

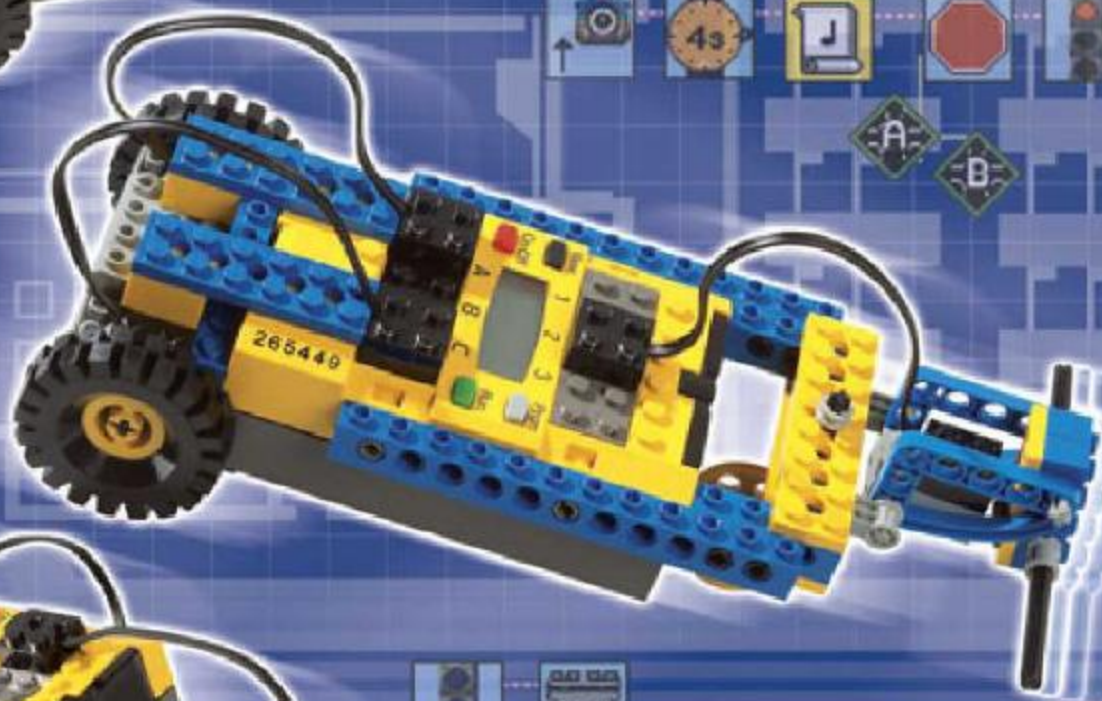

# MINDSTORMS™

FOR SCHOOLS

9 785  
9 786



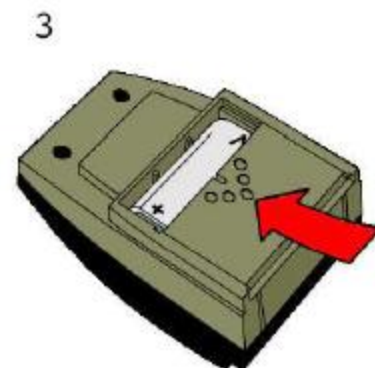
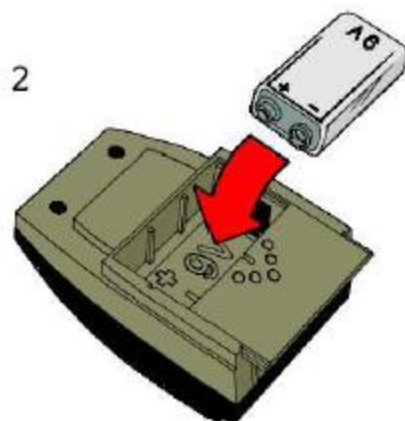
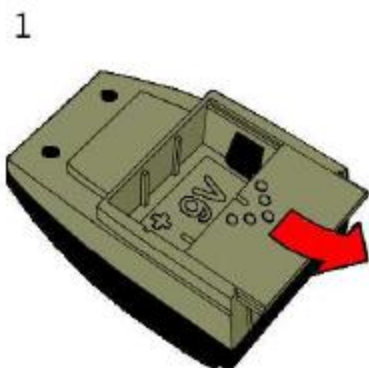
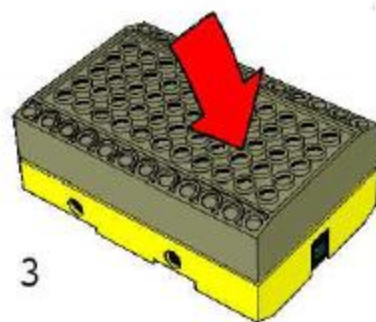
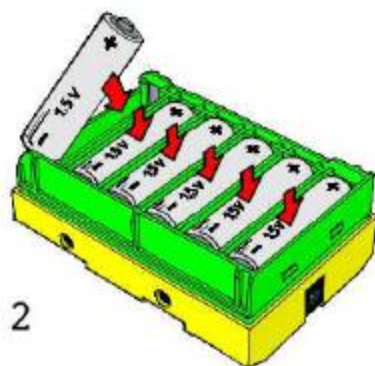
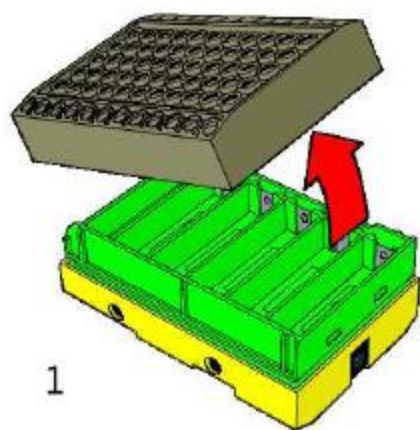

GB

Important information about batteries
Never use different types of batteries together...

FI

Tärkeää tietoa paristosta
Älä sekoita tyypin eriyttäviä paristoja yhdessä...

PL

Ważne informacje dotyczące baterii
Nigdy nie mieszajcie stosować razem różnych rodzajów baterii...

SI

Pomembna informacija o baterijskih vrstah
Nikoli ne uporabljajte različnih vrst baterijskih vrst skupaj...

DE

Wichtige Information zu Batterien
Niemals Sie niemals unterschiedliche Arten von Batterien...

SE

Viktig information om batterier
Använd aldrig olika sorters batterier samtidigt, och inte heller en kombination av gamla och nya batterier...

CZ

Důležitá informace o bateriích
Nikdy nespouštějte napětíhou různě typy baterií nebo kombinaci starých a nových baterií...

RO

Informații importante cu privire la baterii
Nu folosiți niciodată împreună tipuri diferite de baterii și nici combinații de baterii noi și vechi...

FR

Informations importantes concernant les piles
Ne jamais utiliser un mélange de différents types de piles...

PT

Informações importantes acerca das pilhas
Nunca use tipos diferentes de pilhas em conjunto, nem uma combinação de pilhas velhas e novas...

SK

Dôležitá informácia o batériách
Nikdy nespúšťajte napätie rôznych typov batérií ani kombináciu starých a nových batérií...

BG

Важна информация за батерии
Не използвайте различни типове батерии едновременно...

IT

Importanti informazioni sulle batterie
Non usare mai contemporaneamente batterie di tipo diverso a batteria nuova o usata insieme...

GR

Σημαντικές πληροφορίες για τις μπαταρίες
Μην χρησιμοποιείτε ποτέ διαφορετικές ή ετερογενείς μπαταρίες...

HU

Fő felhívás a csomagoláson
Soha ne használjon különböző típusú elemeket, illetve ne keverje össze az új elemeket...

LV

Svarīga informācija par baterijas elementiem
Nekad nlietiet kopā dažādu tipu baterijas elementus...

NL

Belangrijn informatie over batterijen
Gebruik nooit verschillende soorten of nieuwe en oude batterijen tegelijkertijd...

JP

電池の取り扱い方
異なる種類の電池を同時に使用しないでください...

UA

Надійшла інформація про батареї
Ніколи не використовуйте одночасно батареї різних типів...

EE

Oluline teave paristade kohta
Mõte kindi tüüpi paristadega ei tohi segada teiste tüüpi paristadega...

ES

Importante información sobre las baterías
No mezclar nunca diferentes tipos de baterías, ni utilizar baterías antiguas y nuevas...

CN

電池的用法
切勿將不同種類的電池混用...

HR

Važne informacije o baterijama
Nikada ne koristite različite vrste baterija zajedno, i ne koristite stare i nove baterije...

LT

Svarbi informacija apie baterijas
Niekada ne naudokite skirtingų tipų baterijų kartu, taip pat ne naudokite senas baterijas kartu su naujomis...

DK

Vigigt information om batterier
Anvend aldrig forskellige typer batterier sammen, eller nye og gamle batterier samtidig...

RU

Наиболее важная информация об элементах питания
Не в коем случае не используйте одновременно элементы питания различных типов...

SR

Важна информација о батеријама
Никада не користите различите врсте батерија заједно, и не користите старе и нове батерије...

TR

Filizli bilgilere dikkatle okunmalizdir
Farkli tiplere daglik bir arada kullanmayin...



1

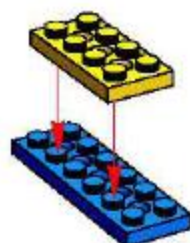
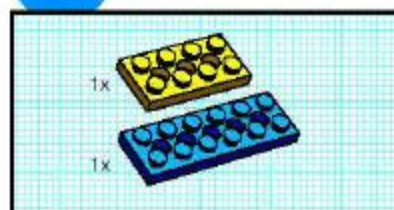

2

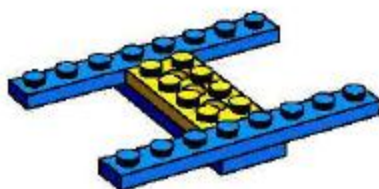
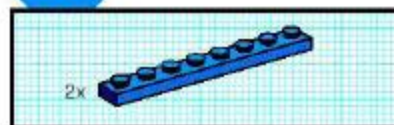

3

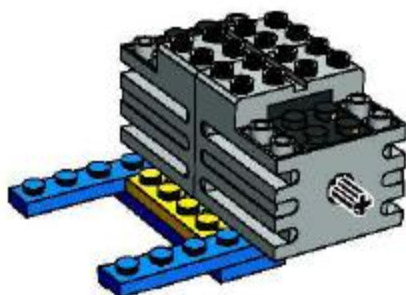

4

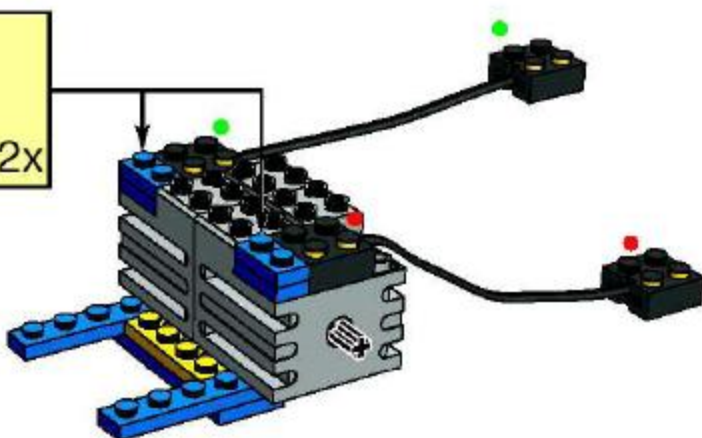
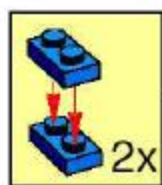
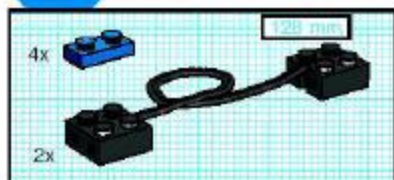

5

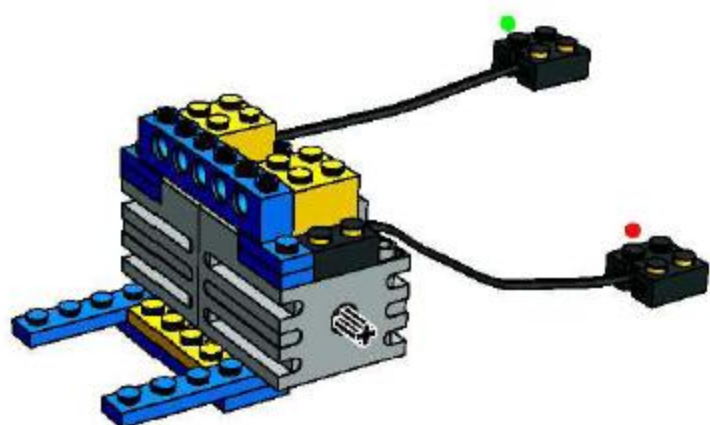
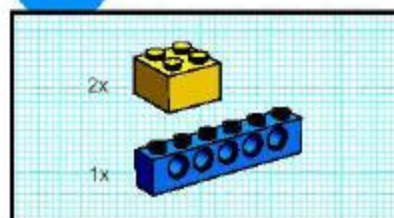

6

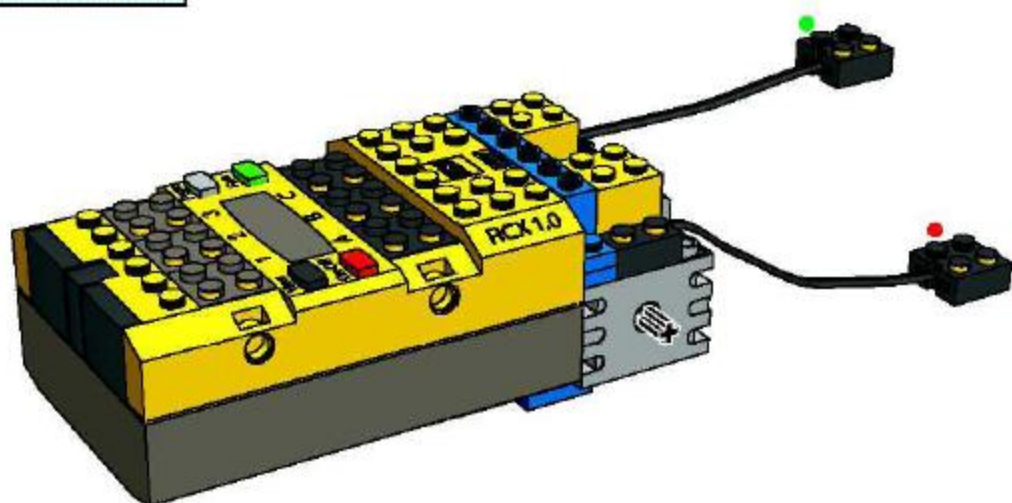
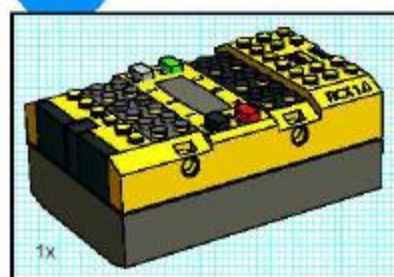

7

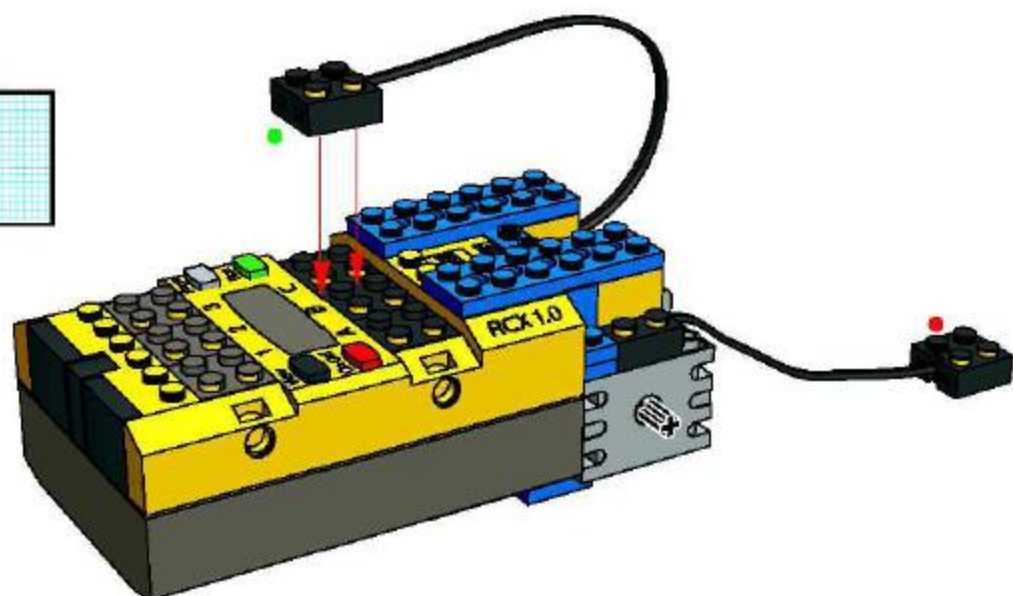
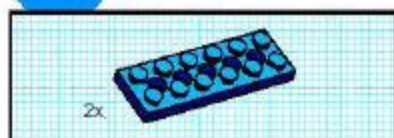

8

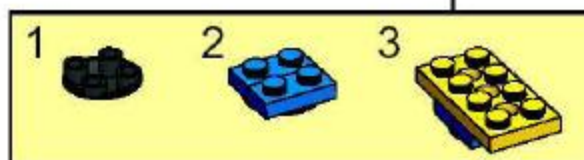



1

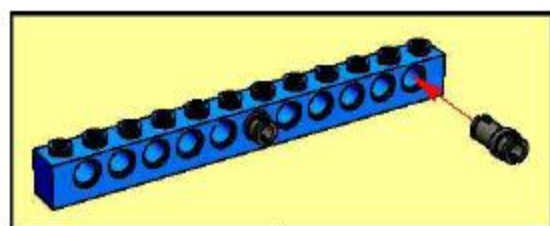
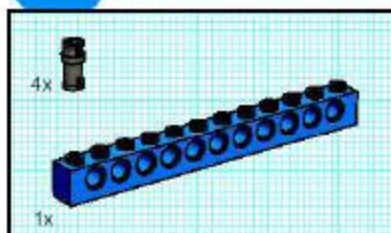



2

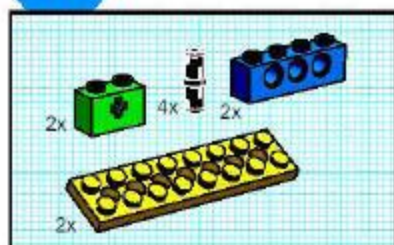

1



2

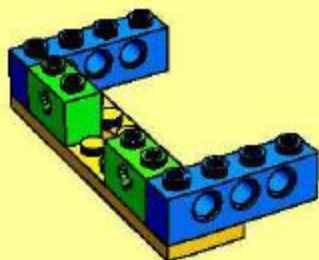

3

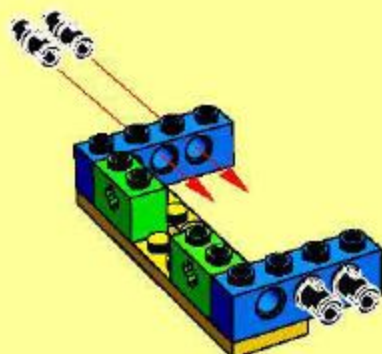

4

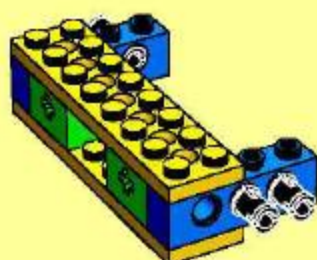

3

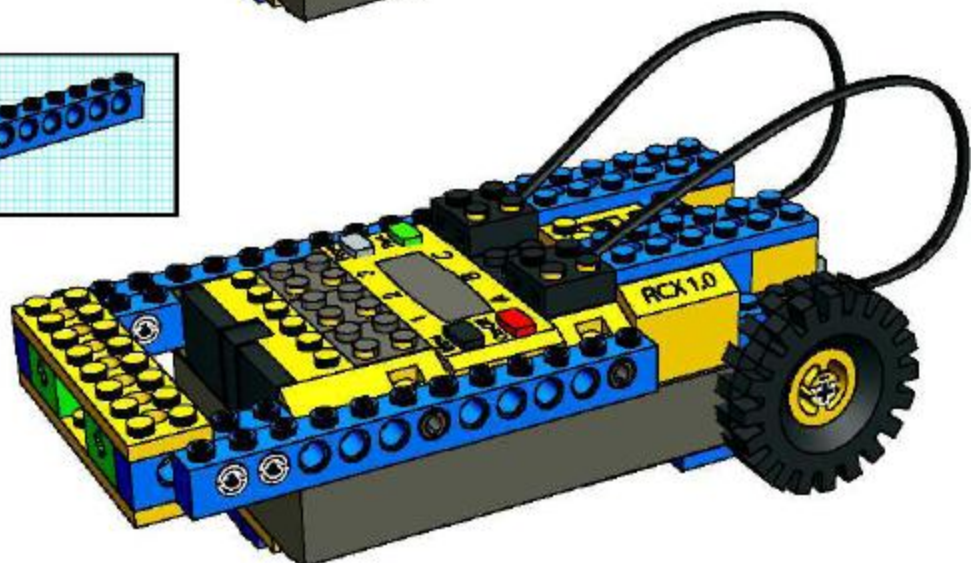
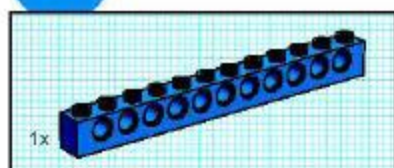

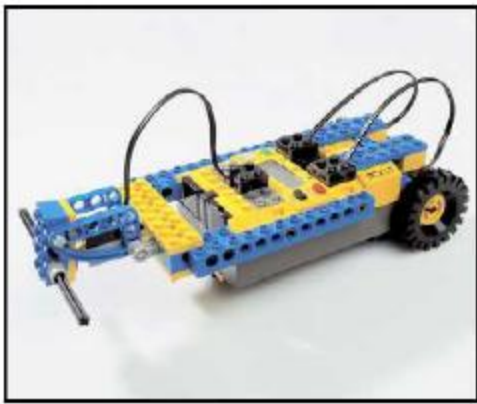

11

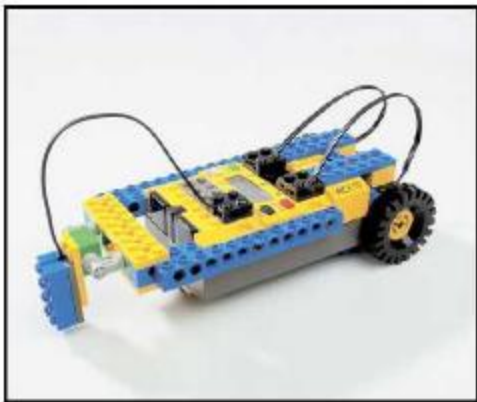

14

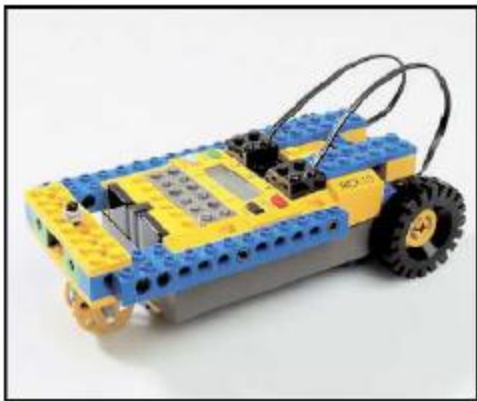

16

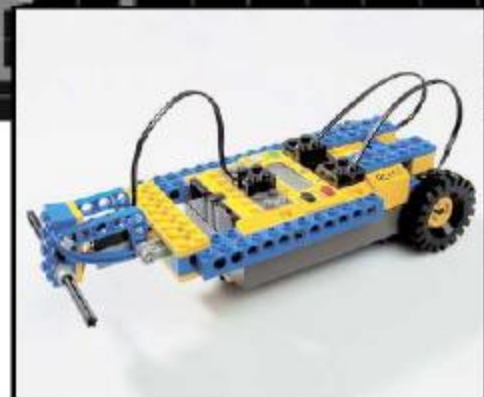

1



2



3

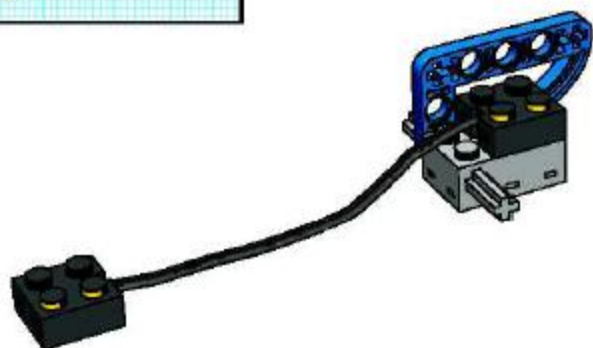

4

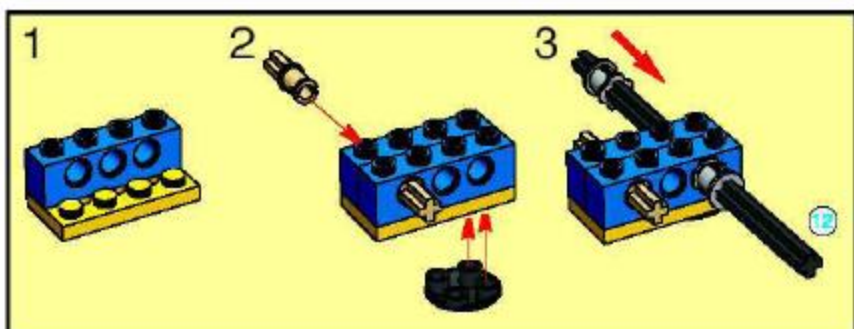
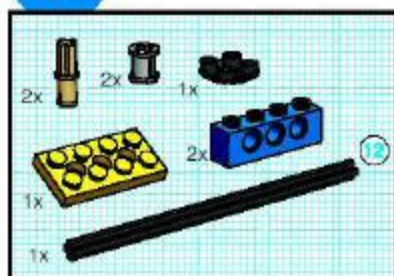

5



6

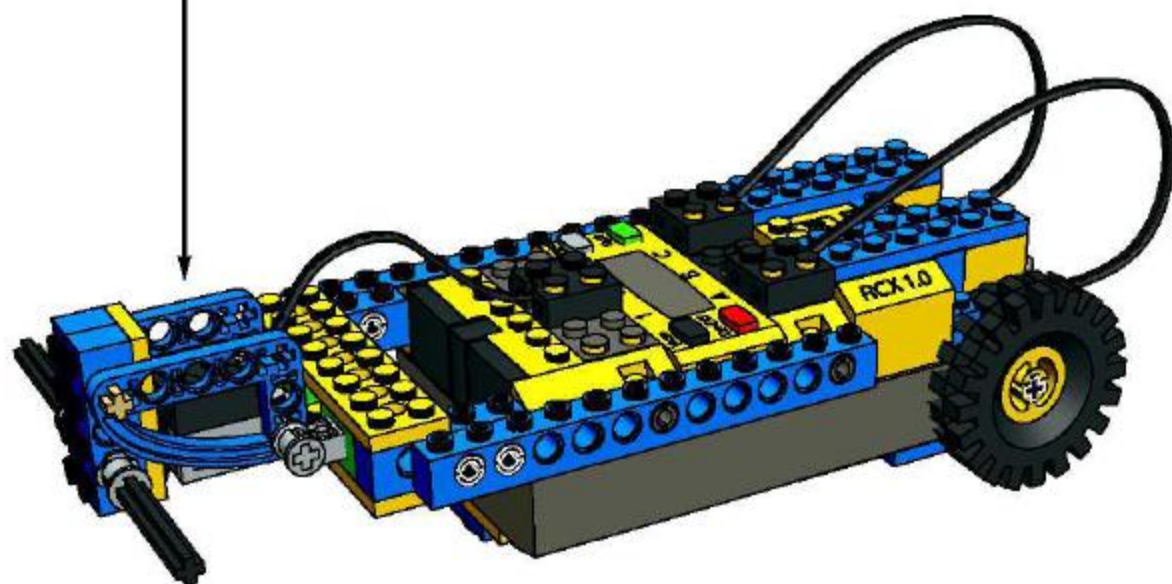
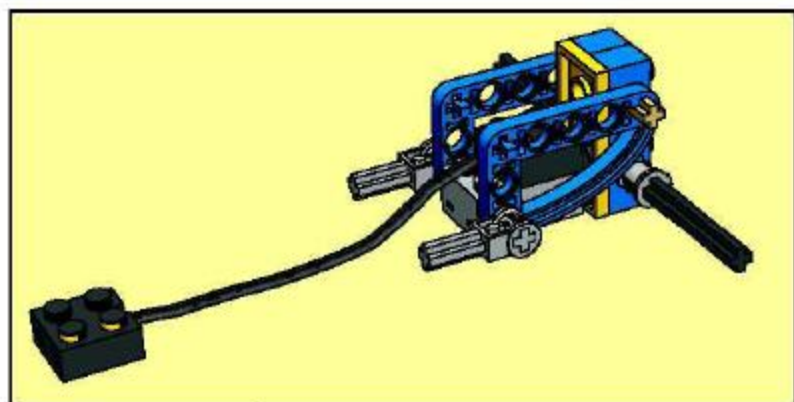
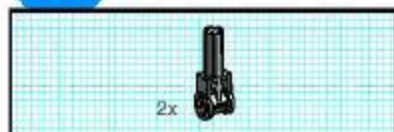



1

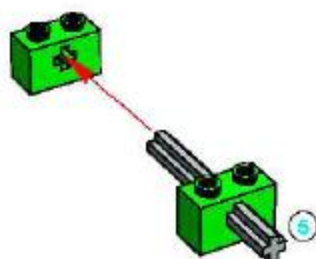
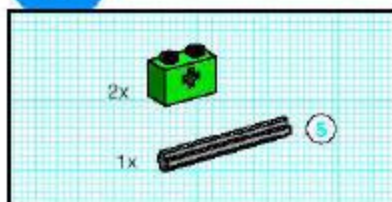

2

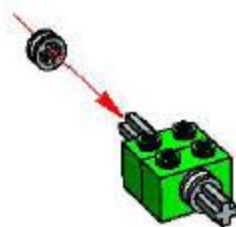

3

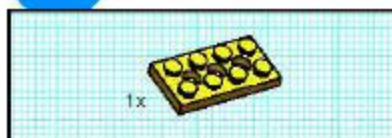

4

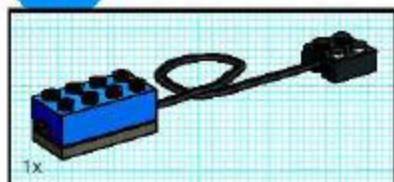

5

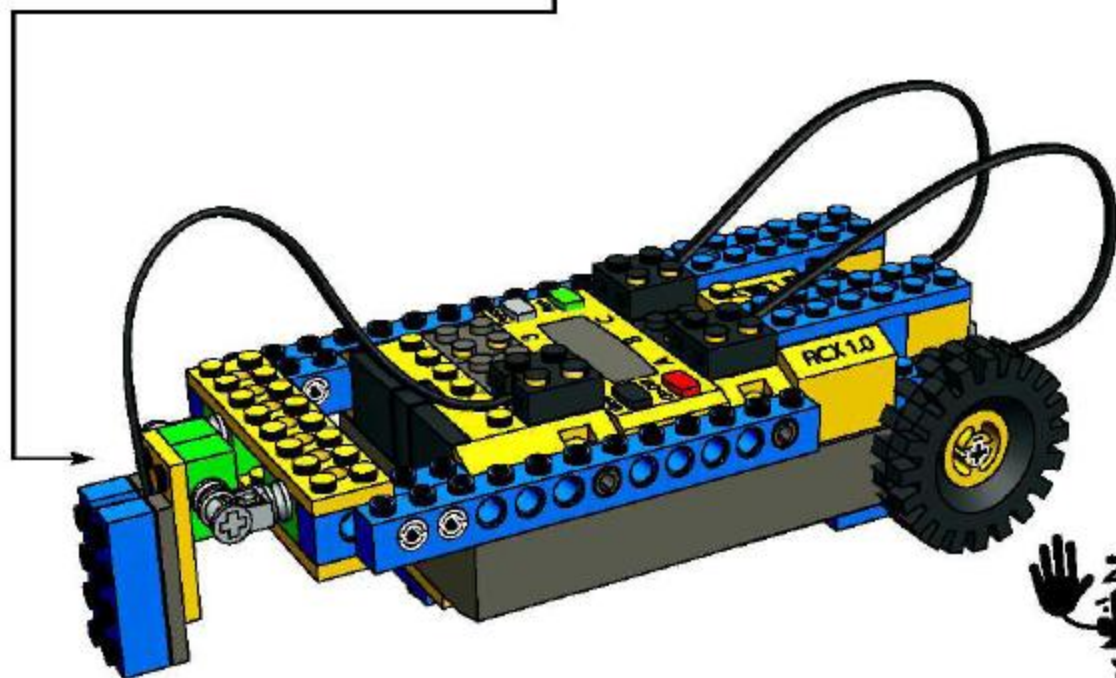
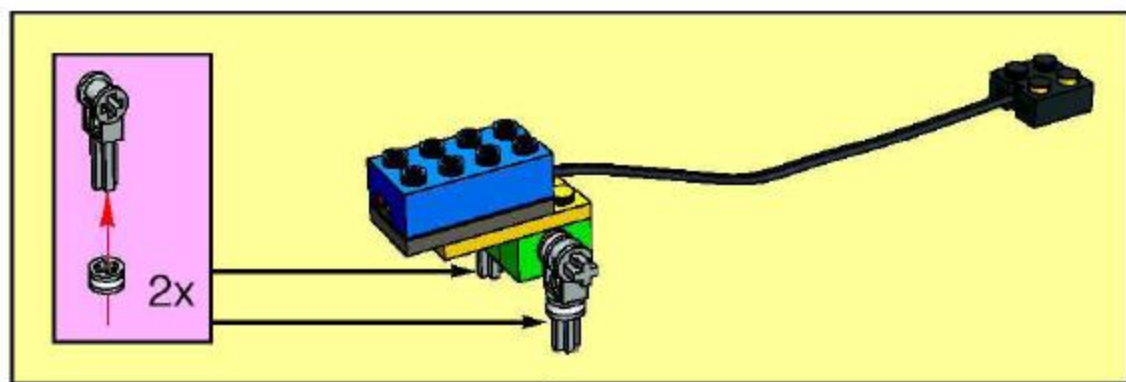
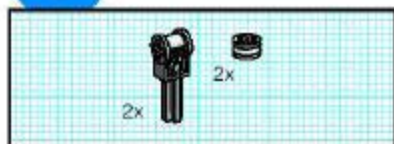

1

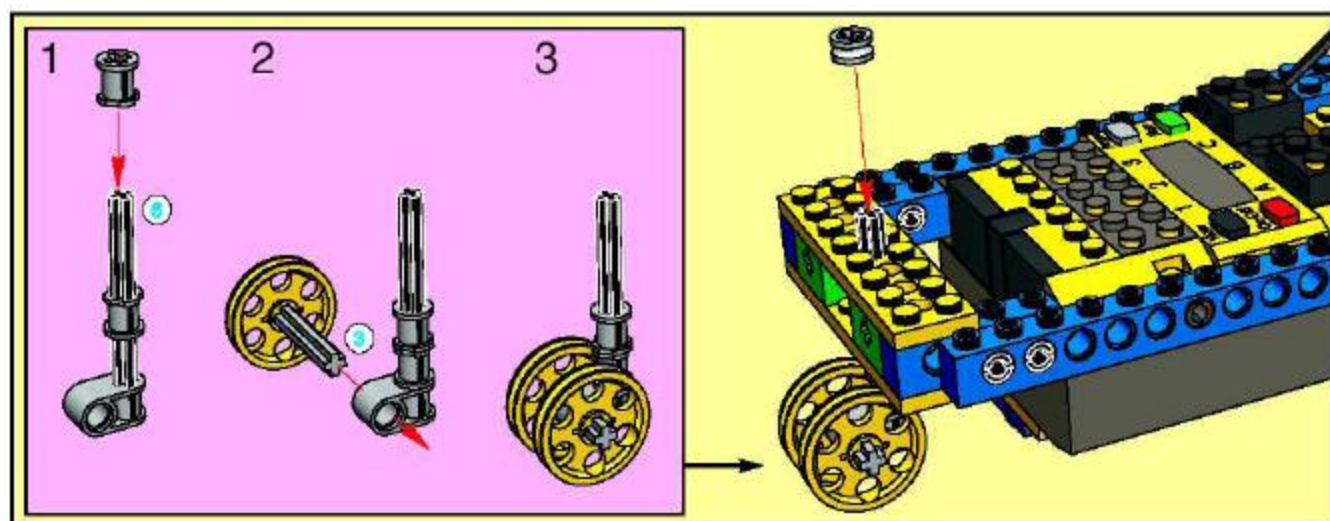





18



25

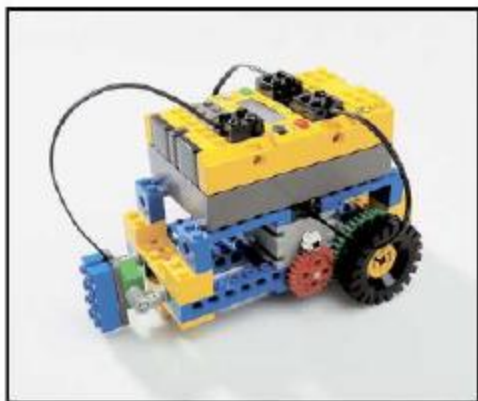

28



1

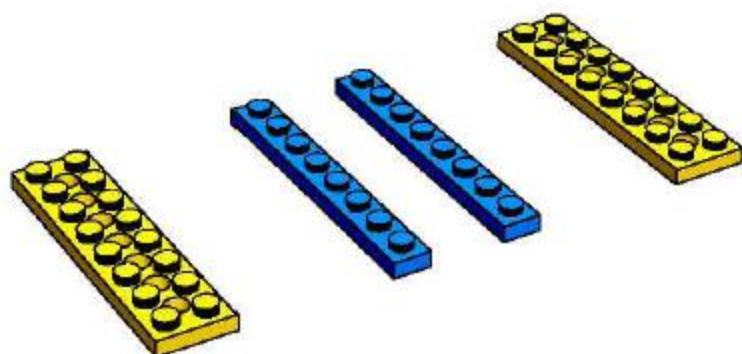
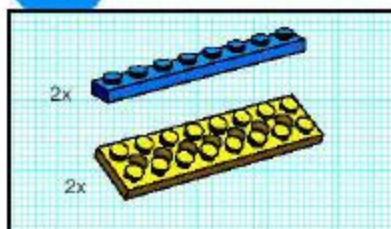

2

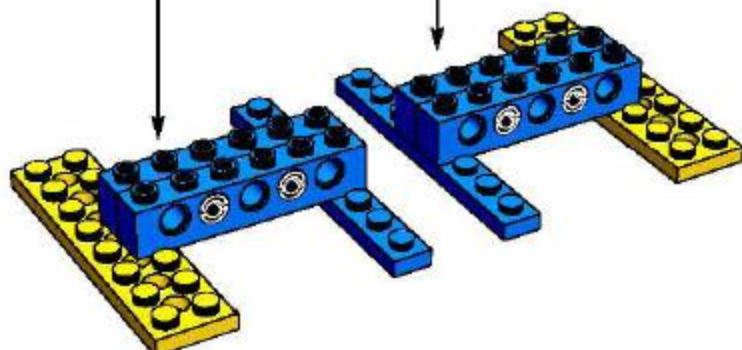
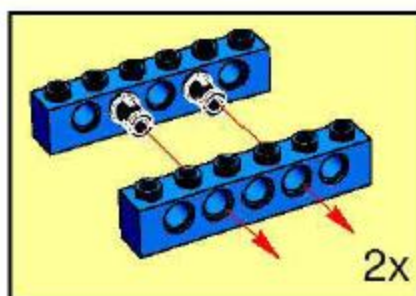
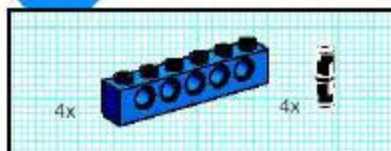

3

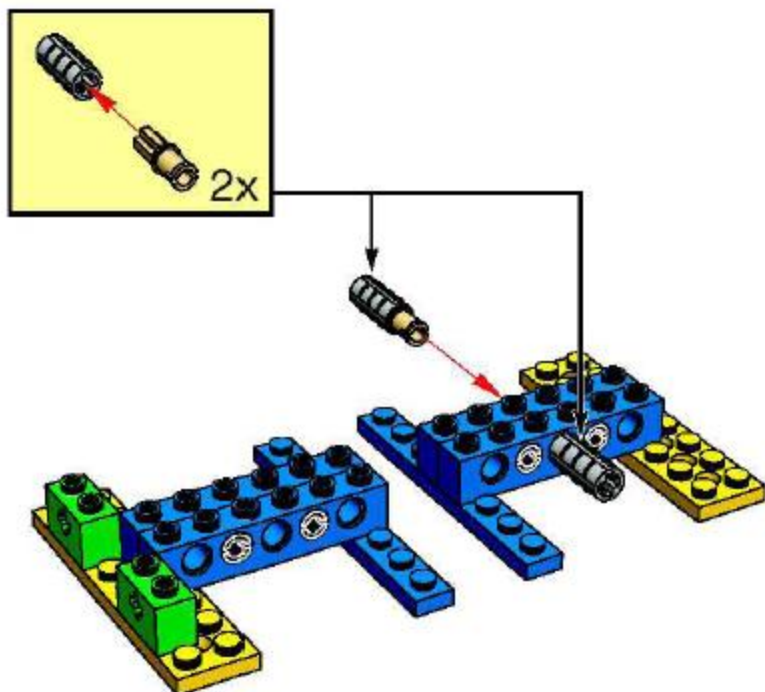
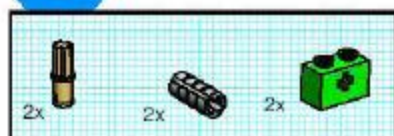

4

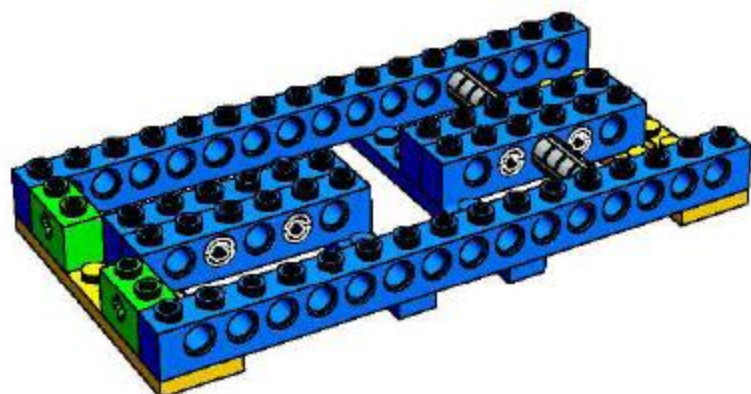
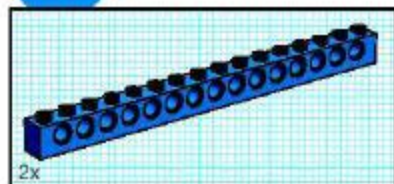

5

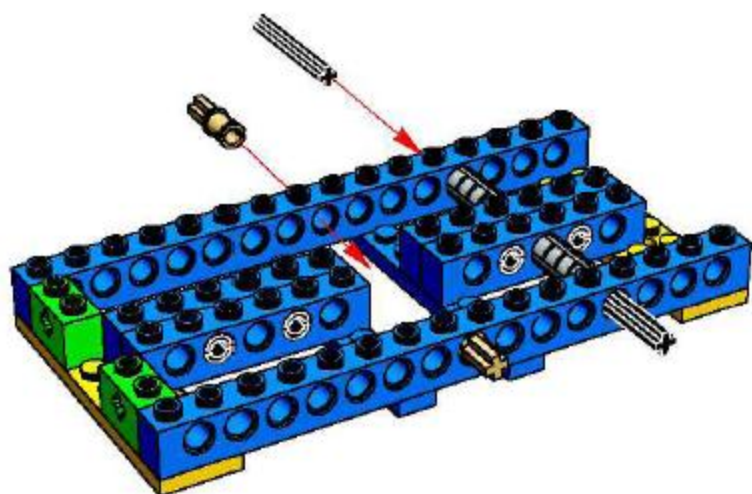
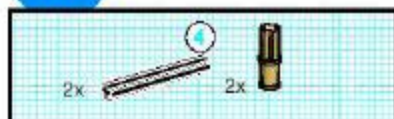

6

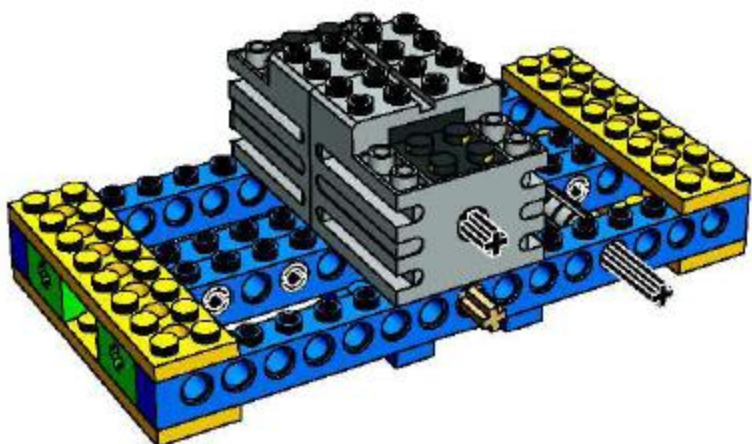
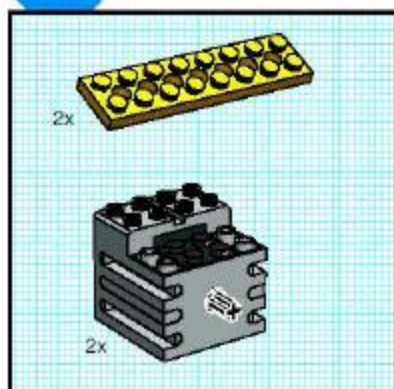

7

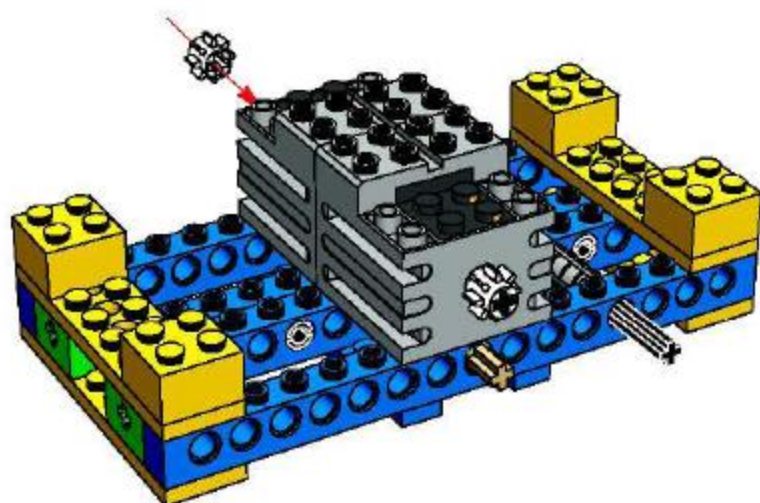
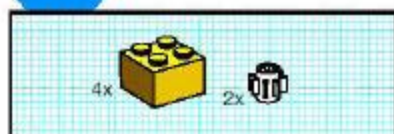

8

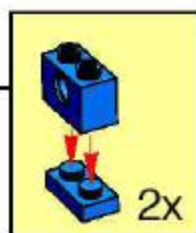
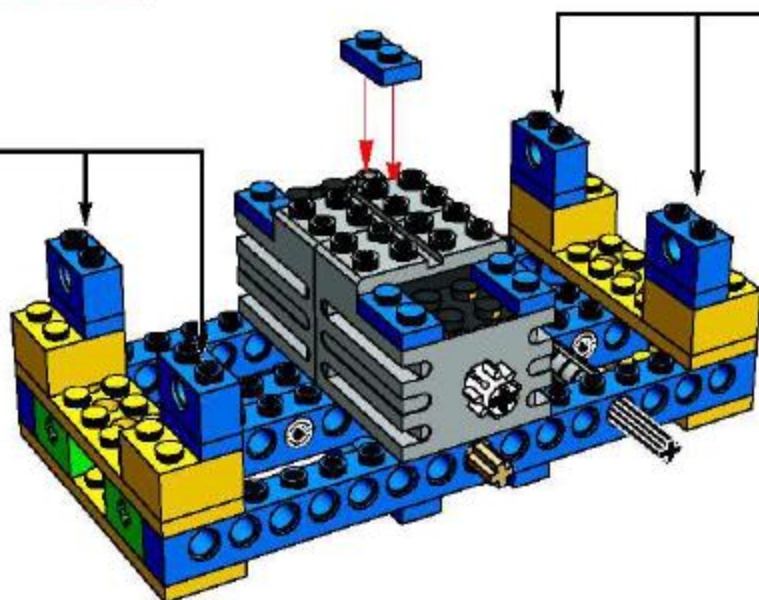
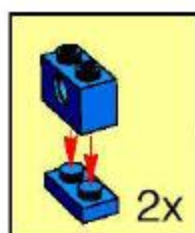
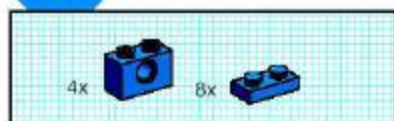

9

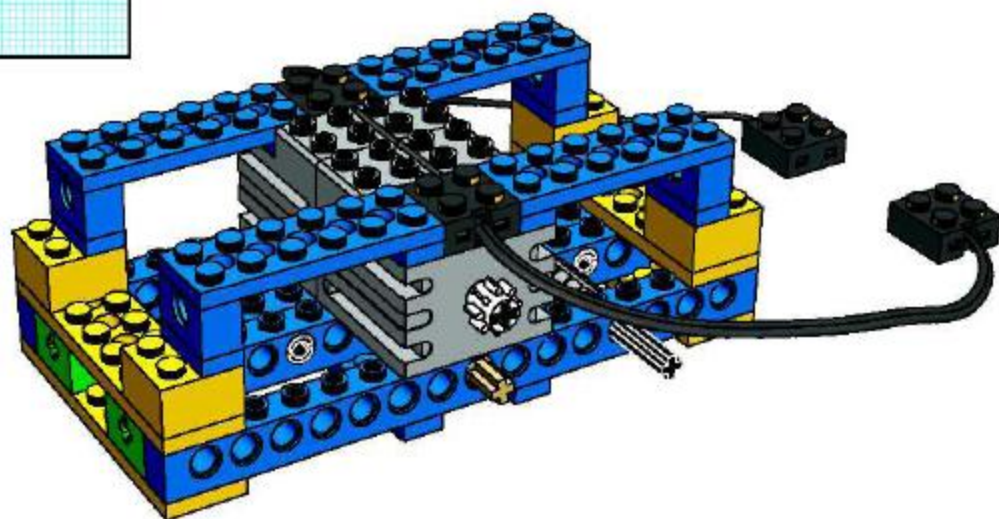
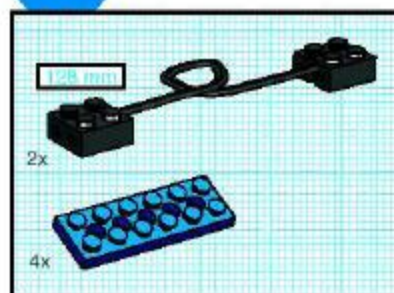

10

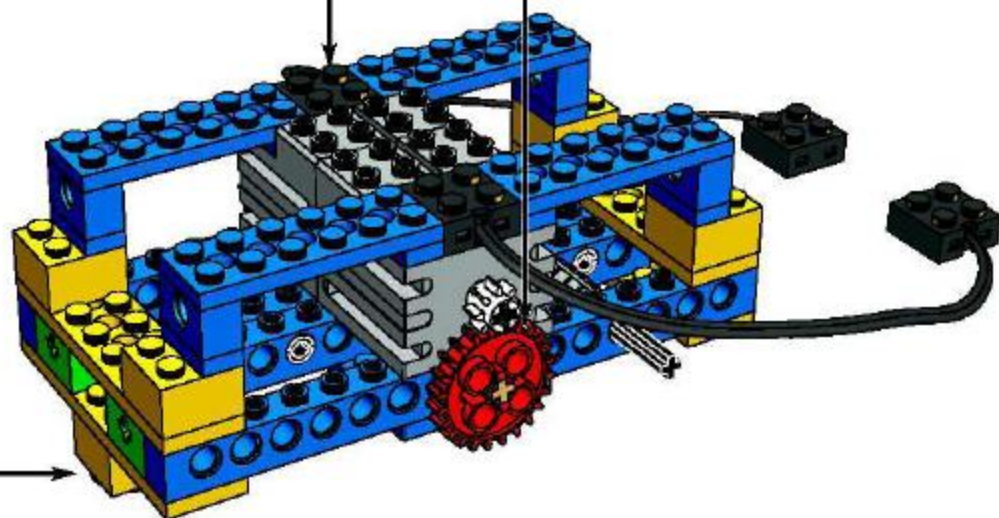
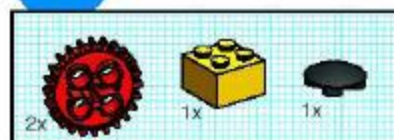

11

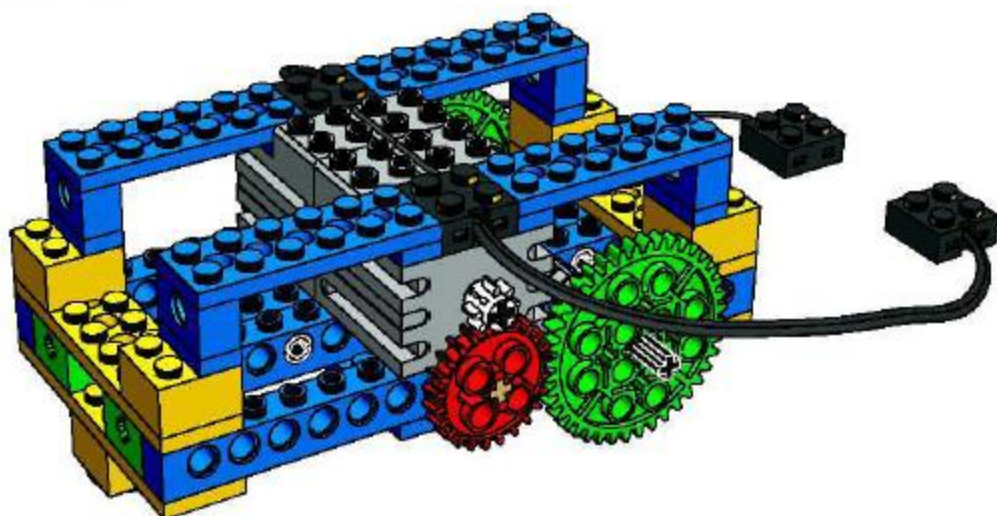
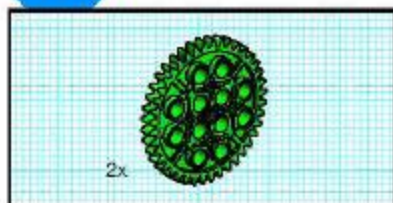

12

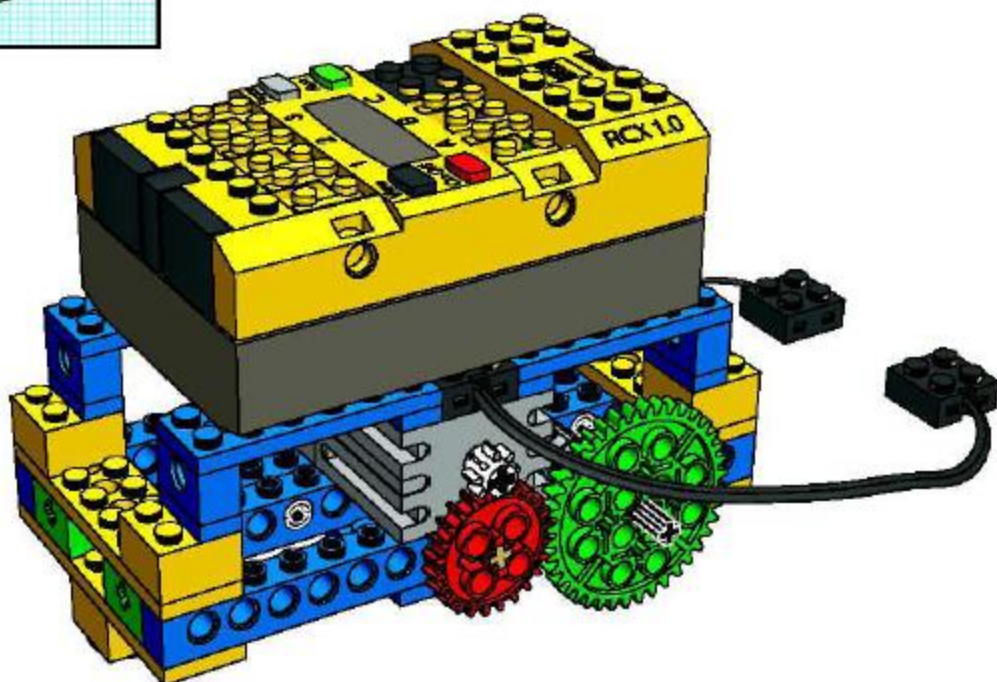
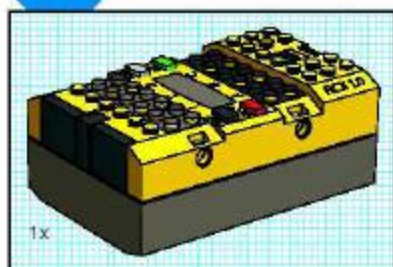

13

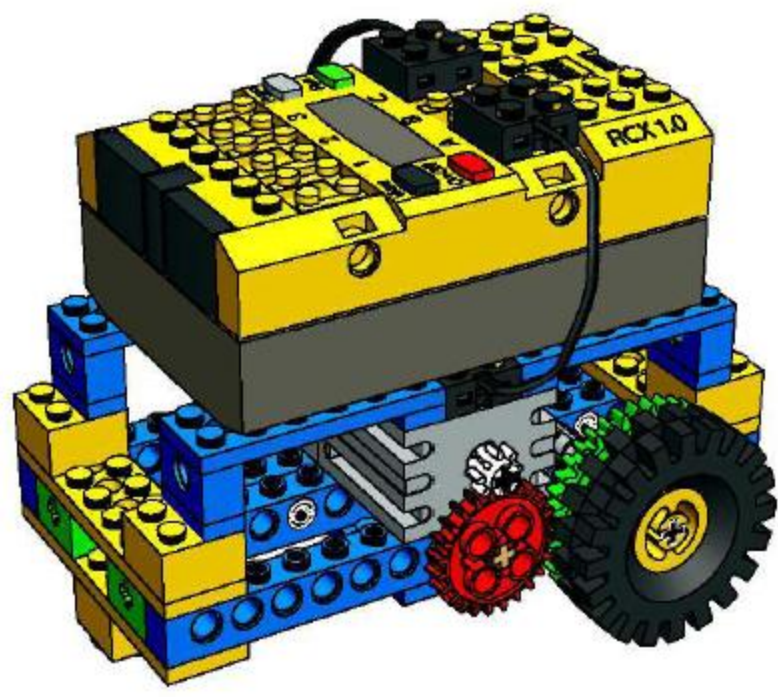



1



2

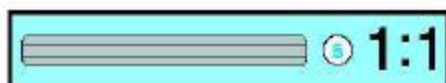

3

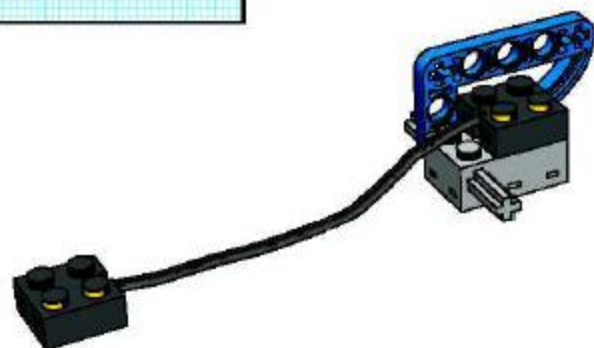

4

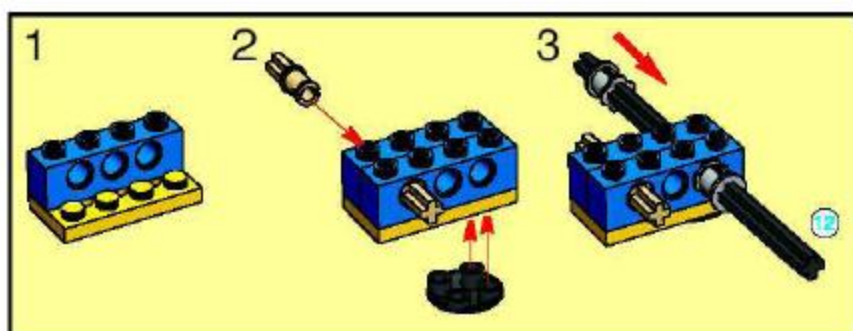

5



6

2x

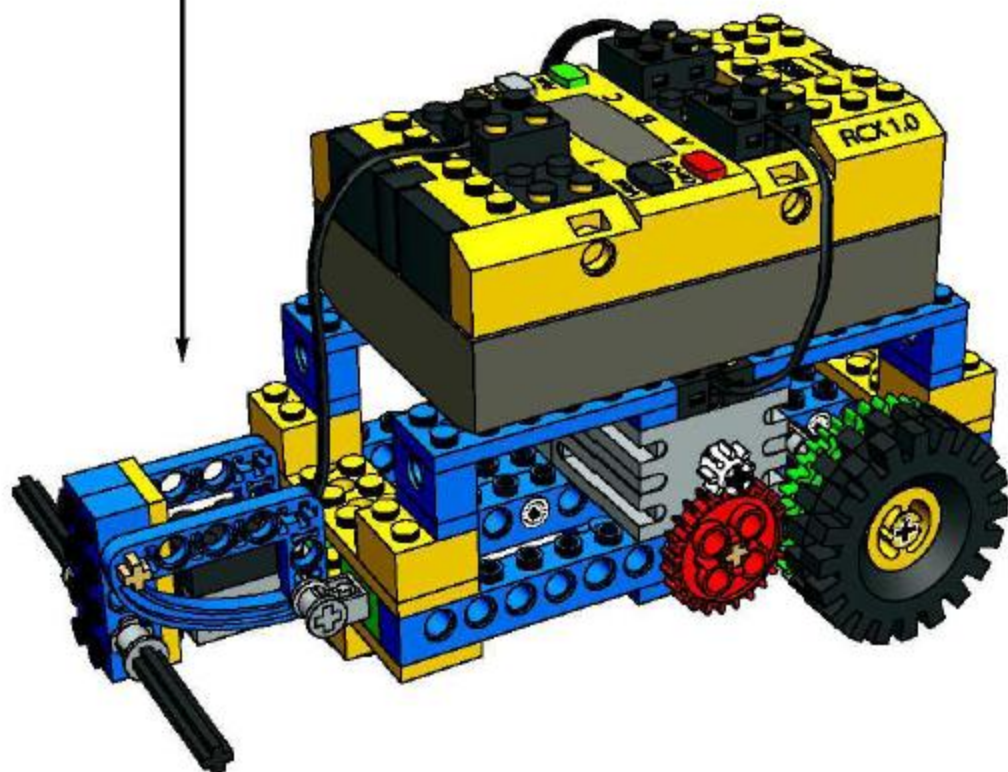
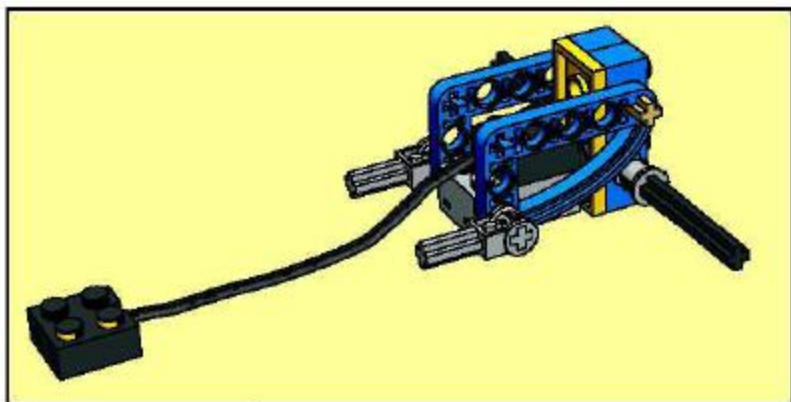



1

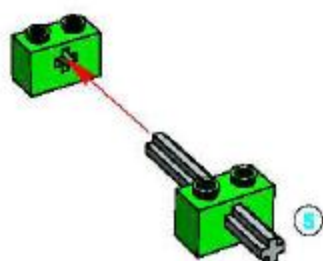
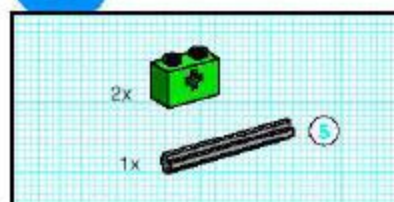

2



3

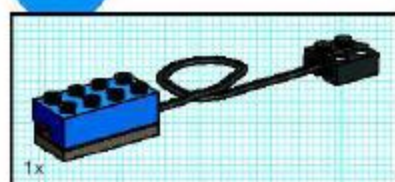

4

