

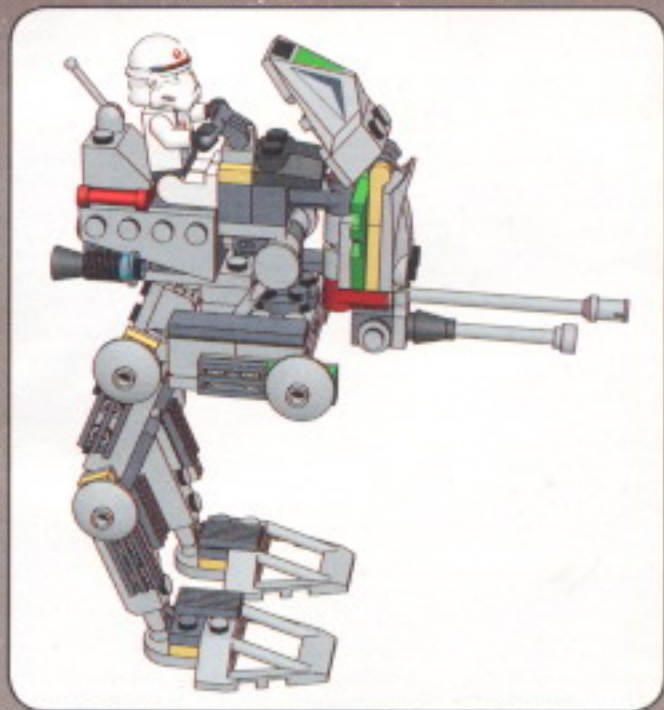

STAR WARS

7250





1

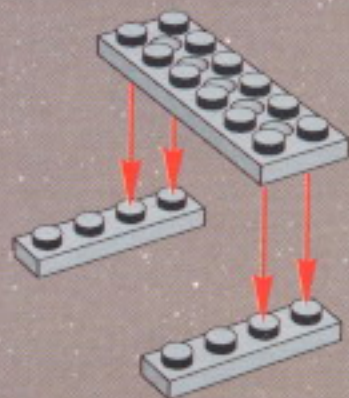

2

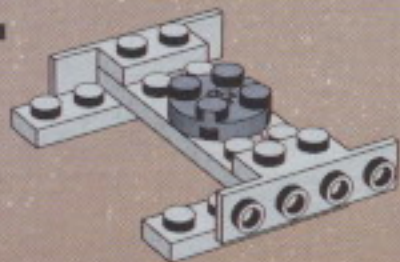

3

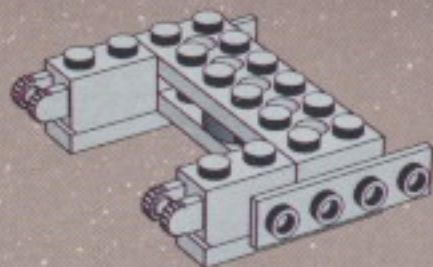

4

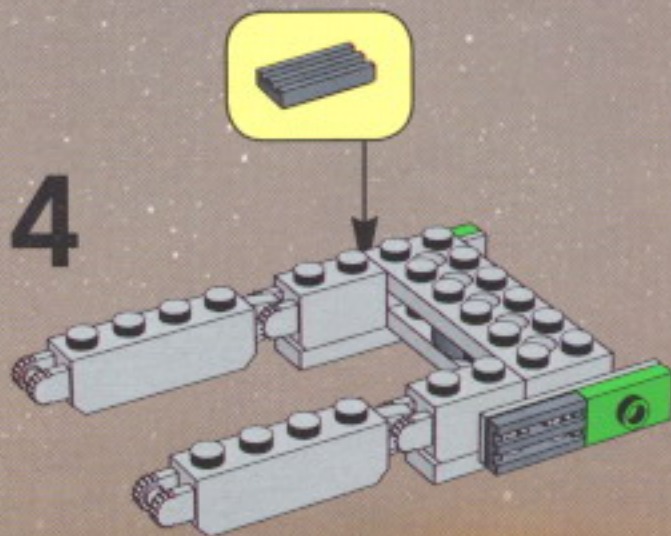

5

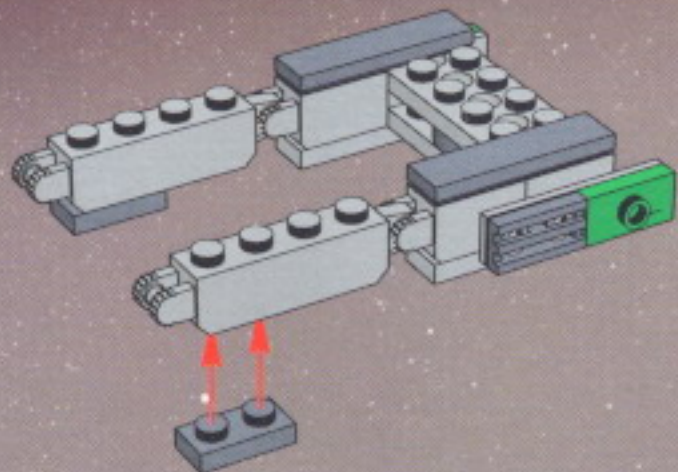

7

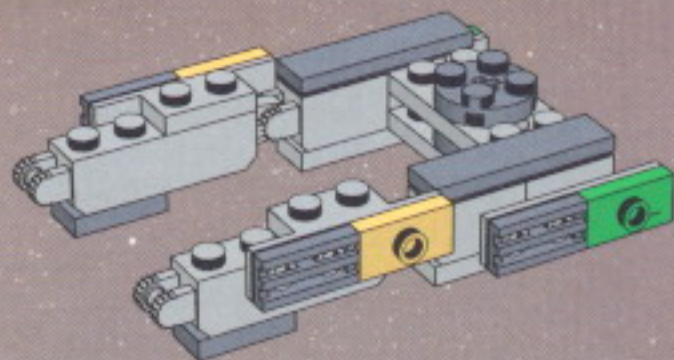

6

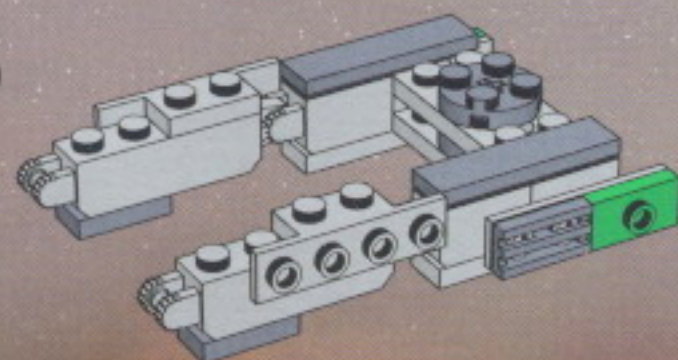

8

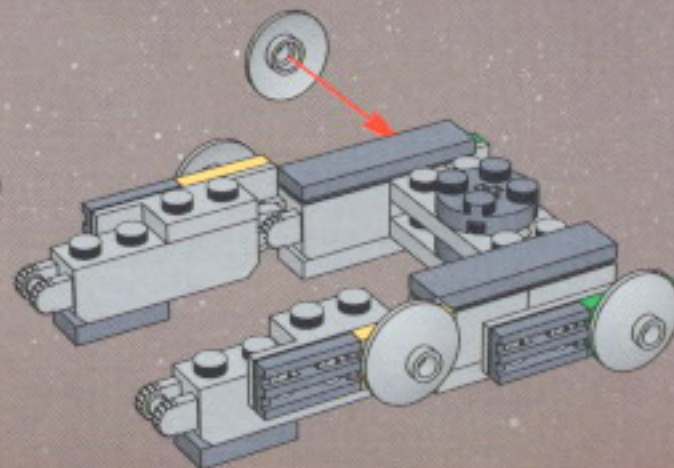

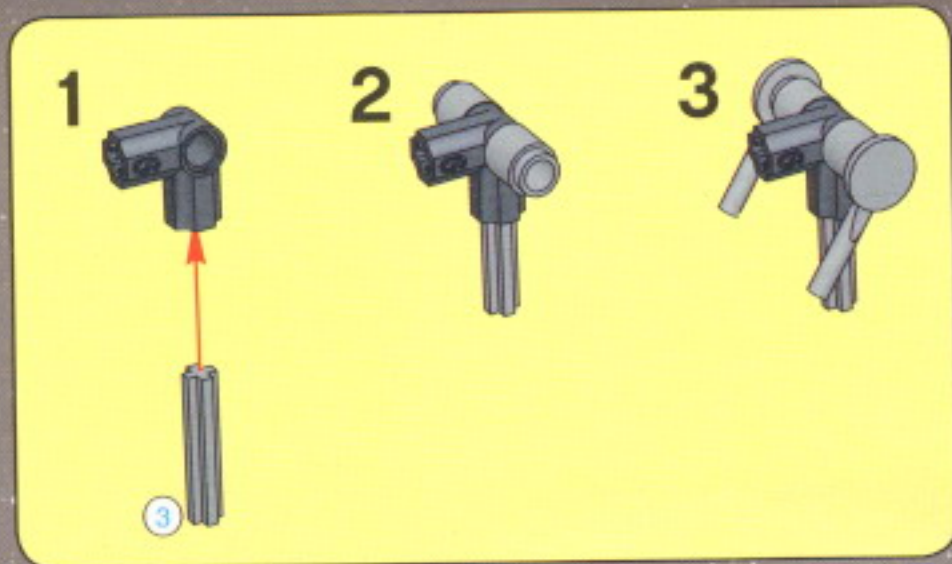

9

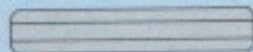
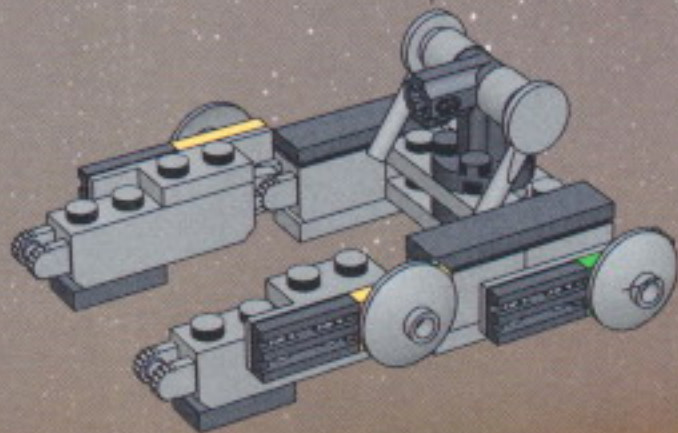

3

1:1

1

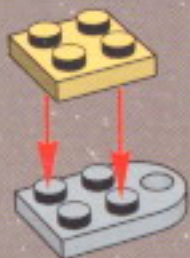

2



3



4

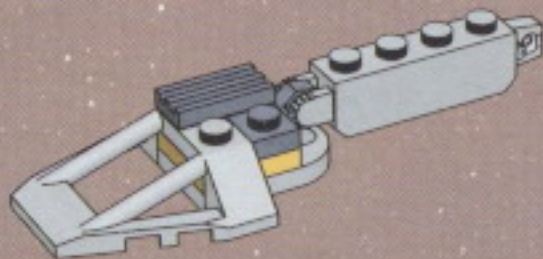

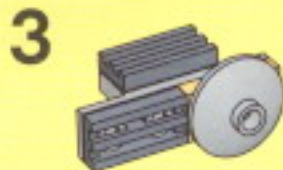
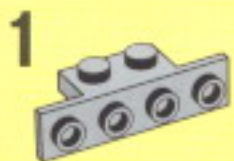

5

10

1

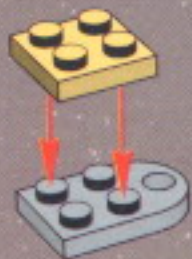

2



3



4

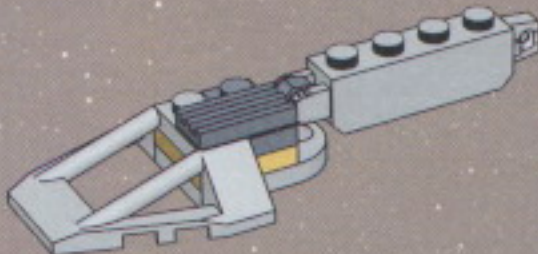

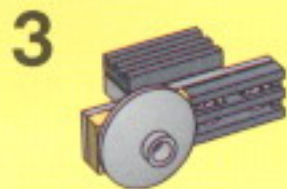
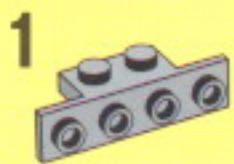

5

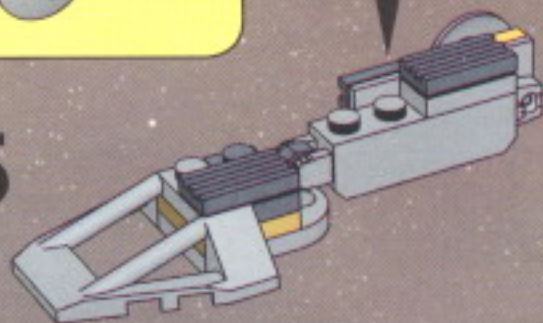

11

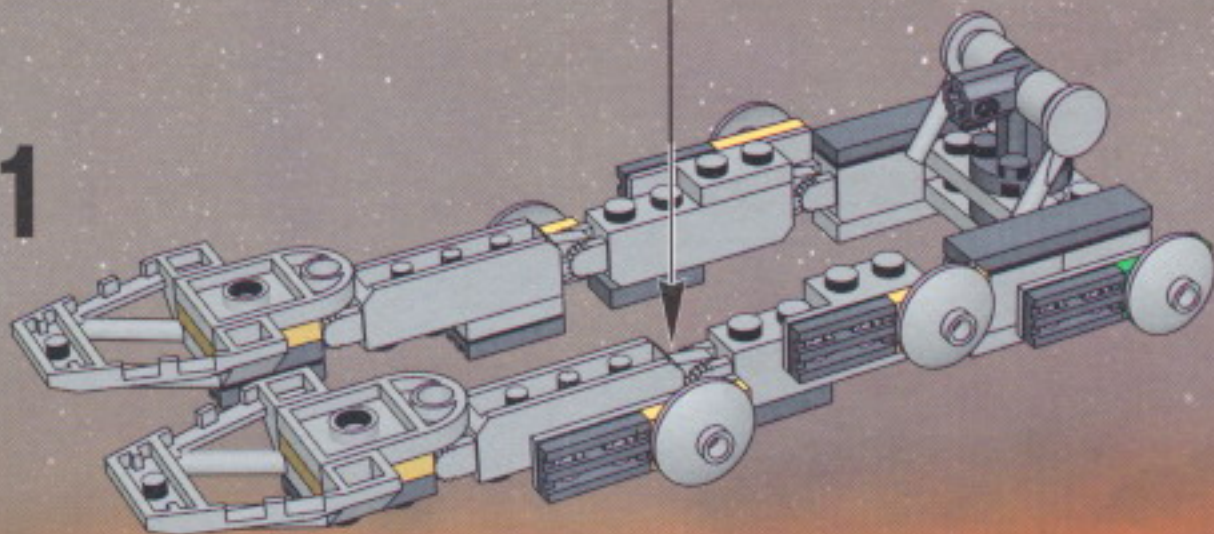

12

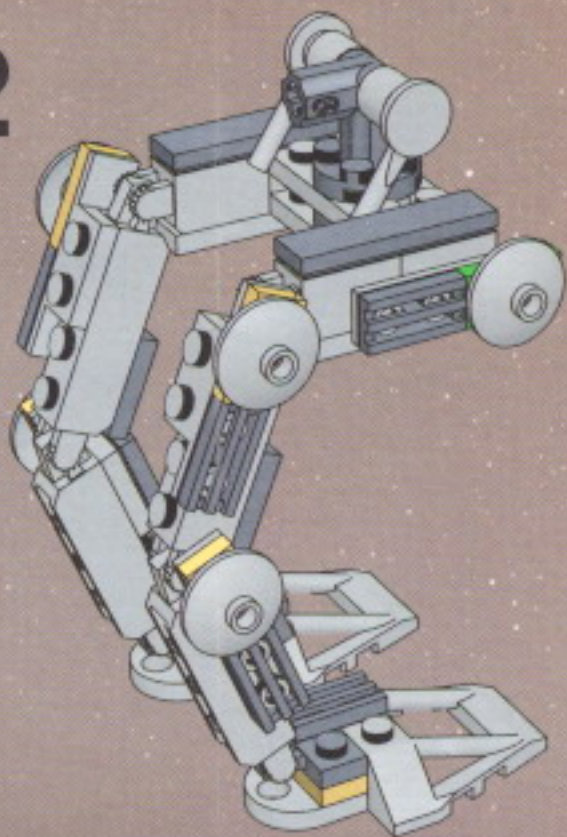



1

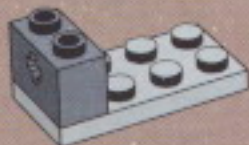

2

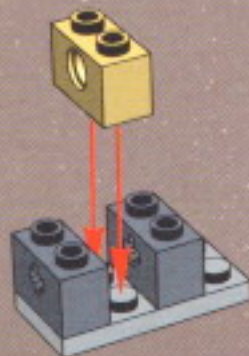

5

1:1

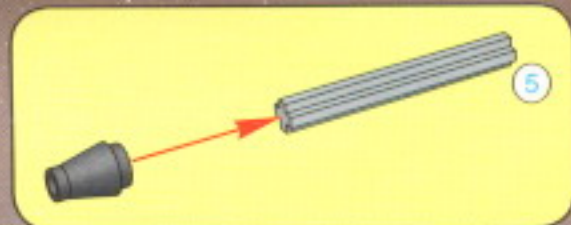

5

3



4

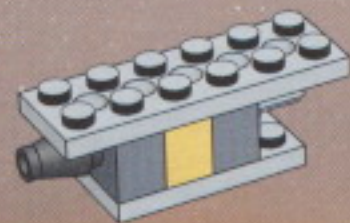

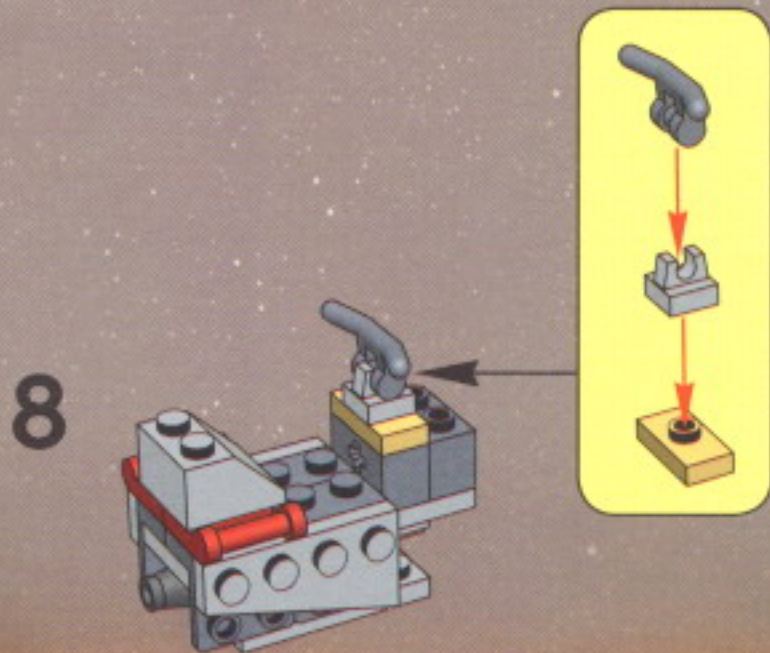
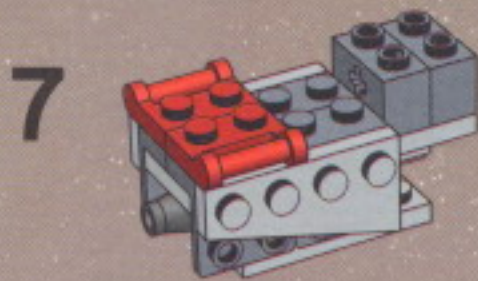
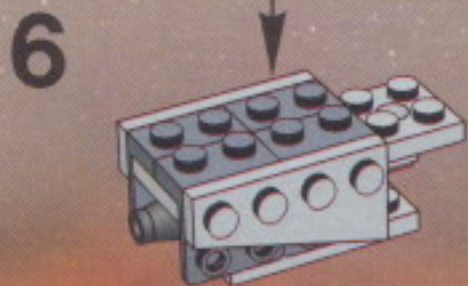
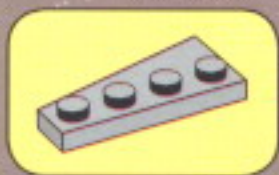
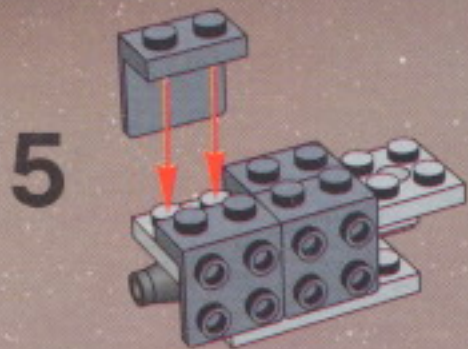

9

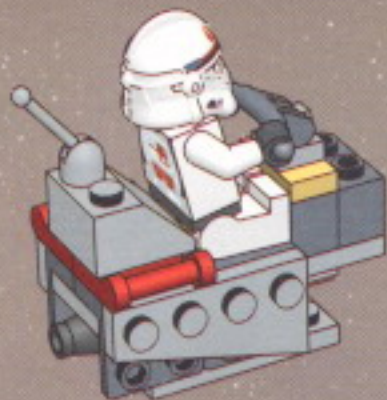

11



10

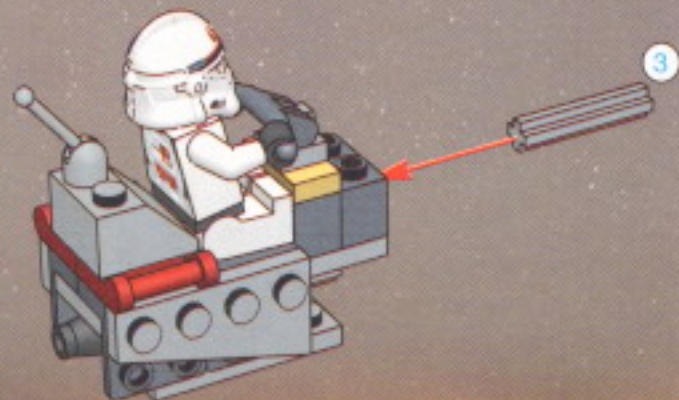

13

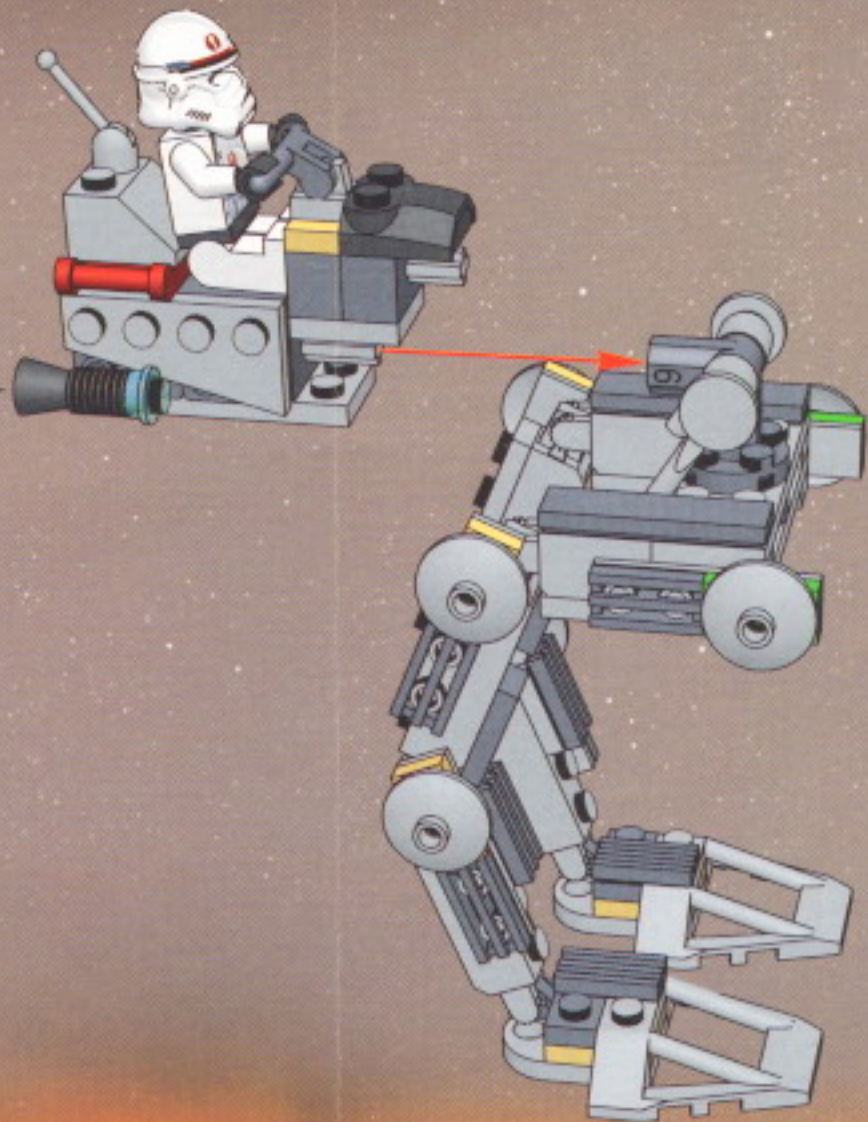

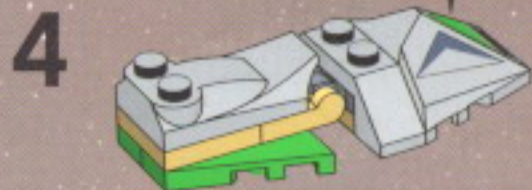
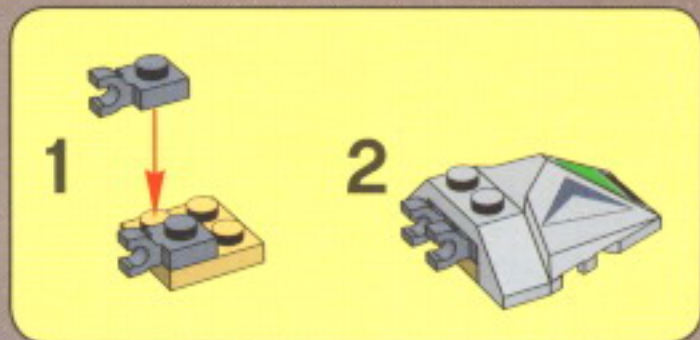
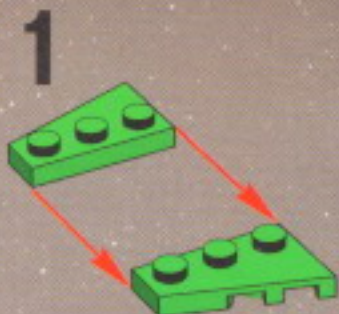
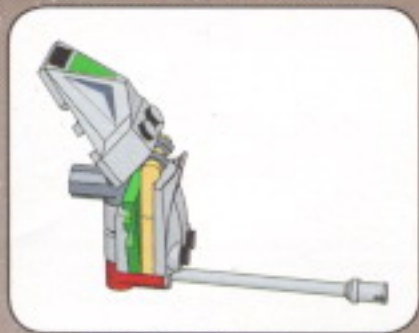

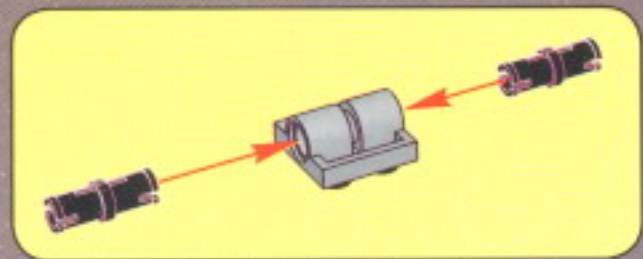

5

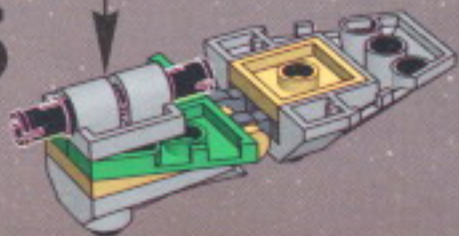

6

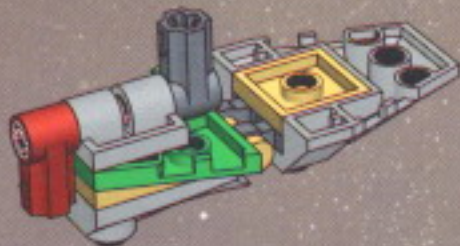

7

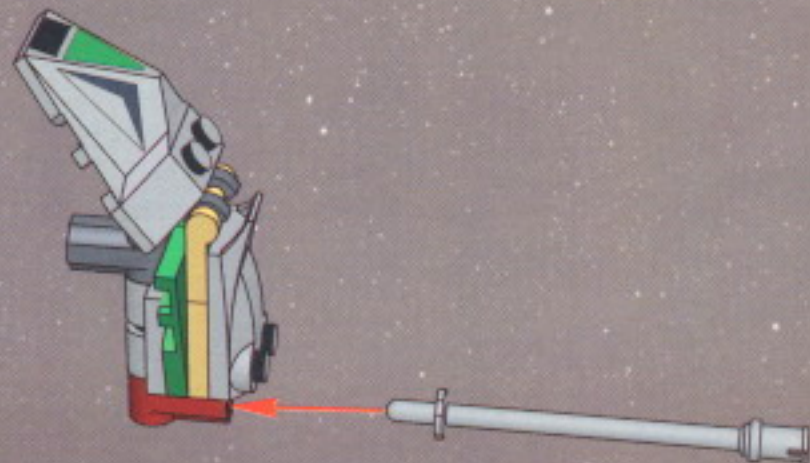

14

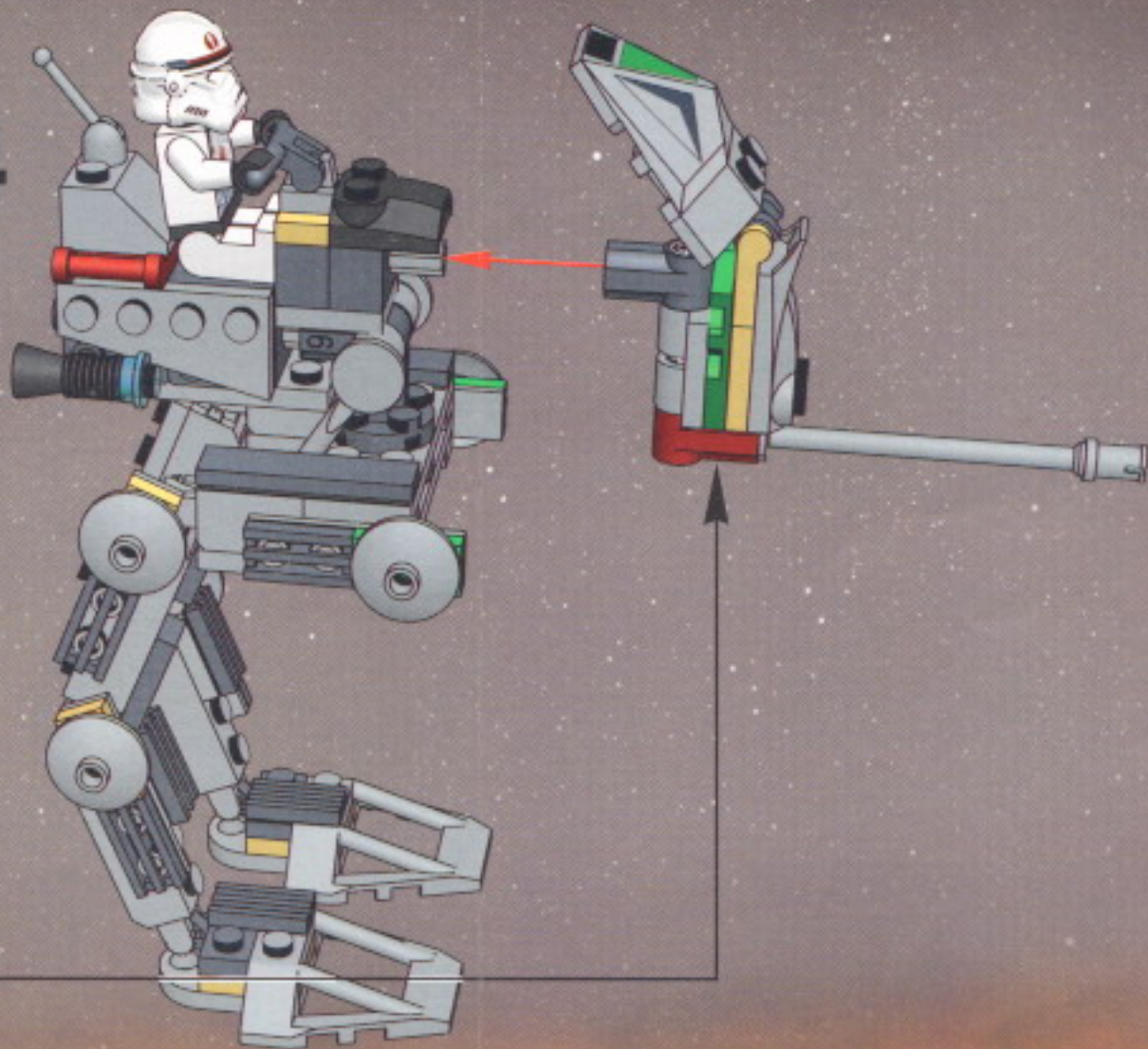

15

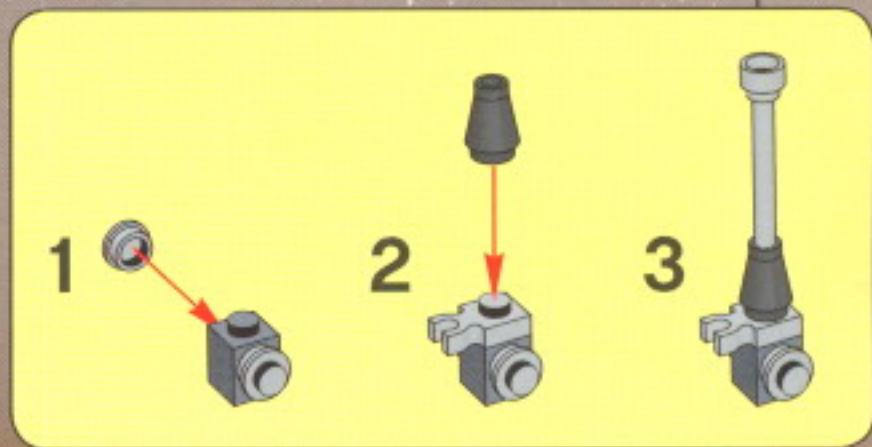
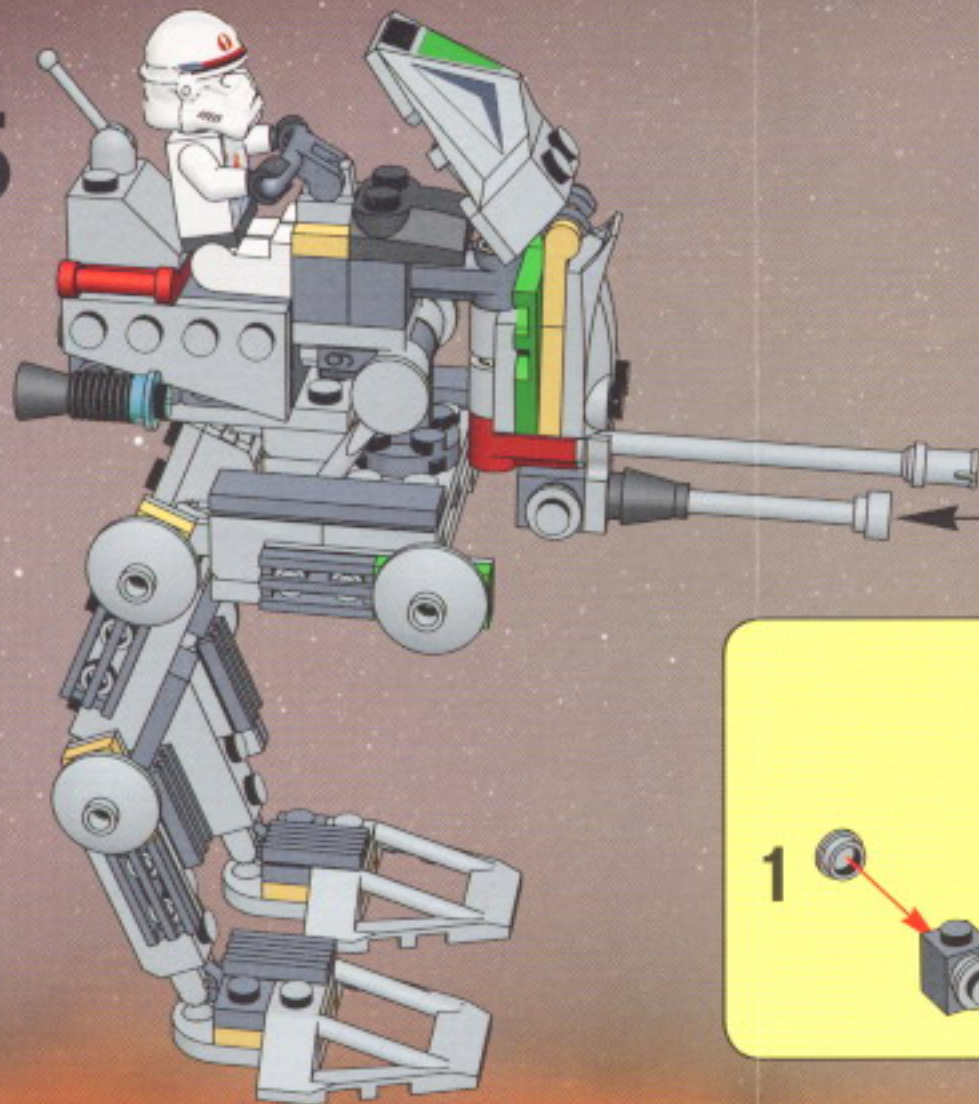

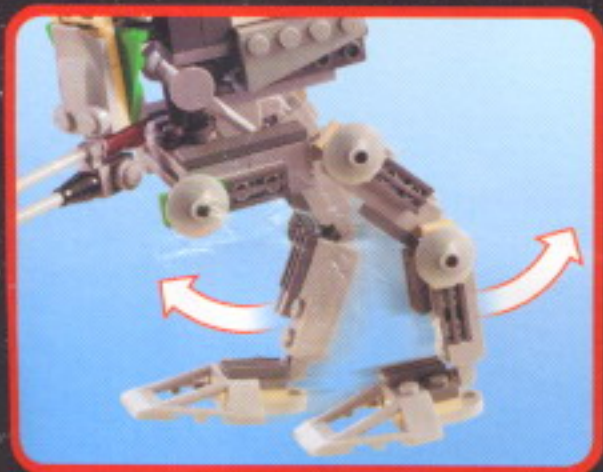

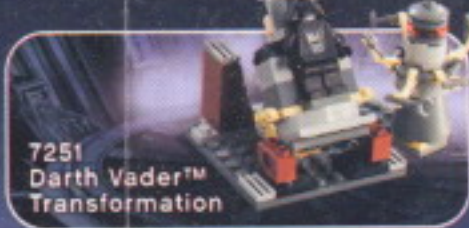



7251
Darth Vader™
Transformation



7256
Jedi Starfighter™
and Vulture Droid™



7259
Arc-170 Starfighter™



7261 Clone Turbo Tank™



7250
Clone
Scout
Walker™



7257 Ultimate Lightsaber™ Duel



7252 Droid
Tri-fighter™



7255 General Grievous™ Chase

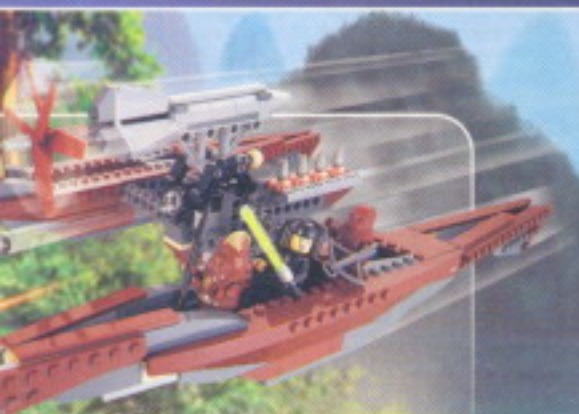

7260
Wookiee
Catamaran™



7258
Wookiee™
Attack



Discover the LEGO UNIVERSE!



www.lego.com/starwars

LEGO SHOP at HOME

The
World's
Biggest
LEGO
Shop!

English Deutsch Français



LEGO club



Win! Gagne! Gewinne! 当たります



WIN LEGO® PRODUCTS

We would like to know what you think about our new LEGO® product. If you could help us by answering a few questions you are in with a chance of winning an exciting LEGO prize. It will only take you about 3 minutes! Log on to the web address below for further instructions.

We would really like to hear what you think about your new LEGO product. If you'd like to help us, go to the web address below for further instructions.



Estimado usuario LEGO®

Al contestar algunas preguntas en inglés, francés, alemán o japonés, en el sitio www.acnielsen.aim.dk/lego, podrás participar en el sorteo de algunos valiosos premios LEGO®.



映画でしご、製品が当たります

お名前、住所、年齢、性別、お住まいの国/地域を教えてください。映画でしごの抽選、参加費なし。当選した製品は映画館にお届けします。映画でしごの抽選は、2007年10月1日(日)まで有効です。抽選結果は、当選者へお電話でお知らせいたします。お問い合わせ先: 020-5717-7777 (平日9時～18時)。



GAGNE DES PRODUITS LEGO®

Nous aimerions savoir ce que tu penses de ton nouveau produit LEGO®. Si tu veux bien nous aider en répondant à quelques questions, tu recevras peut-être bientôt un fantastique prix LEGO. Et cela ne te prendra que 3 minutes environ ! Tu obtiendras davantage d'informations en visitant le site Internet indiqué ci-dessous.

Nous aimerions savoir ce que tu penses de ton nouveau produit LEGO. Si tu souhaites nous aider, rends-toi à l'adresse Internet ci-dessous où tu trouveras des instructions supplémentaires.



Caro Consumidor da LEGO®

Ha responder a algumas perguntas em Inglês, Francês, Alemão ou Japonês no endereço www.acnielsen.aim.dk/lego irá participar num concurso para ganhar valiosos prémios da LEGO®.



GEWINNE LEGO® PRODUKTE

Wir sind sehr an deiner Meinung über dein neues LEGO® Produkt interessiert. Wenn du uns den Gefallen tut und ein paar Fragen beantwortest, kannst du einen tollen LEGO Preis gewinnen. Das Ganze dauert nur etwa 3 Minuten! Gehe einfach zu der unten angegebenen Webadresse - dort findest du weitere Informationen.

Wir möchten gerne wissen, was Sie von Ihrem neuen LEGO Produkt halten. Wenn Sie uns helfen möchten, besuchen Sie bitte die u.a. Website, auf der Sie alles Weitere erfahren.



Kedves Ifjú LEGO® Vásárló

Ha eltérőszáz a www.acnielsen.aim.dk/lego honlapra és ott angol, francia, német vagy japán nyelven megválaszolod néhány kérdést, akkor részt vehetsz egy versenyben, amelyben értékes LEGO® díjakat nyerhetsz.



www.acnielsen.aim.dk/LEGO



LEGO STAR WARS™

THE VIDEO GAME



4276595

©2005 The LEGO Group.

 PlayStation 2

 XBOX

GAME BOY ADVANCE™

PC CD-ROM



LEGO, the LEGO logo and the Minifigure are trademarks of The LEGO Group. © 2004 The LEGO Group. © 2004 Lucasfilm Entertainment Company Ltd. or Lucasfilm Ltd. & © or TM as indicated. All rights reserved. Microsoft, Xbox and the Xbox logos are either registered trademarks or trademarks of Microsoft Corporation in the U.S. and/or in other countries and are used under license from Microsoft. All rights reserved.  and "PlayStation" are registered trademarks of Sony Computer Entertainment Inc. All rights reserved.

GAME BOY ADVANCE IS A TRADEMARK OF NINTENDO. The NINTENDO logo and "The way it's meant to be played" logo are registered trademarks or trademarks of NINTENDO Corporation.