

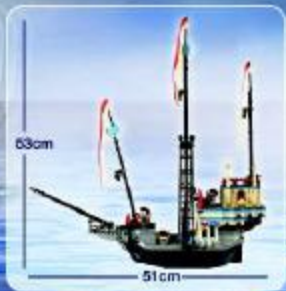

# Harry Potter

4763

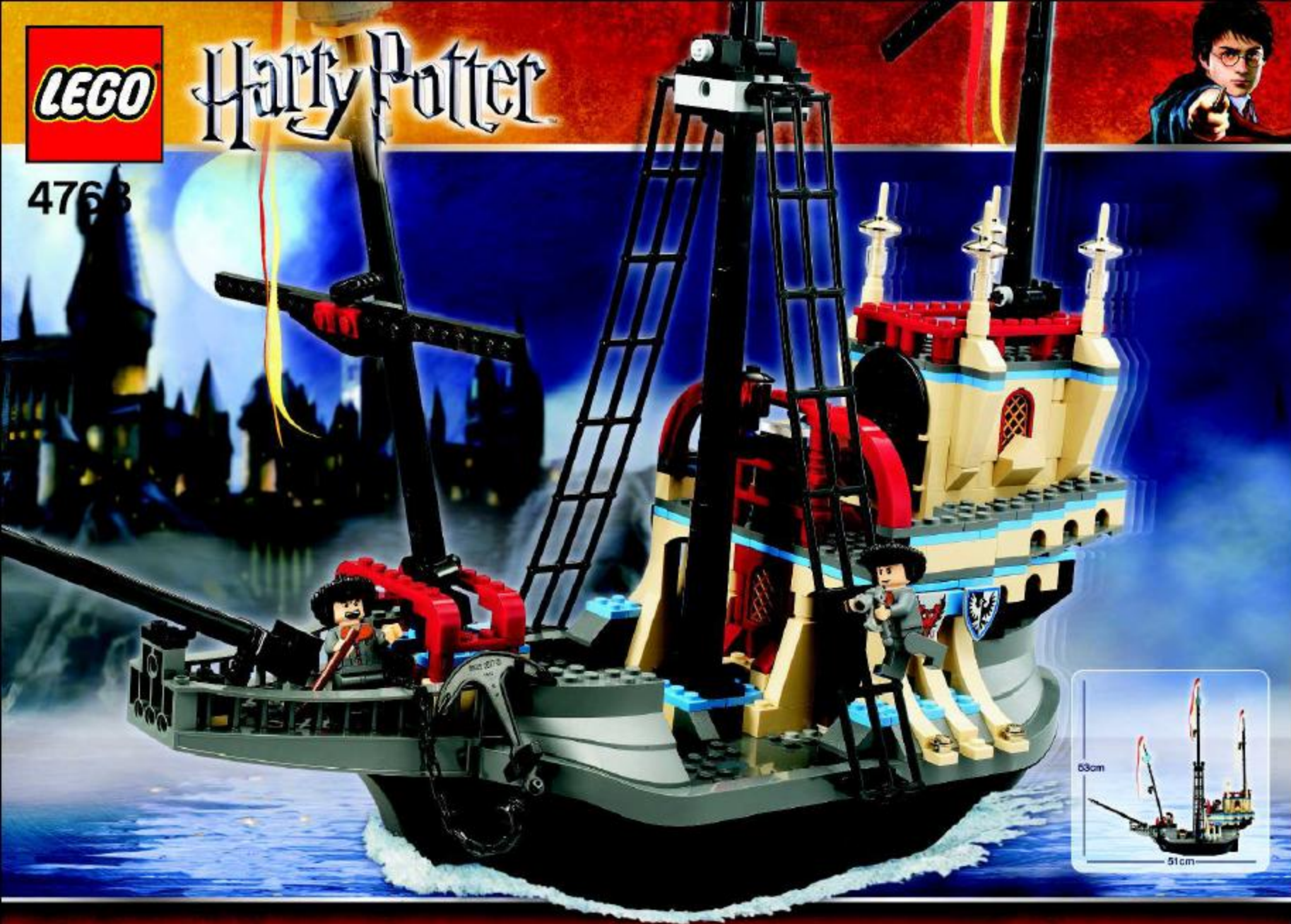

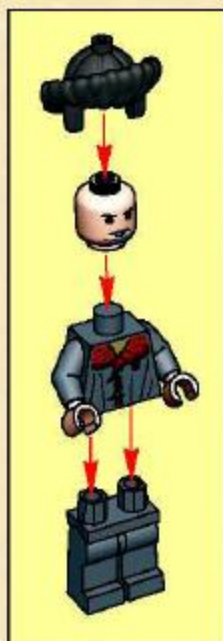





1

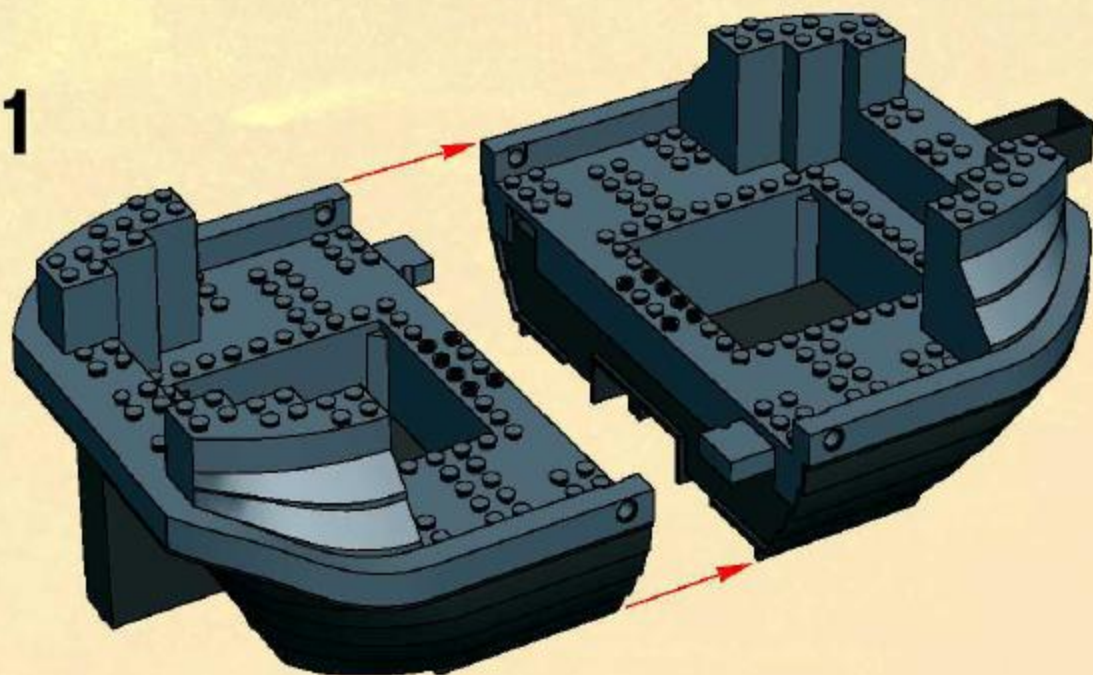

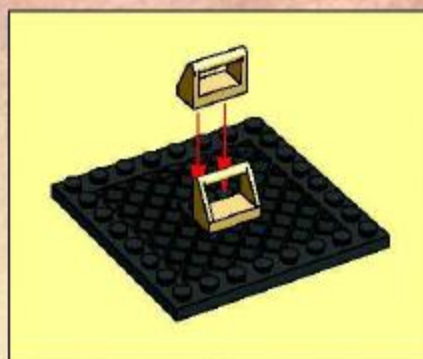

2

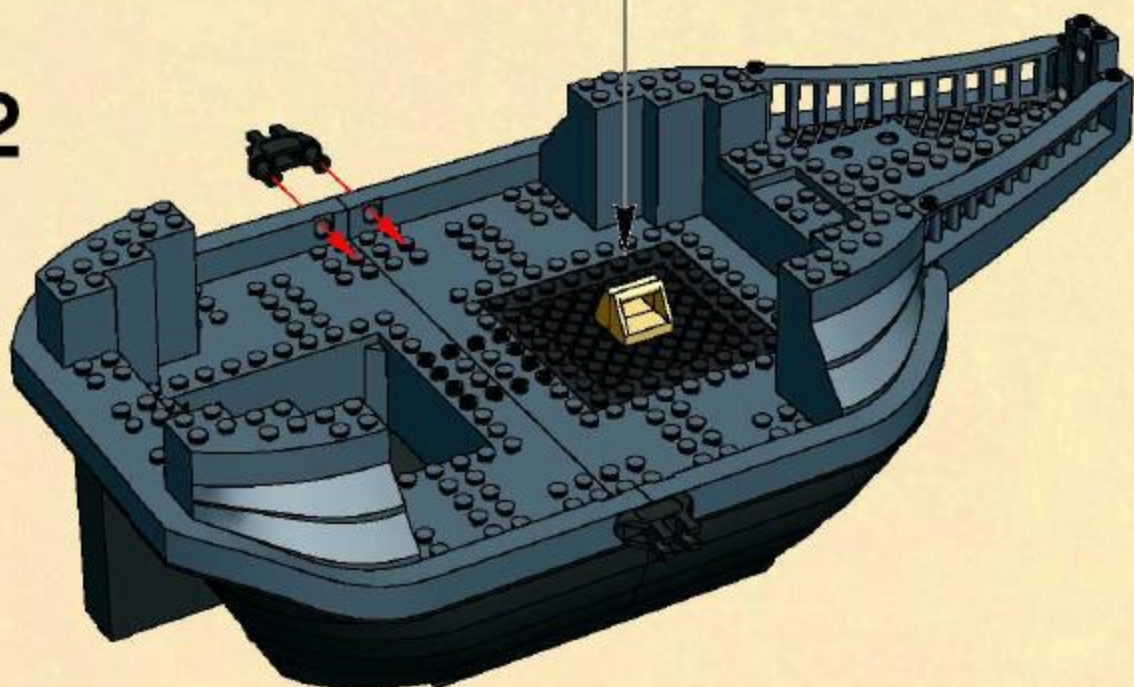



1



2



3

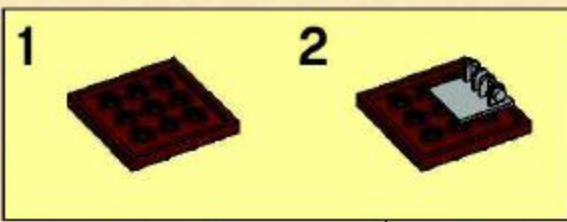

4

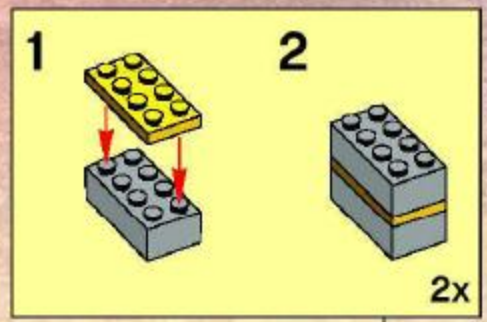

5

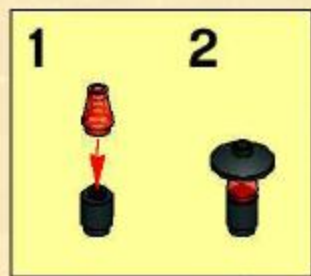
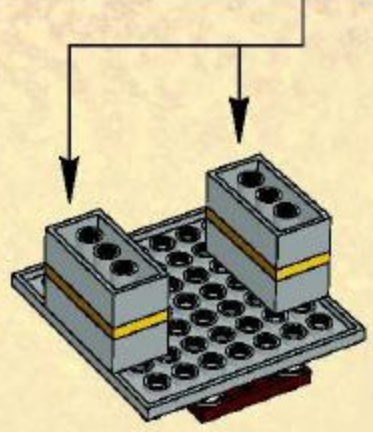

6

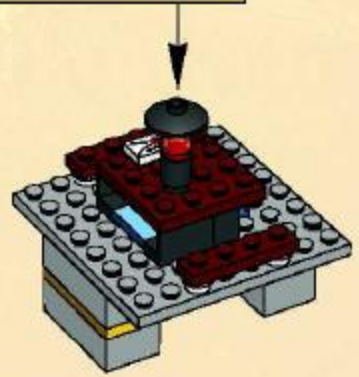

3

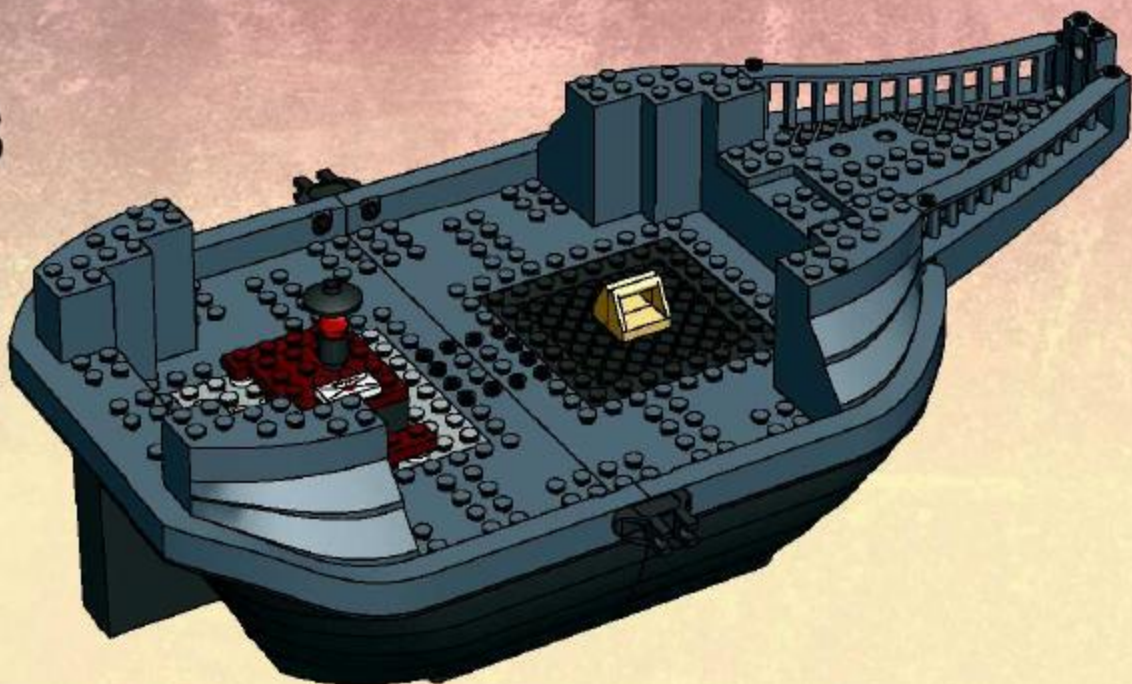

4

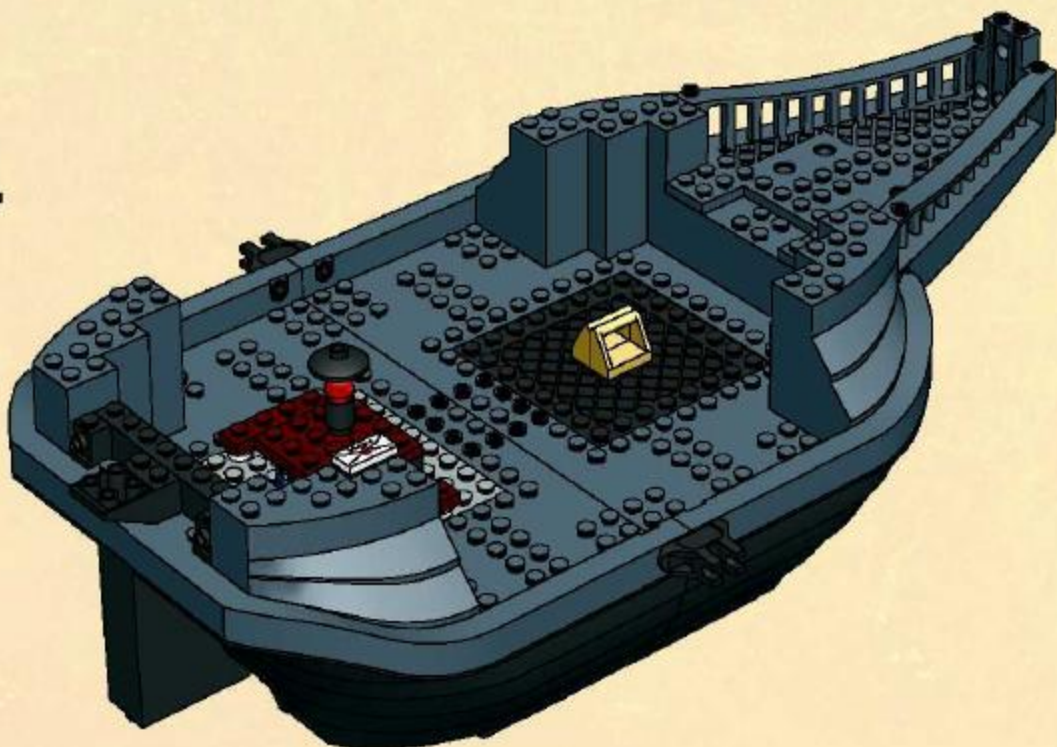



5

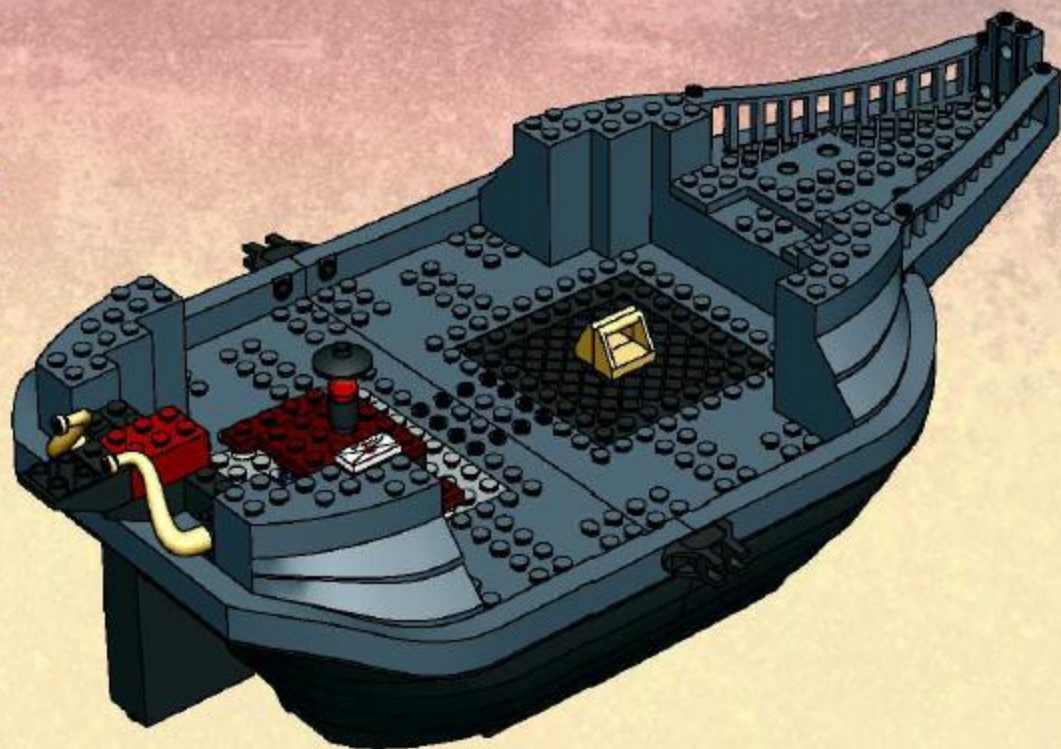

6

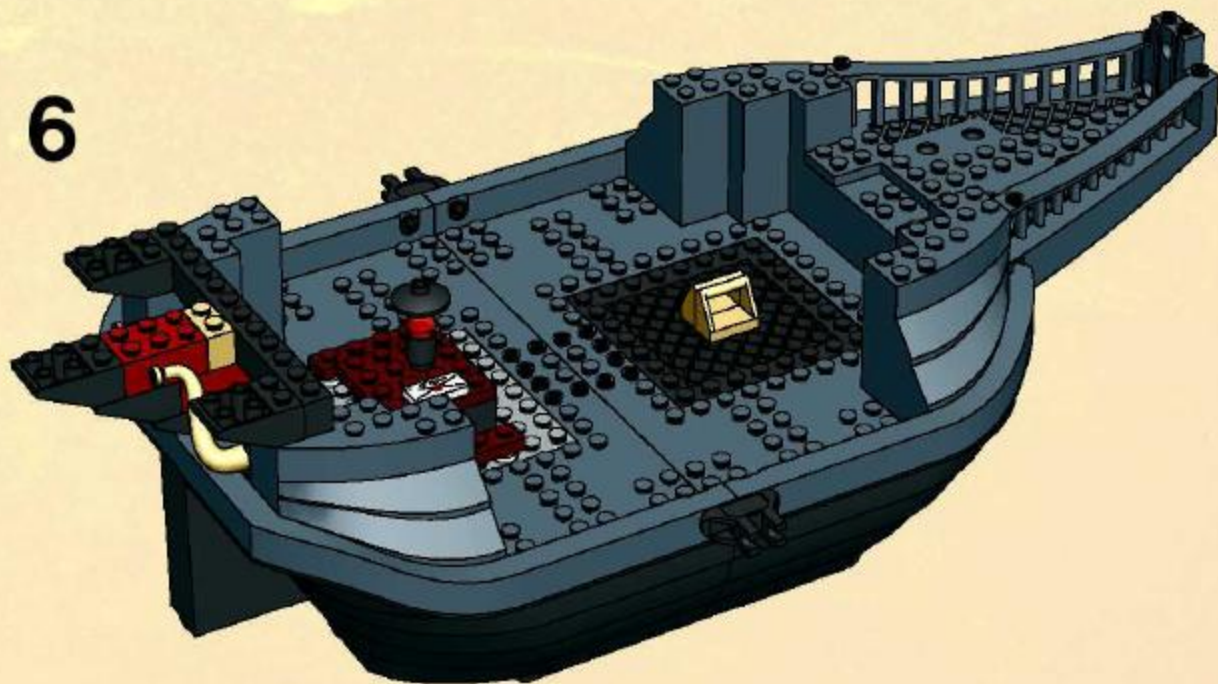

7

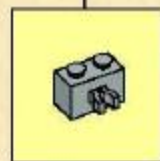
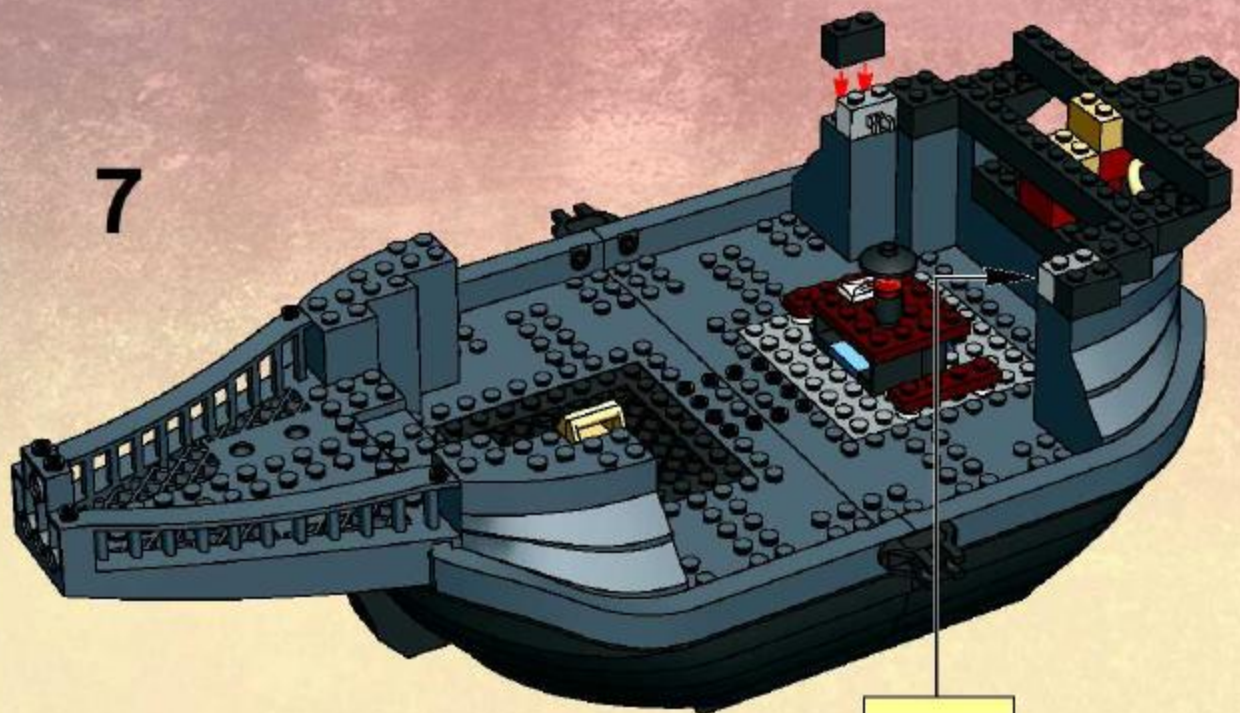

8

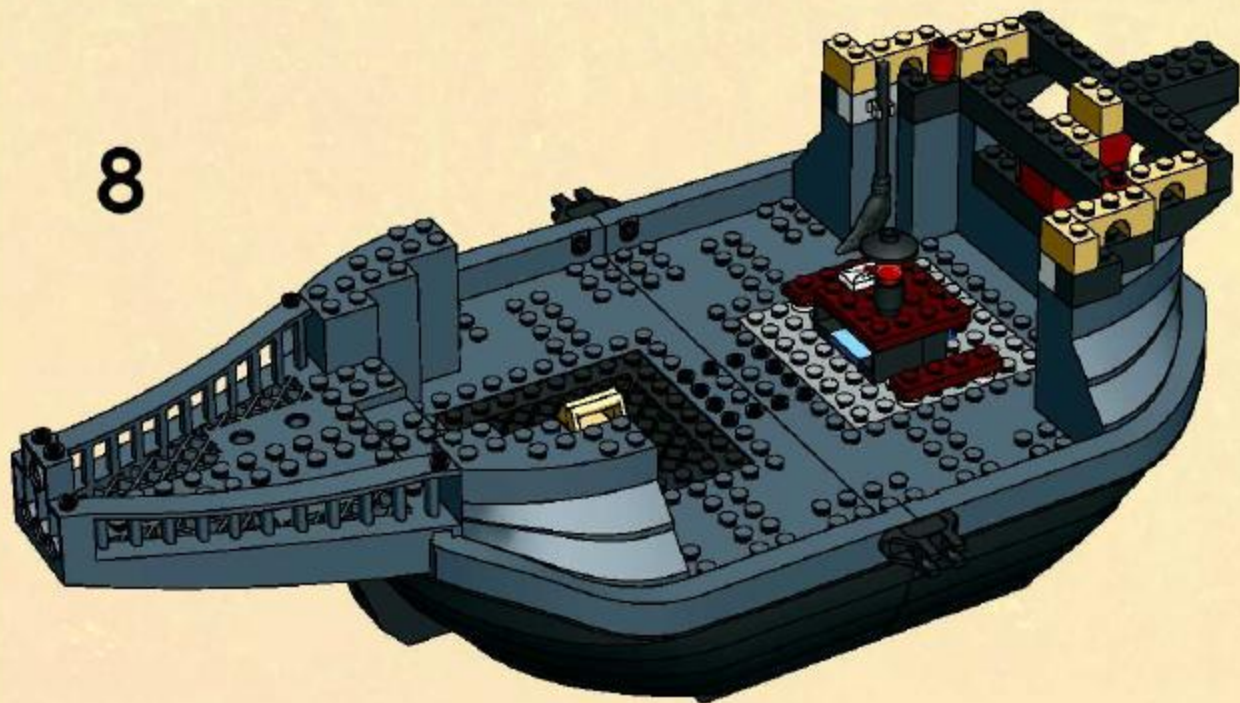



9

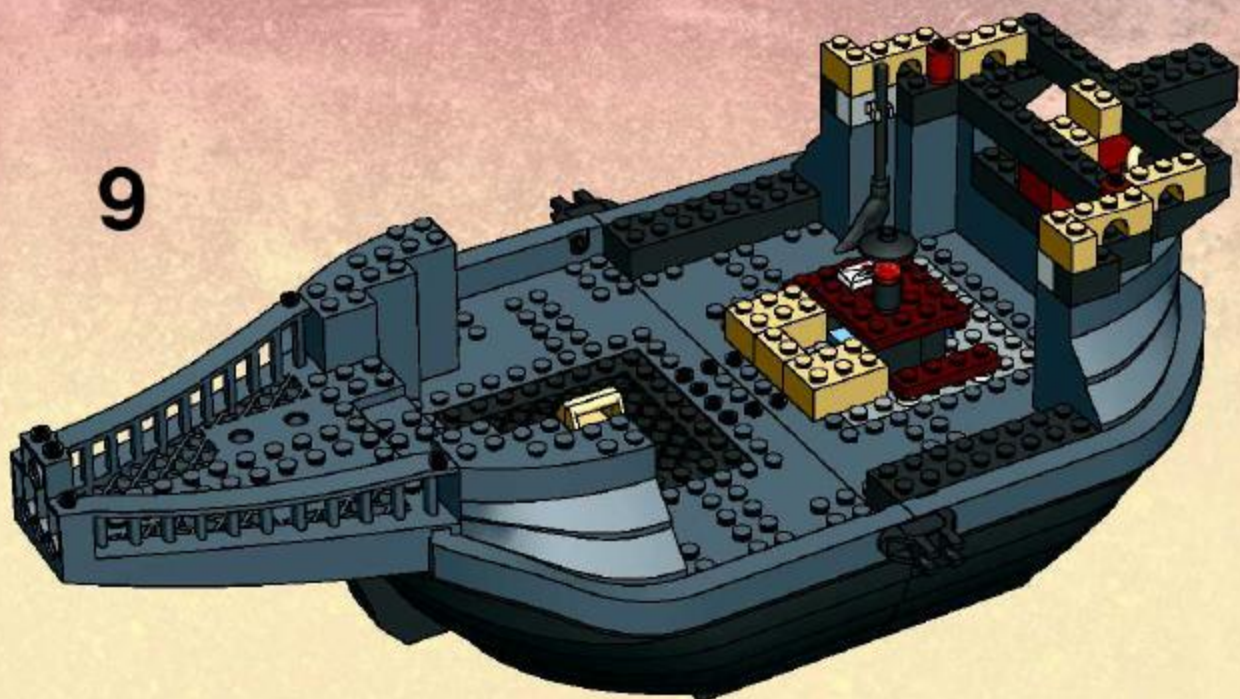

10

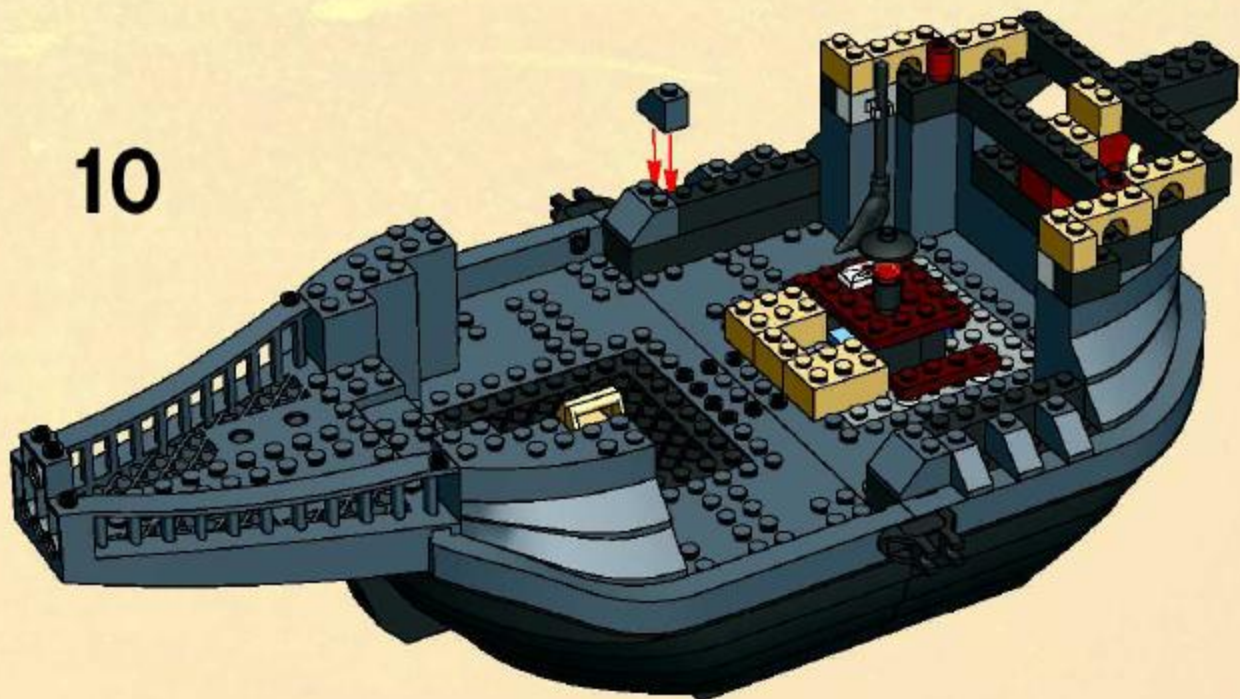



11

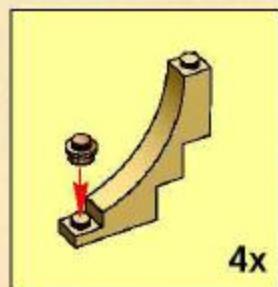
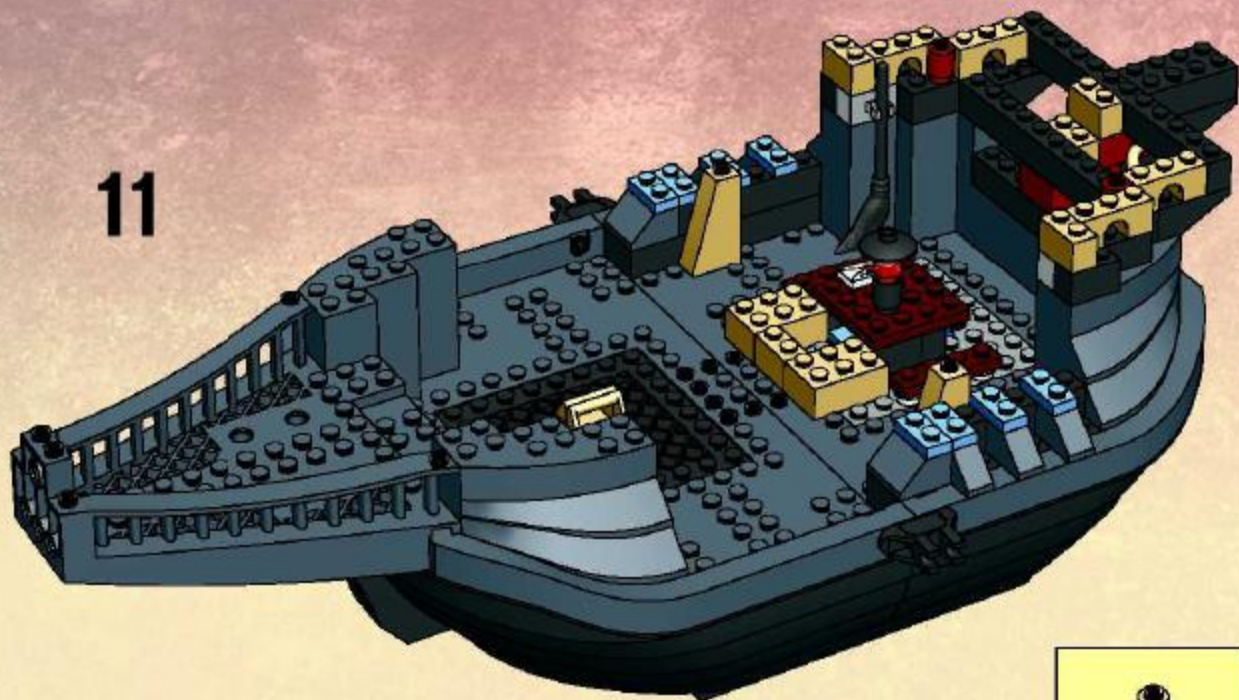

4x

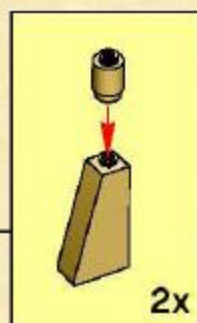

2x

12

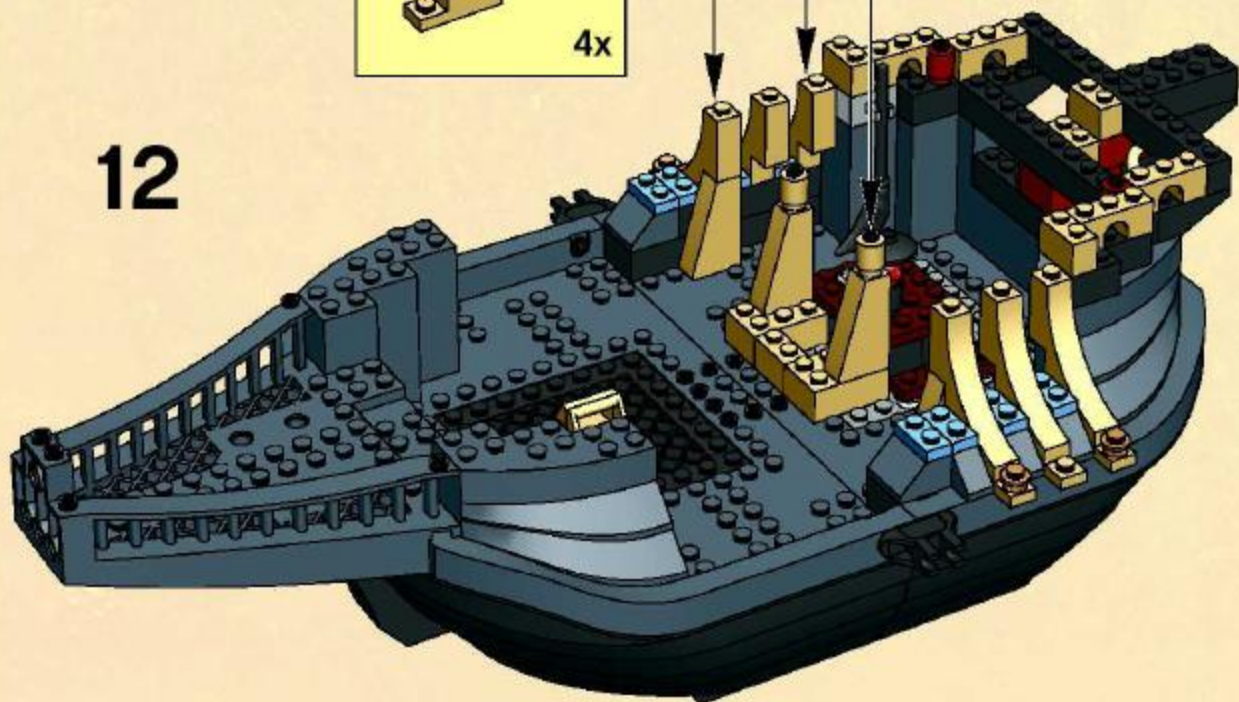



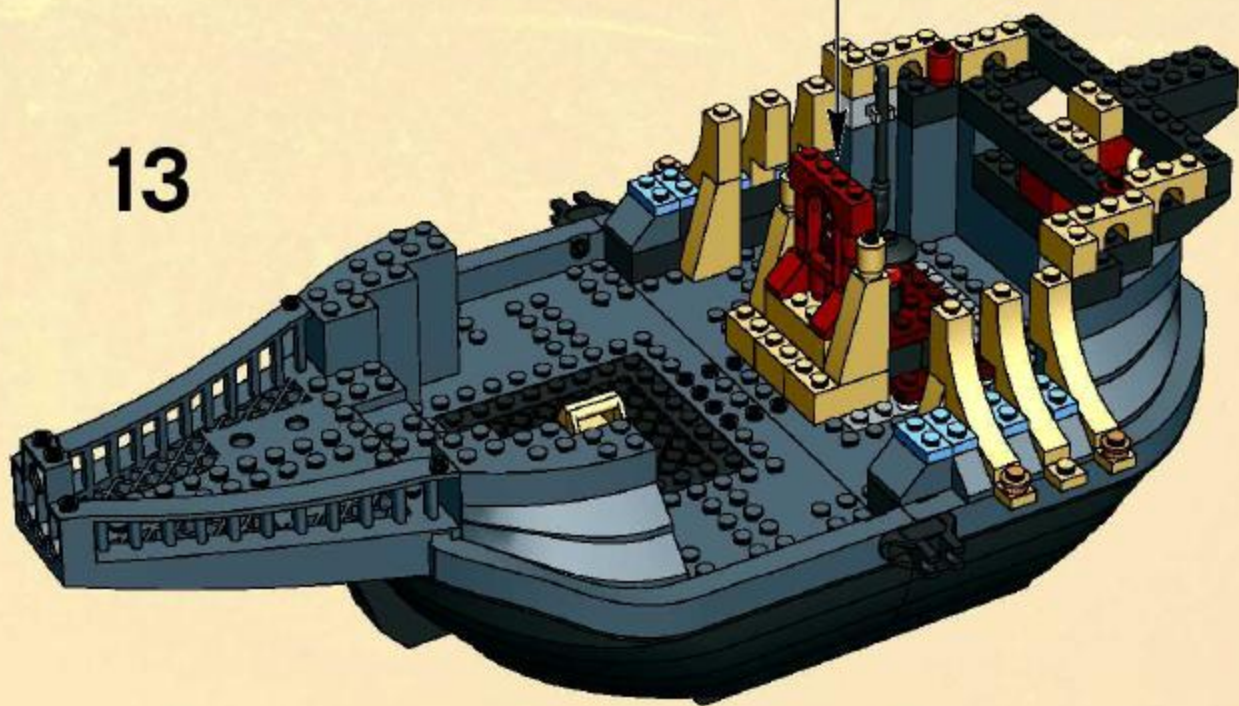
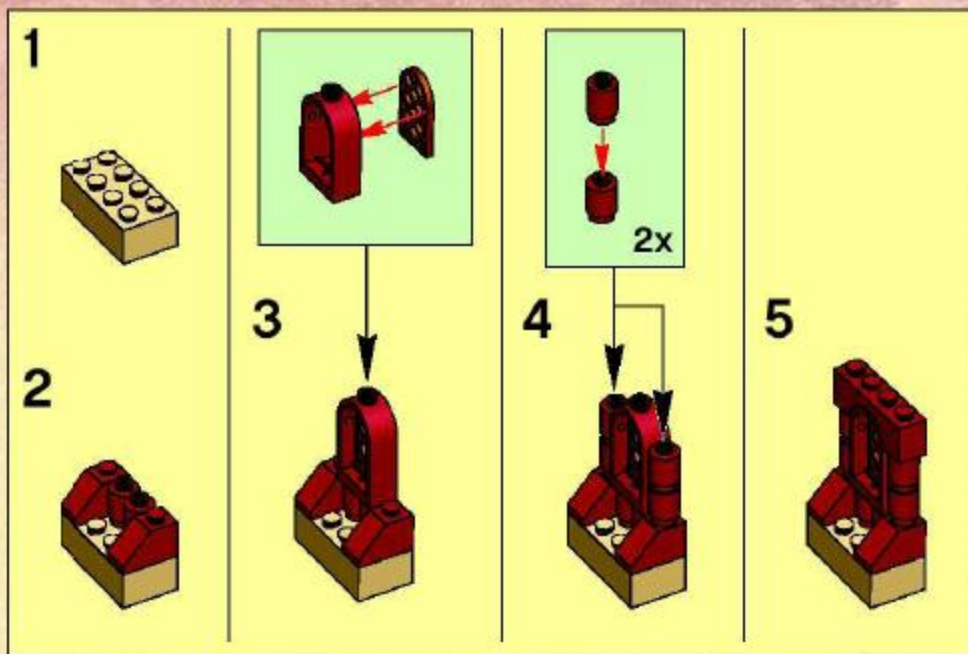

14

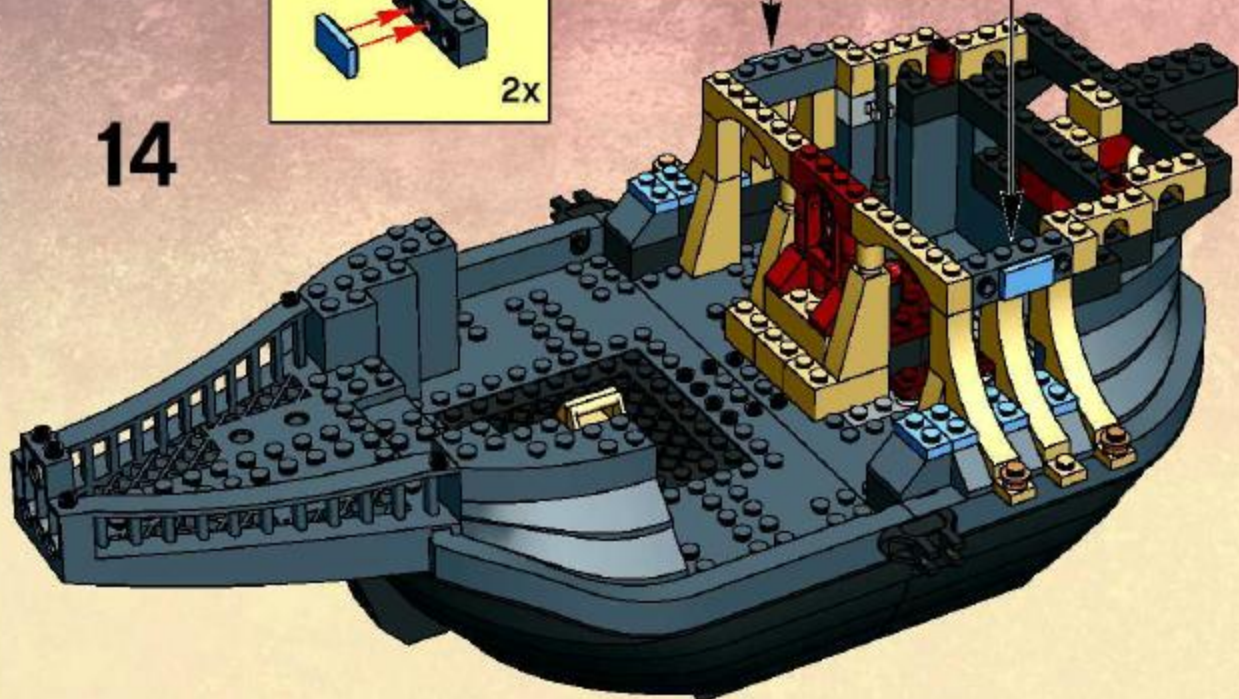
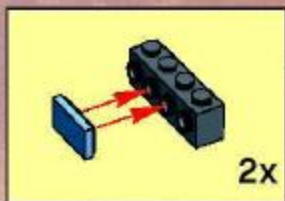

15

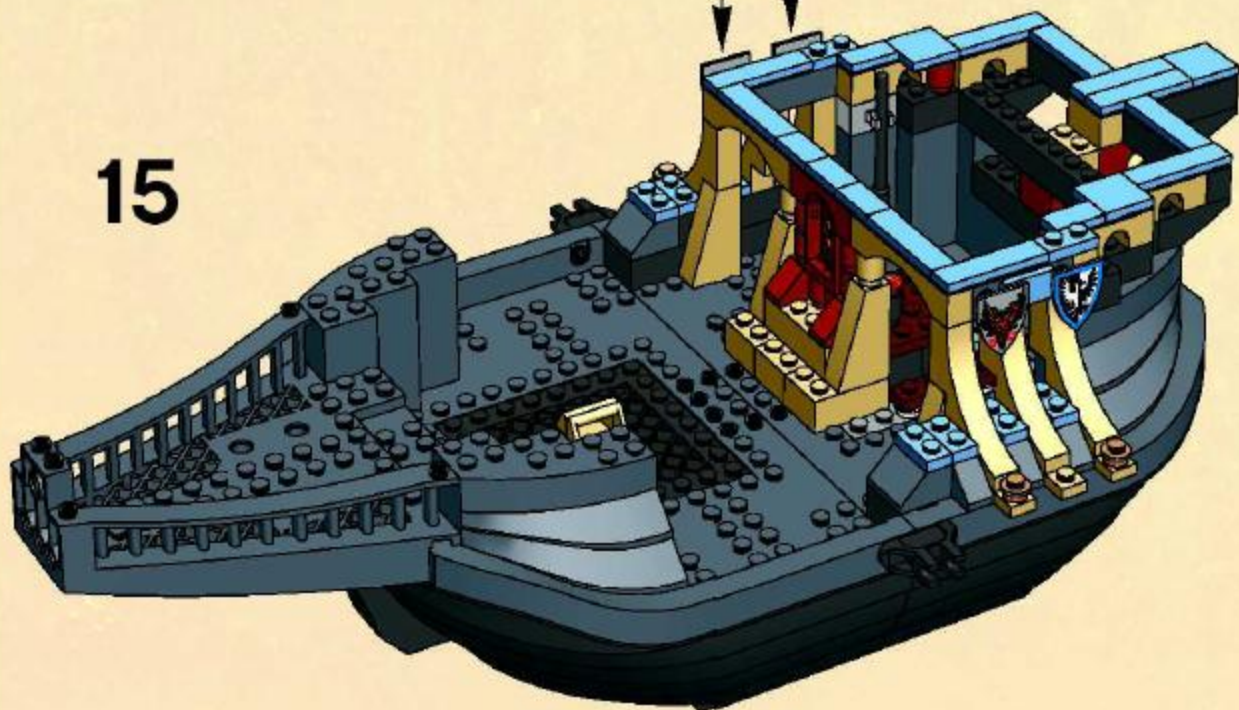
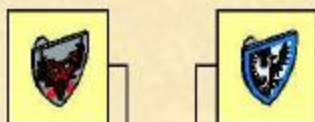



16

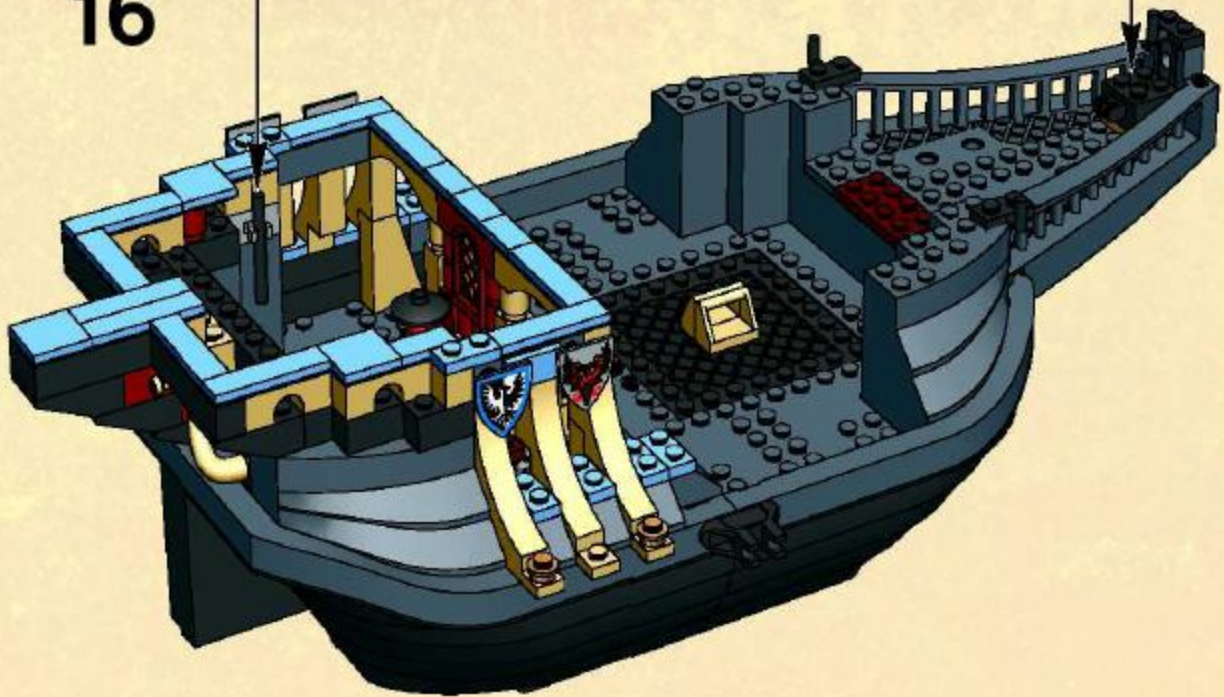

17

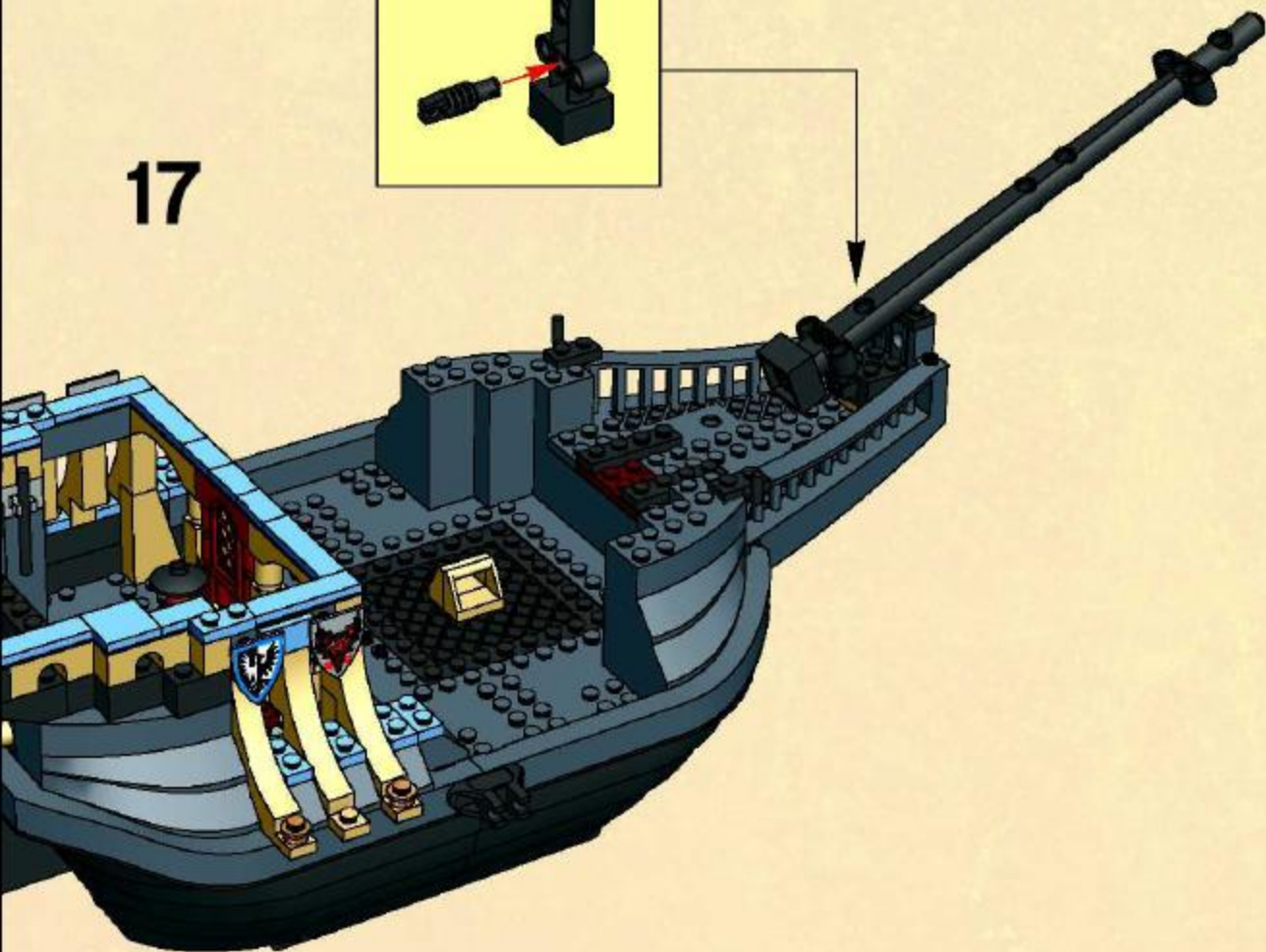
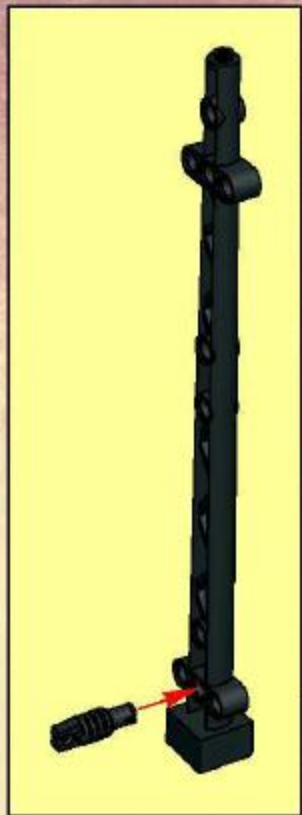



18

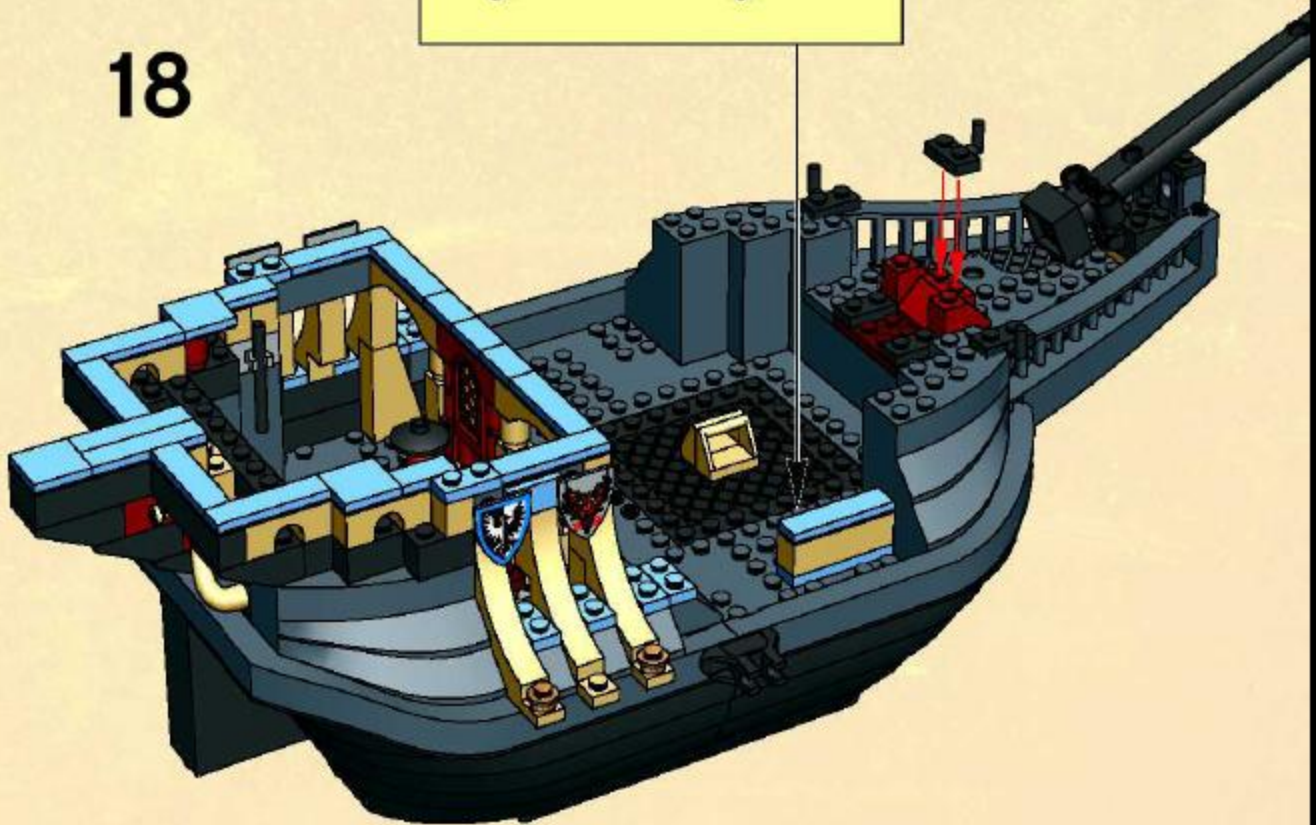
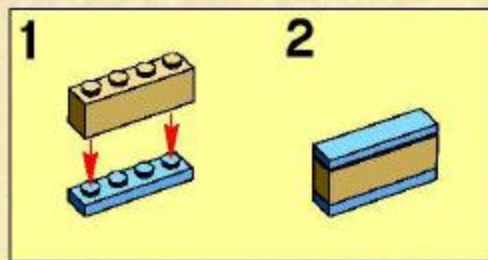

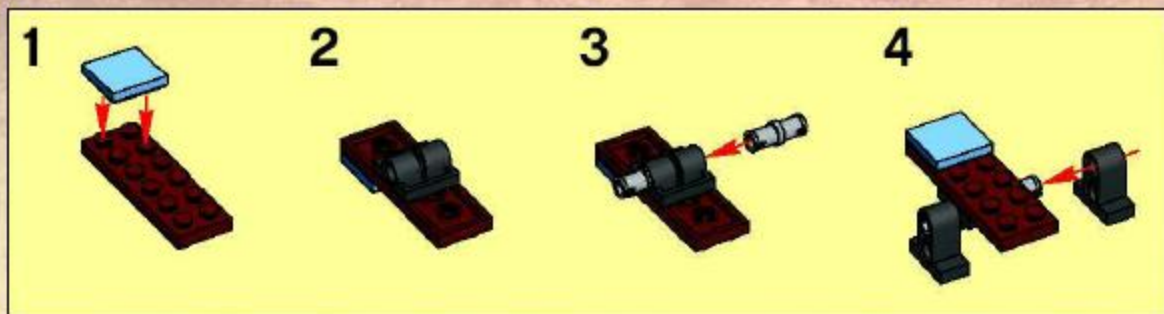

19

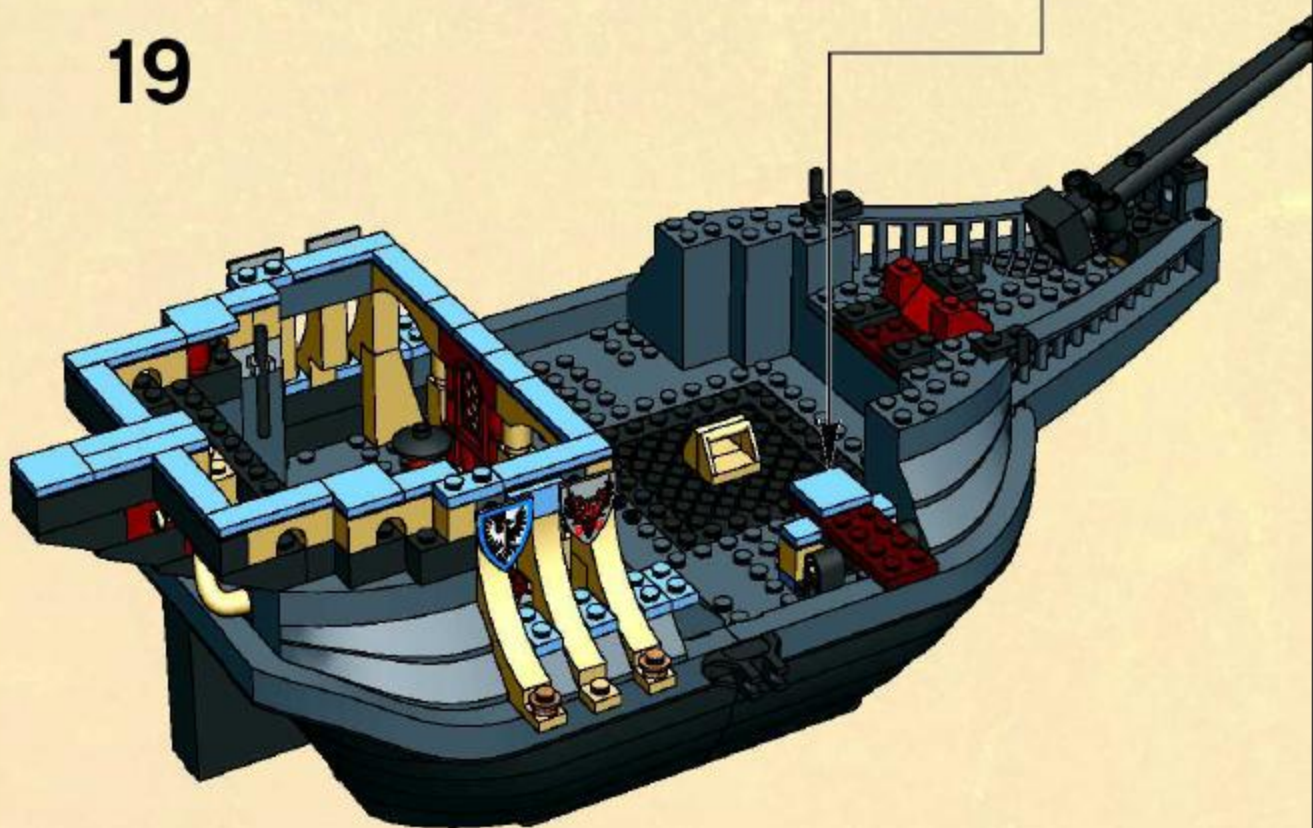



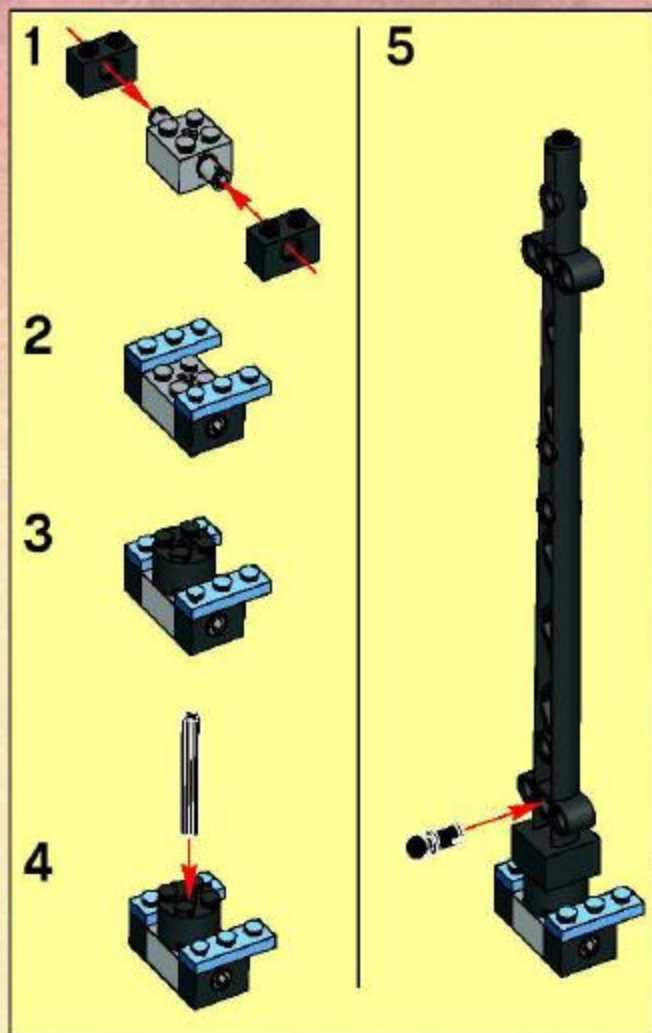

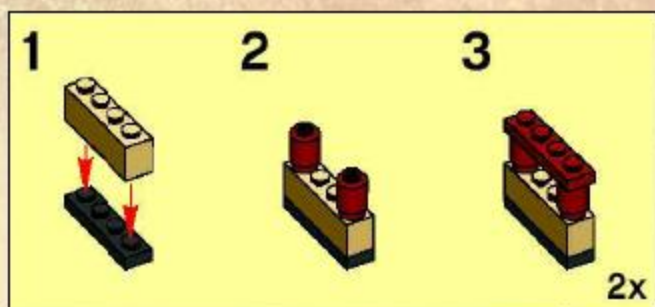

21

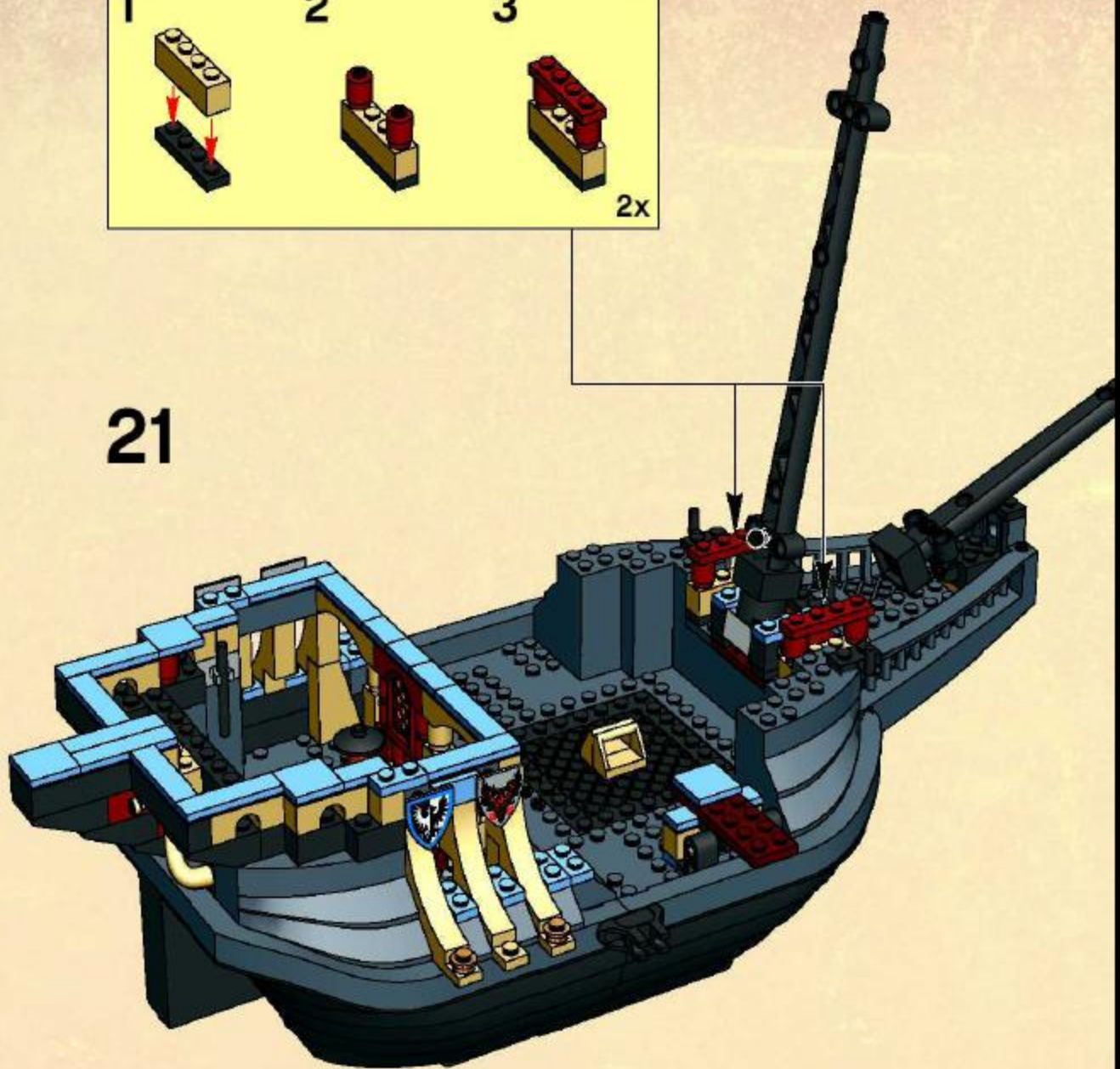



22

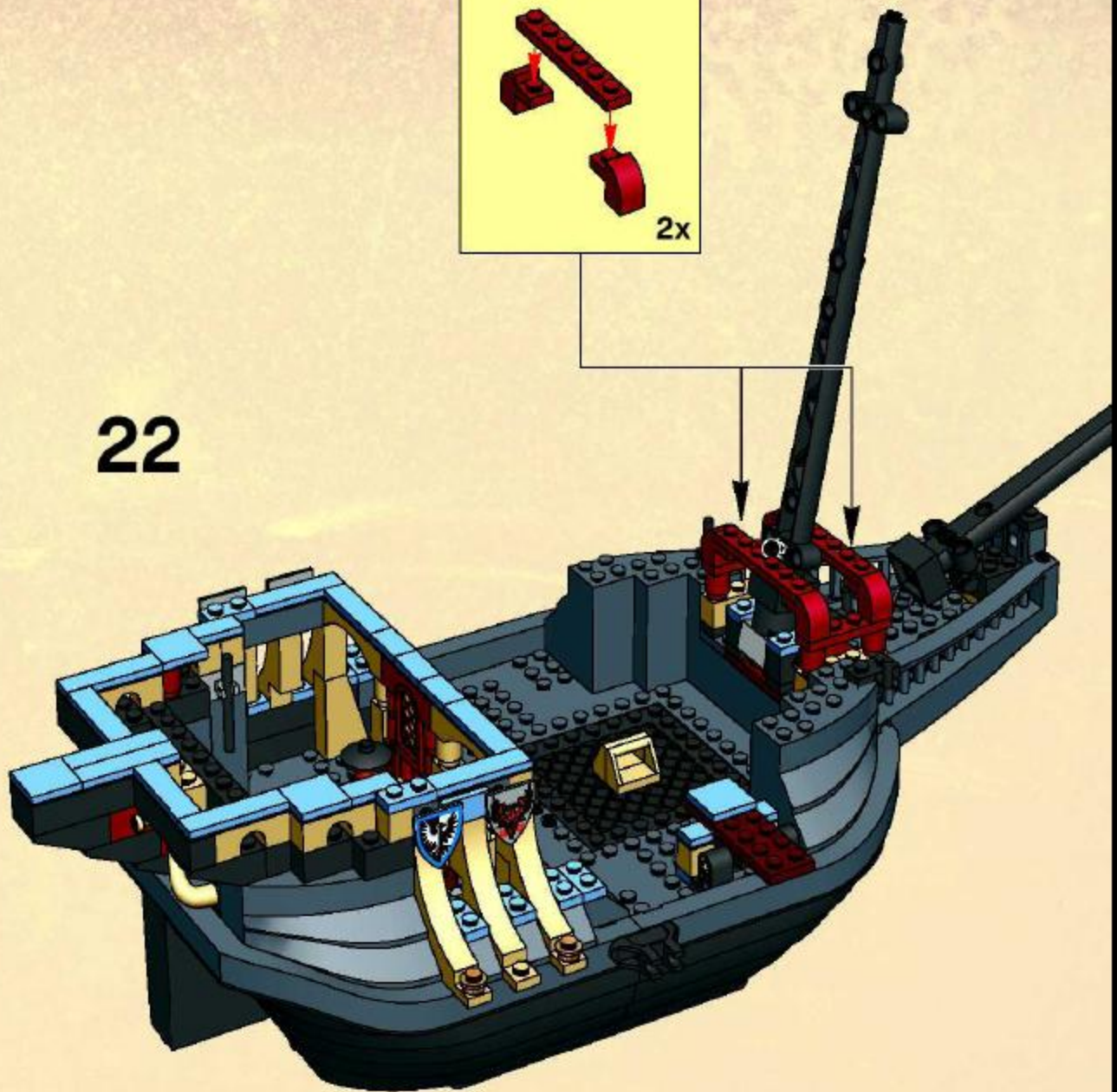
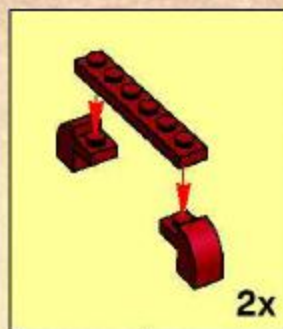



1



2

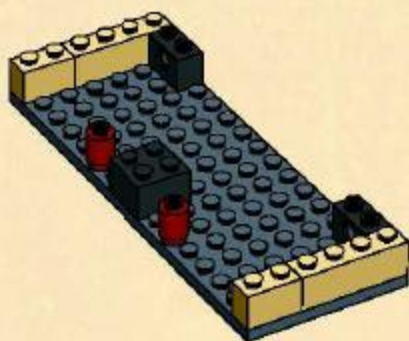

3

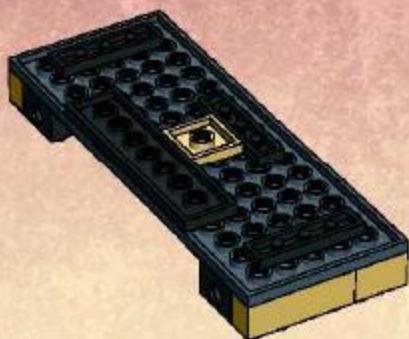

4

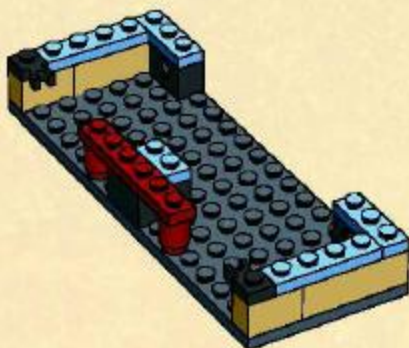

5

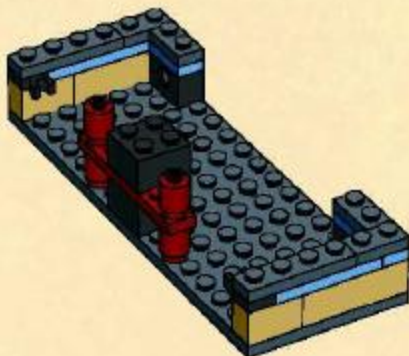



6

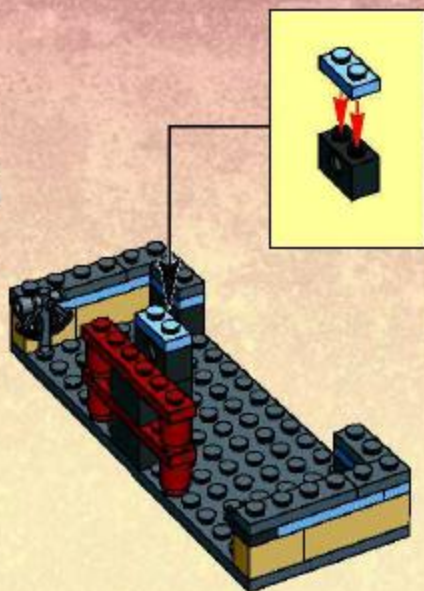

8

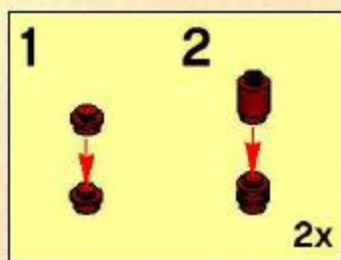
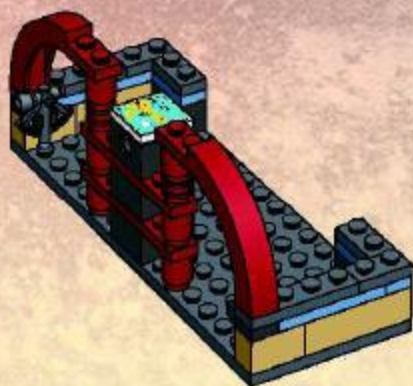

7

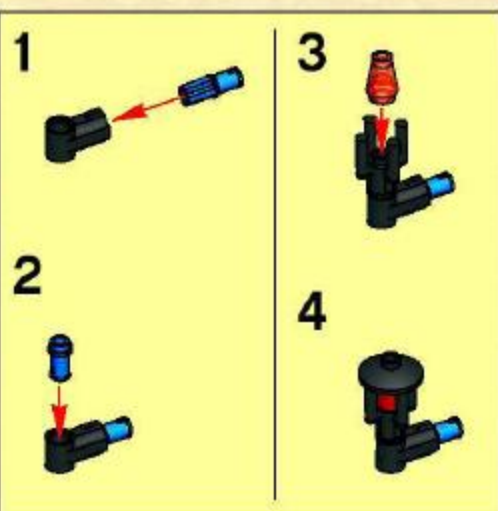
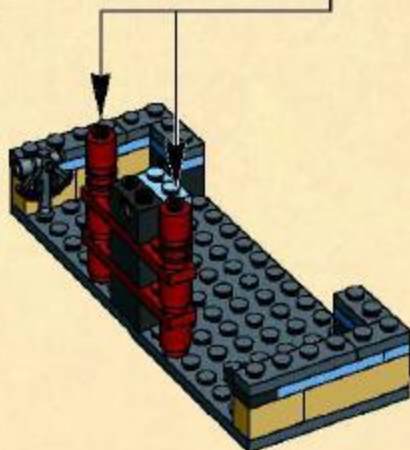

9

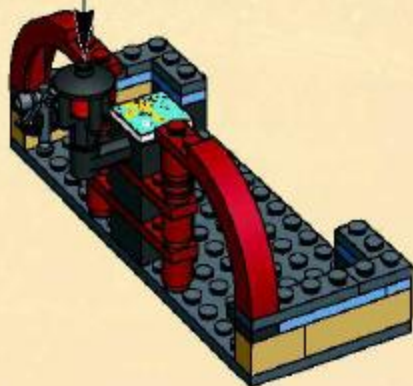

10

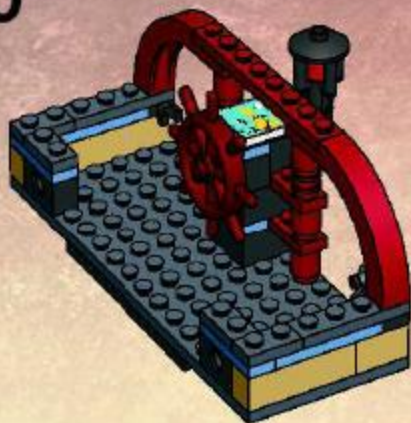

11



23

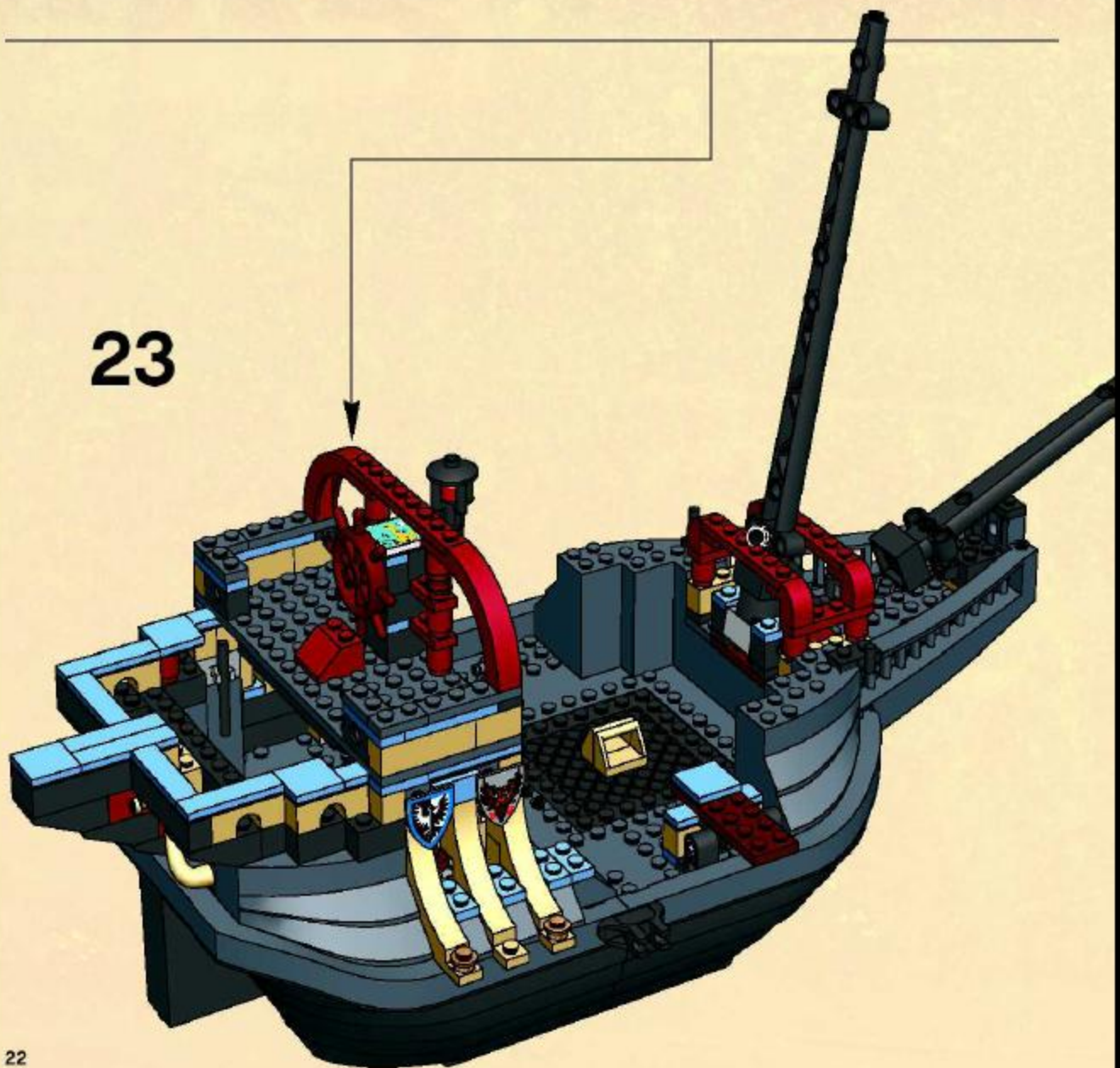





1

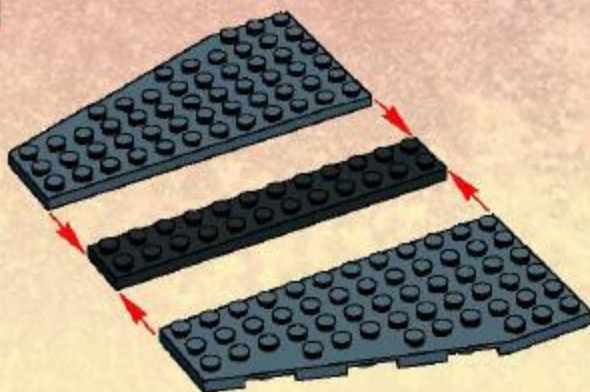

2

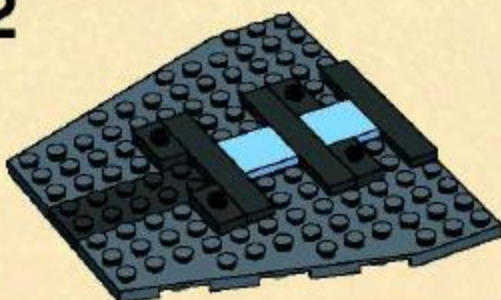

3

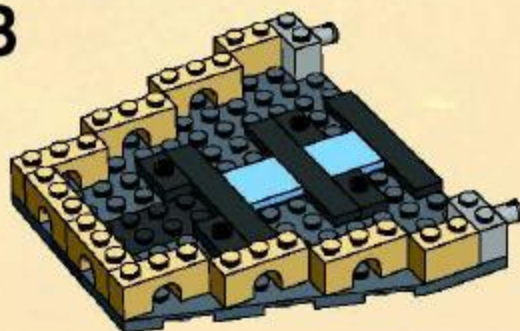

4

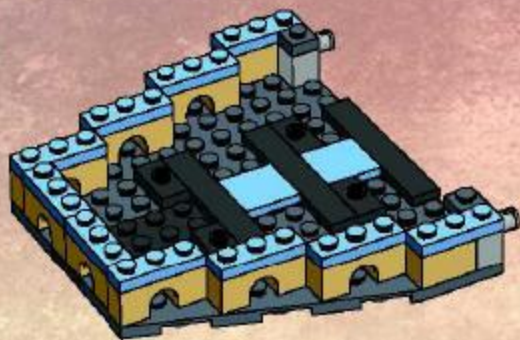

5

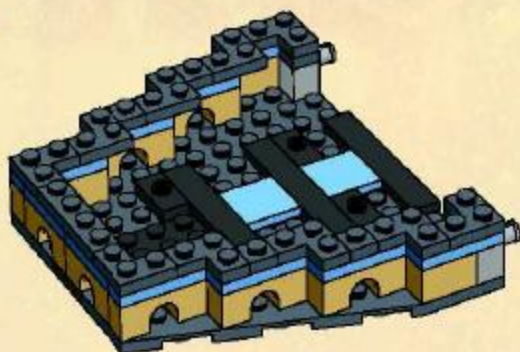

24

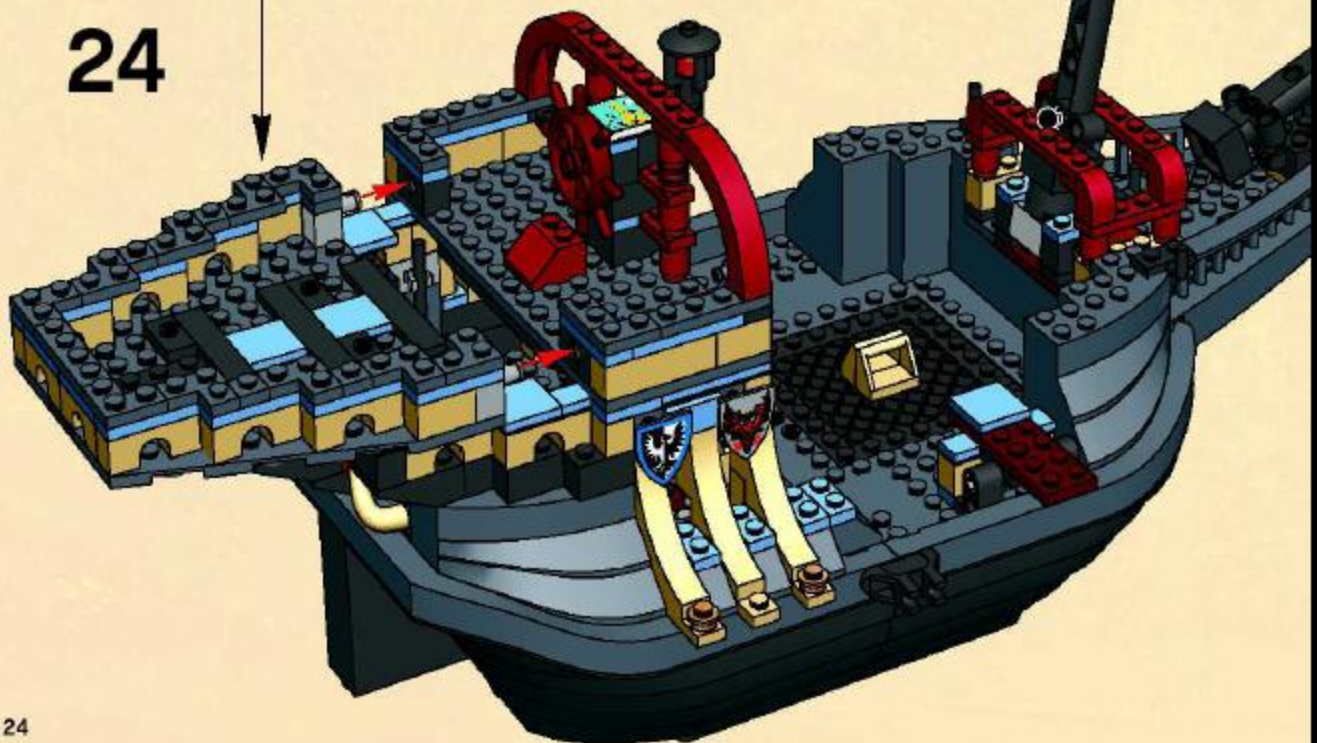





1

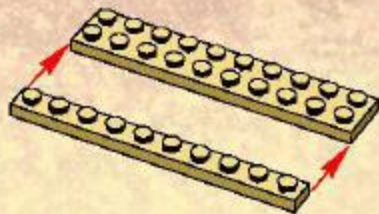

2

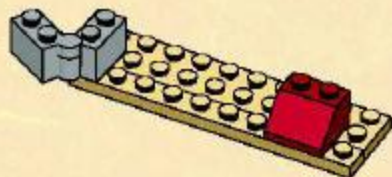
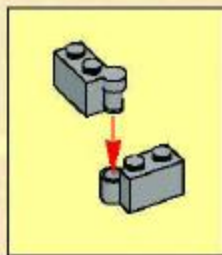

3

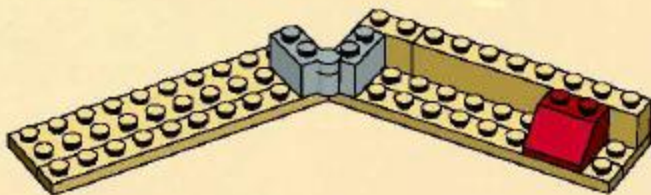

4

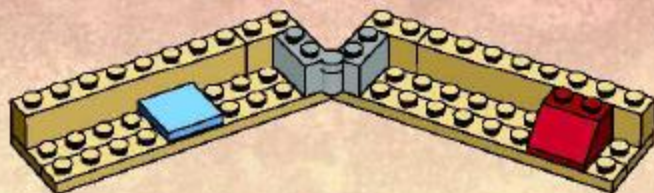

5



6





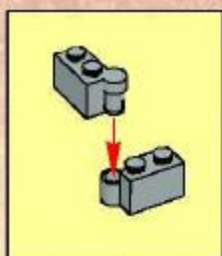
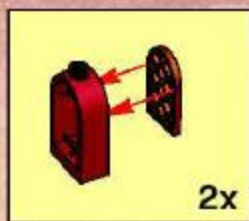

7



8



9

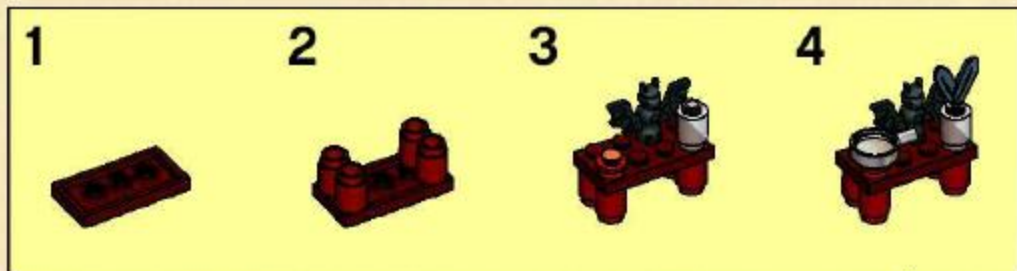
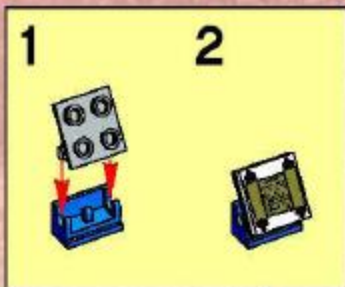

10





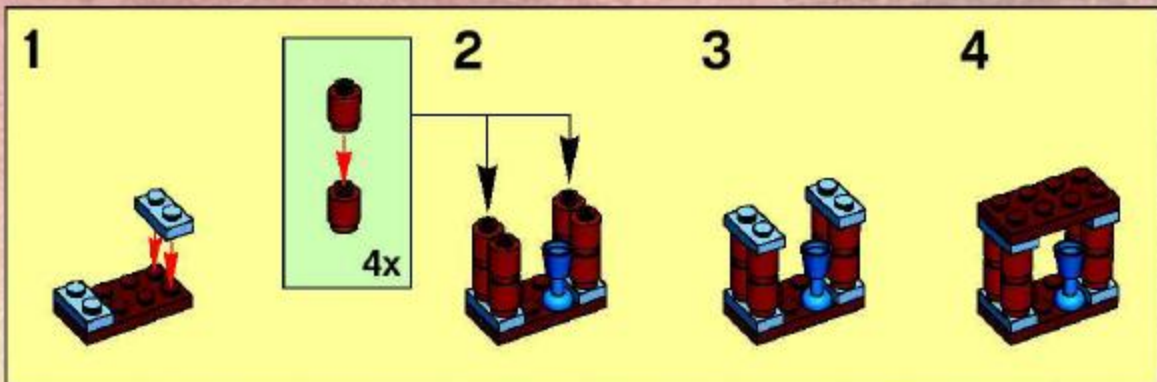

11



12

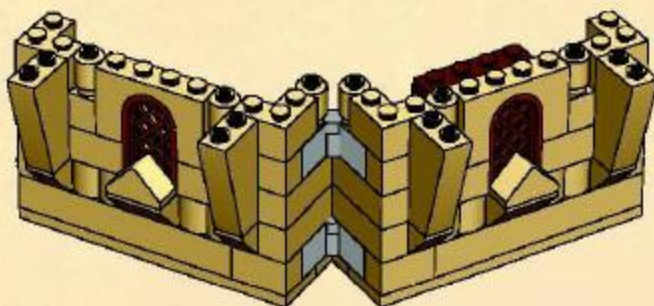

13



14

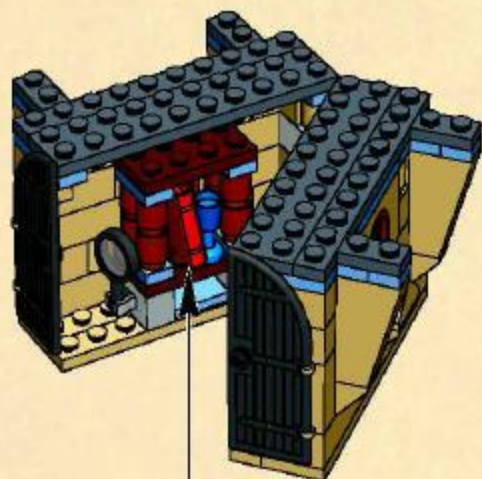



15

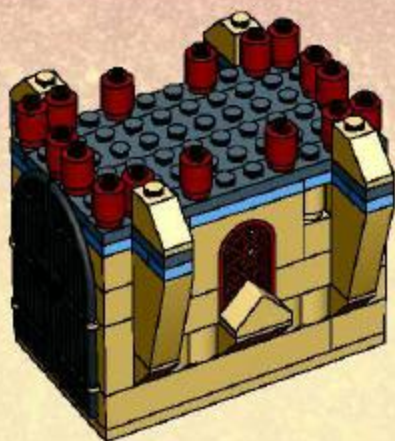

16



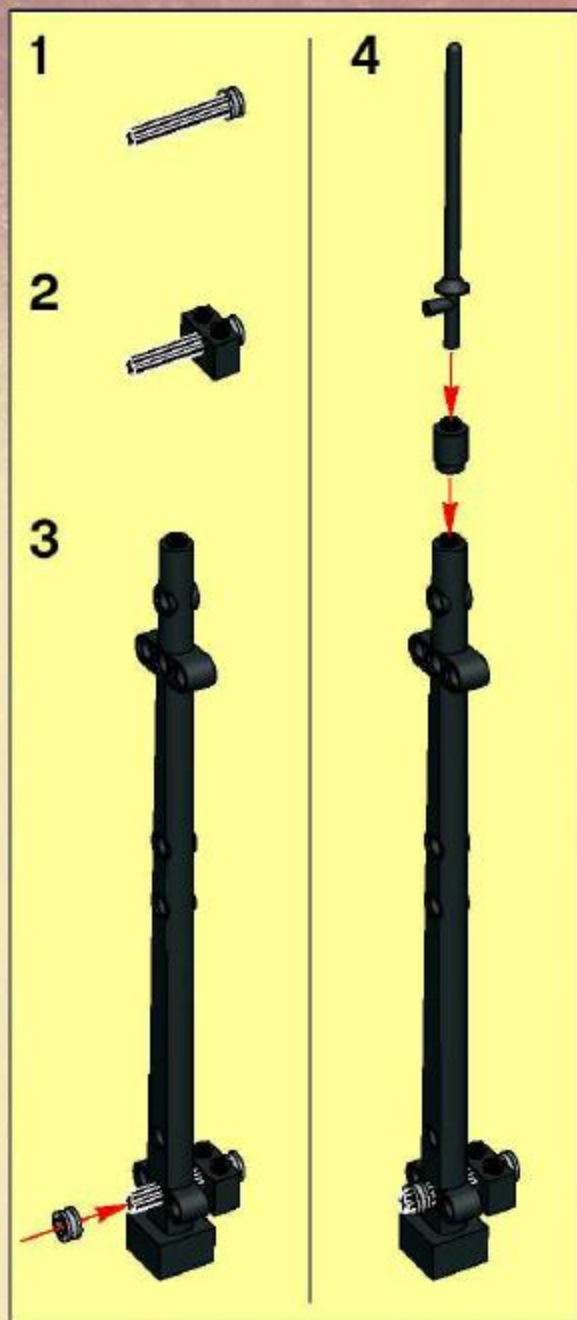

17

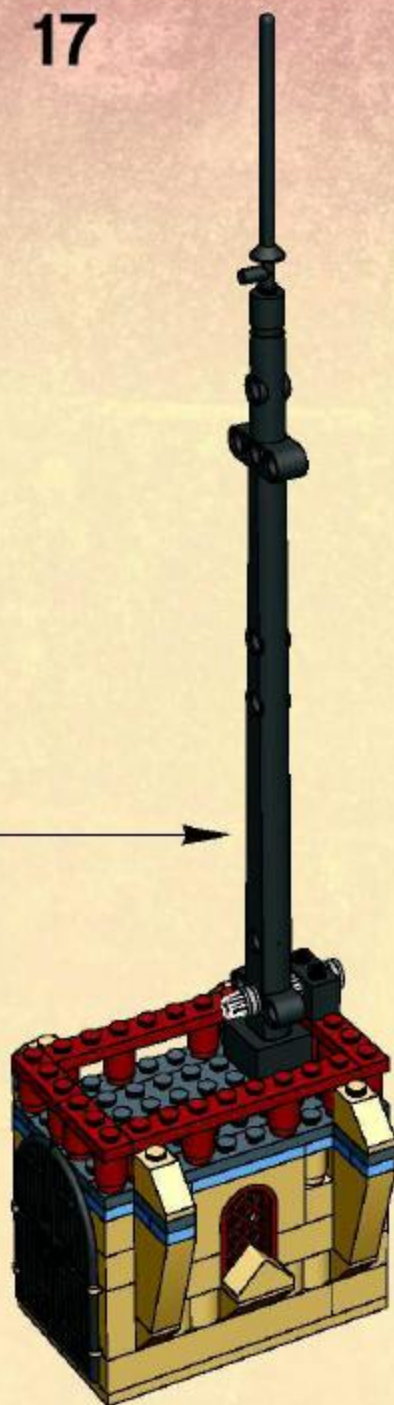



18

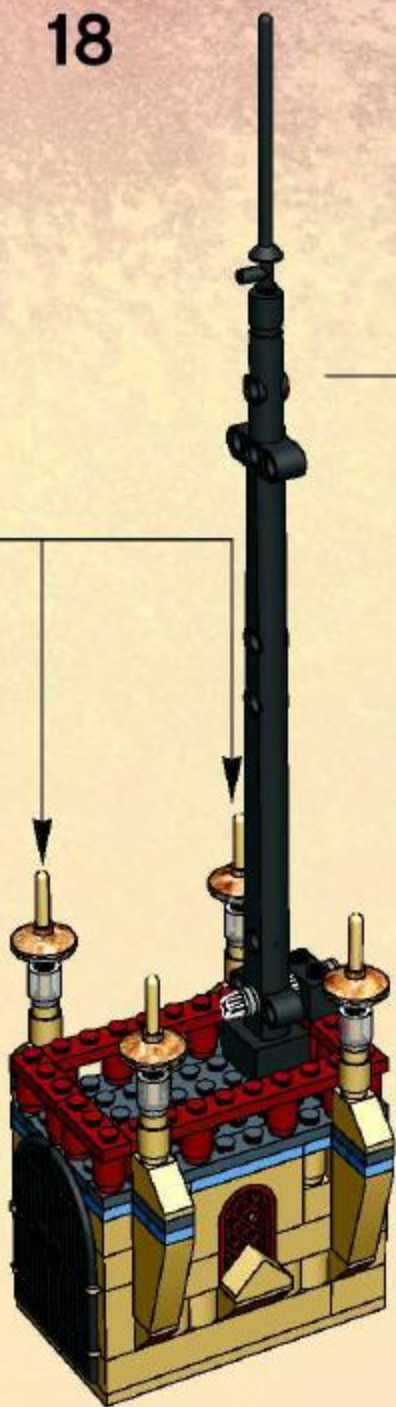
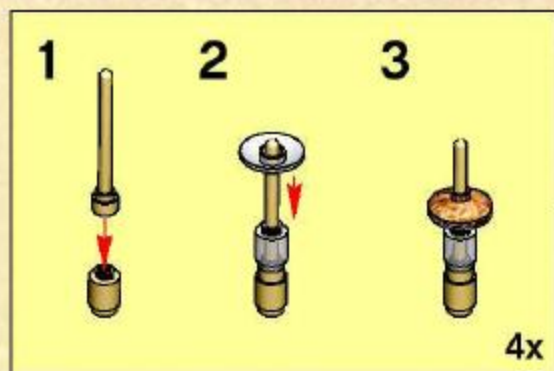

25

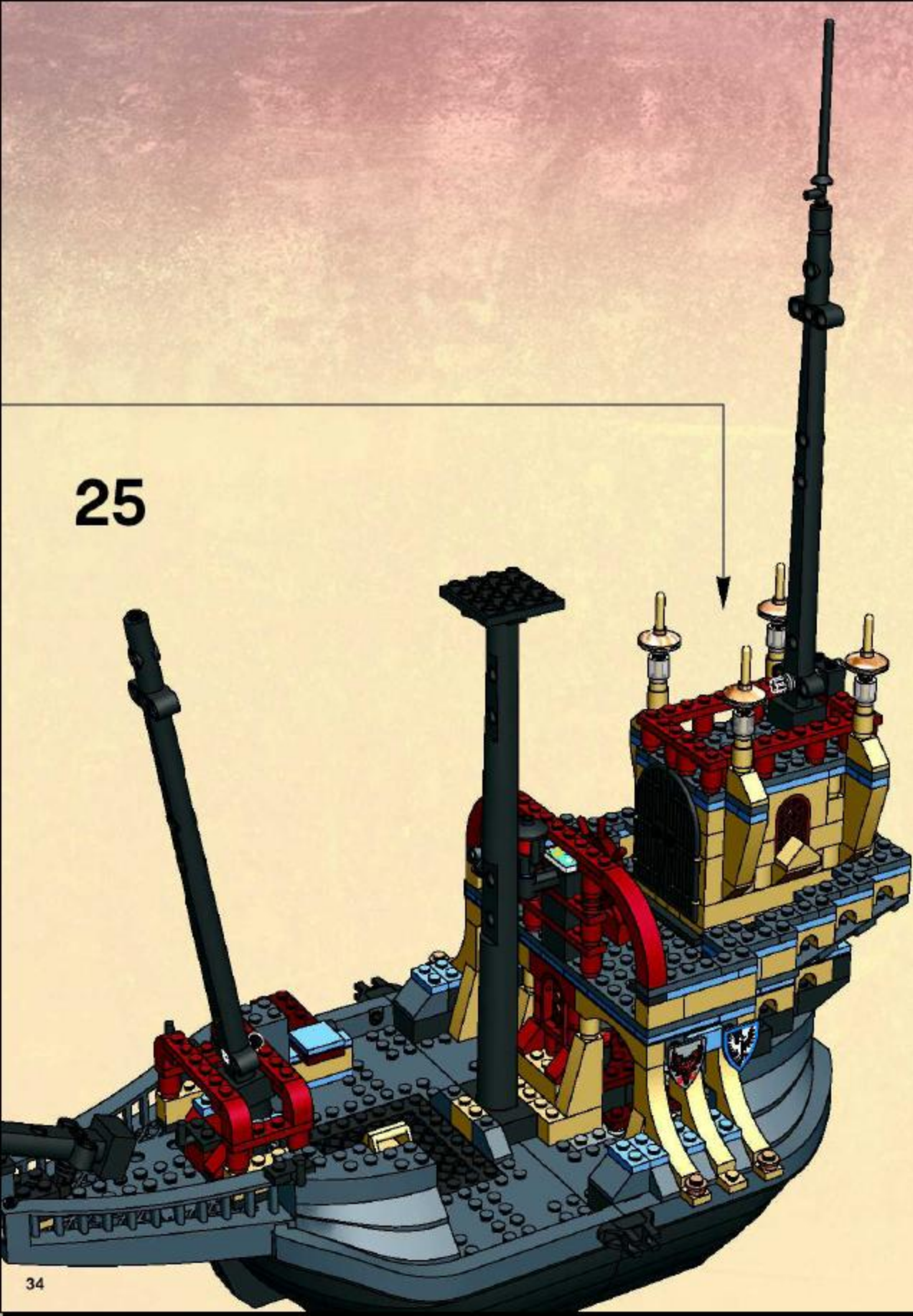



26

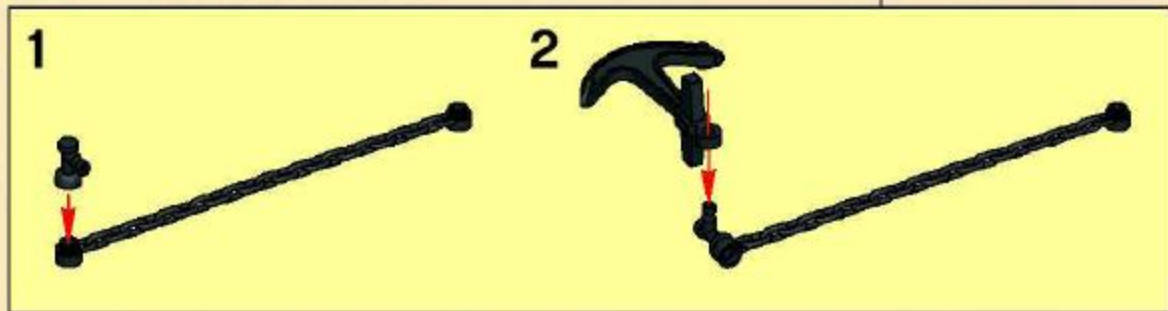
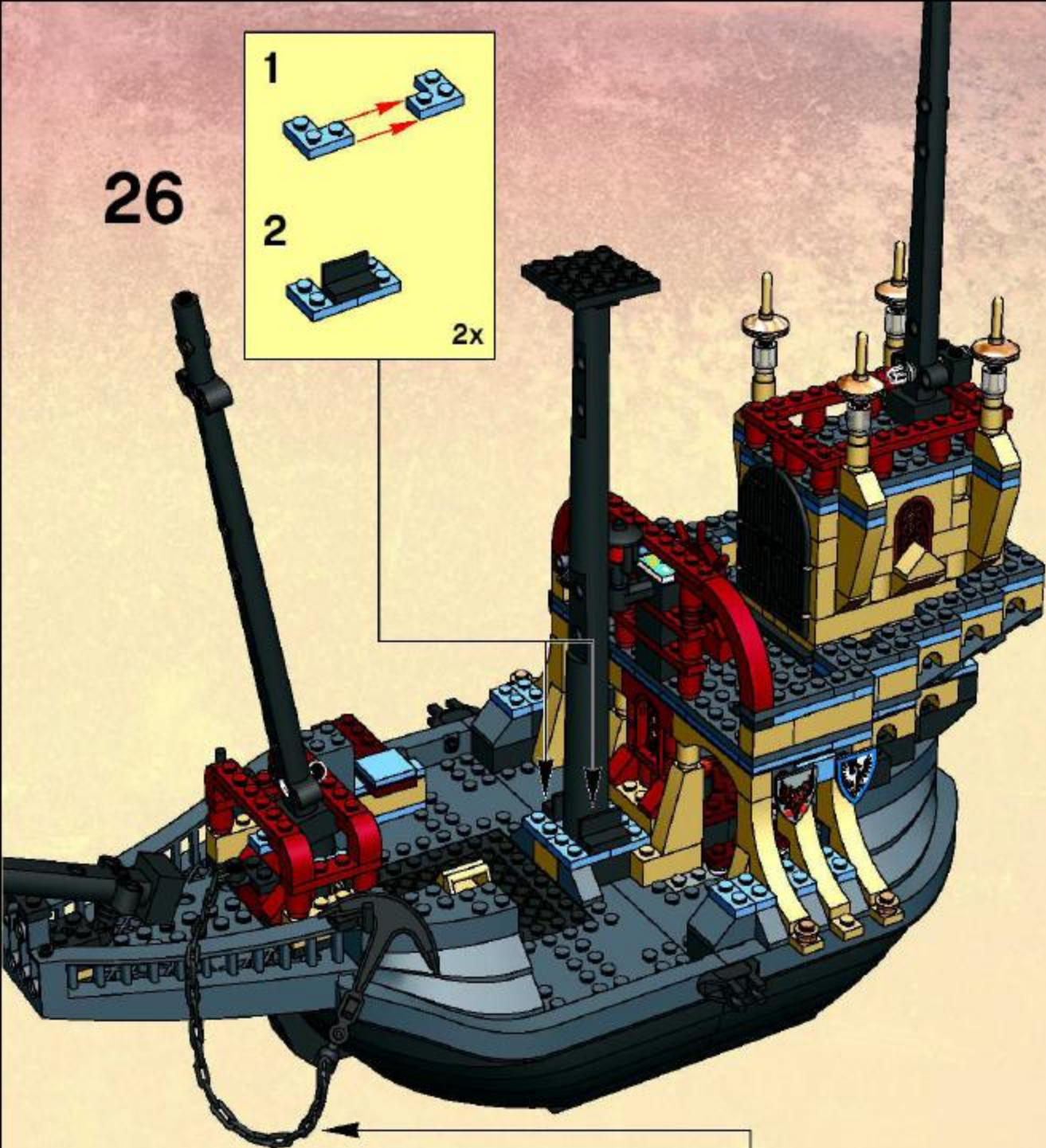
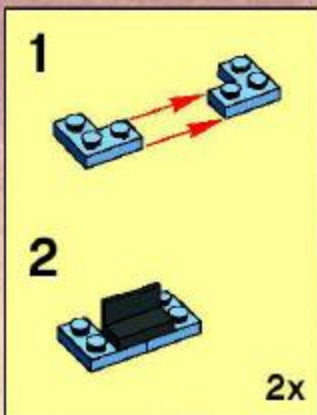

1

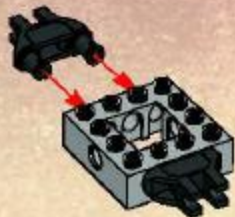

2



3



4



5

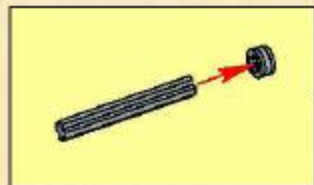



27

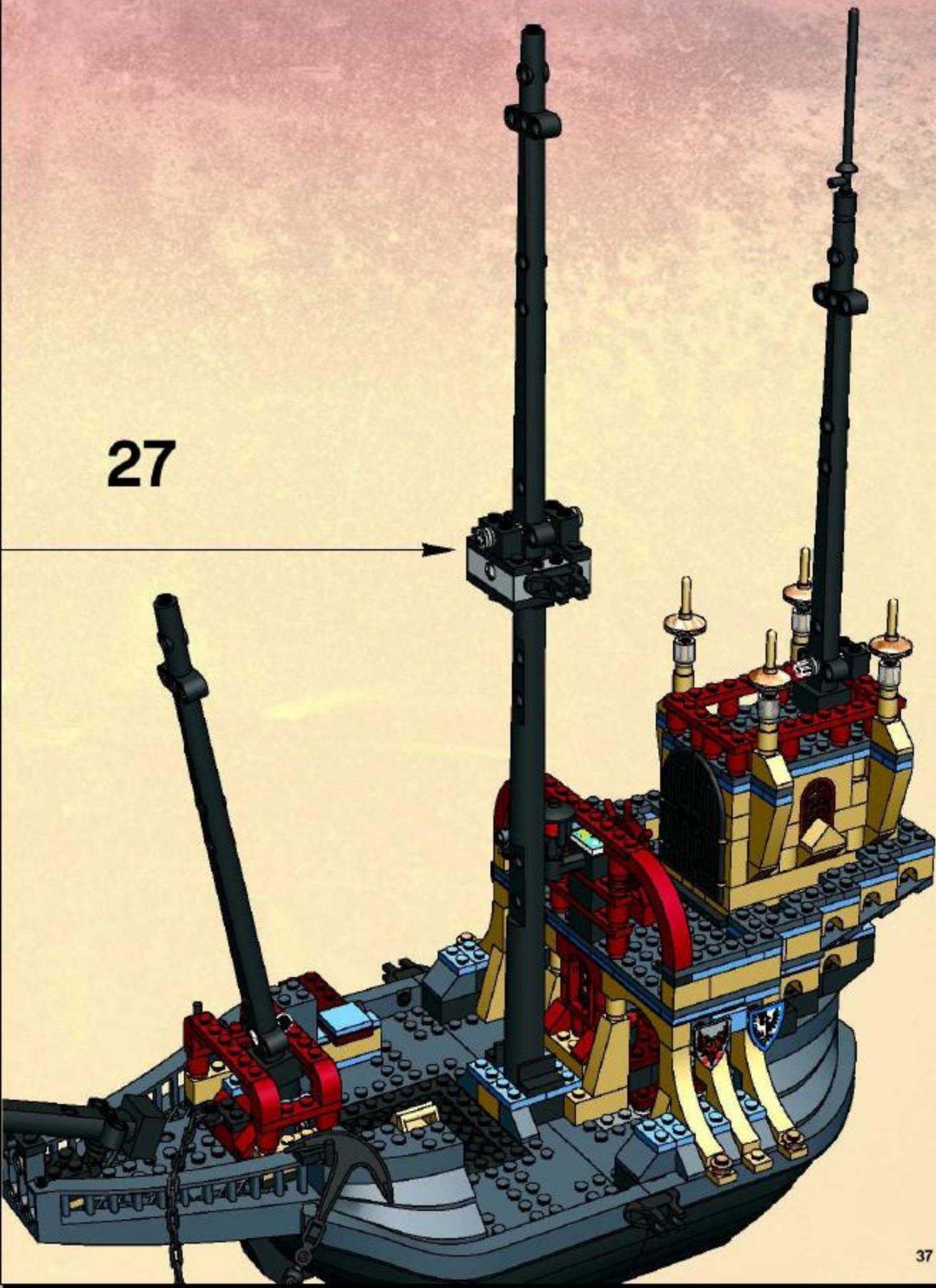

1



2



3

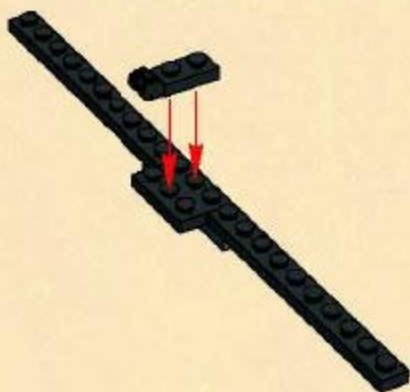

4



5

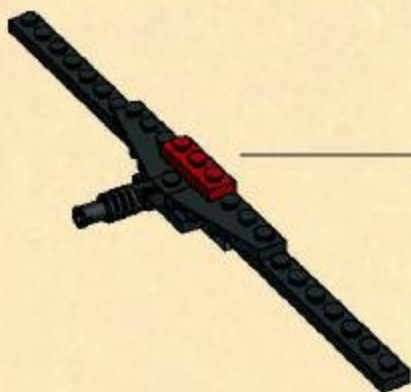

3x



28

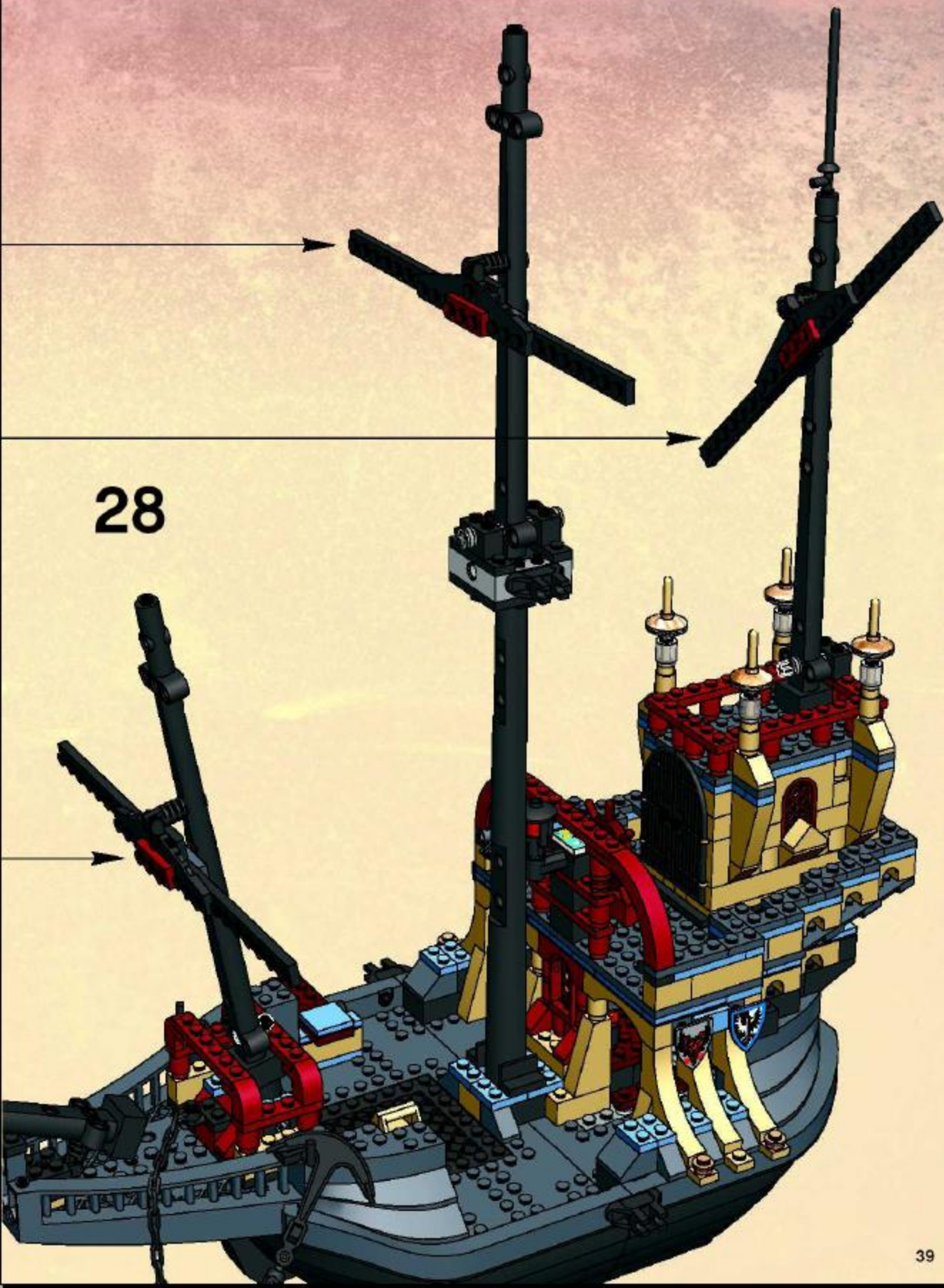

1



2

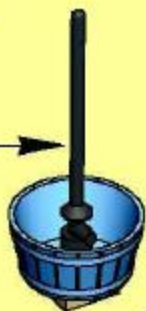

2x

29

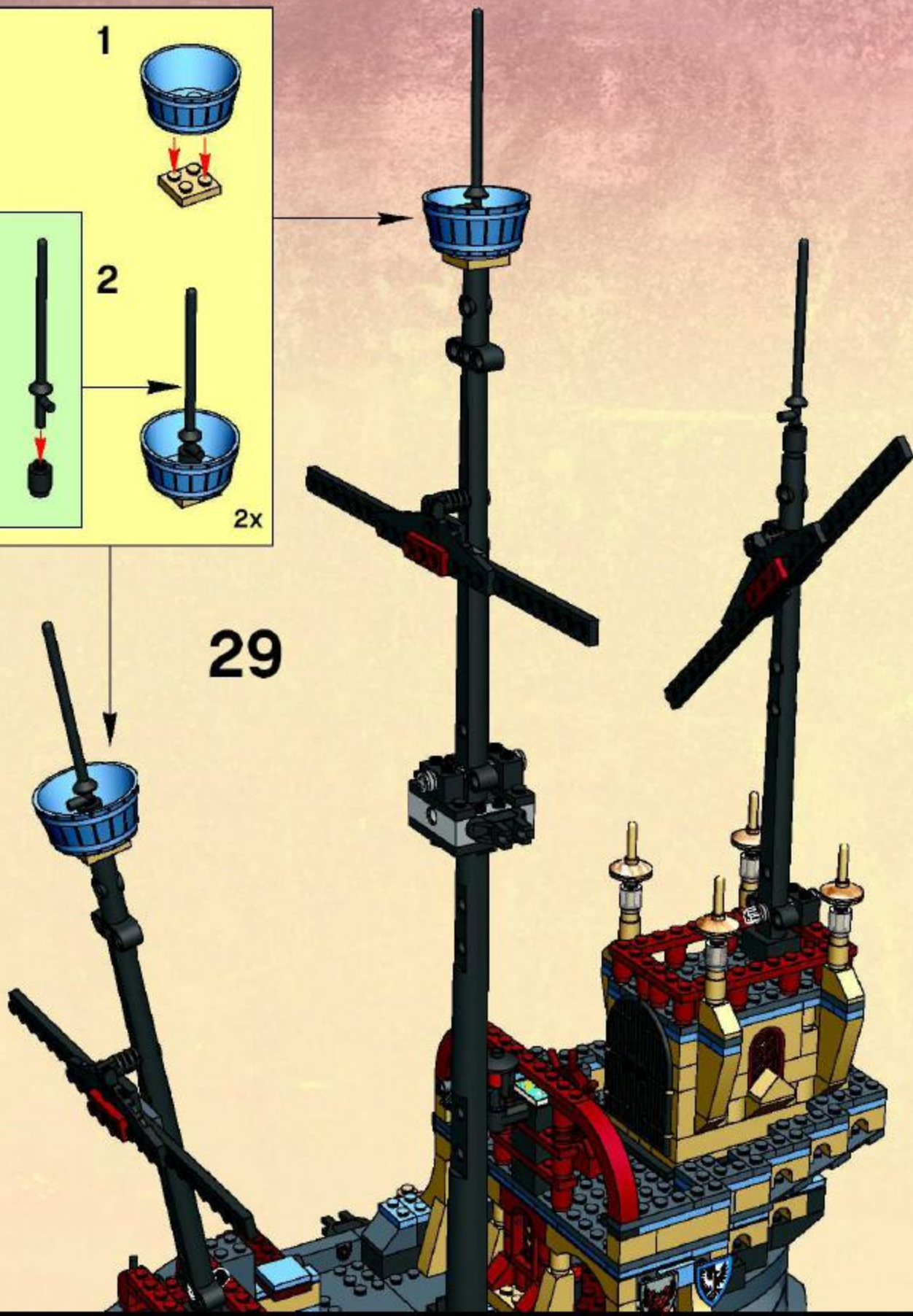



30

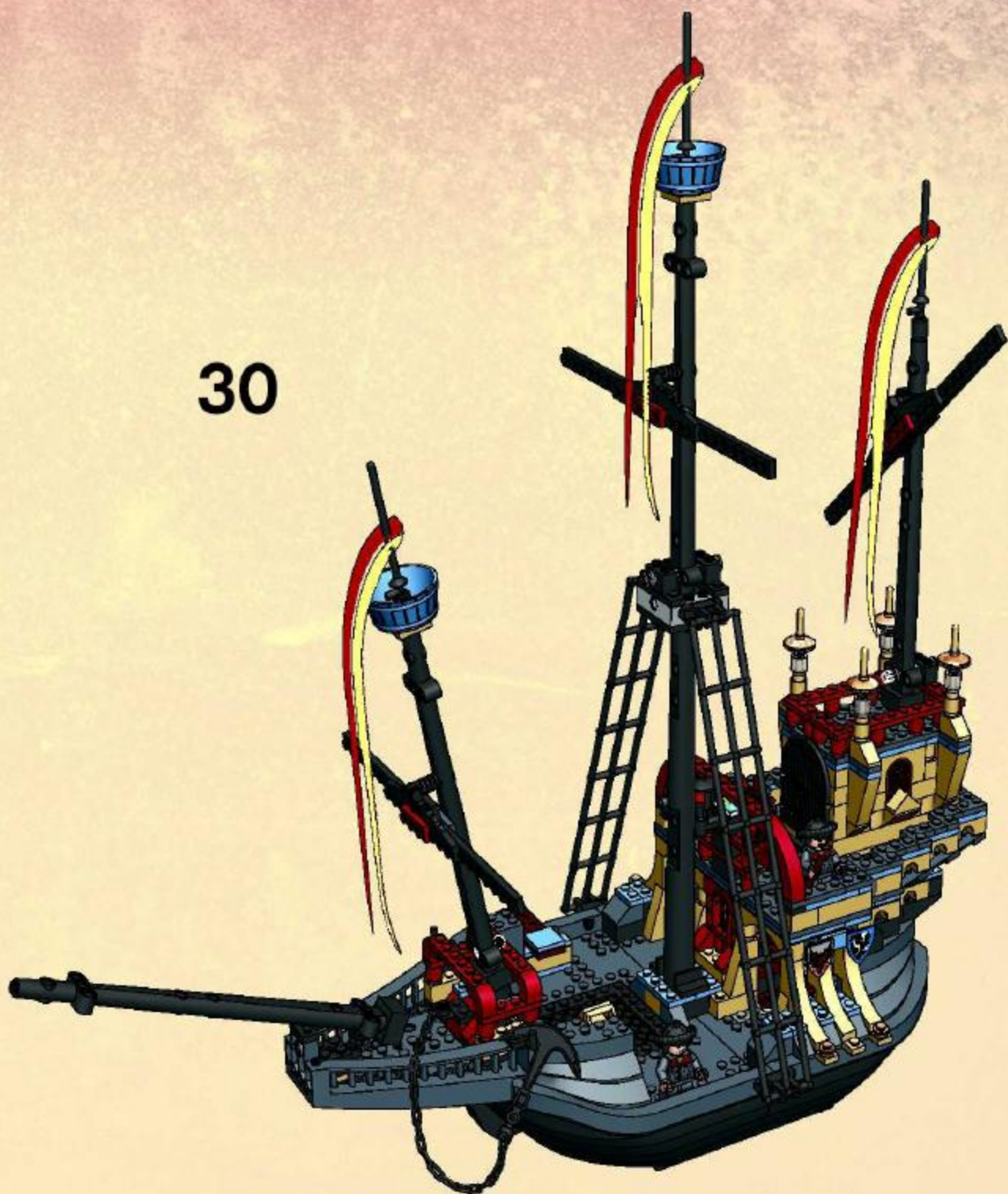

















# Harry Potter



4767

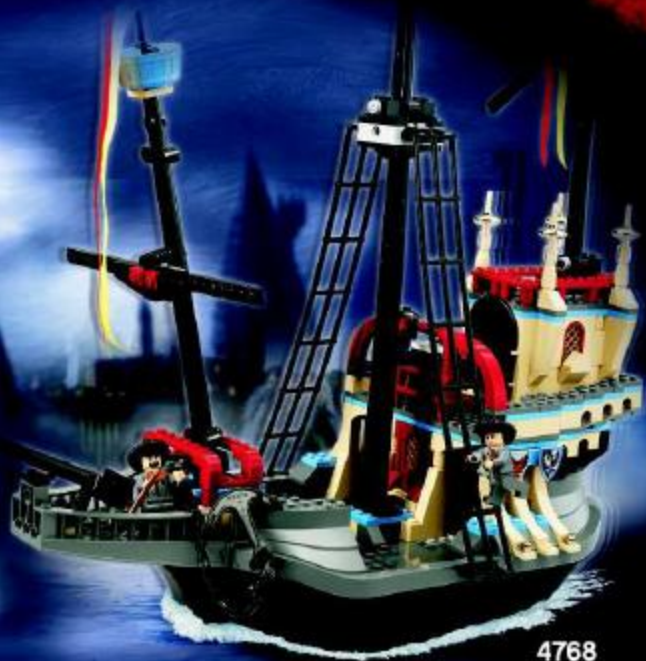

4768



4762



4766



# Discover the LEGO® UNIVERSE!



www.LEGOuniverse.com



**LEGO** SHOP at HOME

The World's Biggest  
LEGO Shop!

English

Deutsch

Francals



**LEGO** club





# Win! Gagne! Gewinne! 当たります



#### WIN LEGO® PRODUCTS

We would like to know what you think about our new LEGO® product. If you could help us by answering a few questions you are in with a chance of winning an exciting LEGO prize. It will only take you about 3 minutes! Log on to the web address below for further instructions.

We would really like to hear what you think about your new LEGO product. If you'd like to help us, go to the web address below for further instructions.



#### GAGNE DES PRODUITS LEGO®

Nous aimerions savoir ce que tu penses de ton nouveau produit LEGO®. Si tu veux bien nous aider en répondant à quelques questions, tu recevras peut-être bientôt un fantastique prix LEGO. Et cela ne te prendra que 3 minutes environ! Tu obtiendras davantage d'informations en visitant le site Internet indiqué ci-dessous.

Nous aimerions savoir ce que tu penses de ton nouveau produit LEGO. Si tu souhaites nous aider, rends-toi à l'adresse Internet ci-dessous où tu trouveras des instructions supplémentaires.



#### Kedves Ifjú LEGO® Vásárló

Ha ellátogatsz a [www.acnielsen.aim.dk/lego](http://www.acnielsen.aim.dk/lego) honlapra és ott angol, francia, német vagy japán nyelven megválaszolod néhány kérdést, akkor részt veszel egy versenyben, amelyben értékes LEGO® díjakat nyerhetsz.



#### GEWINNE LEGO® PRODUKTE

Wir sind sehr an deiner Meinung über dein neues LEGO® Produkt interessiert. Wenn du uns den Gefallen tust und ein paar Fragen beantwortest, kannst du einen tollen LEGO Preis gewinnen. Das Ganze dauert nur etwa 3 Minuten! Gehe einfach zu der unten angegebenen Webadresse - dort findest du weitere Informationen.

Wir möchten gerne wissen, was Sie von Ihrem neuen LEGO Produkt halten. Wenn Sie uns helfen möchten, besuchen Sie bitte die u.a. Website, auf der Sie alles Weitere erfahren.



#### Estimado usuario LEGO®

Al contestar algunas preguntas en inglés, francés, alemán o japonés, en el sitio [www.acnielsen.aim.dk/lego](http://www.acnielsen.aim.dk/lego), podrás participar en el sorteo de algunos valiosos premios LEGO®.



#### Caro Consumidor da LEGO®

Ao responder a algumas perguntas em inglês, francês, Alemão ou Japonês no endereço [www.acnielsen.aim.dk/lego](http://www.acnielsen.aim.dk/lego) irá participar num concurso para ganhar valiosos prémios da LEGO®.



#### 抽選でレゴ®製品が当たります

私たちは、皆さんが興味のあるレゴ®製品についてどんな感想をお持ちか、知りたいと思っています。質問に答えて、楽しいレゴ®製品の抽選にも参加させたい。アンケートの回答には、自分の9分ほどこしかかりません！詳しくは、以下のウェブアドレスまでアクセスしてください。



## [www.acnielsen.aim.dk/LEGO](http://www.acnielsen.aim.dk/LEGO)







# Harry Potter

4283892

©2005 The LEGO Group



HARRY POTTER, characters, names and related indicia are trademarks of and © Warner Bros. Entertainment Inc. Harry Potter Publishing Rights © JKR 2005

WB SHIELD, TM & © Warner Bros. Entertainment Inc.

[www.harrypotter.com](http://www.harrypotter.com)

 [www.LEGO.com](http://www.LEGO.com)