

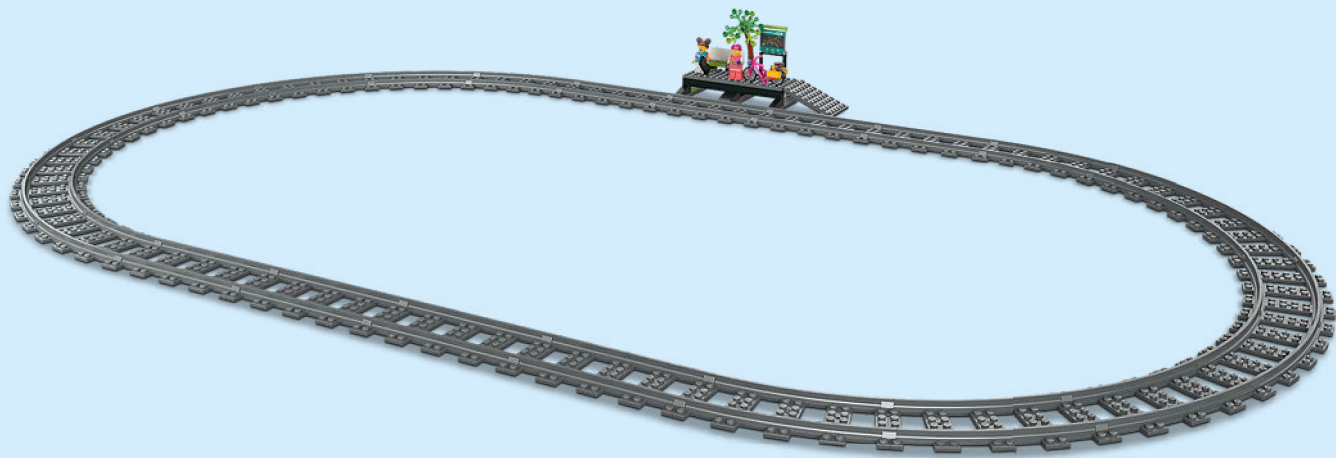

CITY

60337



1



LEGO.com/sustainable-packaging



FR
DONNEZ
OU
RECYCLEZ



OU



OU



ASSOCIATION

MAGASIN

DÉCHÈTERIE

Adresses sur quefairedemesdechets.fr



乐高® 拼搭指引

Check for compatibility
 Kompatibilität prüfen
 Vérifier la compatibilité
 Controlla la compatibilità
 Comprueba tu compatibilidad
 Verificar a compatibilitade
 Ellenőrizd a kompatibilitást
 Pārbaudīt saderību
 Verificarea compatibilității
 检查兼容性

[LEGO.com/devicecheck](https://www.lego.com/devicecheck)



LEGO® Building Instructions



Apple and the Apple logo are trademarks of Apple Inc.
 Google Play and the Google Play logo are trademarks of Google LLC.
 Tencent and the Tencent logo are trademarks of Tencent Inc.



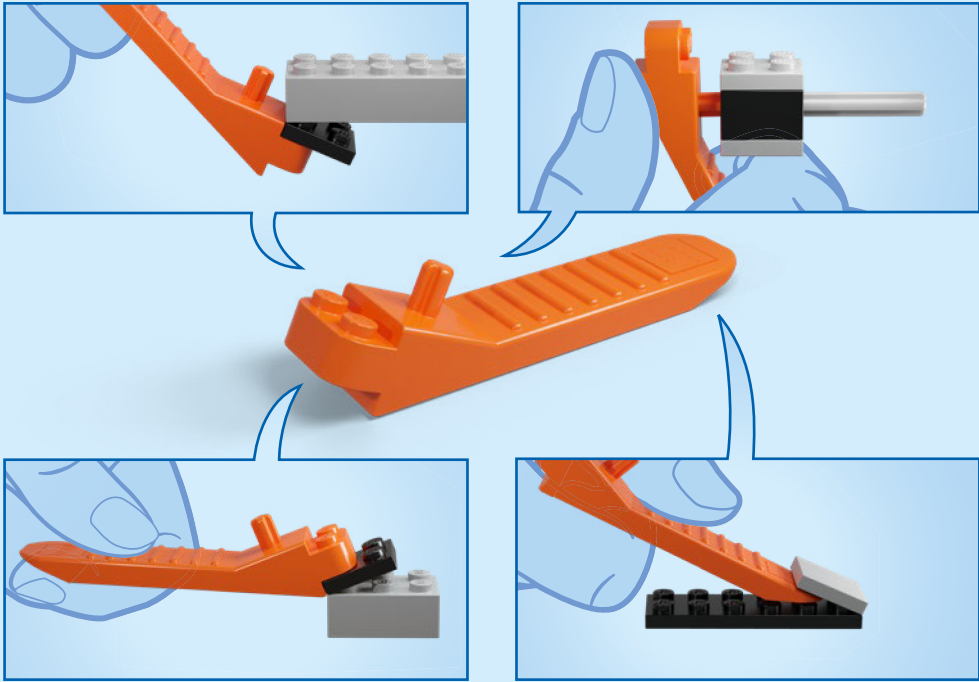

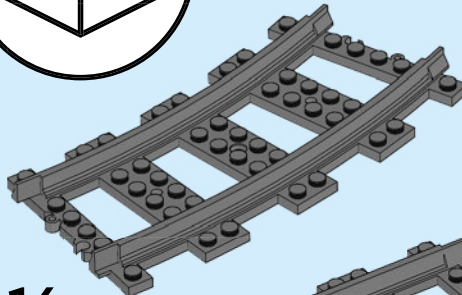
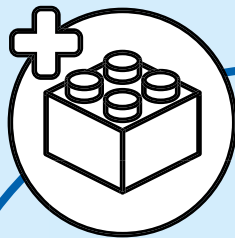

16x

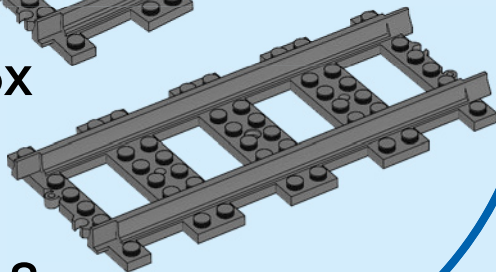

8x

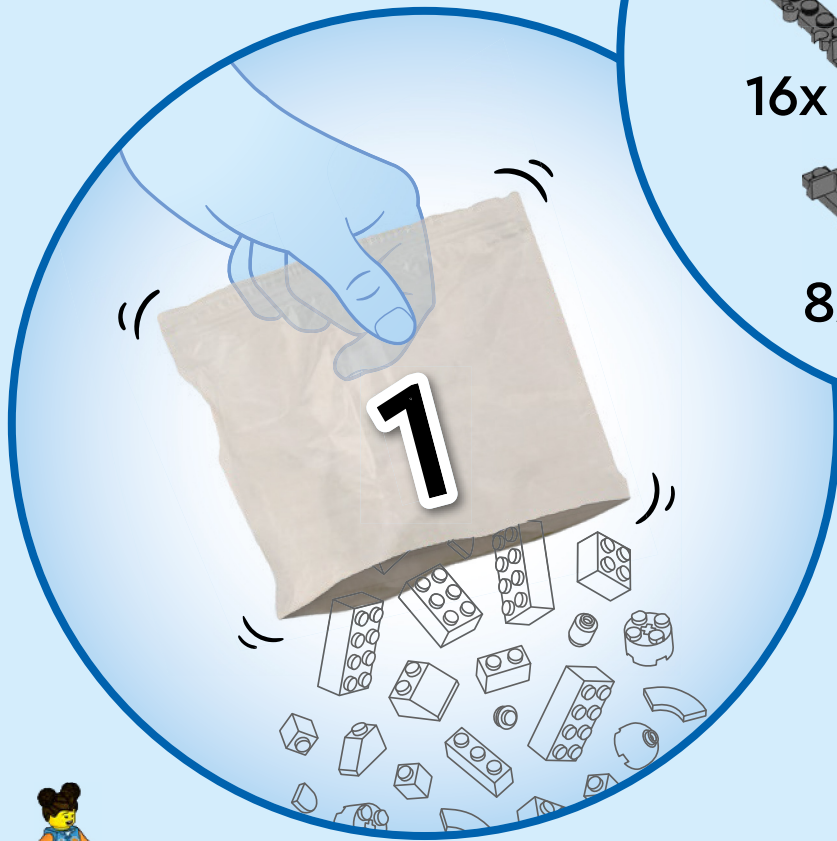

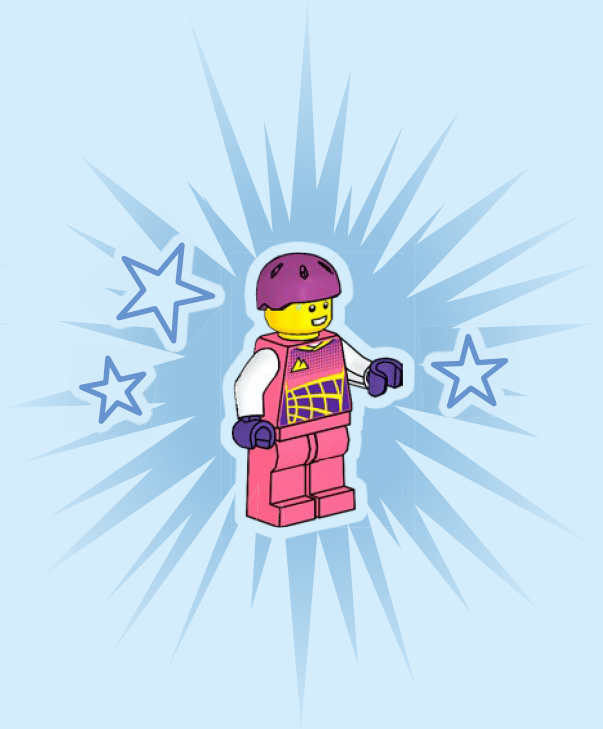
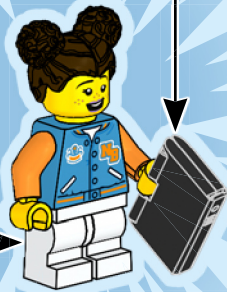
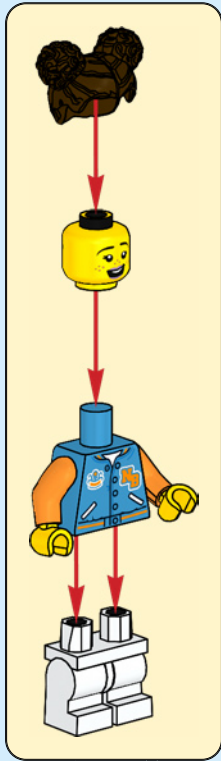

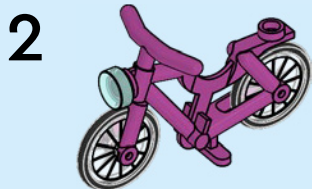
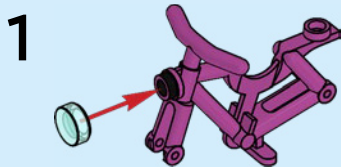
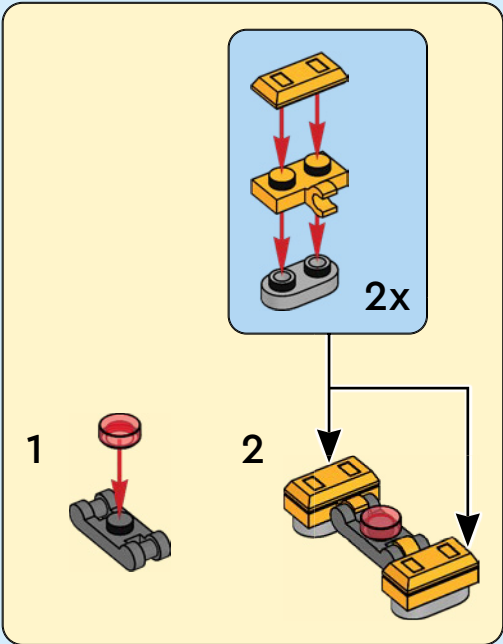

4

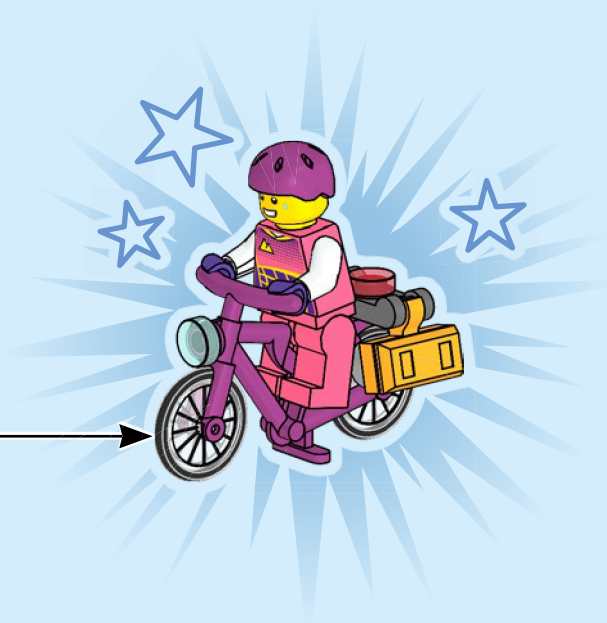
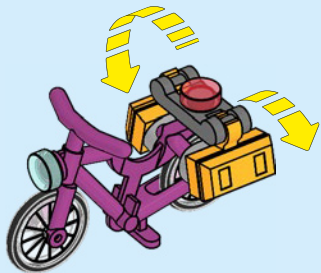

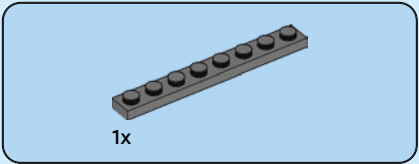

1

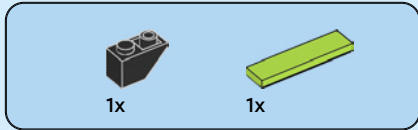
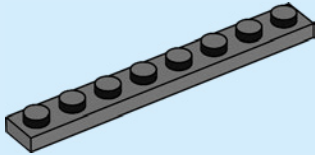

2

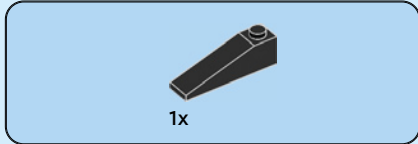
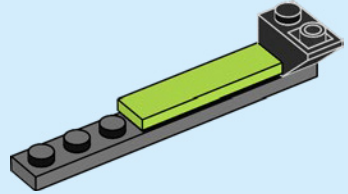

3

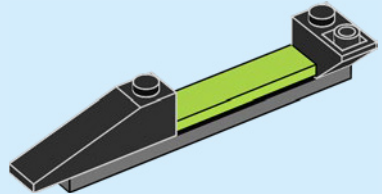

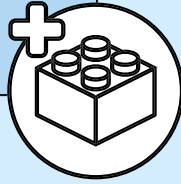
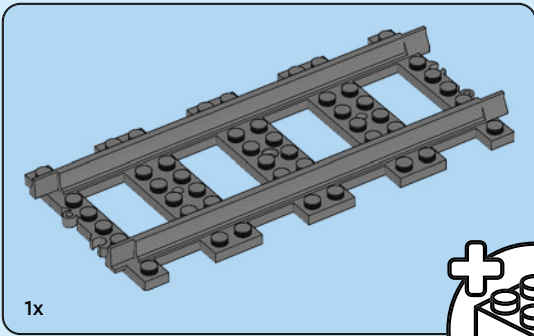

4

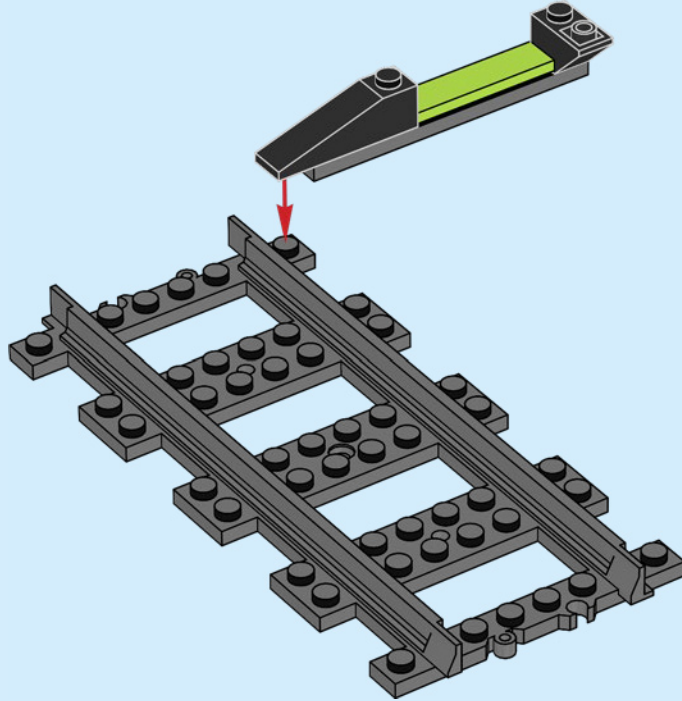

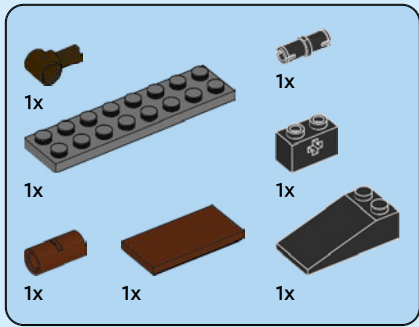

5

1

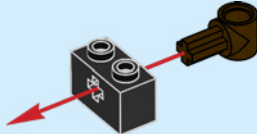

2

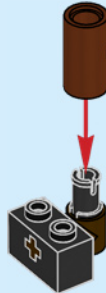

3

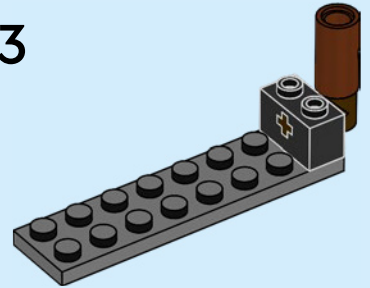

4

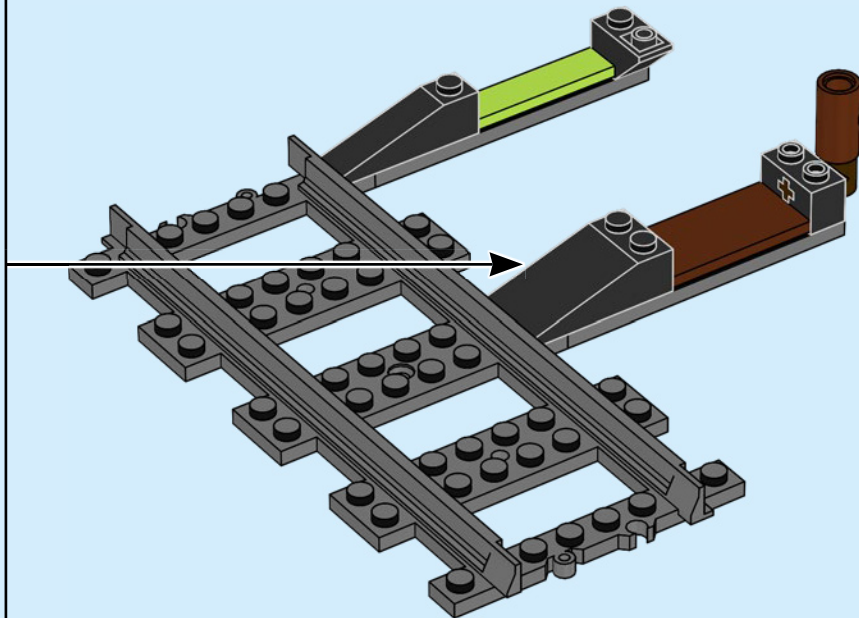
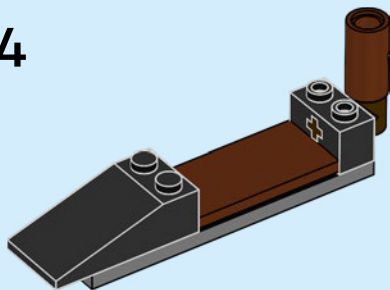

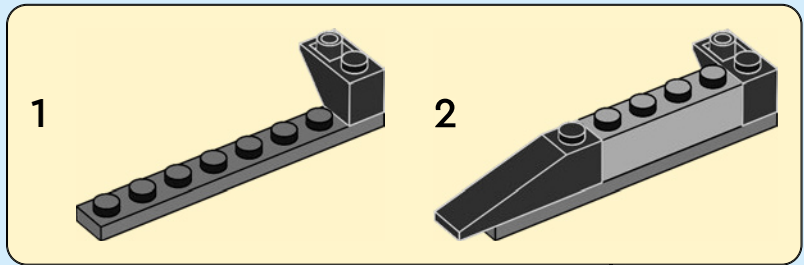
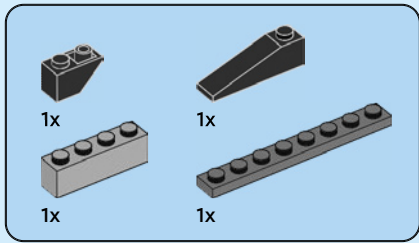

6

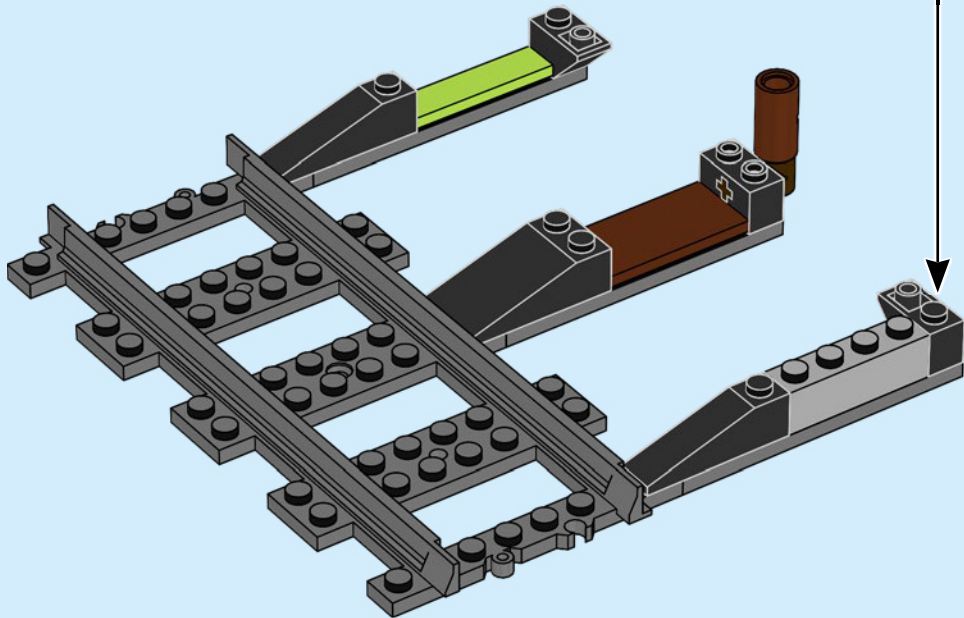

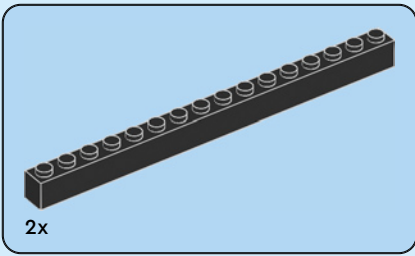

7

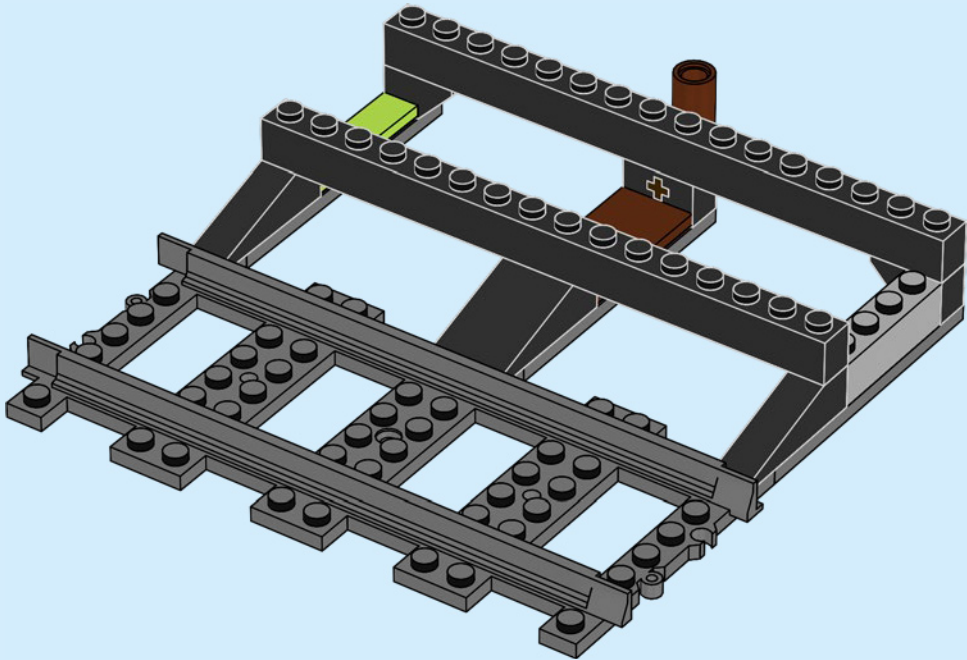



2x

8

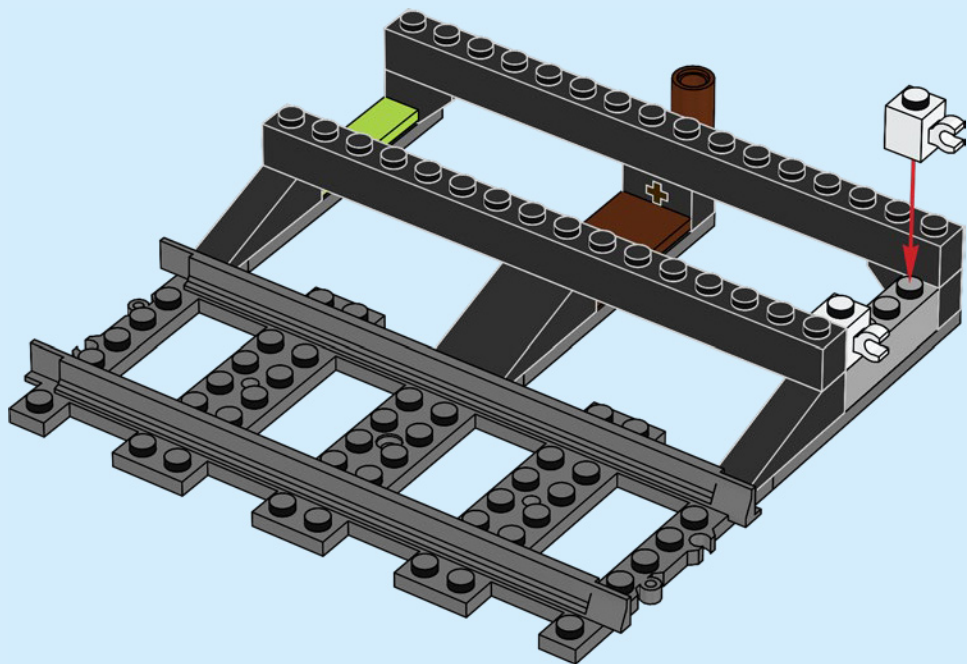

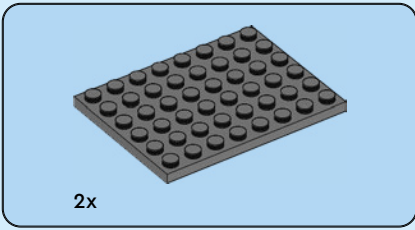

9

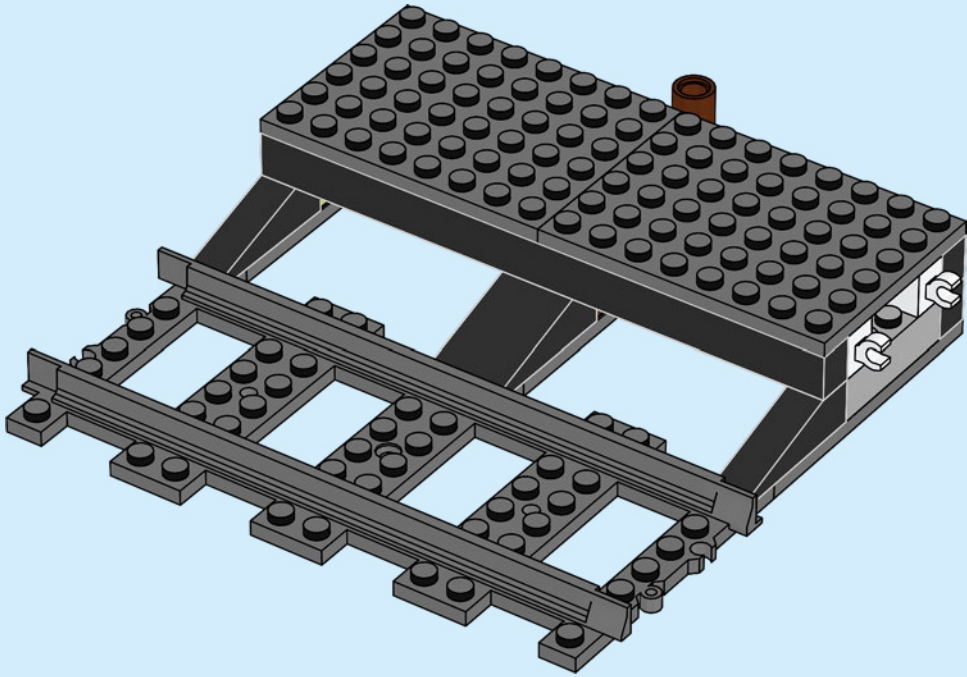

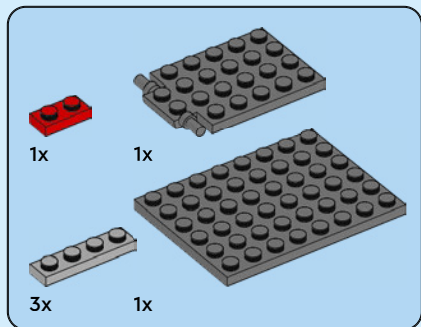

10

1

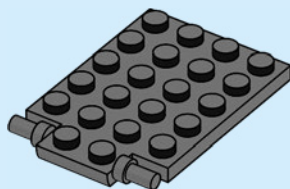

2

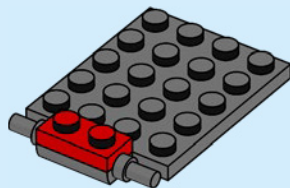

3

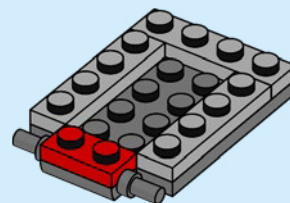

4

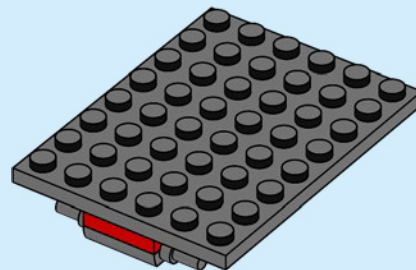

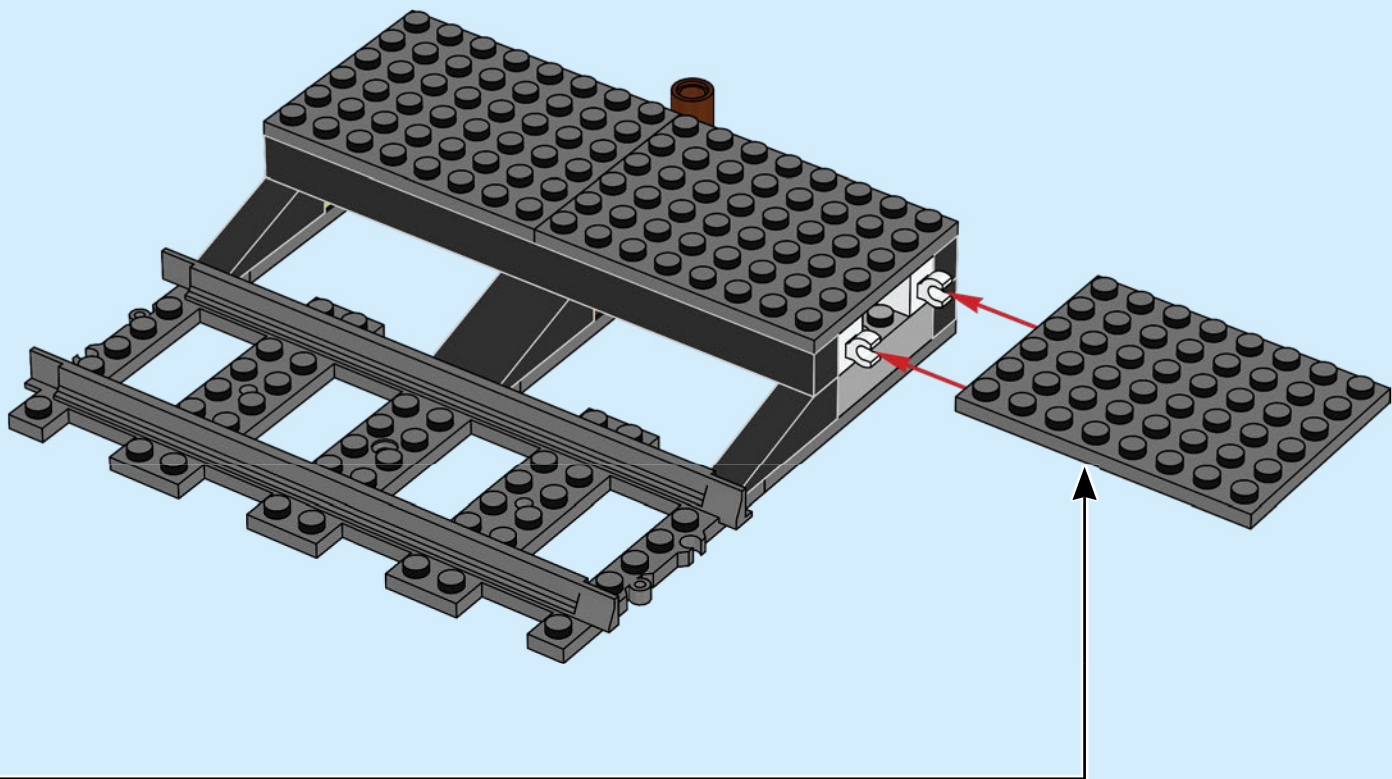

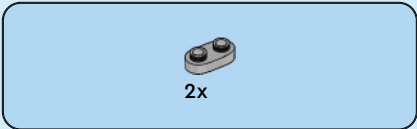

11

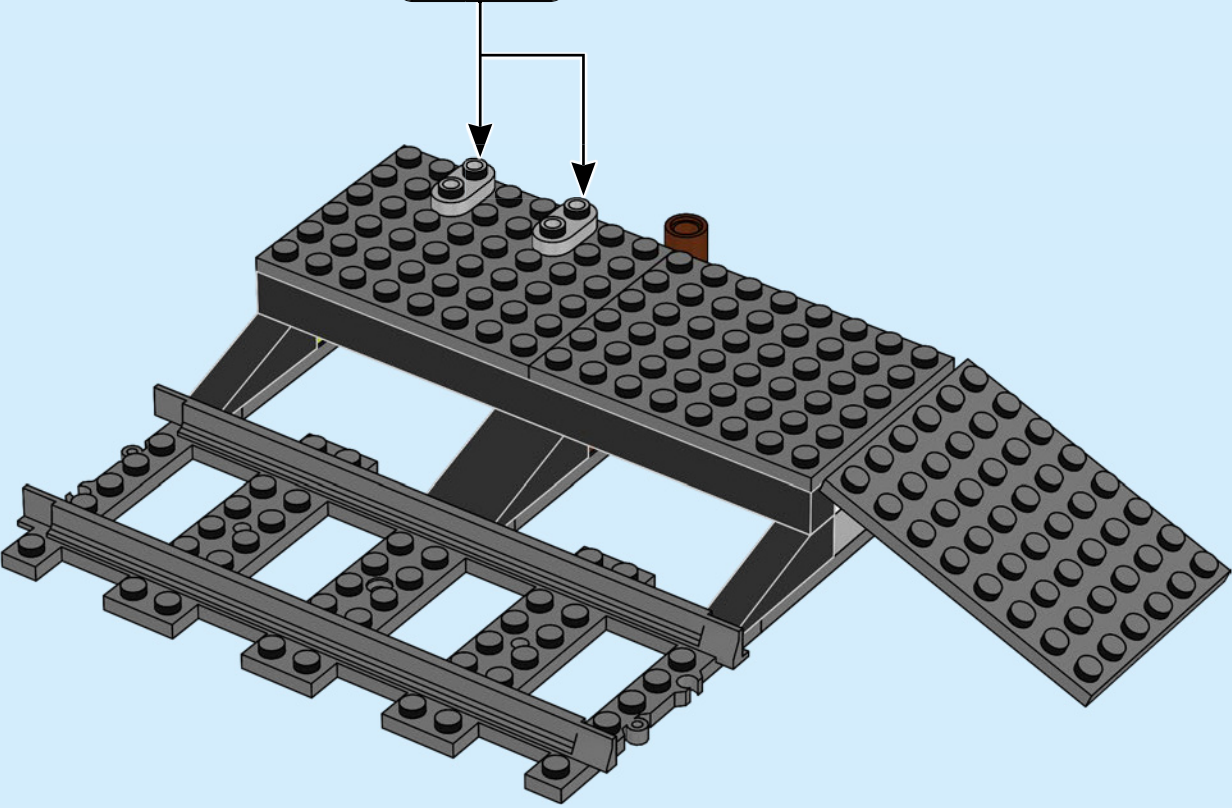
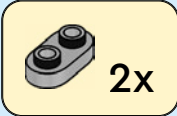



2x

12

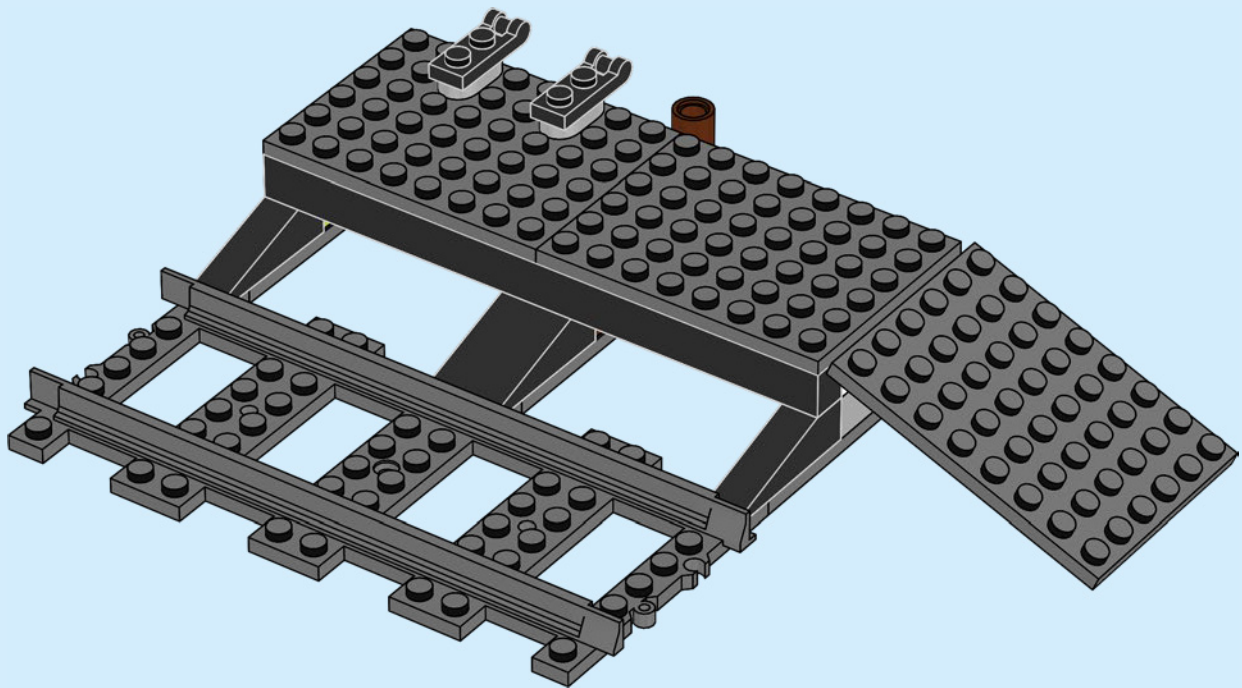

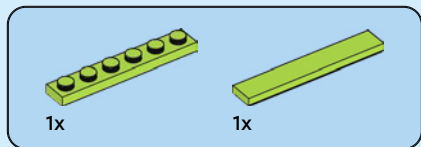

13

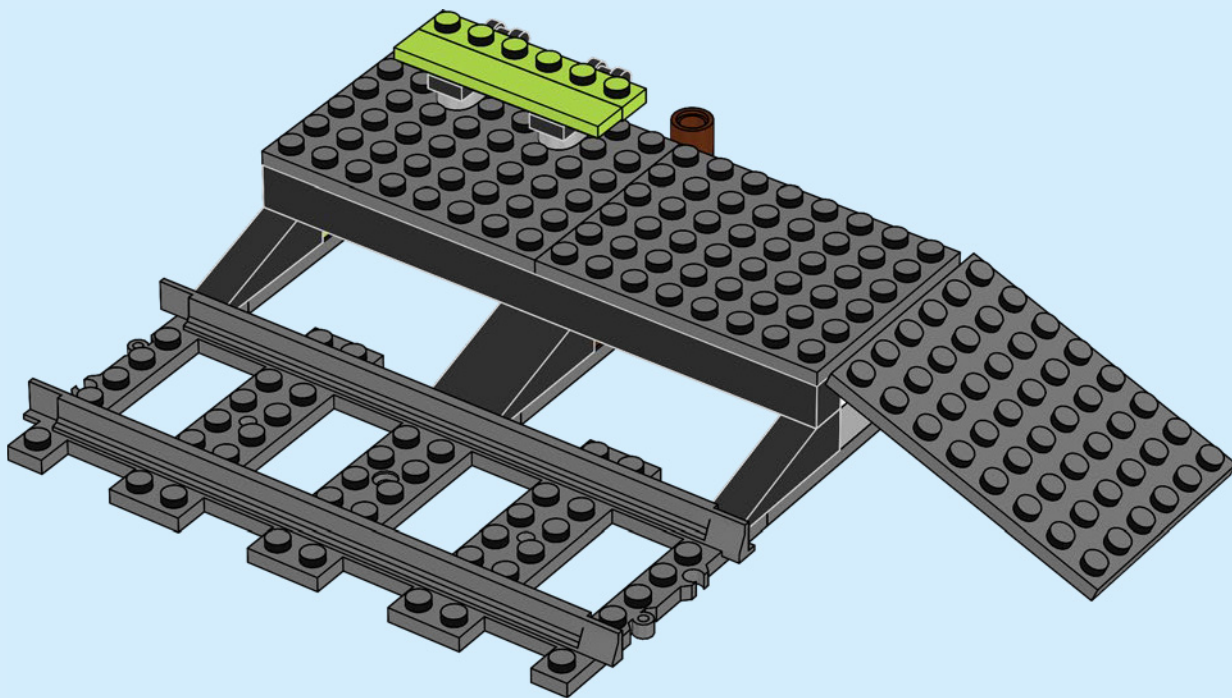

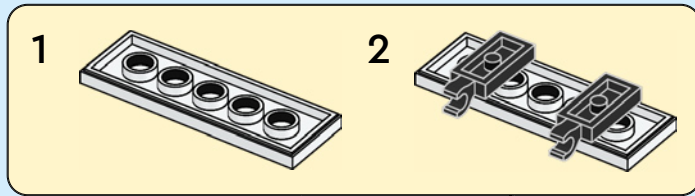
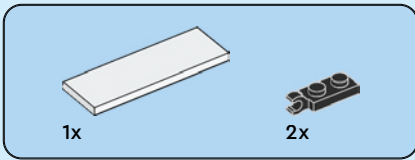

14

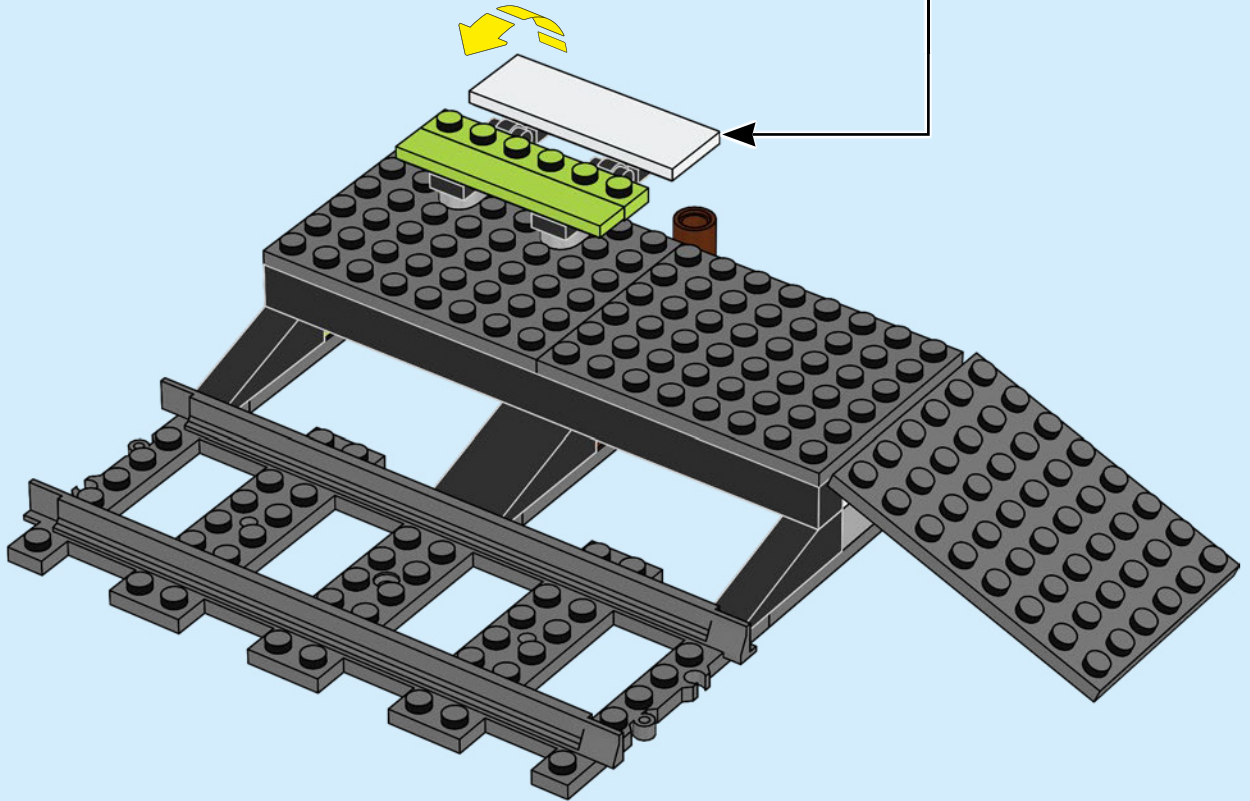

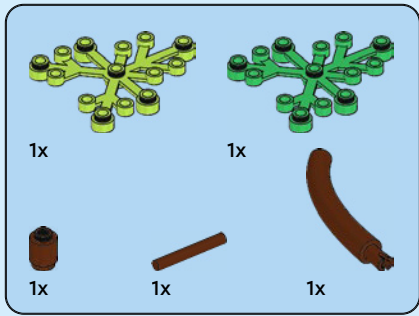

15

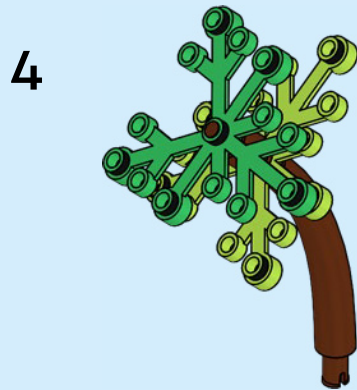
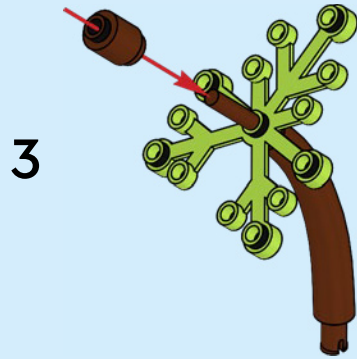
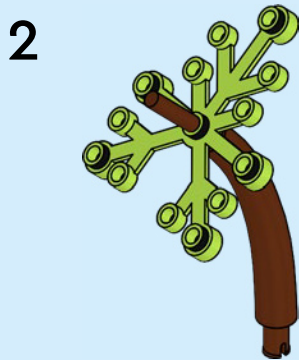
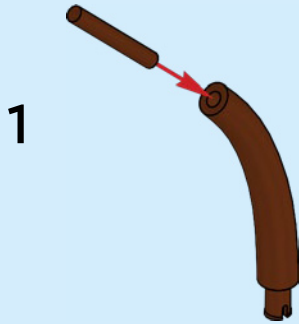

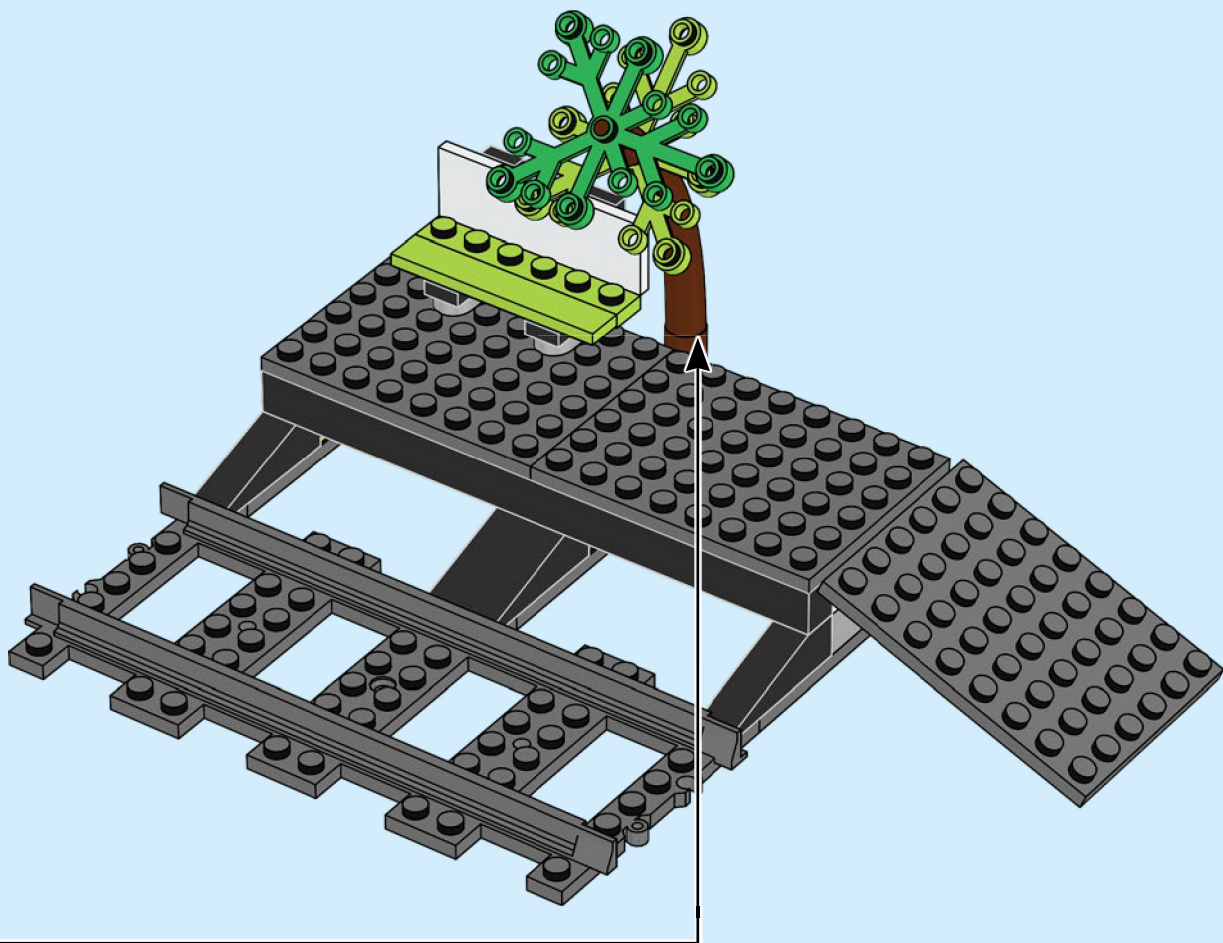

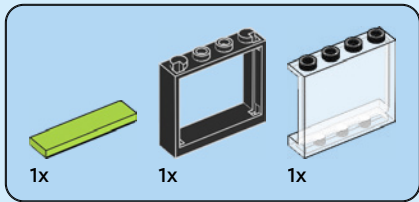

16

1

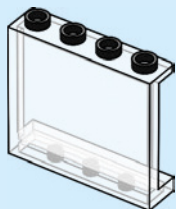

2

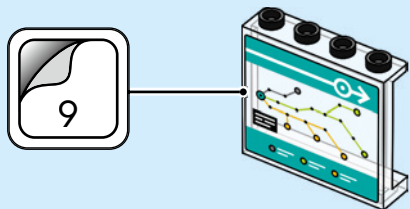

3



4



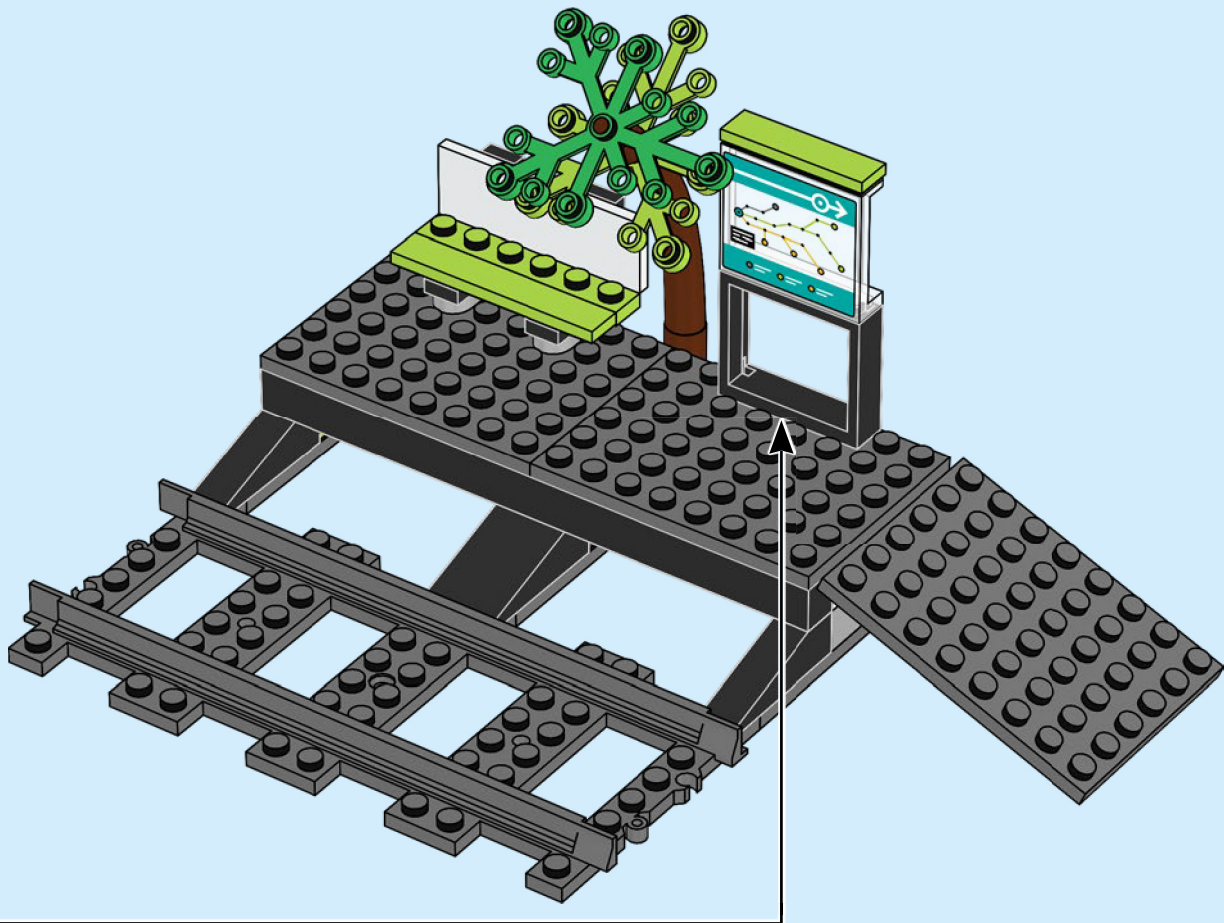

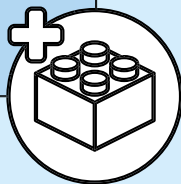
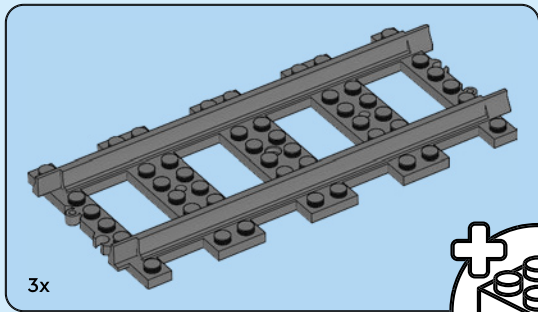

17



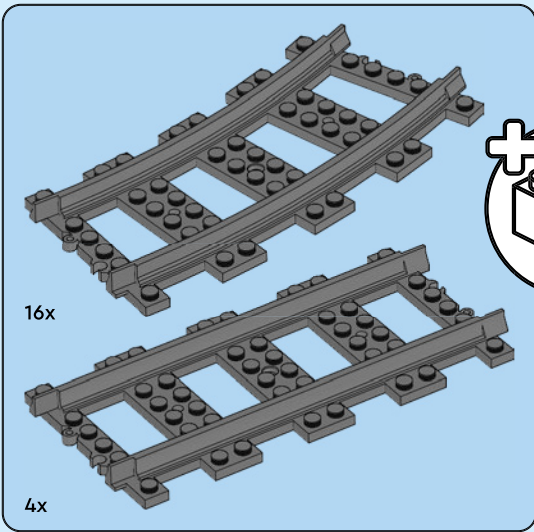

18

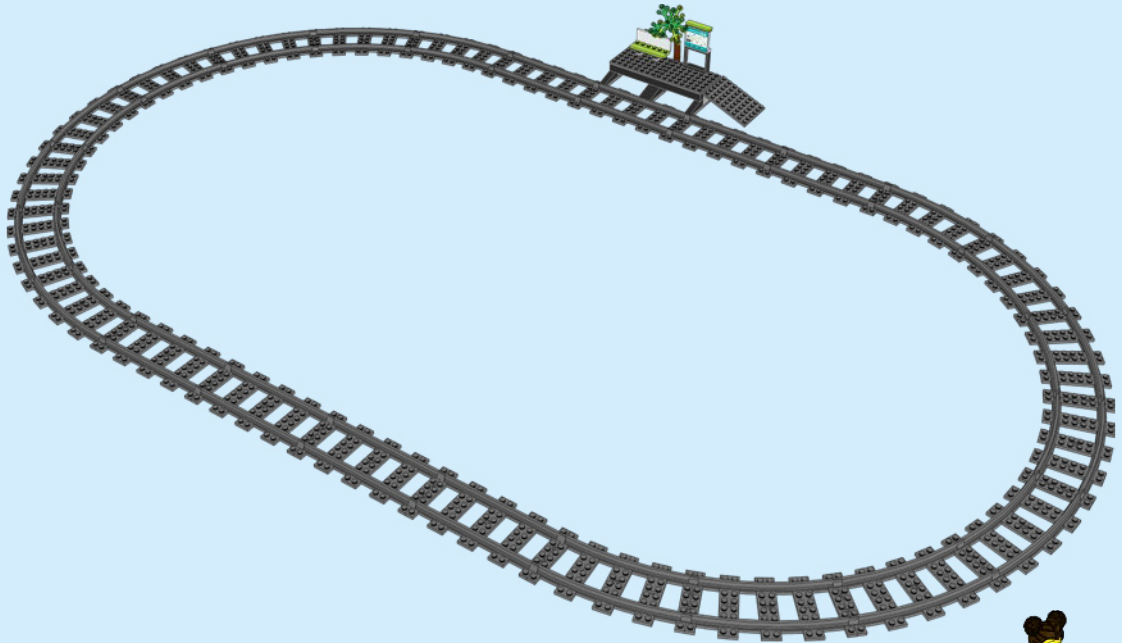

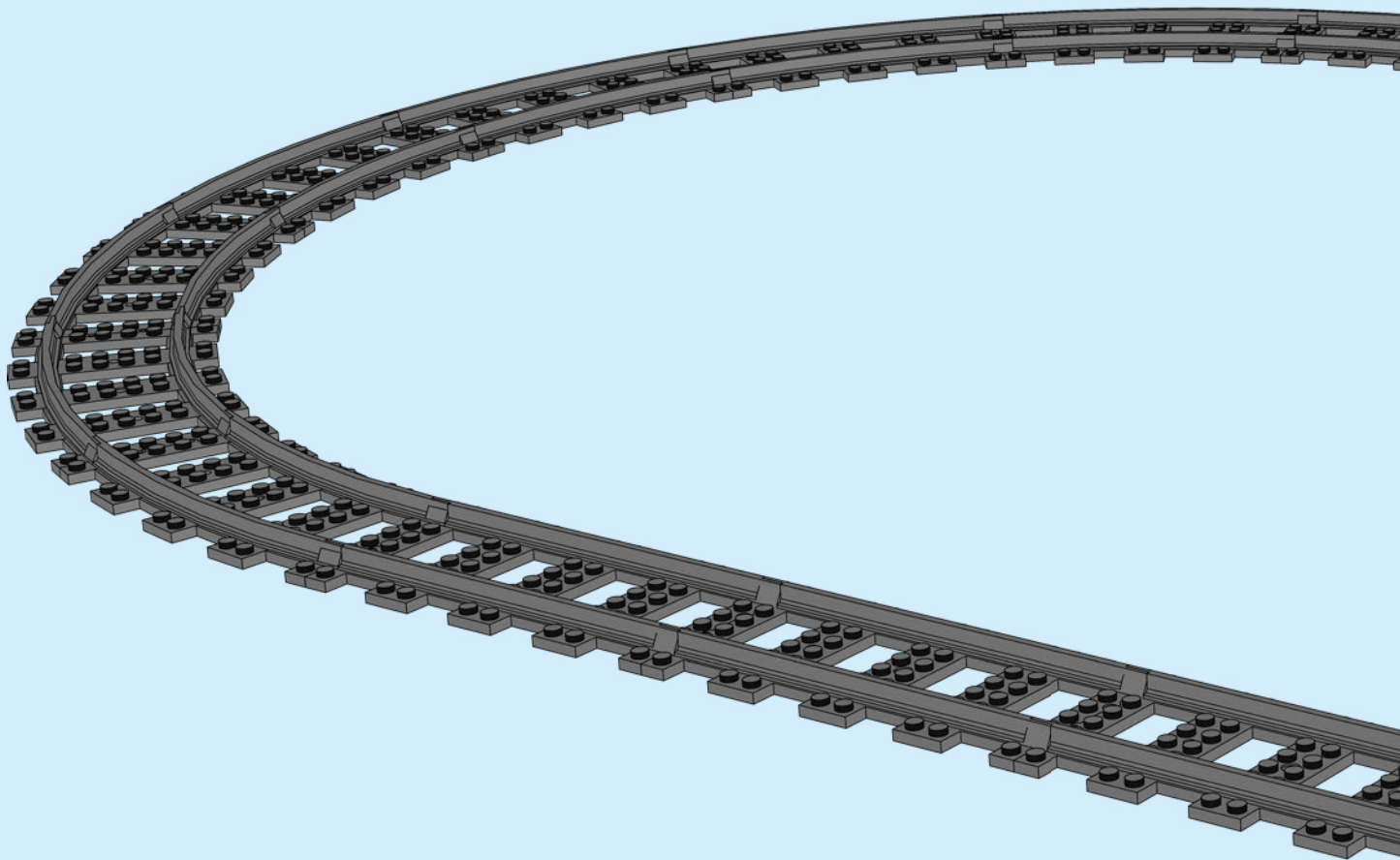

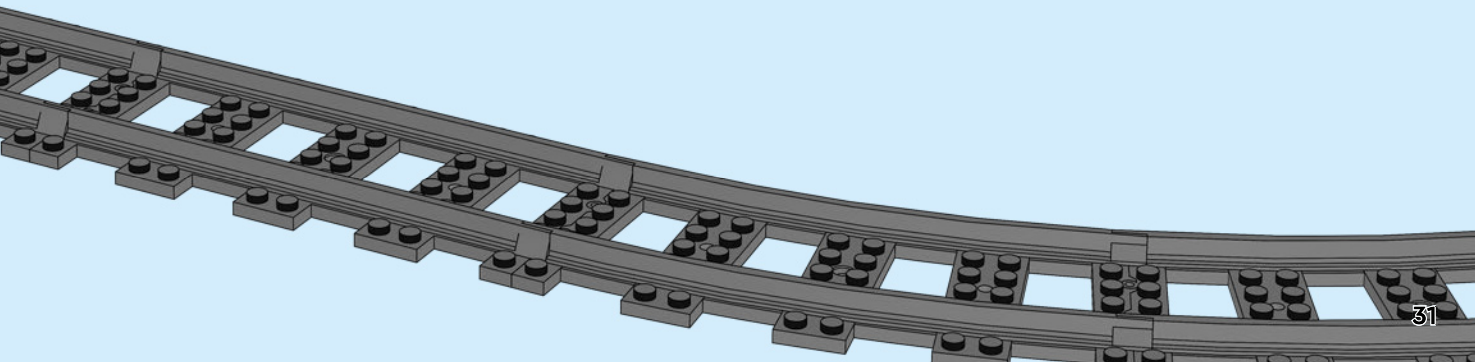



2x
6052312



8x
302401



4x
6170567



2x
6320310



2x
6294351



1x
6284507



8x
366501



1x
6051511



9x
300401



1x
6329697



10x
6137926



1x
300301



1x
6313138



1x
6329582



1x
434501



4x
6158058



1x
6270843



2x
301001



2x
4160387



1x
6332042



2x
300801

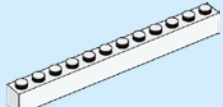

10x
611201



1x
6147214



1x
6093519



1x
4159279



1x
4185177



3x
4114306



1x
4107623



2x
4550324

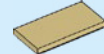

1x
6122047



3x
4114319

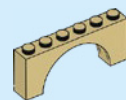

2x
6106187



2x
614121



6x
6170390



1x
6144805



6x
6210269



1x
403221



1x
6266205



1x
302321



2x
6219819



1x
6152679



2x
371021



5x
379521



5x
6181720



2x
654126



2x
6196548



5x
6181713



1x
6279875



4x
4548180



4x
6284110



3x
6336989



8x
4620763

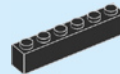

1x
300926



1x
4278359



1x
9339



2x
4614788



2x
6047276



2x
366526



26x
241226



1x
6178922



30x
4584274



1x
6310268



20x
6253473



4x
6214807



1x
4558957



1x
6087083



2x
4560182



5x
302026



1x
4185583



1x
4188534



5x
6179660



2x
370626



5x
6172149

6



1x
6211476



2x
4565323



2x
4515368



2x
6038531



1x
6268856



1x
6207258



1x
329826



1x
4530589



2x
4515362



1x
6254519



4x
6391342

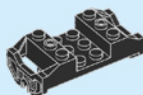

10x
6253474

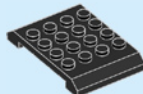

19x
6392874

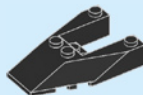

2x
6048746

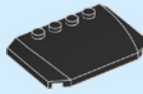

1x
4542671

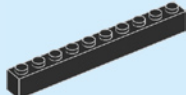

8x
611126



2x
6256101

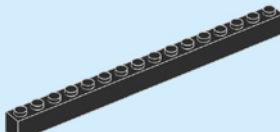

2x
246526

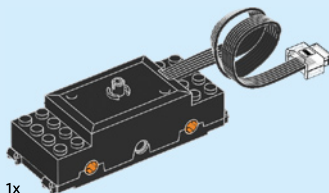

1x
6214559

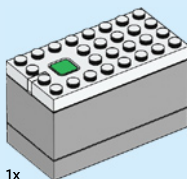

1x
6370369

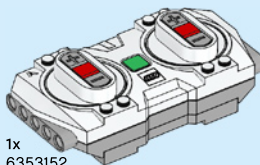

1x
6353152



1x
6145779



1x
6270417



1x
6124264



1x
6384051



1x
6306824



1x
6153335



1x
6211710



3x
302024

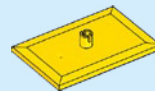

5x
6413626



2x
6163986



1x
6247357



1x
6244904



2x
6246888



1x
6245269



8x
306223



6x
614123



5x
302223



7x
407923



2x
362223



1x
6400763

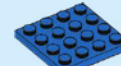

1x
4243815

1x
6258607

6x
6240212

1x
6274739

2x
6373578

1x
6329699

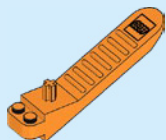

1x
6240515



8x
6392875



7x
6248102



5x
6245264

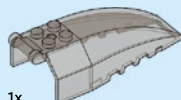

1x
6254293

8x
4183133

12x
6228995

8x
4164022

4x
6247209

3x
4537937

2x
4210210

2x
4164021

6x
6299442

6x
6212989

1x
6167465

2x
6392866

2x
6139693

2x
4529160

3x
4537919

1x
6328137

4x
6392872

16x
6392869

2x
6392867

3x
4210794

1x
6398324

1x
6031896

1x
4595710

1x
4210997

2x
4210998

4x
4210783

8x
6070018

16x
4279717

4x
6334384

1x
4594847



8x
4211135



8x
4211088



1x
6352600

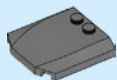

1x
4210940



2x
4211098



8x
4211133



1x
6303099



1x
6350705



1x
6138657



1x
6399256



1x
4162916



1x
4558593



1x
6266968



1x
6334178



2x
6334175



1x
6388304



1x
6275092



1x
6356563



1x
6400045



1x
6400762



1x
6400050



1x
6400053



50x
6253217



1x
6333518



1x
6134197



2x
6236454



2x
6384219



1x
6173132



1x
4211183



1x
6075208



1x
4579690



1x
4221886



1x
6194410



1x
6326087



2x
4211429



3x
4211445



2x
4211450



6x
6093859



4x
6102357



9x
6257593



1x
6171894



10x
6186657



9x
6212077



4x
6248890



14x
4211398



12x
4568637



1x
6028324



2x
6265742



3x
4211396



1x
6267048



1x
4612621



2x
6171067



1x
6297209



1x
4211350



3x
4211568



1x
4211394



5x
4211795



12x
4211481

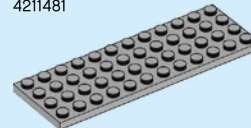

2x
4211401

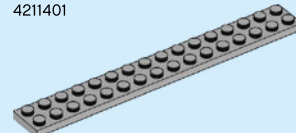

2x
4211486

Customer Service
 Kundenservice
 Service Client
 Assistenza clienti
 Atención al cliente
 Serviço de Apoio ao Consumidor
 Ügyfélszolgálat
 Klientu apkalpošanas dienests
 Serviciul pentru clienț
 客户服务
 コンシューマーサービス
 고객 서비스
LEGO.com/service

WIN

Terms & Conditions apply

Scan this QR code or go to **LEGO.COM/PRODUCTFEEDBACK** and give us your short feedback about this LEGO® set for a chance to win a cool LEGO prize.



GEWINNE

Scanne diesen QR-Code oder geh auf LEGO.COM/PRODUCTFEEDBACK

und gib uns dein kurzes Feedback zu diesem LEGO® Set. Dann hast du die Chance, einen coolen LEGO Preis zu gewinnen.

Es gelten die Teilnahmebedingungen

GAGNE

Scannez ce code QR ou rendez-vous sur LEGO.COM/PRODUCTFEEDBACK

pour donner votre avis sur ce produit LEGO® et avoir une chance de gagner un prix LEGO.

Voir Conditions Générales

GANAN

Escanea este código QR o visita LEGO.COM/PRODUCTFEEDBACK

y comparte con nosotros tu opinión sobre este set LEGO® para tener la oportunidad de ganar un fantástico premio LEGO.

Términos y Condiciones aplicables

获取奖品

只需扫描此二维码或访问 LEGO.COM/PRODUCTFEEDBACK,

就这款乐高®套装提供简短反馈, 就有机会赢得很酷的乐高奖品。

《条款及条件》适用

LEGO and the LEGO logo are trademarks of the LEGO Group. ©2022 The LEGO Group.

The Bluetooth® word mark and logos are registered trademarks owned by Bluetooth SIG, Inc. and any use of such marks by the LEGO Group is under license. Other trademarks and trade names are those of their respective owners.



CITY

60337



2

3



EN

Important information about batteries

Never use different types of batteries together, or a combination of old and new batteries. Always remove the batteries if the product is not to be used for a long time or if the batteries have run down. Never use damaged batteries. Only use alkaline type batteries. Insert the batteries so that the poles are correctly positioned. Never attempt to recharge non-rechargeable batteries. Never short-circuit the battery holder.

DE

Wichtige Informationen zu Batterien

Benutzen Sie niemals unterschiedliche Arten von Batterien oder alte und neue gleichzeitig. Nehmen Sie stets die Batterien heraus, wenn mit dem Modell längere Zeit nicht gespielt wird oder wenn die Batterien leer sind. Verwenden Sie niemals beschädigte Batterien. Verwenden Sie ausschließlich Alkali-Batterien. Achten Sie beim Einsetzen der Batterien auf die richtige Polung. Versuchen Sie unter keinen Umständen, „normale“ Batterien wieder aufzuladen. Schließen Sie das Batteriefach niemals kurz.

FR

Informations importantes concernant les piles

Ne jamais utiliser un mélange de différents types de piles, ou de piles neuves et de piles anciennes ou déjà utilisées. Toujours retirer les piles si le produit n'est pas utilisé durant une période prolongée ou si les piles sont vides. Ne jamais utiliser de piles endommagées. N'utiliser que des piles alcalines. En insérant les piles, respecter scrupuleusement le sens d'orientation des pôles (+/-). Ne jamais essayer de recharger des piles non rechargeables. Ne jamais court-circuiter le compartiment des piles.

IT

Importanti informazioni sulle batterie

Non usare mai contemporaneamente batterie di tipo diverso o batterie nuove e usate insieme. Rimuovere sempre le batterie qualora il prodotto non venga utilizzato per periodi prolungati, oppure se le batterie sono esauste. Non utilizzare mai batterie danneggiate. Utilizzare solo batterie di tipo alcalino. Inserire le batterie avendo cura che la loro polarità sia corretta. Non tentare mai di ricaricare batterie non ricaricabili. Non cortocircuitare mai il portabatterie.

NL

Belangrijke informatie over batterijen

Gebruik nooit verschillende soorten of een combinatie van oude en nieuwe batterijen tegelijkertijd. Verwijder de batterijen altijd als je het product lange tijd niet wilt gebruiken of als batterijen leeg zijn. Gebruik nooit beschadigde batterijen. Gebruik alleen alkalinebatterijen. Plaats de batterijen met de polen in de juiste richting. Probeer nooit niet-oplaadbare batterijen opnieuw op te laden. Laat de batterijhouder nooit kortsluiten.

ES

Información importante acerca de las pilas

No use pilas de diferentes tipos ni pilas nuevas y antiguas para alimentar el producto. Extraiga las pilas del producto si este va a permanecer sin uso durante un período prolongado de tiempo o aquellas se han agotado. No use pilas dañadas. Use solo pilas alcalinas. Inserte las pilas de modo que los polos queden situados en las posiciones correctas. No trate de cargar pilas no recargables. No cortocircuite el compartimento de las pilas.

DA

Vigtige oplysninger om batterier

Brug aldrig forskellige batterityper sammen eller en kombination af gamle og nye batterier. Fjern altid batterierne, hvis produktet ikke skal bruges i lang tid, eller hvis batterierne er flade. Brug aldrig beskadigede batterier. Brug kun alkaliske batterier. Sæt batterierne i, så polerne vender den rigtige vej. Forsøg aldrig at oplade ikke-genopladelige batterier. Kortslut aldrig batteriholderen.

IS

Mikilvægar upplýsingar um rafhlöður

Aldrei skal nota mismunandi gerðir rafhlaðna samtímis, né nýjar og eldri rafhlöður samtímis. Ef ekki á að nota tækið í lengri tíma eða ef rafhlöðurnar eru orðnar tómar skal fjarlægja rafhlöðurnar. Aldrei skal nota rafhlöður sem hafa skemmt. Eingöngu má nota alkaline-rafhlöður. Setja skal rafhlöðurnar í þannig að plús- og mínuskauf þeirra snúi rétt. Aldrei skal reyna að endurhlaða rafhlöður sem ekki eru endurhlaðanlegar. Aldrei ætti að valda skammhlaupi í rafhlöðuhólfinu.

FI

Tärkeää tietoa paristoista

Älä koskaan käytä erityyppisiä paristoja yhdessä. Älä myöskään käytä samassa laitteessa sekä vanhoja että uusia paristoja. Poista paristot tuotteesta aina, kun se on pitemmän aikaa käyttämättä, tai kun paristot ovat tyhjentyneet. Älä koskaan käytä viallisia paristoja. Käytä vain alkaliparistoja. Aseta paristot siten, että navat osoittavat oikeaan suuntaan. Älä koskaan aiheuta oikosulkua pariston kosketinten välillä.

SV

Viktig information om batterier

Använd aldrig olika sorters batterier samtidigt, och inte heller en kombination av gamla och nya batterier. Ta alltid ur batterierna om produkten inte ska användas under en längre tid eller om batterierna är slut. Använd aldrig skadade batterier. Använd endast alkaliska batterier. Sätt in batterierna så att polerna hamnar i rätt läge. Försök aldrig ladda icke-laddningsbara batterier. Kortslut aldrig batteriutrymmets kontaktytor.

NO

Viktig informasjon om batterier

Bruk aldri ulike typer batterier sammen og heller aldri gamle og nye batterier sammen. Ta alltid ut batteriene hvis produktet ikke skal brukes på lang tid, eller hvis batteriene er brukt opp. Bruk aldri skadde batterier. Bruk bare alkaliske batterier. Sett inn batteriene med polene vendt riktig vei. Forsøk aldri å lade opp ikke-oppladbare batterier. Kortslett aldri batteriholderen.

PT

Informação importante sobre as pilhas

Nunca use diferentes tipos de pilhas em simultâneo, ou uma combinação de pilhas usadas e novas. Retire sempre as pilhas se o produto não for usado durante muito tempo ou se as pilhas já não tiverem carga. Nunca use pilhas danificadas. Use apenas pilhas alcalinas. Insira as pilhas de forma a que os polos fiquem corretamente posicionados. Nunca tente recarregar pilhas não recarregáveis. Nunca deixe o compartimento das pilhas entrar em curto-circuito.

EL

Σημαντικές πληροφορίες για τις μπαταρίες

Μην χρησιμοποιείτε ποτέ διαφορετικούς τύπους μπαταριών μαζί και μην συνδυάζετε παλιές και καινούργιες μπαταρίες. Αφαιρείτε πάντα τις μπαταρίες αν δεν σκοπεύετε να χρησιμοποιήσετε το προϊόν για αρκετό καιρό ή αν οι μπαταρίες έχουν αδειάσει. Ποτέ μην χρησιμοποιείτε μπαταρίες που έχουν φθορές. Χρησιμοποιείτε μόνο αλκαλικές μπαταρίες. Τοποθετήστε τις μπαταρίες με τους πόλους στη σωστή θέση. Μην επιχειρήσετε ποτέ να επαναφορτίσετε μη επαναφορτιζόμενες μπαταρίες. Ποτέ μην βραχυκυκλώνετε τη θήκη των μπαταριών.

JA

電池取扱いに関する重要事項

異なるタイプの電池や古い電池を混ぜて使用しないでください。商品を長時間使用しないときや電池が切れたときは、電池を必ず取り外してください。不具合のある電池は絶対に使用しないでください。アルカリタイプの電池のみを使用してください。電極を確認して電池を正しい向きに入れてください。充電式ではない電池は絶対に充電しないでください。電池ホルダをショートさせないでください。

ZH

電池使用注意事項

请勿同时使用不同类型的电池，或把新旧程度不同的电池混合使用。如果产品将有很长时间不会使用，或者电池已经没电，请注意取出电池。切勿使用已破损的电池。仅可使用碱性电池。装入电池时请注意正负极。请勿尝试给非充电电池充电。切勿对电池仓进行短路连接。

KO

배터리 사용 시 주의사항

다른 종류의 배터리를 함께 사용하거나, 새 전지와 오래된 전지를 혼용하지 마세요. 배터리가 방전되었거나 장기간 제품을 작동하지 않을 때에는 반드시 배터리를 분리하세요. 파손된 배터리는 사용하지 마세요. 일괄라인 타입의 배터리만을 사용하세요. 양극과 음극의 위치를 잘 맞춰서 넣으세요. 일반 배터리는 충전해서 사용할 수 없습니다. 배터리 홀더의 접촉부에 배터리를 정확히 끼워서 사용하세요.

RU

Необходимая информация об элементах питания

Ни в коем случае не используйте одновременно элементы питания различных типов, а также элементы питания с разным сроком годности. В обязательном порядке вынимайте элементы питания из терминалов в случае, если вы не пользуетесь прибором в течение долгого времени, либо в случае, если в элементах питания закончился заряд. Ни в коем случае не используйте поврежденные элементы питания. Используйте только элементы питания щелочного типа. Установите элементы питания, соблюдая указанную полярность. Ни в коем случае не пытайтесь подзаряжать непerezаряжаемые элементы питания. Ни в коем случае не пытайтесь замкнуть полюса в устройстве для элементов питания.

PL

Ważne informacje dotyczące baterii

Nigdy nie należy stosować razem różnych rodzajów baterii ani stosować równocześnie starych i nowych baterii. Jeżeli produkt nie jest używany przez dłuższy czas lub jeżeli baterie się wyczerpały, należy wyjąć baterie. Nigdy nie należy stosować uszkodzonych baterii. Należy używać wyłącznie baterii alkalicznych. Przy wkładaniu baterii należy zwrócić uwagę na właściwe położenie biegunów. Nigdy nie należy próbować ładowania baterii jednorazowych. Nigdy nie należy doprowadzać do zwarcia w gnieździe baterii.

CZ

Důležitá informace o bateriích

Nikdy nepoužívejte najednou různé typy baterií nebo kombinaci starých a nových baterií. Nebude-li se výrobek delší dobu používat nebo jsou-li baterie vybité, vždy je vyjměte z výrobku. Nikdy nepoužívejte poškozené baterie. Používejte pouze alkalické baterie. Baterie instalujte se správnou orientací pólů. Nikdy se nesazte nabíjet baterie, které nejsou nabíjitelné. Nikdy nezkratujte kontakty v prostoru pro baterie.

SK

Dôležitá informácia o batériách

Nikdy nepoužívajte naraz odlišné typy batérií ani nekombinujte staré batérie s novými. Batérie vždy vyberte, ak sa výrobok nebude dlhšie používať, alebo ak sa batérie vybili. Nikdy nepoužívajte poškodené batérie. Používajte iba alkalické batérie. Batérie kladajte so správnou orientáciou pólou. Nikdy sa nesazte nabíjať batérie, ktoré nie sú nabíjateľné. Nikdy neskratujte kontakty v priestore pre batérie.

HU

Fontos tudnivalók az elemekről

Soha ne használjon különböző típusú elemeket, illetve ne használjon vegyesen új és használt elemeket. Mindig távolítsa el az elemeket, ha a készüléket előre láthatóan hosszabb ideig nem fogják használni, vagy ha az elemek lemerültek. Soha ne használjon megrongálódott elemeket. Csak alkáli elemeket használjon! Az elemeket helyesen helyezze be, a polaritásuknak megfelelően. Soha ne próbálja meg feltölteni a nem tölthető elemeket. Soha ne hozzon létre rövidzárlatot az elemtartó kivezetéséin.

UA

Необхідна інформація про батарейки

Ніколи не використовуйте одночасно батарейки різних типів або батарейки з різним терміном придатності. Обов'язково вилучайте батарейки з приладу, якщо довго не користуетесь ним, або якщо в батарейках уже скінчився заряд. Ніколи не використовуйте пошкоджені батарейки. Використовуйте лише лужні батарейки. Вставляйте батарейки, враховуючи задану полярність. У будь-якому випадку не намагайтеся підзарядити батарейки, що не підлягають підзарядці. У будь-якому випадку не намагайтеся зробити коротке замикання в приладі для батарей.

HR

Važne obavijesti o bateriji

Nikada nemoj koristiti različite vrste baterija zajedno, isto tako ni kombinaciju starih i novih baterija. Uvijek izvadite baterije ako dugo nećeš koristiti proizvod ili ako su one potrošene. Nikada nemoj koristiti oštećene baterije. Uпотребљавajte samo alkalne baterije. Umetni baterije pazeci da dobro okreneš polove. Nikada ne pokušavaj puniti baterije koje nisu predviđene za punjenje. Nikada ne izazivaj kratki spoj u držaču baterija.

SR

Важне информације о батеријама

Nikada ne koristite različite tipove baterija zajedno niti kombinaciju starih i novih baterija. Uvek izvadite baterije ukoliko proizvod ne možete da se dugo vreme koristiti ili ukoliko su baterije prazne. Nikada ne koristite oštećene baterije. Koristite samo alkalne baterije. Stavite baterije tako da su polovi pravilno pozicionirani. Nikada ne pokušavajte da punite baterije koje ne mogu da se pune. Nikada ne izazivajte kratak spoj u kućištu za baterije.

MK

Важни информации за батериите

Nikošah ne koristete različiti tipovi baterii zaedno ili kombinacija od stari i novi baterii. Sekošah odstranjuvajte gi bateriite dookolu ne go koristite proizvodot podolgo vreme ili dookolu se potrošile. Nikošah ne koristete ošteteni baterii. Koristete samo alkalni baterii. Vmetnete gi bateriite taka što točno ke gi namestite polovite. Nikošah ne obiduvajte se da gi polnite bateriite za ednokratna upotreba. Nikošah ne predizvikuvajte kratok spoj na držajot za baterii.

SL

Pomembne informacije o baterijah

Nikoli ne uporabljajte skupaj različnih baterij ali kombinacije starih in novih baterij. Vedno odstranite baterije, če izdelka dlje časa ne boste uporabljali ali če so iztrošene. Nikoli ne uporabljajte poškodovanih baterij. Uporabljajte le alkalne baterije. Baterije vstavite tako, da so njihovi poli pravilno obrnjeni. Nikoli ne poskušajte polniti baterij, ki niso akumulatorske. Pazite, da ležišč za baterije ne boste spravili v kratek stik.

RO

Informații importante despre baterii

Nu folosiți niciodată împreună tipuri diferite de baterii, sau o combinație de baterii vechi și noi. Îndepărtați întotdeauna bateriile dacă produsul nu este folosit timp îndelungat sau dacă bateriile s-au epuizat. Nu folosiți niciodată baterii deteriorate. Utilizați numai baterii de tip alcalin. Introduceți bateriile astfel ca polișii să fie poziționați corect. Nu încercați niciodată să reîncărcați baterii nereîncărcabile.

Nu scurtcircuitați niciodată suportul bateriei.

BG

Важна информация за батериите

Никога не използвайте едновременно различни типове батерии или комбинация от стари и нови батерии. Винаги изваждайте батериите, ако изделието няма да се използва продължително време или ако батериите са се изтозили. Никога не използвайте повредени батерии. Използвайте само алкални батерии. Поставете батериите така, че полюсите да са разположени правилно. Никога не опитвайте да зареждате батерии, които не са акумулаторни. Никога не свързвайте на кръсо контактите на отделенияето за батериите.

LV

Svarīga informācija par baterijām

Nekad vienlaikus nelietojiet dažādu tipu, kā arī vecas un jaunas baterijas. Vienmēr izņemiet baterijas, ja tās ir izlādējušās vai ja produkts ilgāku laiku netiek lietots. Nekad nelietojiet bojātas baterijas. Izmantojiet tikai sārma tipa baterijas. Ievietojot baterijas, ievērojiet pareizu polaritāti. Nekad nemēģiniet uzlādēt baterijas, kas nav uzlādējamas. Nepieļaujiet issavienojumu bateriju nodalījumā.

ET

Oluline teave patareide kohta

Ära kunagi kasuta koos erinevat tüüpi patareisid, samuti vanu ja uusi patareisid. Kui mänguasja ei kasutata pika aja jooksul, võta patarei sellest välja. Ära kunagi kasuta kahjustatud patareisid. Kasuta ainult leelispatareisid. Pane patareid mänguasja sisse nii, et pluss- ja miinusklemmi asend oleks õige. Ära kunagi proovi akulaadijaga laadida tavalisi patareisid. Patareipesa klemmide vahel ei tohi tekkida lühist.

LT

Svarbi informacija apie elementus

Vienu metu nenaudokite skirtingų elementų, taip pat su naujais elementais nenaudokite senų. Jei nenaudosite gaminio ilgesnį laiką arba jei elementai iššeko, visuomet išimkite juos iš gaminio. Niekada nenaudokite pažeistų elementų. Naudokite tik šarminius elementus. Elementus dėkite atsižvelgdami į jų poliškumą. Niekada nebandykite įkrauti vienkartinį elementų. Saugokitės, kad elementų įdėkle nesukeltumėte trumpojo jungimo.

TR

Piller hakkında önemli bilgiler

Hiçbir zaman farklı tipte pilleri ya da eski pillerle yeni pilleri bir arada kullanmayın. Ürün uzun süre kullanılmayacaksa ya da piller bitmişse, pilleri ürünün içinden çıkarın. Hiçbir zaman zedelenmiş piller kullanmayın. Sadece alkalin piller kullanın. Pilleri kutupları doğru konumda olacak şekilde yerleştirin. Hiçbir zaman, şarj edilebilir olmayan pilleri şarj etmeye çalışmayın. Hiçbir zaman pil kutusuna kısa devre yaptırmayın.

AR

معلومات مهمة عن البطاريات

يحظر استخدام أنواع مختلفة من البطاريات معا أو مزيج من البطاريات القديمة والجديدة. أحرص دائما على نزع البطاريات في حال عدم استخدام المنتج لفترة طويلة أو إذا نفذت طاقة البطاريات. تجنب استخدام البطاريات التالفة. لا تستخدم إلا البطاريات القلوية فقط. قم بتكيب البطاريات بحيث تكون الأقطاب في موضعها الصحيح. يحظر إعادة شحن البطاريات غير القابلة لإعادة الشحن. تجنب إحداث دائرة قصر في حامل البطارية.

ID

Informasi penting tentang baterai

Jangan gunakan baterai yang jenisnya berlainan, atau mencampur baterai lama dan baterai baru. Lepas baterai jika produk tidak akan digunakan untuk waktu lama atau jika baterai sudah lemah. Jangan gunakan baterai yang rusak. Gunakan hanya baterai alkali. Masukkan baterai dengan posisi kutub yang tepat. Jangan pernah coba mengisi ulang baterai biasa. Jangan pernah membuat arus pendek pada dudukan baterai.

MS

Maklumat penting tentang bateri

Jangan guna jenis bateri yang berbeza bersama-sama, atau gabungan bateri baharu dan lama. Tanggalkan bateri jika produk tidak akan digunakan untuk tempoh masa yang lama atau jika bateri telah kehabisan kuasa. Jangan guna bateri yang rosak. Guna bateri jenis alkali sahaja. Selitkan bateri supaya paksi berada pada kedudukan yang betul. Jangan cuba untuk mengecas semula bateri yang tidak boleh dicaskan semula. Jangan pintas liter pemegang bateri.

1

4x
AAA



1x



POWERED
UP

2

6x
AAA



1x

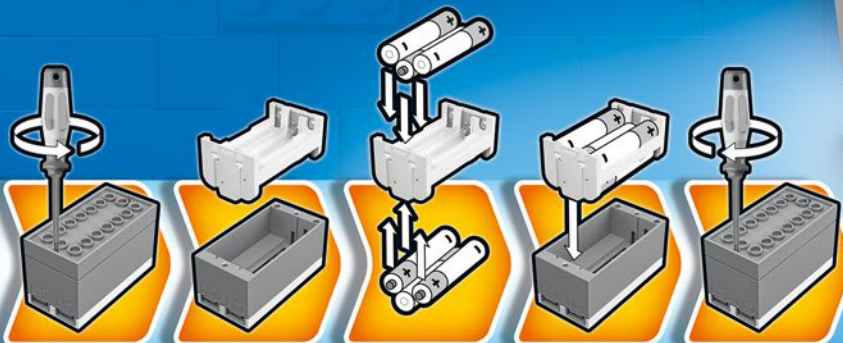

3

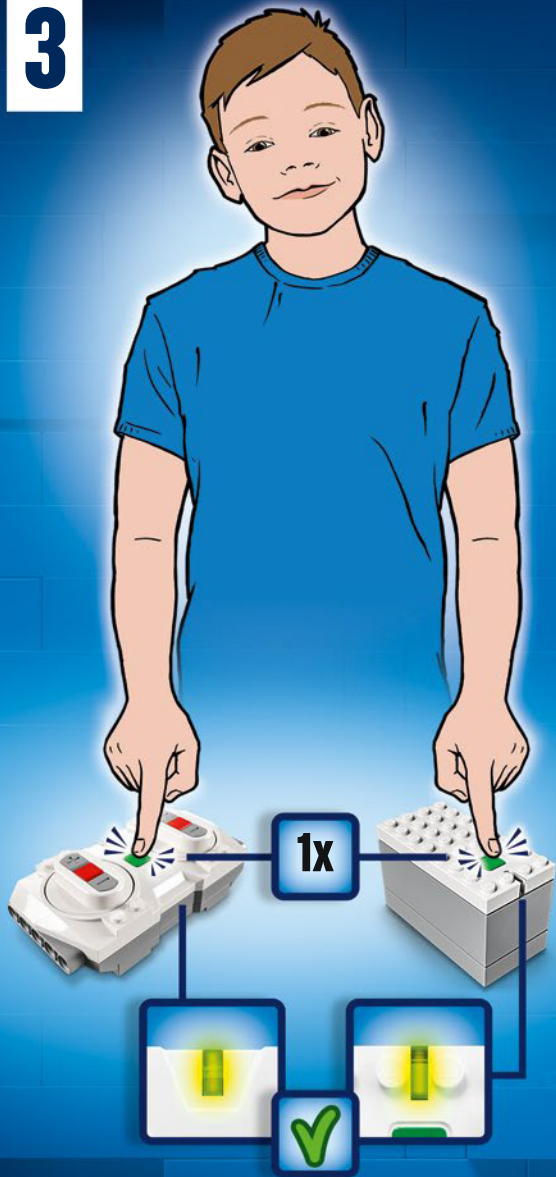

4



5

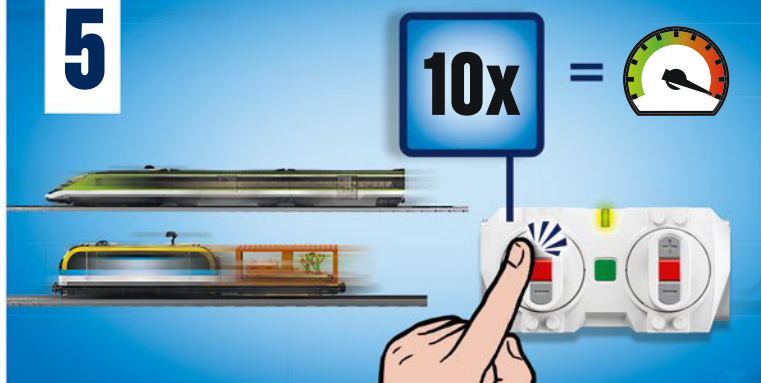

6

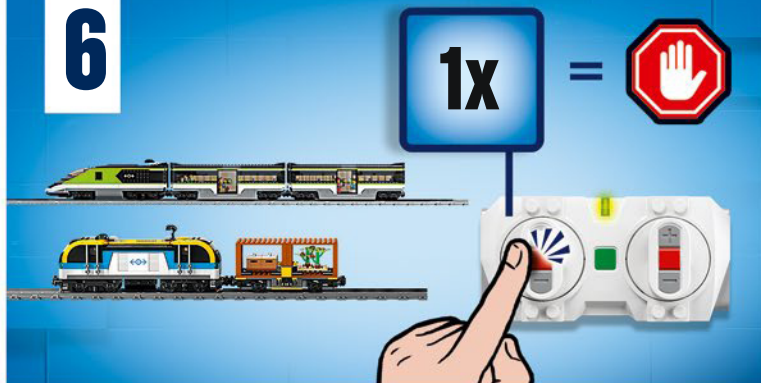

7



8



POWERED UP



LEGO® Powered Up
LEGO.com/apps



HANDSET, NO. 2 , HUB NO. 4

EN

The LEGO Group hereby declares that above product/products comply with the essential requirements and other relevant provisions of Directive 2014/53/EU.

Complete declaration on WWW.LEGO.COM/COMPLIANCE

DE

Hiermit erklart die LEGO Gruppe, dass das oben genannte Produkt/die oben genannten Produkte den notwendigen Anforderungen und weiteren relevanten Bestimmungen der Richtlinie 2014/53/EU entspricht bzw. entsprechen. Vollstandige Erklrung auf WWW.LEGO.COM/COMPLIANCE.

FR

Par la prsente, le Groupe LEGO dclare que le(s) produit(s) mentionn(s) ci-dessus est/sont conforme(s) aux exigences essentielles et aux autres dispositions pertinentes de la Directive 2014/53/UE.

Dclaration complte sur WWW.LEGO.COM/COMPLIANCE

IT

Con la presente, LEGO Group dichiara che il prodotto/prodotti di cui sopra sono conformi ai requisiti essenziali e alle altre disposizioni pertinenti stabiliti dalla Direttiva 2014/53/UE.

Dichiarazione completa su WWW.LEGO.COM/COMPLIANCE

NL

De LEGO Groep verklaart bij dezen dat het bovenstaande product/de bovenstaande producten voldoet/voldoen aan de essentile eisen en overige relevante bepalingen van Richtlijn 2014/53/EU.

De volledige verklaring is te vinden op WWW.LEGO.COM/COMPLIANCE

ES

The LEGO Group declara que el producto o los productos anteriores satisfacen los requisitos fundamentales y dems disposiciones correspondientes de la Directiva 2014/53/UE.

La declaraci3n completa est disponible en WWW.LEGO.COM/COMPLIANCE

DA

LEGO Koncernen erklrer hermed, at produktet/produkterne nvnt ovenfor opfylder de vsentlige krav og andre relevante bestemmelser i direktiv 2014/53/EU.

Komplet erklring p WWW.LEGO.COM/COMPLIANCE

IS

LEGO Group lsir hvi hr me yfir a ofangreind vara uppfyllir grundvallarkr3fur og samremist 3rum vieigandi kveum tilskipunar nr. 2014/53/ESB.

Yfirlýsinguna í heild er a finna  WWW.LEGO.COM/COMPLIANCE

FI

LEGO Group vakuuttaa tten, ett edell mainittu yksi tai useampi tuote on direktiivin 2014/53/EU oleellisten vaatimusten ja ehtojen mukainen.

Tydellinen vaatimustenmukaisuusvakuutus on osoitteessa WWW.LEGO.COM/COMPLIANCE

SV

LEGO Koncernen intyggar hrmed att ovanstende produkt/produkter uppfyller de vsentliga kraven och andra relevanta bestmmelser i direktiv 2014/53/EU.

Fullstndig f3rklaring p WWW.LEGO.COM/COMPLIANCE

NO

LEGO konsernet erklrer herved at ovennevnte produkt/produkter oppfyller de obligatoriske kravene og andre relevante bestemmelser i Europaparlaments- og rdsdirektiv 2014/53/EU.

Hele erklringen ligger p WWW.LEGO.NO

PT

O LEGO Group declara que o/os produto(s) acima mencionado(s) est/esto em conformidade com os requisitos essenciais e outras disposi3es relevantes da Diretiva 2014/53/UE.

Declarao completa em WWW.LEGO.COM/COMPLIANCE

EL

ta της παρούσης ο Όμιλος LEGO Group δηλώνει ότι το/τα παραπάνω προϊόν/προϊόντα συμμορφώνεται/ονται με τις ουσιώδεις απαιτήσεις και λλες σχετικές διατάξεις της Οδηγίας 2014/53/EE.

Η πλήρης δήλωση βρίσκεται στο WWW.LEGO.COM/COMPLIANCE

JA

LEGO Group による上記の製品はすべて、2014 年 EU 指令 (2014/53/EU) の基本的な要求事項およびその他の関連規定に準拠しております。

準拠宣言の全文はこちら:WWW.LEGO.COM/COMPLIANCE

ZH

乐高集团特此声明, 上述产品符合欧盟 2014/53/EU 指令的基本要求和其它有关规定。

请访问 WWW.LEGO.COM/COMPLIANCE 网站查看完整声明

KO

레고 그룹은 상기 제품이 2014/53/EU 지침의 필수 요건 및 기타 관련 조항을 준수함을 선언합니다.

자세한 내용은 WWW.LEGO.COM/COMPLIANCE에서 확인할 수 있습니다.

RU

Настоящим LEGO Group заявляет, что указанные выше товары отвечают основополагающим требованиям и иным применимым положениям Директивы 2014/53/EC.

Полный текст см. на сайте WWW.LEGO.COM/RU-RU.

PL

Grupa LEGO niniejszym oświadczca, że wymienione produkty s zgodne z zasadniczymi wymaganiami oraz innymi wsciwiymi postanowieniami dyrektywy 2014/53/UE.

Pełna treść deklaracji na stronie WWW.LEGO.PL

CZ

LEGO Group tímto prohlašuje, že všechny výše uvedené produkty odpovídají základním požadavkům a všem příslušným ustanovením směrnice 2014/53/EU. Kompletní prohlášení na WWW.LEGO.COM

SK

LEGO Group týmto vyhlasuje, že hore uvedené produkty zodpovedajú základným požiadavkám a všetkým príslušným ustanoveniam smernice 2014/53/EU. Kompletné prehlásenie na WWW.LEGO.COM

HU

A LEGO Csoport ezennel kijelenti, hogy a fenti termék/termékek megfelelnek a 2014/53/EU irányelv alapvető követelményeinek és egyéb vonatkozó rendelkezéseinek.

A nyilatkozat teljes szövege itt olvasható: WWW.LEGO.COM/COMPLIANCE

UA

LEGO Group заявляє, що цей продукт чи продукти відповідають головним вимогам та іншим відповідним положенням Директиви 2014/53/EU. Повний текст заяви можна переглянути на сайті WWW.LEGO.COM/COMPLIANCE

HR

LEGO Group ovim izjavljuje da su gore navedeni proizvod/proizvodi skladni bitnim zahtjevima i drugim odgovarajućim odredbama direktive 2014/53/EU. Cjelovita izjava nalazi se na WWW.LEGO.COM/COMPLIANCE

SR

Компанија LEGO Group овим путем изјављује да је/су горенаведени производ/-и усклађен/-и са основним захтевима и другим релевантним одредбама Директиве 2014/53/EU. Комплетну изјаву можете пронаћи на адреси WWW.LEGO.COM/COMPLIANCE

MK

LEGO Group со ова изјавува дека производот/производитите погоре се во согласност со основните барања и другите релевантни одредби на директивата 2014/53/EC. Целосна декларација на WWW.LEGO.COM/COMPLIANCE

SL

LEGO Group izjavlja, da izdelek ustreza osnovnim zahtevam in drugim relevantnim določilom Direktive 2014/53/ES. Celotna deklaracija je na spletni strani WWW.LEGO.COM/COMPLIANCE

RO

Grupul LEGO declară prin prezenta că produsul/produsele de mai sus se conformează cerințelor esențiale și altor prevederi relevante ale Directivei 2014/53/UE. Declarația completă pe WWW.LEGO.COM/COMPLIANCE

BG

LEGO Group декларира, че посочените продукти по-горе съответстват на основните изисквания и други съответни разпоредби на Директива 2014/53/EC. Пълна декларация на WWW.LEGO.COM/COMPLIANCE

LV

Ar šo LEGO Group paziņo, ka iepriekšminētās(ie) produkts(i) atbilst Direktīvas 2014/53/ES būtiskajām prasībām un citiem saistītiem noteikumiem. Pilns deklarācijas teksts pieejams vietnē WWW.LEGO.COM/COMPLIANCE

ET

Käesolevaga teatab LEGO Group, et eespool nimetatud toode/tooted vastavad direktiivi 2014/53/EL oluliste nõuetele ja muudele asjakohastele sätetele. Täielik deklaratsioon on saadaval aadressil WWW.LEGO.COM/COMPLIANCE

LT

Šiuo dokumentu „LEGO Group“ deklaruoja, kad anksčiau nurodytas (-i) produktas (-ai) atitinka svarbiausius reikalavimus ir kitas 2014/53/ES direktyvos sąlygas. Visą deklaraciją rasite WWW.LEGO.COM/COMPLIANCE

TR

LEGO Group işbu belge ile yukarıdaki ürünü/ürünlerin 2014/53/EU sayılı direktifin temel gereksinimlerine ve diğer ilgili hükümlerine uygun olduğunu beyan eder. Beyanın tam metnine WWW.LEGO.COM/COMPLIANCE adresinden ulaşabilirsiniz.

AR

تعليّن مجموعة LEGO Group بموجب هذه الوثيقة أن المنتج/المنتجات تتوافق مع المتطلبات الأساسية والأحكام الأخرى ذات الصلة بالتوجيه 2014/53/EC. التصريح كاملاً على الموقع WWW.LEGO.COM/COMPLIANCE

ID

LEGO Group dengan ini menyatakan bahwa produk di atas sesuai dengan persyaratan penting dan ketentuan terkait lainnya dalam Directive 2014/53/EU. Pernyataan selengkapnya tersedia di WWW.LEGO.COM/COMPLIANCE

MS

LEGO Group dengan ini mengumumkan bahawa produk di atas mematuhi keperluan asas dan peruntukan relevan lain dalam Directive 2014/53/EU. Pengisytiharan lengkap di WWW.LEGO.COM/COMPLIANCE

This device complies with part 15 of the FCC Rules. Operation is subject to the following two conditions:

- (1) This device may not cause harmful interference, and
- (2) this device must accept any interference received, including interference that may cause undesired operation.

NOTE: This equipment has been tested and found to comply with the limits for a Class B digital device, pursuant to part 15 of the FCC Rules. These limits are designed to provide reasonable protection against harmful interference in a residential installation. This equipment generates, uses and can radiate radio frequency energy and, if not installed and used in accordance with the instructions, may cause harmful interference to radio communications.

However, there is no guarantee that interference will not occur in a particular installation. If this equipment does cause harmful interference to radio or television reception, which can be determined by turning the equipment off and on, the user is encouraged to try to correct the interference by one or more of the following measures:

- Reorient or relocate the receiving antenna.
- Increase the separation between the equipment and receiver.
- Connect the equipment into an outlet on a circuit different from that to which the receiver is connected.
- Consult the dealer or an experienced radio/TV technician for help.

Caution: changes or modifications not expressly approved by the party responsible for compliance could void the user's authority to operate the equipment.

This device contains licence-exempt transmitter(s)/receiver(s) that comply with Innovation, Science and Economic Development Canada's licence-exempt RSS(s). Operation is subject to the following two conditions:

- (1) This device may not cause interference.
- (2) This device must accept any interference, including interference that may cause undesired operation of the device.

L'émetteur/récepteur exempt de licence contenu dans le présent appareil est conforme aux CNR d'Innovation, Sciences et Développement économique Canada applicables aux appareils radio exempts de licence. L'exploitation est autorisée aux deux conditions suivantes :

- (1) L'appareil ne doit pas produire de brouillage;
- (2) L'appareil doit accepter tout brouillage radioélectrique subi, même si le brouillage est susceptible d'en compromettre le fonctionnement.

CAN ICES-3 (B)/NMB-3(B)

La operación de este equipo está sujeta a las siguientes dos condiciones:

- (1) es posible que este equipo o dispositivo no cause interferencia perjudicial y
- (2) este equipo o dispositivo debe aceptar cualquier interferencia, incluyendo la que pueda causar su operación no deseada.

Este equipamento não tem direito à proteção contra interferência prejudicial e não pode causar interferência em sistemas devidamente autorizados.

取得審驗證明之低功率射頻器材，非經核准，公司、商號或使用者均不得擅自變更頻率、加大功率或變更原設計之特性及功能。低功率射頻器材之使用不得影響飛航安全及干擾合法通信；經發現有干擾現象時，應立即停用，並改善至無干擾時方得繼續使用。前述合法通信，指依電信管理法規定作業之無線電通信。低功率射頻器材須忍受合法通信或工業、科學及醫療用電波輻射性電機設備之干擾。

台灣樂高貿易股份有限公司
台北市信義區忠孝東路四段555-1號11樓B室



เครื่องโทรคมนาคมและอุปกรณ์นี้มีความสอดคล้องตาม
มาตรฐานหรือข้อกำหนดทางเทคนิค ของ กสทช



Complies with
IMDA Standards
DA103787

- EN CAUTION: Risk of explosion if the battery is replaced by an incorrect type.
- DE ACHTUNG: Es besteht Explosionsgefahr, wenn die Batterie durch einen ungeeigneten Batterietyp ersetzt wird.
- FR ATTENTION : Risque d'explosion si la pile est remplacée par un modèle incompatible.
- IT ATTENZIONE: rischio di esplosione se la batteria è sostituita con una di tipo errato.
- NL VOORZICHTIG: Explosiegevaar indien de batterij wordt vervangen door een onjuist type.
- ES PRECAUCIÓN: Sustituir la batería por otra de tipo incorrecto representa un riesgo de explosión.
- DA ADVARSEL: Der er risiko for eksplosion, hvis batteriet udskiftes med en forkert type.
- IS VARÚD: Hætta á sprengingu ef rafhlöðunni er skipt út fyrir rafhlöðu af rangri gerð.
- FI VAROITUS: Räjähdyksvaara, jos pariston tilalle vaihdetaan väärän tyyppinen paristo.
- SV VARNING: Explosionsrisk om batteriet byts ut mot ett batteri av fel typ.
- NO FORSKTIG: Kan eksplodere hvis batteriet skiftes ut med feil type batteri.
- PT ATENÇÃO: Risco de explosão se as pilhas forem substituídas por um tipo incorreto.
- EL ΠΡΟΣΟΧΗ: Κίνδυνος έκρηξης εάν η μπαταρία αντικατασταθεί με μια άλλη λανθασμένου τύπου.
- JA 注意:誤った種類の電池を挿入すると爆発する恐れがあります。
- ZH 注意事项:如果所更换的电池类型不正确,则存在爆炸的风险。
- KO 주의: 출고 시 규격 이외의 배터리로 교체할 경우 폭발의 위험이 있습니다.
- RU ВНИМАНИЕ! Установка элемента питания неправильного типа может привести к его взрыву.
- PL UWAGA: Zastosowanie nieprawidłowego typu baterii stwarza zagrożenie wybuchem.
- CZ POZOR: V případě nahrazení baterie nesprávným typem hrozí riziko výbuchu.
- SK VAROVANIE: Ak batériu nahradíte nesprávnym typom, hrozí riziko výbuchu.
- HU VIGYÁZAT! Robbanásveszély, ha az akkumulátort nem megfelelő típusúra cserélik.
- UA ОБЕРЕЖНО! Якщо вставити невідповідний тип батарейки, може статися вибух.
- HR OPREZ: Opasnost od eksplozije ako se baterija zamijeni vrstom koja nije propisana.
- SR ОПРЕЗ: Опасност од експлозије ако се батерија замени неодговарајућом врстом.
- MK ВНИМАНИЕ: Има ризик од експлозија, ако батеријата е заменета со погрешен тип.
- SL POZOR: Če vstavite baterijo napačnega tipa, tvegate, da bo eksplodirala.
- RO ATENȚIE: risc de explozie dacă bateria este înlocuită cu una de un tip incorect.
- BG ВНИМАНИЕ: Има риск от експлозия, ако батерията бъде заменена с такава от неправилен тип.
- LV UZMANĪBU! Ja baterija tiek nomainīta ar nepareiza tipa bateriju, pastāv sprādziena risks.
- ET ETTEVAATUST! Plahvatusoht, kui patarei asendatakse vale tüüpi patareiga.
- LT ATSARGIAI! Įstačius netinkamo tipo elementą, gali kilti sproginimo pavojus.
- TR UYARI: Yanlış türde pil kullanılırsa patlama riski bulunur.
- AR تنبيه: خطر الانفجار في حالة استبدال البطارية بنوع غير صحيح.
- ID HATI-HATI: Risiko ledakan dapat timbul jika baterai diganti dengan jenis yang berbeda.
- MS PERINGATAN: Risiko letupan jika bateri ditukarkan dengan jenis bateri yang salah.

EN Please retain the leaflet and packaging as they contain important information

DE Broschüre und Verpackung bitte aufbewahren, sie enthalten wichtige Informationen

FR Veuillez conserver le dépliant et l'emballage, car ils contiennent des informations importantes

IT Conserva l'opuscolo e la confezione in quanto contengono informazioni importanti

NL Bewaar a.u.b. de folder en verpakking: die bevatten belangrijke informatie

ES Conserve el folleto y el embalaje; contienen información importante

DA Gem hæftet og emballagen, da de indeholder vigtige oplysninger

IS Geymið bæklinginn og umbúðirnar þar sem þau innihalda mikilvægar upplýsingar

FI Säilytä esite ja pakkaus, koska ne sisältävät tärkeää tietoa

SV Spara broschyren och förpackningen eftersom de innehåller viktig information

NO Heftet og emballasjen inneholder viktig informasjon og skal beholdes

PT Por favor guarde o folheto e a embalagem, pois contém informação importante

EL Κρατήστε το φυλλάδιο και τη συσκευασία γιατί περιέχουν σημαντικές πληροφορίες

JA 説明書とパッケージには重要な情報が含まれていますので保管しておいてください

ZH 说明书和包装均包含重要信息, 请妥善保管

KO 중요한 정보가 담겨 있으므로 리플릿과 포장을 보관해두세요

RU Пожалуйста, сохраните эту брошюру и упаковку, поскольку они содержат важную информацию

PL Prosimy zachować ulotkę i opakowanie, ponieważ zawierają one ważne informacje

CZ Ponechte si prosím leták i obal, neboť obsahují důležité informace

SK Ponechajte si prosím leták aj obal, pretože obsahujú dôležité informácie

HU Kérjük, őrizze meg a szórólapot és a csomagolást, mert fontos tudnivalókat tartalmaznak

UA Будь ласка, зберігайте вкладиш та упаковку, оскільки вони містять важливу інформацію

HR Spremite letak i ambalažu jer sadrže važne obavijesti

SR Молимо да сачувате упутство и паковање јер се на њима налазе важне информације

MK Чувајте ги брошурата и амбалажата бидејќи содржат важна информација

SL Prosimo, da brošurico in embalažo shranite, saj vključujeta pomembne informacije

RO Vă rugăm să păstrați prospectul și ambalajul întrucât conțin informații importante

BG Запазете листовката и опаковката, тъй като съдържат важна информация

LV Lūdzu, saglabājiet bukletu un iepakojumu, jo uz tā ir norādīta svarīga informācija

ET Hoidke infoleht ja pakend alles, sest nendele on märgitud oluline teave

LT Išsaugokite informacinį lapelį ir pakuotę, nes ant jų pateikiama svarbi informacija

TR Önemli bilgiler içerdiği için broşürü ve ambalajı saklayın

AR الرجاء الاحتفاظ بالنشرة والغلاف لاحتوائهما على معلومات هامة

ID Harap simpan brosur dan kemasan ini karena berisi informasi penting

MS Sila simpan risalah dan pembungkusan kerana ia mengandungi maklumat penting



EN

Protect the environment by not disposing of this product with your household waste.
Check with your local authority for recycling advice and facilities. Penalties may apply for improper disposal.

DE

Schützen Sie die Umwelt und entsorgen Sie dieses Produkt nicht mit Ihrem Hausmüll.
Informationen zu Recycling-Möglichkeiten erhalten Sie bei den örtlichen Behörden. Bei unsachgemäßer Entsorgung können Strafen verhängt werden.

FR

Protégez l'environnement : ne jetez pas ce produit avec vos autres déchets ménagers.
Contactez les autorités locales pour obtenir des informations sur le recyclage et connaître les points de collecte. Des sanctions peuvent être appliquées en cas d'élimination inappropriée.

IT

Proteggi l'ambiente! Non smaltire questo prodotto con i rifiuti domestici.
Per consulenza sul riciclaggio dei rifiuti e le strutture di riciclaggio, rivolgersi alle proprie autorità locali. Uno smaltimento improprio può comportare sanzioni.

NL

Bescherm het milieu: gooi dit product niet samen met het andere huisvuil weg.
Raadpleeg de plaatselijke instanties voor locaties van milieustations en advies over hergebruik. In geval van onjuiste verwijdering kunnen boetes worden opgelegd.

ES

Proteja el medio ambiente no deshaciéndose de este producto junto con sus residuos domésticos.
Solicite asesoramiento e información sobre instalaciones de reciclaje a las autoridades locales. La eliminación inadecuada puede ser objeto de sanciones.

DA

Beskyt miljøet! Smid ikke dette produkt ud sammen med husholdningsaffaldet.
Få vejledning om genbrug og genbrugsstationer hos din kommune.
Ukorrekt bortskaffelse kan medføre bøde eller straf.

IS

Stuðlið að umhverfisvernd með því að farga þessari vöru ekki með heimilissorpi.
Leitið upplýsinga um endurvinnslu- og förgunarstaði hjá yfirvöldum á hverjum stað. Viðurlögum kann að vera beitt ef förgun er ekki með réttum hætti.

FI

Tämä tuote on hävitettävä ympäristöstävällisesti ja erillään muusta talousjätteestä.
Tietoja kierrätyksestä ja keräyspisteiden sijainnista saat paikkakuntasi teknisestä virastosta. Epäasianmukaisesta hävittämisestä saattaa aiheutua seuraamuksia.

SV

Skydda miljön genom att inte kasta denna produkt bland ditt hushållsavfall.
Kontakta din kommun för frågor om återvinning och miljöstationer. Påföljder kan tillkomma för felaktigt avyttring.

NO

Beskytt miljøet. Ikke kast dette produktet i husholdningsavfallet.
Kontakt kommunen for veiledning om gjenbruk og miljøstasjoner. Feil avfallshåndtering kan være straffbart.

PT

Proteja o ambiente não eliminando este produto com o seu lixo doméstico.
Consulte as autoridades locais para informação sobre reciclagem e sistemas de recolha. Podem ser aplicadas coimas por eliminação inadequada.

EL

Προστατέψτε το περιβάλλον. Μην πετάτε αυτό το προϊόν μαζί με τα συνηθισμένα οικιακά απορρίμματα.
Επικοινωνήστε με τις τοπικές αρχές σχετικά με συμβουλές και εγκαταστάσεις ανακύκλωσης. Ενδέχεται να επιβάλλονται κυρώσεις για ακατάλληλη διάθεση απορριμμάτων.

JA

環境保護のため、本製品は家庭ごみとは別に処分してください。
リサイクルに関する指示や施設については、お住まいの地方自治体にお問い合わせください。不適切な廃棄を行った場合、罰則が適用されることがあります。

ZH

注意保护环境，请勿将本产品与生活垃圾一起丢弃处理。
请咨询当地相关部门，了解与回收相关的设施与建议。
处理不当可能会导致处罚。

KO

환경 보호를 위해 이 제품을 생활폐기물과 함께 버리지 마십시오.
재활용 방법 및 시설에 관한 사항은 현지 관계 당국에 문의하십시오. 부적절하게 폐기할 경우 벌칙이 부과될 수 있습니다.

RU

Позаботьтесь об окружающей среде: не утилизируйте этот продукт вместе с бытовым мусором.
Узнайте в органах местного самоуправления правила вторичной переработки и утилизации таких отходов.
В случае ненадлежащей утилизации могут быть наложены штрафы.



PL

Aby chronić środowisko naturalne, nie należy wyrzucać tego produktu wraz z odpadkami z gospodarstwa domowego.

W celu uzyskania wskazówek dotyczących recyklingu oraz adresów zakładów należy skontaktować się z lokalnym urzędem.

Za nieprzestrzeganie zasad związanych z utylizacją odpadów grożą kary.

CZ

Nevyhazujte tento produkt do domácího odpadu, chráňte životní prostředí.

Zjistěte si prosím u místních úřadů možnosti recyklace a dostupná zařízení.

Nesprávná likvidace může být pokutována.

SK

Nevyhádzajte tento produkt do domáceho odpadu, chráňte životné prostredie.

Zistite si na miestnych úradoch možnosti recyklácie a dostupné zariadenia.

Za nesprávnu likvidáciu môžu byť uložené sankcie.

HU

Környezetét óvja, ha ettől a terméktől nem a háztartási hulladékkal együtt válik meg.

Érdeklődjék a lakóhelyéhez közel eső hatóságánál az újrahasznosítás módjáról és lehetőségeiről. A nem megfelelő hulladékéelhelyezésért büntetés járhat.

UA

Допоможіть захистити довкілля: не утилізуйте цей виріб разом із побутовим сміттям.

Вказівки з утилізації та відомості про пункти прийому з'ясуєте в місцевих компетентних органах. У разі неналежної утилізації можуть застосовуватися штрафи.

HR

Zaštite okoliš tako da ovaj proizvod ne odložite u otpad zajedno s kućanskim otpadom.

Od lokalnih vlasti zatražite savjet ili informacije o pogonima za recikliranje.

Moguća je kazna za nepropisno zbrinjavanje.

SR

Zaštite životnu sredinu tako što nećete da odlažete ovaj proizvod sa kućnim otpadom.

Raspitajte se kod lokalnog nadležnog organa o načinu reciklaže i o sabirnom centru. U slučaju nepravilnog odlaganja u otpad, mogu biti izrečene kazne.

MK

Zaštite je oколната така што нема да се ослободите од производот со домашниот отпад.

Консултирајте се со локалните власти за да дознаете за советите и објектите за рециклирање. Возможно е да бидат применети казни за неправилно исфрлање.

SL

Zaščitite okolje! Okolje varujte tako, da tega izdelka ne zavržete skupaj z gospodinjiskimi odpadki.

Pri krajevni upravi preverite, kakšne možnosti in kateri obrati za recikliranje obstajajo v vaši okolici. Za nepravilno odlaganje odpadkov vas lahko doleti kazen.

RO

Protejați mediul înconjurător și nu vă debarașiți de acest produs împreună cu deșeurile menajere.

Consultați autoritățile locale pentru îndrumări și facilități de reciclare. Dezafectarea necorespunzătoare poate atrage sancțiuni.

BG

Защитете околната среда и не изхвърляйте този продукт заедно с битовите си отпадъци.

Свържете се с местните власти относно съвети и съоръжения за рециклиране. Възможно е да има глоби за неправилно изхвърляне.

LV

Lai saudzētu vidi, neizmetiet šo izstrādājumu kopā ar sadzīves atkritumiem.

Vērsieties vietējās varas iestādēs, lai noskaidrotu, kur un kā tas nododams pārstrādei. Par neatbilstošu likvidēšanu var tikt piemērots sods.

ET

Keskonda saate kaitsta nii, et ei kõrvalda seda toodet koos olmejäätmetega.

Nõuandeid toote taaskasutusse võtmise ja ümbertöötlemispunktid kohta saate asjaomaselt kohalikult asutuselt.

Nõutele mittevastav kasutuselt kõrvaldamine võib kaasa tuua trahvid.

LT

Saugokite aplinką; nemeskite šio produkto kartu su buitinemis atliekomis.

Atsižvelkite į savo vietos valdžios rekomendacijas dėl pakartotinio panaudojimo ir sąlygas. Už netinkamą šalinimą gali būti taikomos baudos.

TR

Bu ürünü, evsel atıklarla birlikte atmayarak çevreyi koruyun.

Gerİ dönüşüm tavsiyeleri ve tesisler hakkında bilgi için yerel yönetimle iletişİm kurun. Uygunsz atılması durumunda cezalar uygulanabilir.

AR

احم البيئة بعدم التخلص من هذا المنتج مع المخلفات المنزلية.
استشر السلطة المحلية لديك للحصول على نصح بخصوص إعادة تدوير المخلفات ومرفاقه.
قد يتم تطبيق عقوبات على التخلص غير السليم.

ID

Jagalah lingkungan dengan tidak membuang produk ini bersama sampah rumah tangga Anda.

Periksa peraturan pemerintah setempat tentang saran dan fasilitas daur ulang. Pembuangan yang tidak sesuai ketentuan dapat dikenakan denda.

MS

Lindungi alam sekitar dengan tidak melupuskan produk ini bersama sisa isi rumah anda.

Rujuk pihak berkuasa tempatan anda tentang nasihat dan kemudahan kitar semula. Penalti boleh dikenakan untuk pelupusan yang tidak wajar.





EN
CAUTION: The substitution of firmware in this product with firmware not approved or supplied by the LEGO Group may cause unpredictable product behaviour, including damaged or overheated batteries, overheated element surfaces (e.g. motors or sensors), or other hazards.

DE
ACHTUNG: Der Austausch von Firmware in diesem Produkt durch nicht genehmigte oder mitgelieferte Firmware durch die LEGO Group kann zu unvorhersehbaren Situationen führen, einschließlich beschädigte oder überhitzte Batterien, überhitzte Elementoberflächen (z. B. Motoren oder Fühler), oder anderen Gefahren.

FR
ATTENTION : Toute substitution du microprogramme de ce produit avec un microprogramme non approuvé ou non fourni par le Groupe LEGO peut engendrer certains dangers ou situations imprévisibles, tels que l'endommagement ou la surchauffe des piles ou la surchauffe de certaines surfaces de l'élément (p. ex., moteurs ou capteurs).

IT
AVVERTENZA: la sostituzione del firmware di questo prodotto con un firmware non approvato o non fornito da The LEGO Group può causare condizioni imprevedibili, incluso danni o surriscaldamento delle batterie, surriscaldamento delle superfici degli elementi (per es. motori o sensori) o altri pericoli.

NL
VOORZICHTIG: als je de firmware van dit product vervangt door firmware die niet is goedgekeurd of aangeleverd door de LEGO Groep kan dit onvoorspelbare gevolgen hebben, zoals beschadigde of oververhitte batterijen, oververhitte elementoppervlakken (zoals bij motoren of sensoren) en andere gevaarlijke situaties.

ES
PRECAUCIÓN: La sustitución del firmware de este producto por una versión no autorizada o suministrada por The LEGO Group puede dar lugar a resultados impredecibles, como daños en las pilas o sobrecalentamiento de las mismas, sobrecalentamiento de la superficie de elementos como los motores o sensores, y otras situaciones peligrosas.

DA
ADVARSEL: Udskitning af firmware i dette produkt med firmware, som ikke er godkendt eller leveret af LEGO Koncernen, kan medføre uforudsigelige forhold, herunder beskadigede eller overophedede batterier, overophedede elementoverflader (f.eks. motorer eller sensorer) eller andre farer.

IS
VARÚÐ: Skipti á fastbúnaði þessarar vöru fyrir fastbúnað sem ekki er samþykktur eða kemur ekki frá The LEGO Group geta valdið ófyrirsjáanlegum aðstæðum, þ.m.t. skemmdum rafhlöðum eða ofhitnun í rafhlöðum, of heitu yfirborði hluta (t.d. mótorá eða skynjara) eða annarri hættu.

FI
VAROITUS: Tämän tuotteen laiteohjelmiston vaihtaminen sellaiseen laiteohjelmistoon, jota LEGO Group ei ole hyväksynyt tai toimittanut, voi aiheuttaa ennalta arvaamattomia tilanteita, kuten akkujen ja paristojen vaurioita tai ylikuumentumista, (esim. moottorien ja anturien) pintojen ylikuumentumista tai muita vaaratilanteita.

SV
VAR FÖRSIKTIG: Ersättning av firmware i denna produkt med firmware som inte är godkänd eller tillhandahålls av LEGO Koncernen kan orsaka oförutsägbara tillstånd, inklusive skadade eller överhettade batterier, överhettade elementtytor (t.ex. motorer eller givare), eller andra faror.

NO
FORSIKTIG! Hvis fastvaren i dette produktet byttes ut med fastvare som ikke er godkjent av LEGO konsernet, kan det gi uforutsigbare resultater, inkludert batteriskade, overoppheting av batterier, overoppheting av elementoverflater (f.eks. motorer eller sensorer) eller annen fare.

PT
ATENÇÃO: A substituição do firmware neste produto por firmware que não tenha sido aprovado ou fornecido pelo LEGO Group pode causar situações imprevisíveis, incluindo pilhas danificadas ou sobreaquecidas, superfícies de elementos sobreaquecidas (por ex., motores ou sensores), ou outros perigos.

EL
ΠΡΟΣΟΧΗ: Η αντικατάσταση του firmware αυτού του προϊόντος με firmware το οποίο δεν έχει εγκριθεί ή παρασχεθεί από τον όμιλο LEGO Group μπορεί να προκαλέσει απρόβλεπτες συνθήκες, όπως βλάβη ή υπερθέρμανση μπαταριών, υπερθέρμανση των επιφανειών των στοιχείων (π.χ. κινητήρων ή αισθητήρων), ή άλλους κινδύνους.

JA
注意: 本製品のファームウェアを、LEGO Group が承認または供給した以外のファームウェアに交換すると、電池の損傷や加熱、パーツ表面の加熱 (例: モーター、センサー)、その他の危険など、不測の事態を引き起こす原因となる可能性があります。

ZH
注意事项: 使用非乐高集团准许或提供的固件替换本产品中的固件, 可能会导致不可预知的情况, 包括电池损坏或过热、元素表面过热 (如电机或传感器) 或其它危险。

KO
주의: 레고 그룹에서 승인하거나 제공하지 않은 펌웨어를 이용해 이 제품의 펌웨어를 교체할 경우, 배터리의 손상이나 과열, 장치 표면의 과열(예: 모터 또는 센서) 또는 기타 위험 요소를 포함하여 예측할 수 없는 결과가 유발될 수 있습니다.

RU
ВНИМАНИЕ! Замена встроенного ПО данного изделия на ПО сторонних поставщиков, не одобренное The LEGO Group, может привести к непредсказуемым последствиям, в том числе к повреждению или перегреву аккумуляторных батарей, перегреву поверхностной элементов (например, моторов или датчиков) и иным потенциально опасным ситуациям.



PL
UWAGA: zastąpienie firmowego oprogramowania w tym produkcji oprogramowaniem, które nie zostało zatwierdzone lub dostarczone przez Grupę LEGO, może przynieść nieprzewidywalne skutki, jak uszkodzenie i przegrzanie baterii, przegrzanie elementów powierzchniowych (np. silników lub czujników) oraz innych niebezpiecznych sytuacji.

CZ
POZOR: Přehrání firmwaru v tomto zařízení firmwarem, který nebyl schválen či dodán společností LEGO Group, může způsobit nepředvídatelné okolnosti, včetně poškození nebo přehřátí baterií, přehřátí povrchu zařízení a jeho částí (např. motorů nebo senzorů), nebo jiná rizika.

SK
VAROVANIE: Nahradenie firmvéru v tomto produkte firmvérom, ktorý neschválila alebo nedodala spoločnosť LEGO Group, môže spôsobiť nepredvídateľné podmienky vrátane poškodenia alebo prehriatia batérií, prehriatia povrchov prvkov (napr. motorov alebo snímačov) alebo iných rizík.

HU
VIGYÁZAT! Ha ennek a terméknek a firmware szoftverét nem jóváhagyott vagy nem a LEGO Csoport által adott firmware-re cserélik ki, akkor ez kiszámíthatatlan állapotokat, többek között az akkumulátor károsodását vagy túlmelegedését, az alkotóelemek (pl. motorok vagy érzékelők) felületének túlmelegedését, vagy más veszélyes helyzeteket okozhat.

UA
ЗАСТЕРЕЖЕННЯ: Заміна мікропрограми продукту на мікропрограми споронніх виробників, не схвалені компанією The LEGO Group, може спричинити непередбачувані наслідки, зокрема пошкодження чи перегрівання батарейок, перегрівання зовнішньої поверхні деталей (наприклад, двигунів чи датчиків) та інші небезпечні ситуації.

HR
OPREZ: Zamjena firmvera u ovom proizvodu firmverom koji nije odobrio ili isporučio LEGO Group može dovesti do nepredvidljivih stanja, uključujući oštećenje ili pregrijavanje baterija, pregrijavanje površina elementa (npr. motora ili senzora) ili drugih opasnosti.

SR
OPREZ: Zamena sistemskog softvera u ovom proizvodu sistemskim softverom koji nije odobrila ili isporučila kompanija The LEGO Group može da dovede do nepredvidljivih uslova, uključujući oštećenje ili pregrejane baterije, pregrejane površine elemenata (npr. motora ili senzora) i drugih opasnosti.

MK
ВНИМАНИЕ: Замената на системскиот софтвер во овој производ со системски софтвер којшто не е одобрен или снабден од страна на LEGO Group може да предизвика непредвидливи услови, вклучувајќи оштетени или прегреани батерији, прегреани површини на елементите (нр. на моторите или сензорите), како и други опасности.

SL
POZOR: Zamenjava strojne programske opreme tega izdelka s strojno programsko opremo, ki je ni odobrila ali dobavila skupina The LEGO Group, lahko povzroči nepredvidljive pogoje, vključno s poškodovanjem ali pregrevanjem baterij, pregrevanjem površin elementov (npr. motorjev ali senzorjev) in druge nevarnosti.

RO
ATENȚIE: Înclocuirea firmware-ului din acest produs cu un firmware neautorizat sau nefurnizat de The LEGO Group poate cauza situații imprevizibile, inclusiv deteriorarea sau supraîncălzirea bateriilor, supraîncălzirea suprafețelor (de ex. la motoare sau senzori), sau alte pericole.

BG
ВНИМАНИЕ: Замяната на фърмуера в този продукт с фърмуер, който не е одобрен или предоставен от LEGO Group, може да доведе до непредсказуеми условия, включително повреда или прегряване на батериите, прегряване на повърхностите на елементите (напр. двигатели или сензори), или до други опасности.

LV
UZMANĪBU! Aizstājot šajā produktā iekļauto aparātprogrammatūru ar tādu aparātprogrammatūru, ko nav apstiprinājis vai piegādājis LEGO Group, var rasties iepriekš neparedzami apstākļi, tostarp akumulatoru bojājums vai pārkaršana, elementu virsmu (piemēram, motoru vai sensoru) pārkaršana vai citi bistami apstākļi.

ET
ETTEVAATUST! Selle toote püsivara asendamine püsivaraga, mis pole LEGO Group poolt heaks kiidetud või tarnitud, võib põhjustada ettearvamatuid olukordi, sealhulgas kahjustusi apstākļi, tostarp akumulatoru bojaajums vai pärkäršana, elementu virsmu (piemēram, motoru vai sensoru) pärkäršana vai citi bistami apstākļi.

LT
ATSARGIA! Šio gaminio programinės aparatinės įrangos pakeitimas LEGO Group nepatvirtinta arba netiekiama programine aparatine įranga gali lemti nenumatytas pasekmes, pvz., gali sugesti arba perkaisti baterijas, perkaisti komponentų (pvz., variklių arba jutiklių) paviršiai arba kilti kitų pavojų.

TR
UYARI: Bu üründeki aygıt yazılımının LEGO Group tarafından onaylanmamış ya da sağlanmamış aygıt yazılımıyla değiştirilmesi, pillerin hasar görmesi ya da aşırı ısınması, eleman yüzeylerinin aşırı ısınması (örn. motorlar veya sensörler) ya da başka tehlikeler dahil öngörülemez koşullara neden olabilir.

AR
تنبيه: قد يتسبب استبدال البرنامج الثابت في هذا المنتج ببرنامج ثابت لم تعتمده مجموعة LEGO أو توفره إلى ظهور حالات غير متوقعة، بما في ذلك تلف البطاريات أو زيادة سخونتها، أو زيادة سخونة أسطح المكونات (مثل المحركات أو المستشعرات)، أو غيرها من الأخطار.

ID



HATI-HATI: Mengganti firmware dalam produk ini dengan firmware yang belum disetujui atau tidak dipasok oleh LEGO Group dapat mengakibatkan kondisi yang tak terduga, seperti baterai rusak atau kepanasan, permukaan elemen (misalnya motor atau sensor) kepanasan, atau bahaya lainnya.

MS

PERINGATAN: Penggantian perisian tegar dalam produk ini dengan perisian tegar yang tidak diluluskan atau dibekalkan oleh The LEGO Group mungkin mengakibatkan keadaan luar jangkauan, termasuk kerosakan bateri atau bateri terlampau panas, permukaan elemen terlampau panas (seperti motor atau sensor), atau bahaya lain.

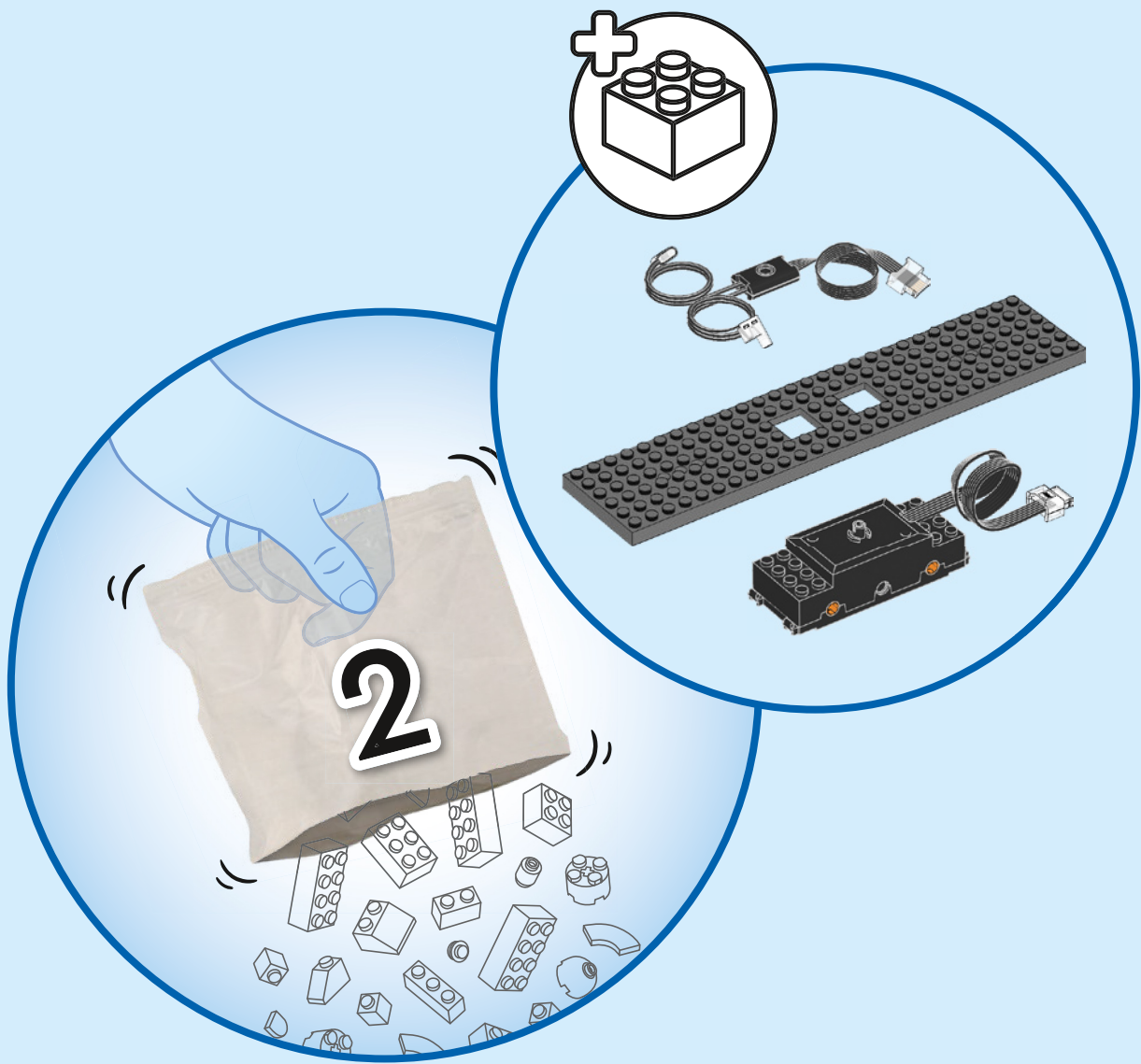

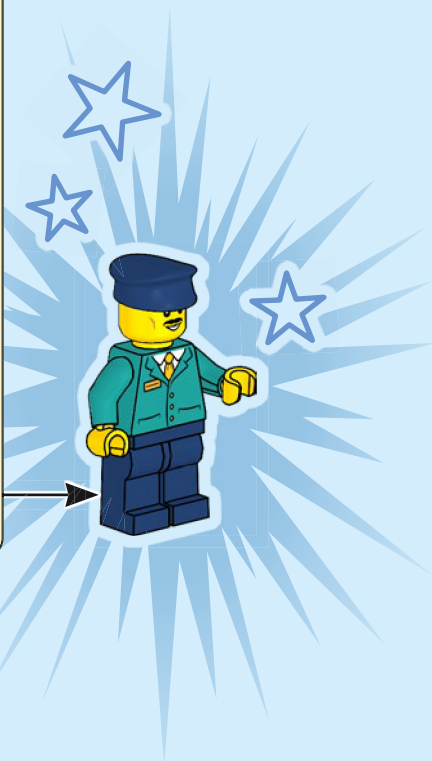
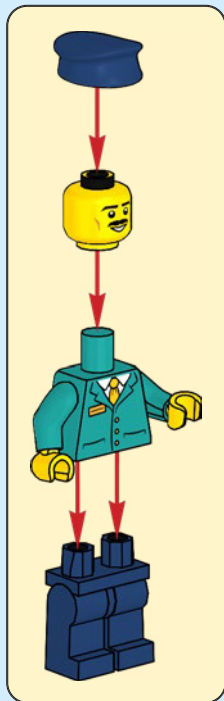

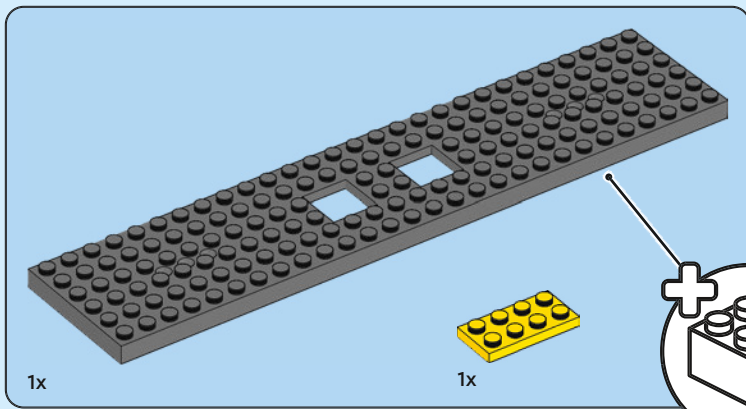

1

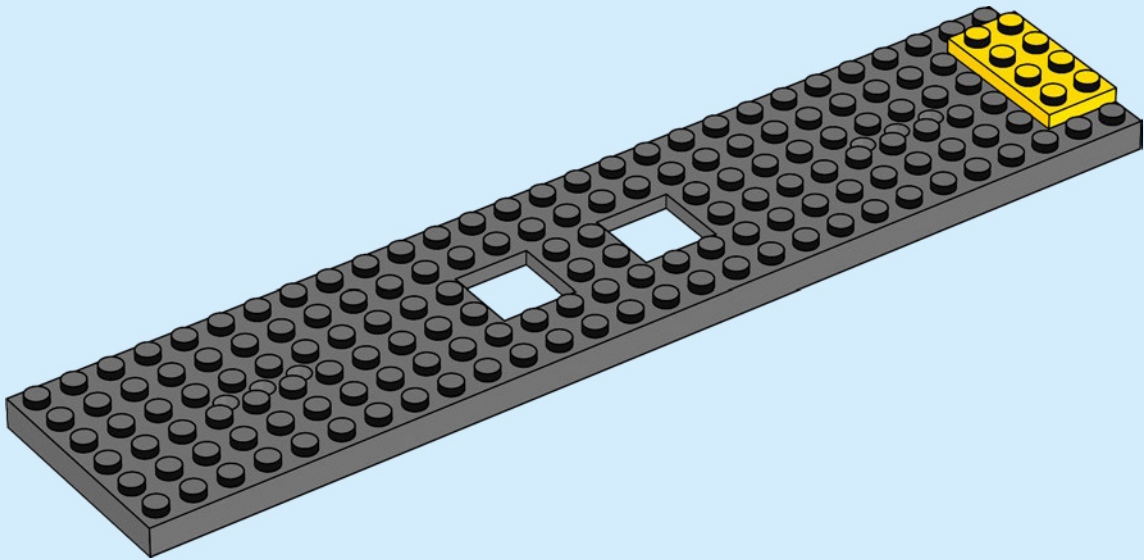

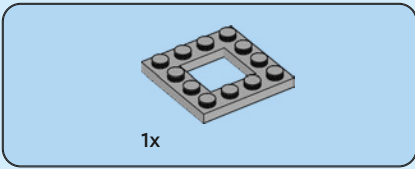

2

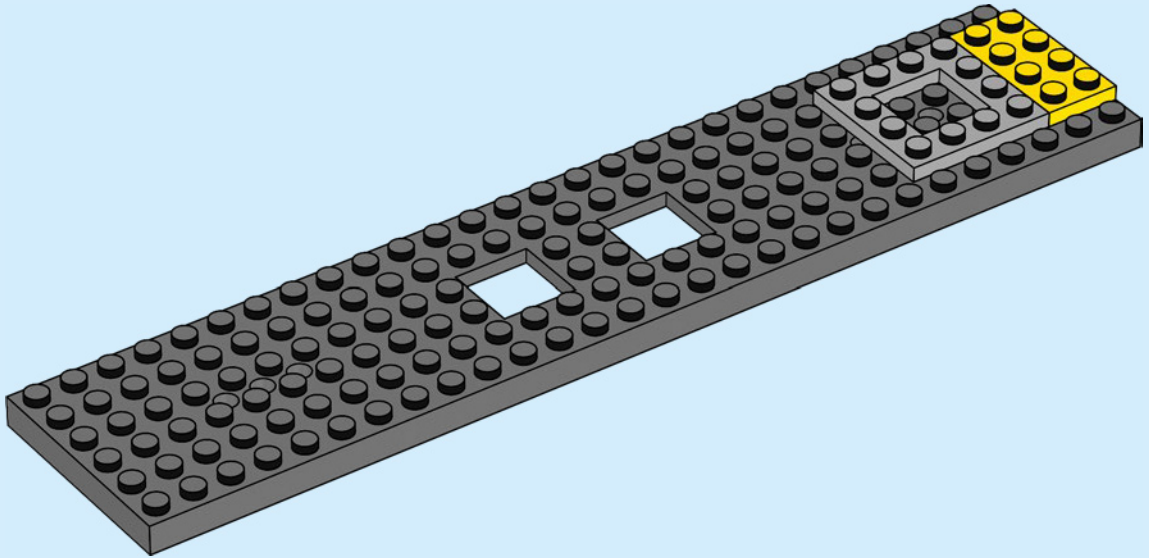

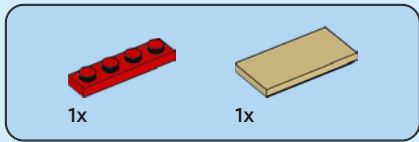

3

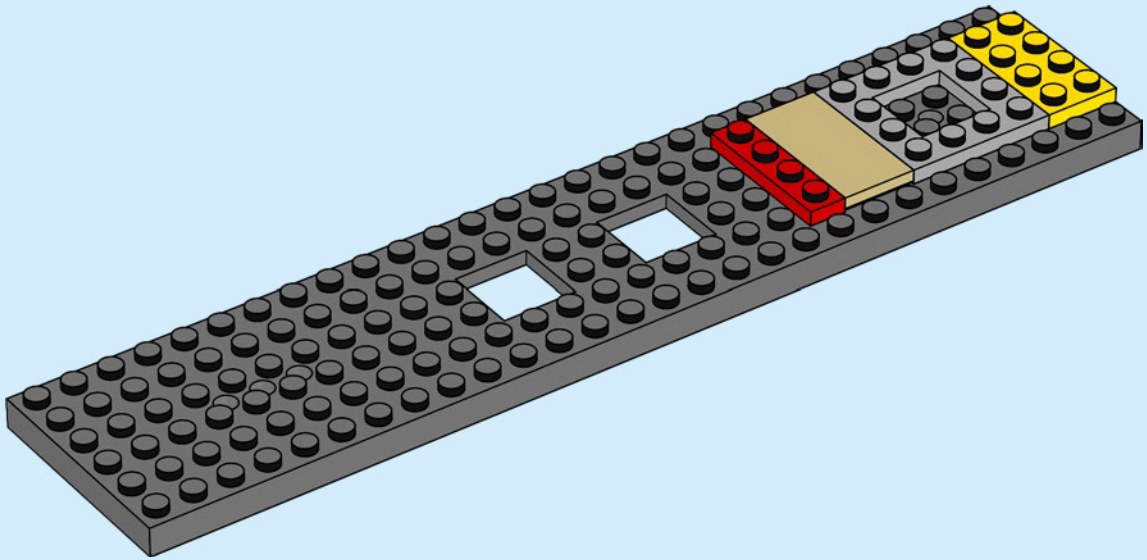

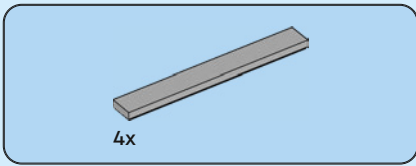

4

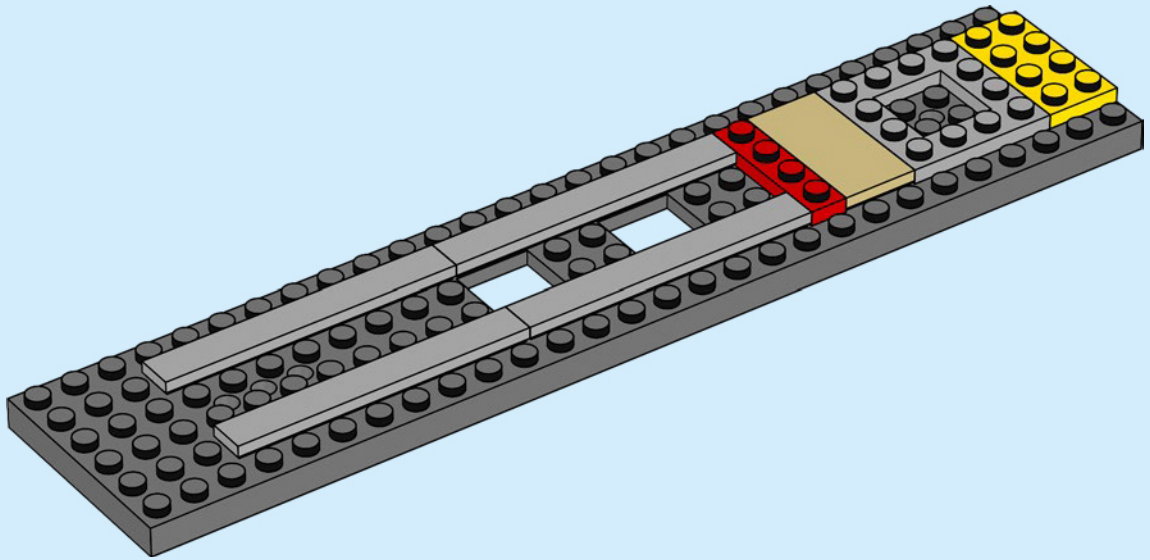



1x

5

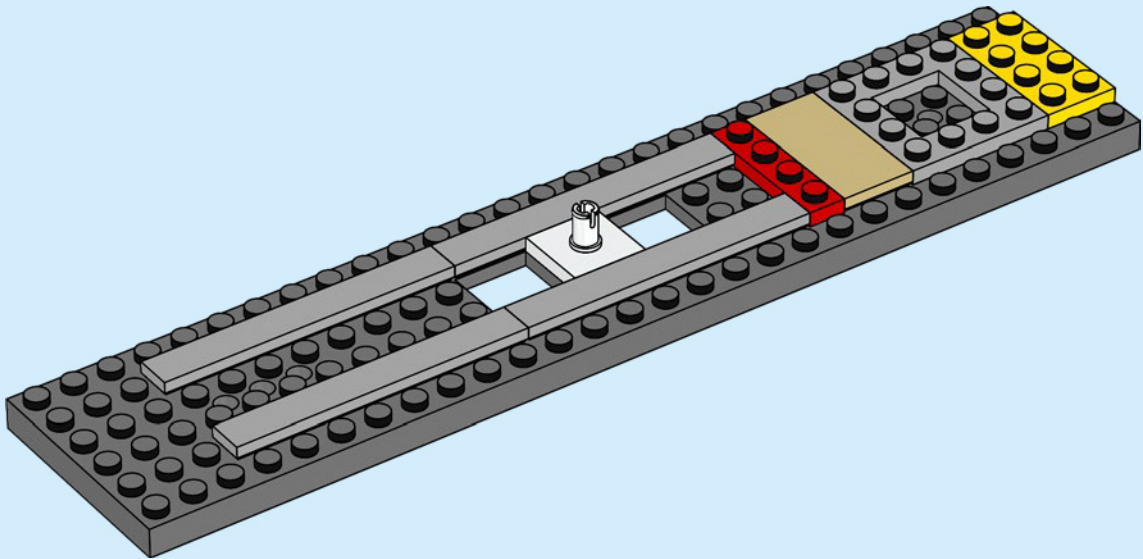



2x

6

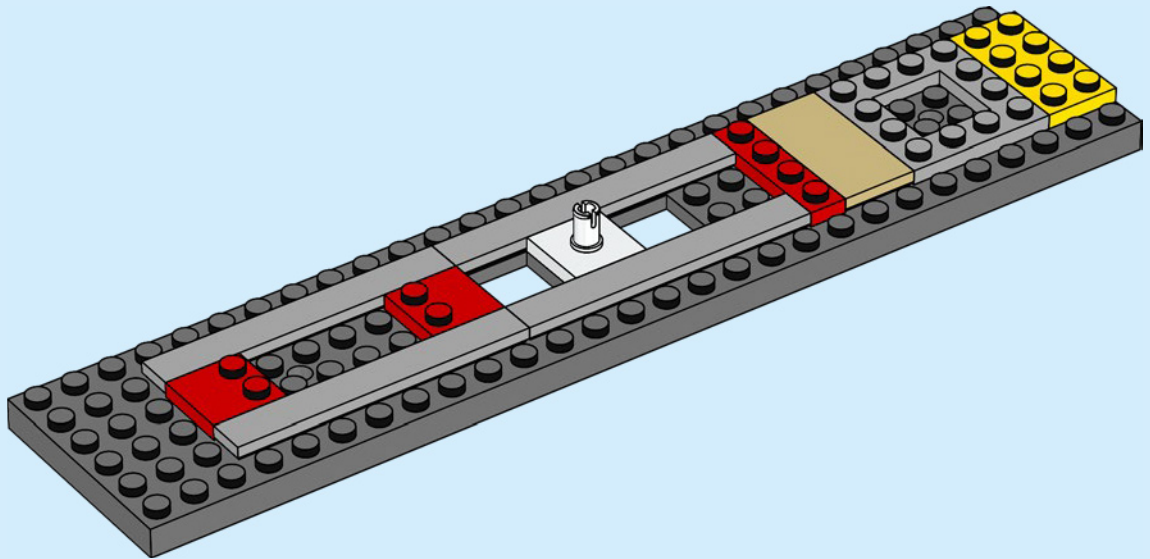



2x

7

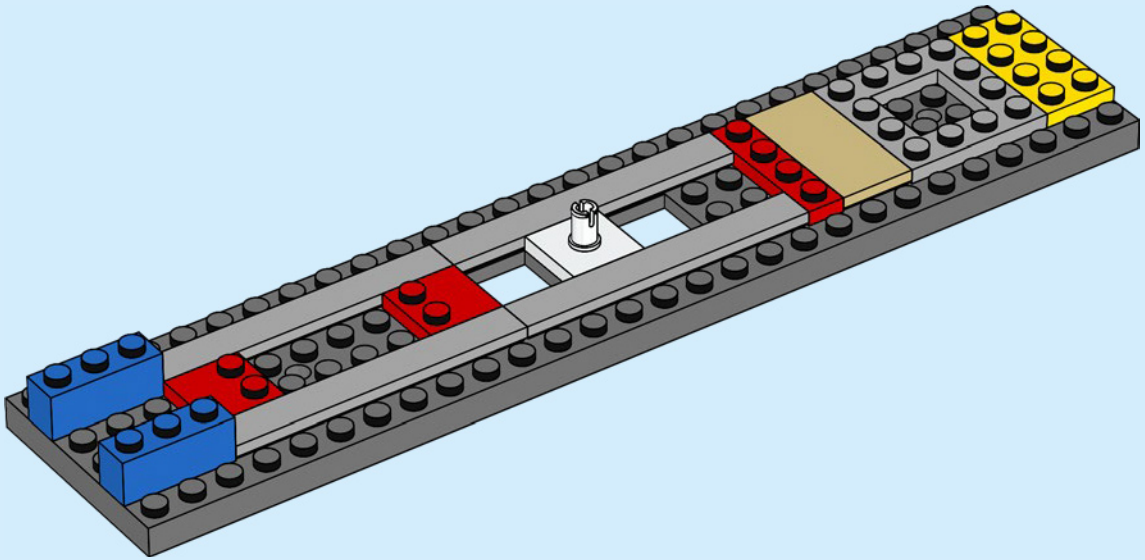

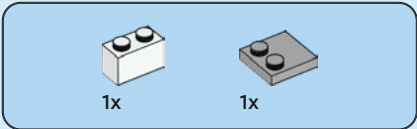

8

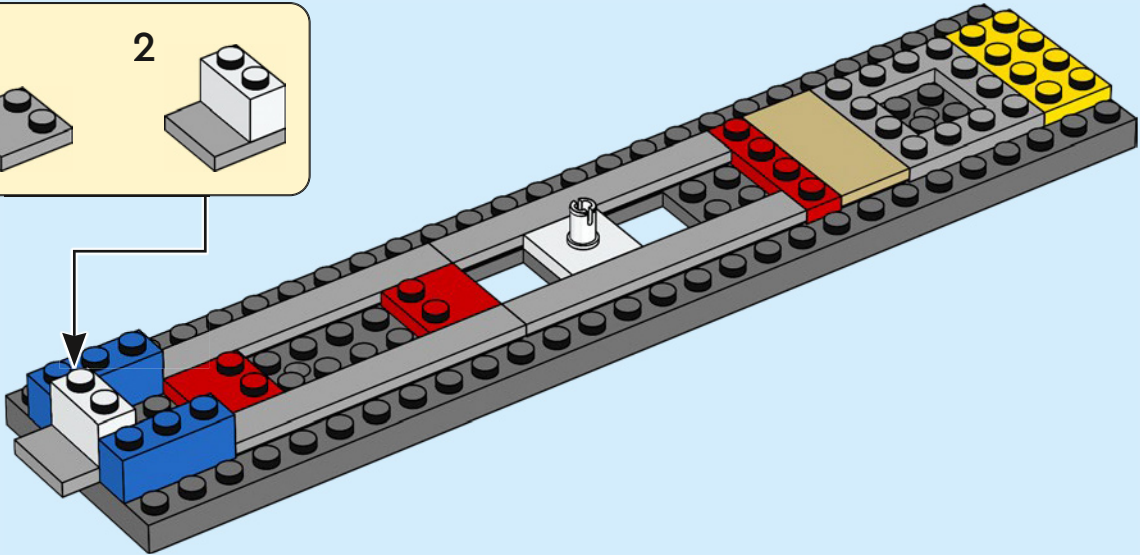
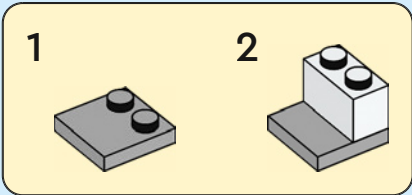

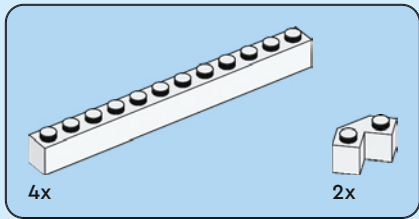

9

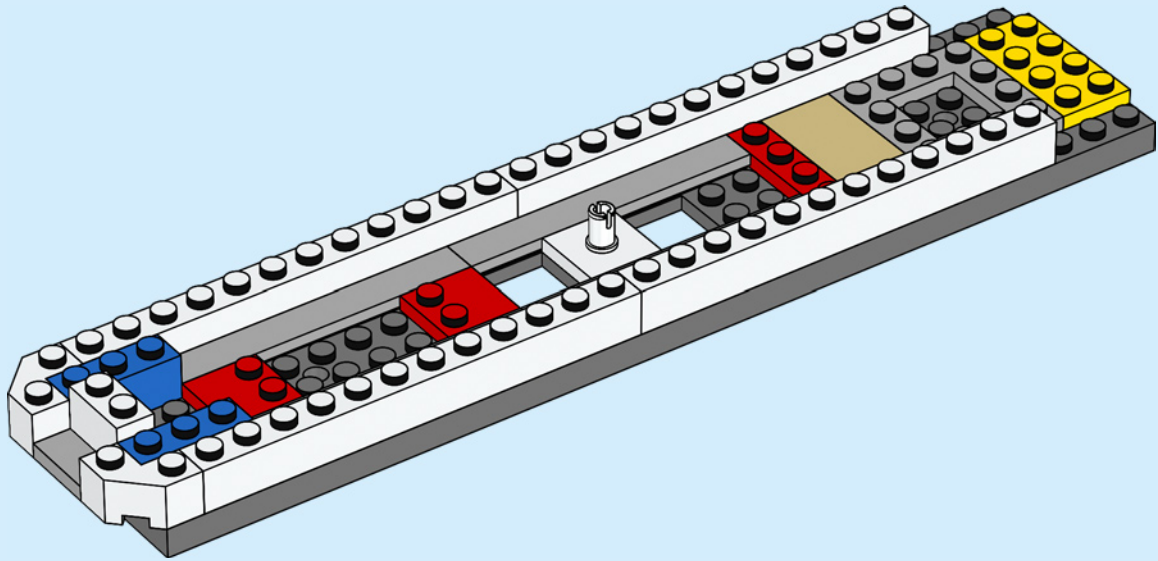

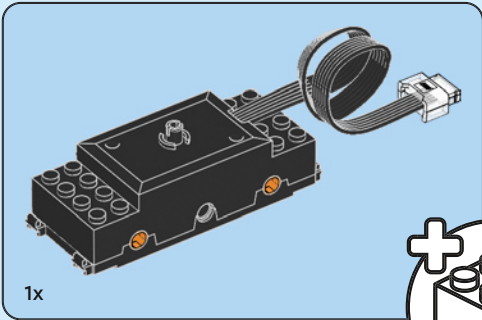
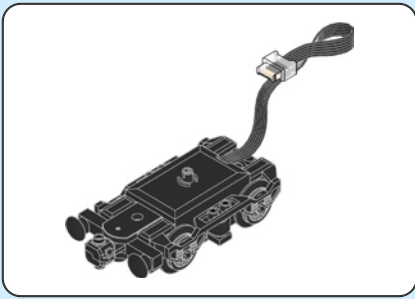

1x

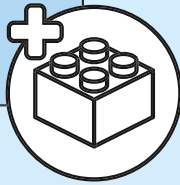

10

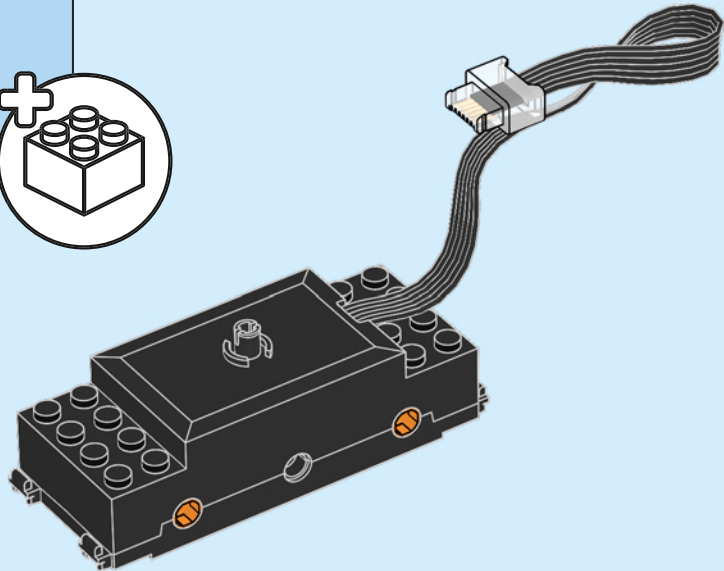

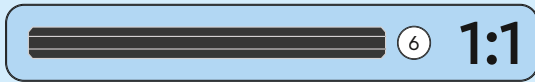
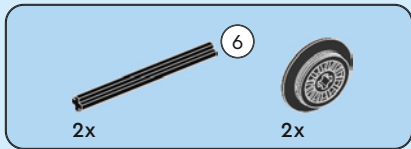

11

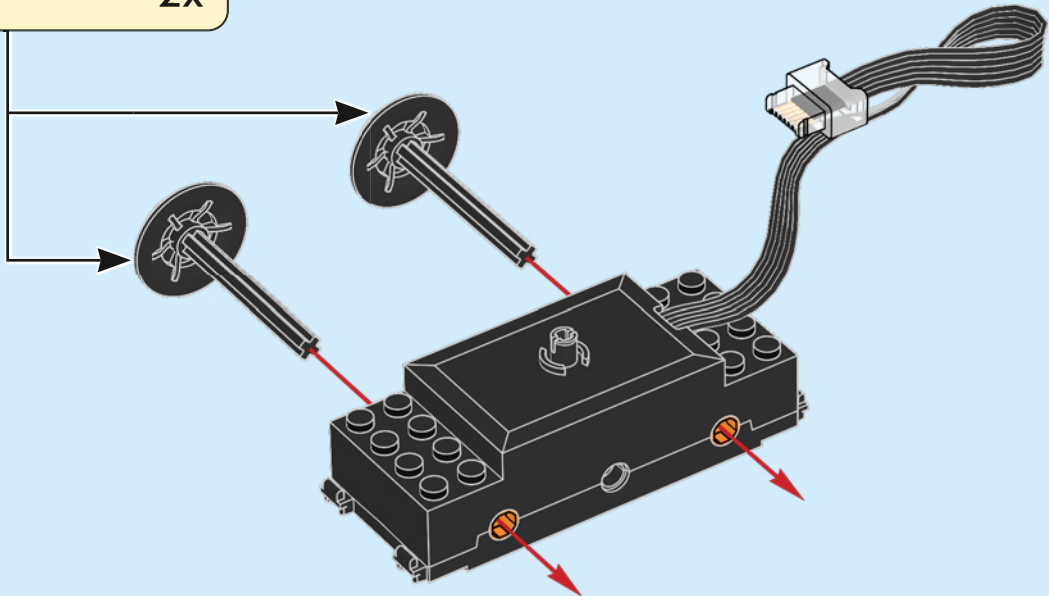



2x

12

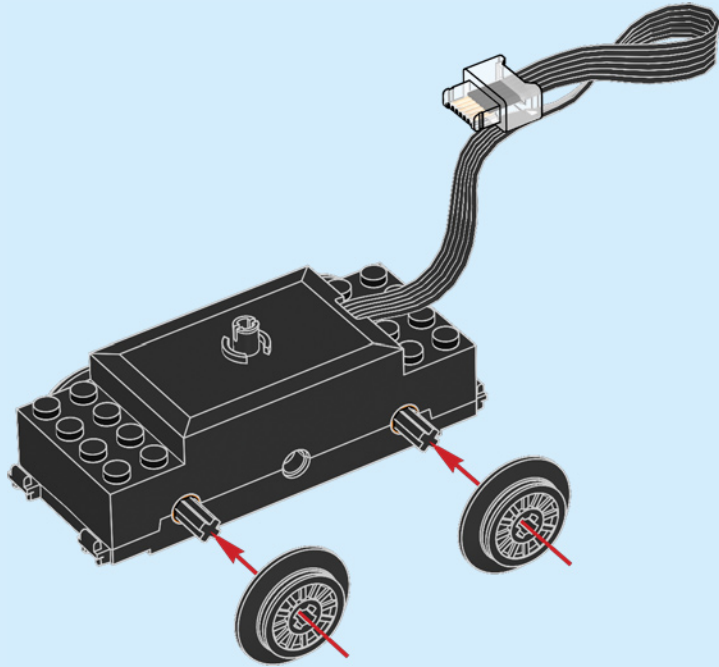

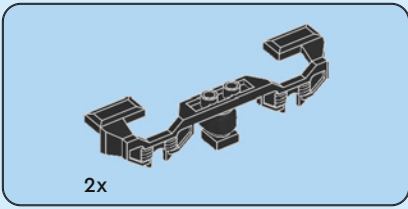

13

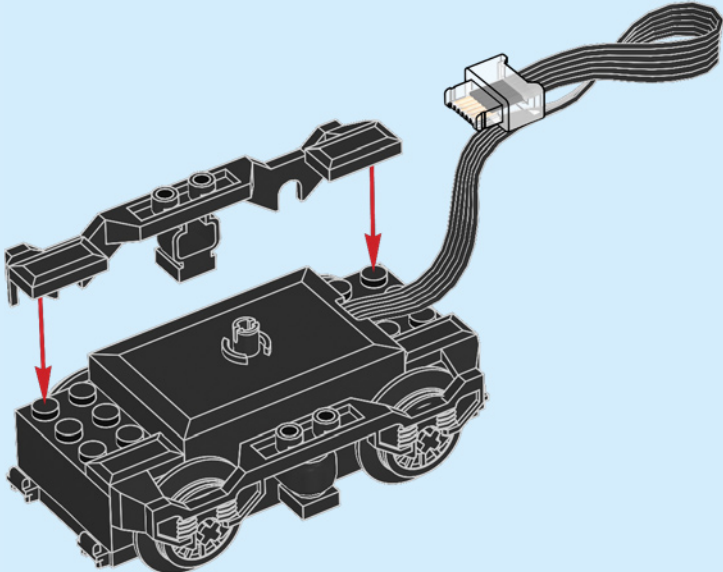

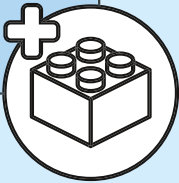
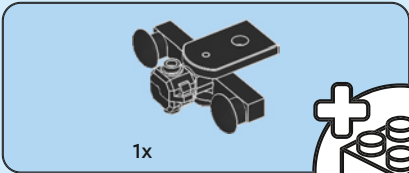

14

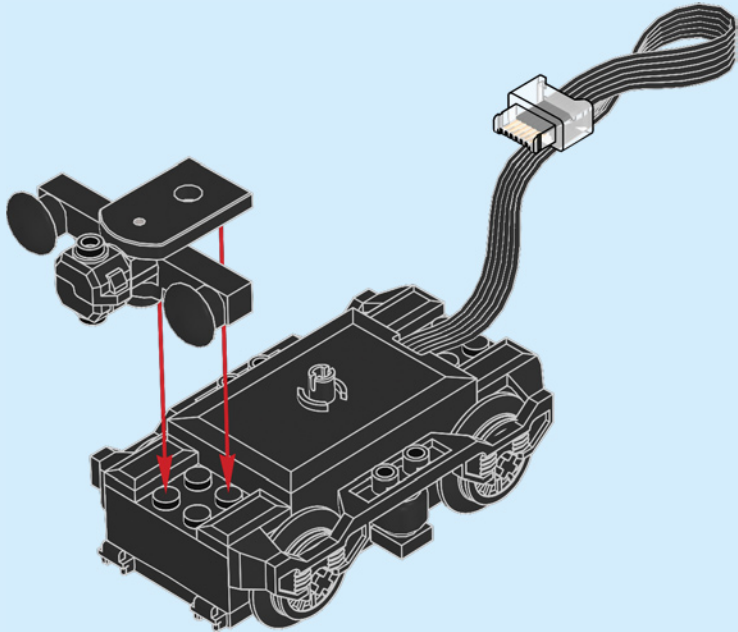

15

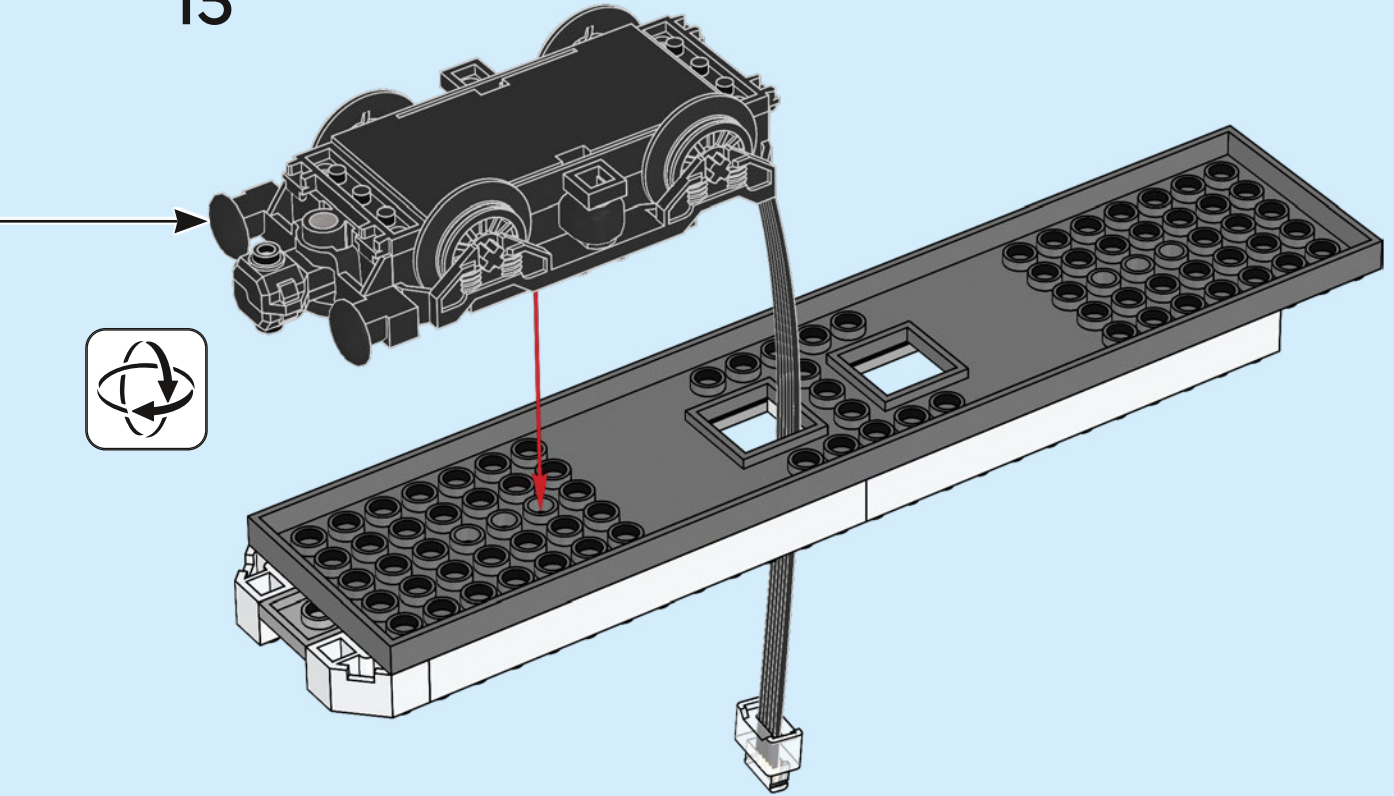

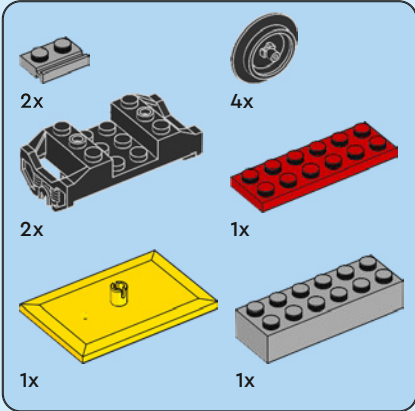
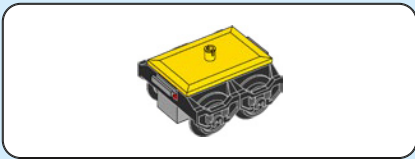

16

1

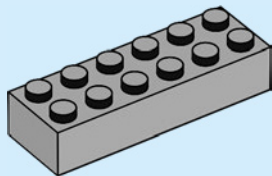

2

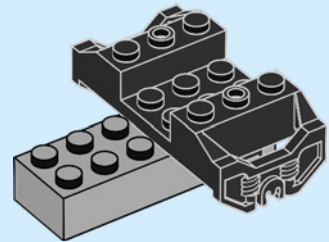

3

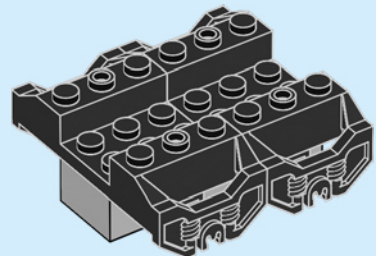

4

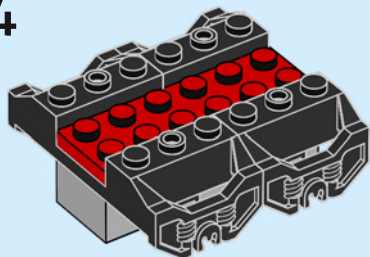

5

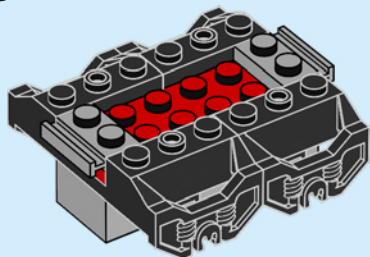

6

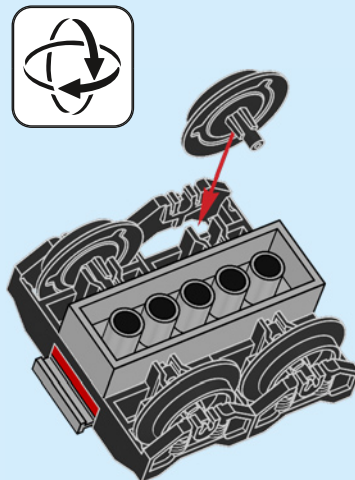

7

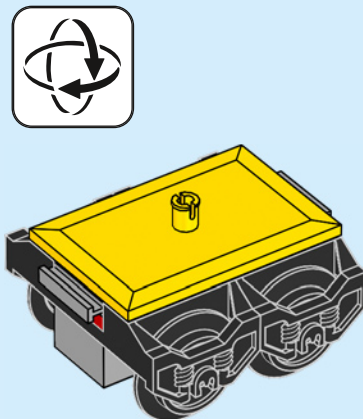

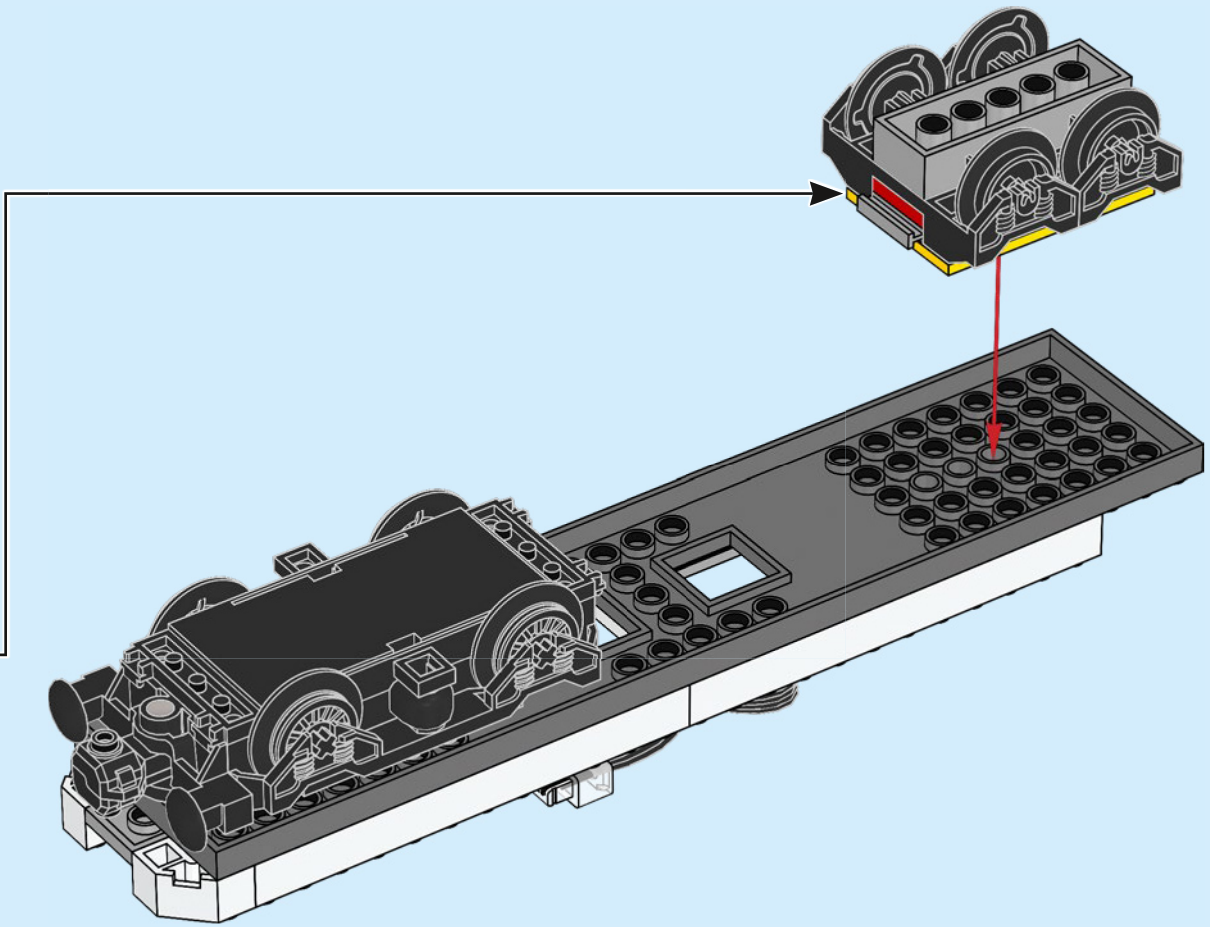

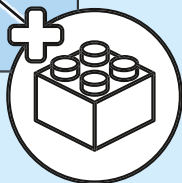
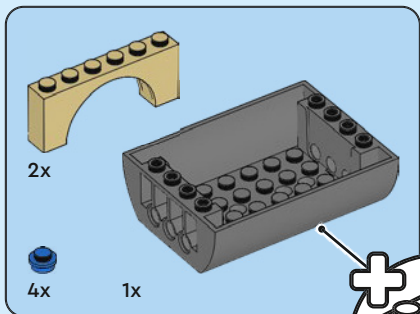

17

1

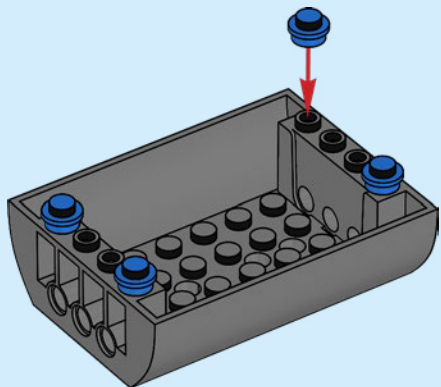

2

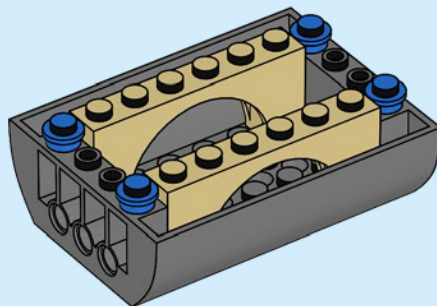

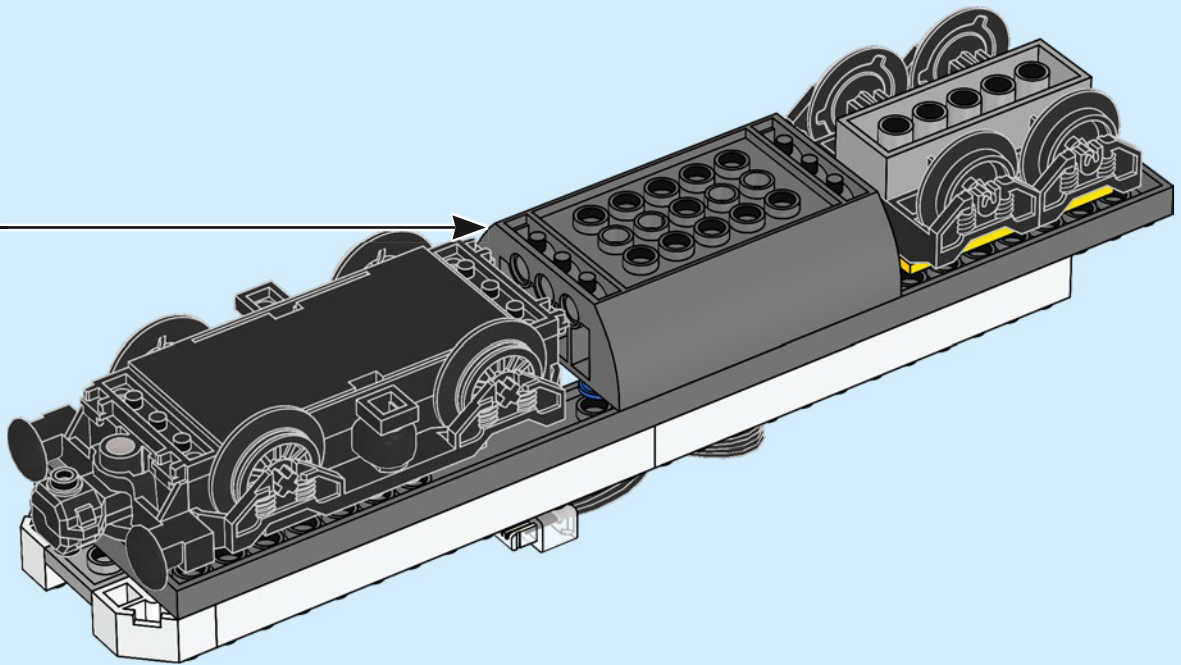

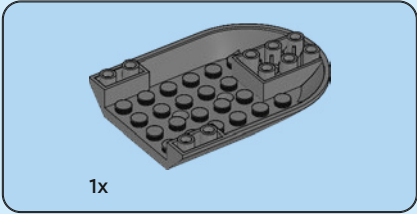
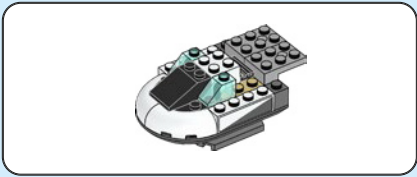

18

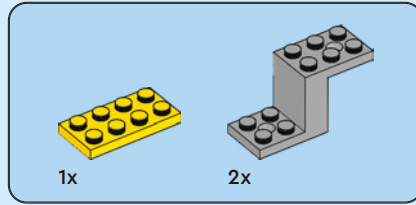
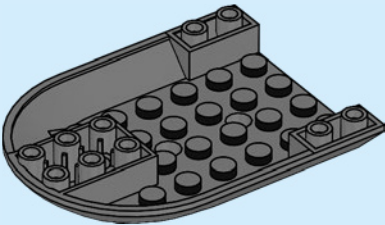

19

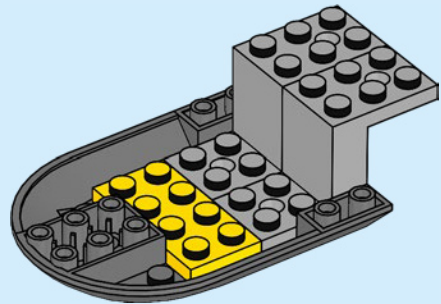

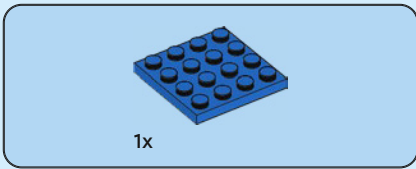

20

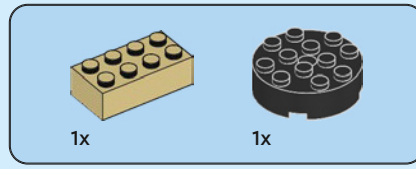
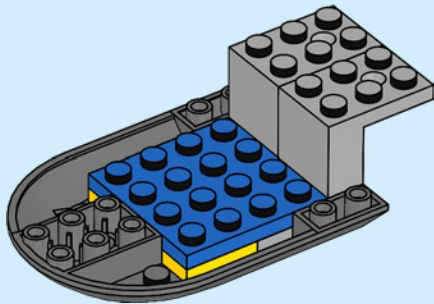

21

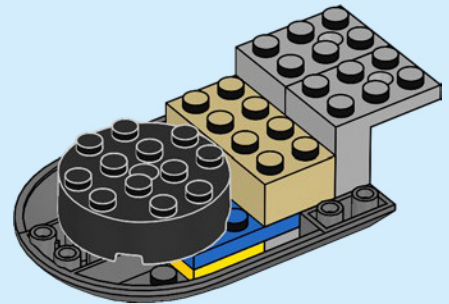

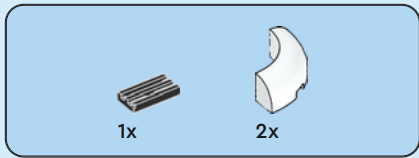

22

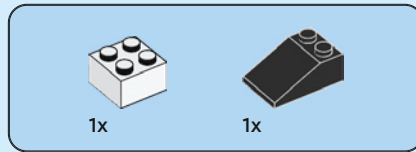
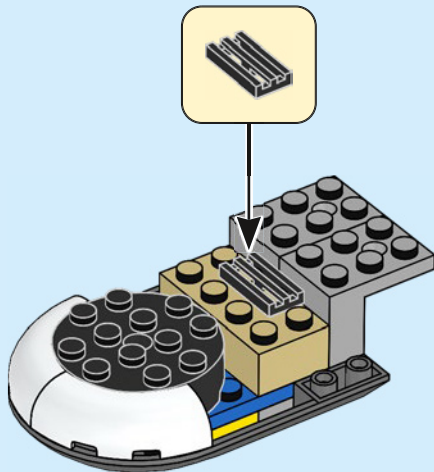

23

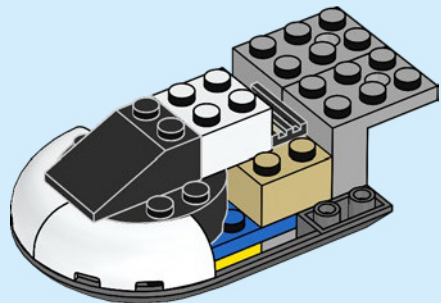

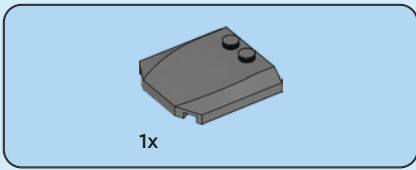

24

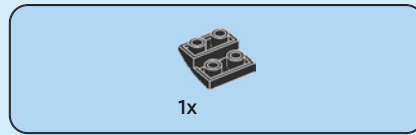
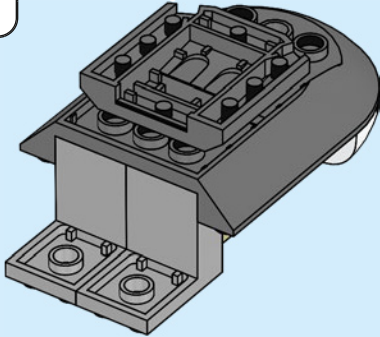
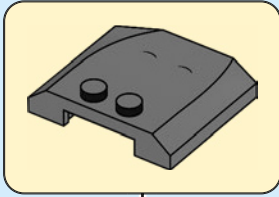

25

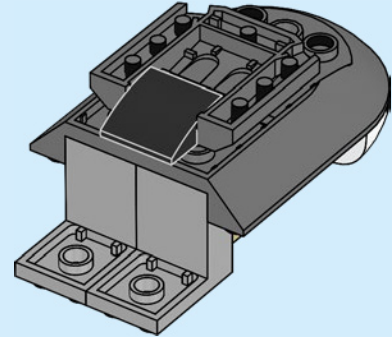



2x

26

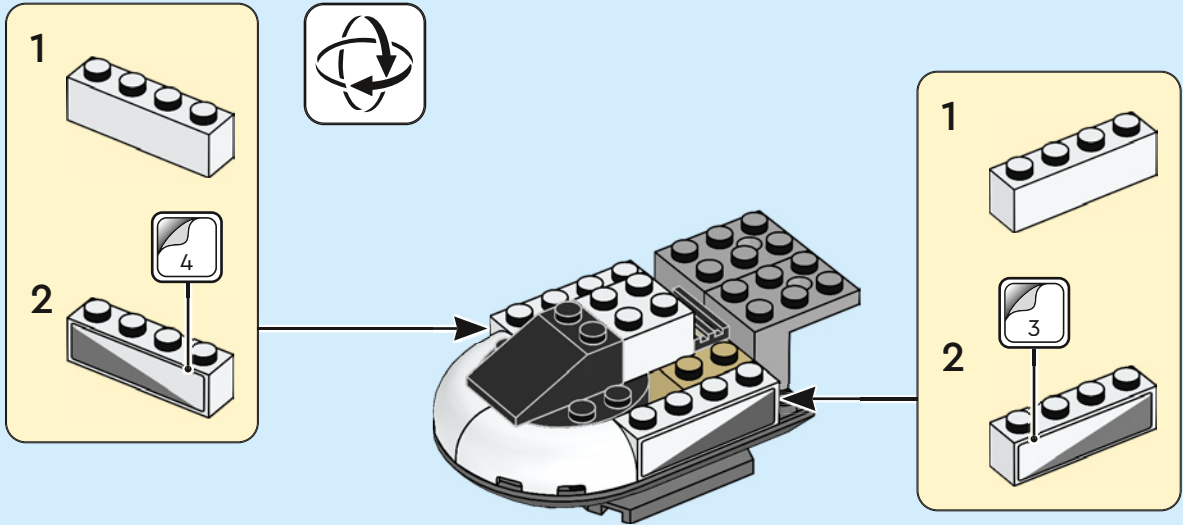



2x

27

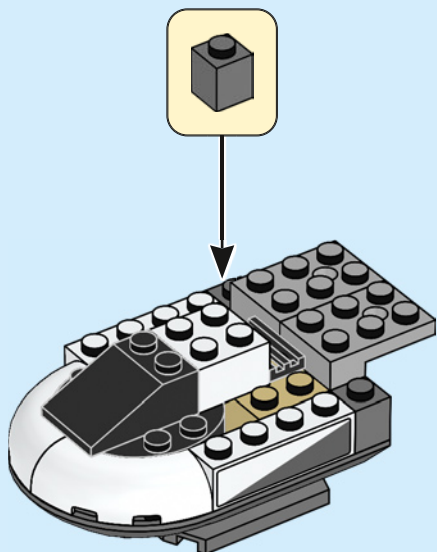

2x

28

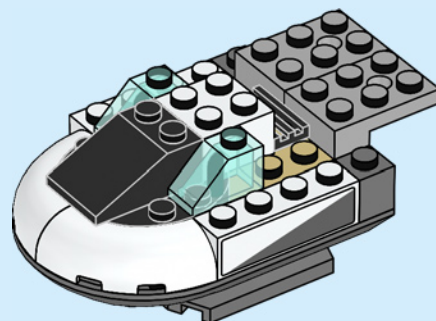

29

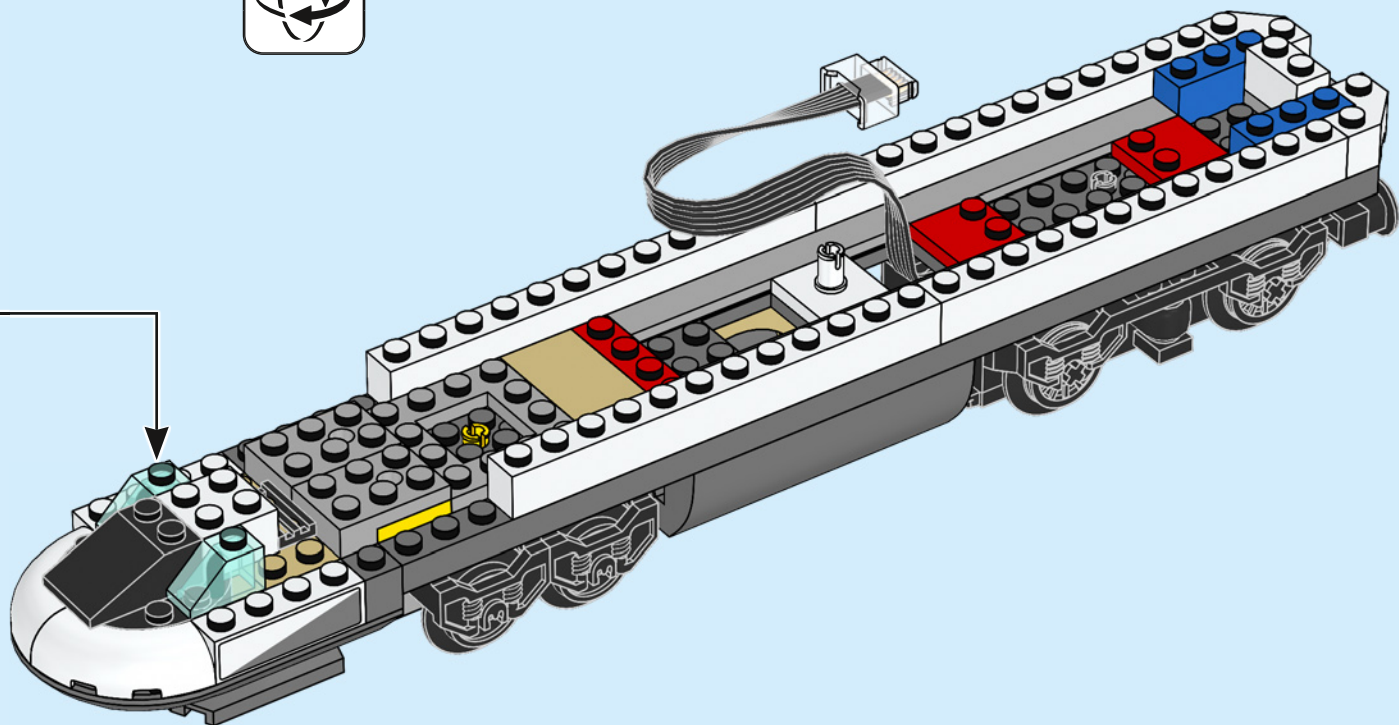

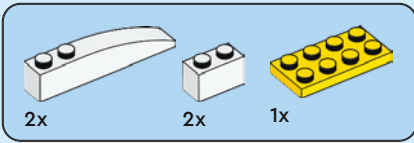

30

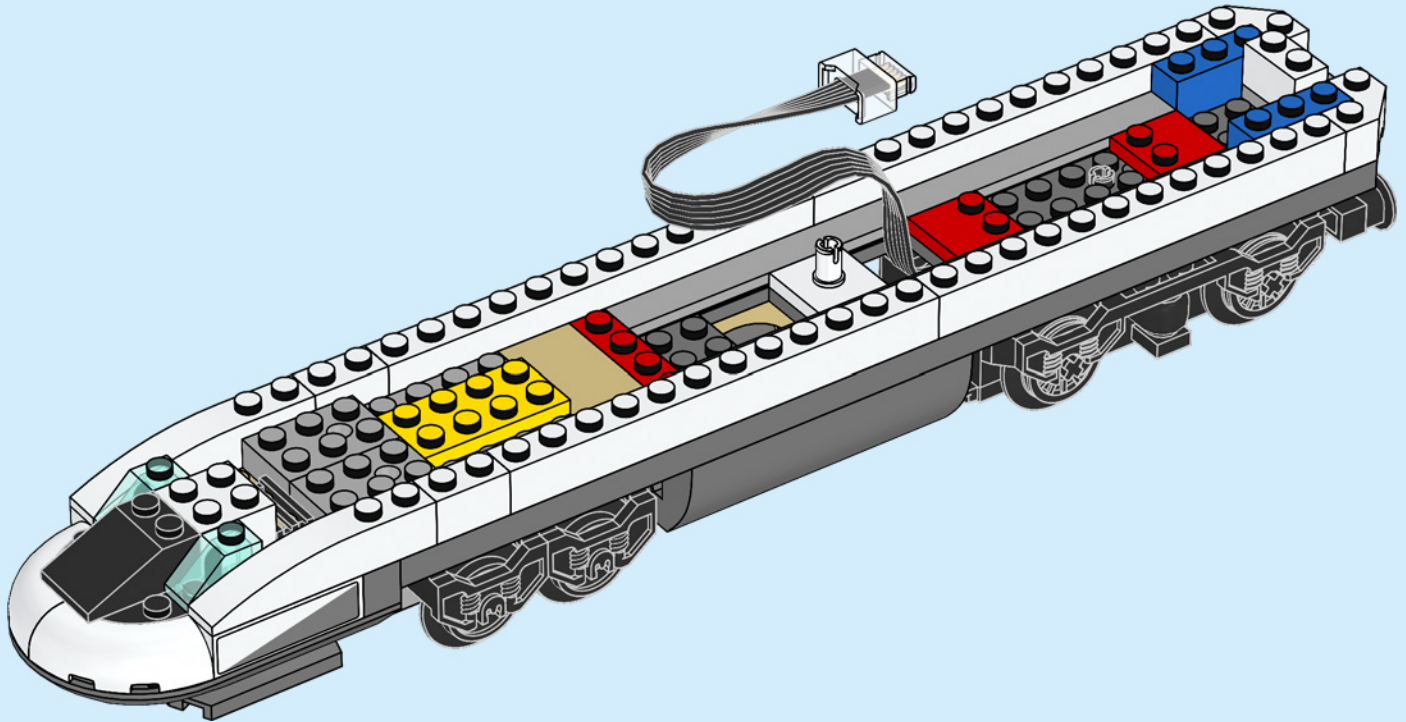

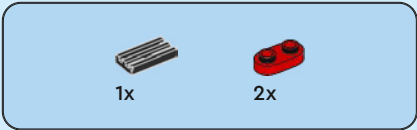

31

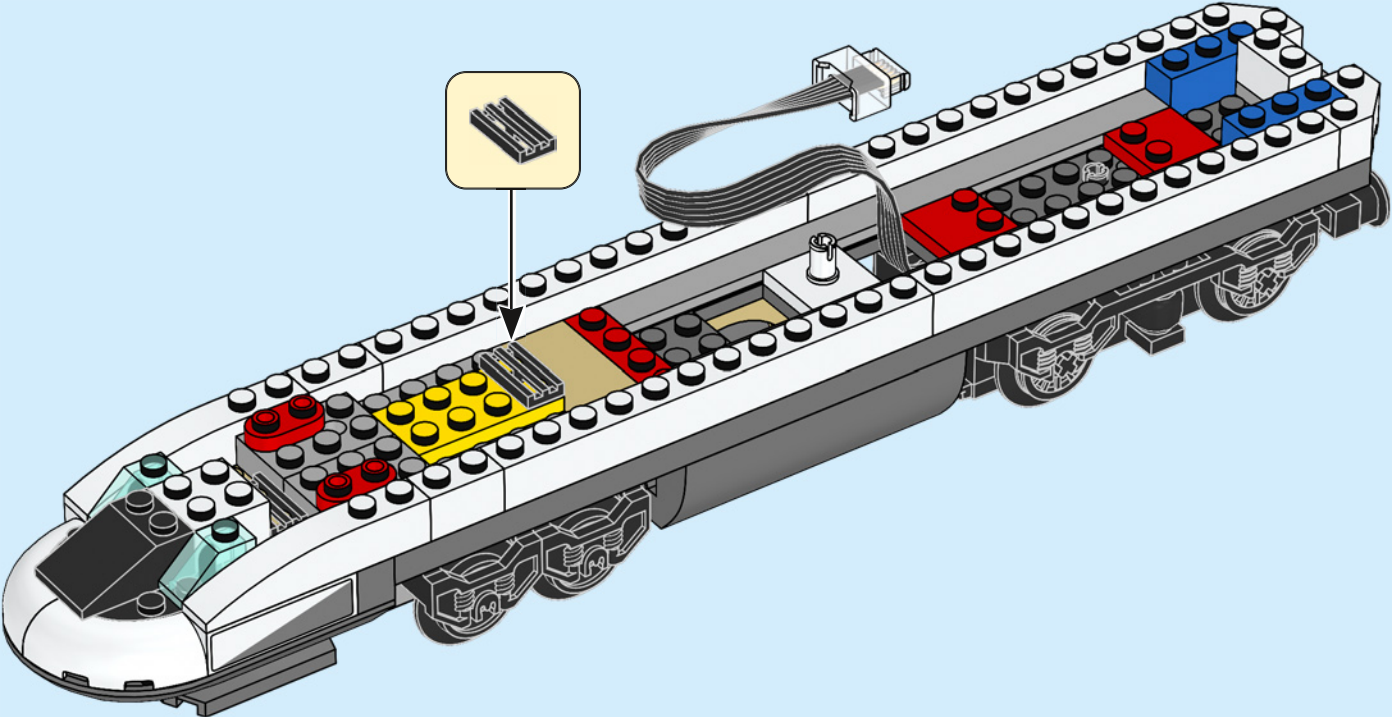

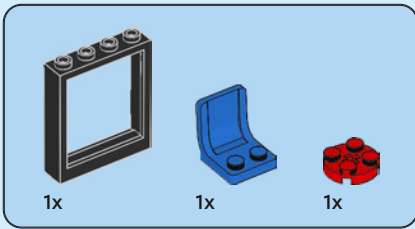

32

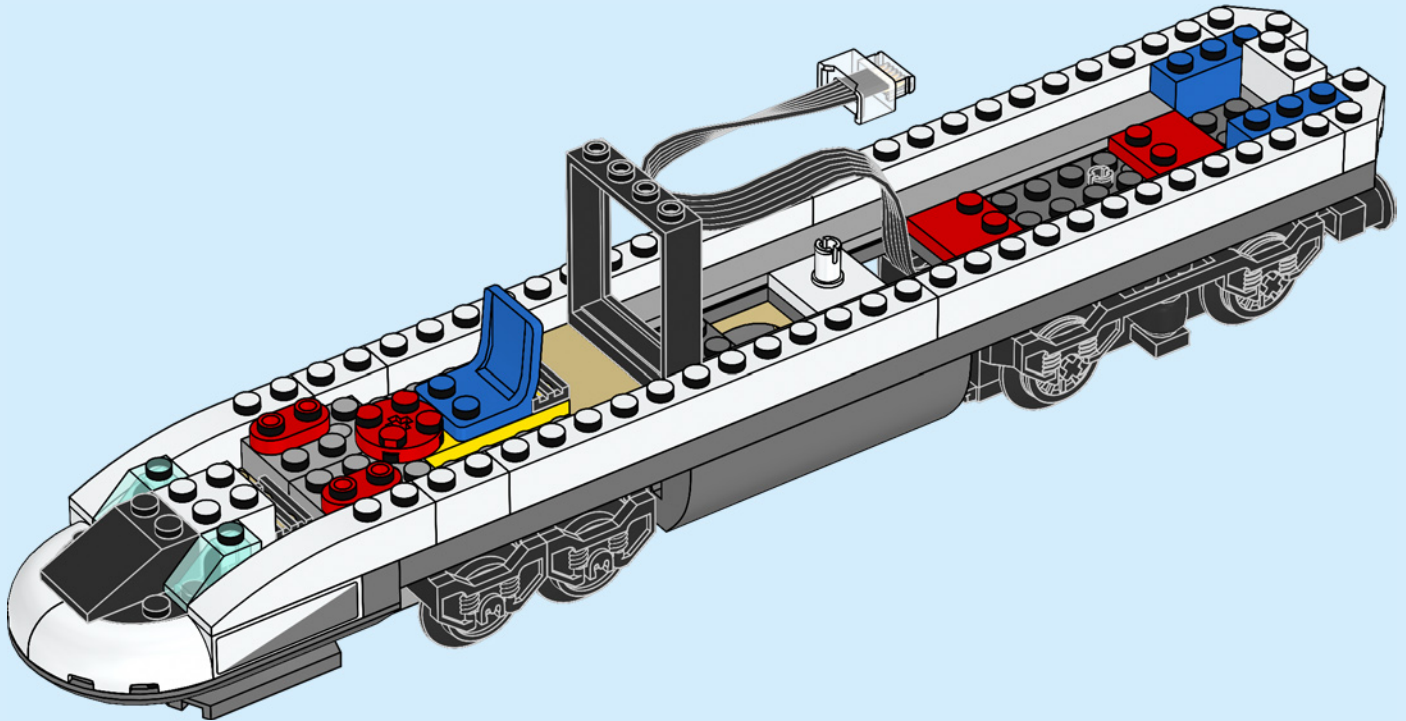

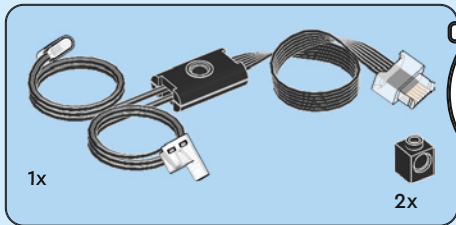

33

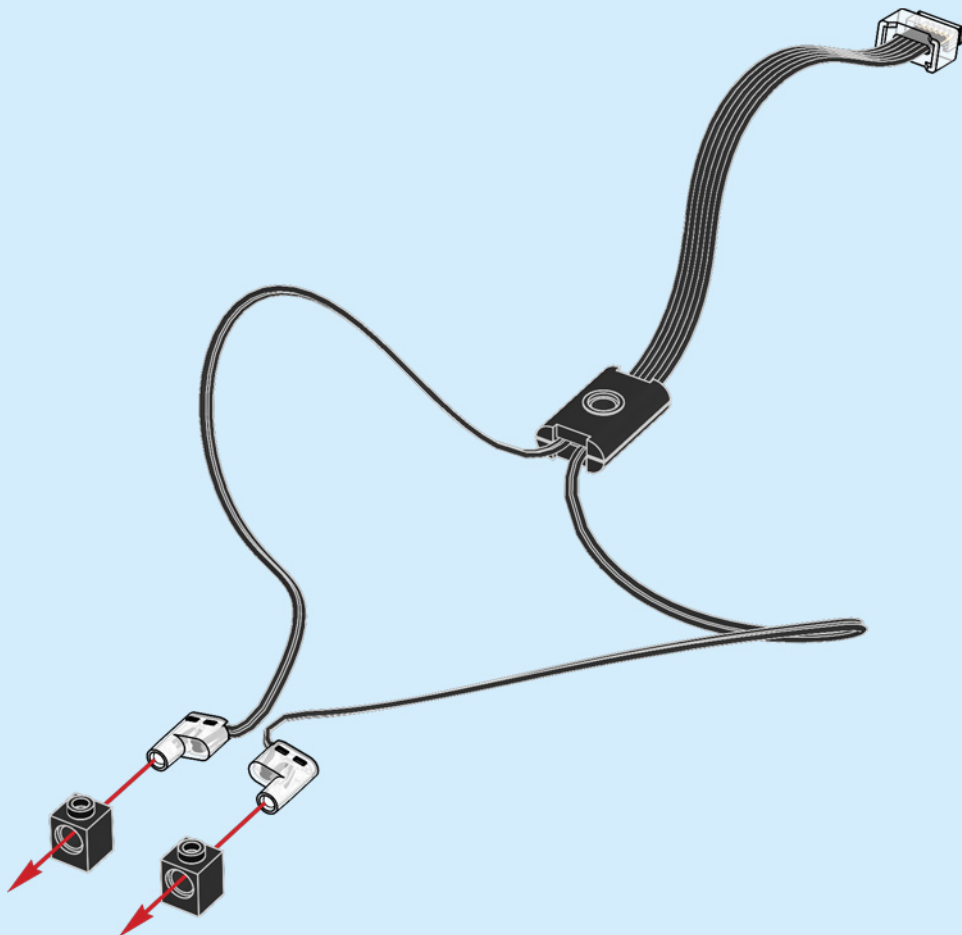

34

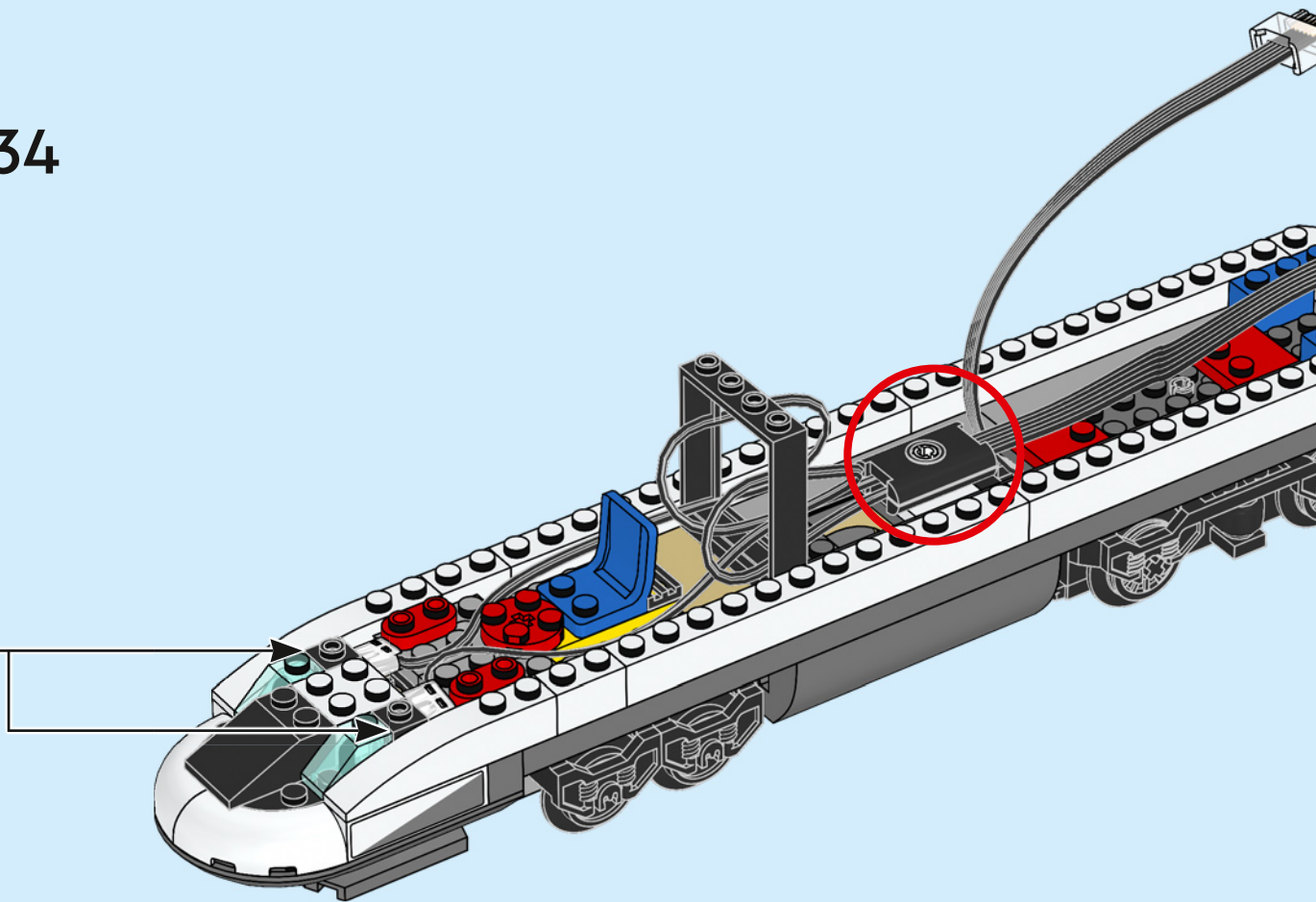

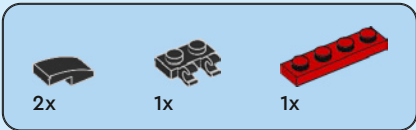

35

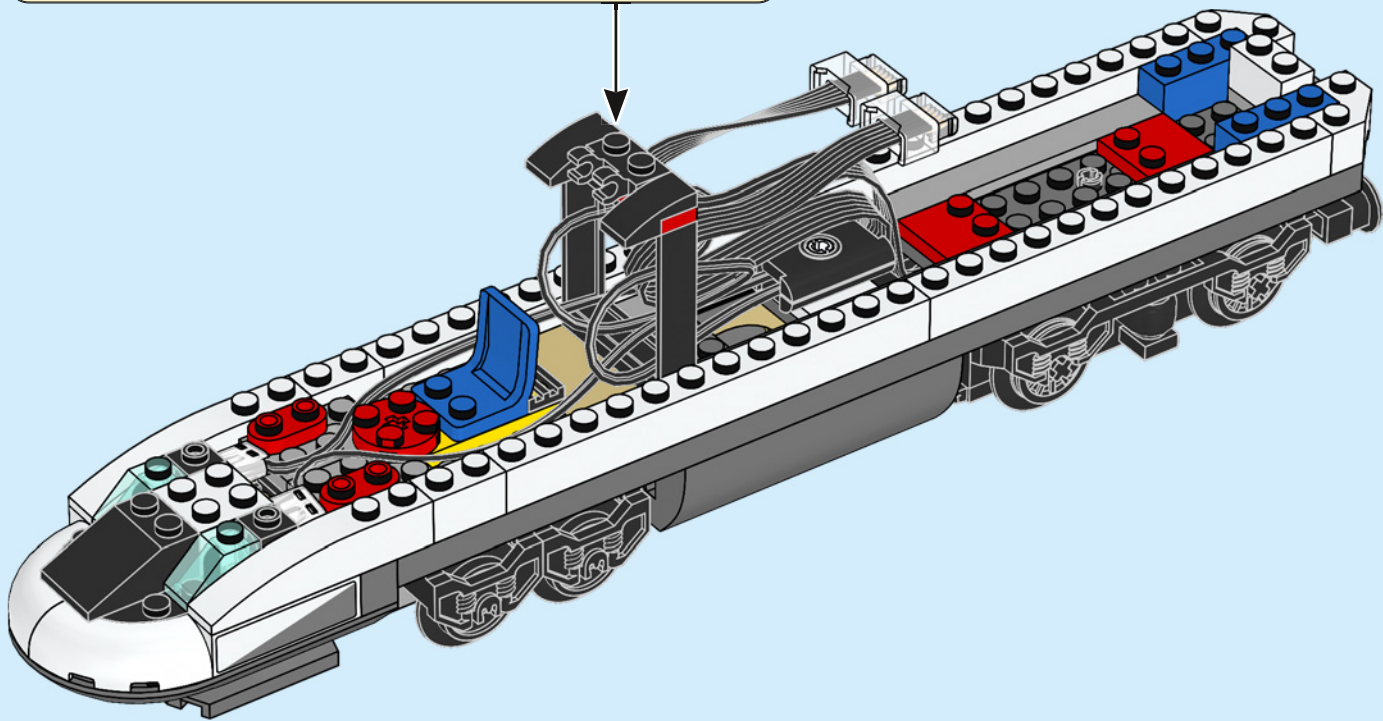
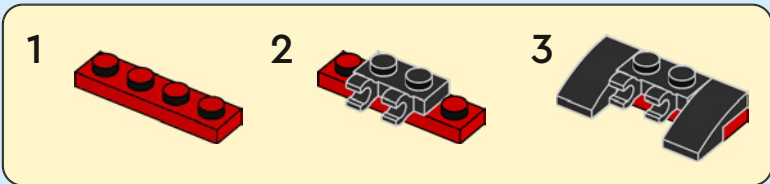

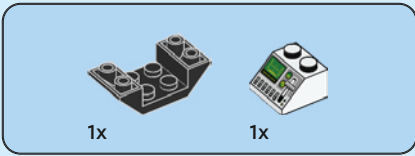

36

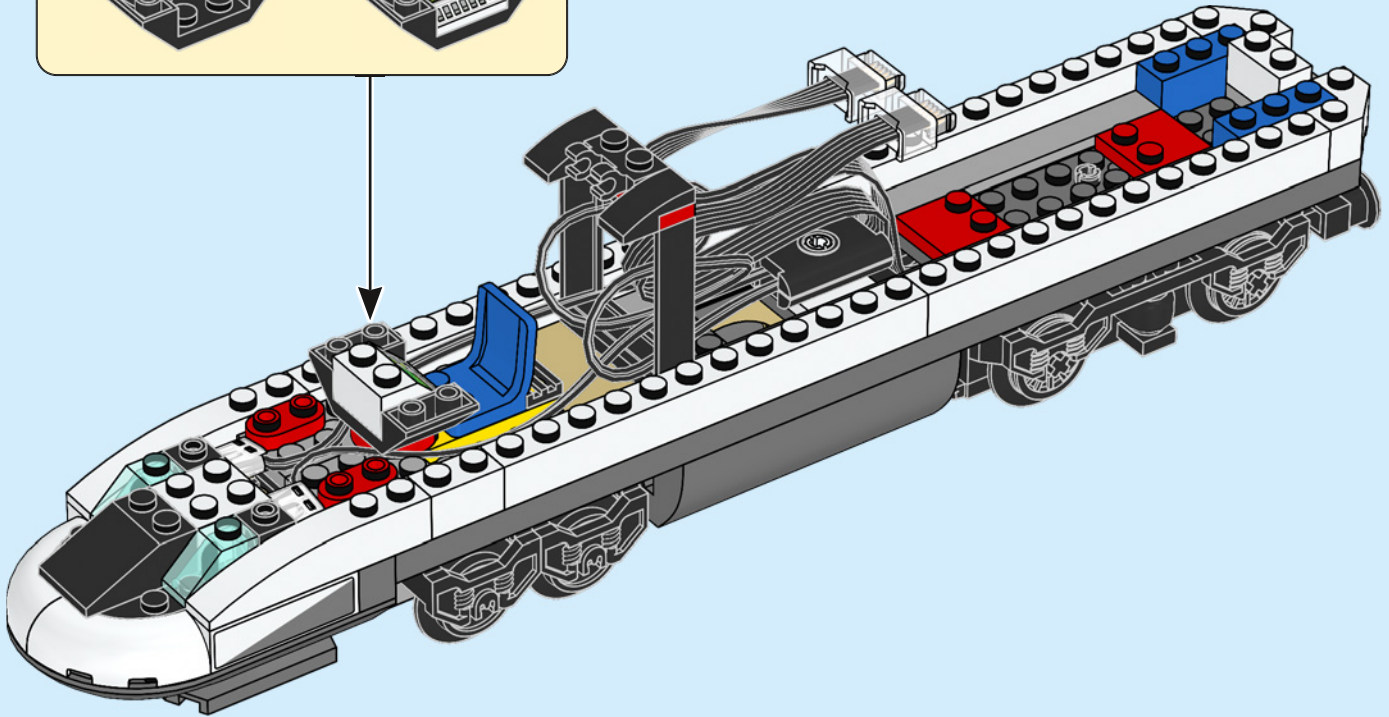
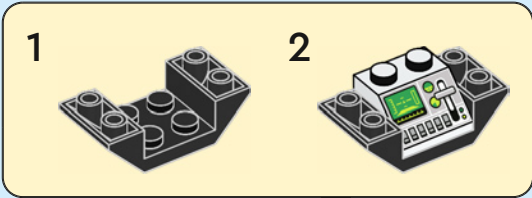

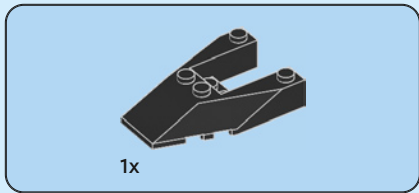

37

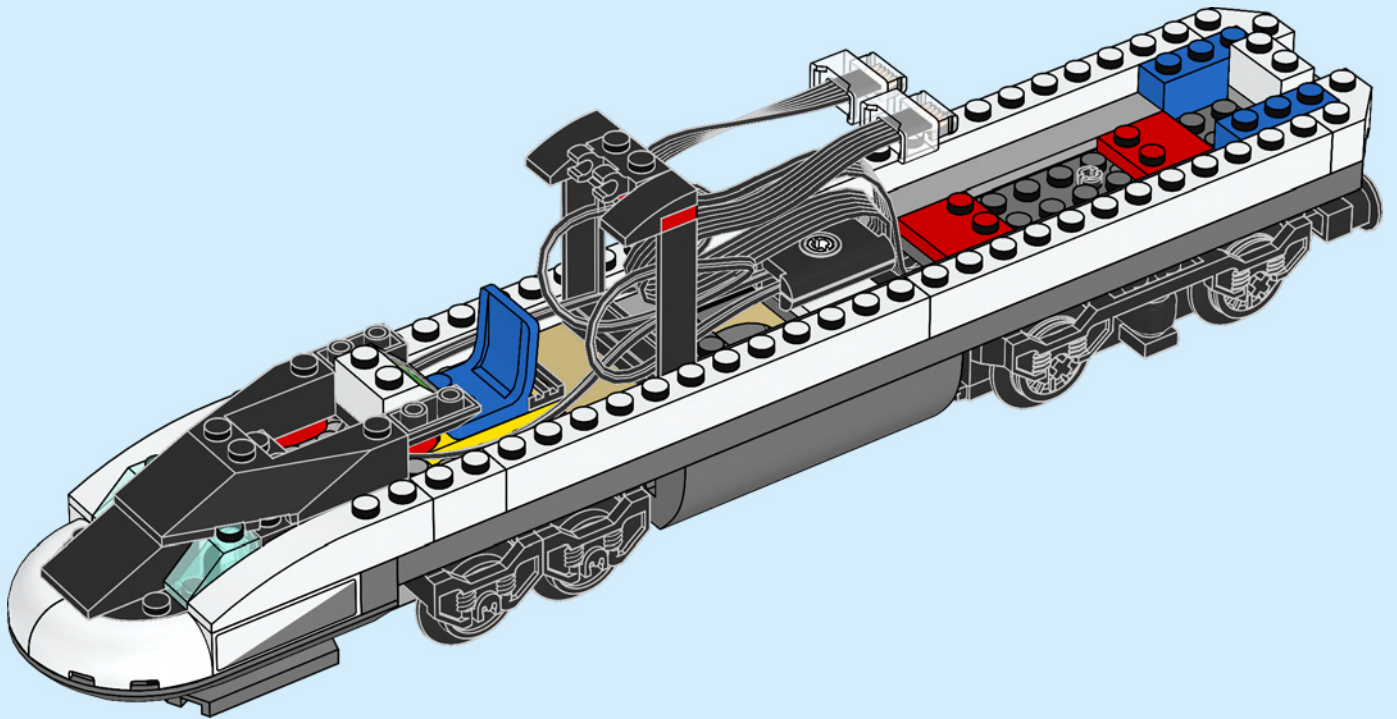

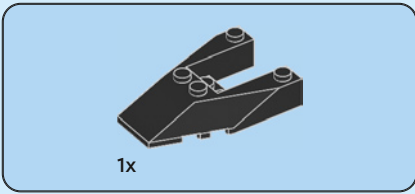

38

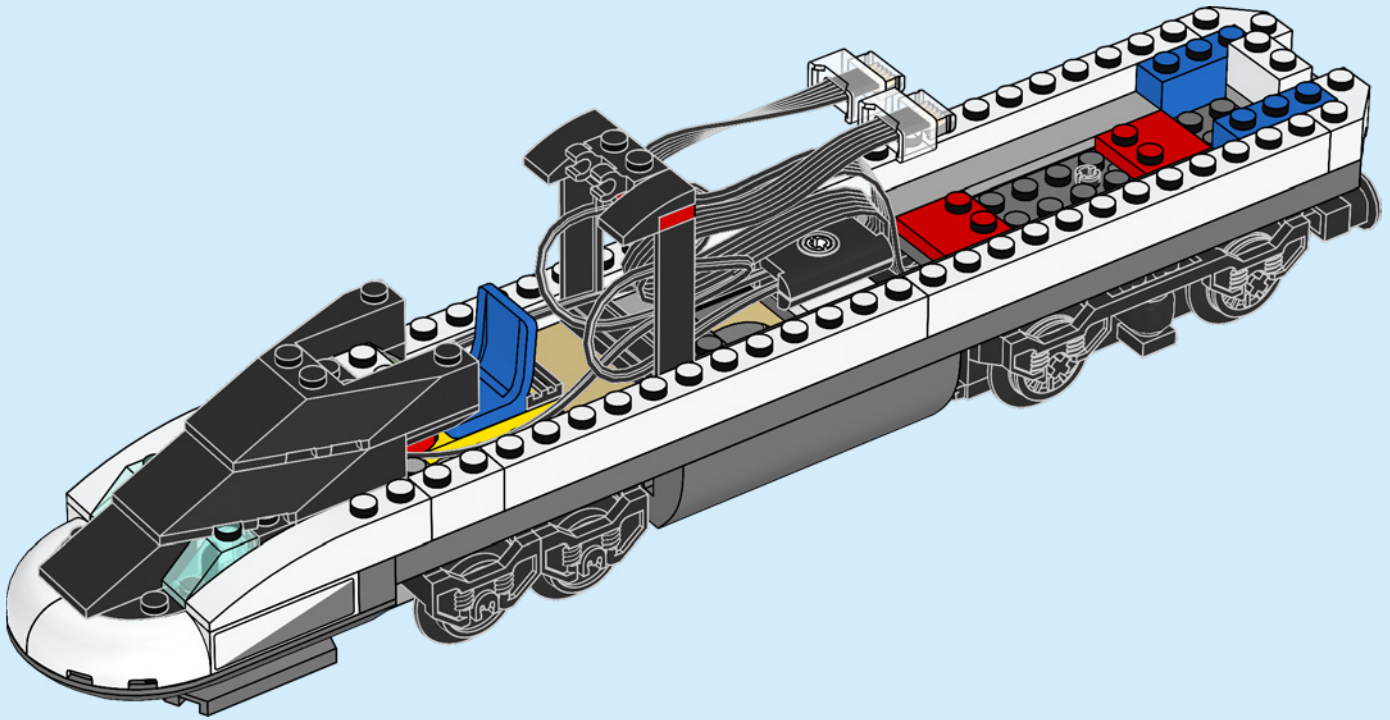



1x

39

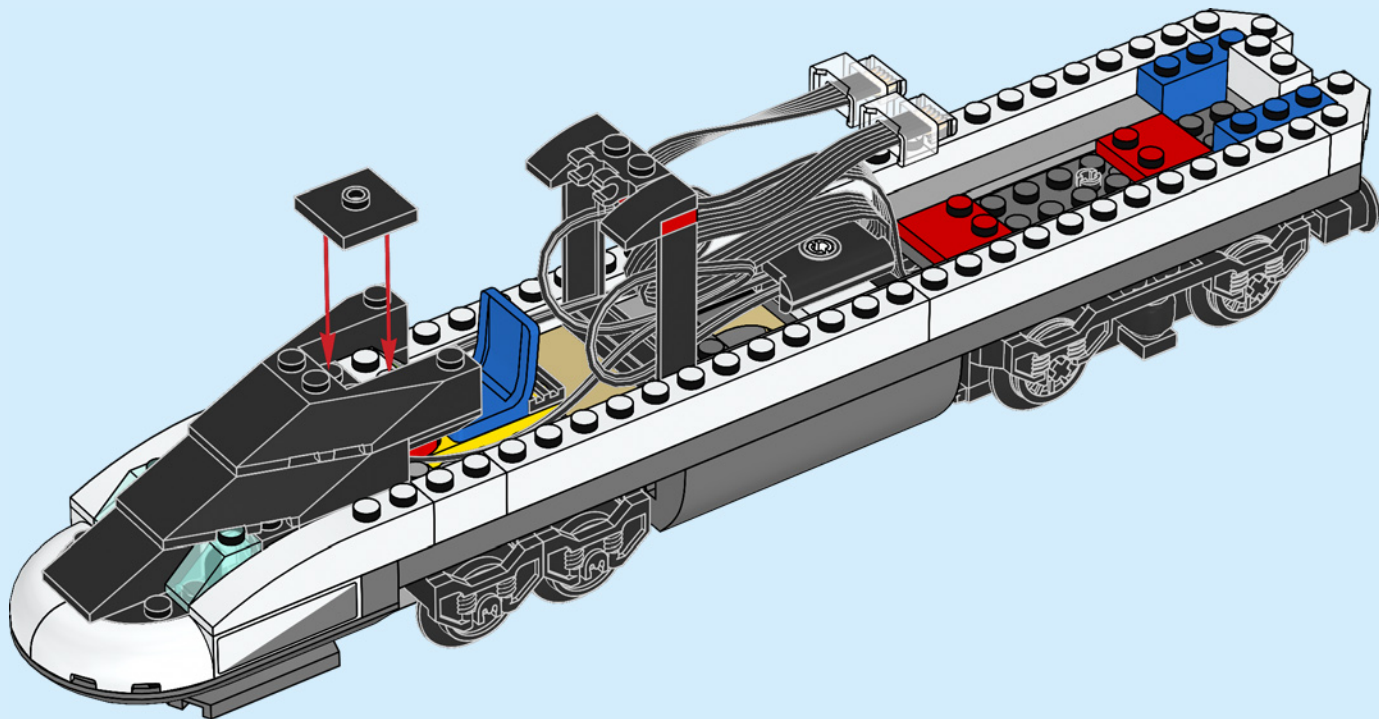

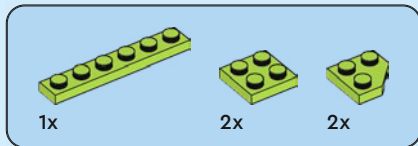
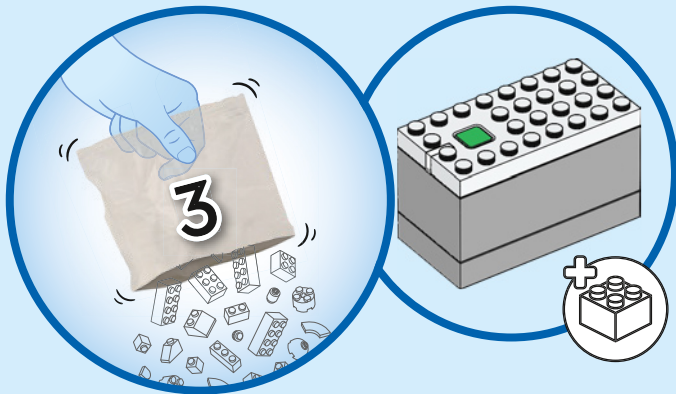

40

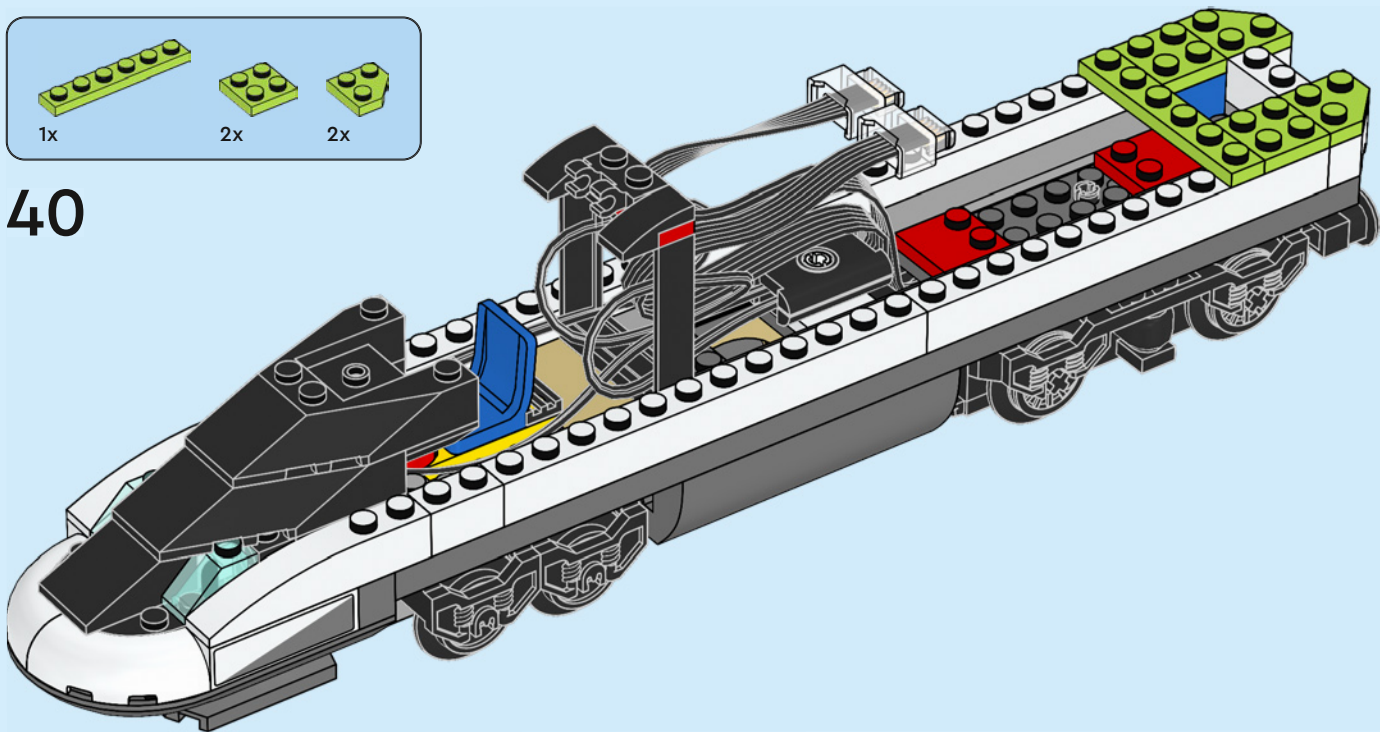

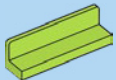

6x

41

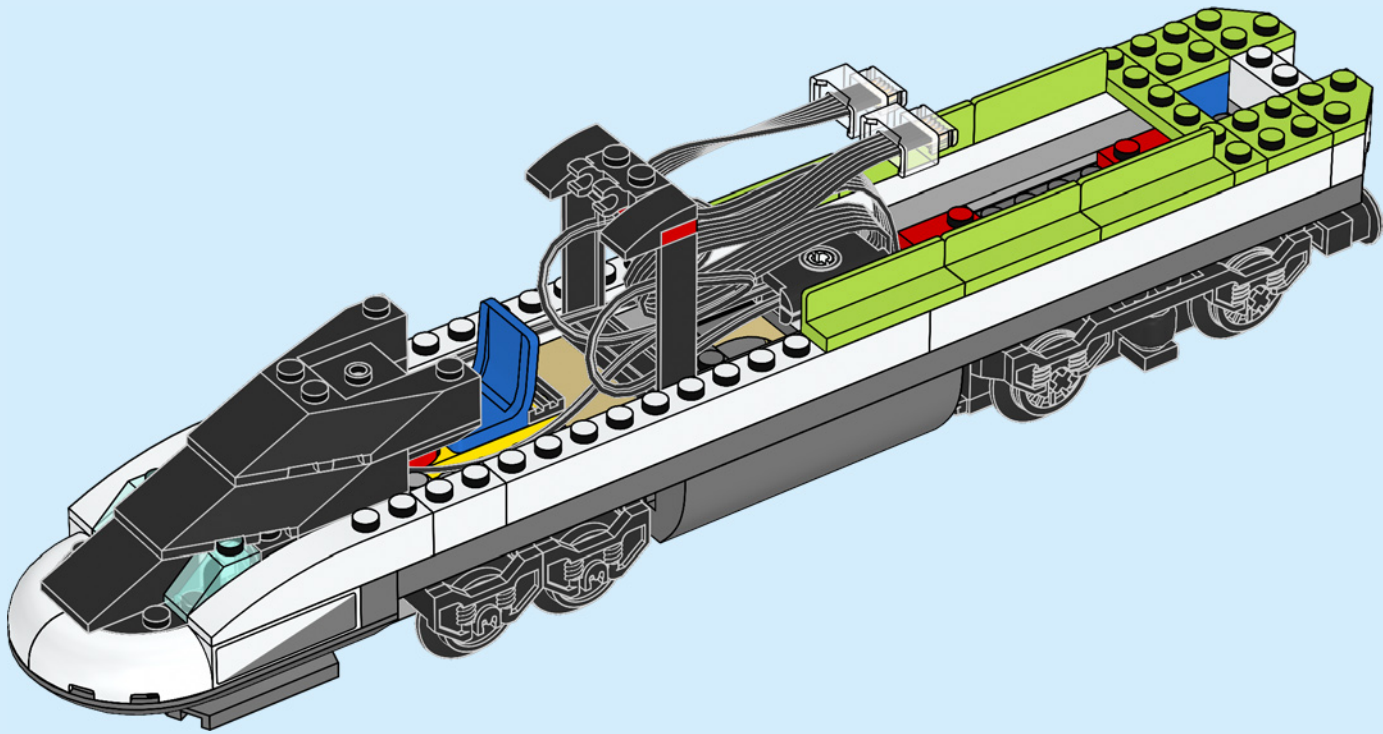

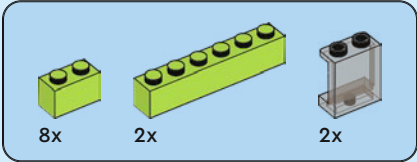
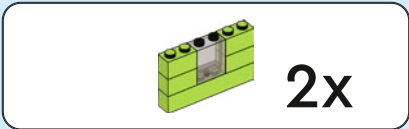

42

1

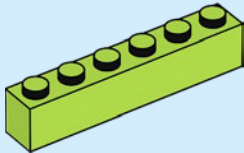

2

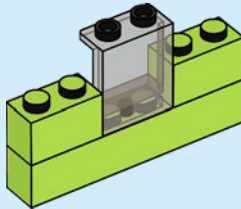

3

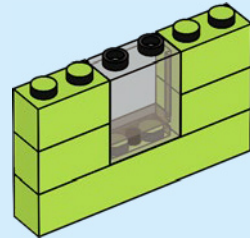

2x



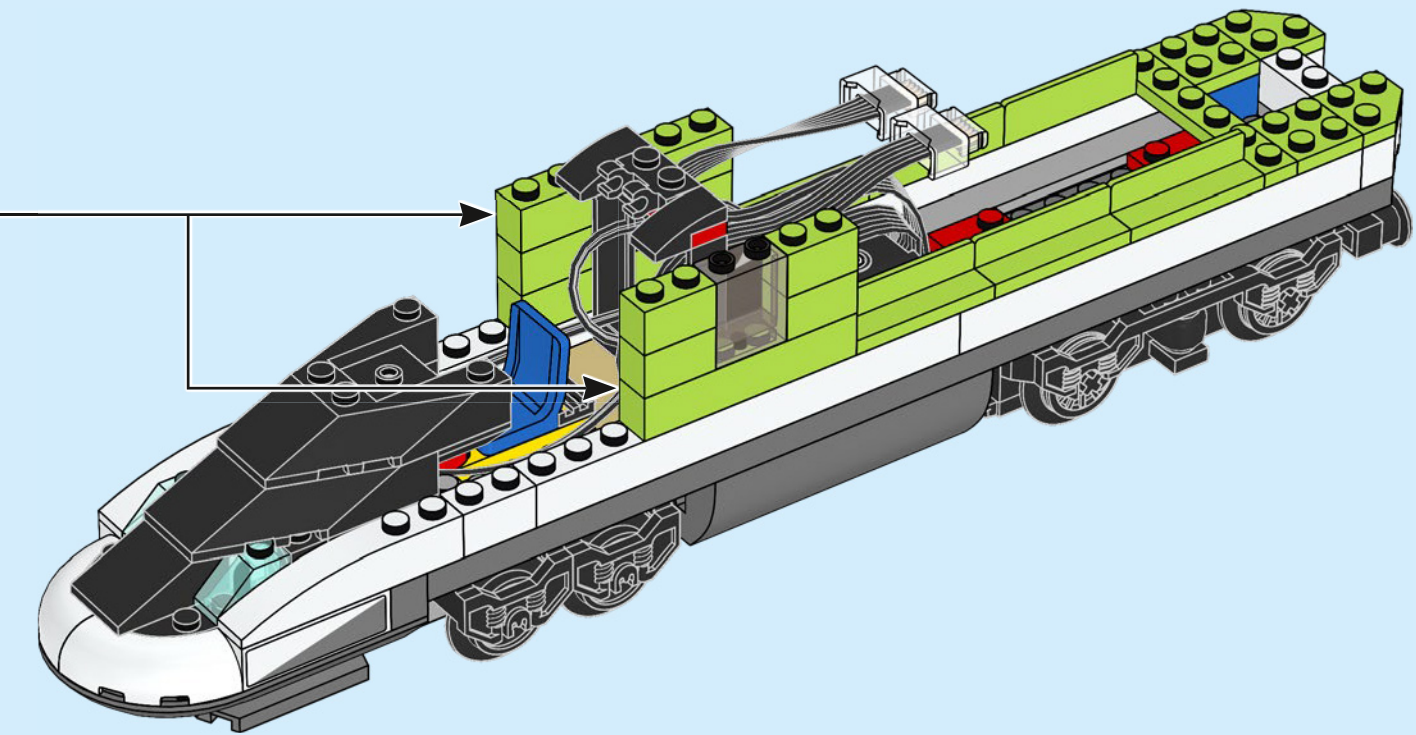

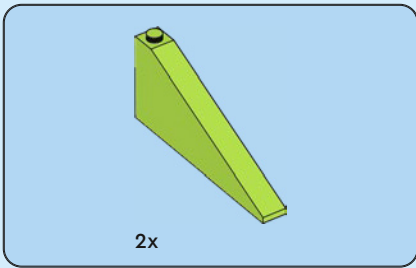

43

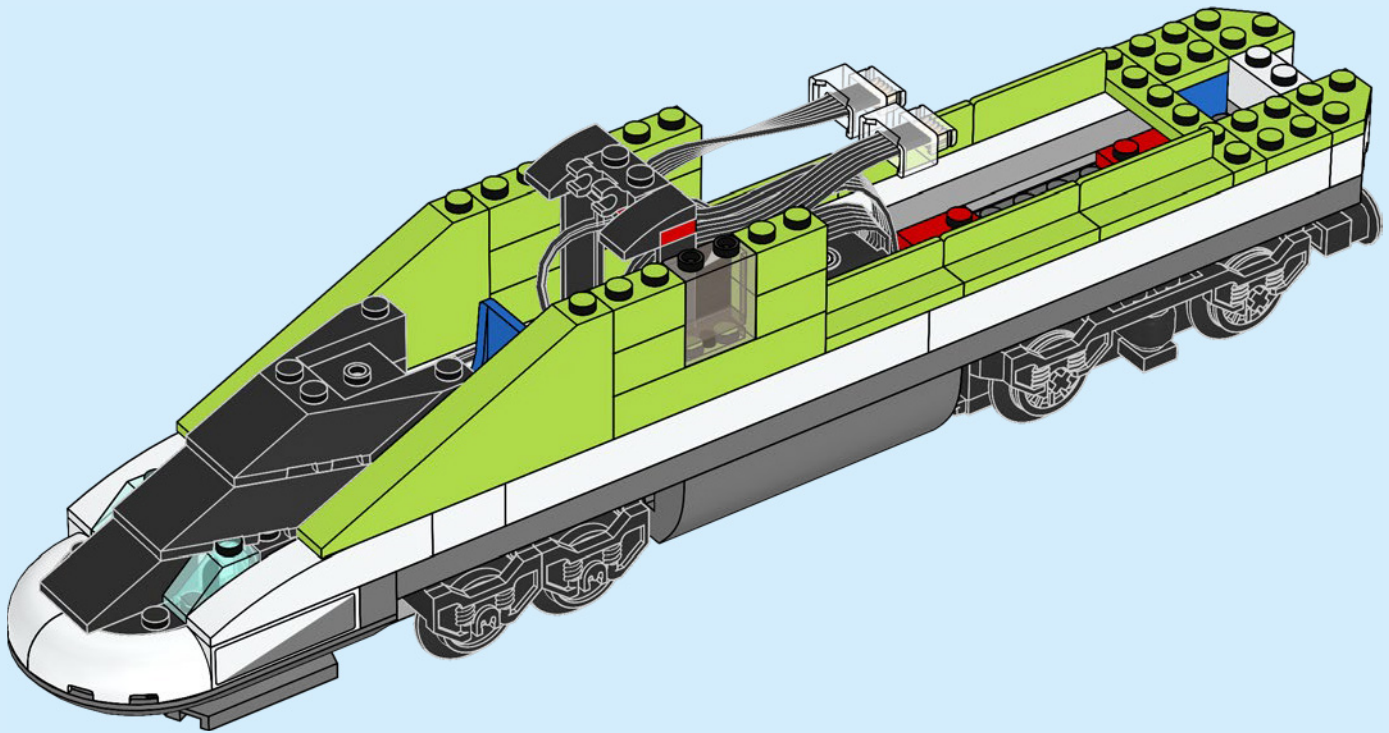

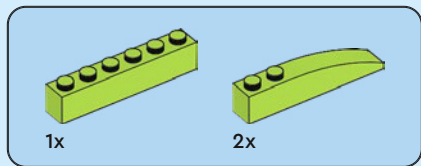

44

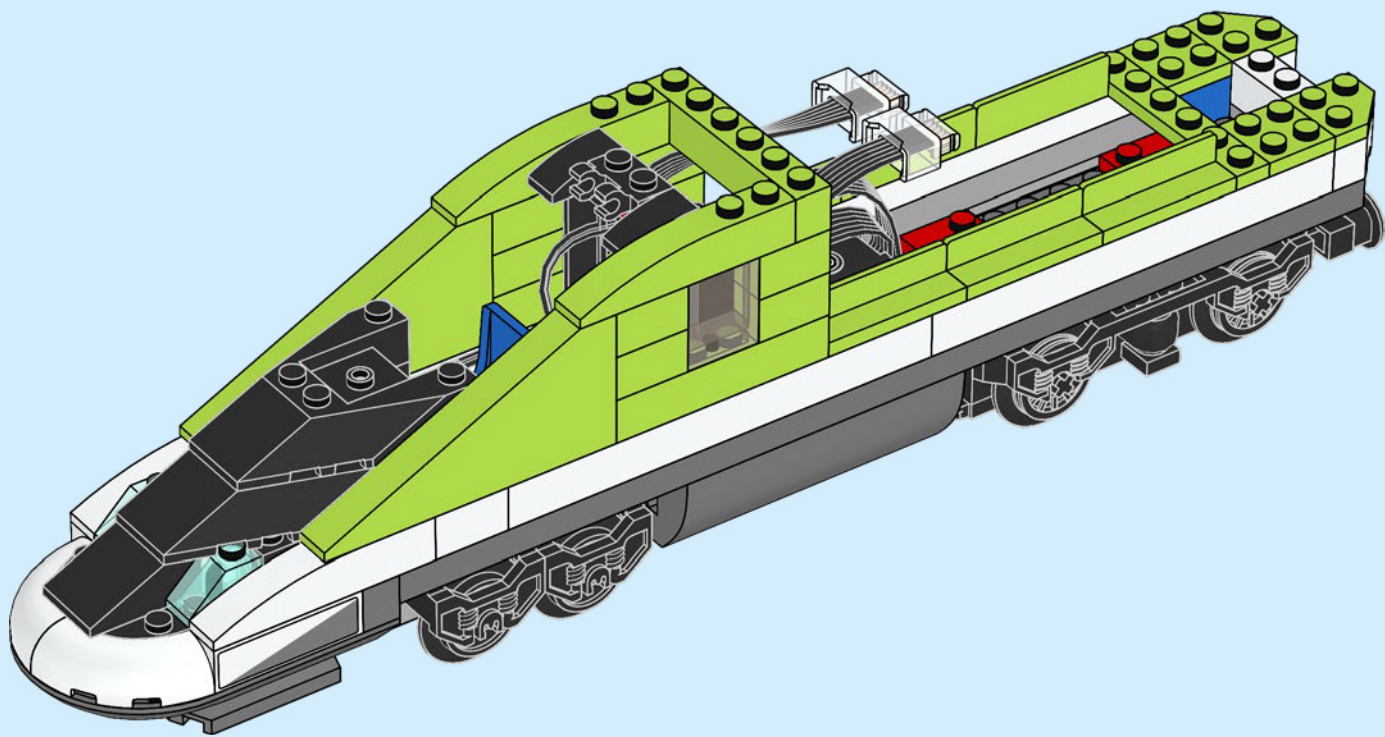

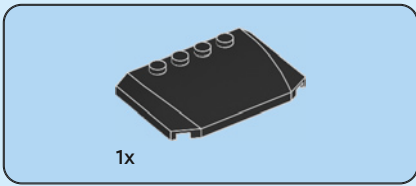

45

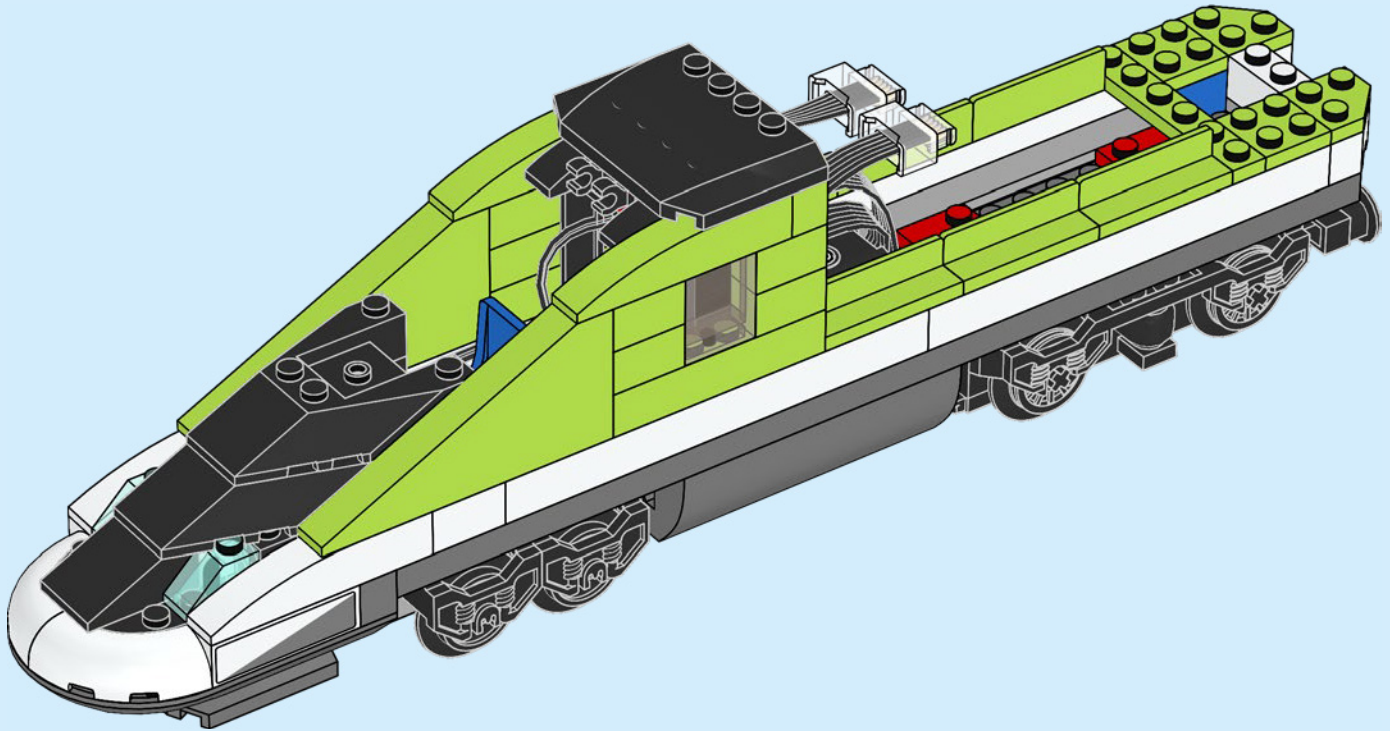

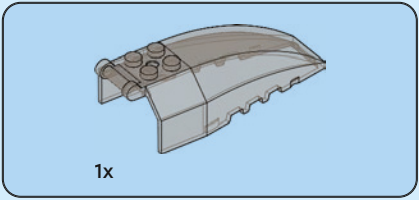

46

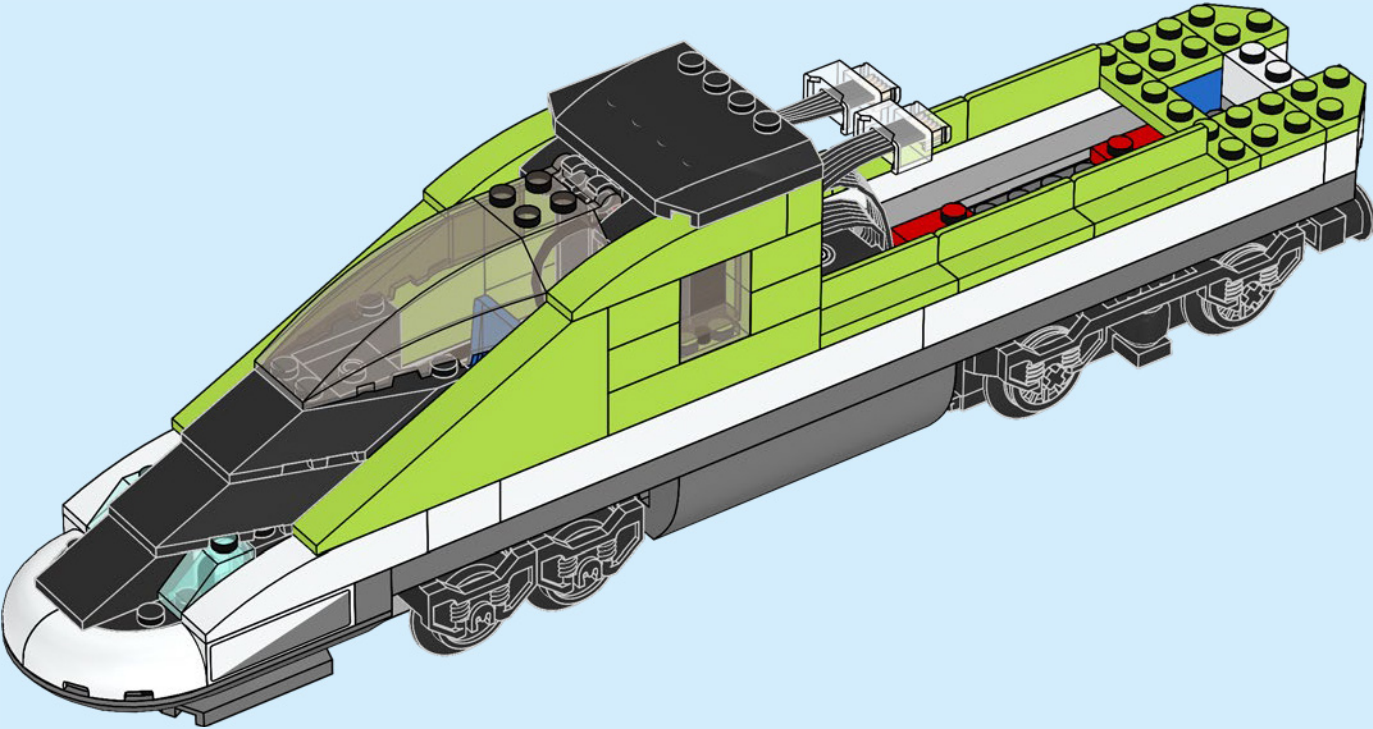

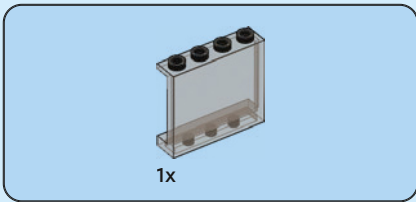

47

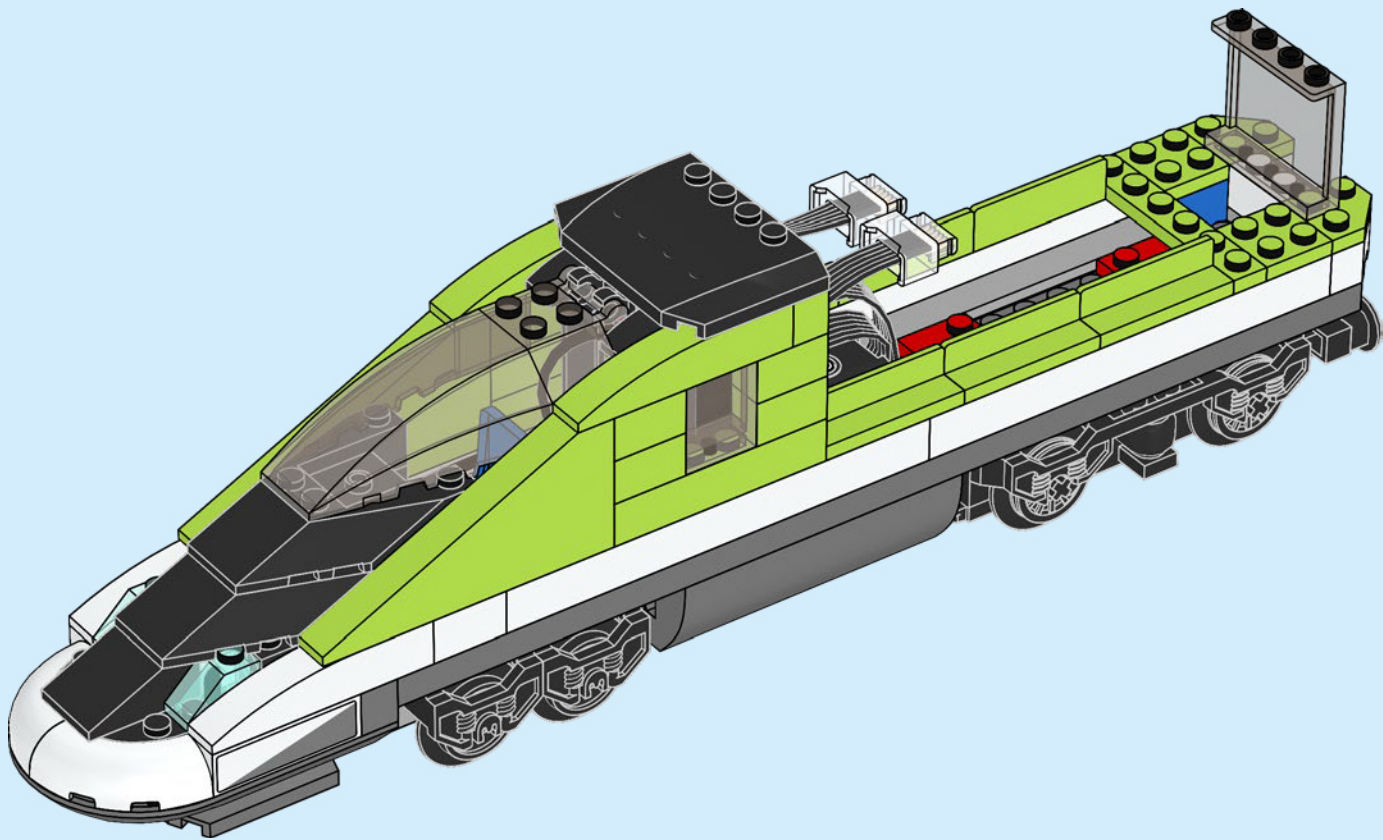



6x

48



2x

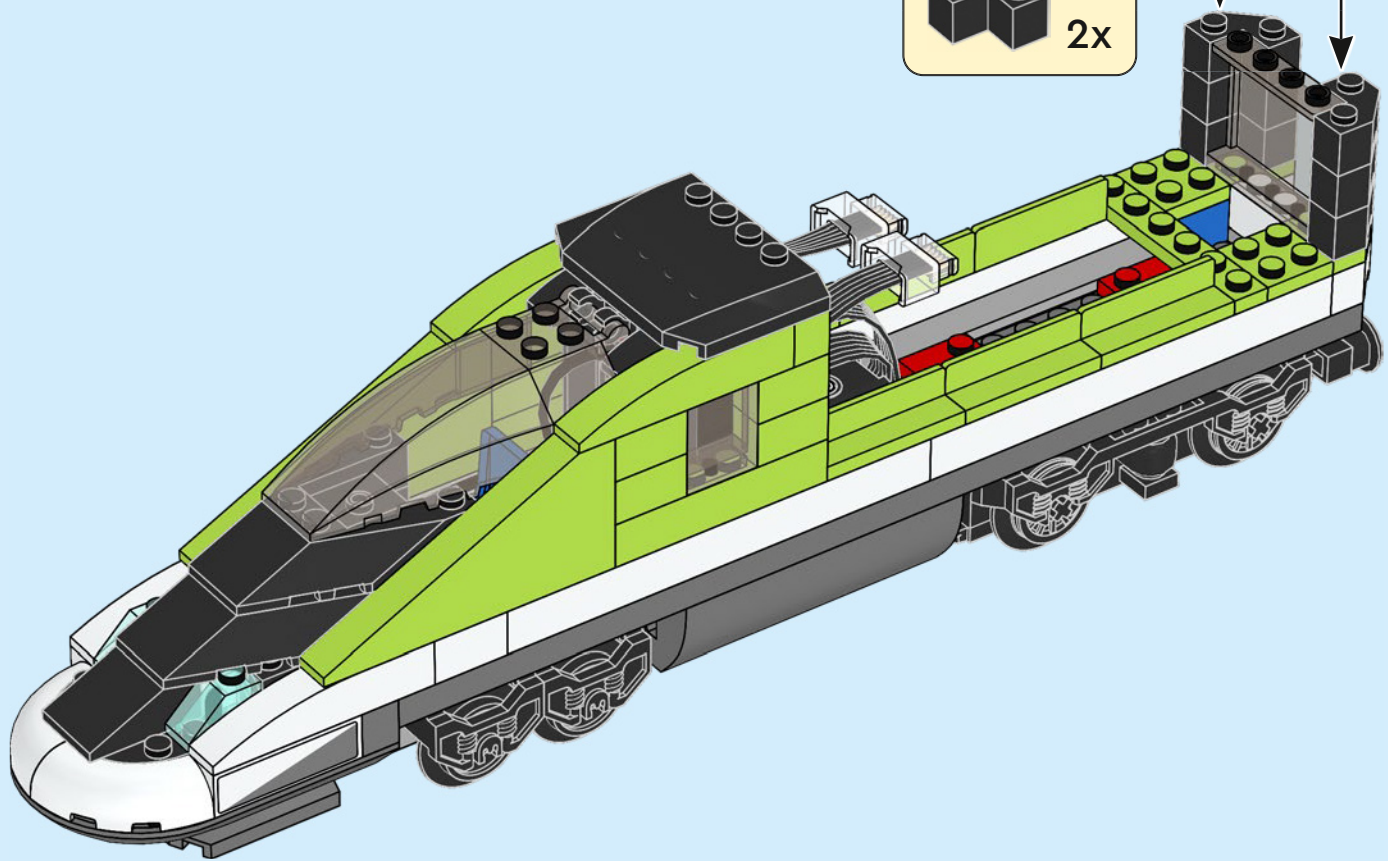



2x

49

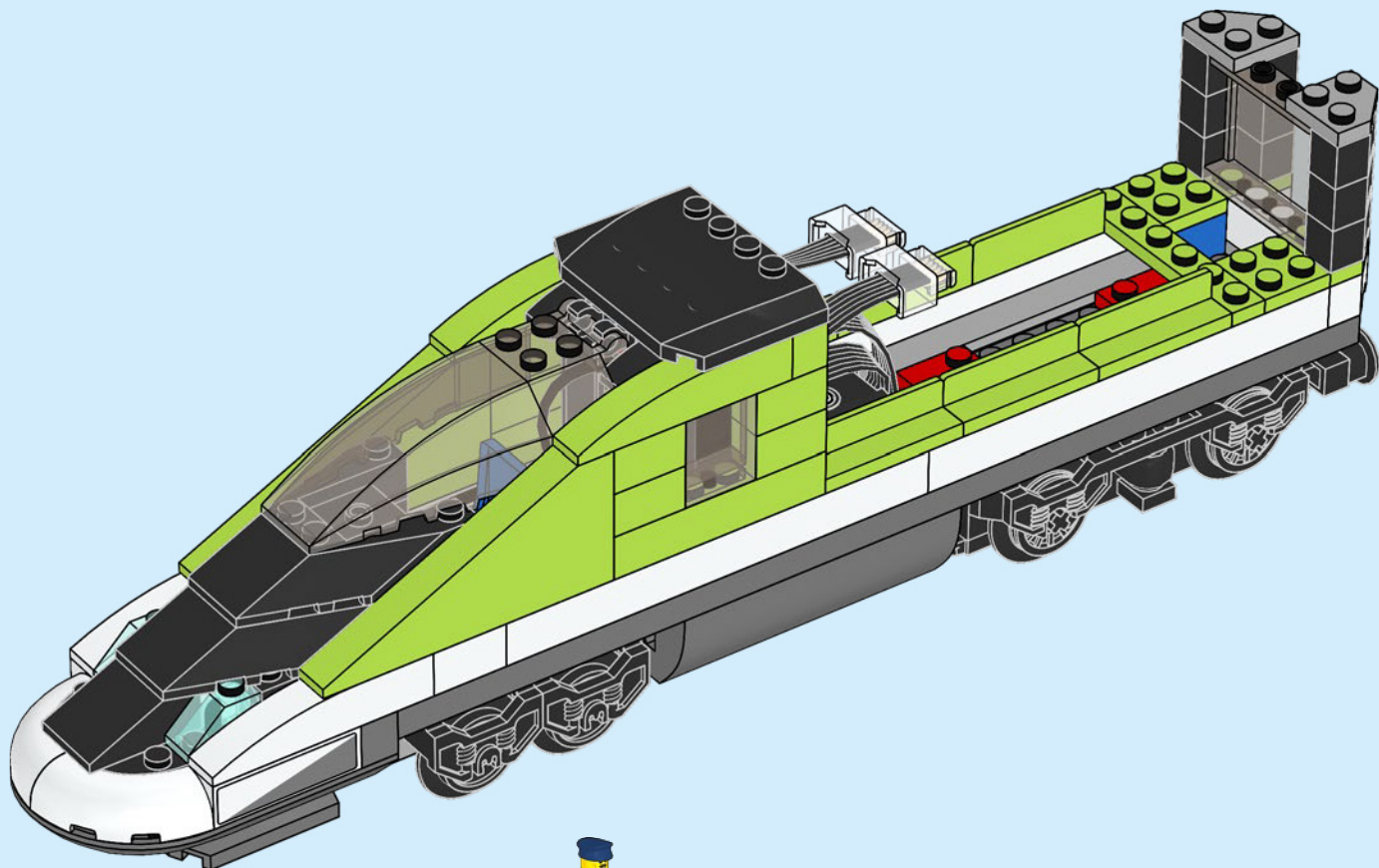

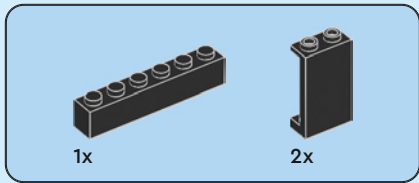

50

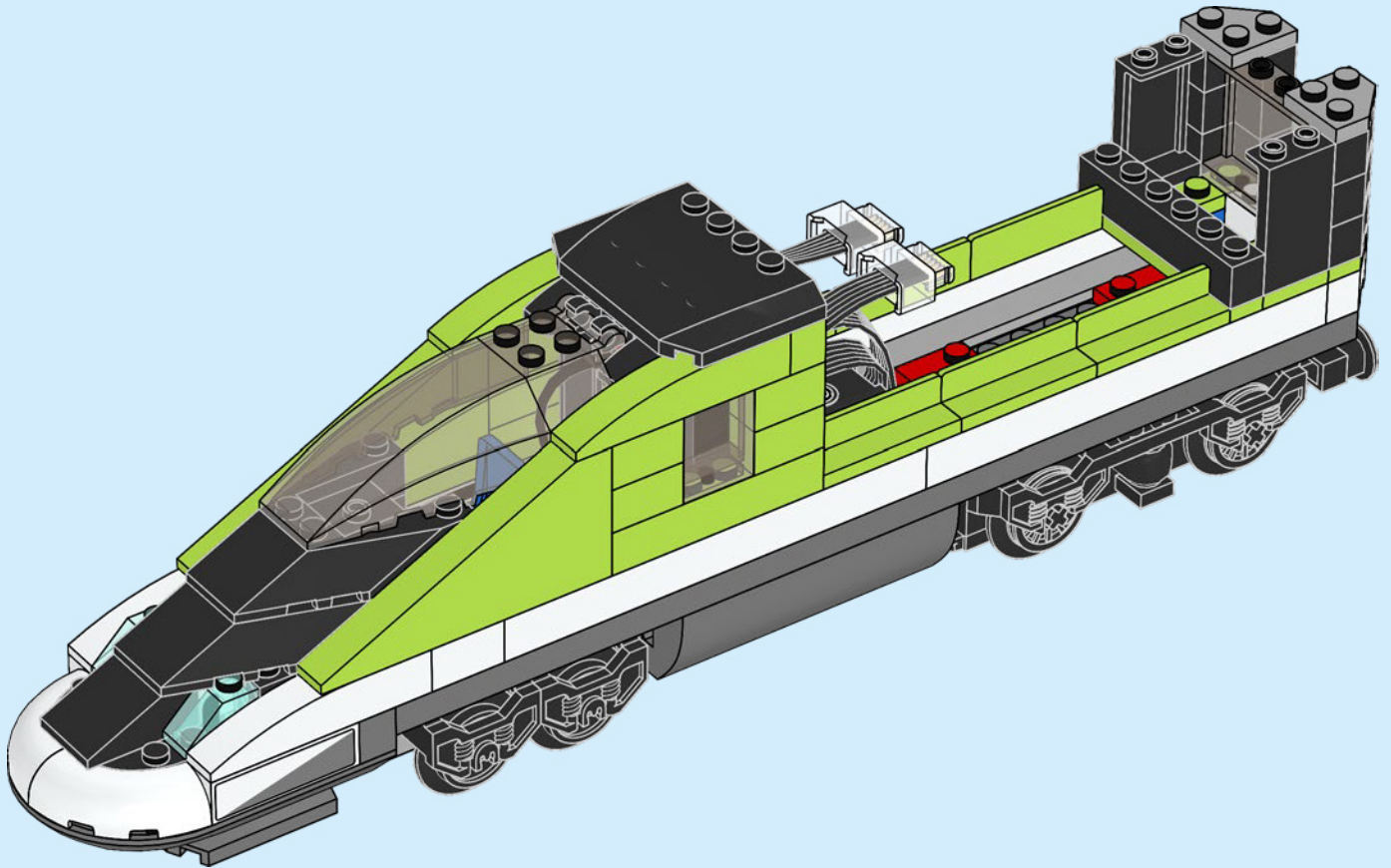

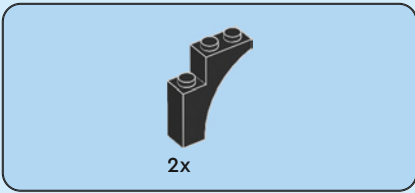

51

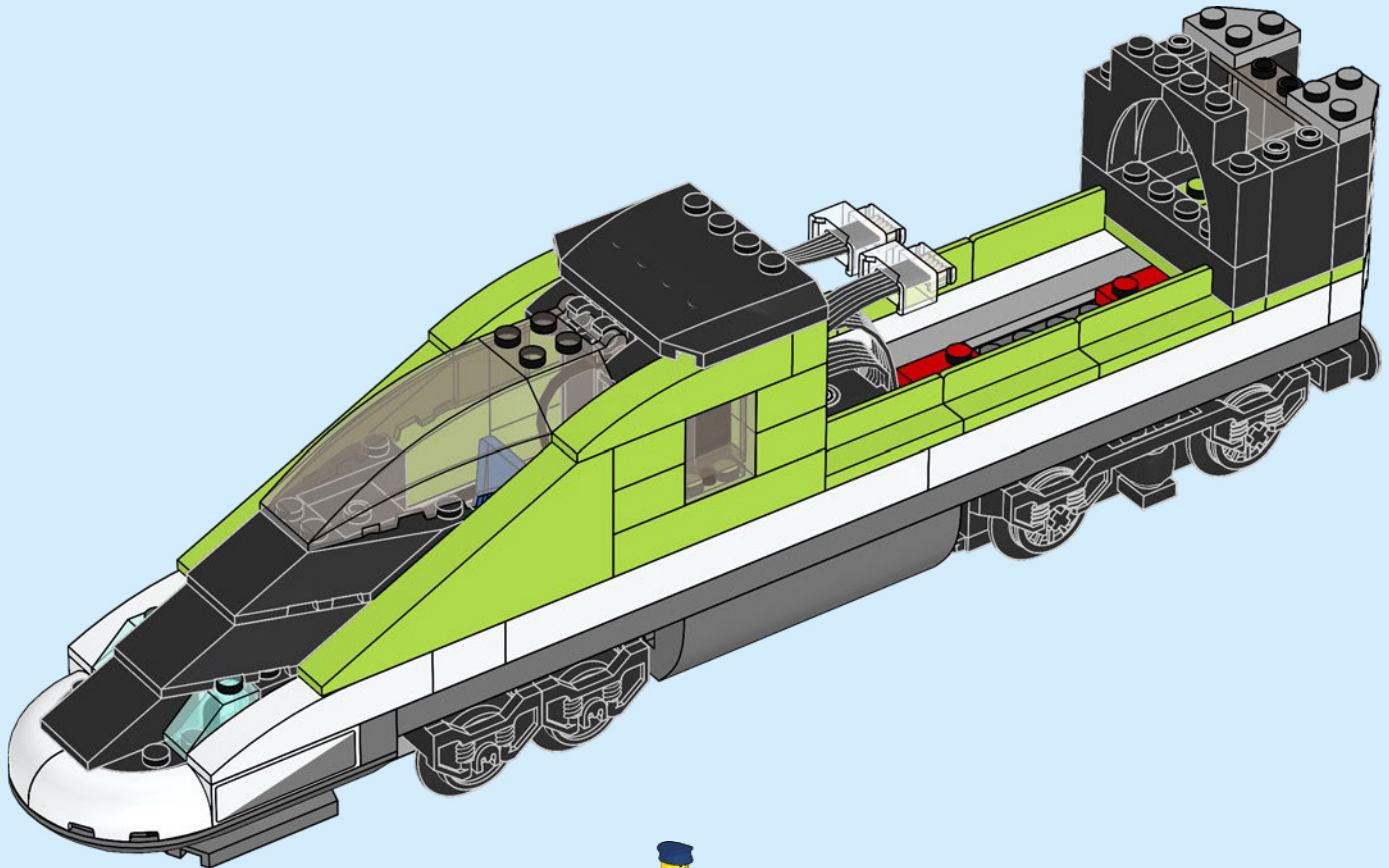



2x



1x

52

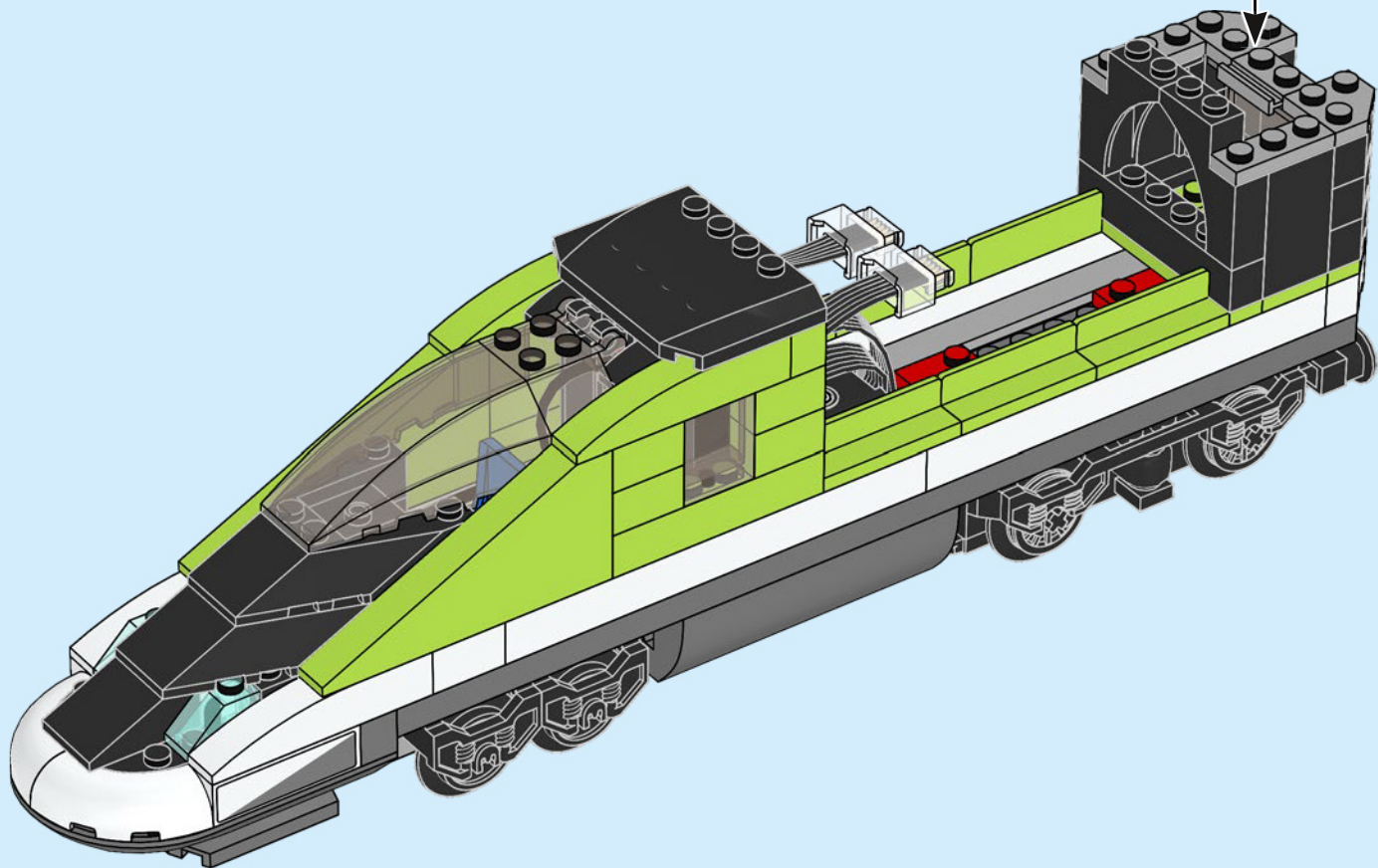

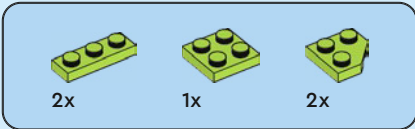

53

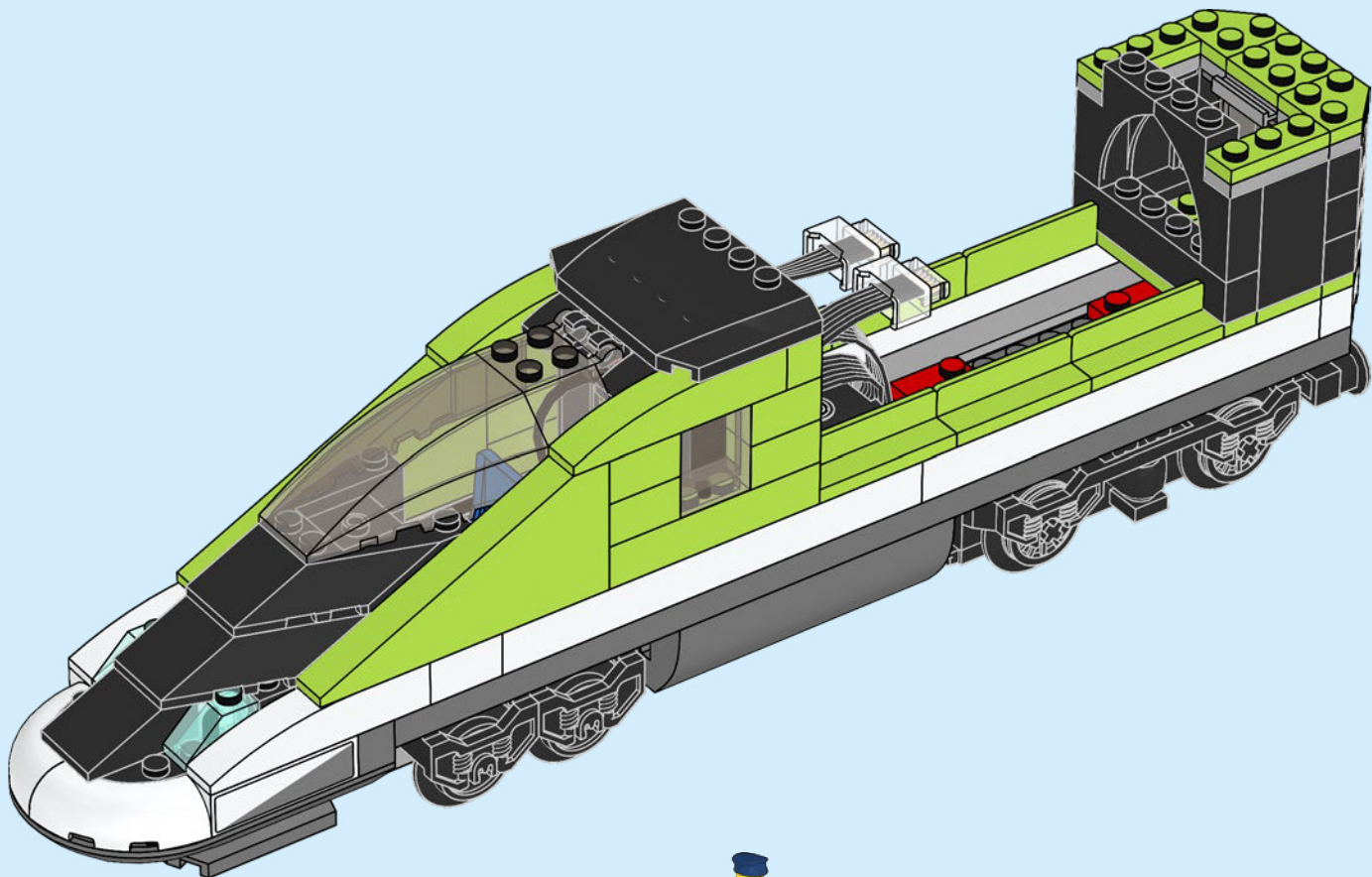

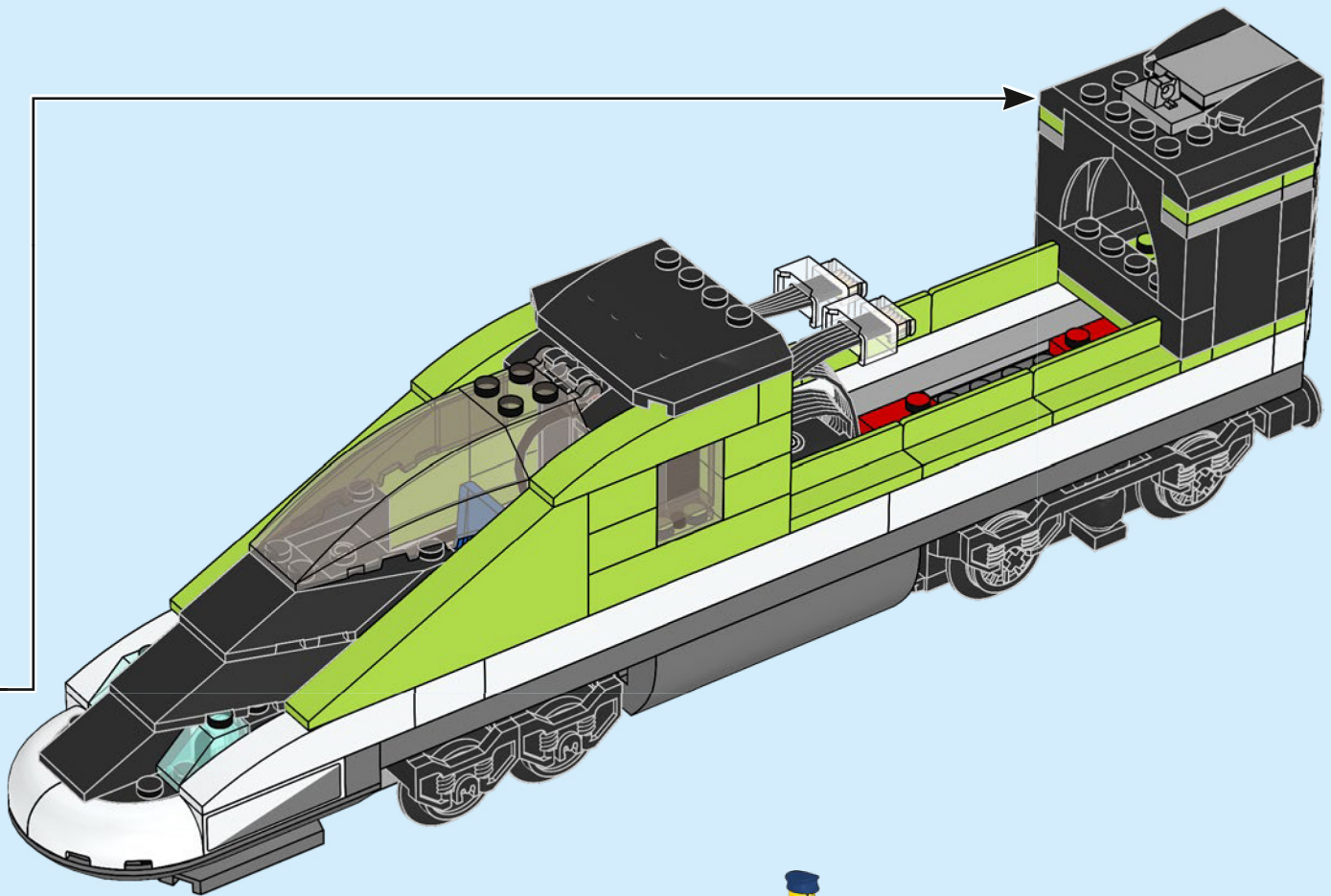

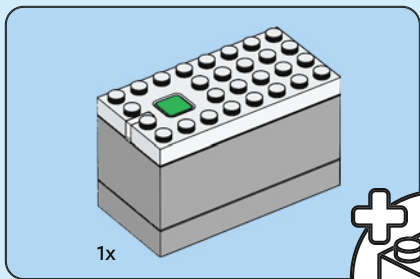

1x

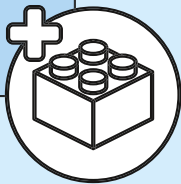

55

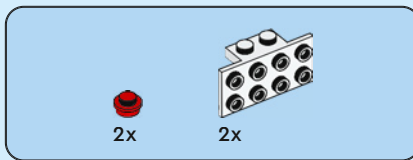
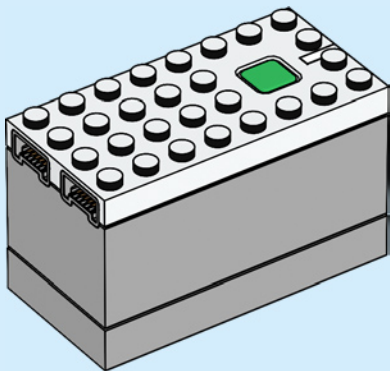

2x

2x

56

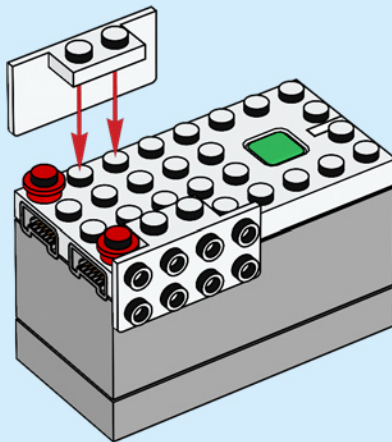

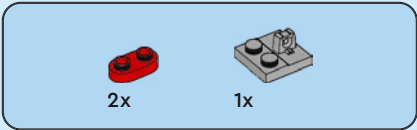

57

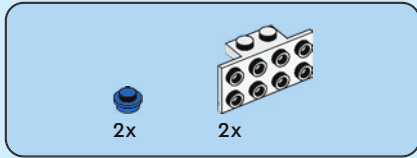
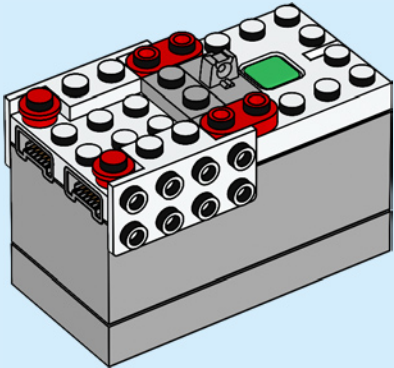

58

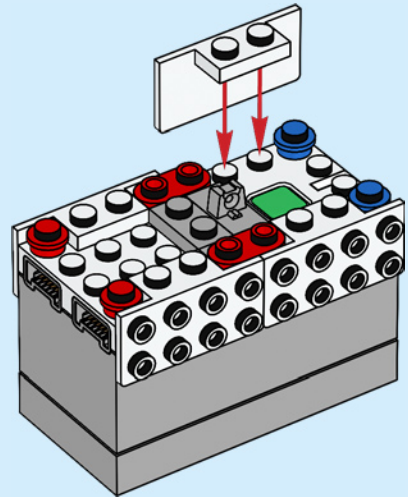

59

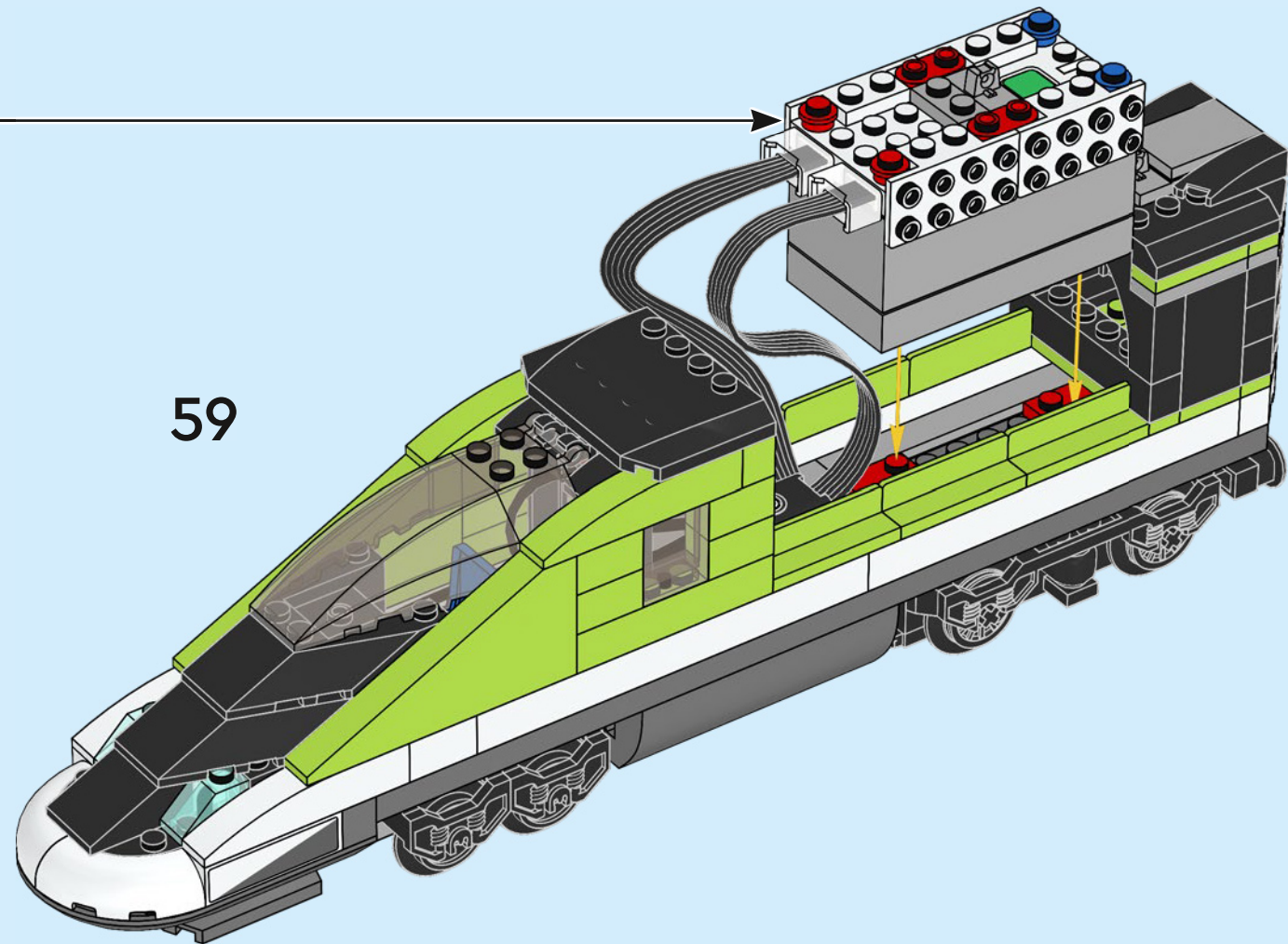

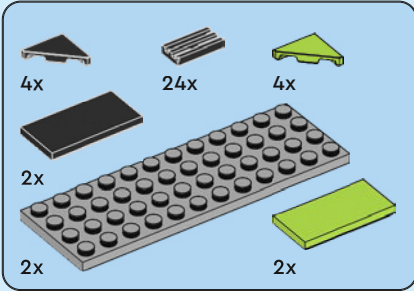
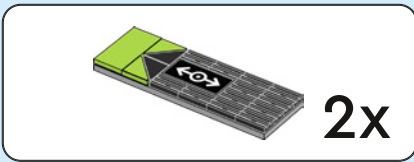

60

1

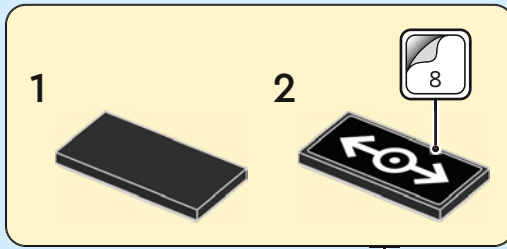
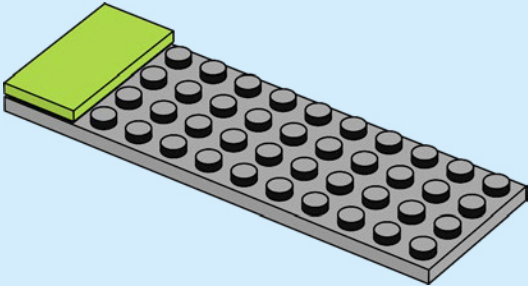

2

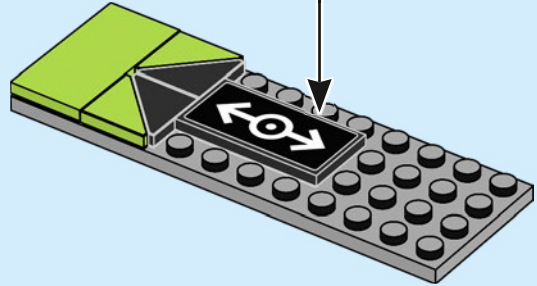

3

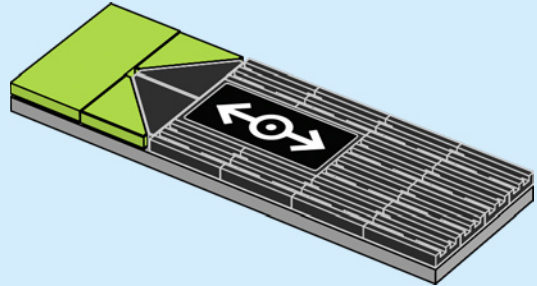

2x



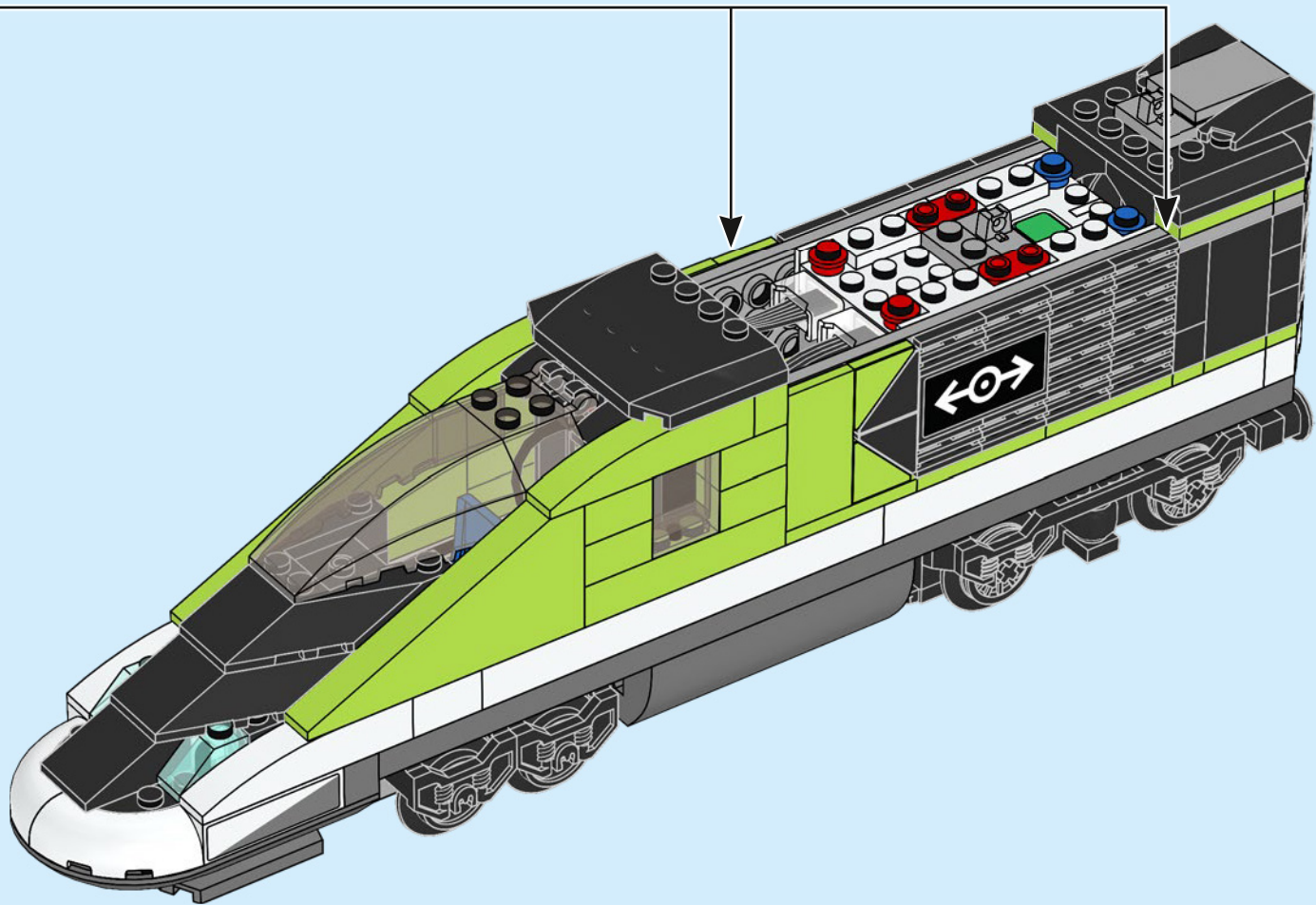

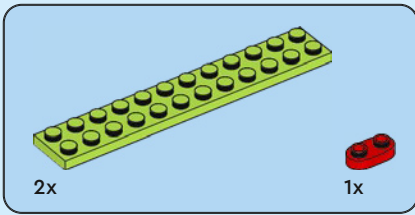

61

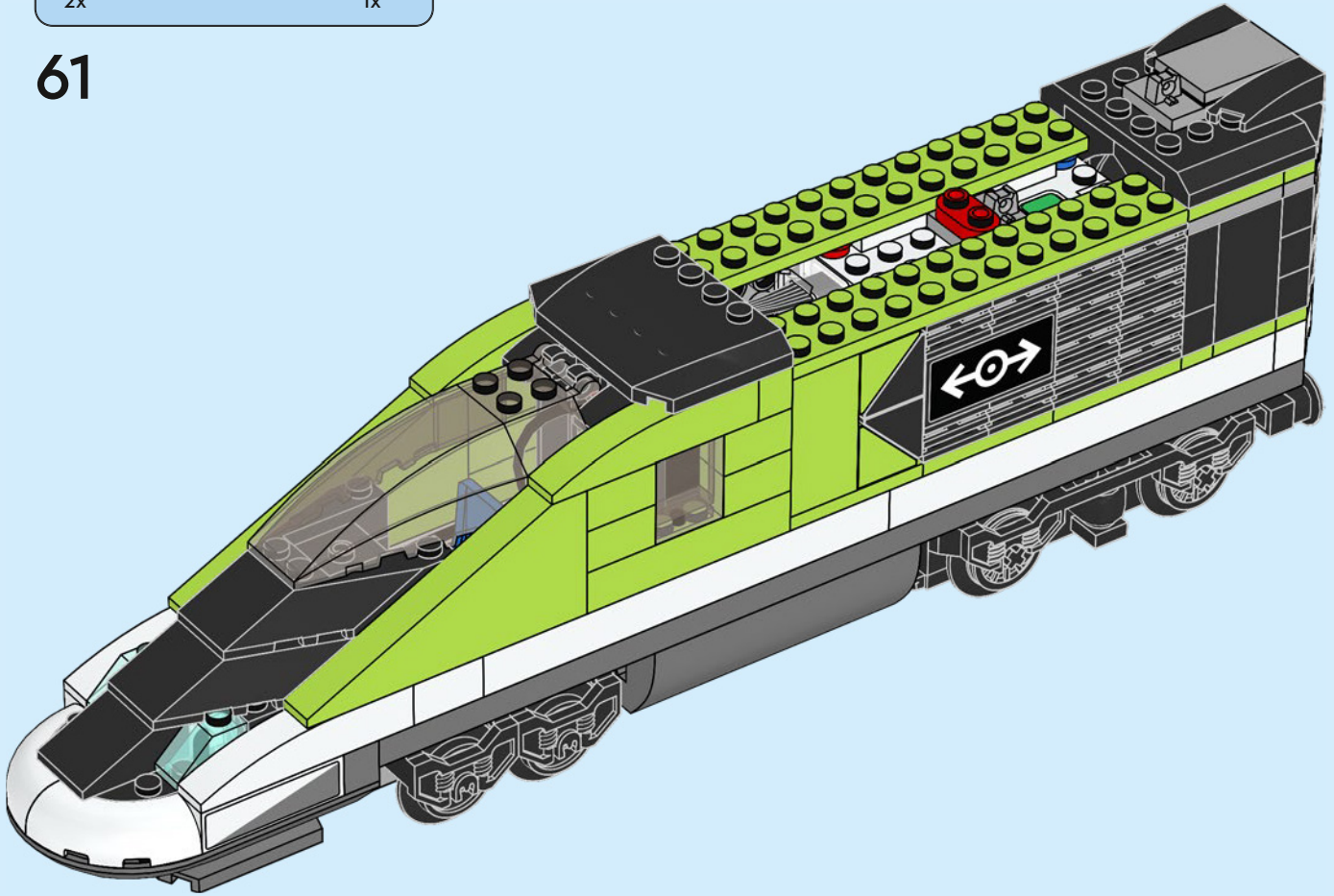

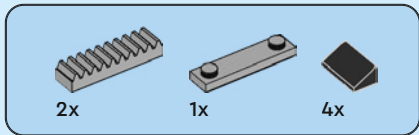

62

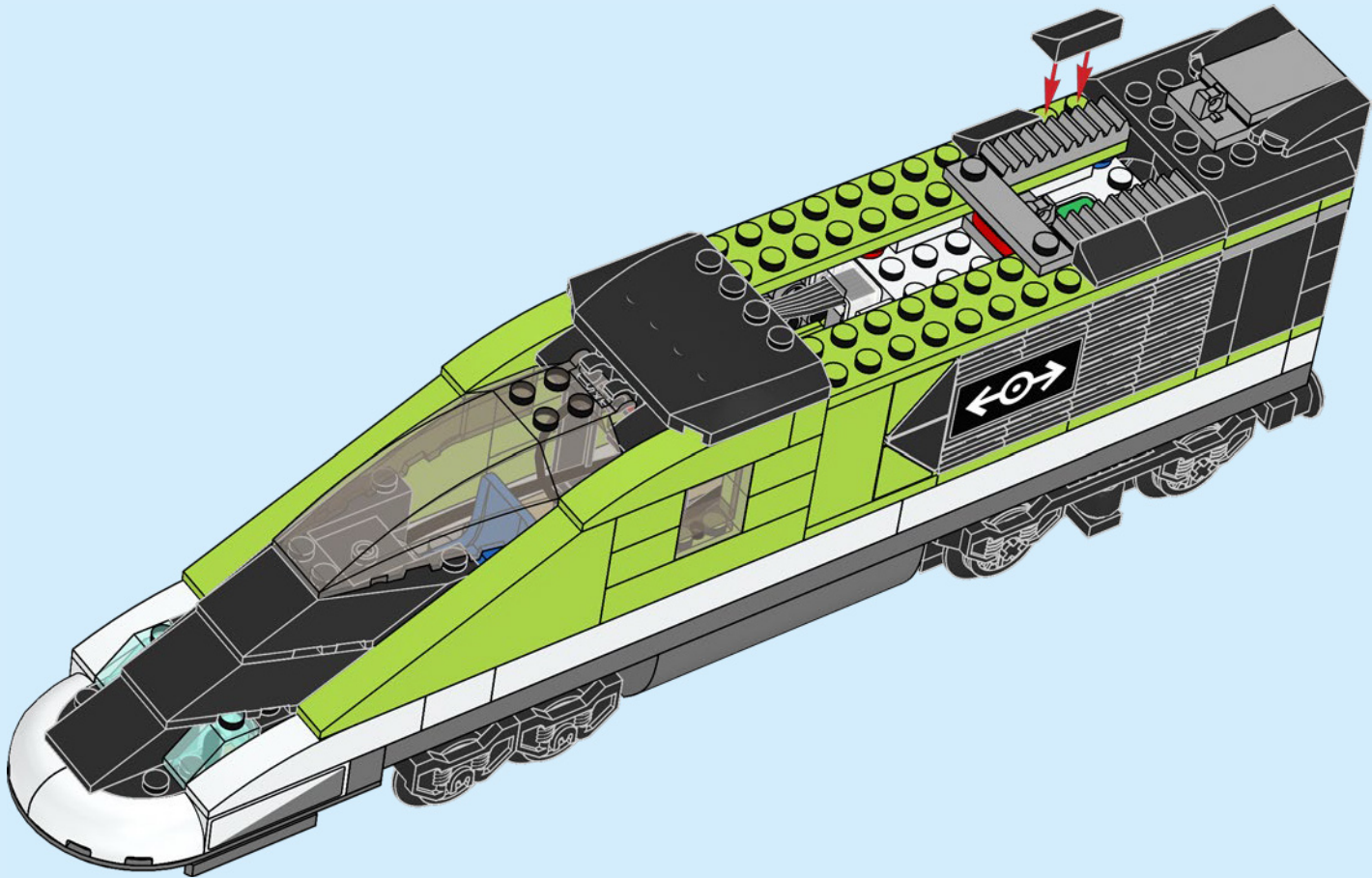



63

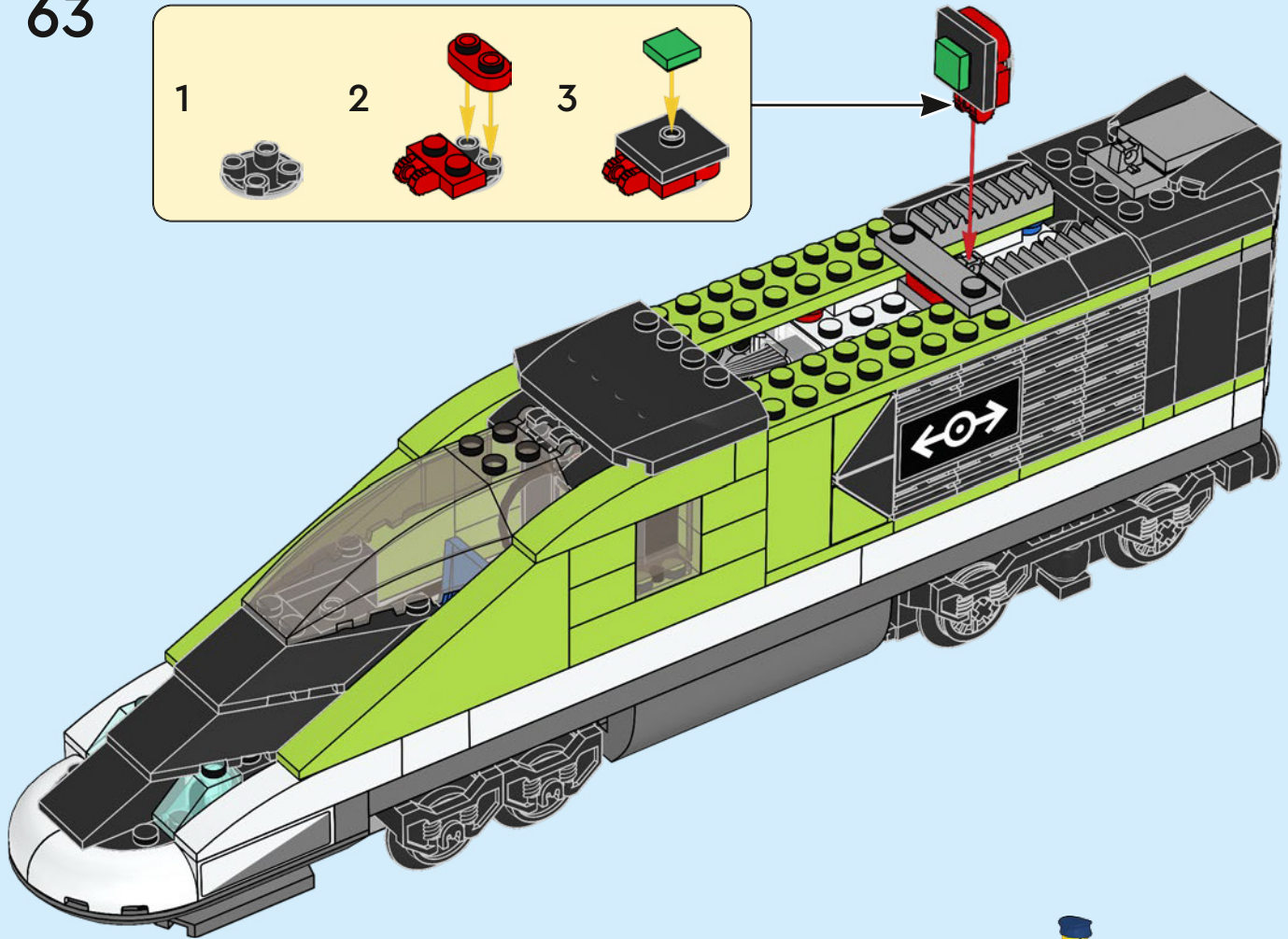
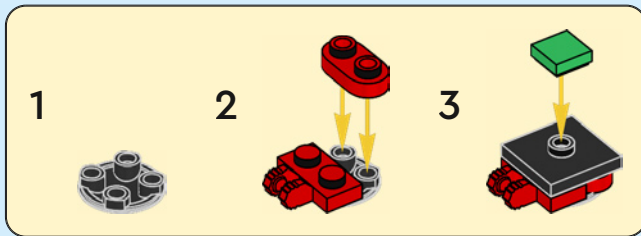

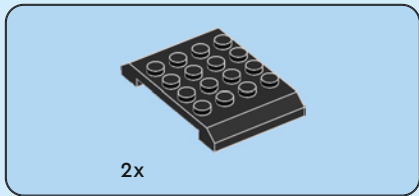

64

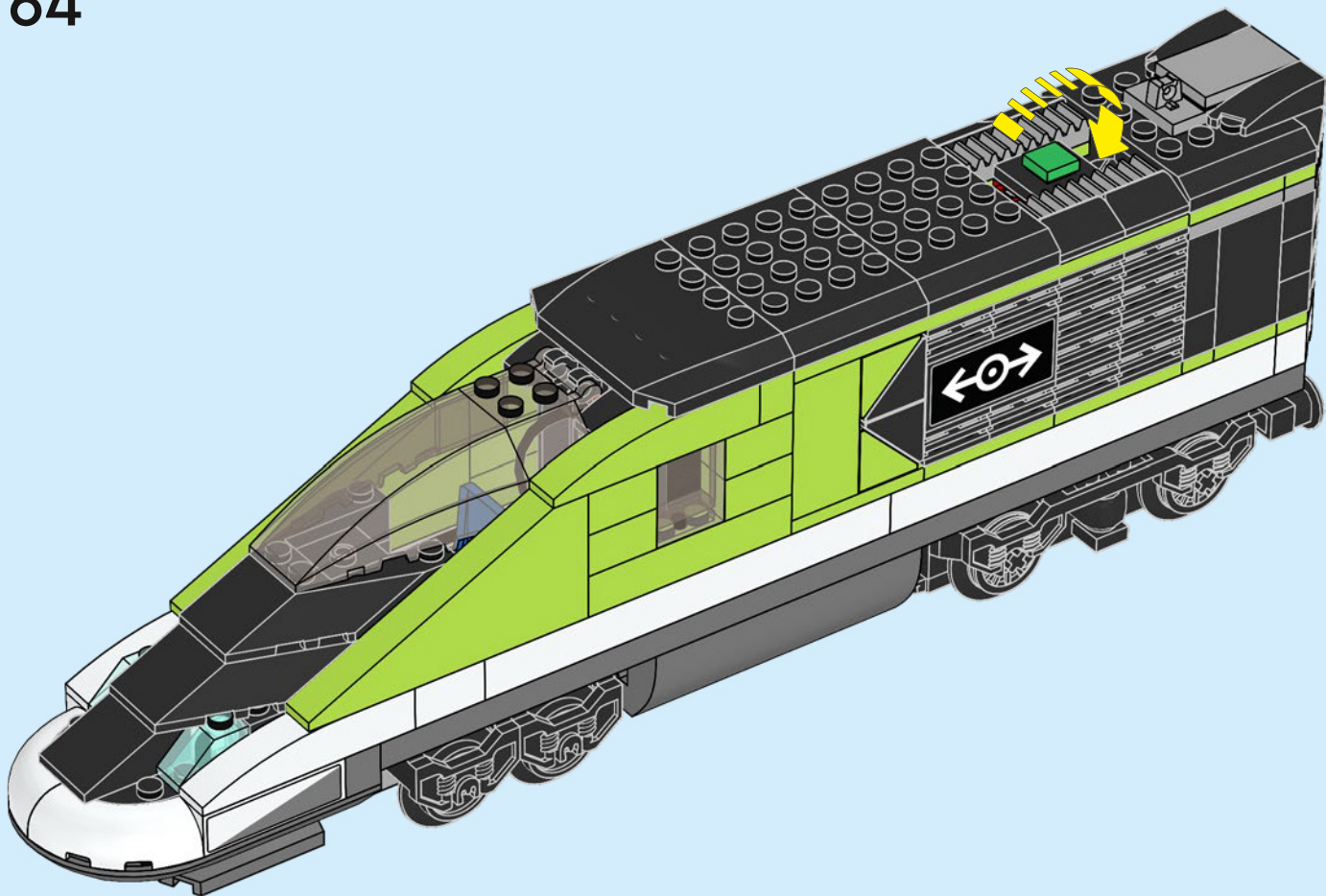

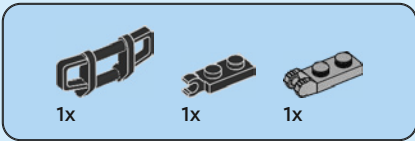

65

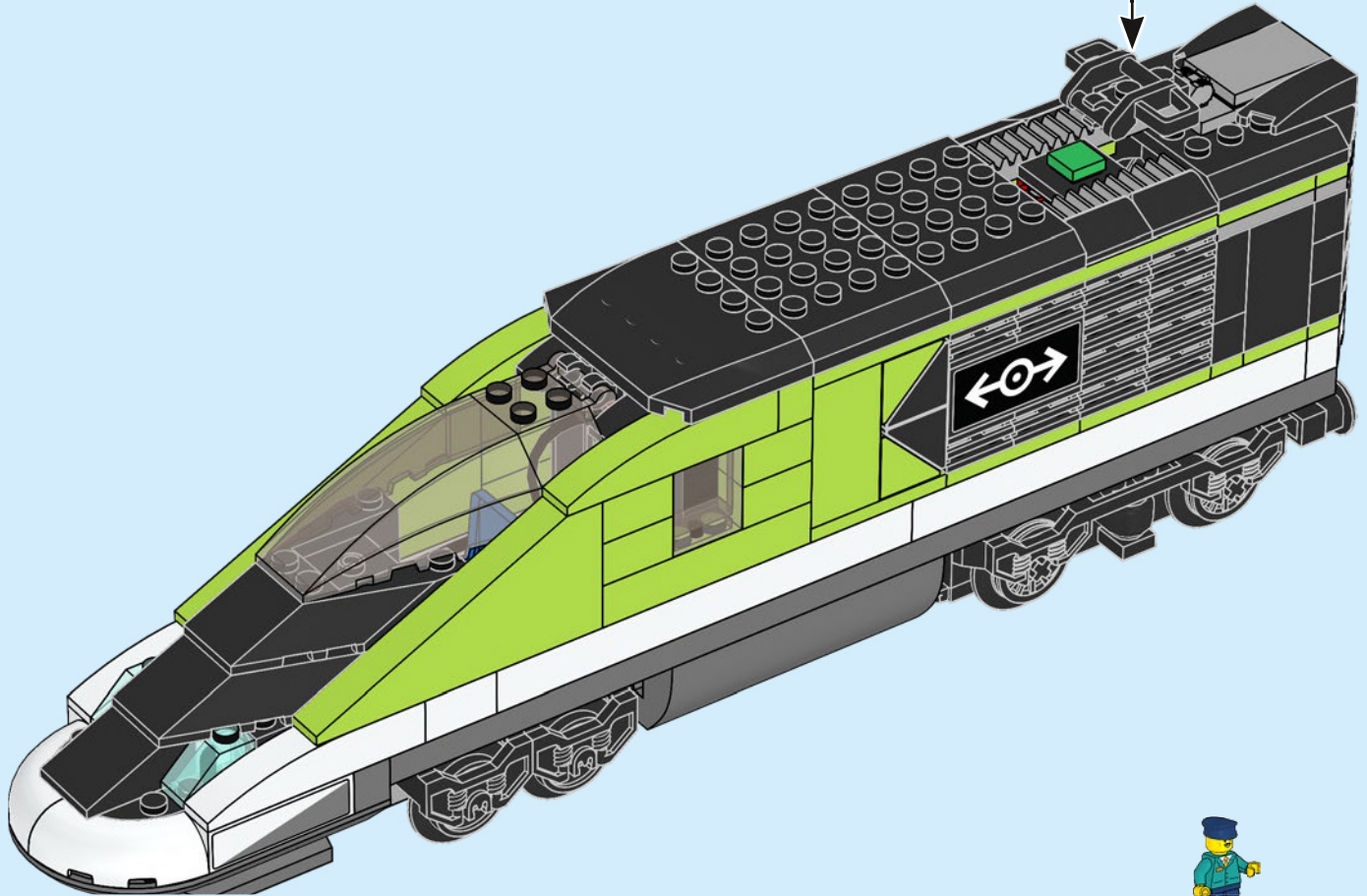
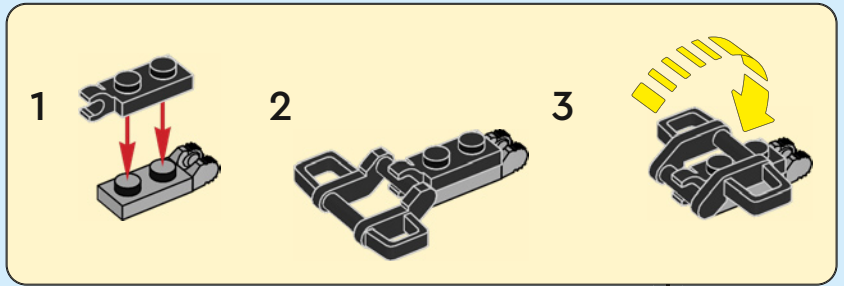

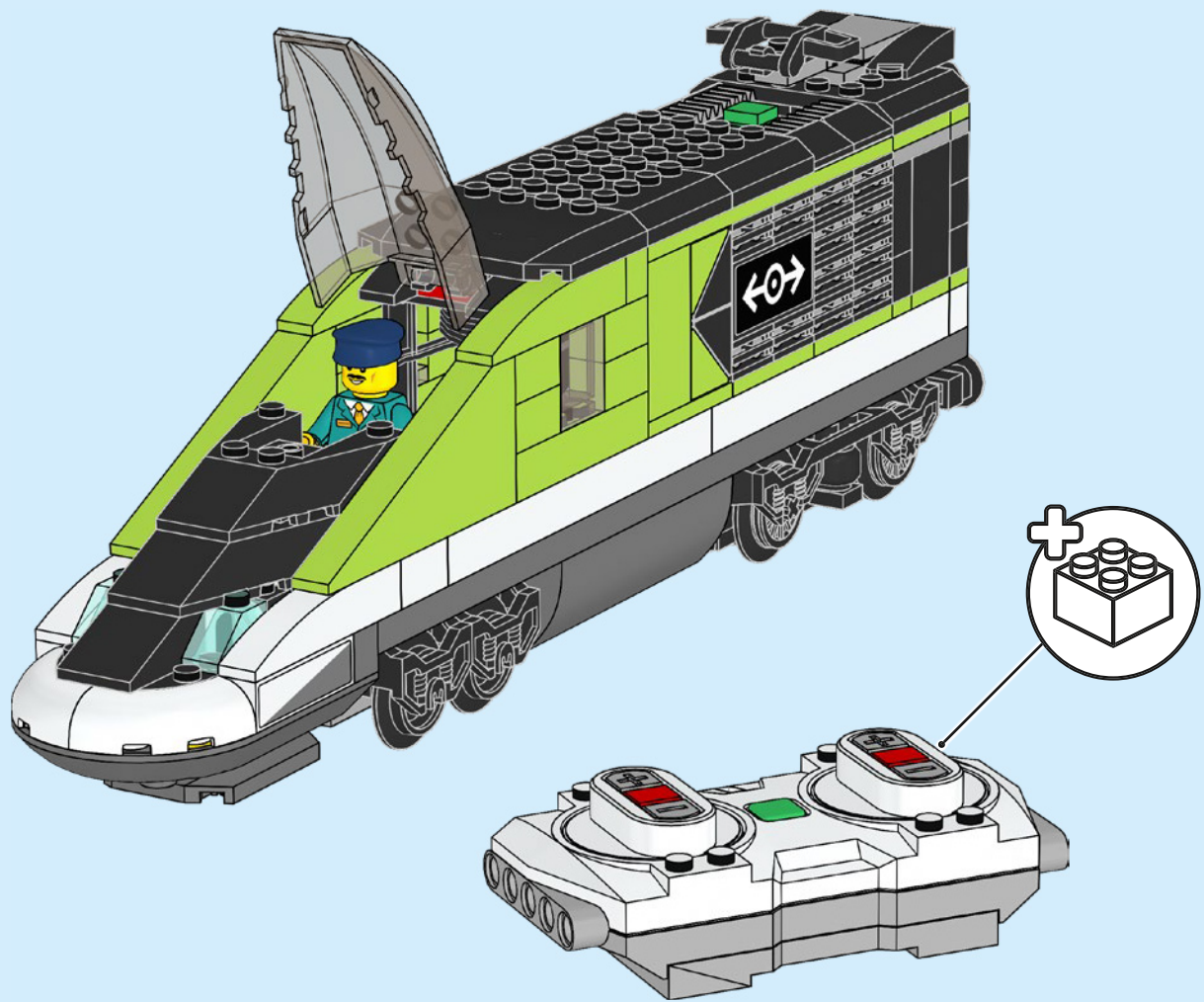

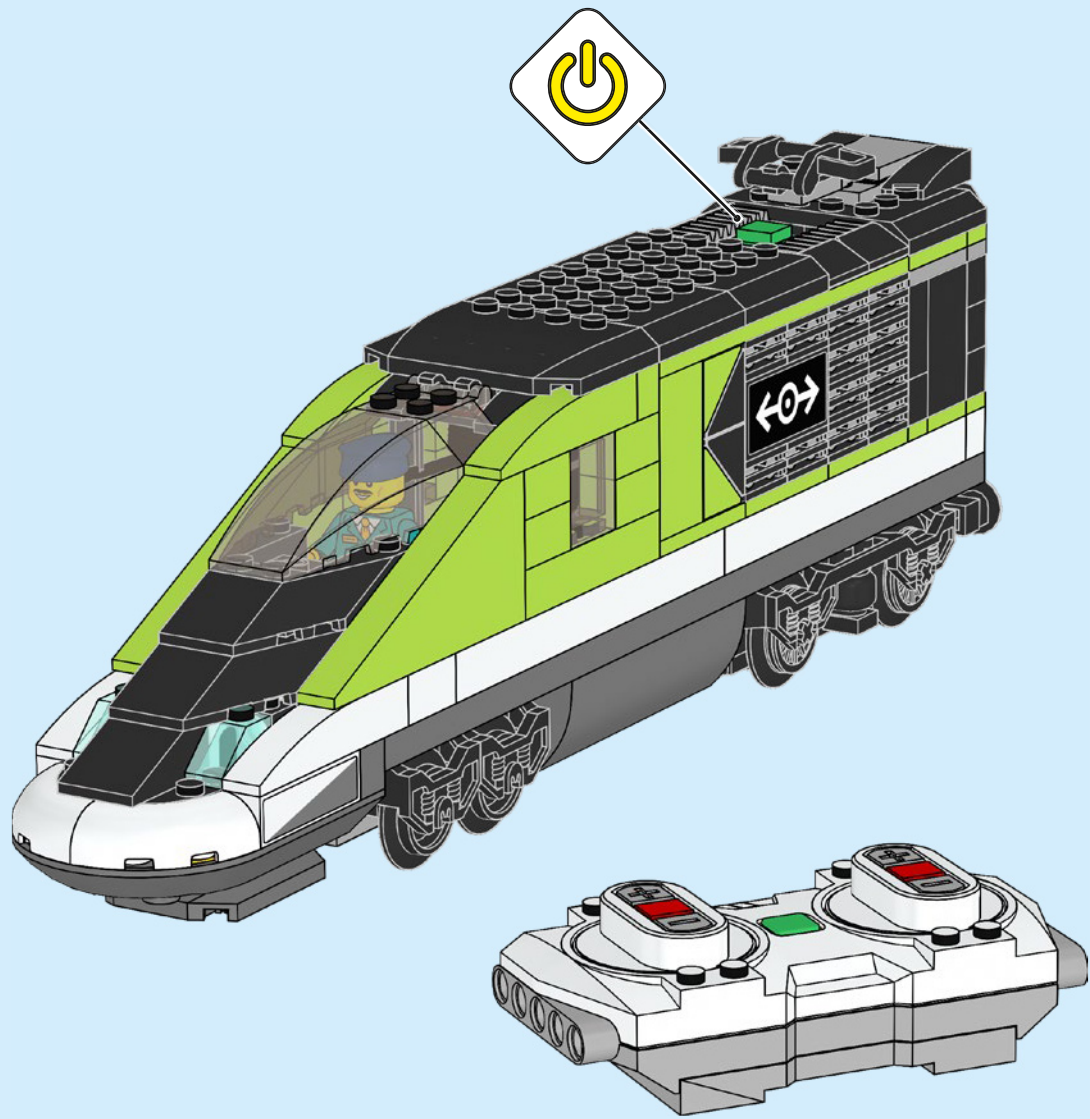



CITY

60337



4

5

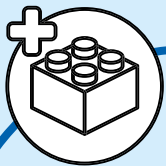

2x

4

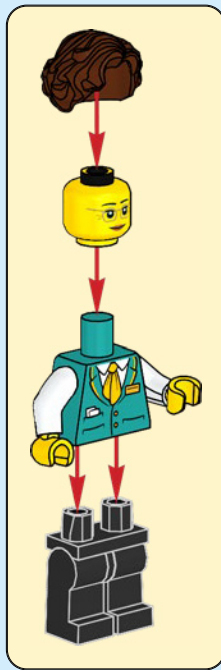

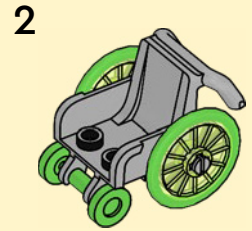
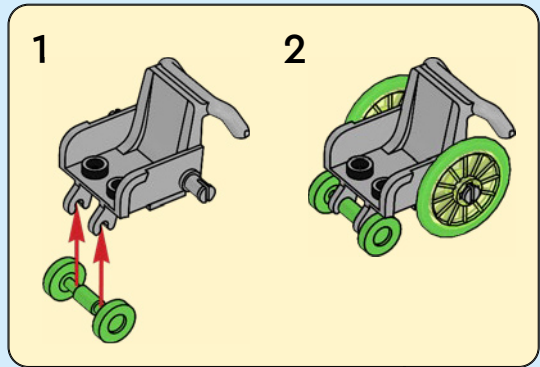
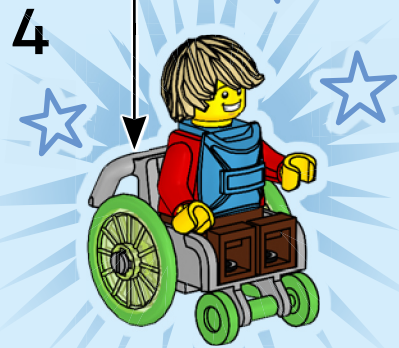
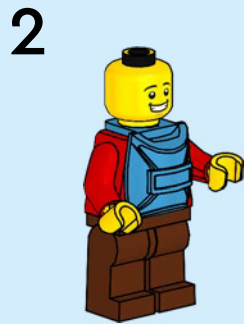
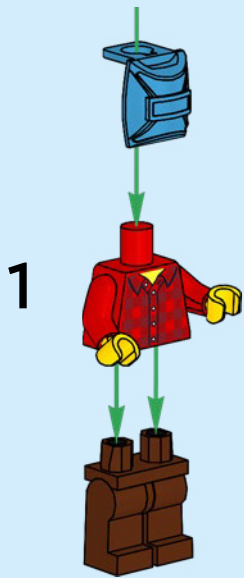

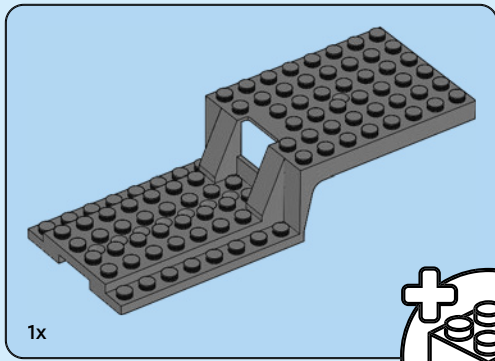

1x

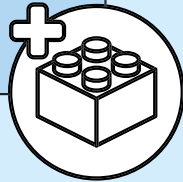

1

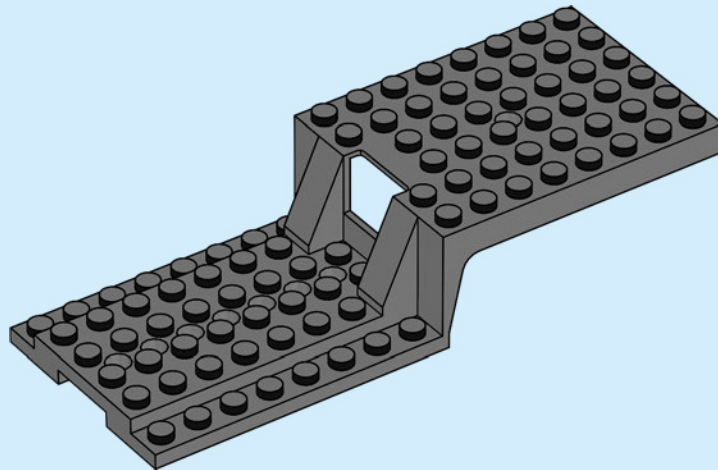

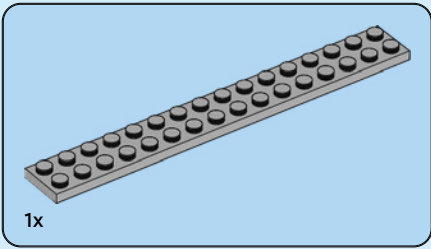

2

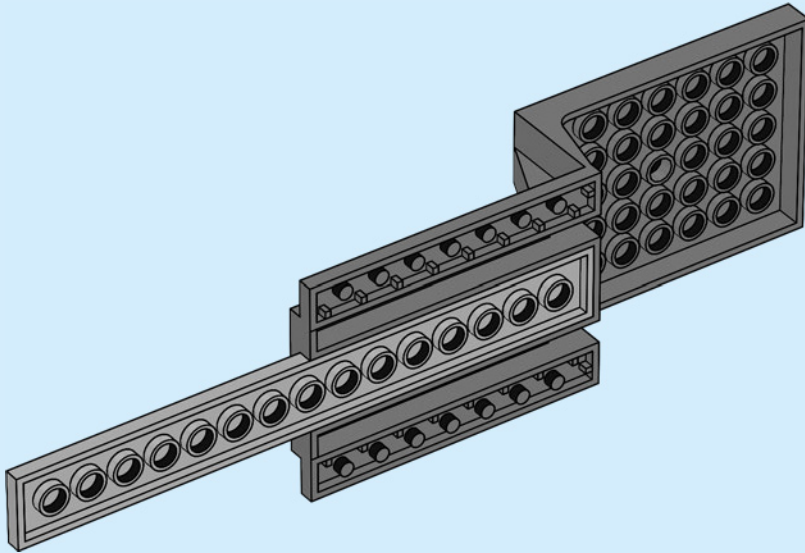

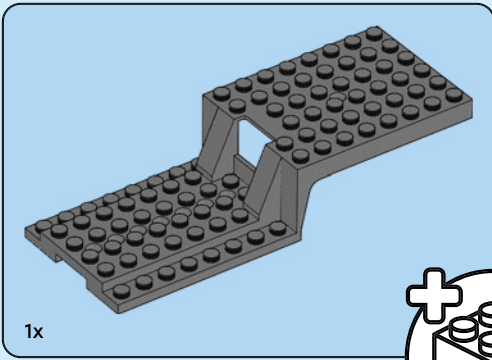

1x

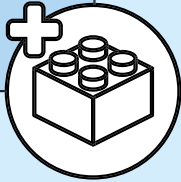

3

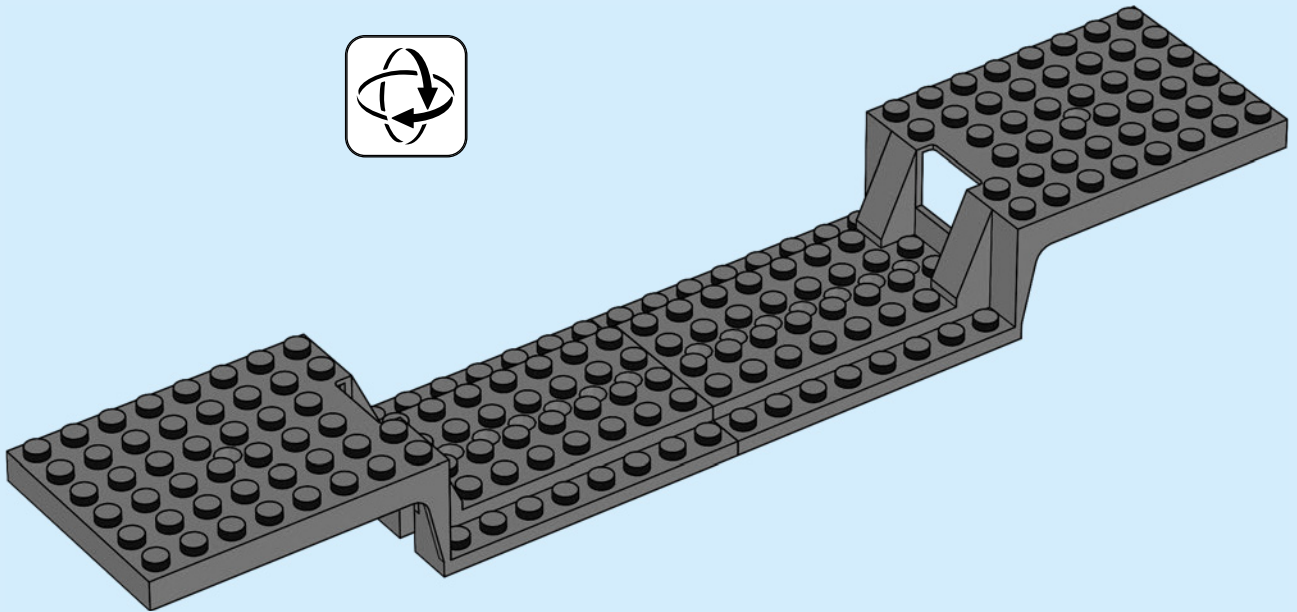
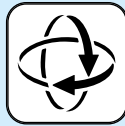

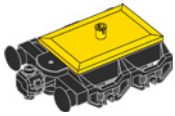

2x

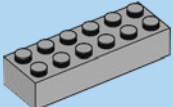

2x



2x



2x

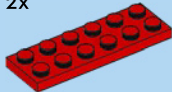

2x

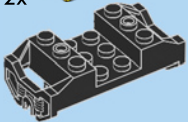

4x

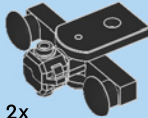

2x

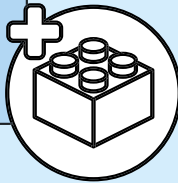

4

1

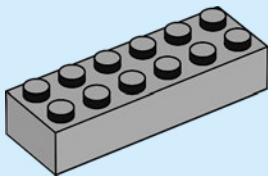

2

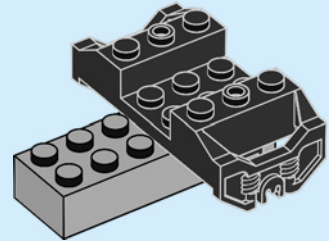

3

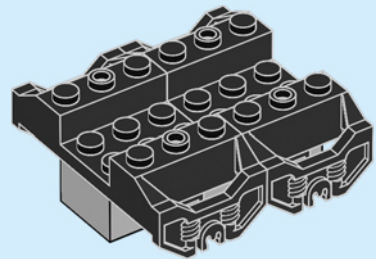

4

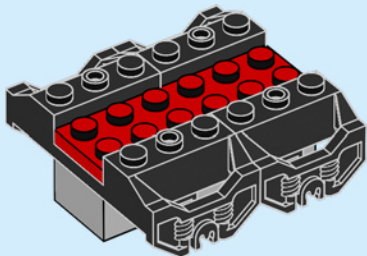

5

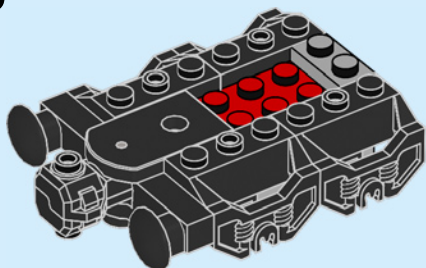

6

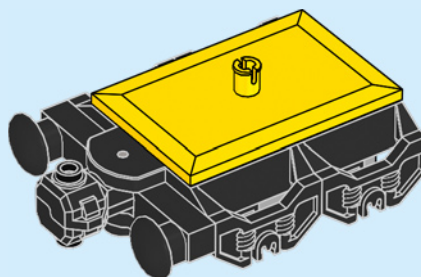

2x



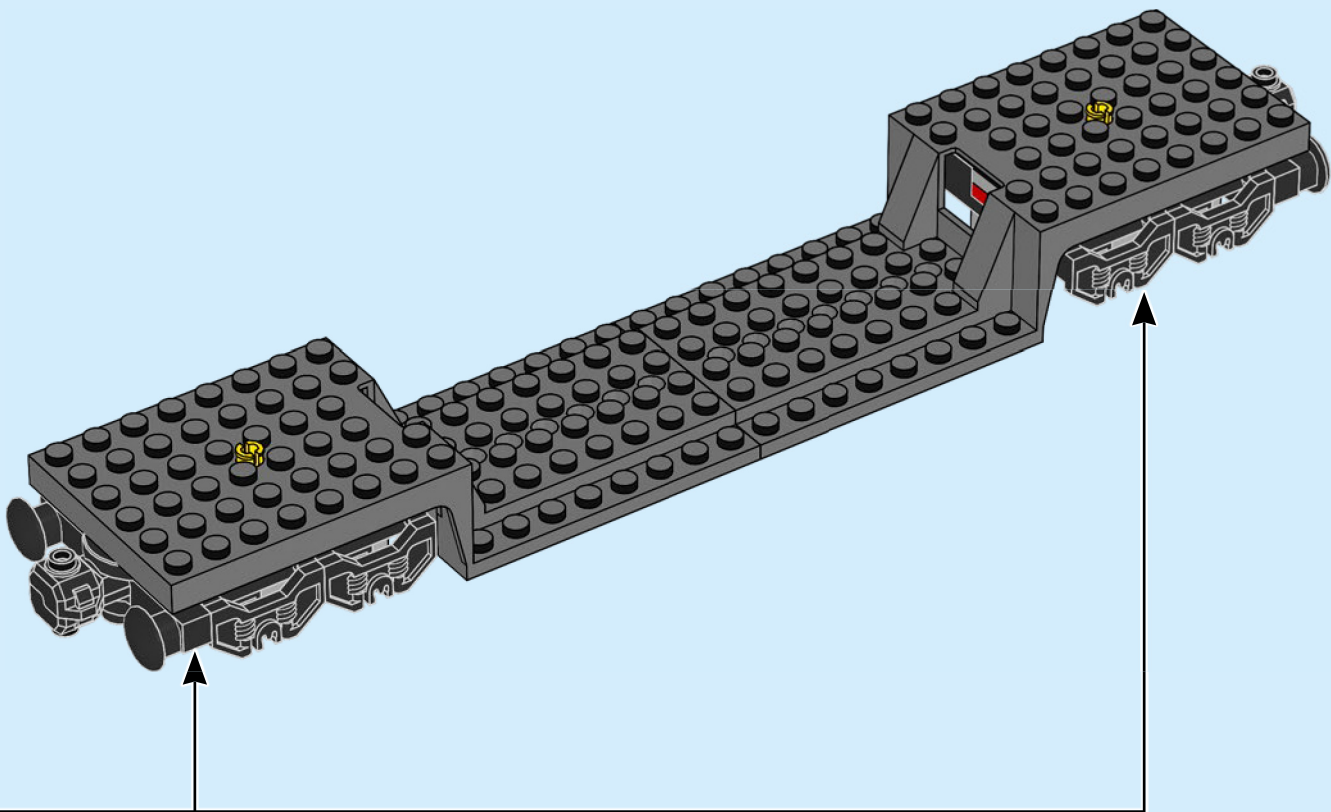

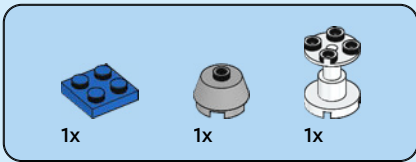

6

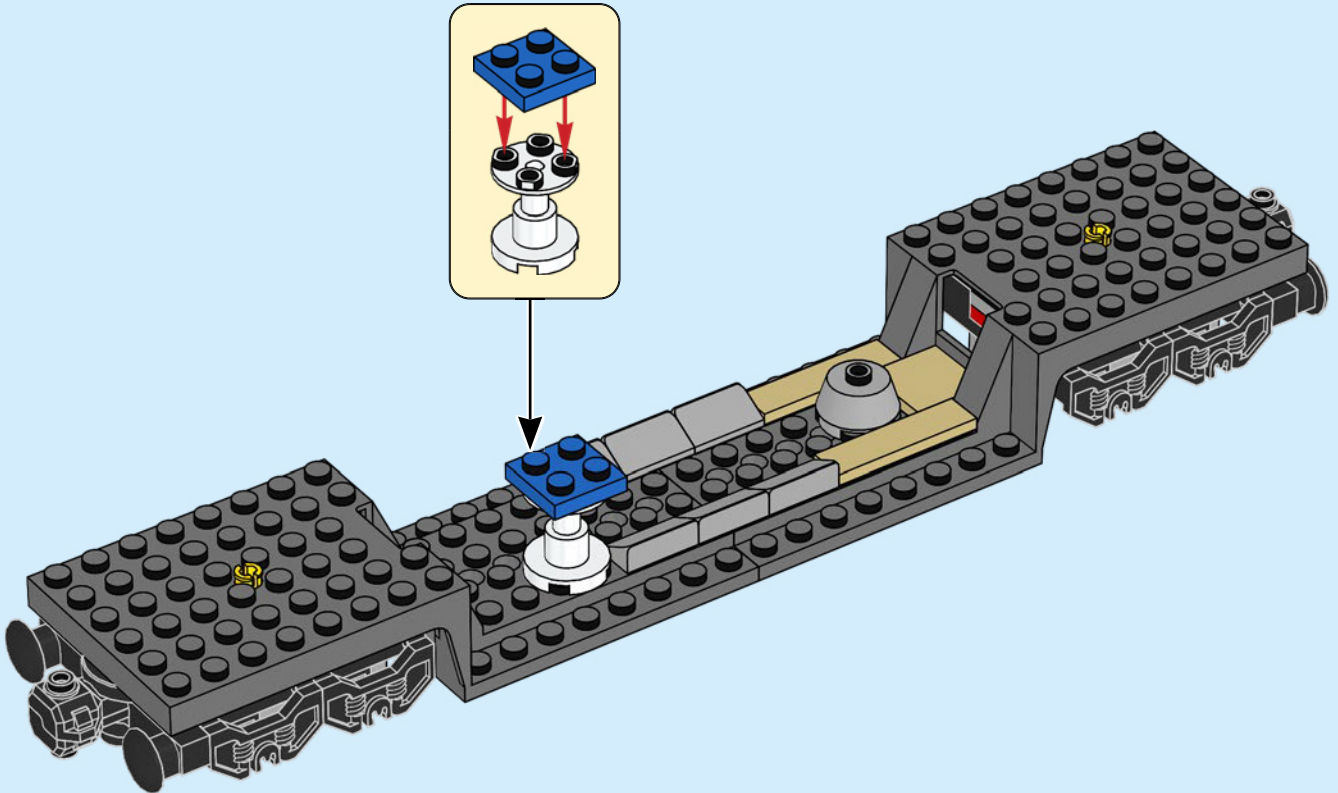

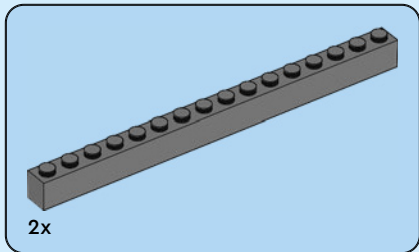

7

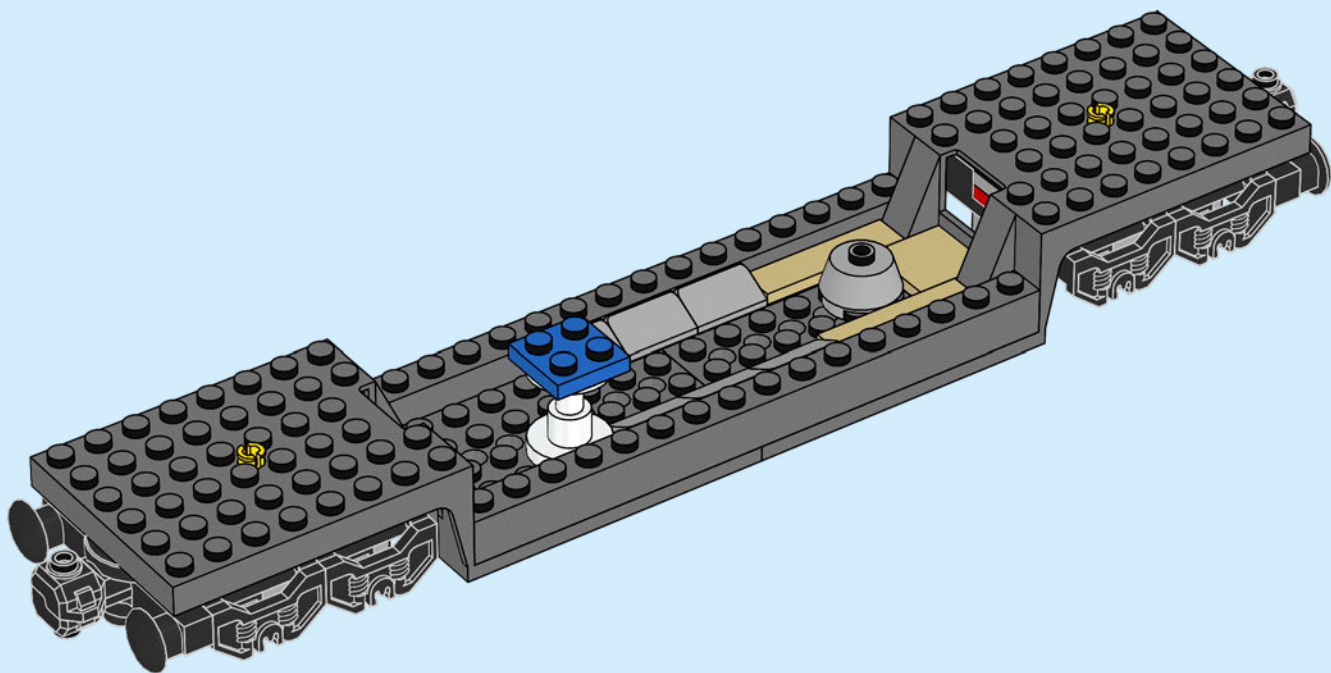

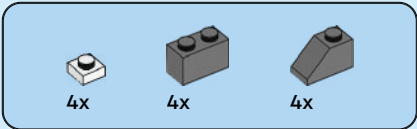

8

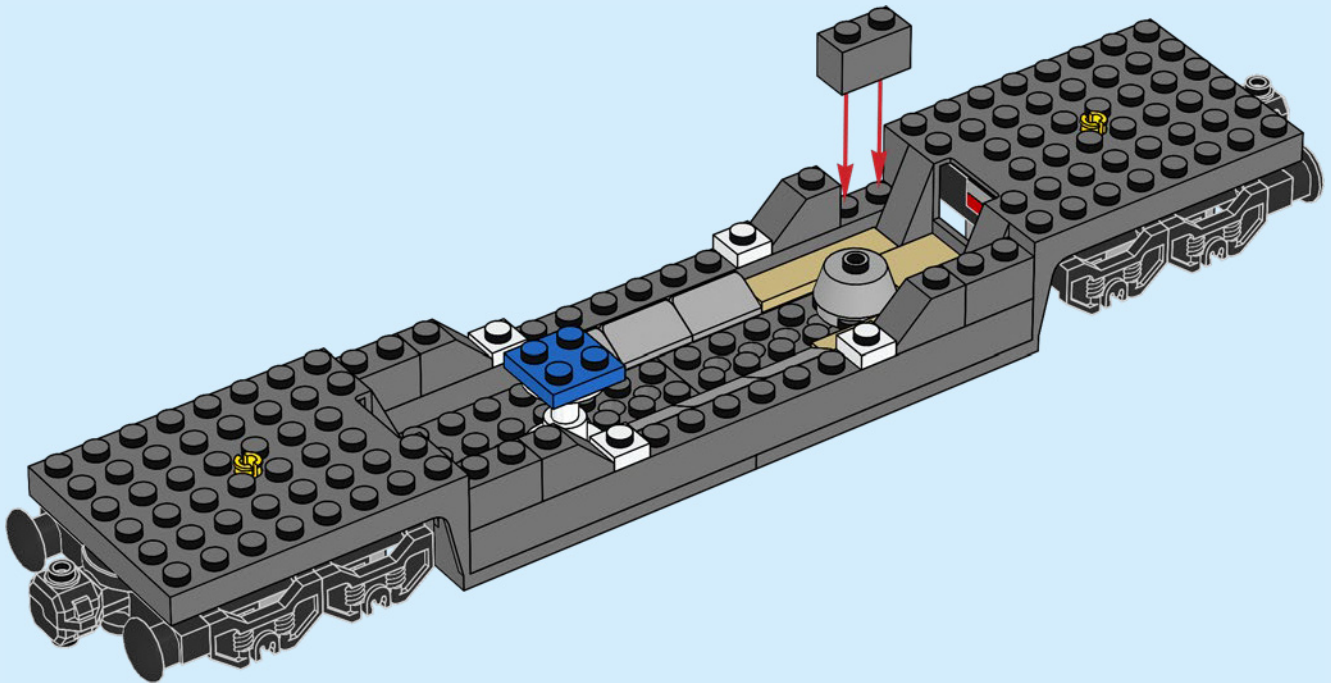

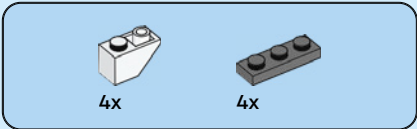

9

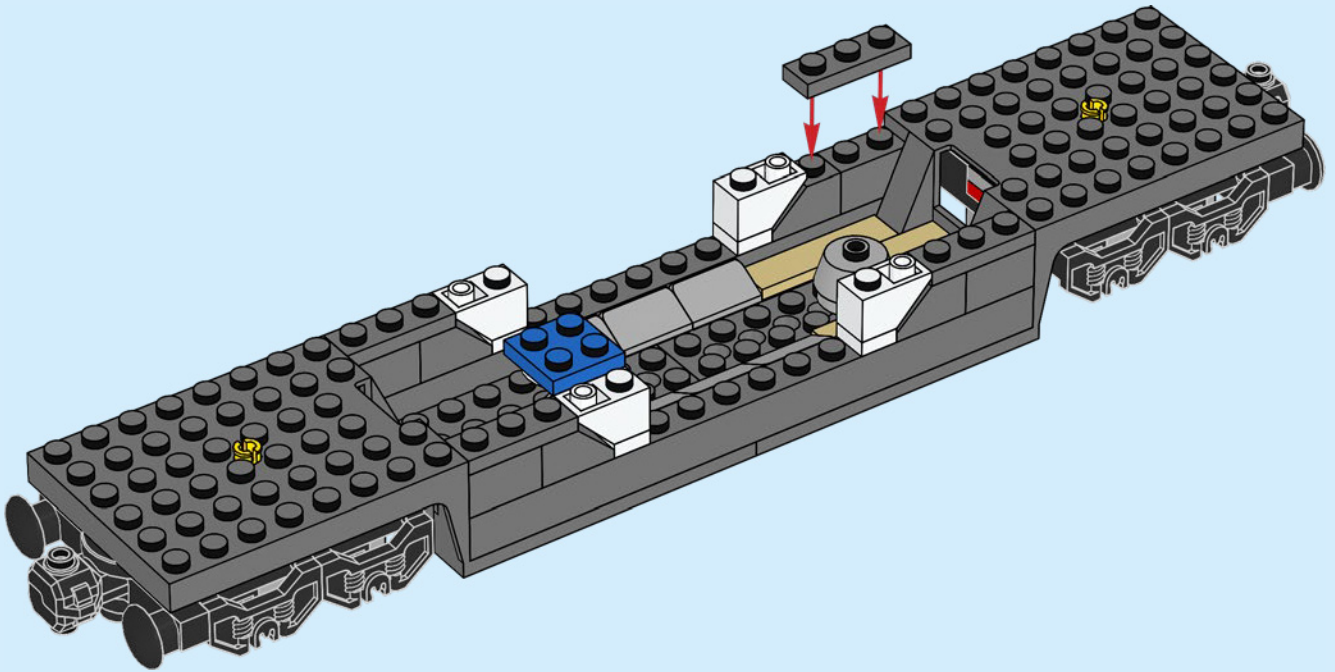



2x

10

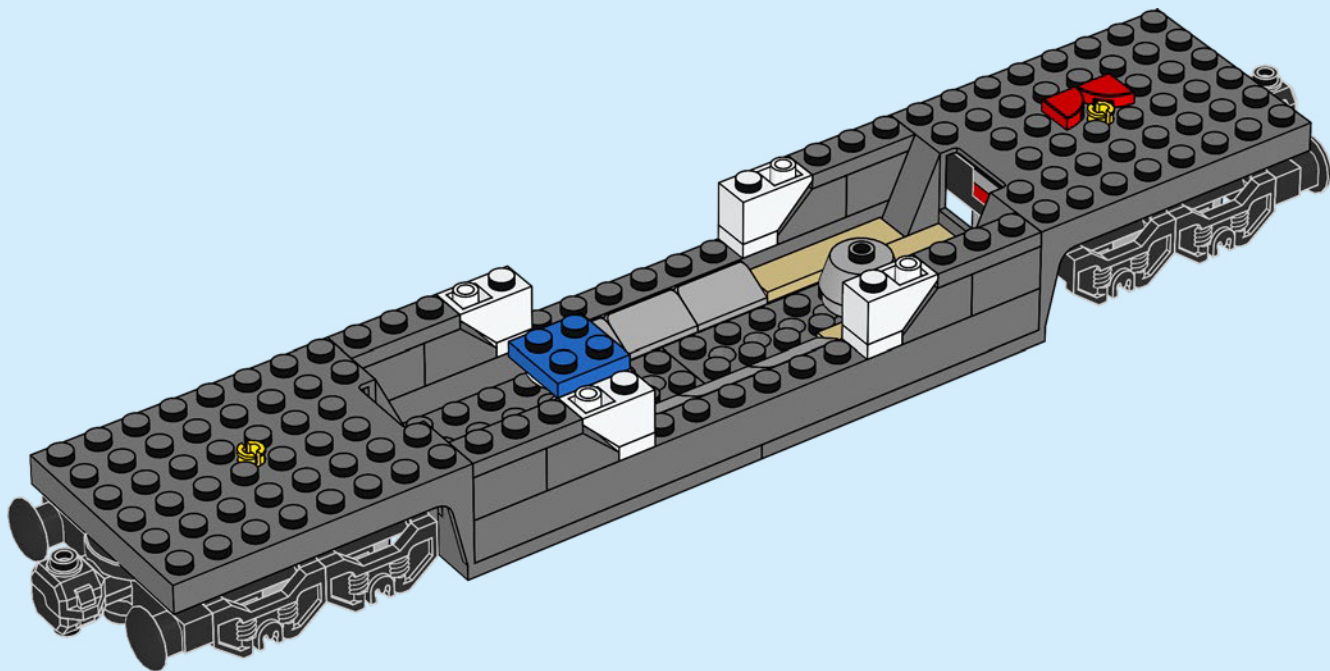

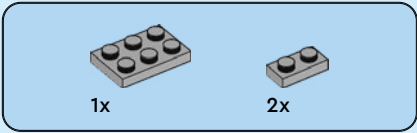

11

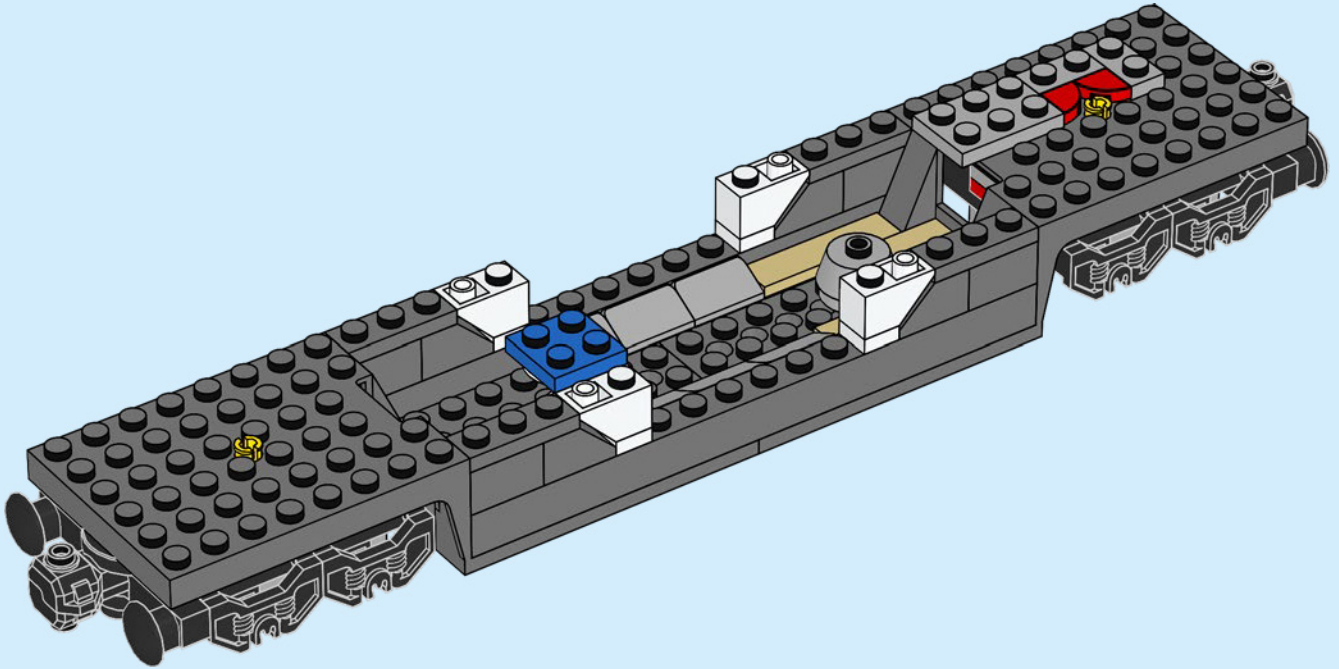

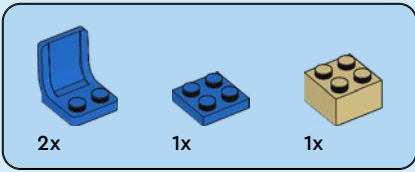

12

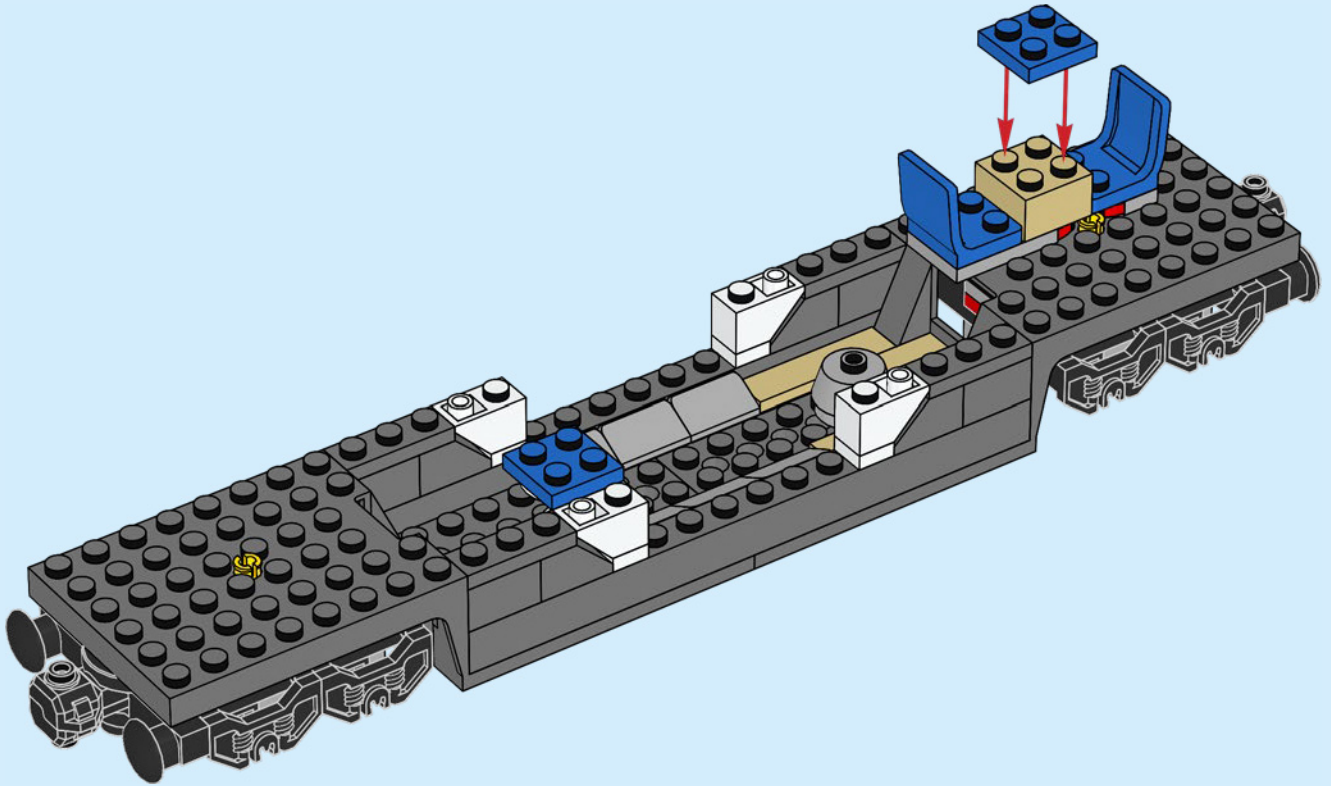

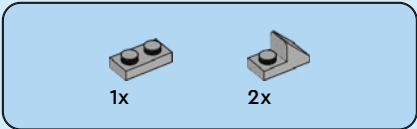

13

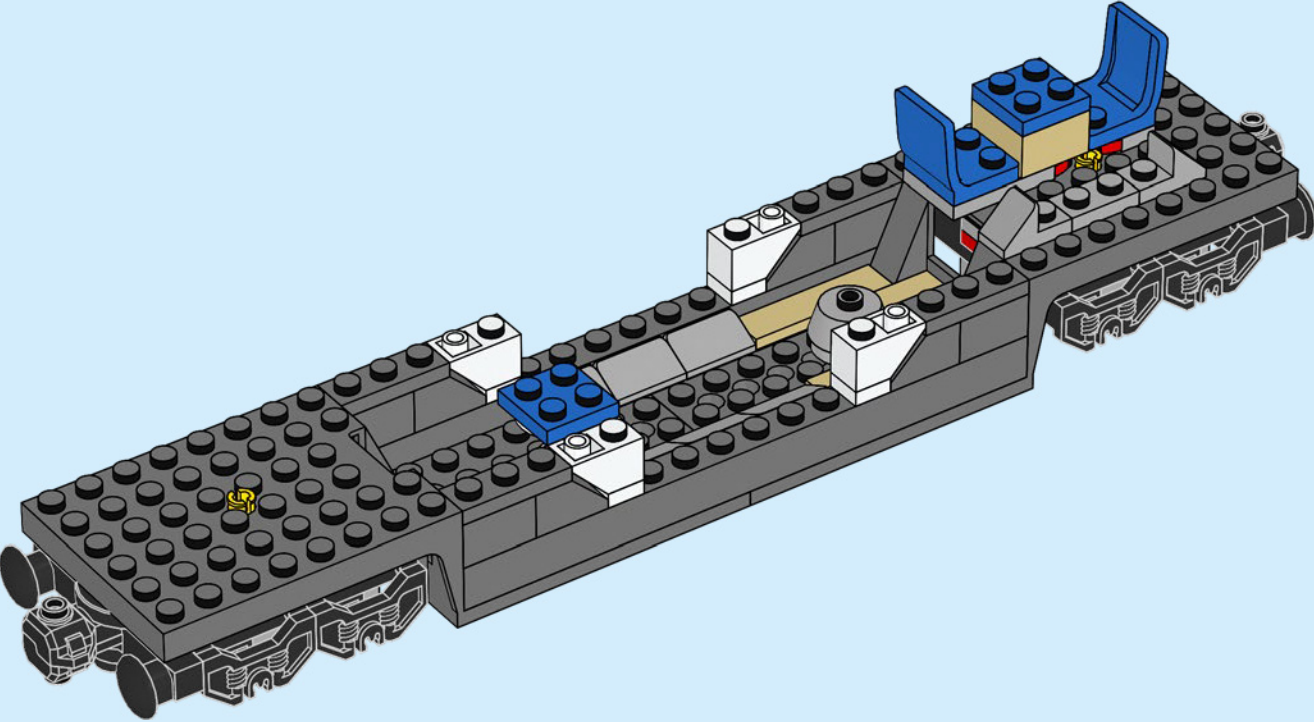

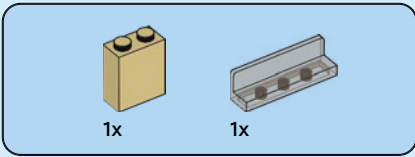

14

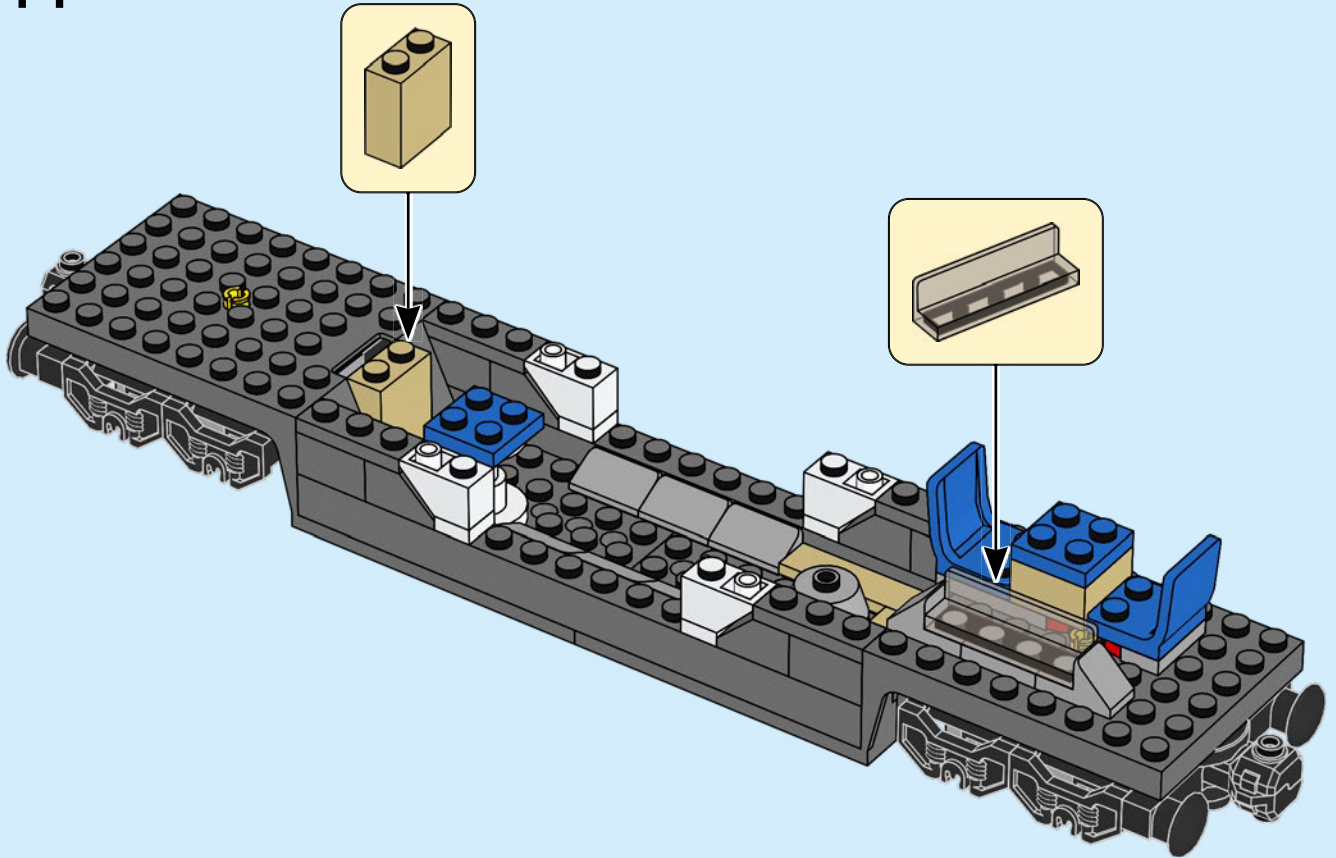

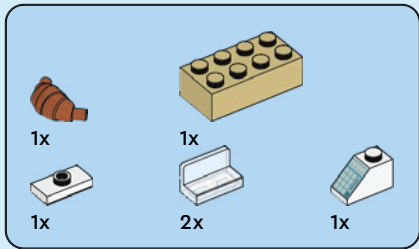

15

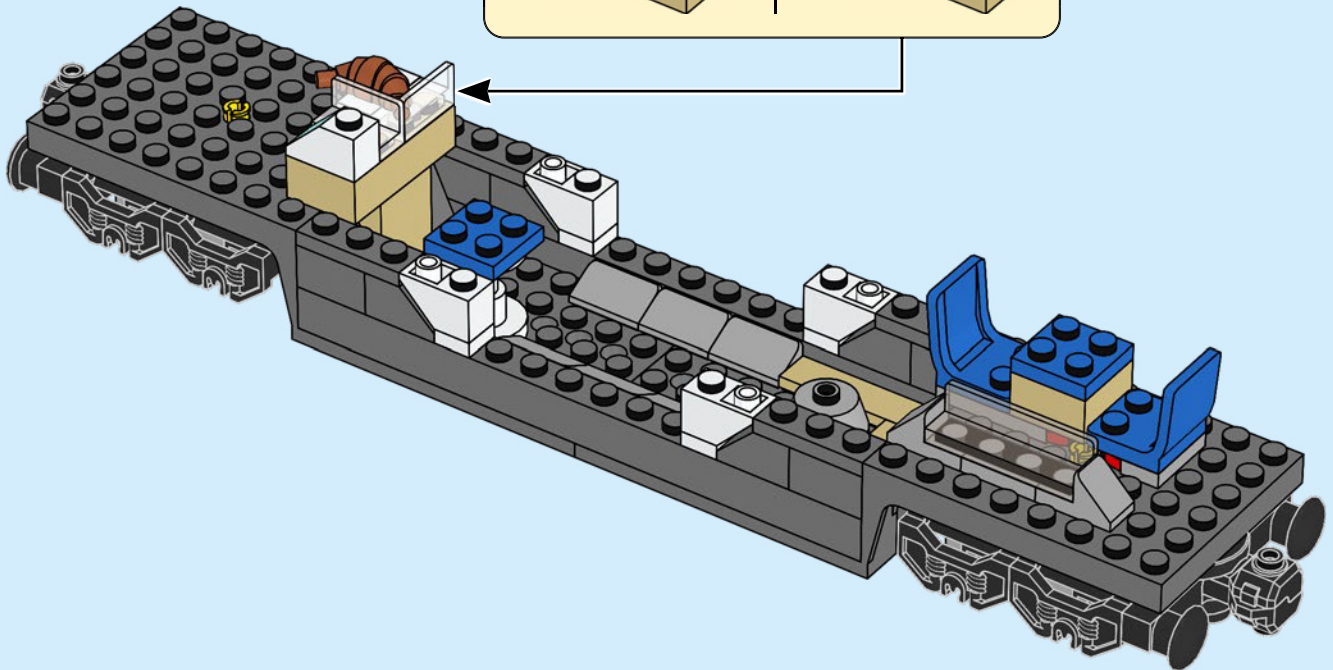
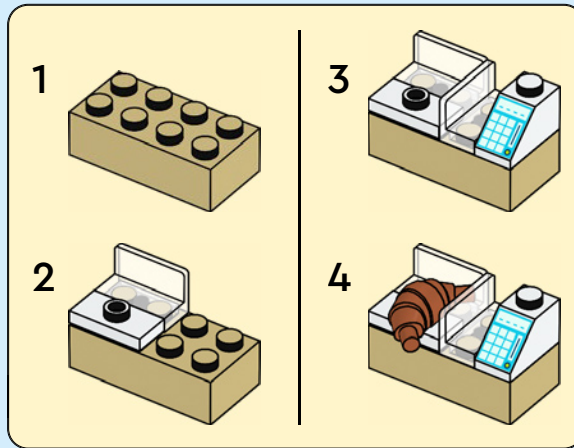



4x

16

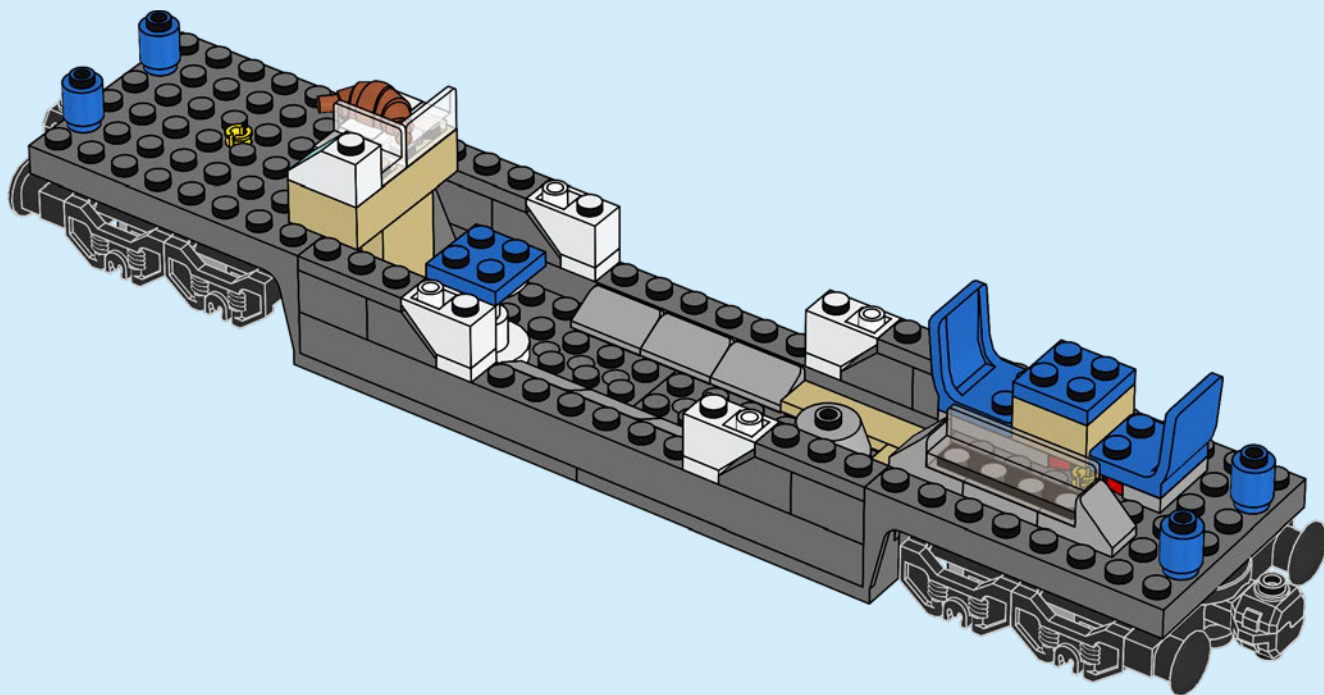

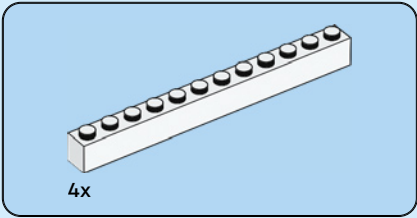

17

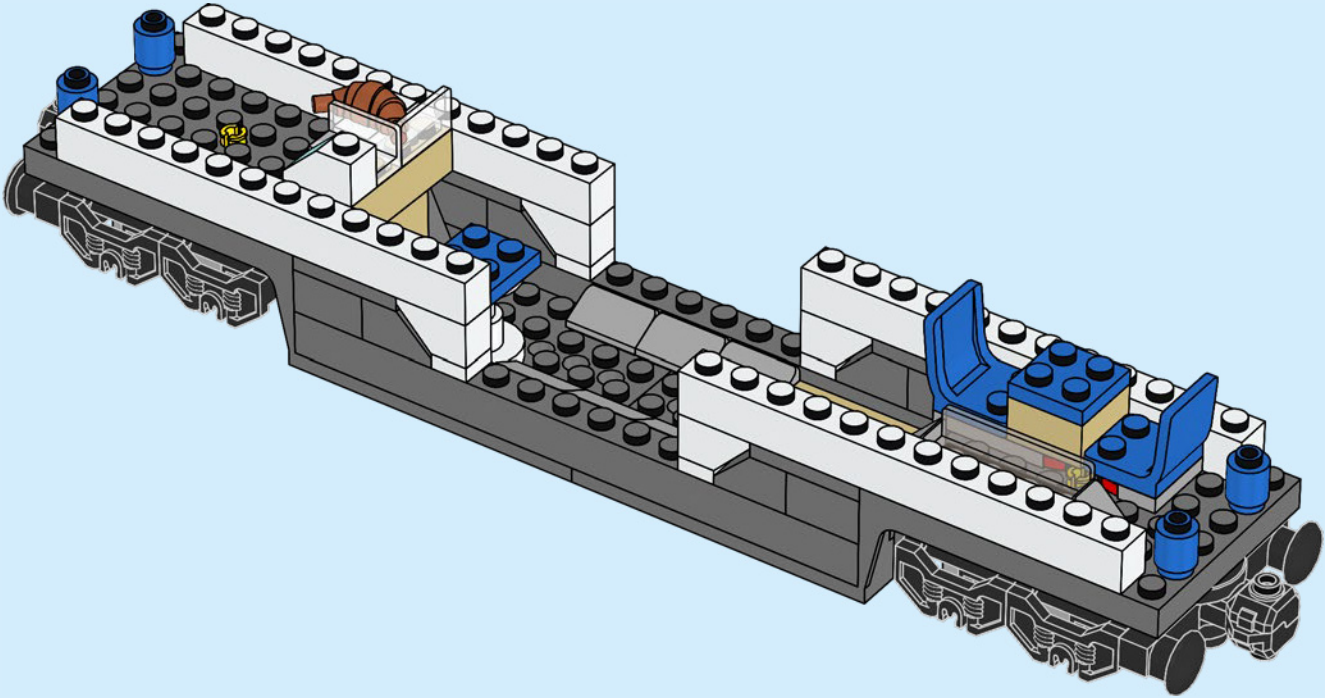

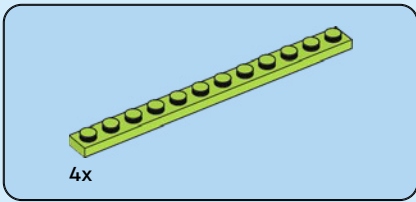

18

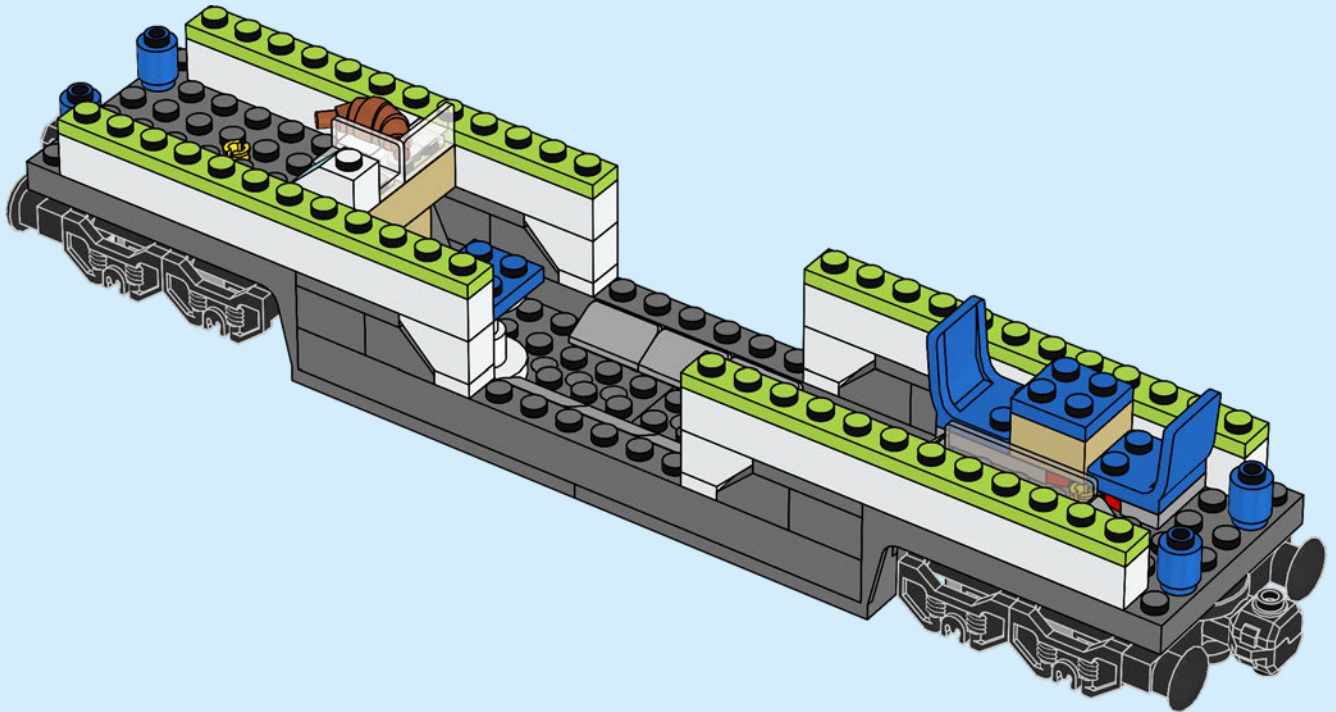

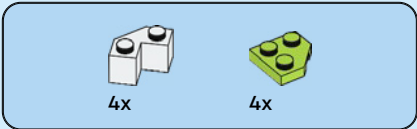

19

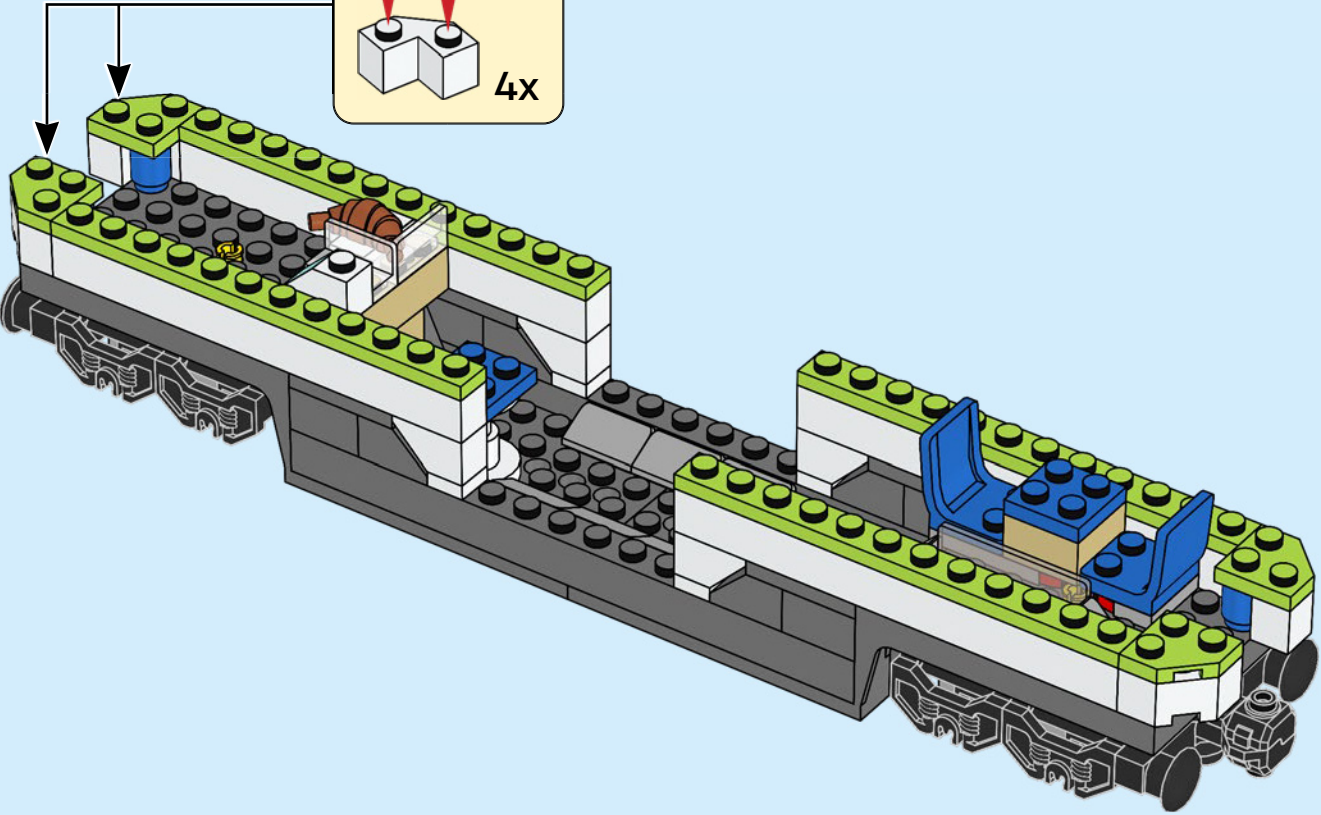
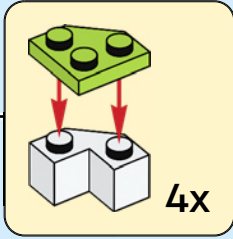



2x



2x

20

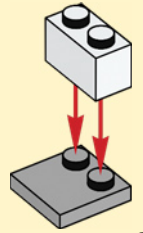

2x

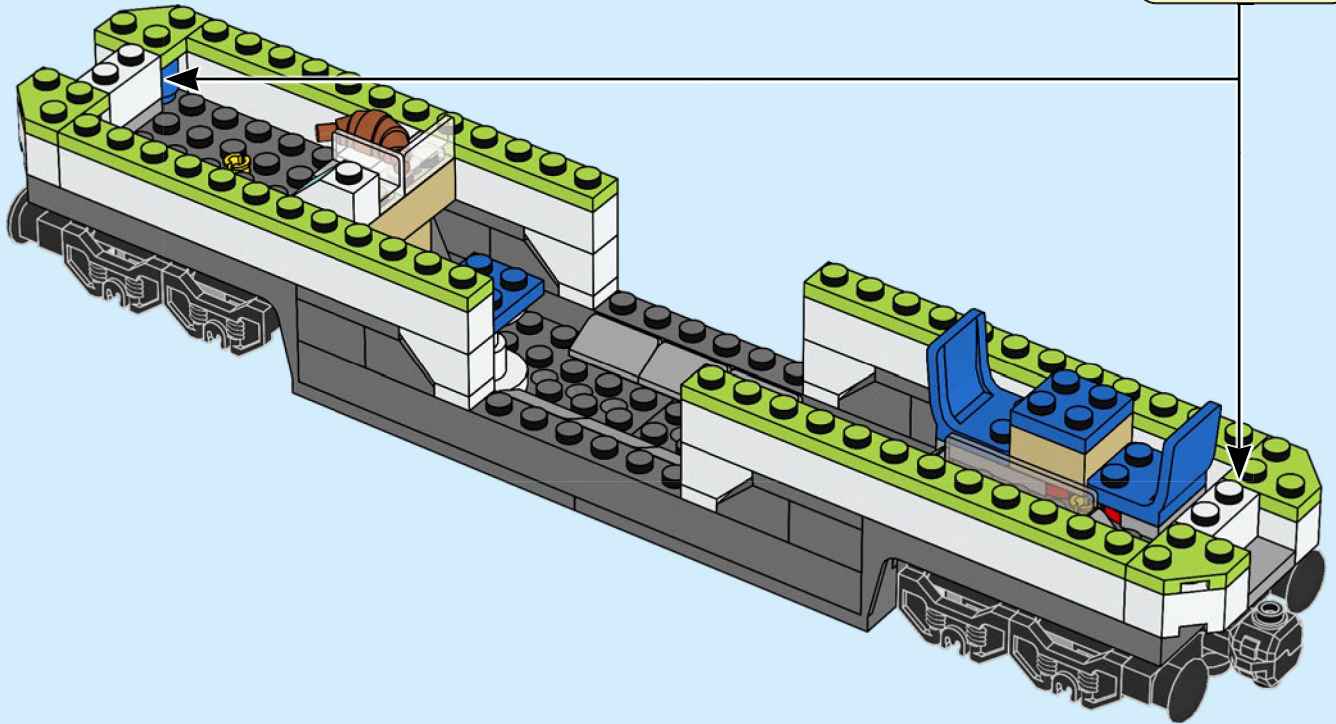



1x

21

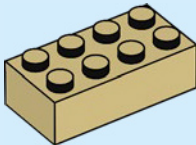

1x



1x

22

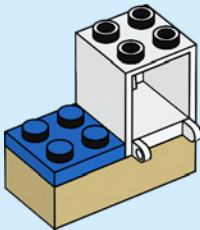

1x

23

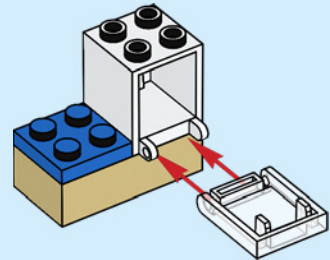

1x



1x

24

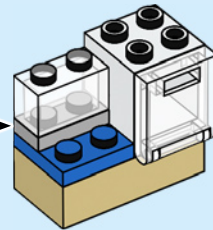
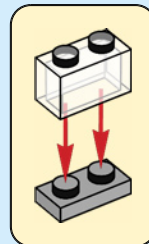



2x

25

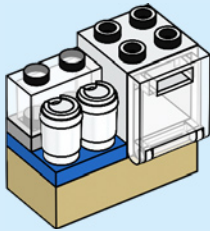

2x

26

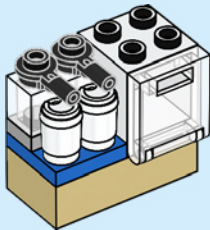

1x

27

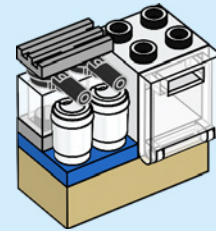

1x



1x

28

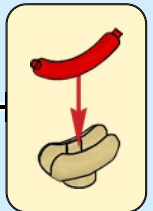
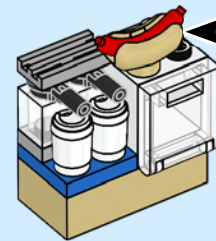

29

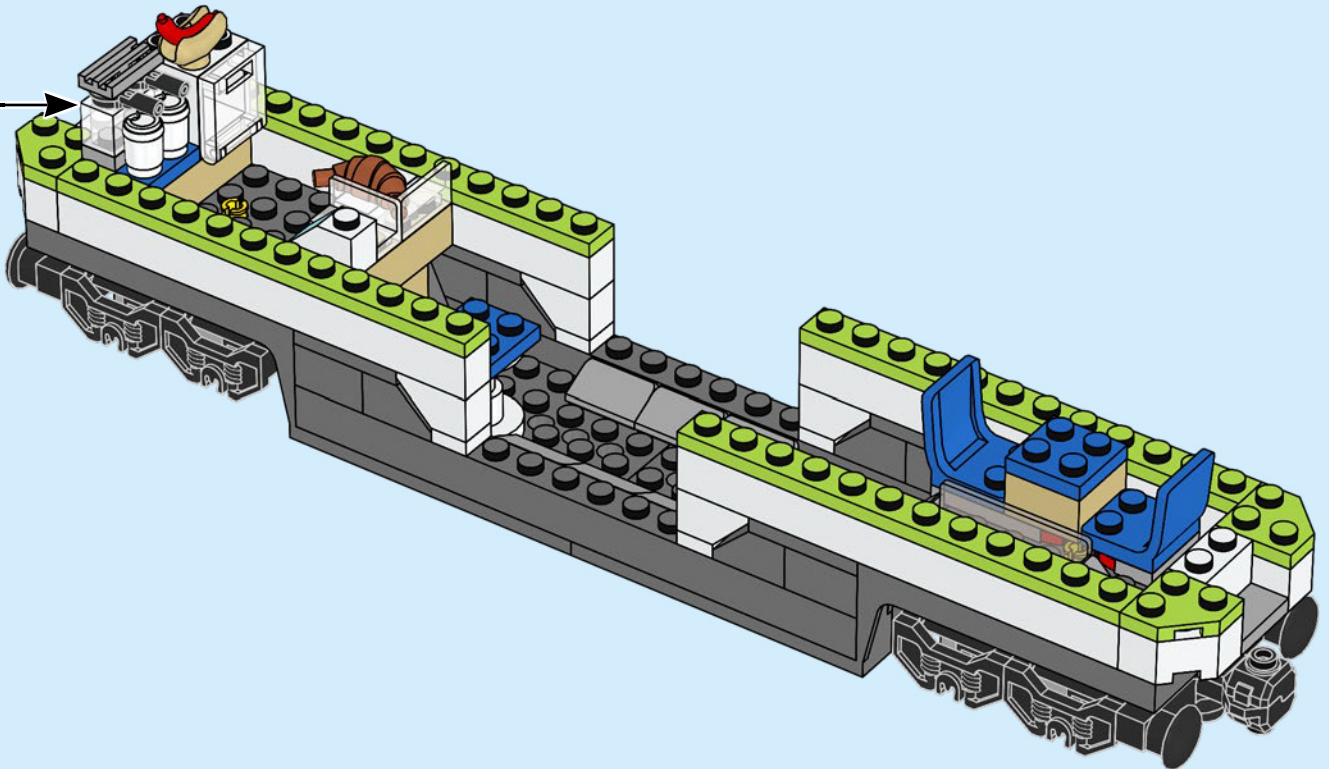





2x

30

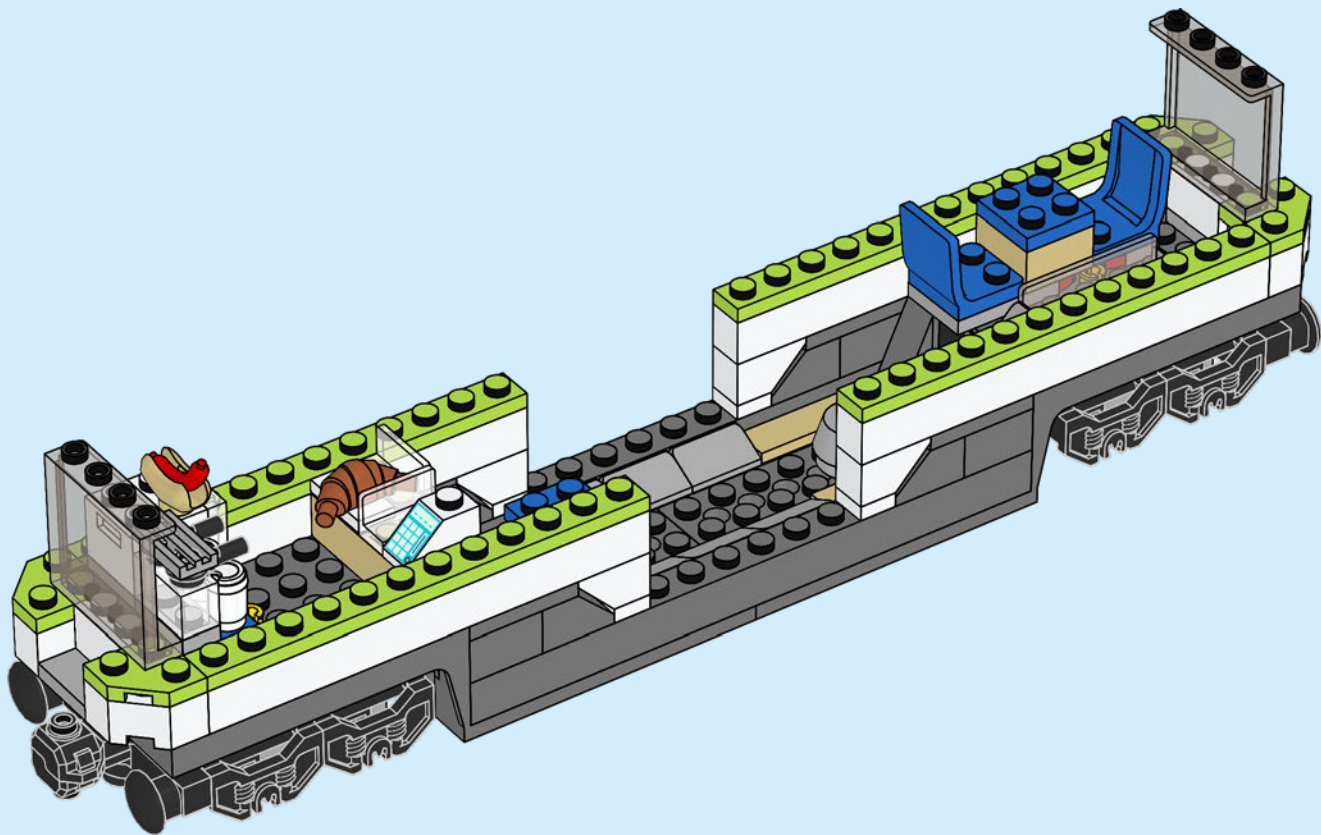



12x

31

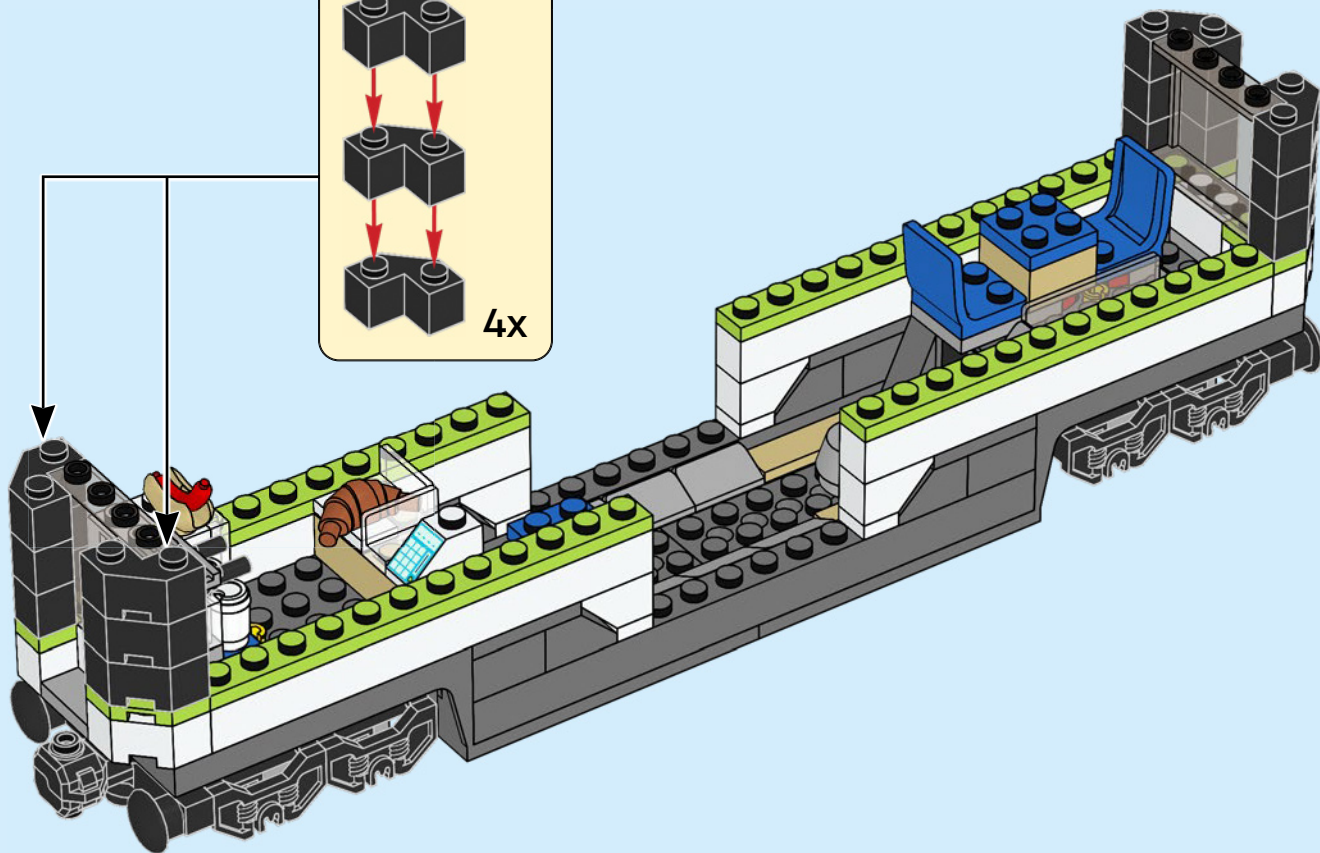
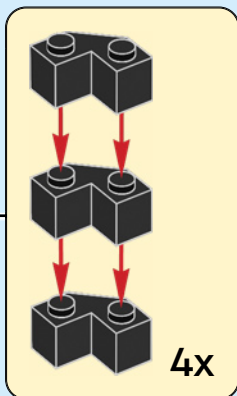



4x

32

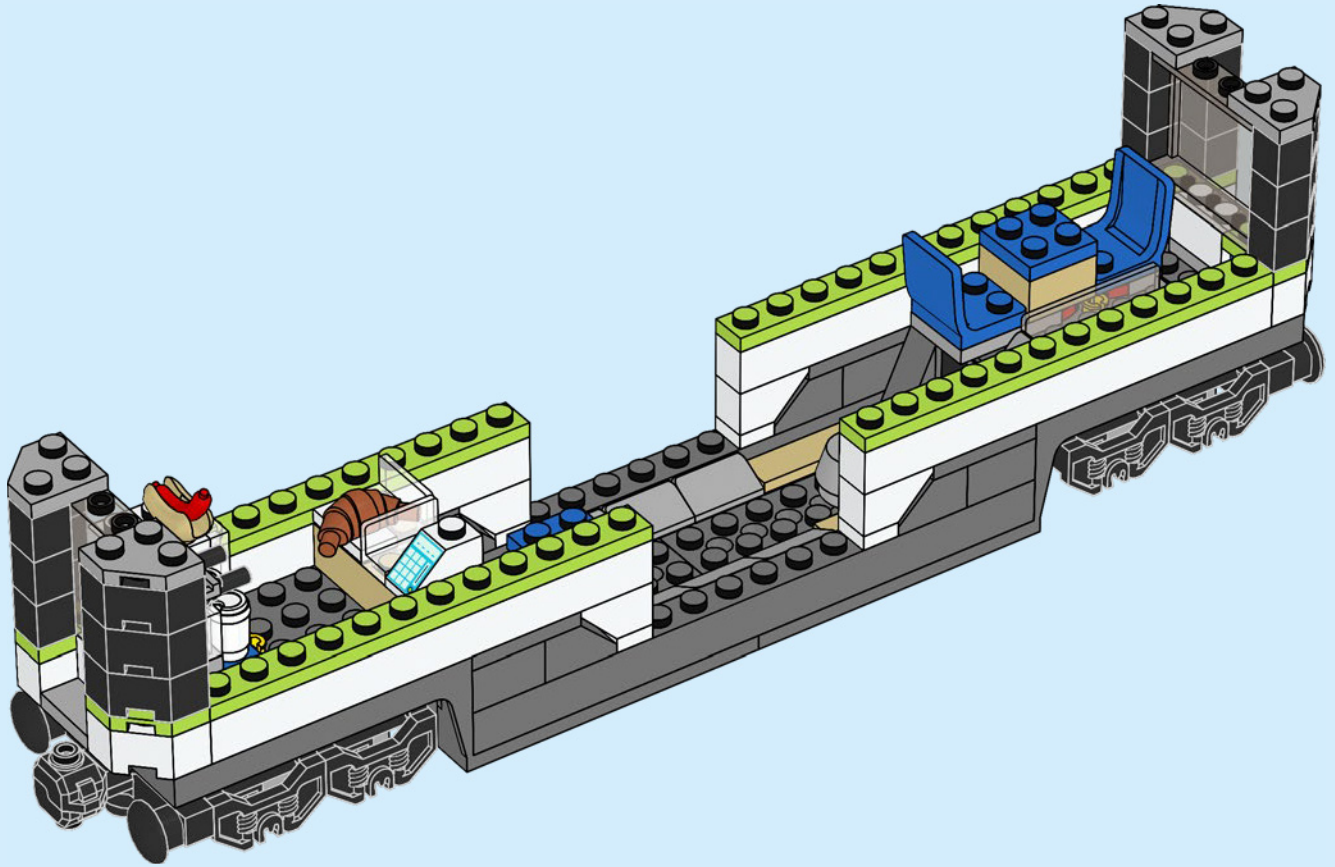



20x

33

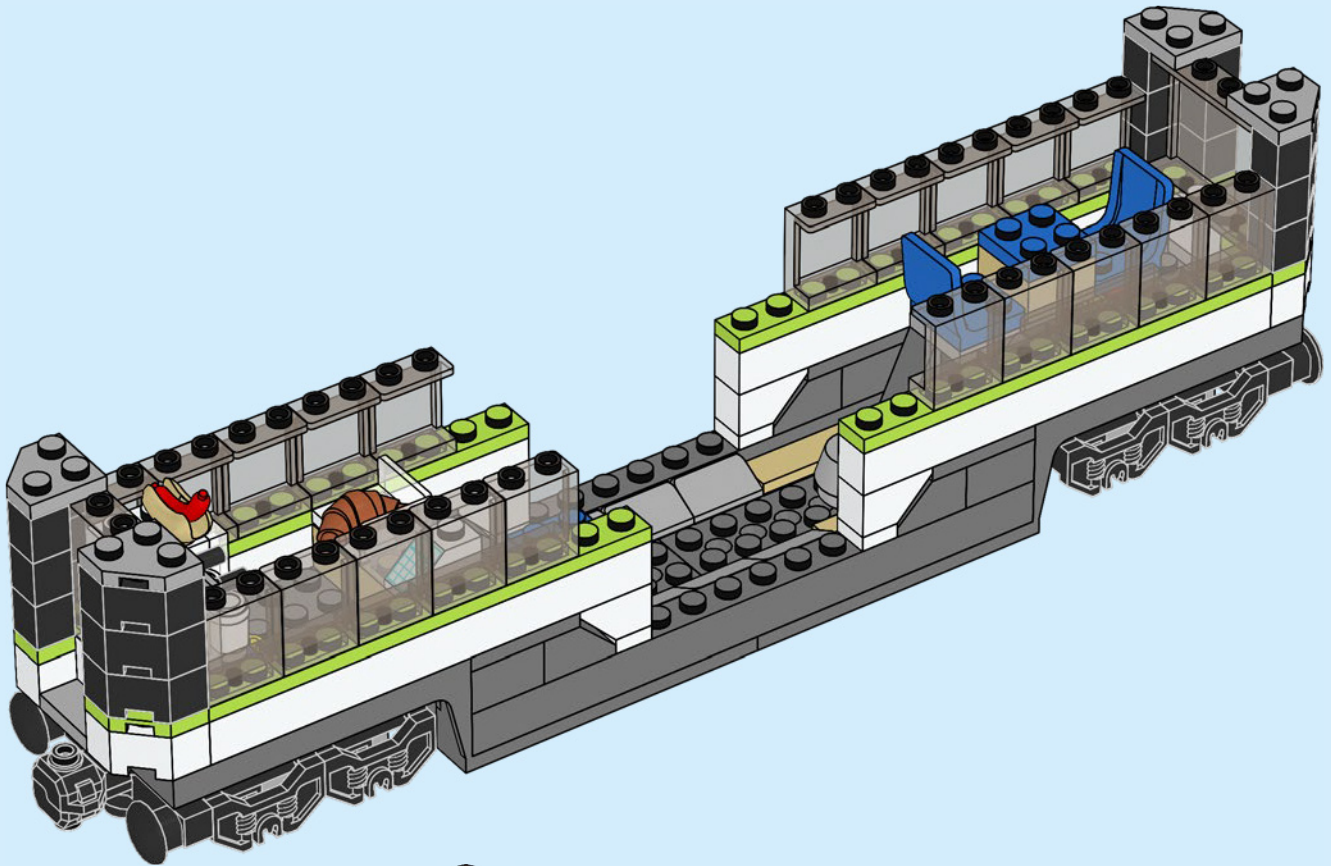

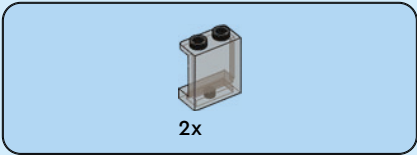

34

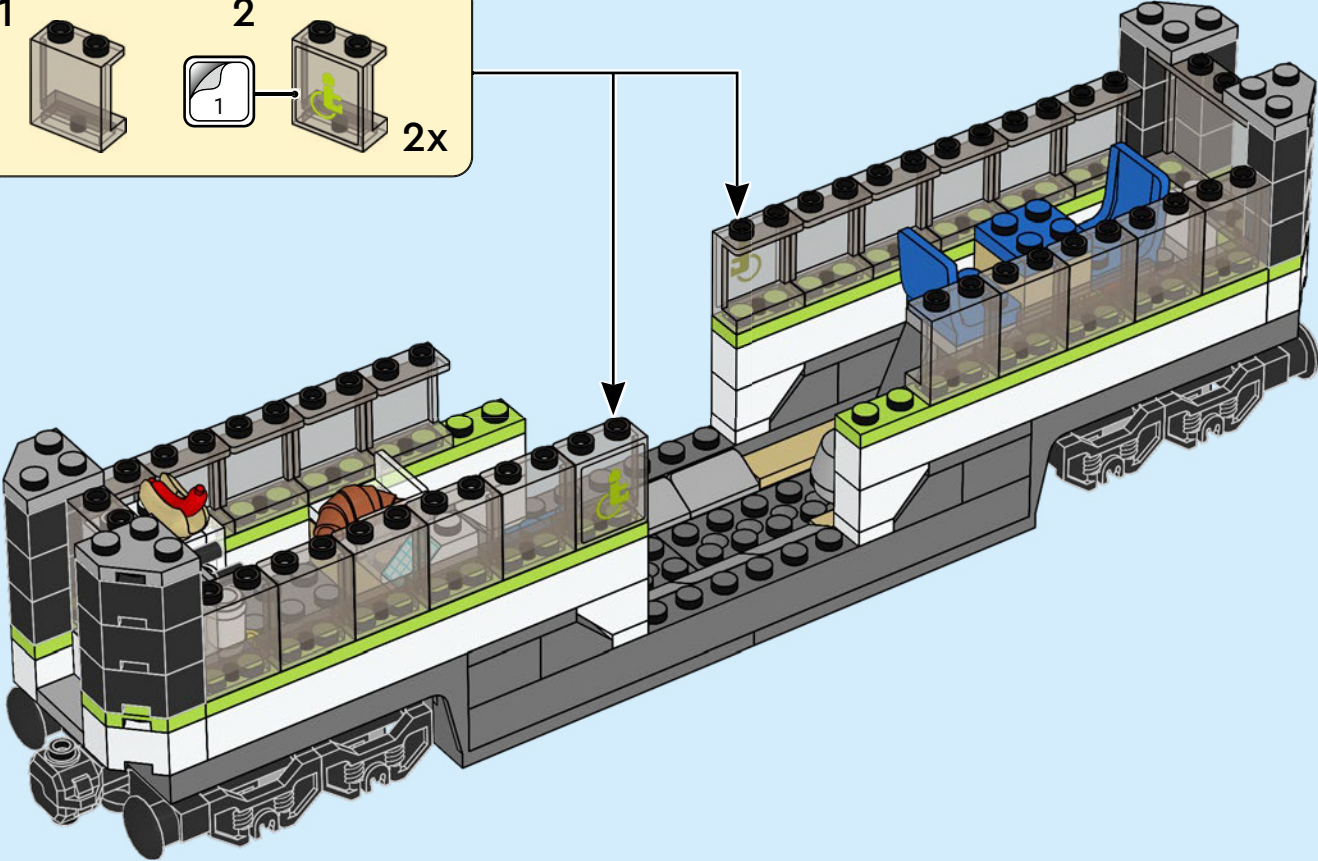
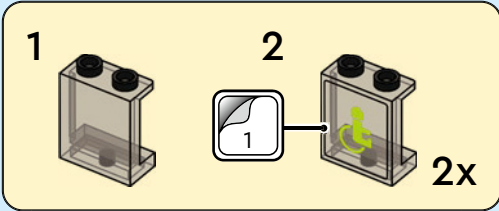

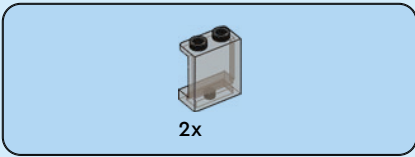

35

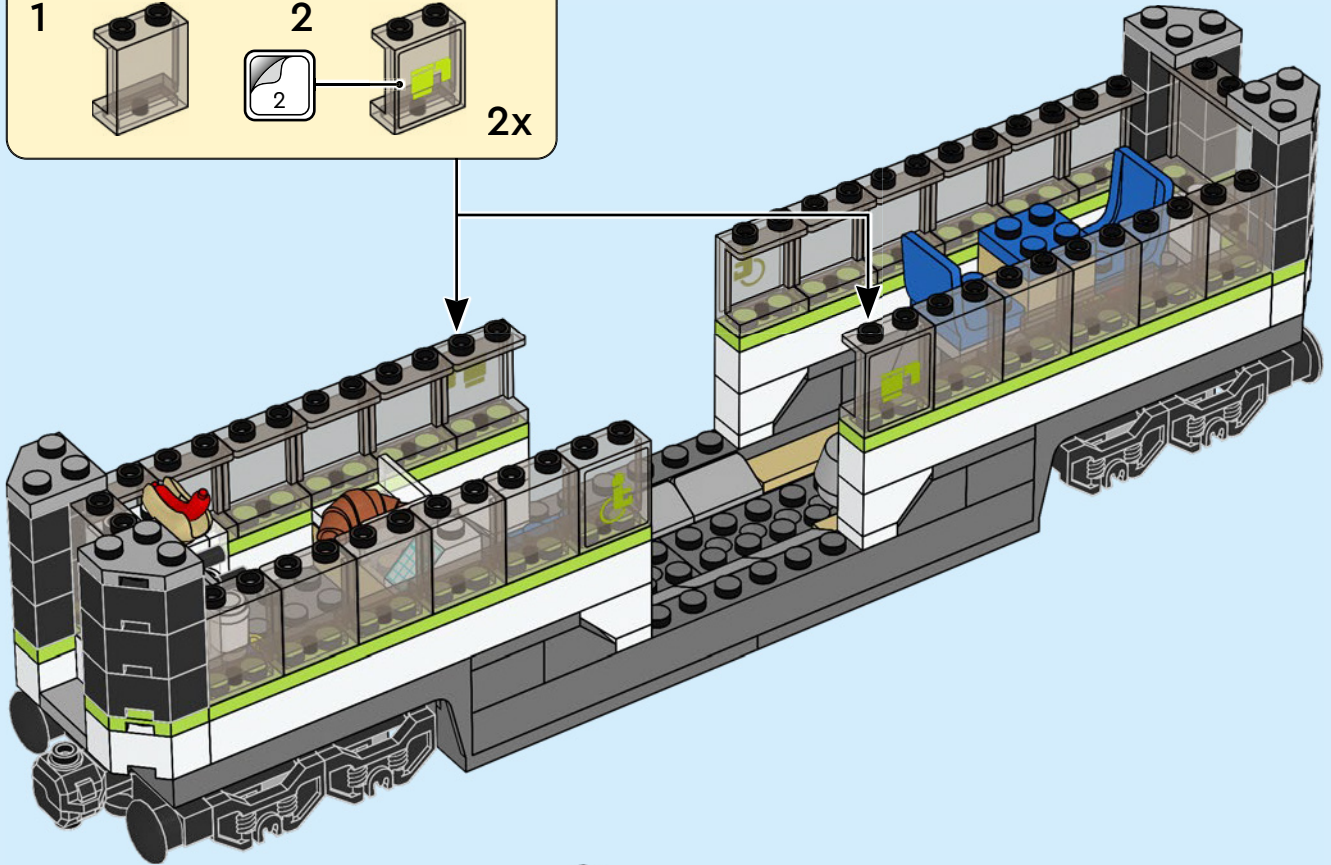
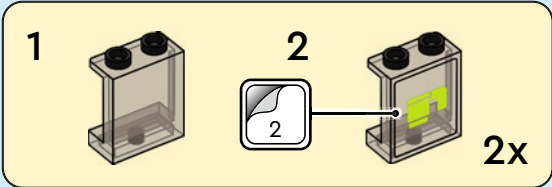

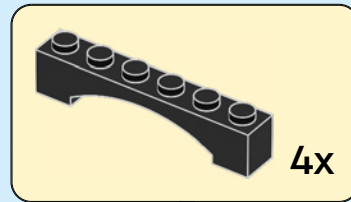
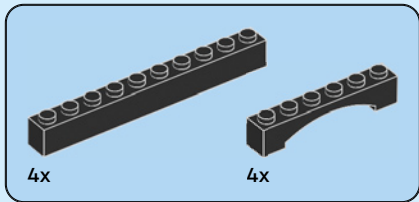

36

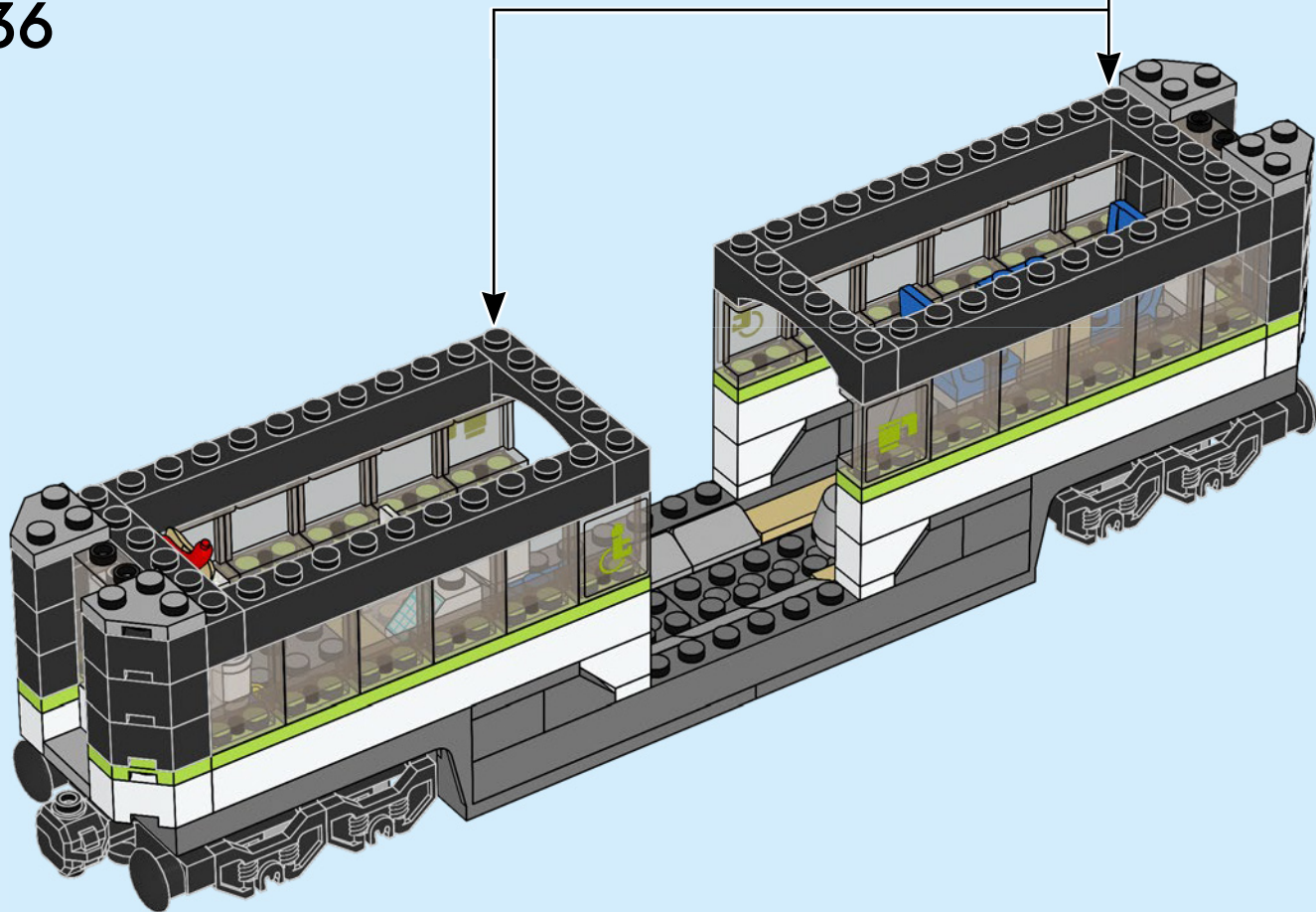

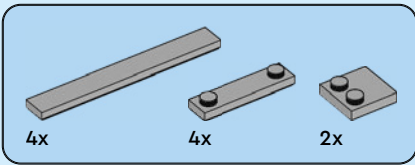

37

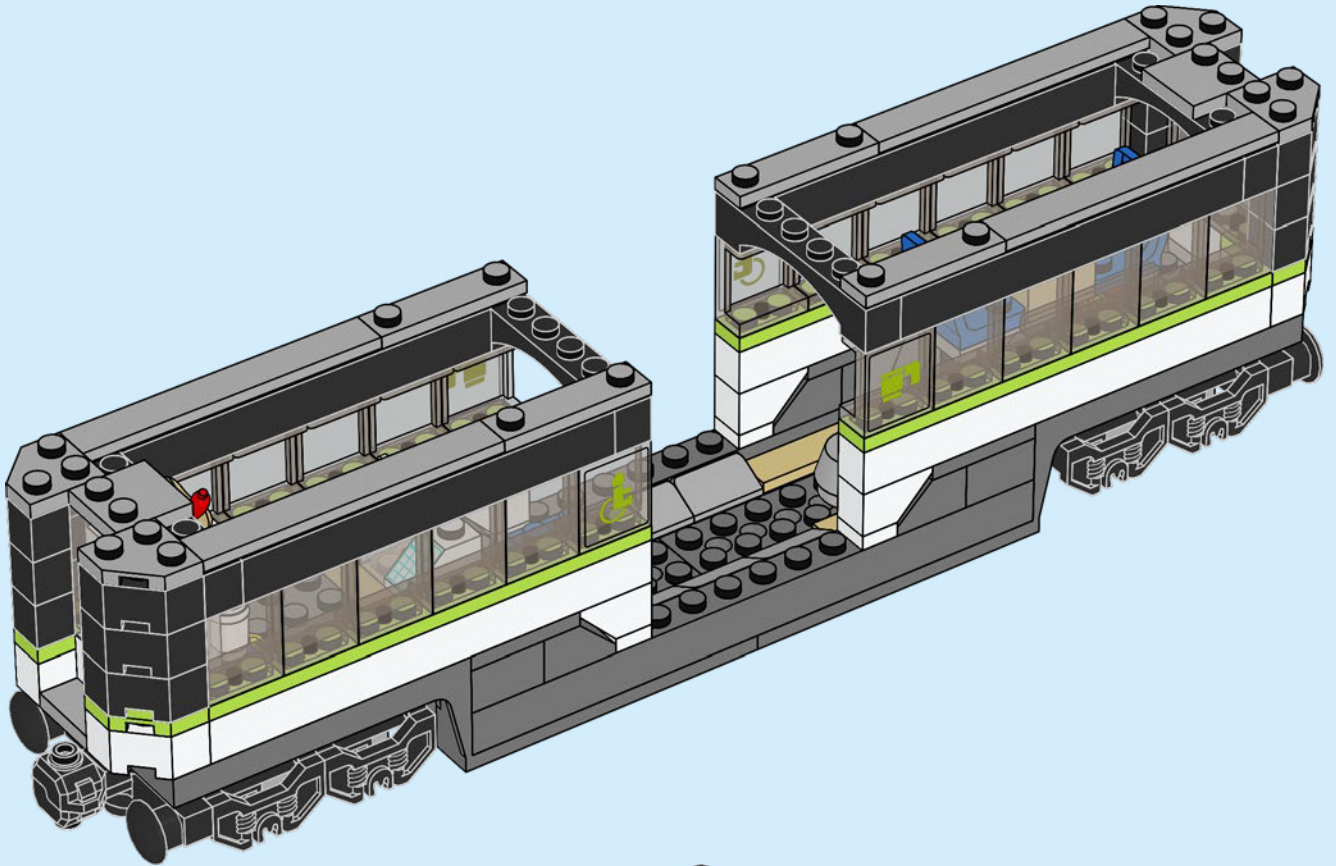

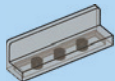

2x

38

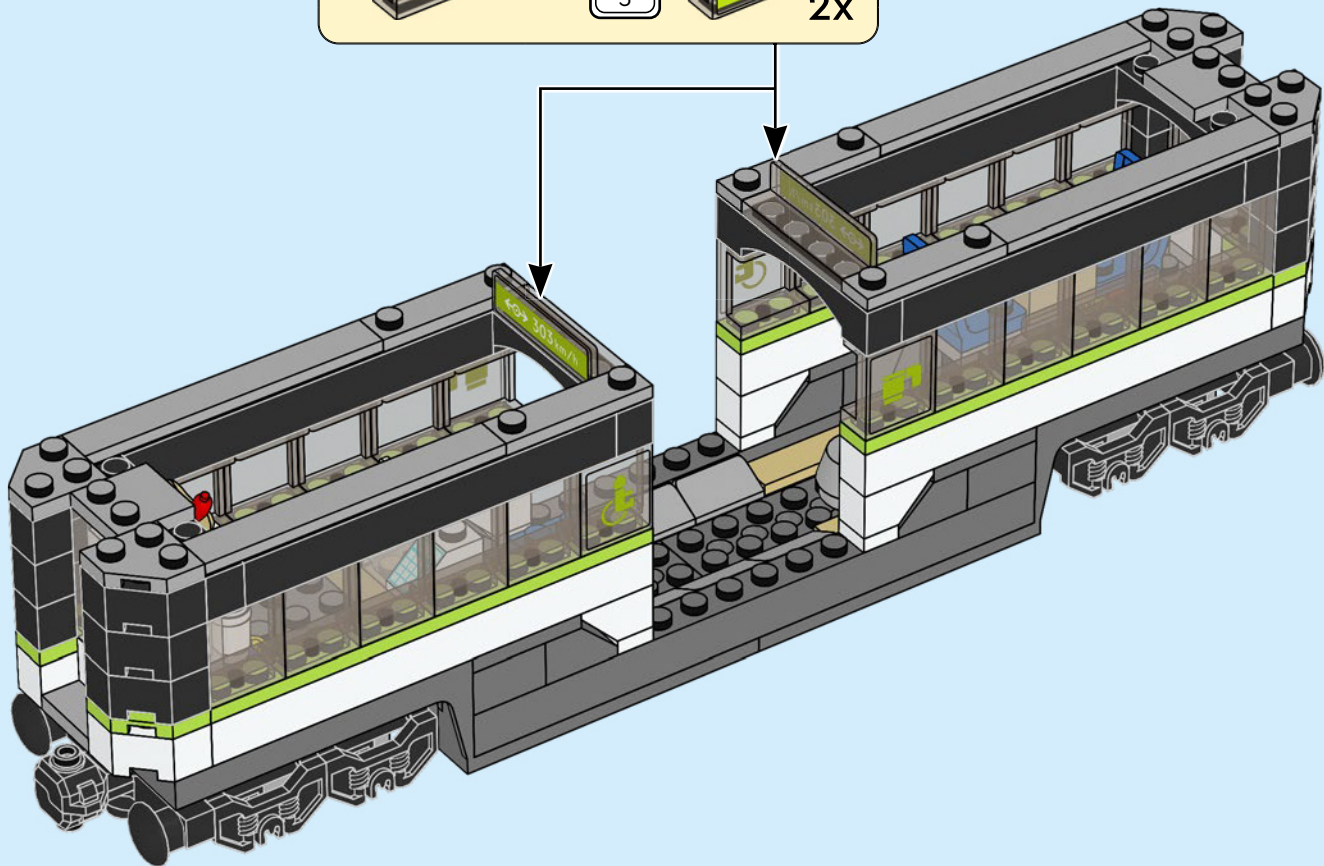
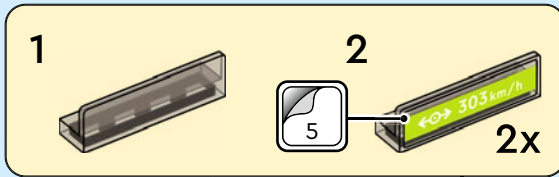

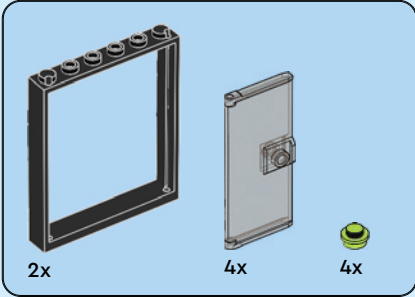
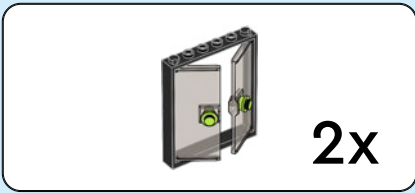

39

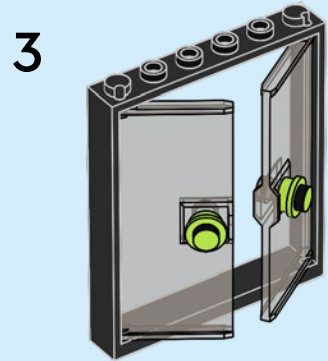
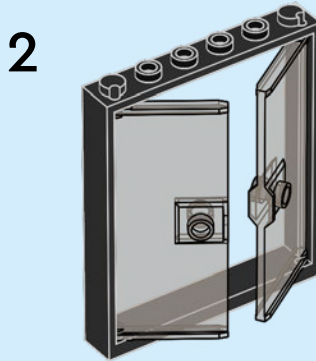
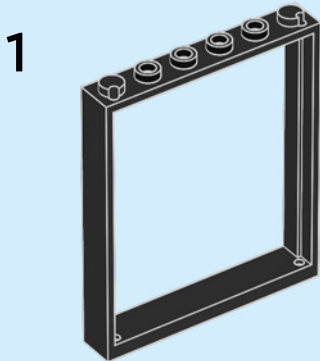

2x



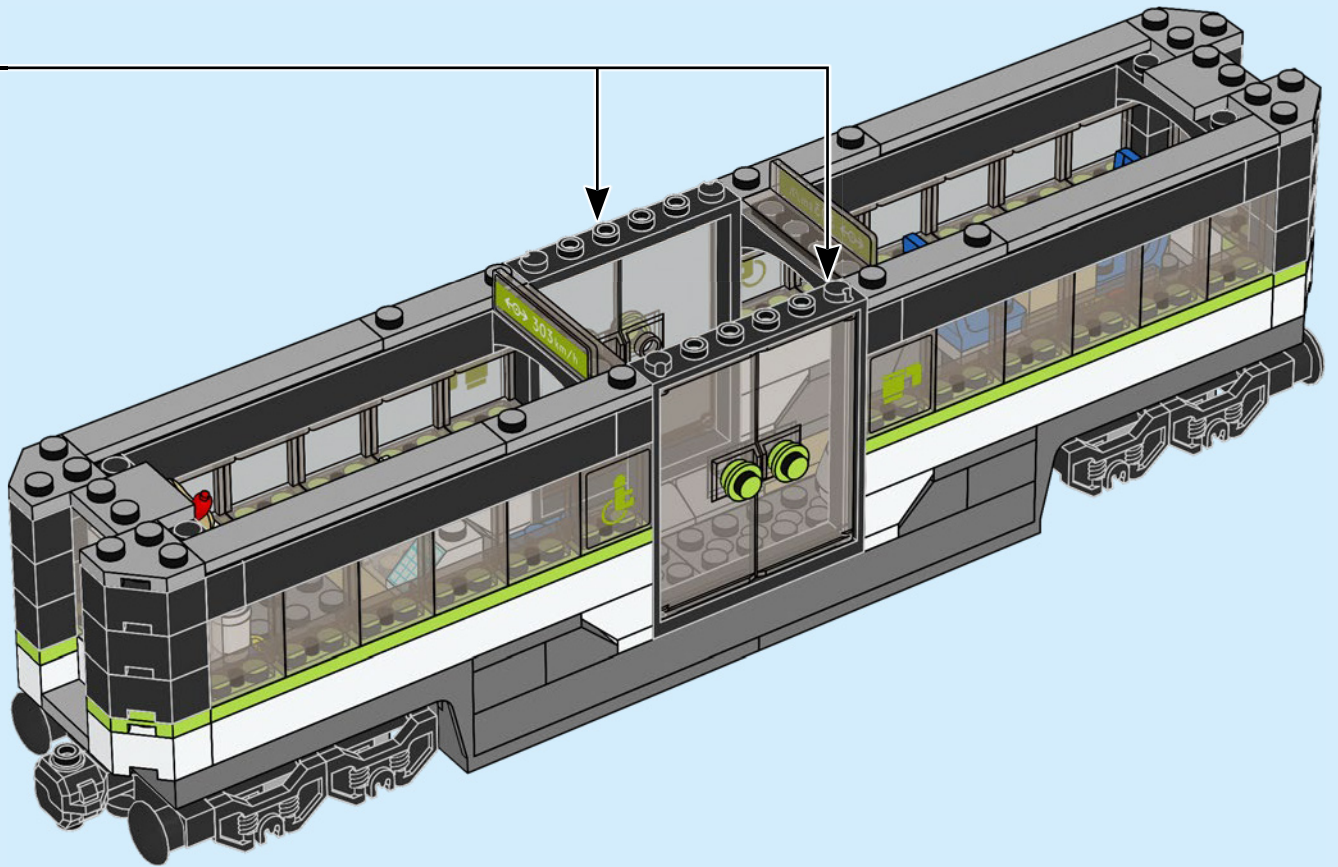

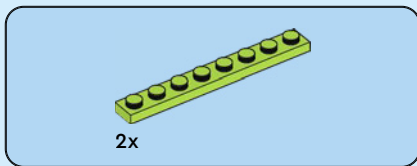

40

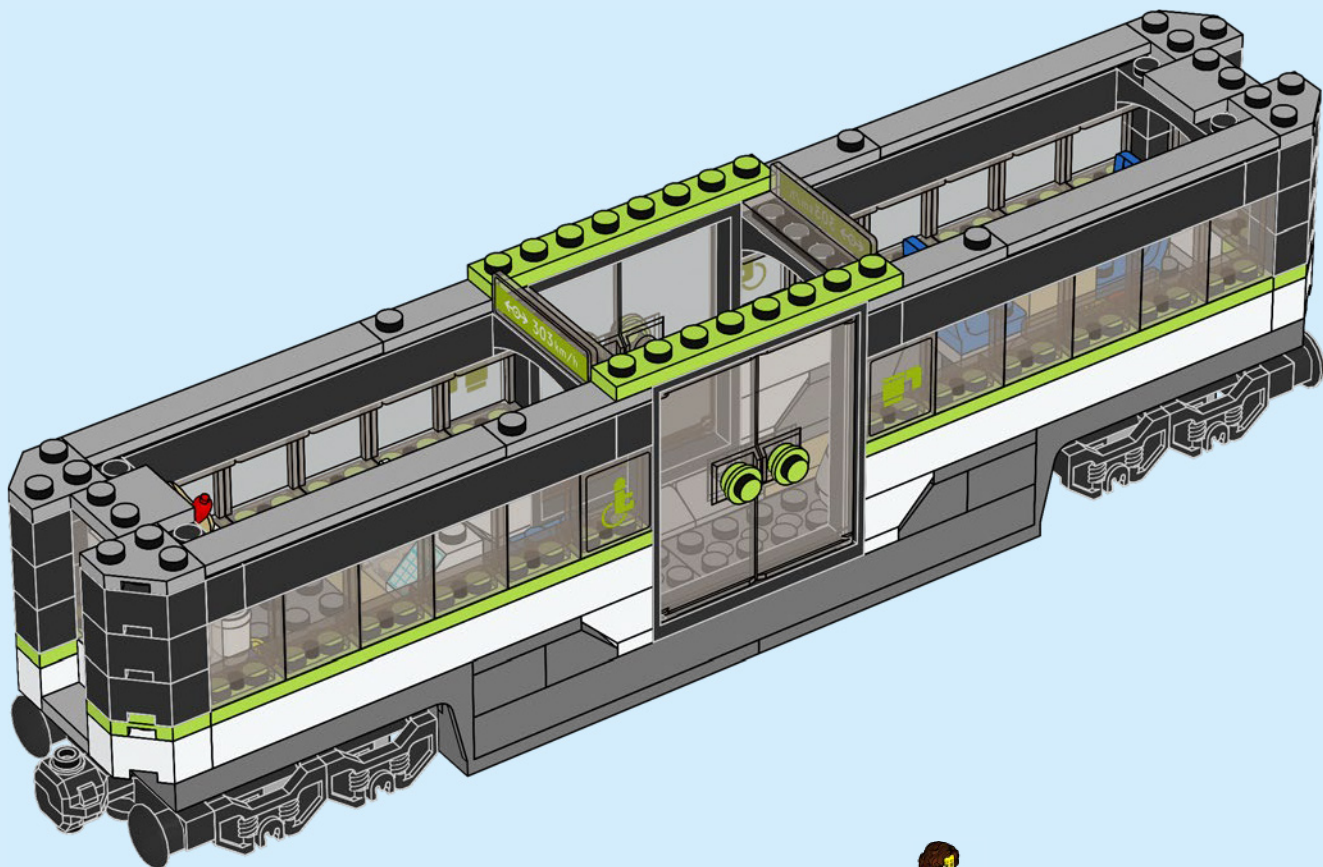

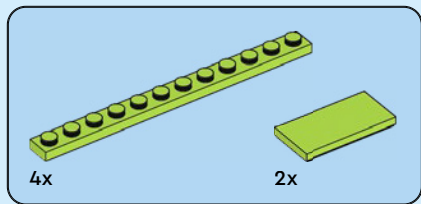

41

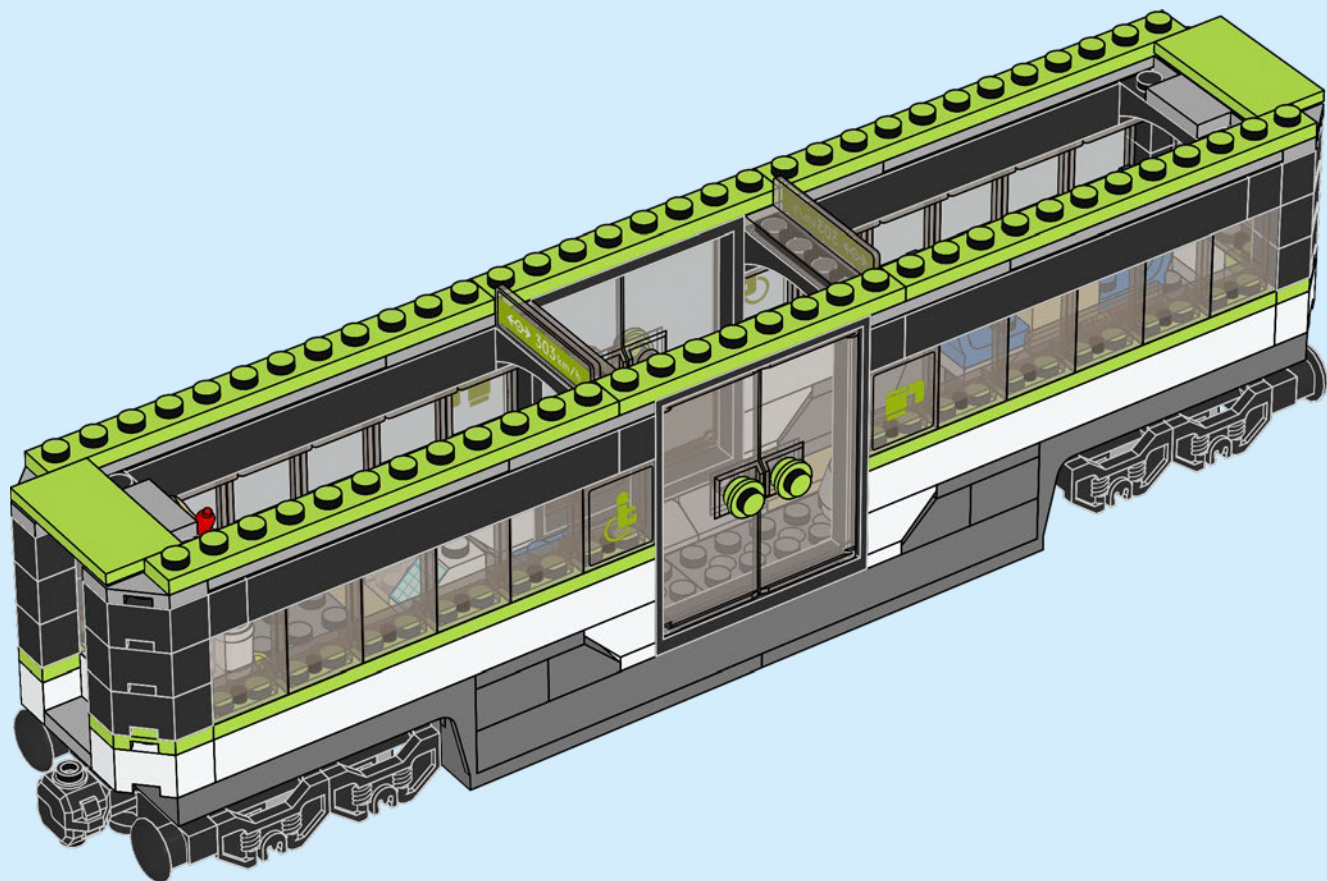

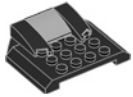

2x



2x



2x



2x



2x



2x

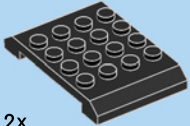

2x



2x

42

1

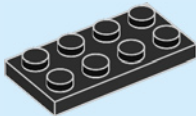

2

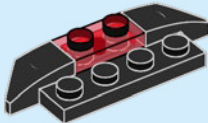

3

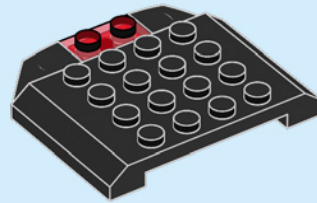

4

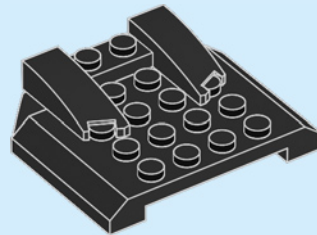

5

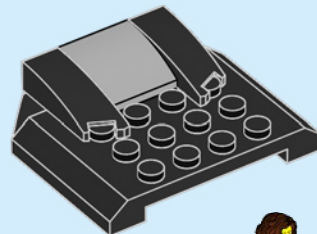

2x



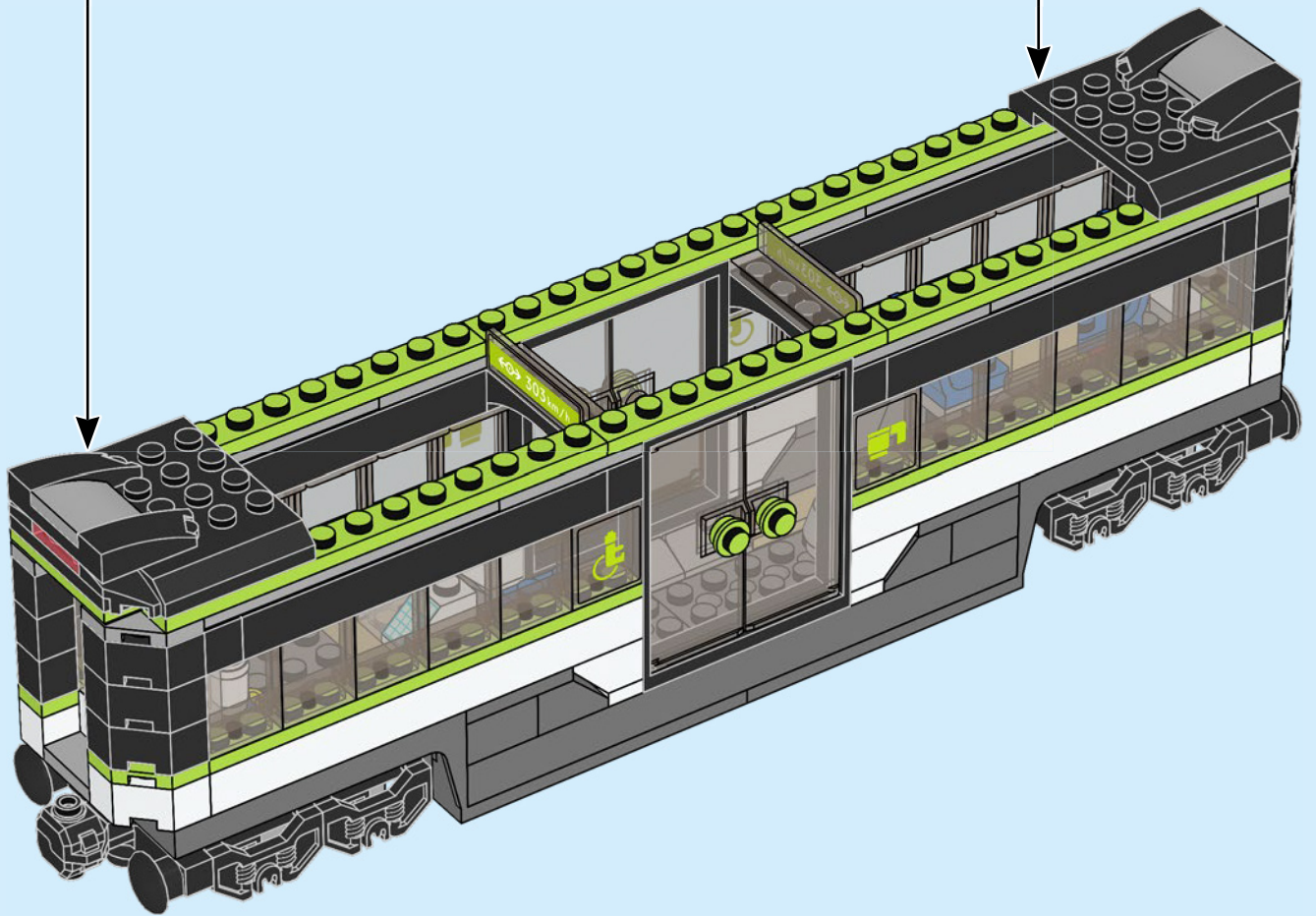

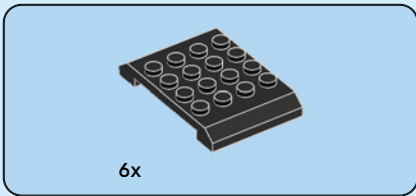

43

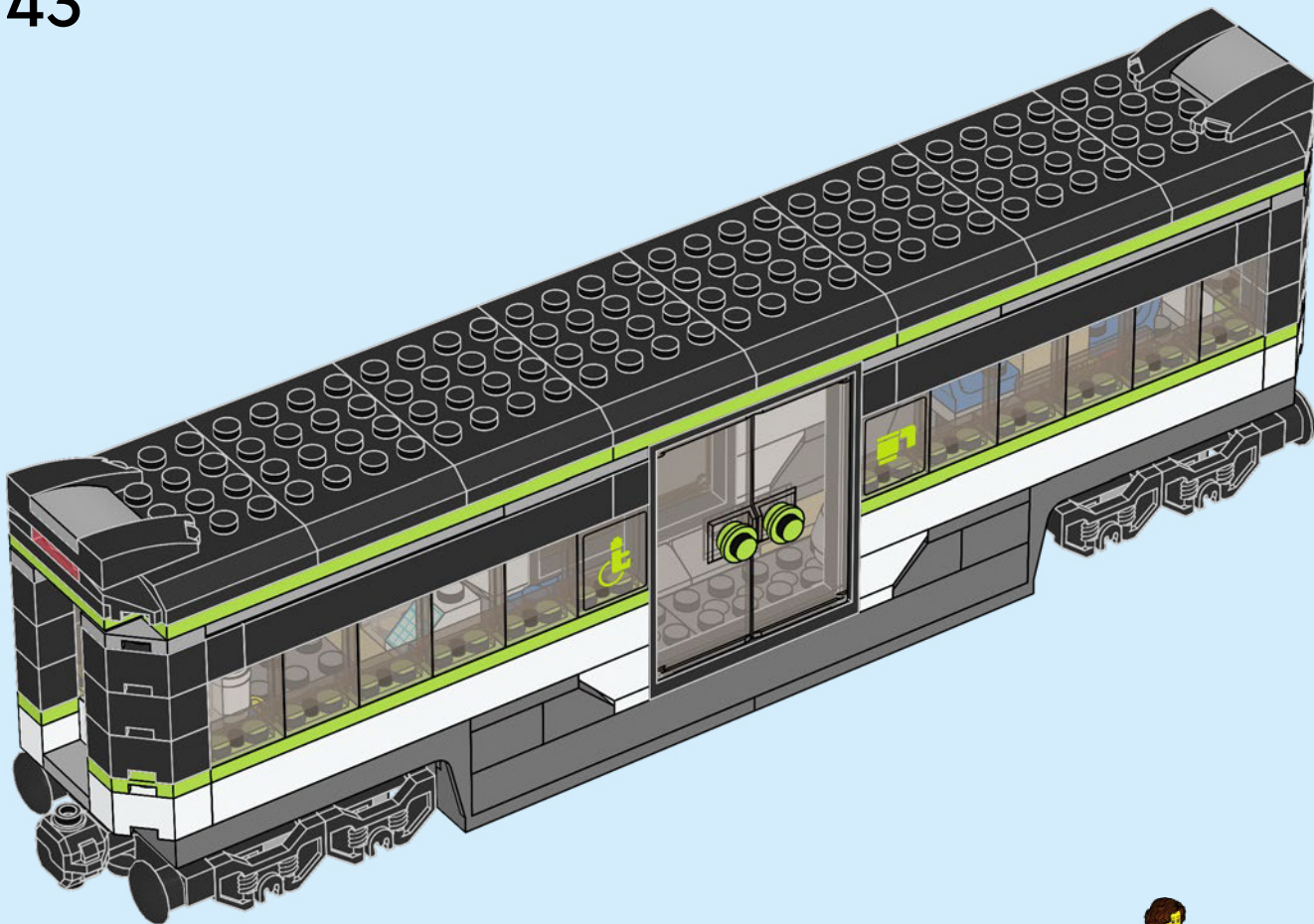



8x

44

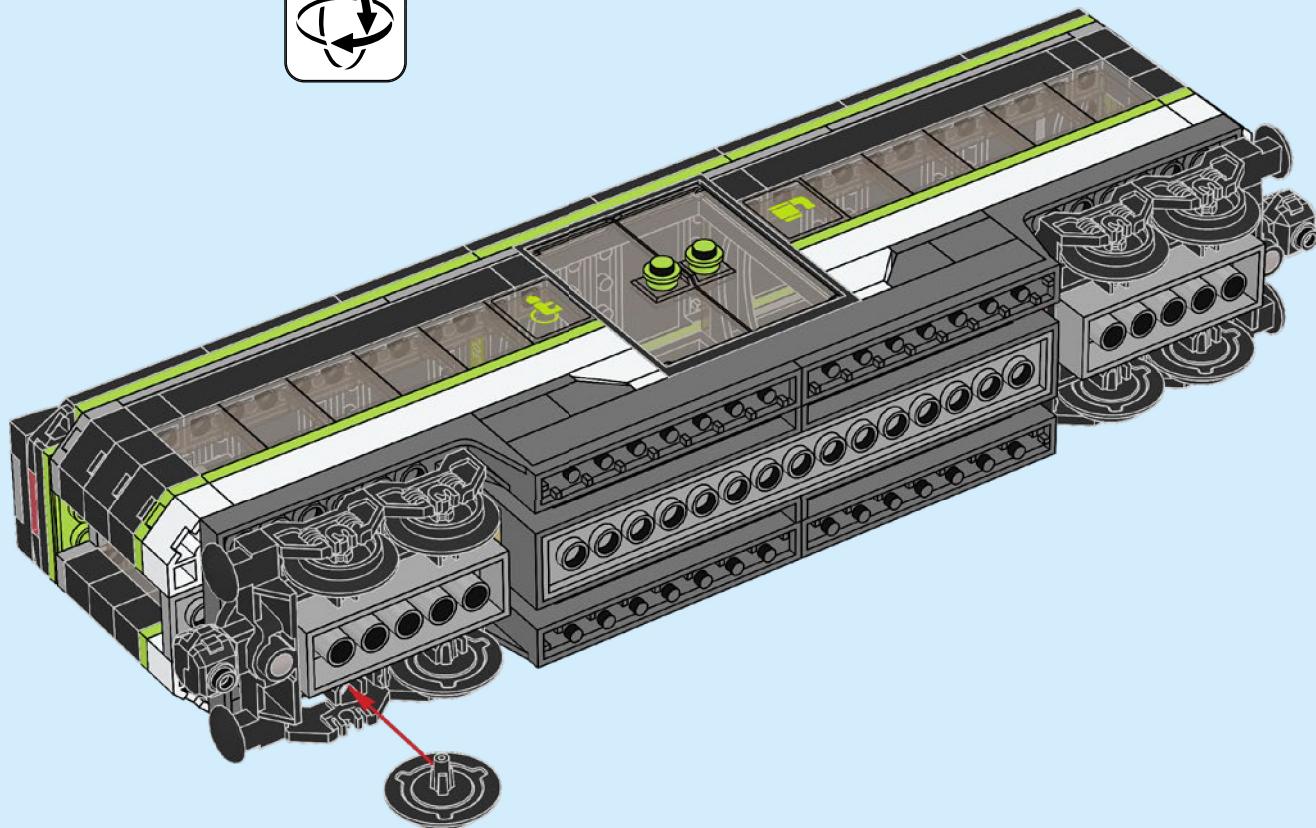

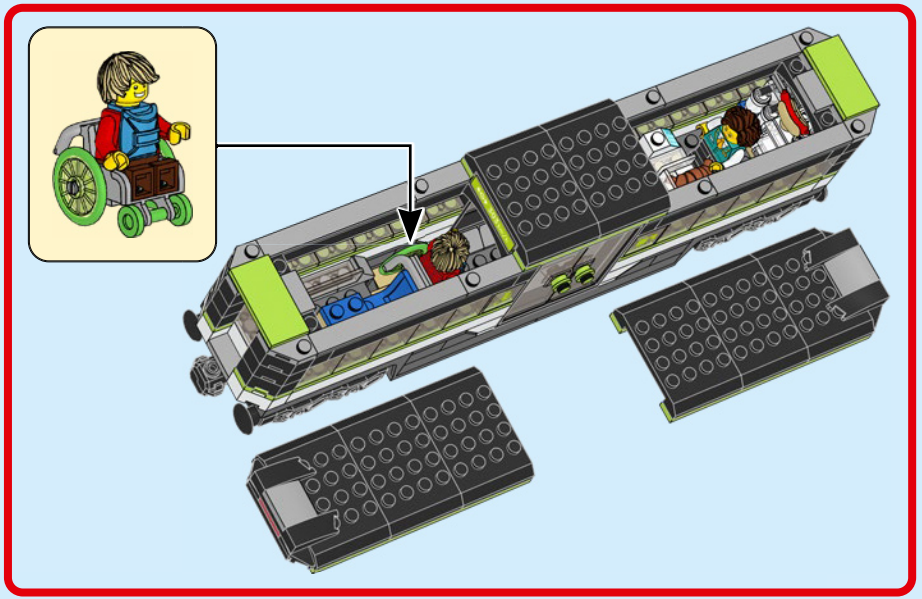



Rebuild
the
world™



LEGO and the LEGO logo are trademarks of the LEGO Group. ©2022 The LEGO Group. 6424311
The Bluetooth® word mark and logos are registered trademarks owned by Bluetooth SIG, Inc.
and any use of such marks by the LEGO Group is under license. Other trademarks and trade
names are those of their respective owners.



CITY

60337



6

7

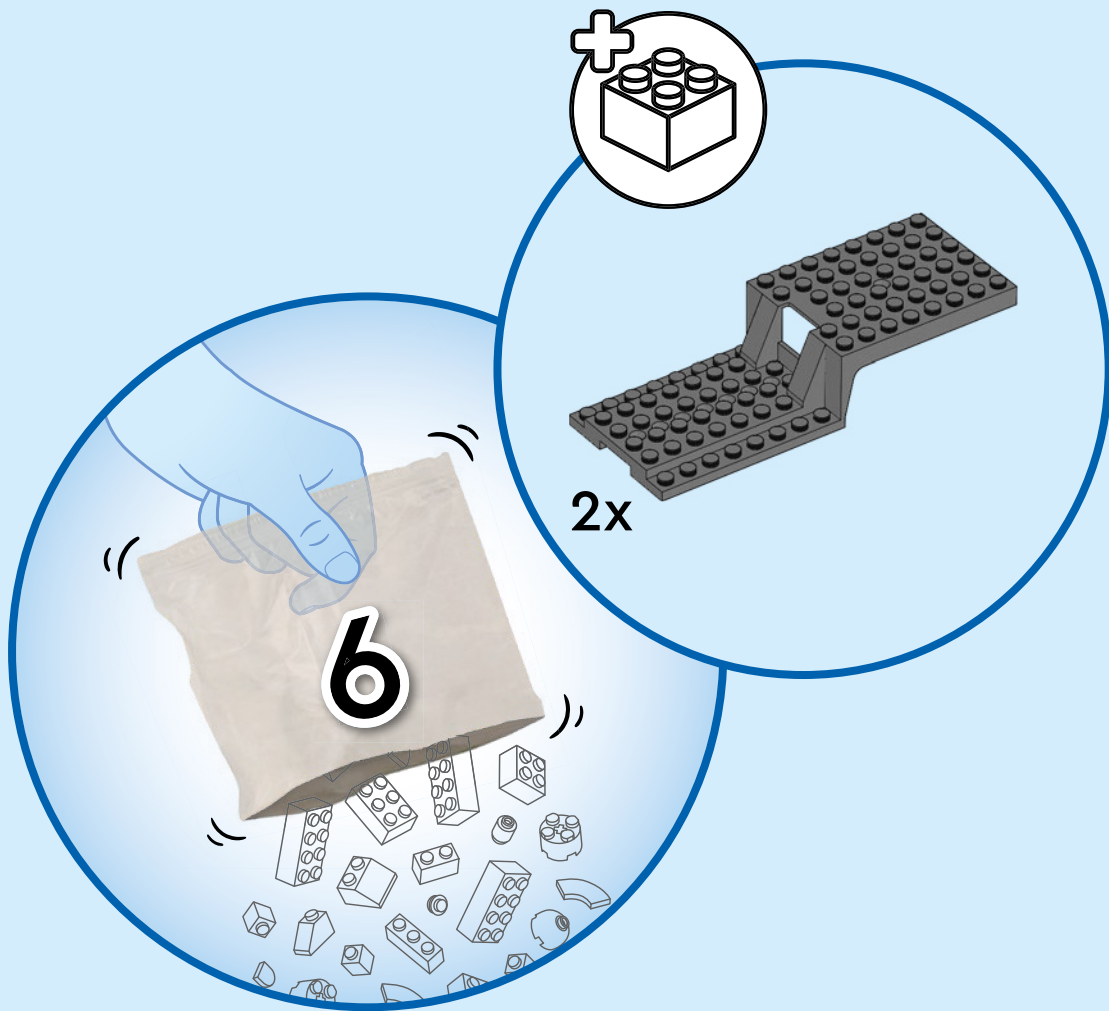

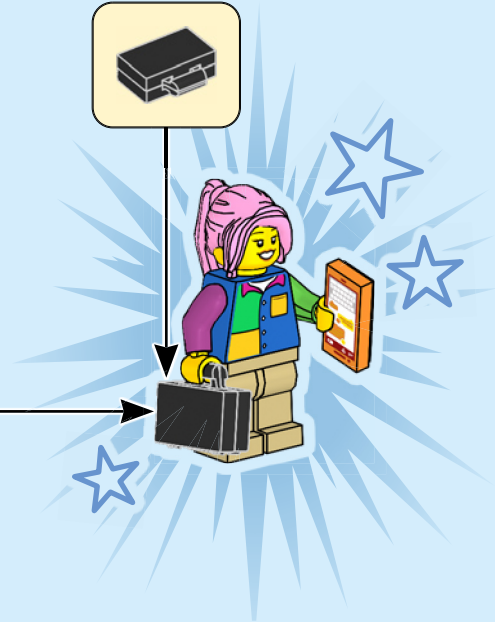
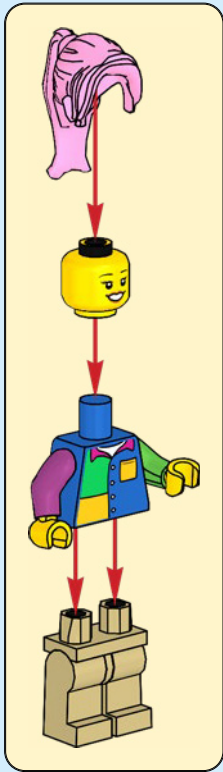

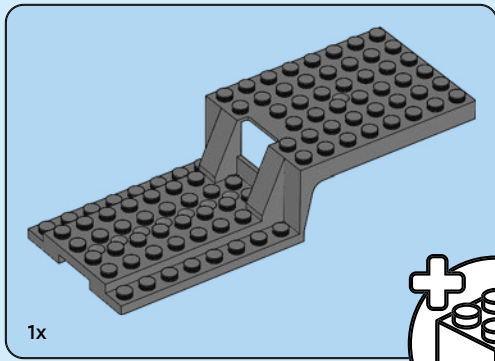

1x

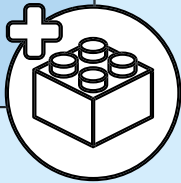

1

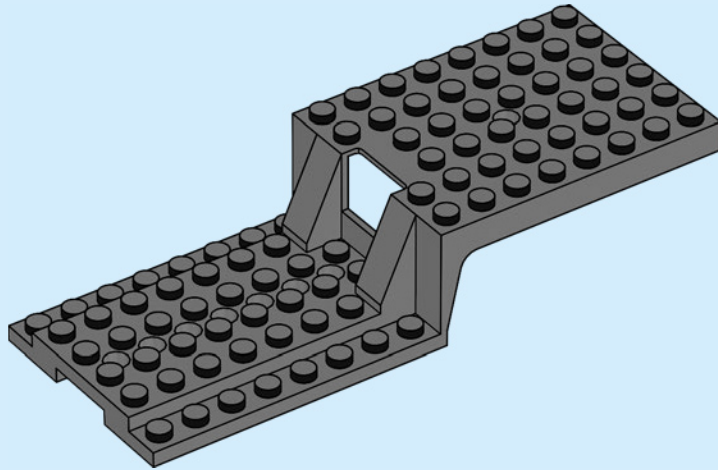

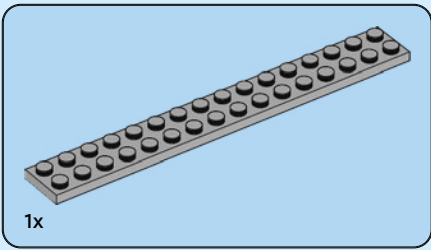

2

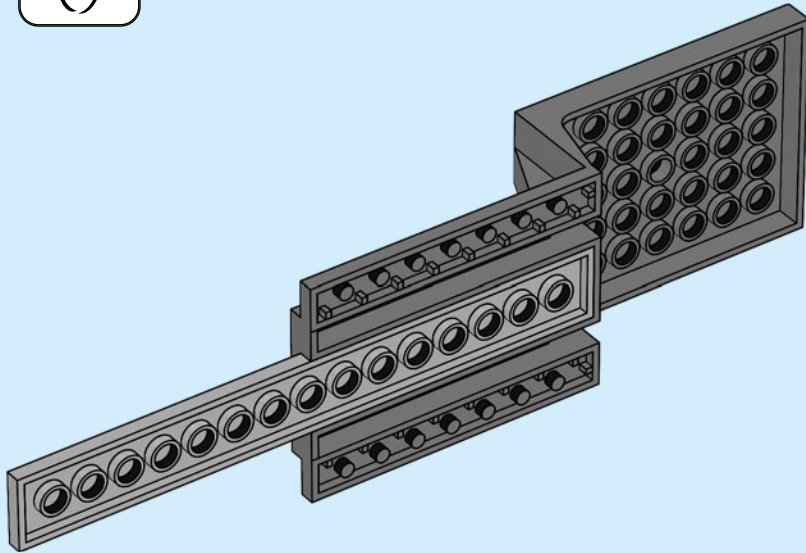

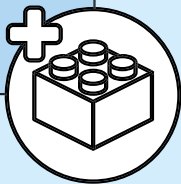
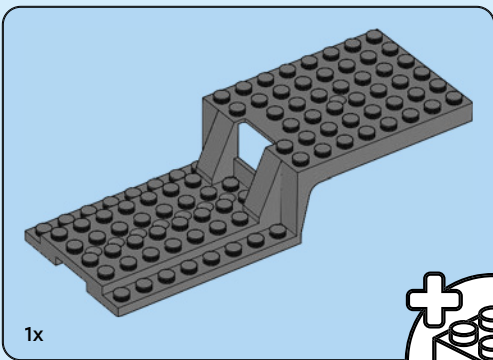

3

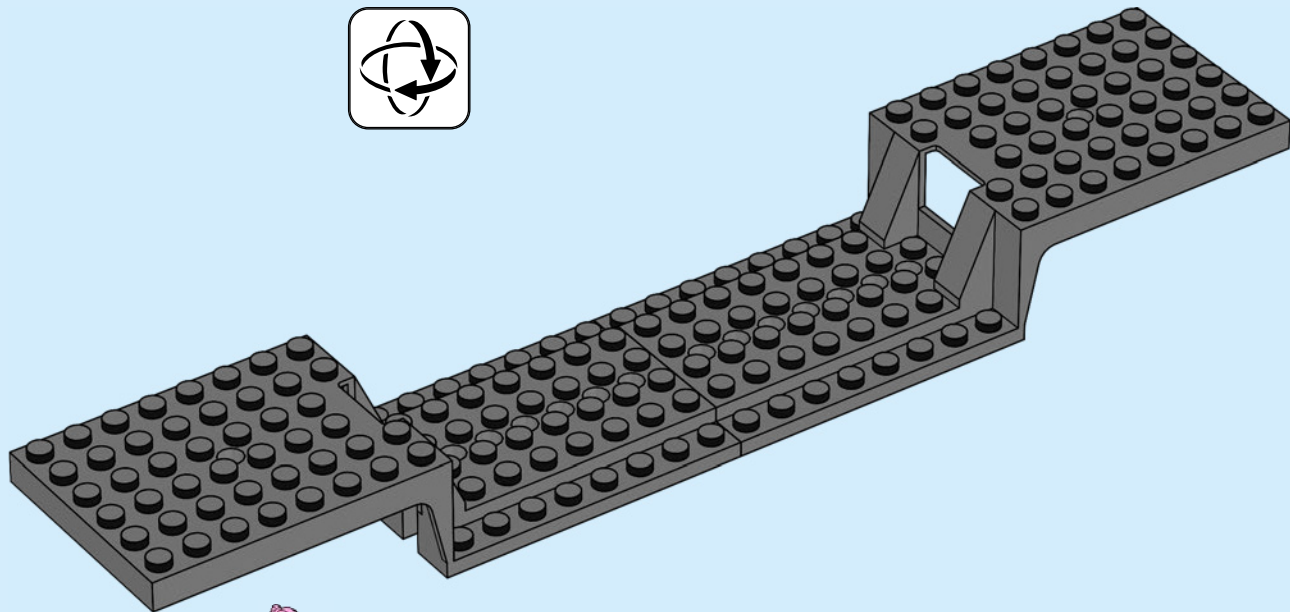

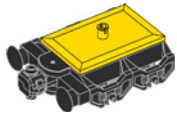

2x

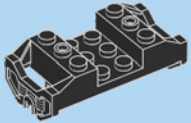

4x



2x

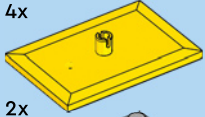

2x

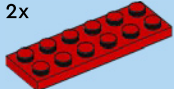

2x



2x

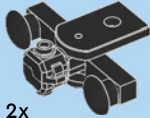

2x

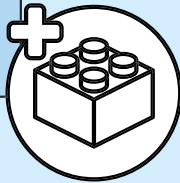

4

1

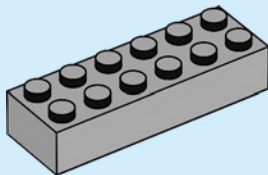

2

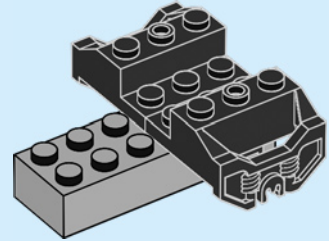

3

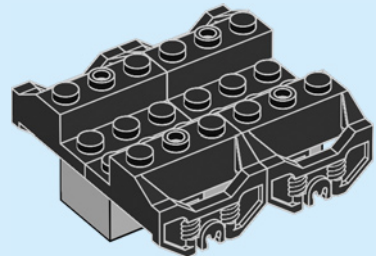

4

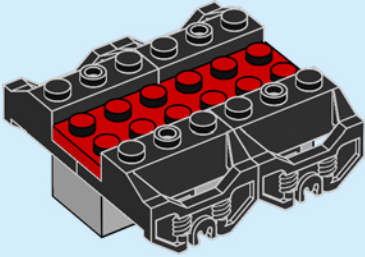

5

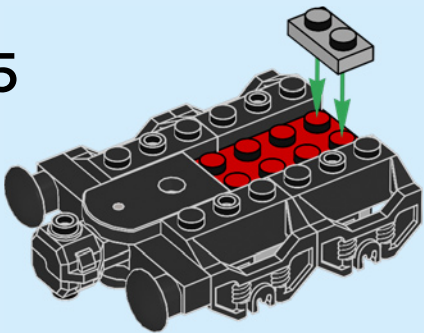

6

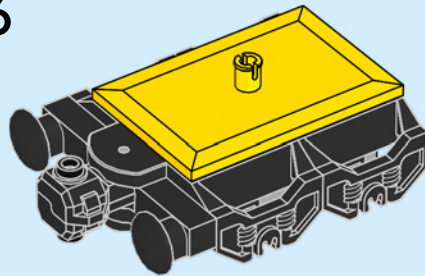

2x



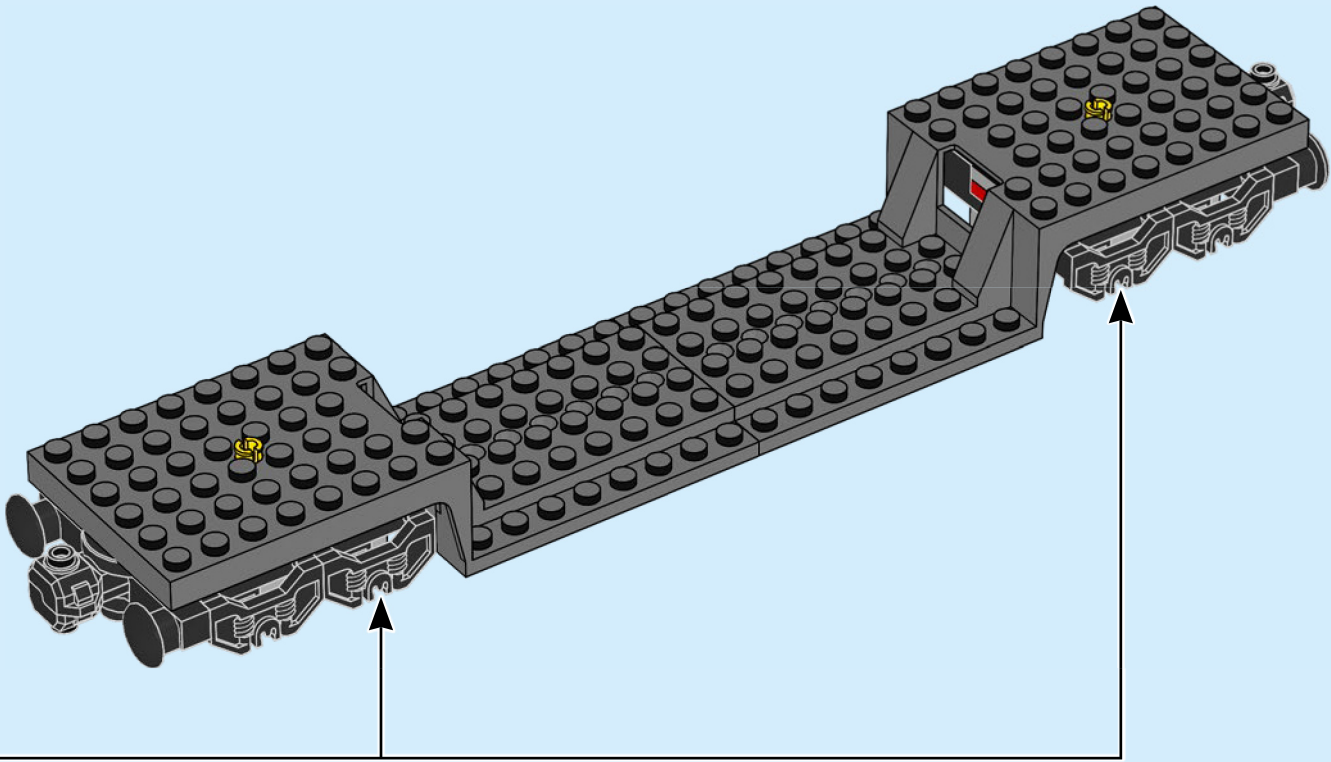



2x



4x

5

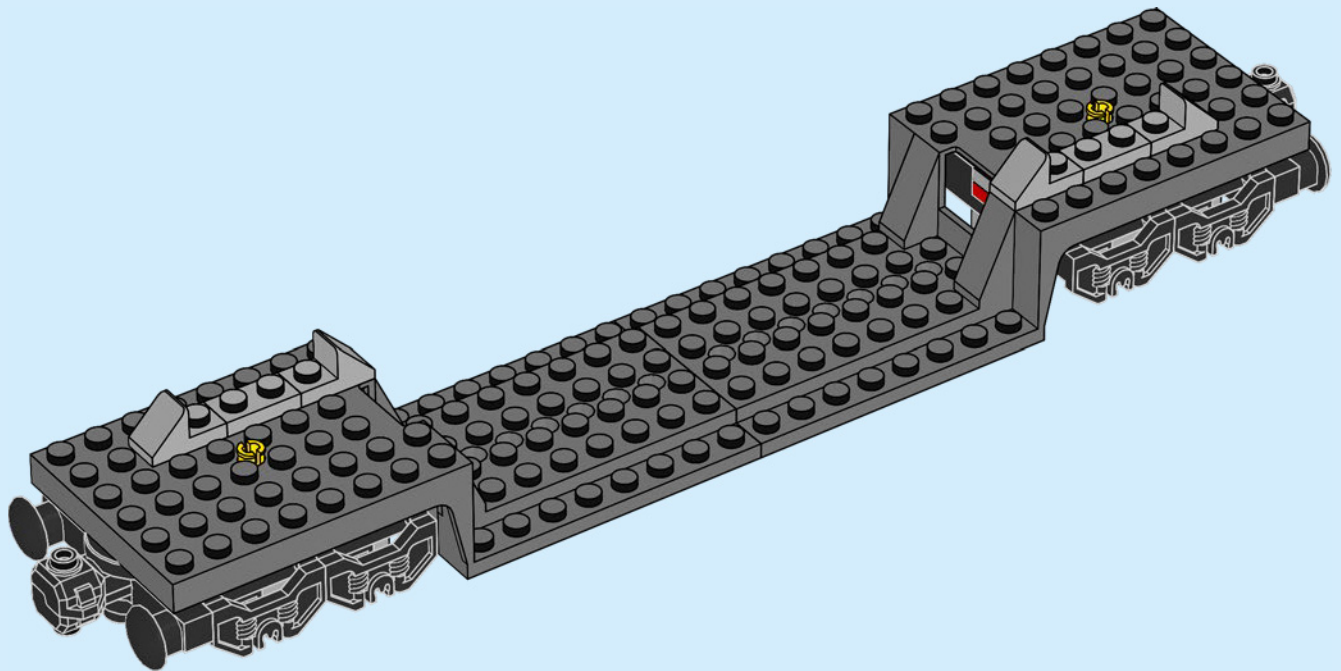



2x



4x

7

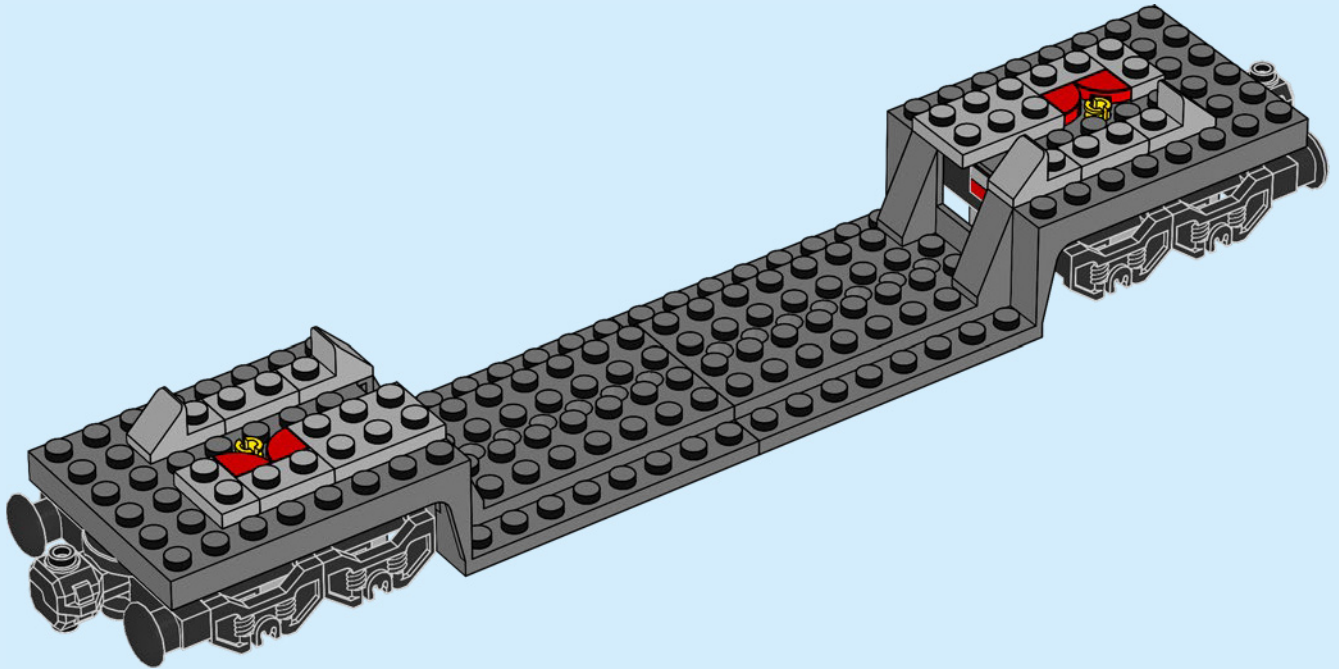

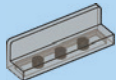

2x

8

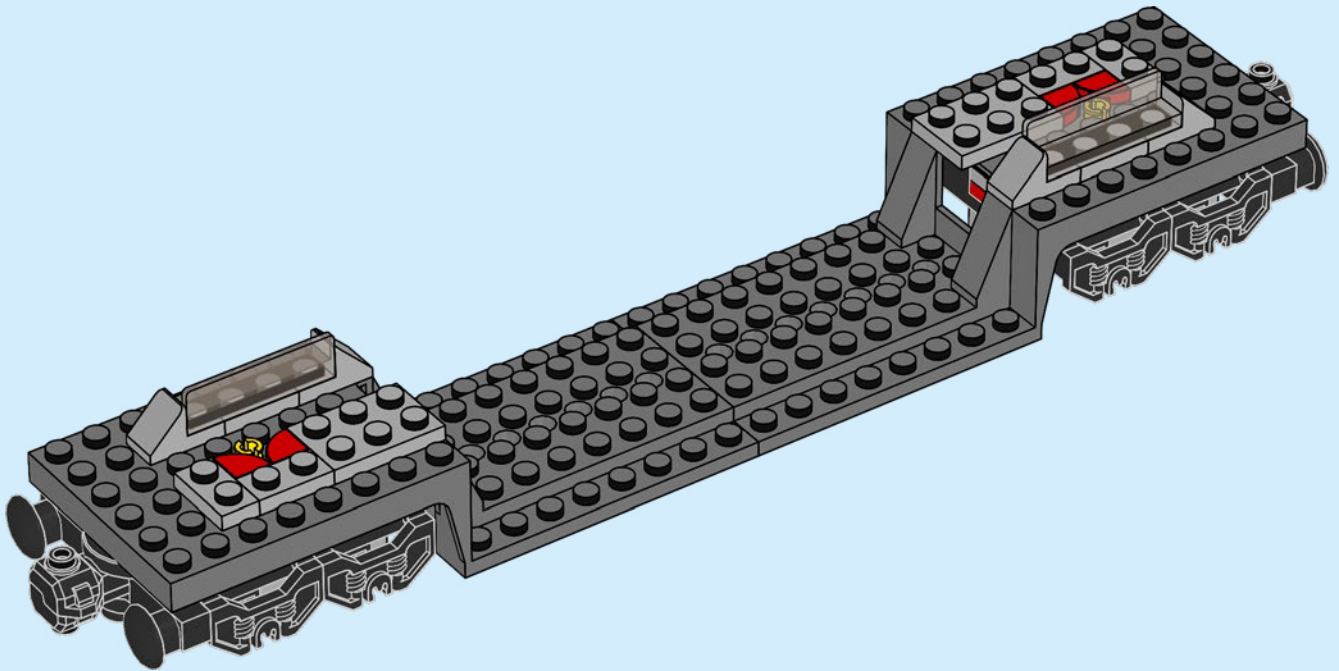



4x

9

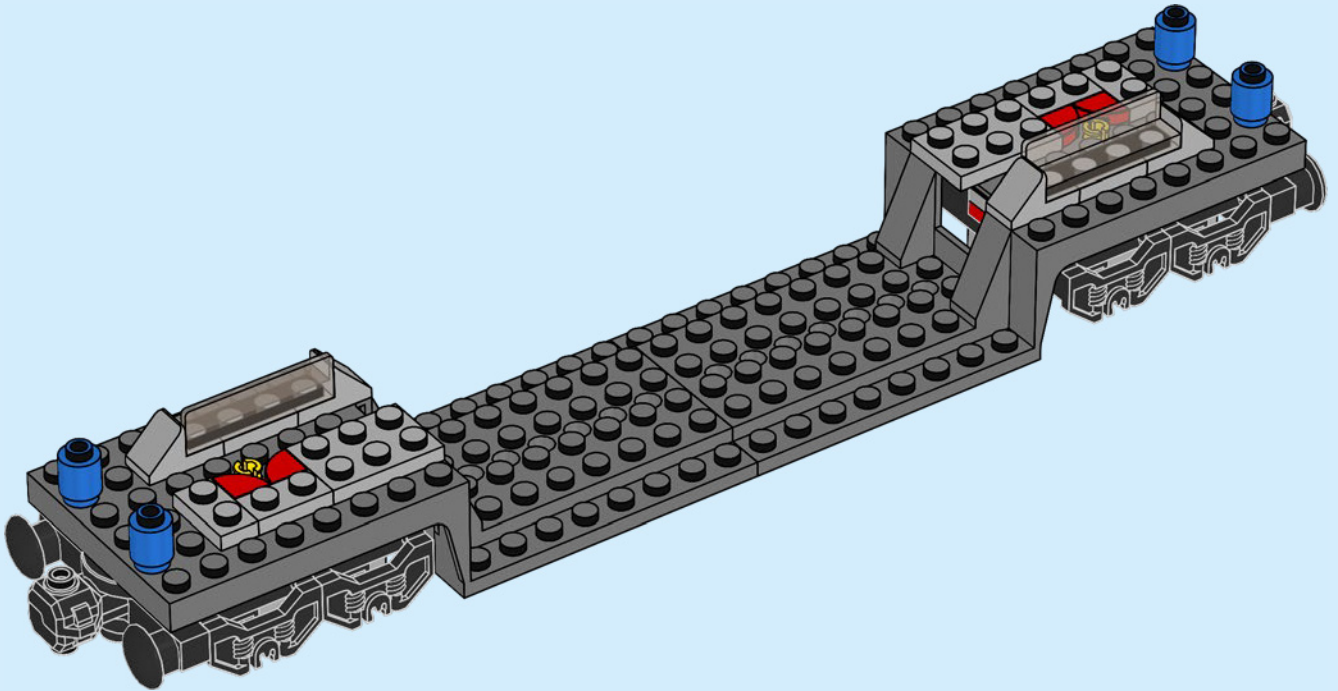

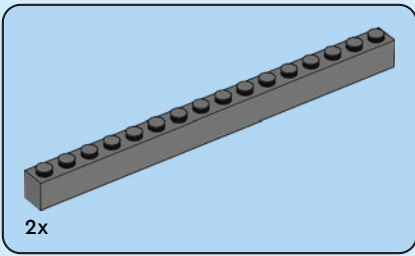

10

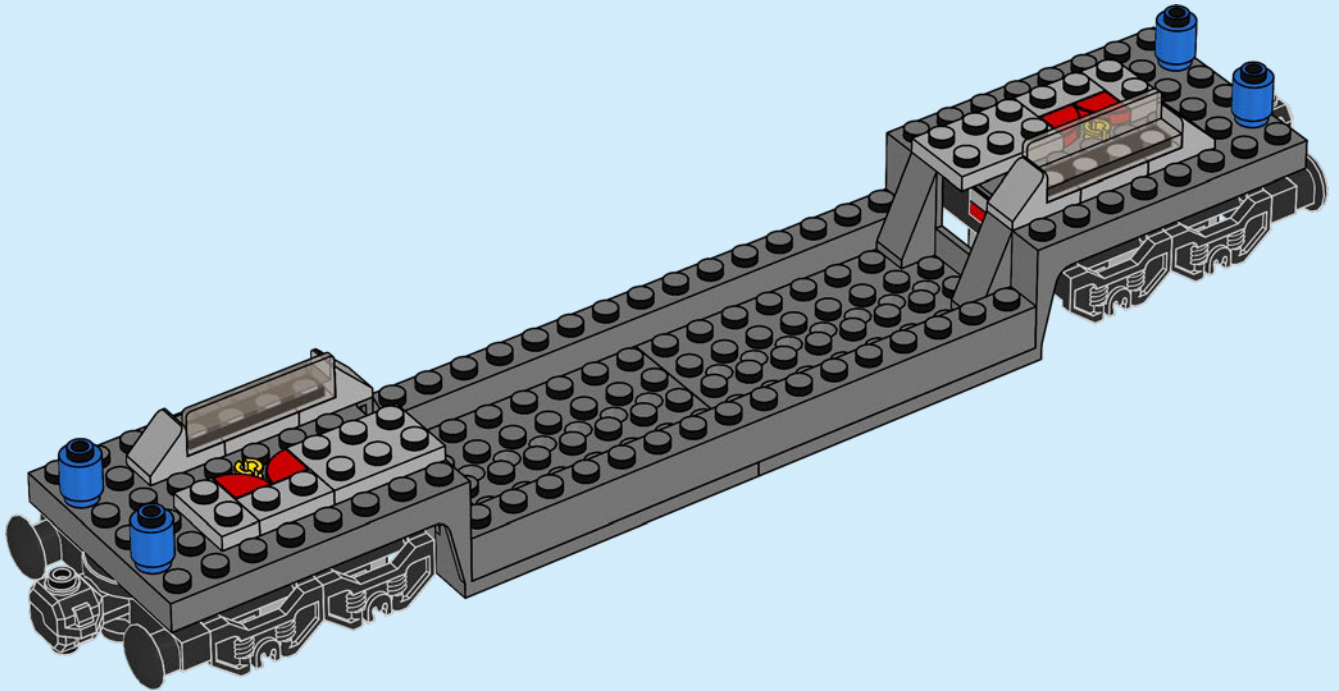



6x

11

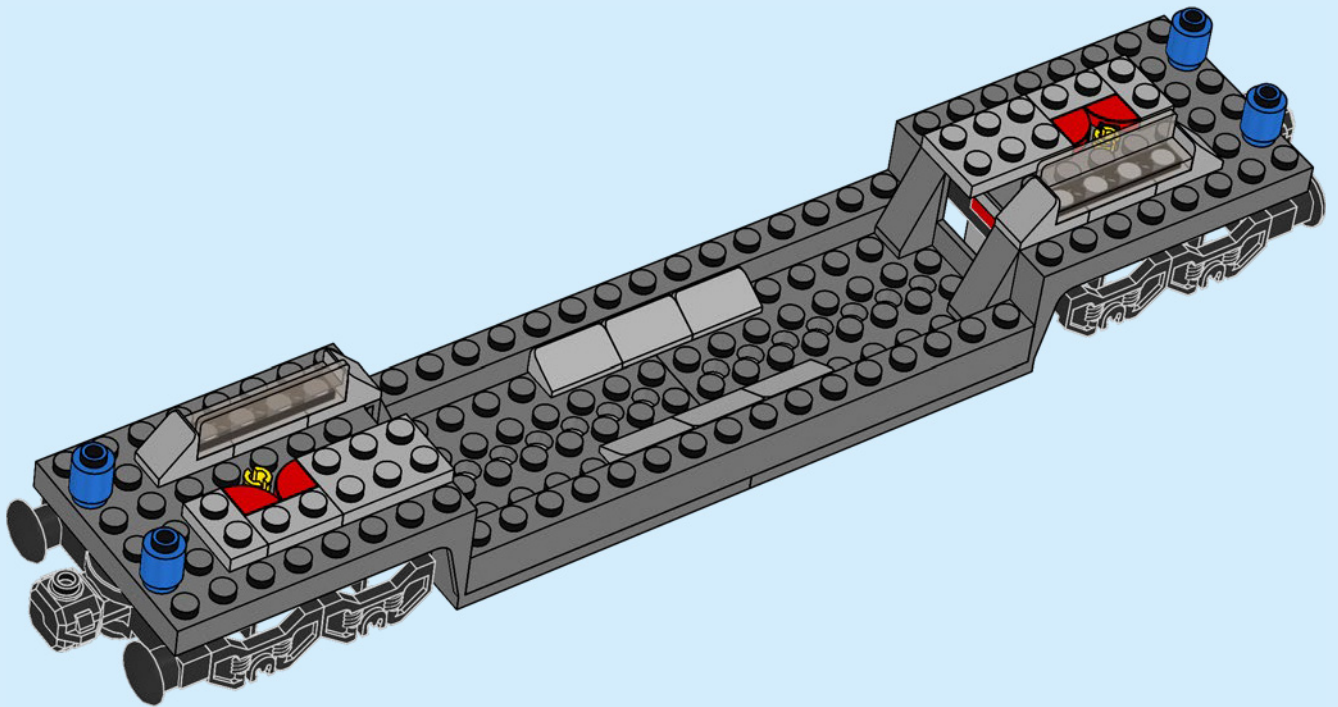

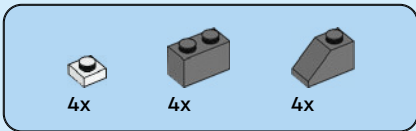

12

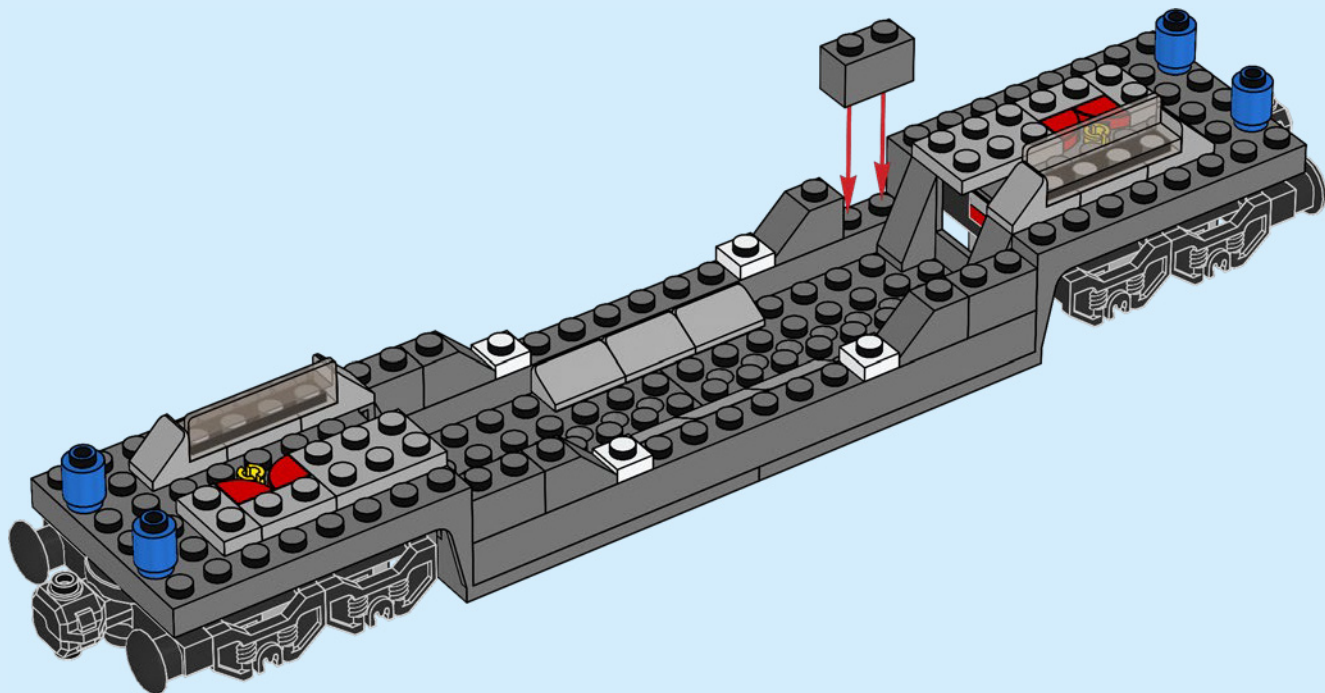

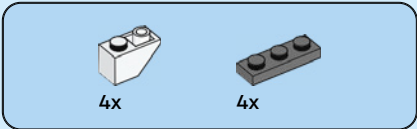

13

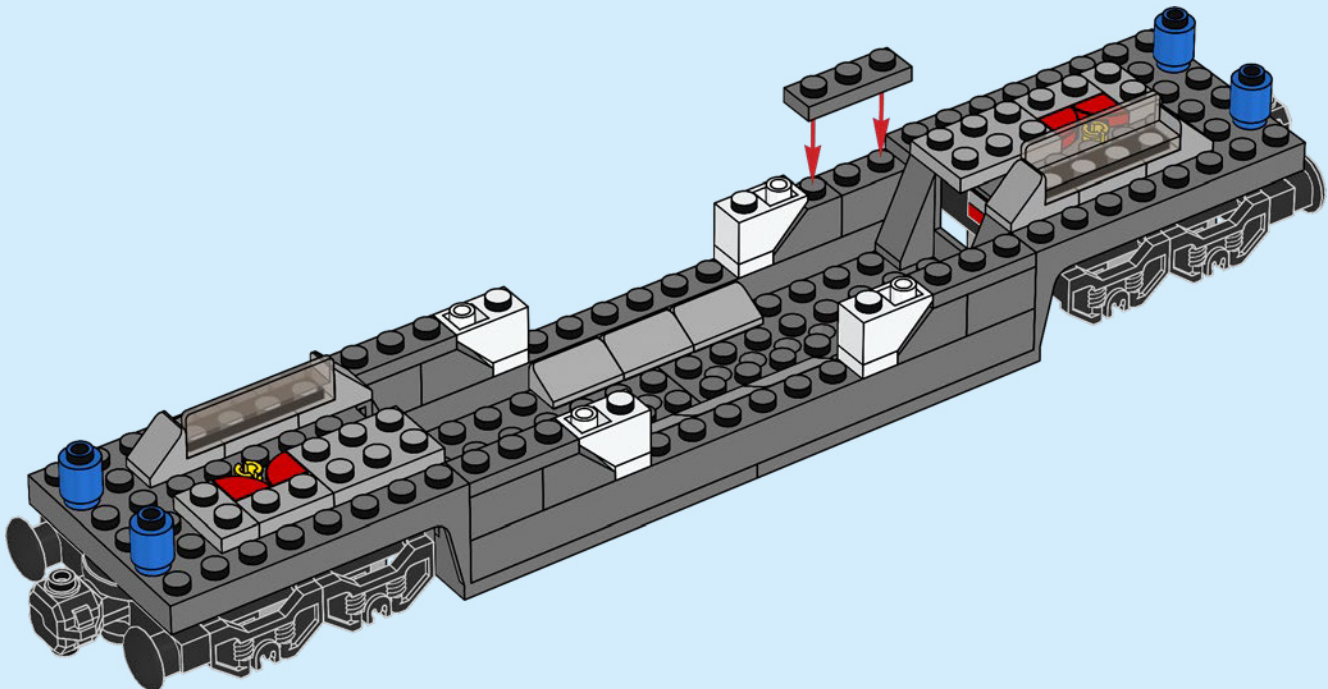



2x



4x

14

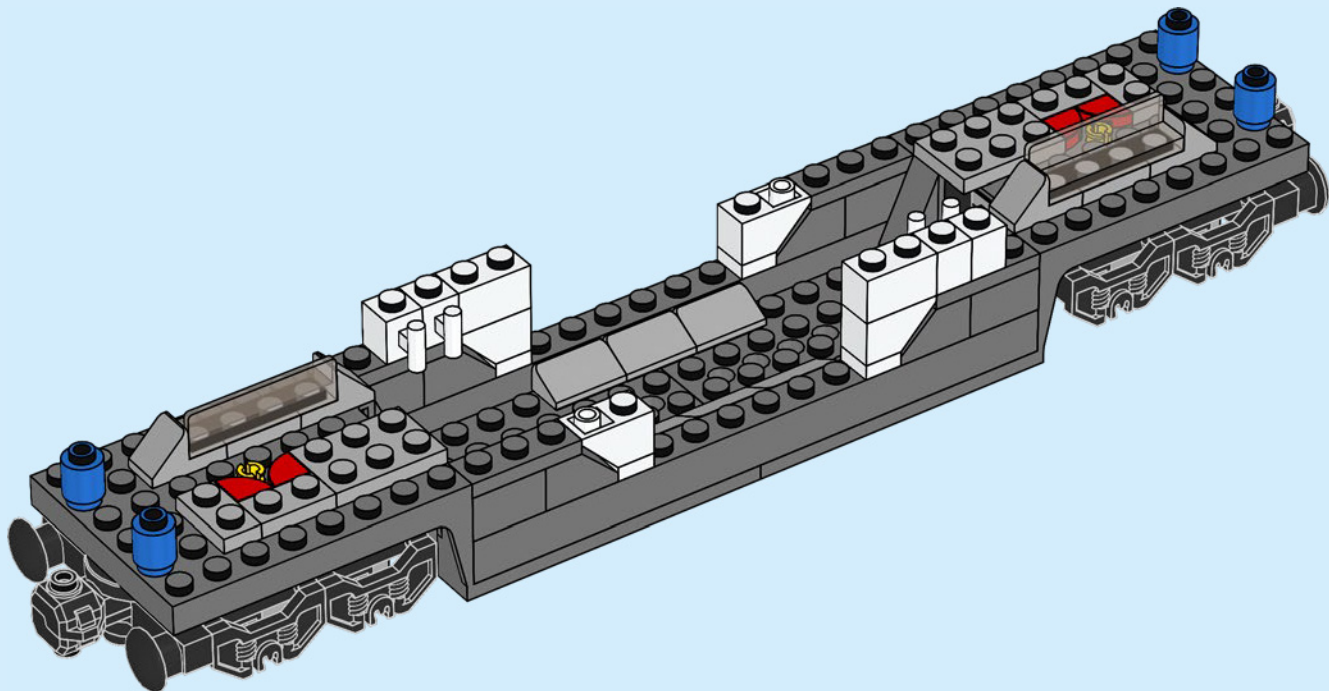

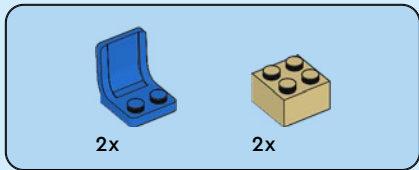

15

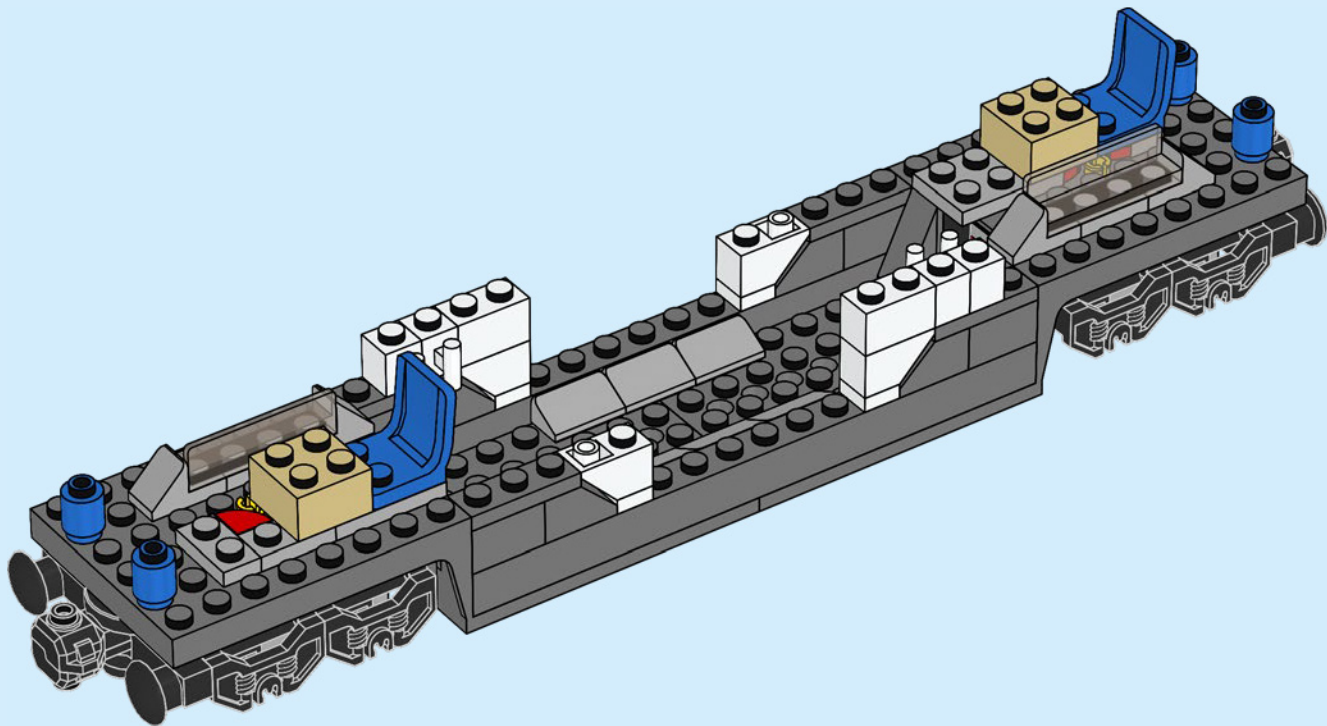

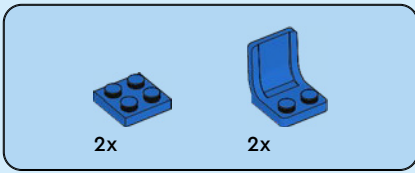

16

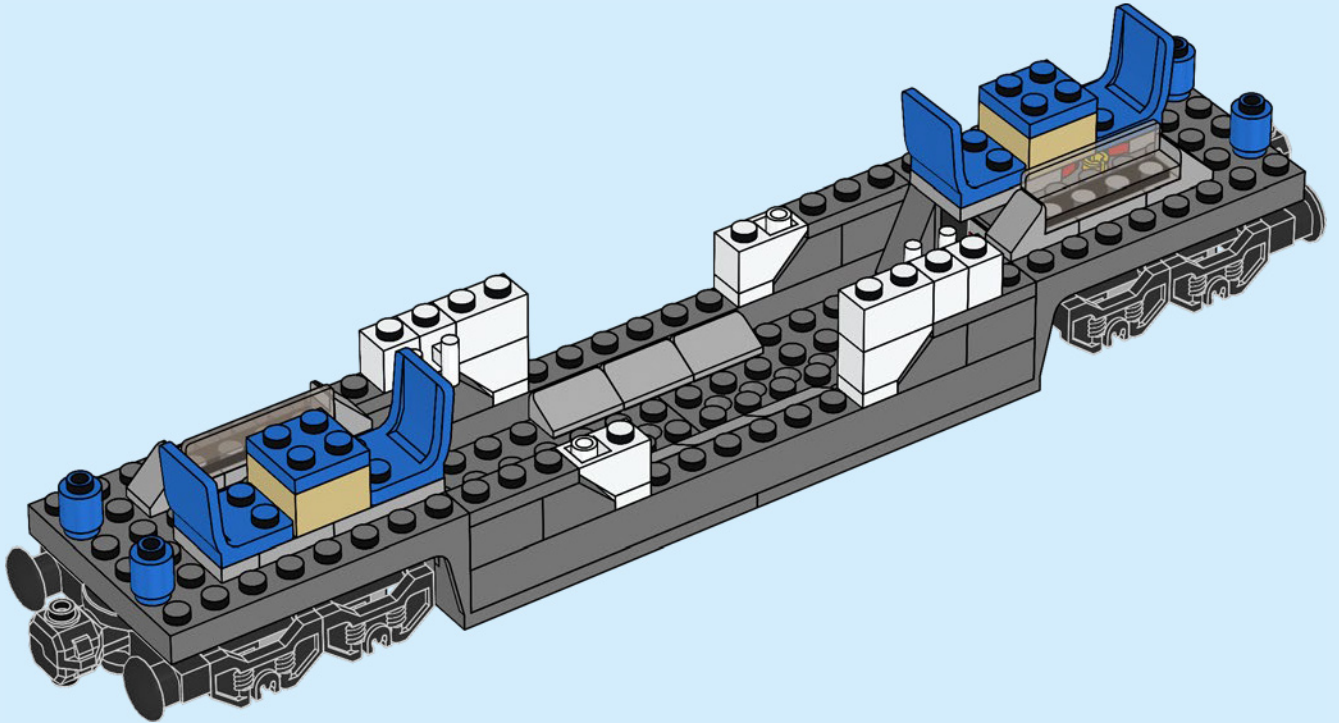

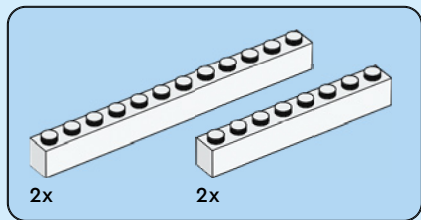

17

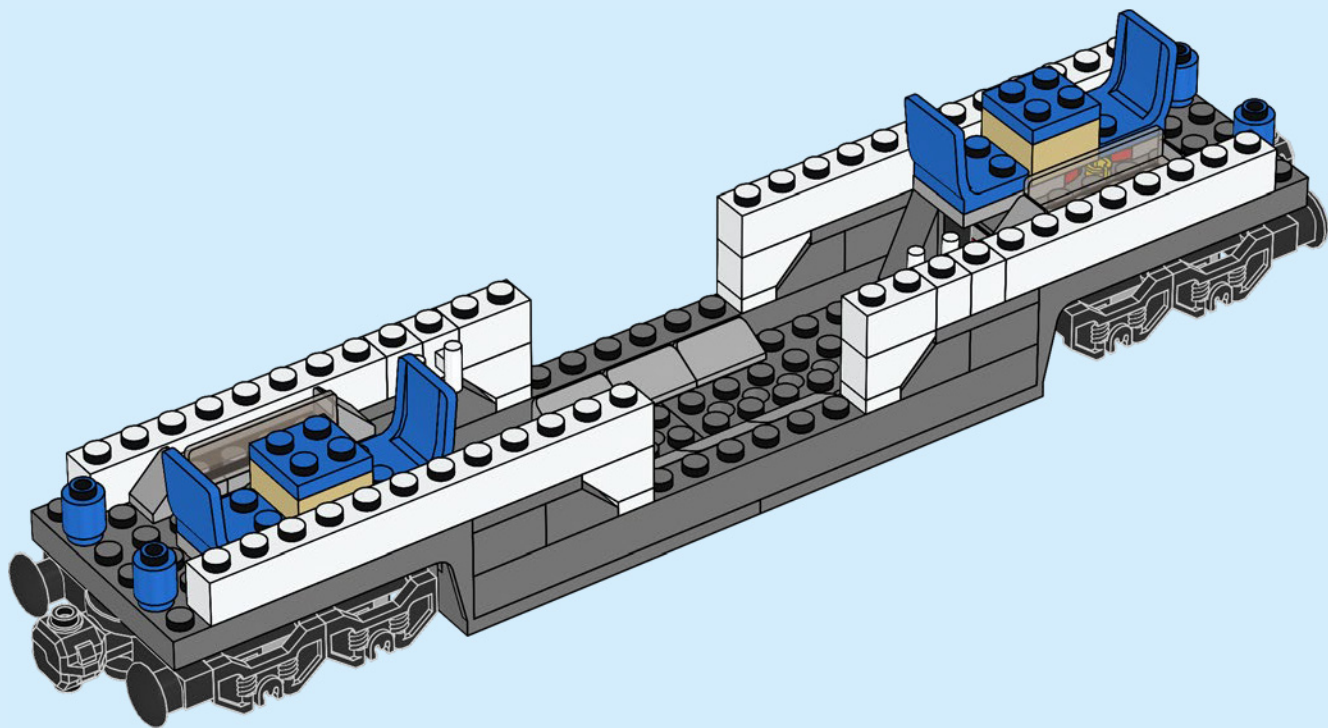

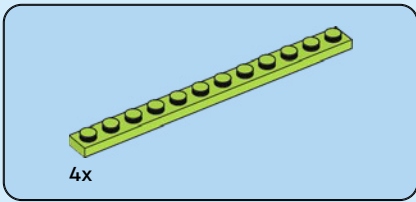

18

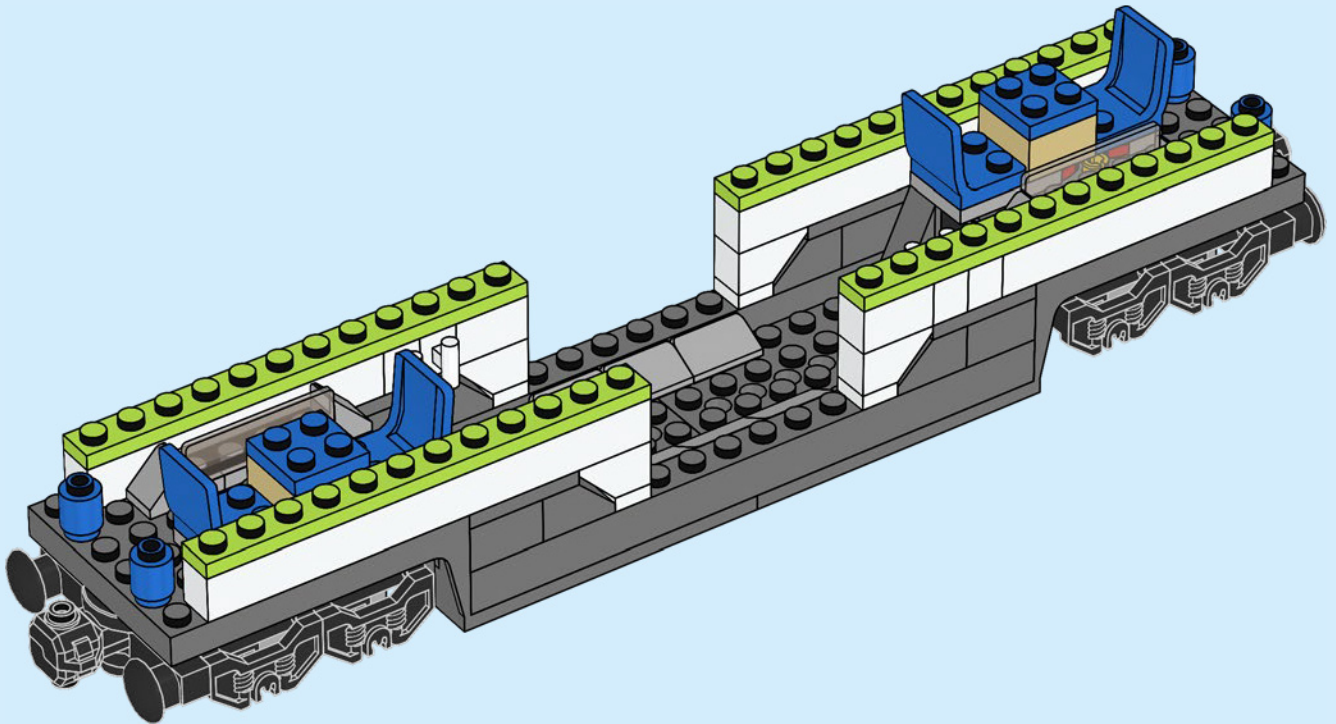

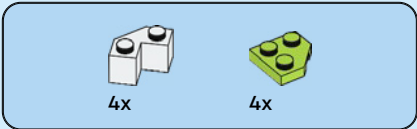

19

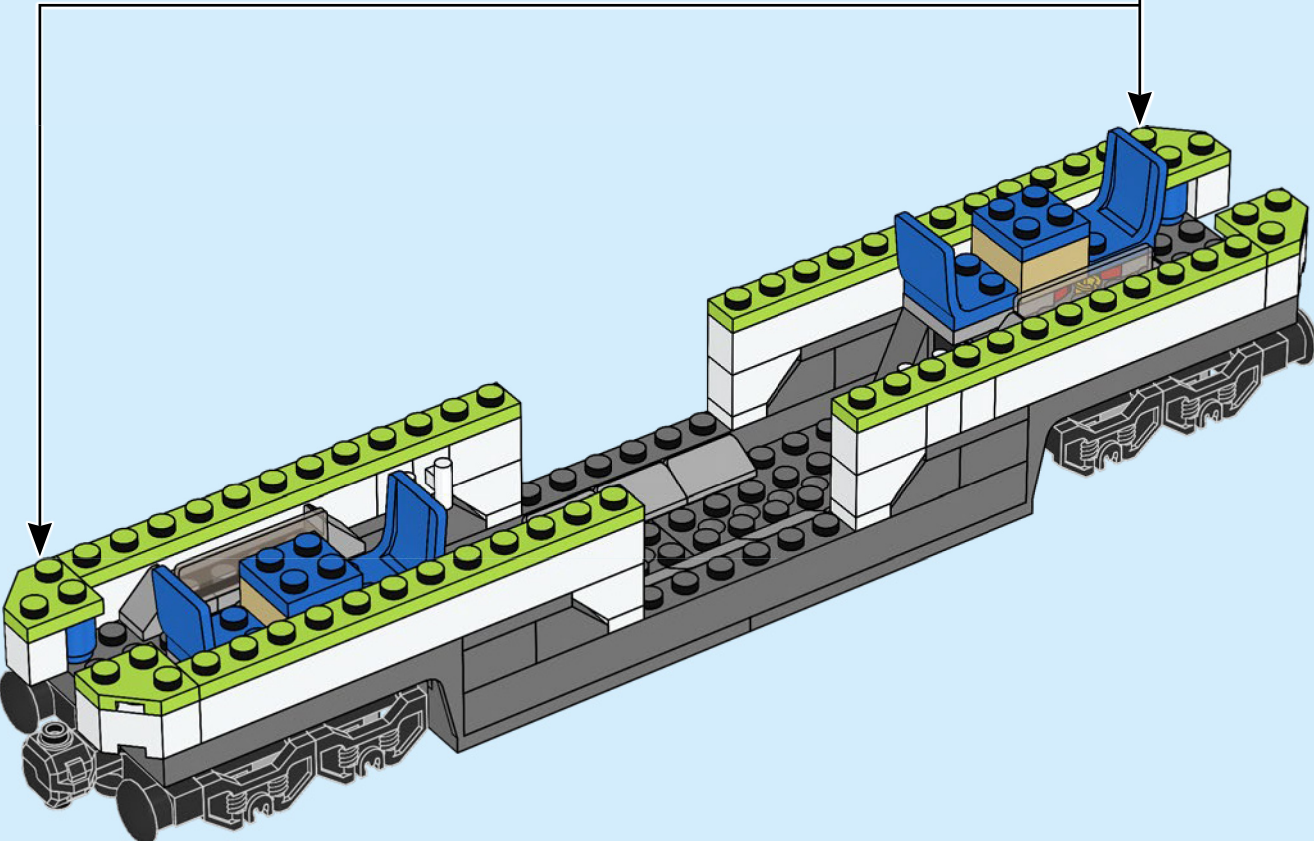
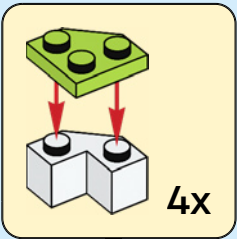



2x



2x

20

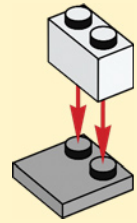

2x

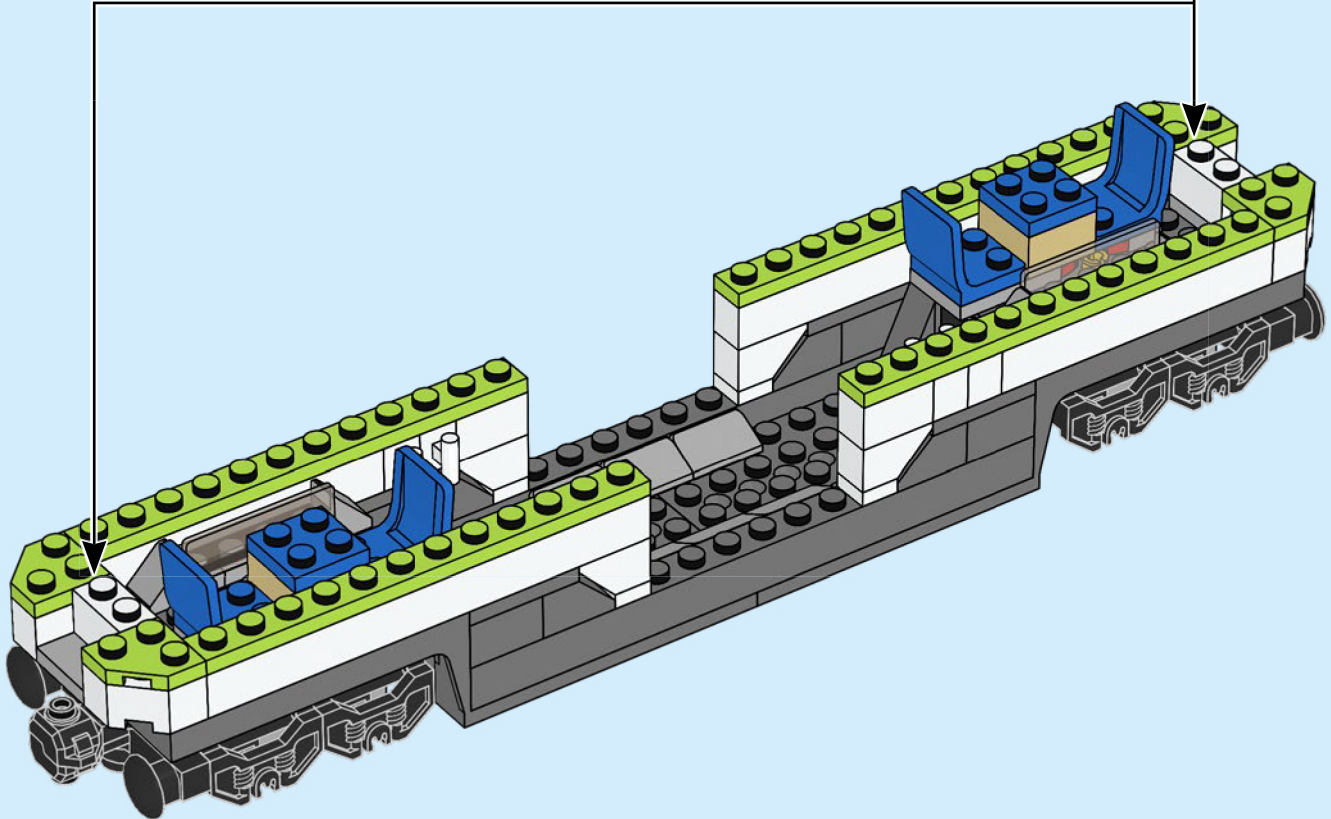

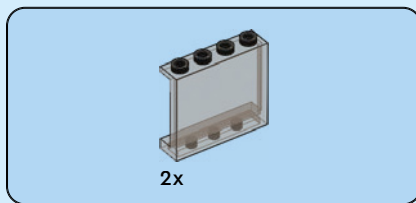

21

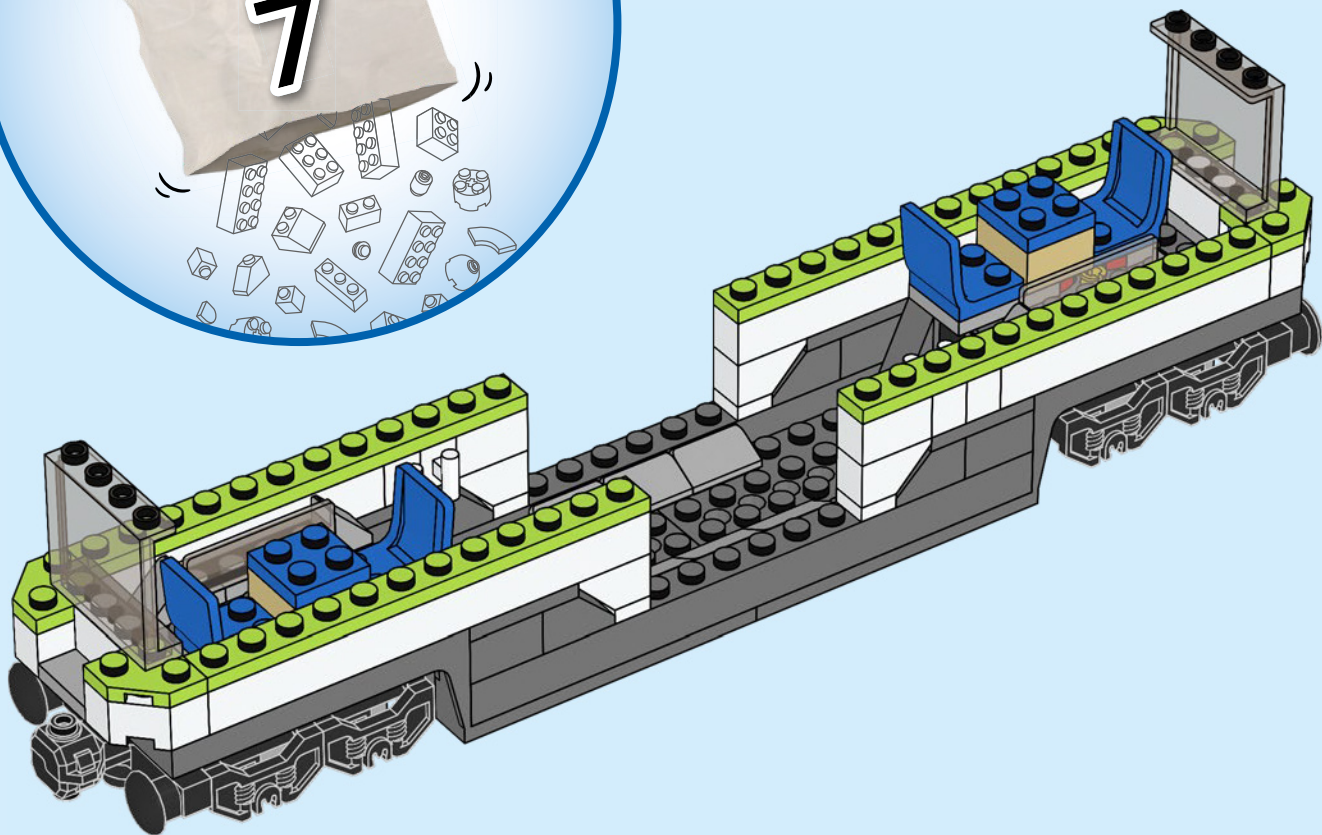



12x

22

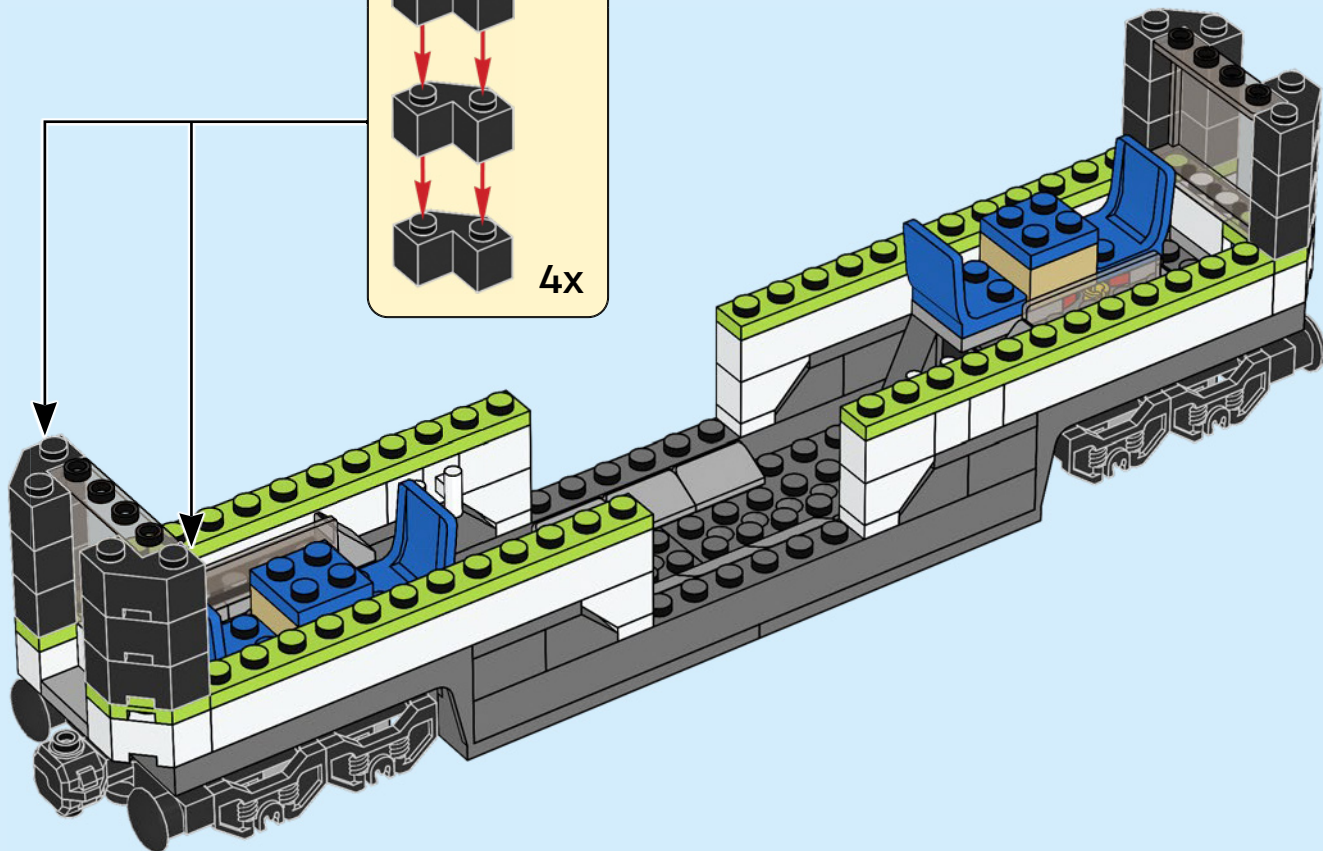
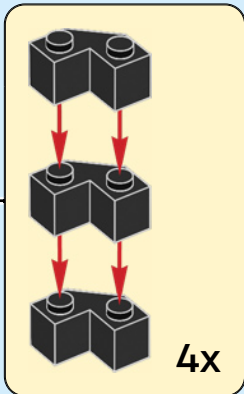



4x

23

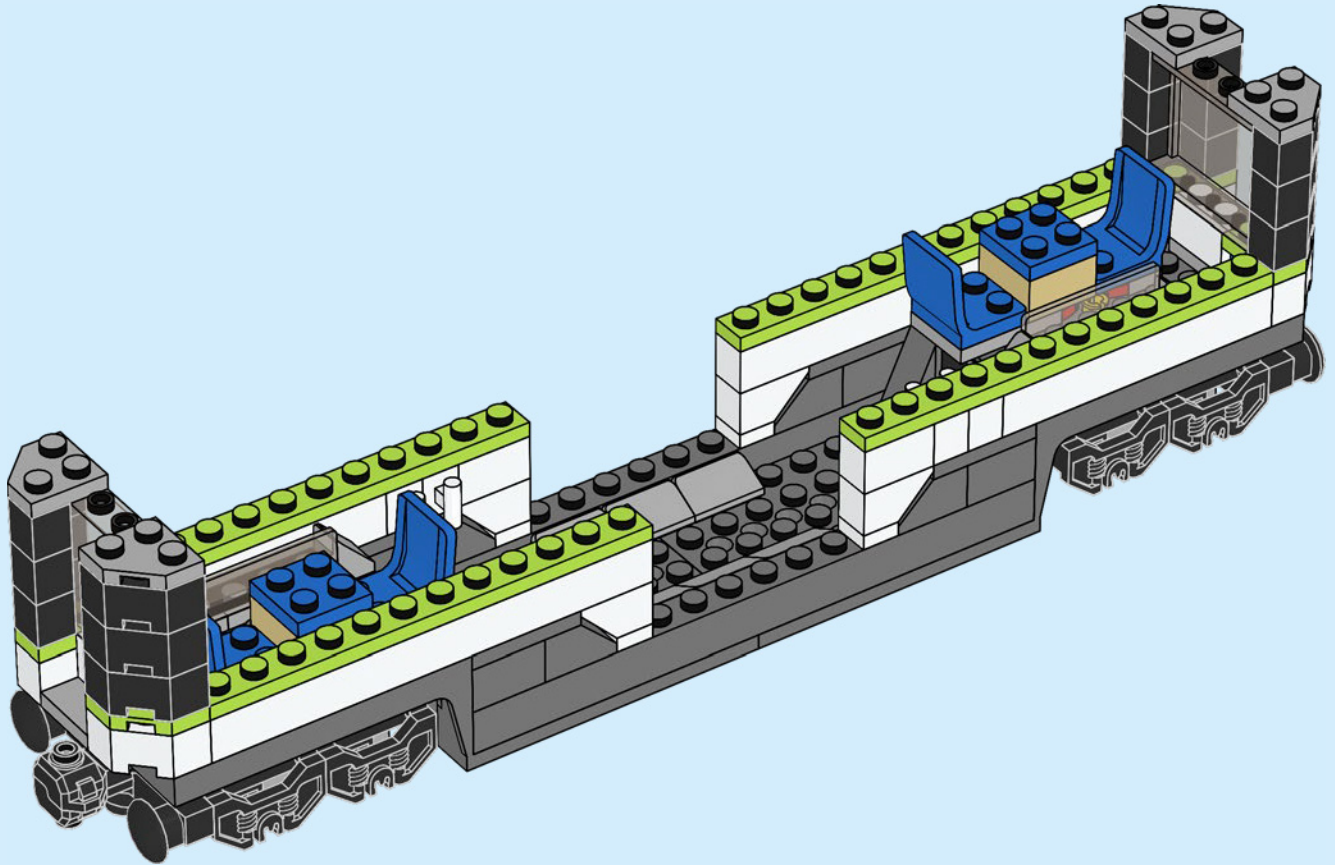



20x

24

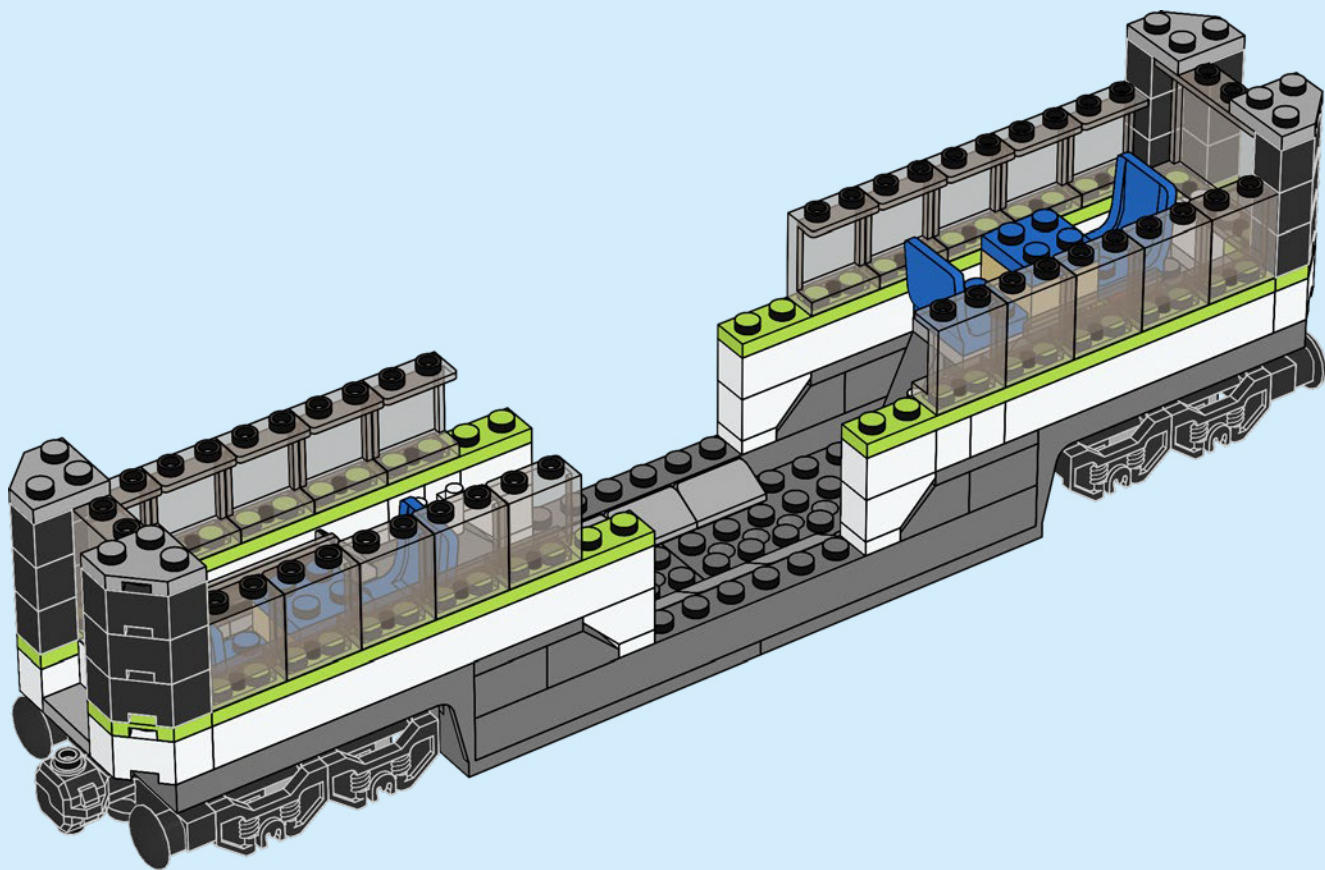

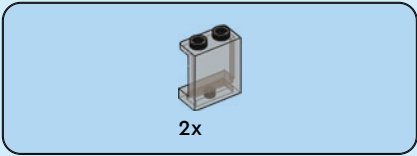

25

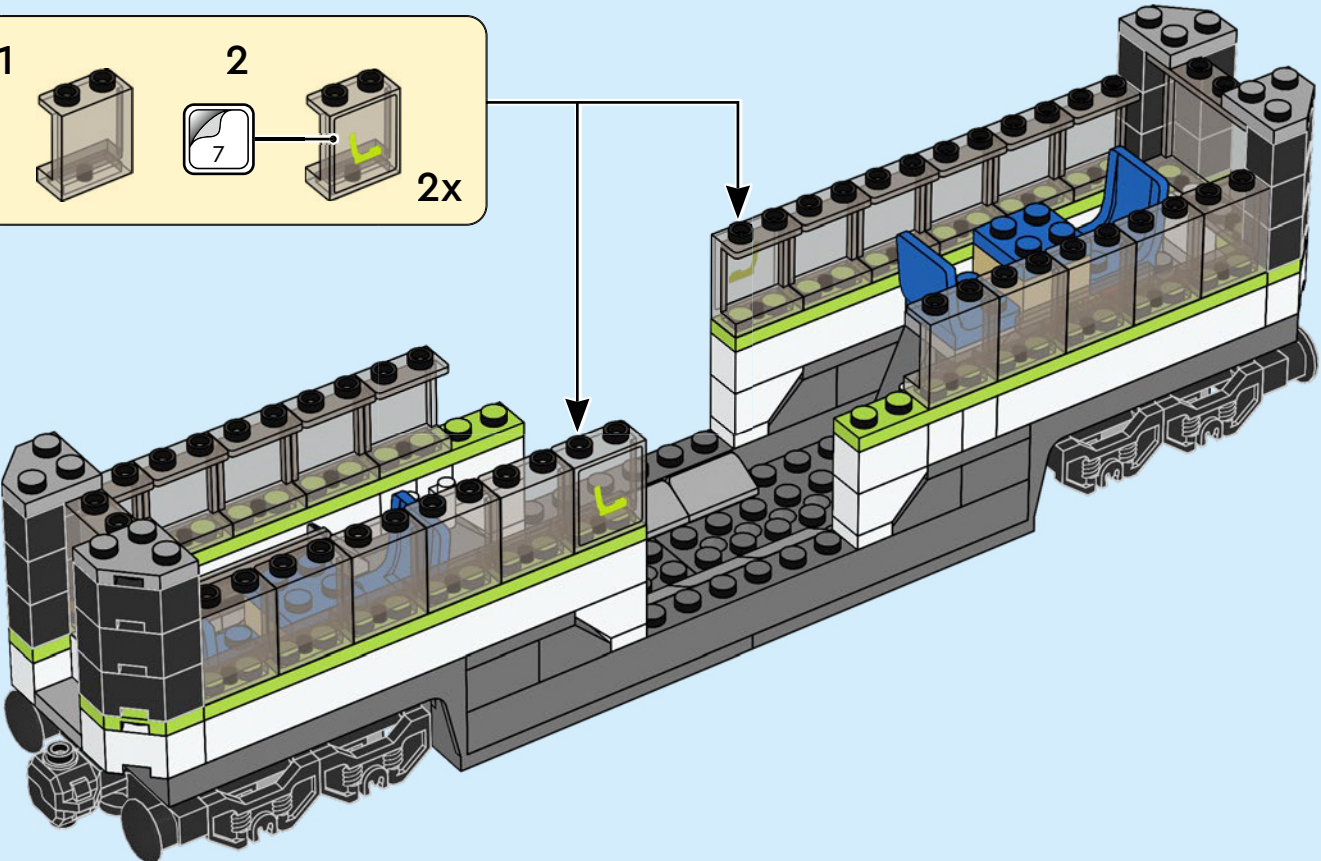
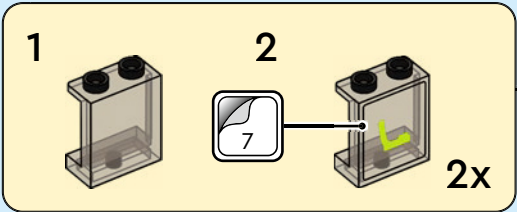

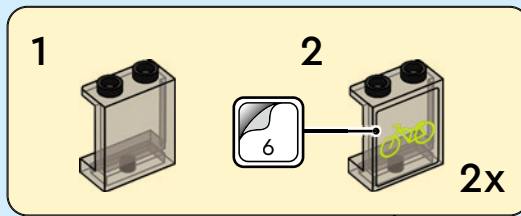
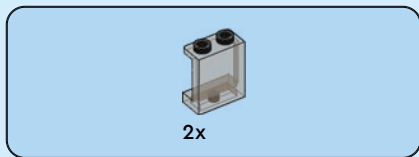

26

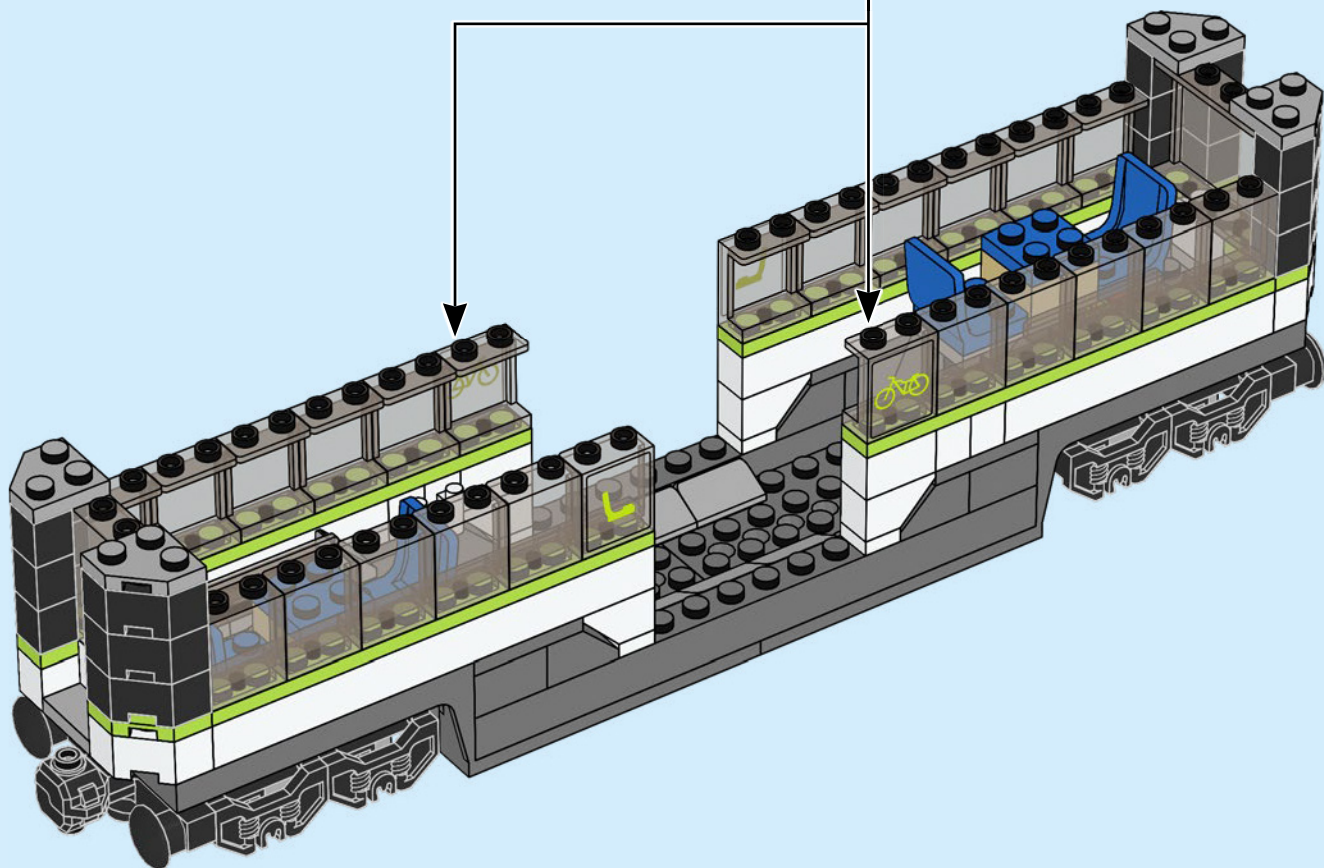

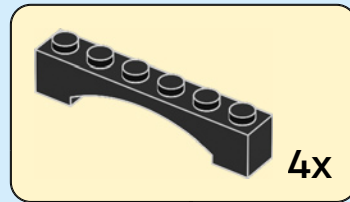
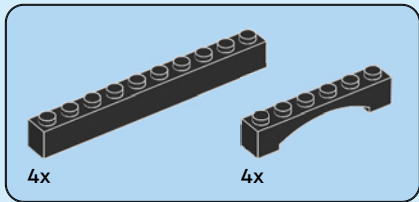

27

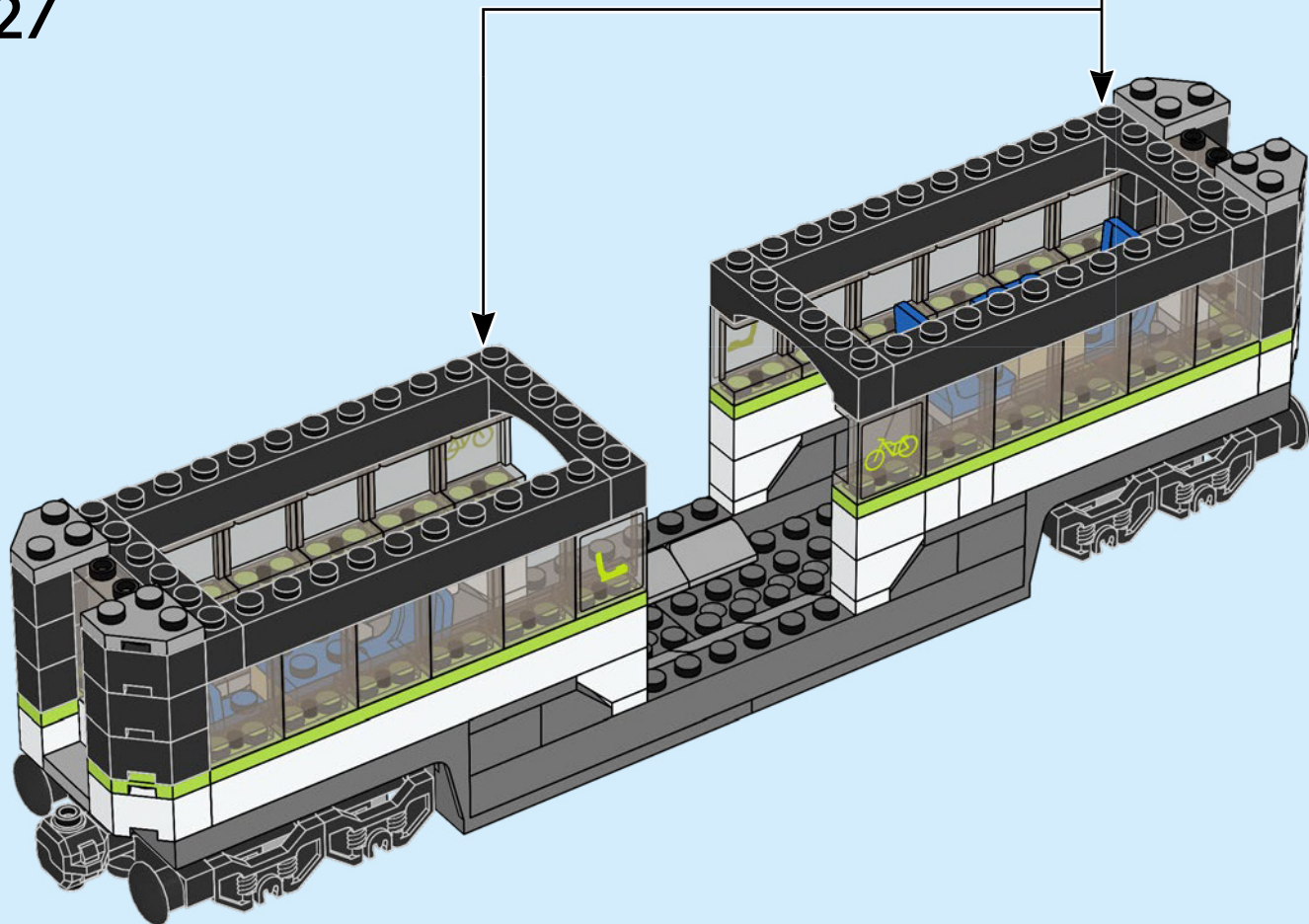

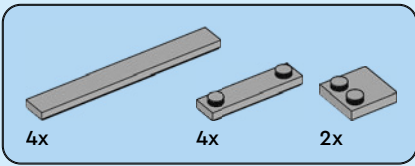

28

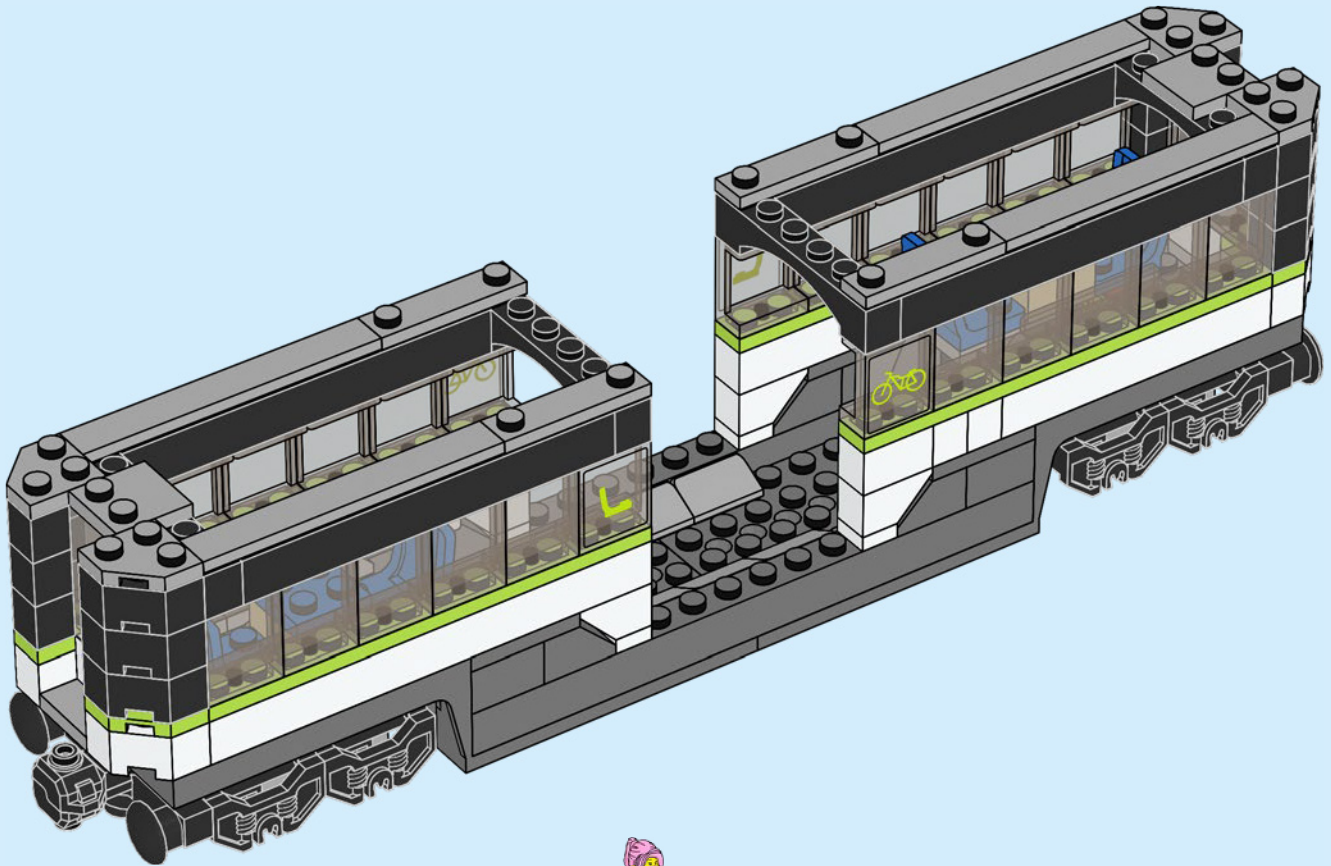

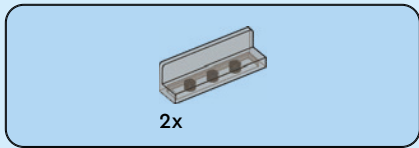

29

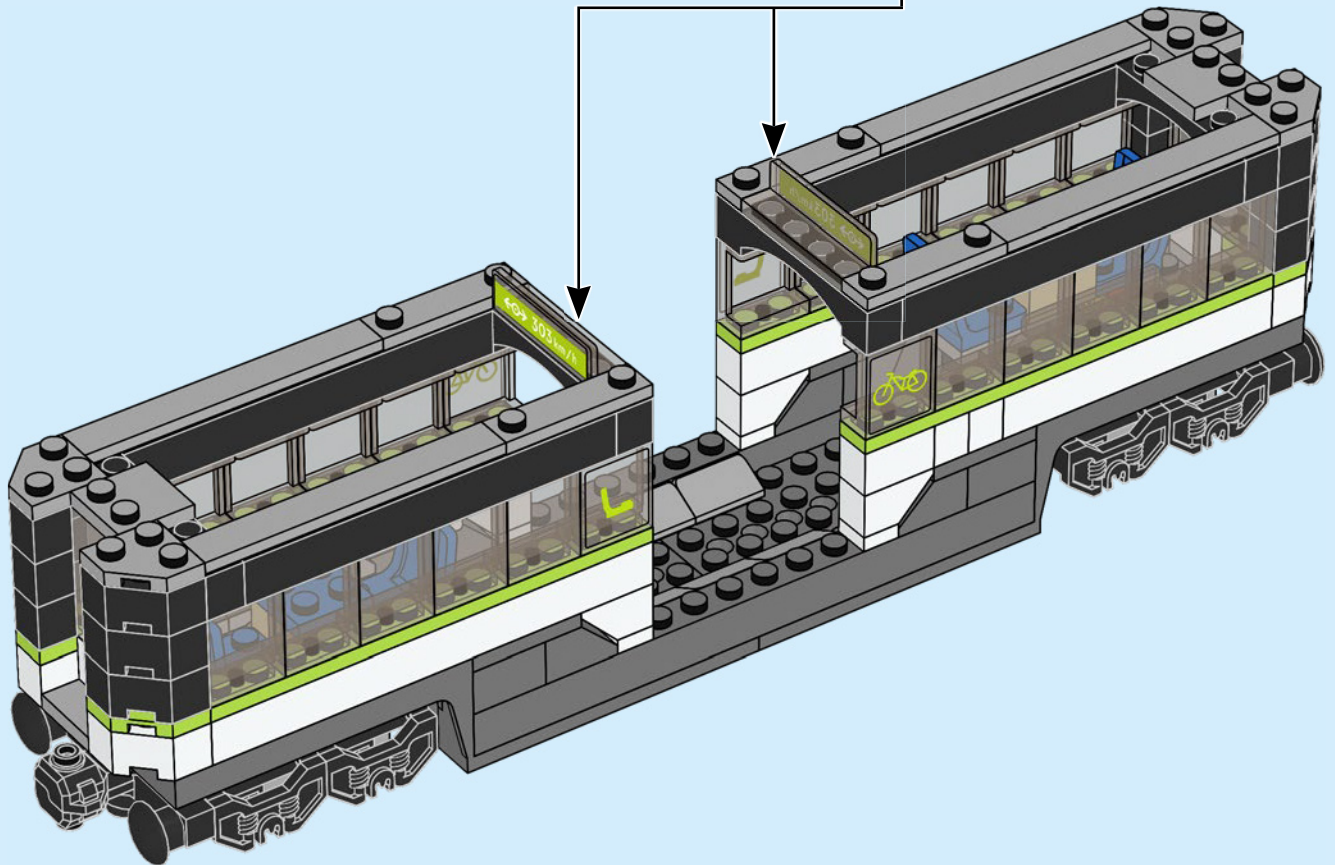
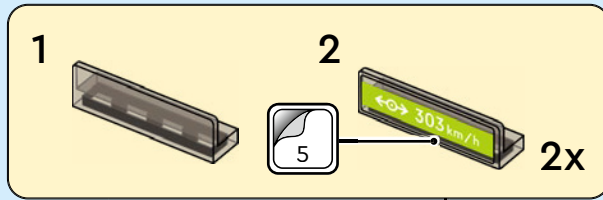

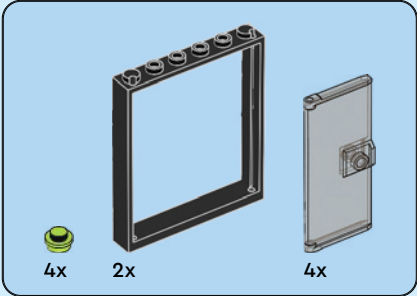

30

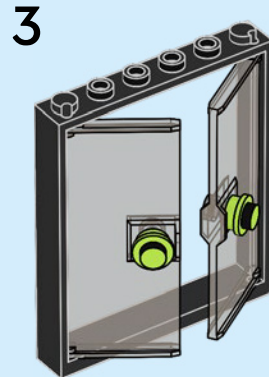
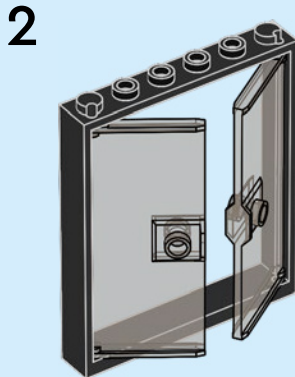
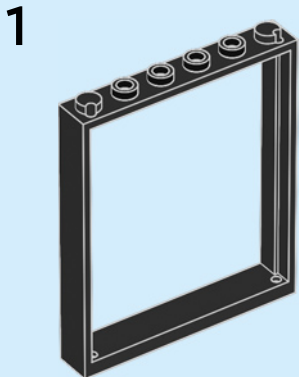

2x



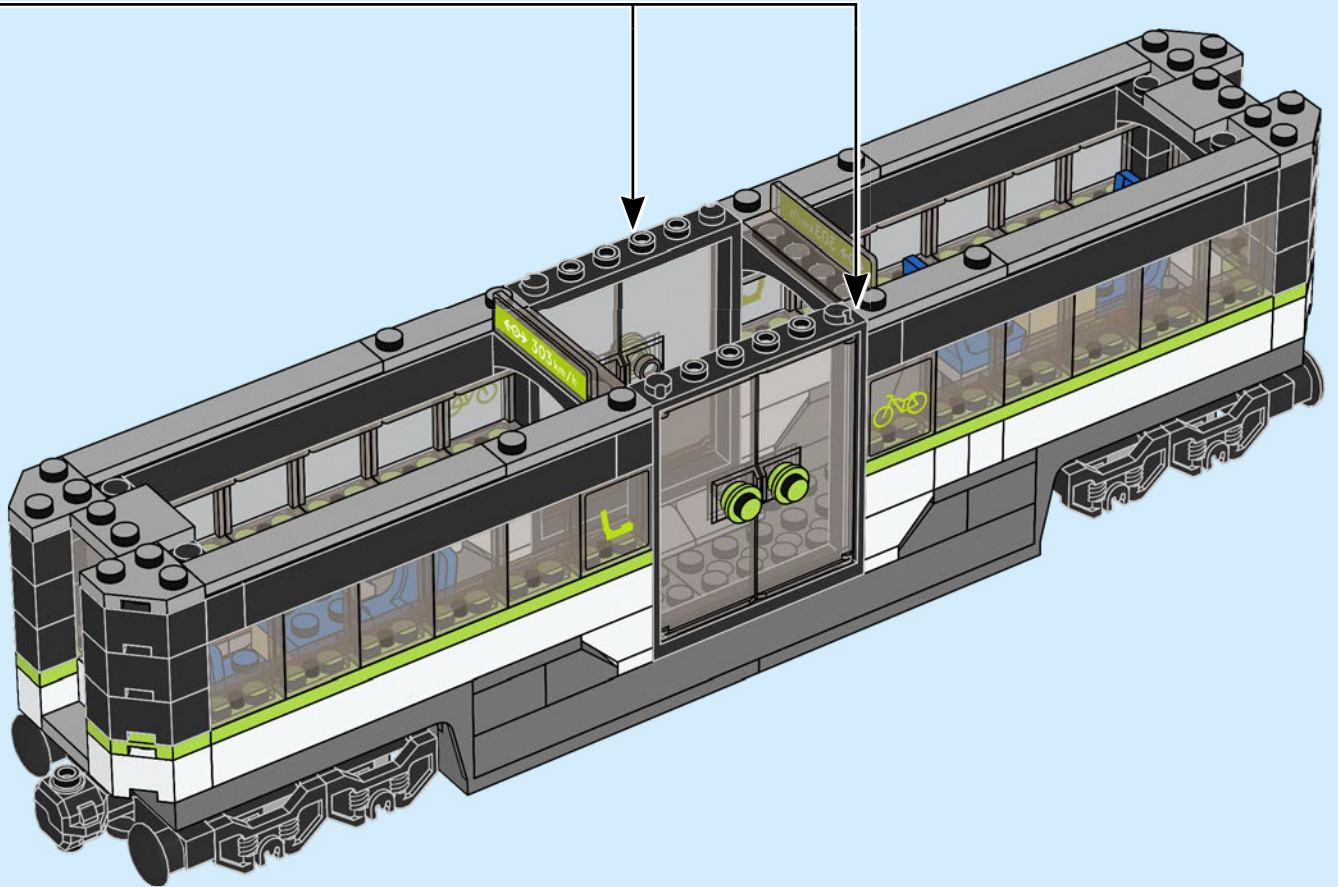

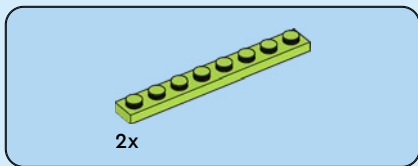

31

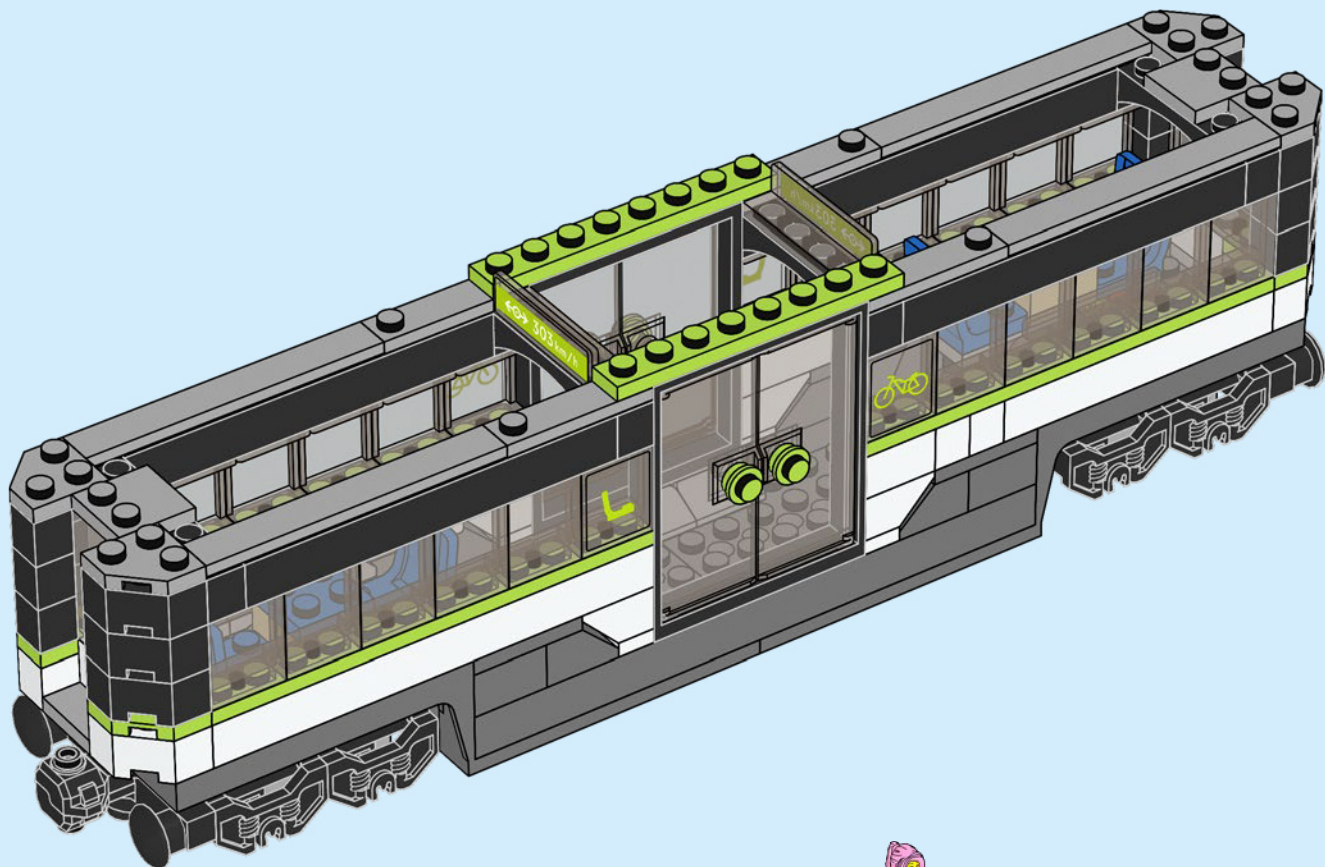

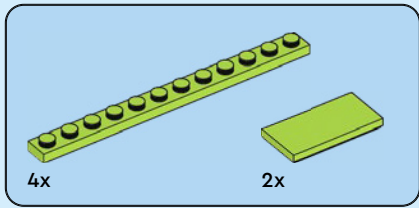

32

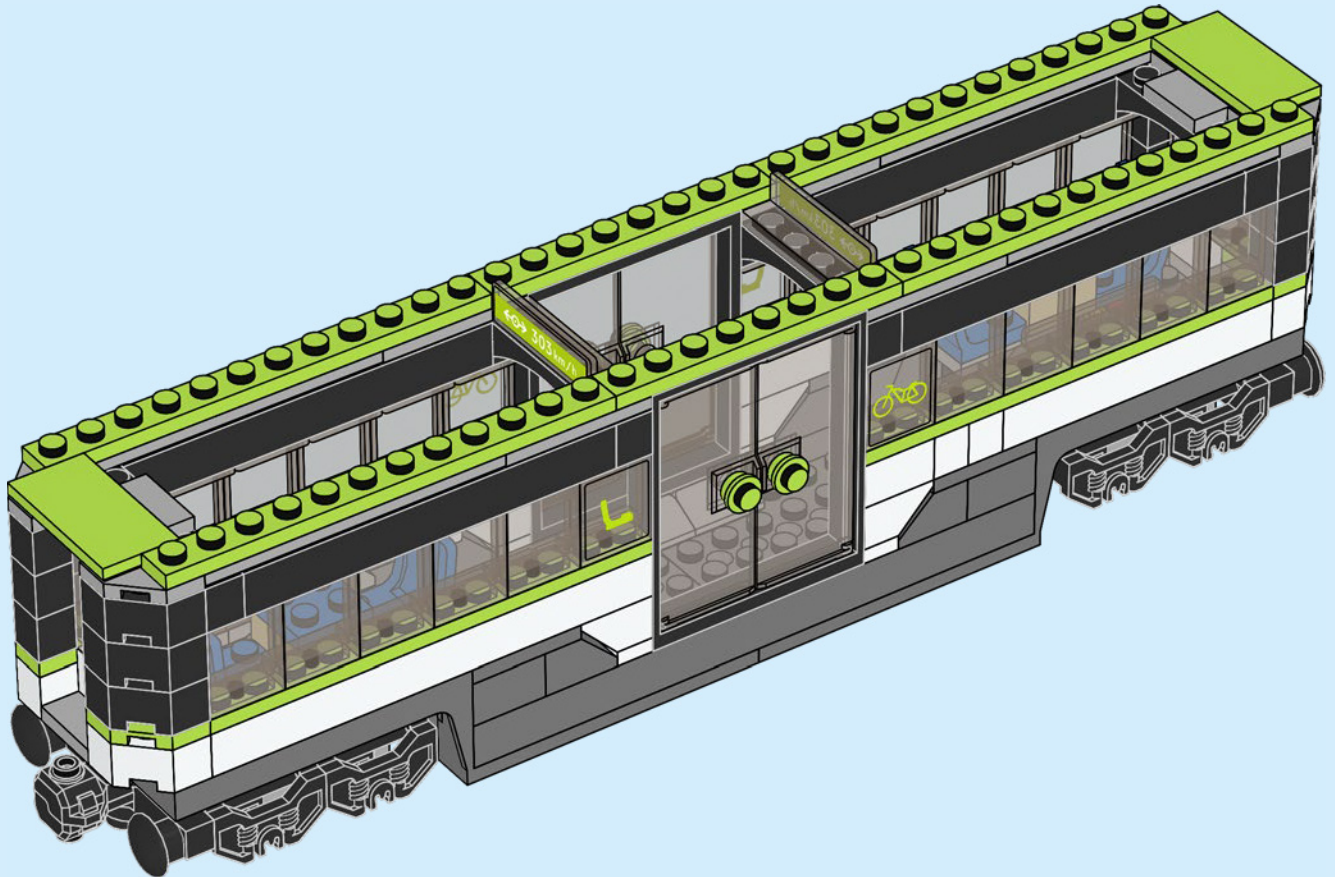

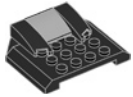

2x

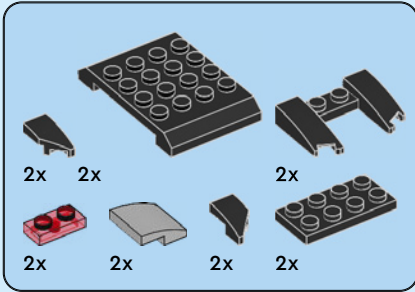

33

1

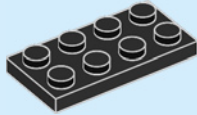

2

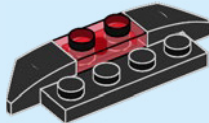

3

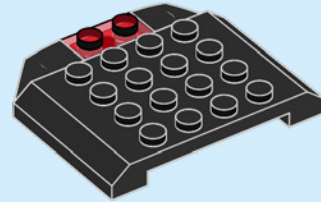

4

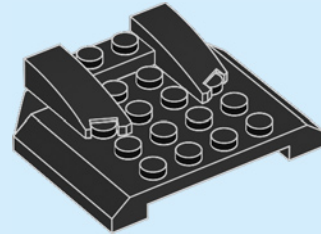

5

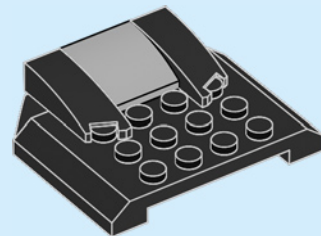

2x



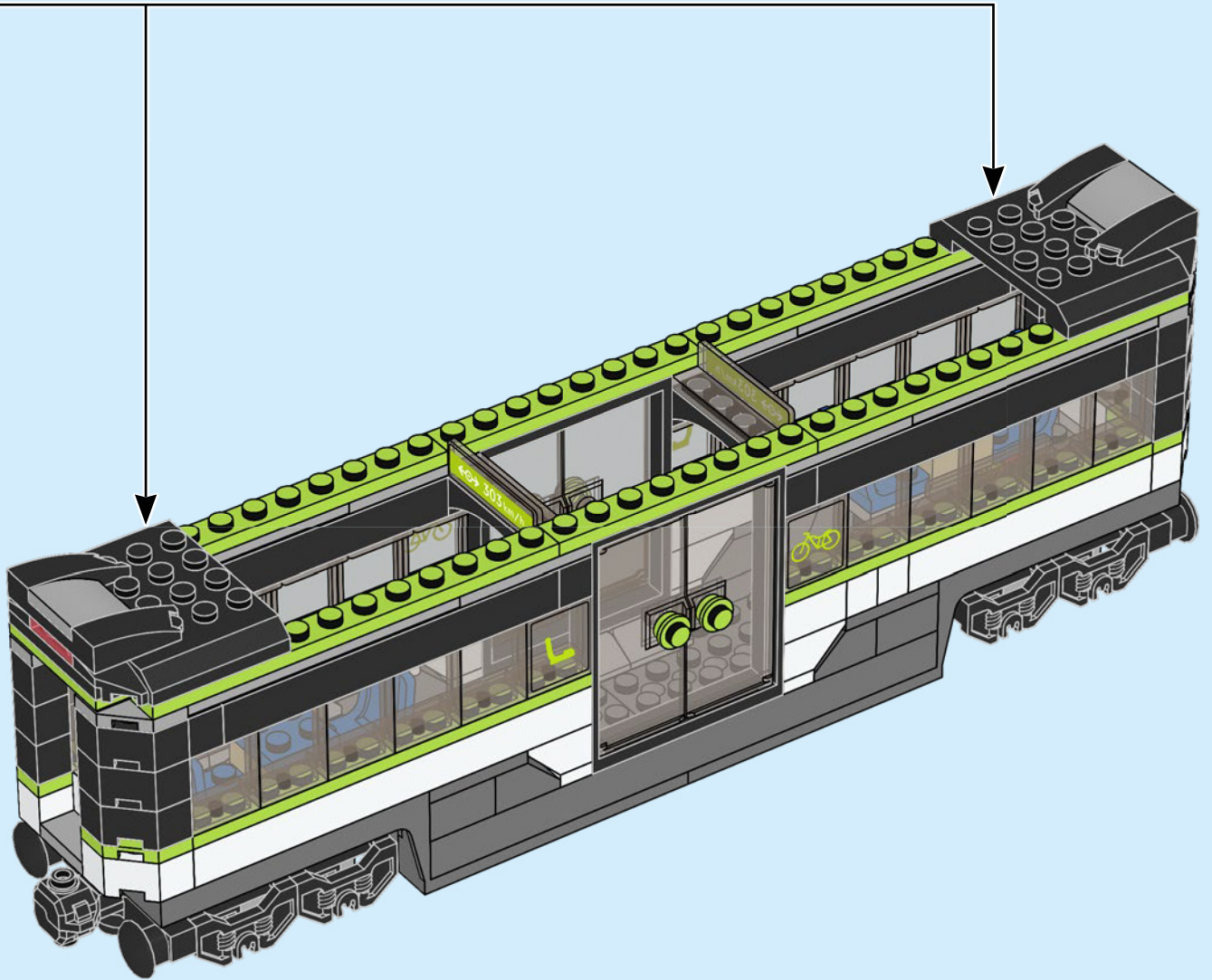

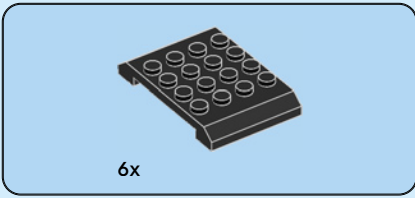

34

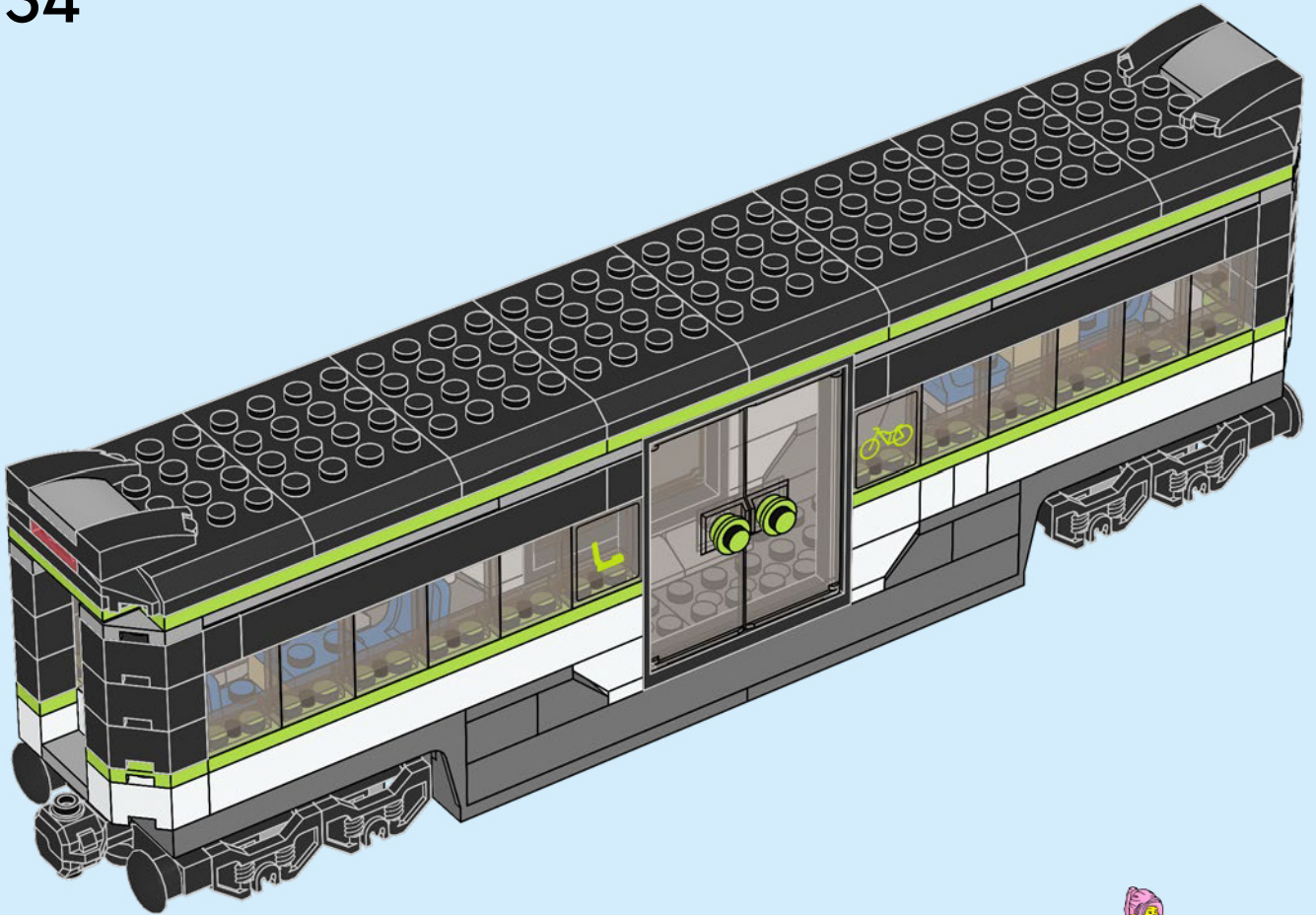



8x

35

