



# NINJAGO

Masters of Spinjitzu

70633



**KAI**  
**SPINJITZU**  
MASTERS





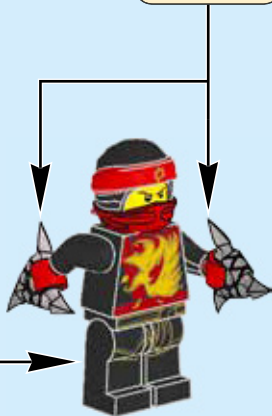
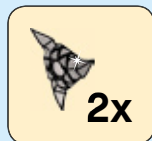



1

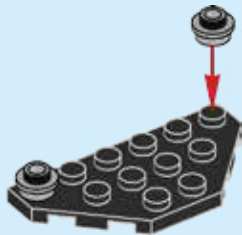

2

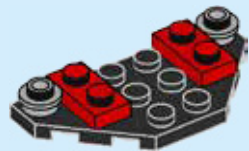



2x

3

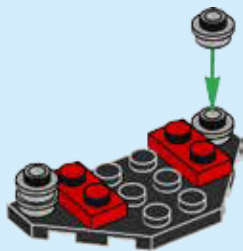

2x

4

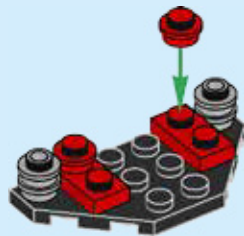



1x

5

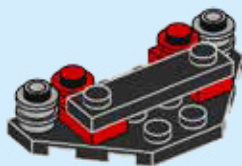

6



2x

6

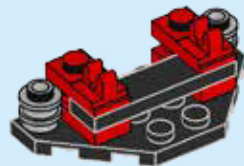



2x

7

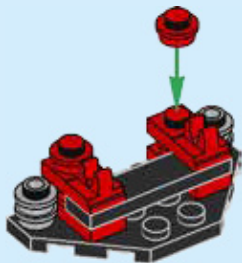

2x

8

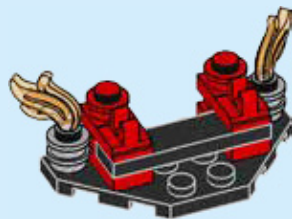



1x

9

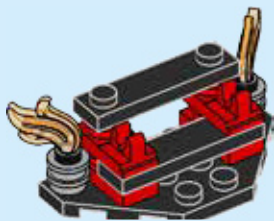

8





2x

10

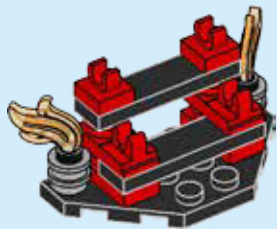

2x

11

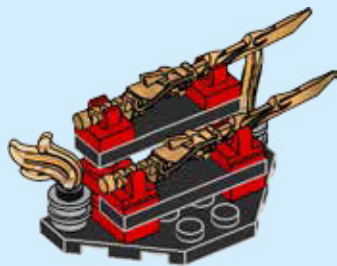

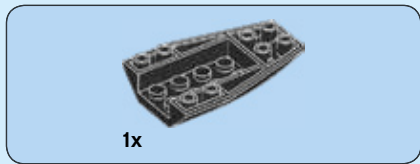

1

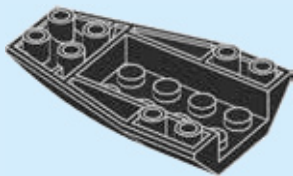

2

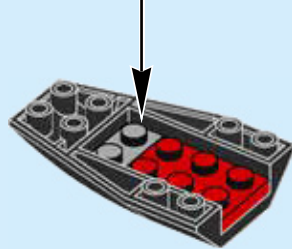
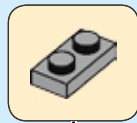



3

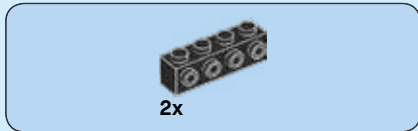
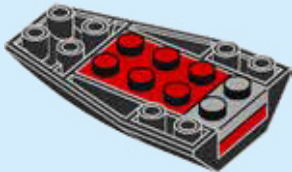

4

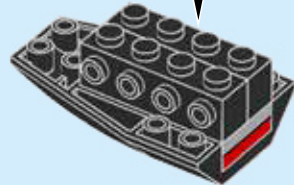
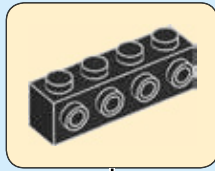

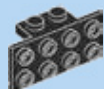

1x

5

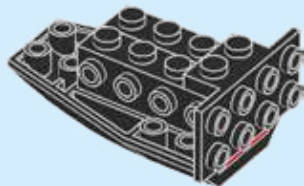

1x

6

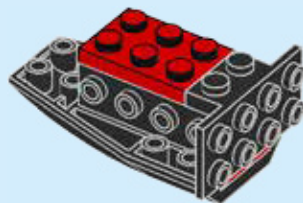



1x

7

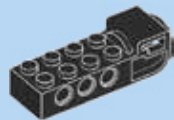
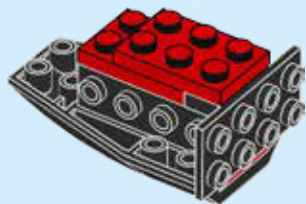

1x

8

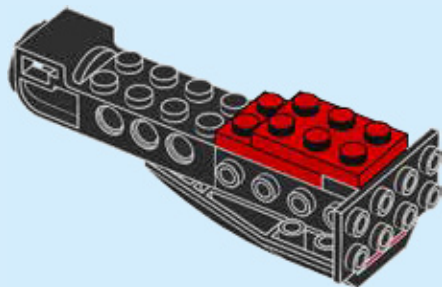

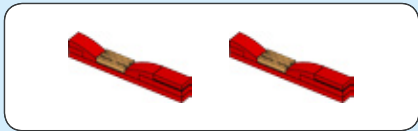

9

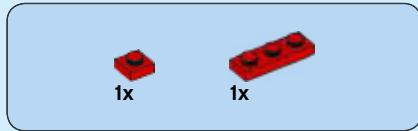
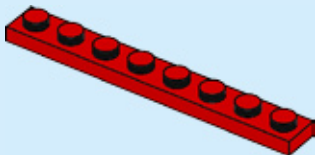

10

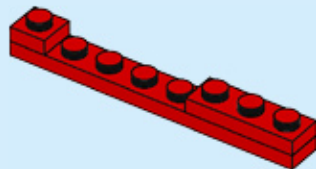



11

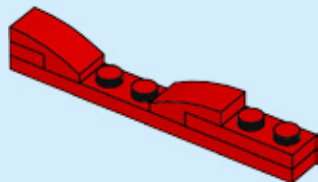

12

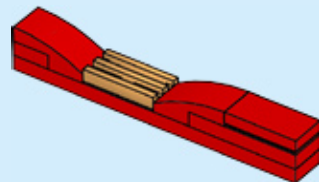

2x

13

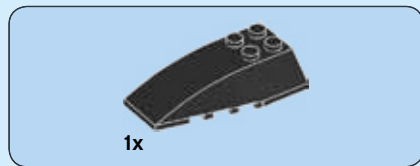
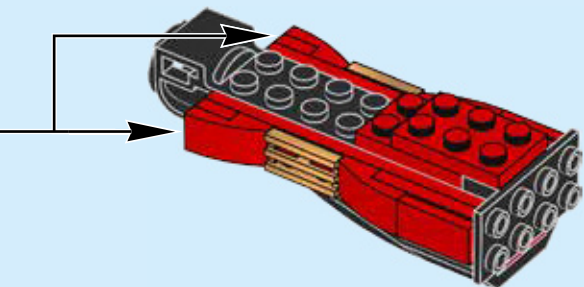

14

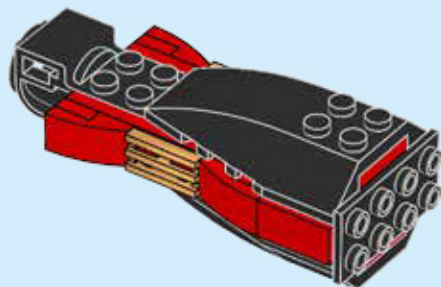





1x

15

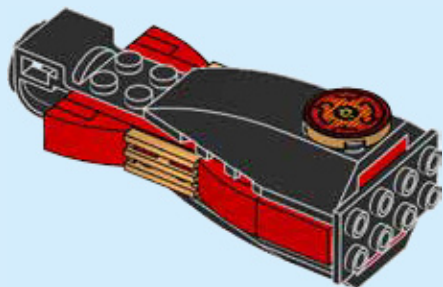

1x

16

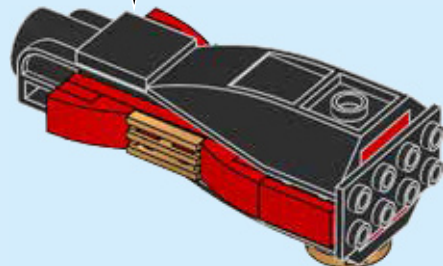
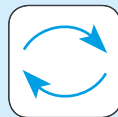



1x

17

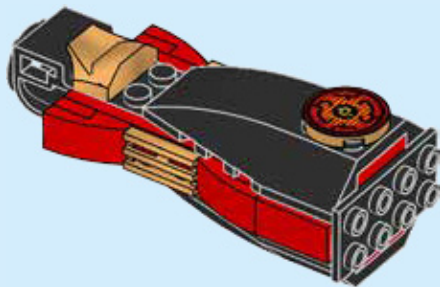
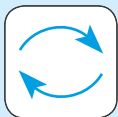

18



1x

18

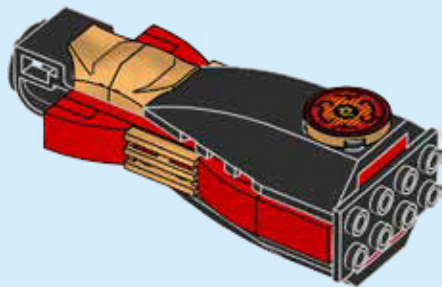

19

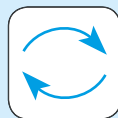

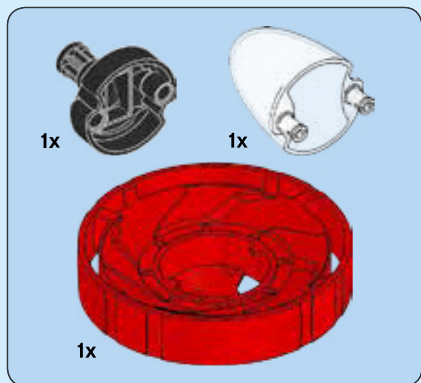

20

1



2



3

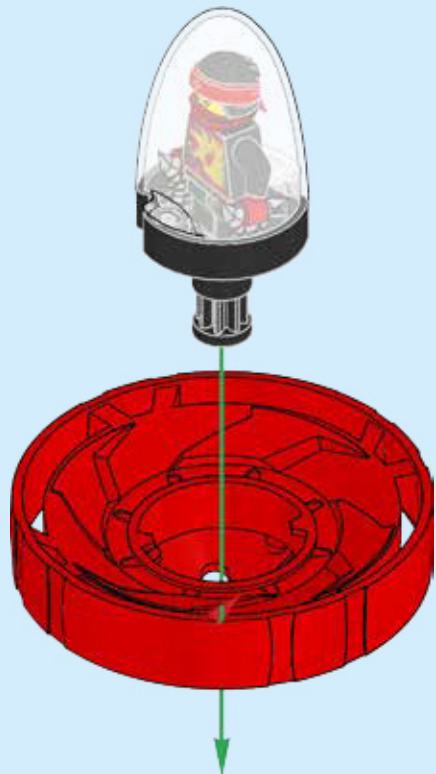

4

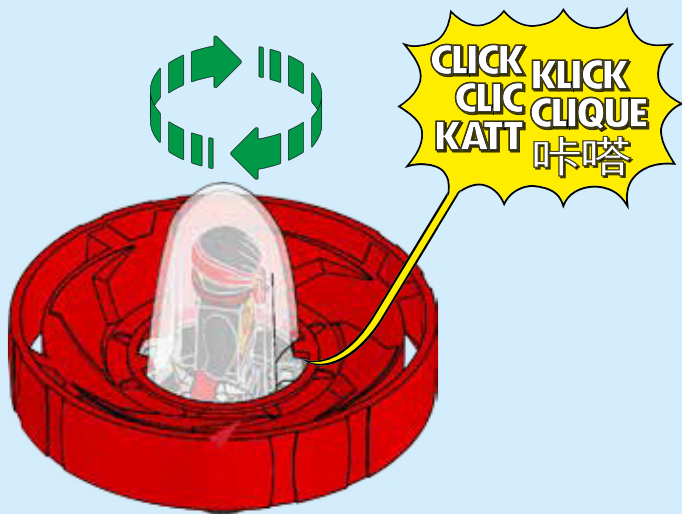

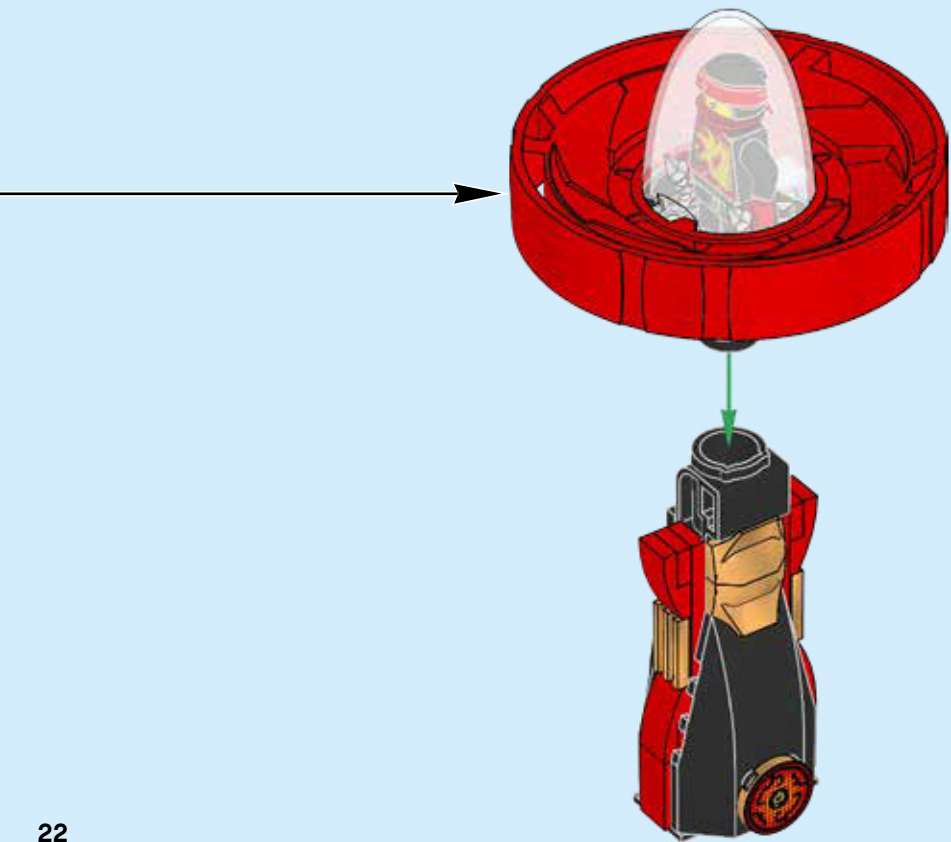

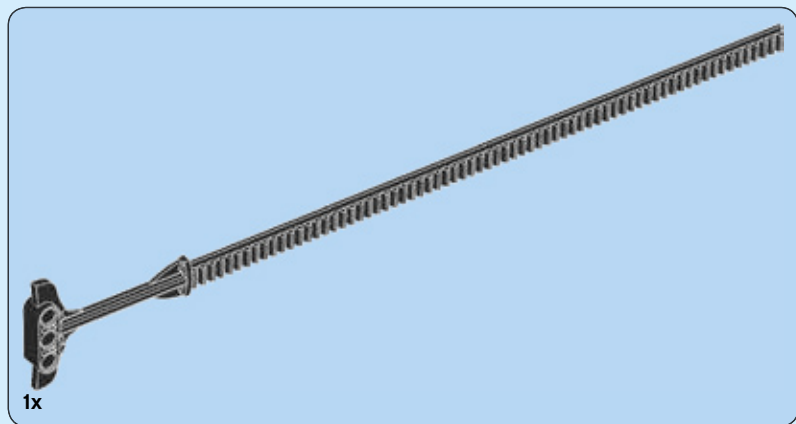

21

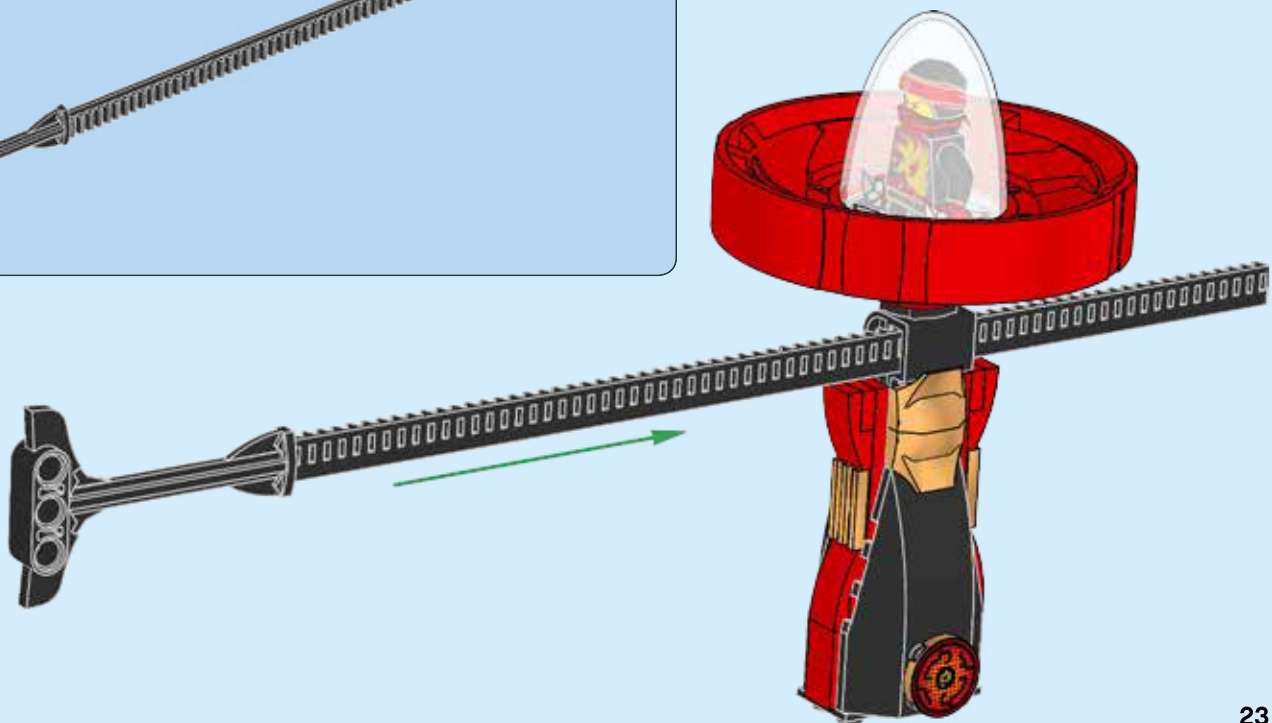

# #BeNinja

**1**  
RIP  
ZIEHEN  
LANCIA  
TIRA  
PUNJA O ČRBO  
RANTSU NEGI  
拉动

**2**  
ROLL  
RÖLLEN  
RÖLLEN  
FAI RUOTARE  
RUOLJA  
ROLJA  
PORBESO MEBI  
疾速滚动

**3**  
TRICK  
ASTUCE  
TRUCCO  
TRÜCK  
技巧



The Orbit  
Umkreisen  
L'Orbite  
Orbita  
La órbita  
A Órbita  
A pálya  
发射轨道





70637

**The Knockout**  
Umstoßen  
Le K.O.  
Demolitore  
El destructor  
O Knockout  
A kiütés  
猛击

70635

**The Leapfrog**  
Überspringen  
Le Saut  
Salto  
La rana  
O Salto ao Eixo  
A bakugrás  
蛙跳

70634

**The Zen**  
Zen-Übung  
Le Zen  
Zen  
El zen  
O Zen  
A zen  
禅

70628

**The Palm Spin**  
Handkreisel  
Le « Palm Spin »  
Rotazione sulla mano  
En la mano  
Spin na Palma da Mão  
Kézi pörgettyű  
掌中旋转

# SPINJITZU MASTERS

**The Drift**  
Driften  
Le dérapage  
Sbandata  
El derrape  
Impulso Ondeante  
Drifteles  
疾速漂移

70636

70633

**The Orbit**  
Umkreisen  
L'Orbite  
Orbita  
La orbita  
A Orbita  
A pályá  
发射轨道



70628



70633



70634



70635



70636



70637



# NINJAGO

Masters of Spinjitzu



*Cool tricks online!*  
*Cool Tricks online*  
*Des astuces cool en ligne*  
*Fantastici trick online*  
*Los mejores trucos online*  
*Truques fantásticos online*  
*Vagány trükkök online*  
*在线炫酷技巧*



LEGO.com/life

LEGO.com/NINJAGO

LEGO

# NINJAGO

Masters of Spinjitzu

NINJA GEAR  
 NINJA-AUSRÜSTUNG  
 ÉQUIPEMENT DE NINJA  
 ACCESSORI NINJA  
 ACCESÓRIOS NINJA  
 EQUIPAMENTO NINJA  
 NINZSA FELSZERELÉS  
 忍者装备



# #BeNinja

All materials might not be available in all markets.  
 Möglicherweise ist nicht das ganze Material in allen Märkten verfügbar.  
 Certains produits peuvent ne pas être disponibles sur certains marchés.  
 Tutti i materiali potrebbero non essere disponibili in tutti i mercati.  
 Ciertos materiales podrían no estar disponibles en todos los mercados.  
 Os materiais poderão não estar todos disponíveis em todos os mercados.  
 Elképzelhető, hogy bizonyos kiegészítők a Te országodban nem elérhetőek.  
 部分内容可能不适用于某些国家/地区

**LEGO**

# NINJAGO

Masters of Spinjitzu

70640



70640



70639



70638



70639



70638

**LEGO** NINJAGO<sup>®</sup>  
The Ride



**LEGO**  
**LEGOLAND**  
RESORTS

BILLUND • DEUTSCHLAND  
WINDSOR • MALAYSIA

**EXCLUSIVELY • EXKLUSIV • EXCLUSIVEMENT • EN EXCLUSIVA • ESCLUSIVO  
EXCLUSIVAMENTE • KIZÁRÓLAGOSAN • 独家所有 • EKSKLUSIVT • ここだけの特典 • ÖZEL**

**LEGO**  
**LEGOLAND**  
DISCOVERY CENTRE

Manchester • Berlin • Oberhausen  
Istanbul • Osaka • Shanghai • Tokyo



LEGO, the LEGO logo, the Brick and Knob configurations, NINJAGO, the Minifigure and LEGOLAND are trademarks of the LEGO Group.  
©2017 The LEGO Group. LEGOLAND is part of Merlin Entertainments plc.

**LEGOLAND.COM**

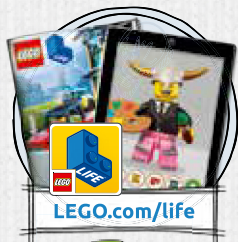



1x  
6212938



2x  
4162443



4x  
614121



4x  
6029946



1x  
6212640



1x  
6190411



1x  
6190398



1x  
6210763



2x  
6072998



2x  
362321



2x  
6114676



4x  
6168647



1x  
6213362



1x  
241926



2x  
302421



4x  
302121



2x  
4490599



2x  
4211398



2x  
302321



2x  
346021



2x  
6096099



2x  
4649066



1x  
6013867



1x  
6210749



2x  
4597713



1x  
6211787



1x  
6117255



1x  
6210747



1x  
6118829



1x  
4180469



2x  
306921



1x  
6213247



2x  
4599499



1x  
6123844



1x  
6210760

Customer Service

Kundenservice

Service Consommateurs

Servicio Al Consumidor

LEGO.com/service or dial



: 00800 5346 5555

: 1-800-422-5346

# WIN

GO TO [WWW.LEGO.COM/PRODUCTFEEDBACK](http://WWW.LEGO.COM/PRODUCTFEEDBACK) AND  
GIVE US YOUR SHORT **FEEDBACK** ABOUT THIS  
LEGO® SET FOR A CHANCE TO WIN  
A COOL LEGO PRIZE.

Terms & Conditions apply



## [LEGO.com/productfeedback](http://LEGO.com/productfeedback)

### GEWINNE

Erzähle uns auf  
[www.LEGO.com/productfeedback](http://www.LEGO.com/productfeedback)

etwas über die Erfahrungen, die du mit  
diesem LEGO® Set gemacht hast, und  
sichere dir die Chance auf einen coolen  
LEGO Preis!

Es gelten die Teilnahmebedingungen

### GAGNE

Rends-toi sur  
[www.LEGO.com/productfeedback](http://www.LEGO.com/productfeedback)

et donne-nous quelques commentaires sur  
ce produit LEGO® pour avoir une chance  
de gagner un prix LEGO !

Voir Conditions Générales

### GANAN

Visita  
[www.LEGO.com/productfeedback](http://www.LEGO.com/productfeedback)

y envíanos tu opinión acerca de este set  
LEGO®. ¡Participarás en el sorteo de un  
premio LEGO!

Términos y Condiciones aplicables

### 获取奖品

登录  
[www.LEGO.com/productfeedback](http://www.LEGO.com/productfeedback)

给出关于此乐高®套装的简短反馈，  
就有机会获得炫酷乐高奖品

《条款及条件》适用

LEGO, the LEGO logo and NINJAGO are trademarks of the LEGO Group. ©2018 The LEGO Group.

6224551