

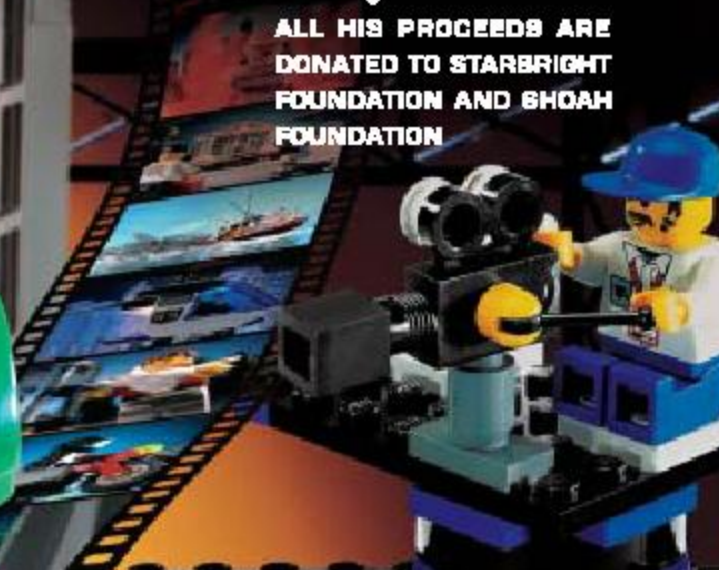

Steven Spielberg

ALL HIS PROCEEDS ARE
DONATED TO STARBRIGHT
FOUNDATION AND SHOAH
FOUNDATION



SOFTWARE MANUAL
BUILDING INSTRUCTIONS
DIRECTOR'S HANDBOOK

WELCOME TO THE WORLD OF IMAGINATION AND CREATIVITY.

With this MovieMaker Set, you have a gift that can lead you to hours of fun and accomplishment.

You may not even realize that when playing with your own toys, you were already telling stories. Now you have a chance to share with your friends the stories you have been telling all these years.

There wasn't anything like this when I made my first films as a young teenager so you already have a running start. This book, filled with instructional tips, can help you step by step toward making your own movies.

Yet, all the instructions, the digital camera, the packages of bricks and props, your personal computer are just the tools. The most important elements are in your imagination where all ideas begin.

Get the most out of those ideas by developing them into stories. You can do it with the characters and situations that you invent; the settings, your camera angles, your movements, your sounds, your music, and visual effects.

Personal movie-making is all about the choices you make.

You are the storyteller. You're totally in charge. You have final cut.

May the MovieMaker Set give you hours of enjoyment and, who knows, perhaps a desire to someday tell stories for a living.

A handwritten signature in black ink that reads "Steven Spielberg". The signature is written in a cursive, flowing style with a large initial "S".

ALL HIS PROCEEDS ARE
DONATED TO STARBRIGHT
FOUNDATION AND SHOAH
FOUNDATION

LEGO® AND STEVEN SPIELBERG MOVIEMAKER BOOK



LEGO and Steven Spielberg MovieMaker Book
Manual written by Sheila Hanley
Software Consultants: Adriana Eyzaguirre and Adrian Price

Director's Handbook written by Guy Meredith and Jim Hill
Senior Designer: Stephen Scanlan
Edited by Shaheen Bilgrami
Designed by Studio Hegger

LEGO Media International Ltd, LEGO House, 33 Bath Road, Slough,
Berkshire SL1 3UF, United Kingdom

© 2000 The LEGO Group

® LEGO is a registered trademark of the LEGO Group

All rights reserved. No part of this publication may be reproduced, stored
in a retrieval system, or transmitted in any form or by any means,
electronic, mechanical, photocopying, recording or otherwise, without the
prior written permission of the copyright owner.

Picture Credits

t=top, m=middle, b=bottom

Wallace and Gromit image © Aardman/W&G Ltd 1989; p72b; Kobal
Collection: p88m; Kobal Collection/Amblin/Universal: p72m, p84m;
Kobal Collection/Warner Bros: p66m; Kobal Collection/United Artists:
p69t; Kobal Collection/Paramount: p63t; Kobal Collection/RKO: p65b;
Kobal Collection/Columbia: p85t; Kobal Collection/Hal roach: p63t;
Jaws image © Universal Studios Inc: p65t.

All other images © The LEGO Group

CGI artwork by Sebastian Quigley and Artwork (UK) Ltd

Colour reproduction by MULTI GROUP, Copenhagen, Denmark
Printed in USA

CONTENTS

SOFTWARE MANUAL	4 - 25	DIRECTOR'S HANDBOOK	62 - 104
		How to Make Magnificent Movies	
Getting Started	4	Introduction	62
Lights, Camera, Action! Filming Your Movie	8	The Idea	64
Cut! Editing Your Movie	12	The Characters and the Plot	66
Showtime! Watching Your Movie	22	The Script	68
Menu Options	24	Casting and Locations	70
Epilepsy Warning	25	Ready to Roll	72
		Lights - Camera - Action!	74
		Lighting	76
		Camera Shots and Angles	78
		Shooting Out of Sequence	80
		Sound	82
BUILDING INSTRUCTIONS	26 - 61	Stunts and Special Effects	84
		Editing Your Movie	86
		Editing the Sound	88
		Transitions and Credits	90
		Screening Your Movie	92
		What Next?	93
		Masterclass 1	
		Additional sound effects for you to create	94
		Masterclass 2	
		Additional animation effects for you to create	95
		Masterclass 3	
		Creating atmosphere using lighting	96
		Masterclass 4	
		Additional effects using different camera shots	97
		Ideas Sheet	98
		Storyboard Sheet	100
		LEGO Studios Sets	102
		How to use your LEGO PC Movie Camera on the Internet	104

GETTING STARTED

Start by following the instructions on the installation card – **do not plug in your camera until you have finished installing the software!**

Welcome to The LEGO® & Steven Spielberg MovieMaker Set. I'm the director and I'm going to take you through every stage of the moviemaking process, step by step. I'll also share some inside information and give you a few hot tips on how to make great movies. By the time we're through, you'll be on your way to becoming a top director yourself.

The first thing you have to do is read the installation instructions on the enclosed leaflet. Once you've loaded the MovieMaker Set software CD-ROM, this is what you'll see on your screen.

Here, you will find four buttons.





The first time you put the MovieMaker Set CD-ROM into your computer, the **Install** button will appear. Click on this button, then follow the on-screen directions to install the program.

Do not plug in your camera to the USB port until you are asked to do so. Otherwise, the software may not work correctly. If this happens, please try the following:

- **Unplug the camera from the USB port**
- **Restart your computer**
- **Follow the installation instructions carefully.**



Every time you use the MovieMaker Set software from now on, you will see the **Play** button instead of the **Install** button. When you click on **Play** you will be taken straight to the **Film Screen** so that you can start filming. Find out all about the **Film Screen** on page 8.



If you want to uninstall the MovieMaker Set software, follow these simple steps:

- Click on the **Start** button in the bottom left-hand corner of your screen
- Click on **Programs**
- Click on the **LEGO Media** folder
- Click on the **LEGO Studios** folder
- Select **Uninstall-Re-install**
- Follow the on-screen directions and the MovieMaker Set software will be removed from your computer.



Tutorial Click on this button to go to the tutorial, where you get to meet me in person. I'll show you how to film, edit and view a movie. The tutorial is divided into different sections. You can click on each section in turn so I can tell you all there is to know about making movies with the MovieMaker Set. Or, you can choose just one section that you want to hear about.

You can get back to the tutorial whenever you want, no matter what screen you're on. Click on **Help** and then on **Tutorial**. The LEGO & Steven Spielberg MovieMaker Set CD-ROM must be in the CD-ROM drive before you can visit the tutorial.

THE TIPS SCREEN



This is where you'll find some clever moviemaking tricks. This inside knowledge will give you a head start in your own career as a brilliant movie director.



Viewer Controls Press these buttons to play, stop or skip to the beginning of any movie. The two small buttons on the right take you back to the previous movie or forwards to the next movie.



Great LEGO Movies Sit back and watch some of my best movies, made using this Steven Spielberg MovieMaker Set.



Story Starters Click on this button to see clips that show special effects that can be created using some of the other LEGO sets. The clips will also give you ideas for making your own movies.



Tips and Tricks Click on this button to see short movies that show you how to create great effects in your movies.

PRE-PRODUCTION

As any director knows, there's a lot to prepare before you can actually start making a movie. First, you'll need a story or script. You should also think about characters and decide how you are going to light each scene of your movie.

Building your sets is another important pre-production stage. Here at the LEGO Studios, we use LEGO pieces to create our sets. In the box, you'll find the pieces for creating a dinosaur movie. There are step-by-step instructions for building the set that begin on page 26. The Director's Handbook which begins on page 62 has lots of information on how to make a movie – from writing a screenplay to shooting your movie.

Naming Your Movie

A window will pop up to allow you to name your movie when you turn on the program for the first time and then every time you start a new movie. If you want to, you can work on more than one movie at a time. Your movie will be automatically saved when you close down and quit out of the MovieMaker Set software. If you shut off your computer without closing down the software first, your movie will not be saved.

Start Filming!

Once you've got your script, set, cast and sound ready, you can start filming. You shouldn't try to film your movie all in one step. Instead, film it in sections, one short section at a time. These short sections of movie are called clips. Eventually, you will put your clips together and add special effects to make a complete movie. This is called editing. You will find out how to edit a movie on page 12. But first, let's find out how to film a clip. Are you ready? Let's go!



LIGHTS, CAMERA, ACTION!

FILMING YOUR MOVIE

THE FILM SCREEN

When you insert the MovieMaker Set CD-ROM, a screen will appear with some options. To begin with, press the **Play** button. This will take you to the Film Screen. On this screen you will find the following:



Viewer This shows you what the camera is pointing at.



If you want to get back to the Film Screen, click on the **Film** button. A red light under the **Film** button shows that you're on the Film Screen.



Clips Area This is where all the clips you record are stored and displayed.



Forward and Backward Buttons You can see up to 12 clips at a time in the Clips Area. Your other clips are stored on separate pages. Use these buttons to flip through the pages to find the clip you want.



Trash Can If you want to get rid of a clip that doesn't work, you can delete it. To do this, highlight the clip, then click on the **Trash Can**. Remember, once you've done this it will be gone for good.



Disk Space Counter This counter lets you know how much space there is left on your hard drive. You can work out how much more filming you can do by looking at this.

Picture Controls

These four sliders change the quality of your picture. If you move the sliders up or down, you will see what effect they have.



Brightness controls how bright or dark your picture is.



Contrast adjusts the amount of light and shadow in your picture.



Saturation affects the strength of the colors in your picture.



Volume changes the level of the sound in the recording.

Filming Clips

There are two ways of filming clips using your LEGO PC Movie Camera. The first is called live action filming. In live action filming, the camera simply records what is happening in front of it.

The second kind of filming is called stop motion animation. It's a little more difficult than live action filming and takes time and patience to get just right.



Live Action

Let's say you want to film a live action clip using the Mini figure, the dinosaur and car from your set. This is what you do:



- Press the **Live Action** button.
- Point the camera at the car. Use the Viewer to make sure the camera is pointing at the right spot.



- When you are ready to start filming, press the **Start Filming** button. The camera will start recording.
- Make the action happen. [Why not push the car along to make it move?]



- The Frame Counter will show how many seconds of movie you are recording.



- When the action is over, stop filming. Notice how the **Start Filming** button has changed into the **Stop**. Press it to stop filming.

You will see that the clip appears in the top right-hand corner of the Clips Area. If you want to watch the clip you have filmed, you need to go to the Edit Screen and watch it on the Viewer there. Look on page 12 to find out how to get to the Edit Screen and how to use the Viewer.



Stop Motion Animation

A movie clip is made up of lots of single pictures, called frames. In live action filming, the camera takes lots and lots of pictures automatically. In stop motion animation, you film each picture one by one. This is how to film animation:



- Click on the **Animation** button.
- Set up a scene from your movie and point the camera at it. Use the Viewer to check that the camera is pointing in the right direction.



- Click on the **Start Filming** button to take a snapshot of the scene. This will be the first frame of your animation clip.

- Move the characters or other objects in your scene a tiny bit. You can try using modeling clay to position your characters or objects. The clay makes it easier to move things a little bit at a time.



- Now click on the **Start Filming** button again to take another picture. Repeat until the characters or objects have completed their actions or movements.

Frames: 0031

- Check the **Frames Counter** to see how many frames you have recorded – you need 15 frames to make one second of animation.



- The last frame you recorded will appear in the small viewing screen above the **Trash Can**. If you don't like the last frame – maybe you moved something too much or not enough – you can get rid of it by clicking on the **Trash Can**.



- When you have finished recording a sequence of frames, click on **Finish**. All the frames will be put together as a clip of animation that will appear in the Clips Area.

Clips Area

If you want to watch the clip, go to the Edit Screen and play it back on the Viewer. Look on page 12 to find out how to get to the Edit Screen and how to use the Viewer. You can find out more about animation in the Director's Handbook on page 72.

Sound

Have you ever used a video camera? If you have, you will know that it records sounds as well as pictures. Your LEGO PC Movie Camera is just the same. This means that while you are filming live action clips, you will record all the background sounds. This can be useful if you want to make your characters speak as they act. You can add more sounds to your movie when you edit it – more about that later. If you don't want to use sound, turn the volume control all the way down as you film.

Just remember, it's harder to get rid of sounds than it is to add them. So make sure your set is quiet when you film, with only the sounds that you want to record being heard. Unwanted background sounds like whispering and sneezing could ruin the drama of your scene!

CUT! EDITING YOUR MOVIE

OK, you've got all the clips you need. Now you are ready to move on to the next stage of making a movie – editing. When you edit a movie, you put together all your clips in sequence so that they tell a story. You can also add a soundtrack, special sound and visual effects, and some text to give your movie a really professional look.



Let's get started with editing a movie. Click on the **Edit** button. This will take you to the **Edit Screen**.

THE EDIT SCREEN



On the Edit Screen you will find the following:

Tools

The Tools section has buttons running down both sides of it. Each button represents a different creativity tool. These tools allow you to choose and add creative things to your movie – clips, pictures, transitions, titles and credits, and sound. More about the individual tools in a moment.



Viewer Instead of showing what the camera sees, in the Edit Screen the Viewer now shows the clips.

Viewer Controls These buttons let you move through your clip or movie.



Timeline This is where you actually edit your movie. The Timeline is made up of four tracks. Each track on the Timeline is like a different strand or part of your movie. Once you put things onto the tracks, they will all work together to create a complete movie masterpiece. Read more about this on page 14.



- **Clips Track** This is where you put your clips and transitions. You can also add titles here if you want full screen titles rather than overlays.
- **Titles Track** This is where you add any text you need in your movie and images as overlays.
- **Sound Track** This is where you add sound effects and other additional sounds you record as indirect sound.
- **Music Track** This is where you add a music track from CDs or Smart Sounds®.

Scrubber

The **Scrubber** is the vertical line that you can move left and right along the Timeline. It helps you line up the different elements of your movie so that the sound and other effects match the filmed action exactly. The clip under the scrubber is the clip that is currently shown in the Viewer. More about the uses of the scrubber in the Editing section on page 20.



Editing Clips

Let's start by putting clips into your movie. Here's how to do it:



- Click on the **Clips** button on the left-hand side of the Tools Screen. This is also the default choice. The screen will change to show a selection of clips that you have filmed.



- Use the **Backward** and **Forward** buttons to flip through the pages of clips to find the one you want.

- If you want to use a clip from another movie you've made, follow the instructions in the **Help** file in the software.
- Once you've found the clip you want, highlight it by clicking on it.
- If you want to view the clip first, go to the Viewer Controls and click on the **Play** button. The highlighted clip will play in the Viewer.
- When you're certain that this is the clip you want, click and drag it to the **Timeline**. The cursor will change into a little hand. Now you can drag the clip down on to the **Clips Track** of the Timeline.



- You can put a clip wherever you want on the Timeline by simply dragging and dropping it onto the spot you want.
- Continue dragging clips onto the Clips Track until you have all the clips in place to tell your movie story.



Zoom In Click on this button to zoom in to the Timeline so that you can see more detail.



Zoom Out Click on this button to zoom out of the Timeline.

There is a **Scroll Bar** underneath the Timeline that lets you move quickly along the length of your movie.



The **Split Clip** button to the right of the Timeline lets you split a clip so that you can insert something else in the middle of it. Say you need an extra shot in the middle of a scene. Start by moving the **Scrubber** to the place on the clip where you want to insert the new shot. (You move the Scrubber by clicking and dragging on the blue brick that sits above it.) Then click on the **Split Clip** button to make a gap in the clip just where the Scrubber is. Now you can drag another clip into the gap. You can also insert a title or transition into the gap. You'll find out more about these on the next page.

You can check how your movie is shaping up whenever you want. Just click on **Play** underneath the Viewer. Your movie will start playing from the point where the Scrubber is.



To delete a clip from the **Timeline**, click on it to highlight it, then click on the **Trash Can**. The clip will still be in the Clips Area so you can use it later or for another movie.



You might discover as you edit that you haven't got enough clips to complete your movie. No problem. Just go back to the **Film Screen** by clicking on the **Film** button and film some more.

ADDING PICTURES

The Picture Tool lets you add pictures or graphic effects to your movie. Maybe you have a scene where the hero checks out a dinosaur in the distance through a pair of binoculars. Or, you want to create the effect of flames in a dramatic rescue scene. Well, with this tool, you can make the dinosaur look as if it is being seen through binoculars or you can add flickering flames around the edge of the screen.



Simply click on the **Pictures** button to see a number of different graphics. Then click on the picture you want, drag it on to the Titles Track of the Timeline, and drop it into place. It will appear directly over the clip, like a mask. You can stretch the picture on the length of the Titles Track to make the effect last as long as the action. If you want it to take up the whole screen instead of acting like a mask, drop it on to the Clips Track.



EDITING YOUR MOVIE

You might like to create your own picture to add to your movie, perhaps as a background for the titles and credits. This is how to do it: first, create the picture in a paint package on your PC. Then save your picture as a bitmap file, which has .bmp at the end of the file name. This is a type of picture that the MovieMaker Set software recognizes. Save it into the **Titles** folder that is in the **LEGO Studios** folder on your PC. Now, when you go back to the MovieMaker Set software, you will see your picture among the other images, ready to be used. To use it, simply drag it onto the **Clips Track**.

ADDING TRANSITIONS

OK. You've put your clips together and they tell a complete story. Now you should play back your movie and watch it carefully. Do you notice that sometimes the move from one clip to another is jerky? You can smooth this out with the help of transitions. The easiest way to understand transitions is to try one out for yourself. Here's how:



- Click on the **Transitions** button.



- A screen showing different transition choices will appear.
- Choose a transition type that looks interesting. You can preview it by double clicking on it.



Use the **Forward** and **Backward** buttons to flick through the pages of transitions you can choose from.

- To add a transition, click on it, drag it on to the **Clips Track**, and drop it into place. Transitions must be placed at the end of one clip and before another. If you want to put one in the middle of a clip you will have to use the **Split Clip** button described on page 15 to create a gap.
- Once you've added a transition, click on the **Play** button under the Viewer to see how it looks.



If you don't like the transition, just click on where it is on the **Timeline**. This will highlight it. Then click on the **Trash Can** to the right of the **Timeline** to get rid of it.

ADDING TITLES AND CREDITS

Titles are the words that appear at the beginning of a movie. They give the name of the movie, and usually the names of the director and stars. The credits come at the end of a movie – these are lists of all the people who helped make the movie.

You can find out more about titles and credits – who you should thank and what other sort of information is usually included in them – in the Director's Handbook section on page 91. Once you've decided what you want to write, here's what you do:



- Start by putting the **Scrubber** on the spot where you want the title or credits of your movie to appear. Then click on the **Titles** button.



- The **Titles** screen will appear. On this screen you can type whatever you want to appear on your screen. You can change the size of your text by clicking on the text size arrows next to the number. Remember, the higher the number, the larger the letters.



- Click on **Different Looks** to choose from a range of styles for your text. You will see a new window with many options, such as fuzzy or blocky borders, different colors, and so on.



- Click on the **Justify** button to position your text on the screen. You can make the text appear in the center or at the top, bottom, left or right of the screen. It can even go in the corners of the screen. The choice is yours!



- Once you've typed a title, you can add a background to it if you want. Click on the **Background** button to see the backgrounds you can choose from.

1. Background is transparent

This is good if you want your words to appear on top of your movie clips. If you select this option, your title will be added to the **Titles Track** of the Timeline. If you place it before a clip, the title will appear on its own with a black background.

2. Background is a solid color

This option lets you choose any color background you like from a selection of thousands.

3. Background is a gradient

This option lets you choose colors for each corner of the background. You can choose up to four colors which will blend into one another.

4. Background is a picture file

If you have any .jpg or .bmp picture files, you'll be able to use these as a background for your titles. Just tell the program where to find the image on your hard drive.



- If you don't like something you've typed, you can get rid of it by clicking on the **Cancel** button, or just highlight the parts you don't want and click on the delete key on your keyboard.

- There are two places to put a picture or an image. The first is the **Titles Track**, where the picture will appear over the top of the film clip. You can also place a picture on the **Clips Track**. This will be played as a clip on its own.



- When your text is ready, place the **Scrubber** where you want to add your titles and click on **OK**. Click on **Play** under the Viewer to check how your titles or credits look with the rest of your movie.



- If you don't like the way your text looks, highlight it on the **Timeline** by clicking on it, then click on the **Trash Can** to delete it.

You can make your text last for a longer or shorter time in your movie. To do this, place your cursor over the edge of the text clip. The cursor will change to a small arrow. Now you can drag it left or right along the Timeline to make the text clip longer or shorter.

ADDING SOUND

All four buttons on the right side of the Tools section are to do with adding sounds. Of course, your movie will just have the sound that you recorded while filming the clips. Now I'll show how to add lots of other exciting, realistic, funny or dramatic sounds and music.



Sound Effects

It's very simple to add sound effects – like a dog barking, the crash of a collapsing building, or the sound of breaking glass.



- Click on the **Sound Effects** button. This will bring up a screen with lots of great pre-recorded sound effects to choose from.



- Click on the arrow next to the pull-down sound menu at the top to see other categories of sounds.



- Select the category you want, and a list of sound effects will appear. Click on the **Forward** and **Backward** buttons to scroll through more sound effects. Click on any sound to hear it play.

- To add it to your movie, click and drag it on to the Timeline. Then click on **Play** under the Viewer so you can make sure that you have put the sound in the right place.

When adding sound, you need to make sure that the sound and pictures match exactly. Use the **Scrubber** to line up your sound effect directly under the part of your clip where you want it to play. To find the right spot, play your movie in the Viewer. Stop when you reach the place where you want the sound, then drag your sound effect down to where the Scrubber is sitting on the **Sound Track** of the Timeline.

Microphone

Not only can you choose from the many fantastic sounds provided, but you can also record your own sound effects using the microphone in your LEGO PC Movie Camera. Here's how you do it:



- Click on the **Microphone** button.



- The **Record Screen** will appear. You can now use your LEGO PC Movie Camera as a microphone.

EDITING YOUR MOVIE



- Now place the Scrubber on the **Timeline** – just where you want to add the recorded sound.
- You can adjust the volume by moving the **Volume Slider** up or down. The colored bar helps you select the correct volume. Green means that the volume is good, yellow is loud but OK, and red is too loud!



- Once you are ready to record, click on the **Record** button. There will be a timer countdown before recording begins. The word **REC** will appear when you're recording.

- When you start recording, you will see the Scrubber moving. The sound you record will appear on the Sound Track of the Timeline.



- Click on the **Stop** button to stop recording.

CD

Most movies have background music to create the right mood. Follow these simple steps to add music to your movie:



- Click on the **CD** button. A screen showing the track number and recording button will appear.



- Insert the CD you've chosen into the CD drive of your computer. (Remember, you won't be able to look at the Tutorial or the Tips while the MovieMaker Set CD-ROM is out of the computer.)

- Choose the track number that you want to record by using the arrow. The song will automatically start playing.



- Click on **Record** just before the music or sounds that you want to record actually start playing.



- Click on the **Stop** button when you've recorded as much music as you need. The CD music you've recorded will go straight to the point on the Music Track of the Timeline where the Scrubber is sitting. If you need to move the sound, just click and drag it to the correct place on the Timeline.

Note: Music from CDs doesn't belong to us. We can use it to entertain ourselves, but we can't broadcast it or use it to make money. If you are making a movie to post on the LEGO website, create your own music instead of using music from a CD.

Smart Sounds®

The MovieMaker Set software includes a library of different pieces of music for you to use, called **Smart Sounds**. You can even change the way that each piece sounds so that it fits in with your movie. Here's how:



- Click on the **Smart Sounds** button and the screen will appear.
- Highlight the area on the **Timeline** where you want to add the music.
- Choose a song, then decide what style you want it to be played in – pop or classical, for example. You can also choose a version of the song.



- Click on the **Preview** button to listen to the music you've chosen. If you want to use it, click on the **OK** button.
- Now comes the really "smart" part of Smart Sounds: you can make the song you've chosen stretch to fit any piece of film. Click on your Smart Sound on the Music Track of the Timeline, then drag it along the track. The sound will stretch as you drag it. You can keep dragging until it fits the section of film you want; you can also shorten it by dragging it the other way. When you play back this part in the Viewer, it will sound like the song was composed especially to fit that piece of film.

Volume Control

You can adjust the volume on Smart Sounds, sound effects, and even the sounds on the clips themselves. Just click on the specific sound line to select it and move the red line up or down (as shown on the Music Track below). Remember, it might be difficult to hear dialogue if there are other sounds playing at the same time. If this happens make the background sounds softer.



Direct Sound

Sound Track

Music Track

SHOWTIME!

WATCHING YOUR MOVIE

You've filmed your clips and put them together in a sequence, and you've added a soundtrack, special effects, transitions, titles and credits. Now it's time for the first screening of the completed movie.

THE SHOW SCREEN



Click on the **Show** button. This will take you to the **Show Screen**. On this screen you'll see the following:



Viewer Controls

The controls at the bottom work in the same way as before.



File Size This lets you know how large your movie will be when you make it into a file that you can e-mail.

Film Archive This is where you'll find all the movies you have made so far. You'll see a frame from each one so you can find the one you want to show.



Forward and Backward These buttons let you scroll through the movies in the Film Archive until the one you want to watch is visible under the Show Movie button.



Playing a Movie

Now you're all set. Select **Show Movie** (the movie projector button) when you are ready to see the movie. You should probably watch the movie on your own first, to check it through. Then you could organize a grand premiere.



LEGO Studios Link If you want to find out more about LEGO Studios, click this button. An Internet browser window will open and you'll be taken to the LEGO Studios website if you are connected to the Internet. Please make sure you have permission to access the Internet before clicking this button.



E-mailing a Movie If you want to e-mail your movies you need to turn them into special files. To do this simply click on the **Make Movie** button. Wait a few moments and you'll find the movie, ready to attach to an e-mail, in your Steven Spielberg MovieMaker Set folder. Avoid sending large files via e-mail. If your movie is long, use another program to compress your movie down before you send it. Ask for permission before you send any files larger than 4 MB with an e-mail!



There is a **Quit** button on the top of each of the three main screens. This button closes the window and takes you back to the first screen.



Click on **Exit** if you want to leave the Steven Spielberg MovieMaker Set software. You will be asked if you are sure you want to leave the program. If you click on the **OK** button you will exit the program. Clicking on the **Cancel** button will close the small window and take you back to the Steven Spielberg MovieMaker Set software.



MENU OPTIONS

You may have noticed the four Menu Options above the Viewer. Let's look at each one in detail.

FILE

Under **File**, you will find the following options:

New Project Click on this to create a new movie project to work on. Choose this option when you haven't finished editing a movie, but want to leave it for a while and start work on a new movie.

Open Use this to open up a movie that you've already created.

Delete Project When you choose this option, a list of all the movies you have made so far will appear. You can select one and delete it. You might want to do this if you need more room on your disk.

Files Click on this to see a list of the nine most recent movies you have made. You can open one of these by selecting it here.

Exit This will take you out of the Steven Spielberg MovieMaker Set software.

EDIT

Under **Edit**, you will find the following options:

Undo This will undo the last thing you did on your movie.

Redo/Can't Redo If you undo something that you really want to keep, you can select Redo. If something can't be redone, Can't Redo will show.

Select All This option lets you select all the items on the highlighted screen.

Delete Choosing this option will get rid of anything that you have highlighted.

Cut Highlight something that you want to remove, then select this option. It will be removed from the screen.

Copy Highlight something that you want to repeat elsewhere, then select Copy. The item will be copied.

Paste Select this option to put an item that you have cut or copied into a new place. Move the Scrubber to the place you want to add the item and click on Paste.

VIEW

Under **View**, you will find the following options:

Film This option will take you to the Film Screen. It is the same as clicking on the Film button.

Edit This option will take you to the Edit Screen. It is the same as clicking on the Edit button.

Show This option will take you to the Show Screen. It is the same as clicking on the Show button.

HELP

Under **Help**, you will find the following options:

Help Select this option to see what all the different buttons and controls do. Click on the one that you want help with and an explanation of how it works will appear.

Tutorial Choose this if you want me to guide you through a particular aspect of the MovieMaker Set software.

Tips Check this out to find my hottest tips for moviemaking success.

About the Steven Spielberg MovieMaker Set software Select this to find out more about the MovieMaker Set software program.

Epilepsy Warning

Please read this before using any software program or allowing your children to use it. Some people are liable to have an epileptic seizure or loss of consciousness when exposed to flashing lights or certain normal conditions of everyday life. Such persons could risk a seizure while watching televised images or while using certain software programs, and this can occur even if there have been no previous medical problems or experiences of epilepsy.

If you or a member of your family have ever shown any epileptic symptoms (seizure or loss of consciousness) when exposed to flickering lights, consult your doctor before using this software.

Parents should supervise their children's use of computer software. If you or your children experience any of the following symptoms – dizziness, altered vision, eye or muscle twitches, loss of consciousness, disorientation, involuntary movements or convulsions – discontinue use immediately and consult your doctor.

PLEASE TAKE THE FOLLOWING GENERAL PRECAUTIONS WHEN USING SOFTWARE:

Do not sit too close to the television screen; position yourself with the linking cable at full stretch. It is preferable to run the software on a small screen. Do not use when you are tired or have not had much sleep. Make sure that the room in which you are using the software is well lit. Rest for 10–15 minutes per hour while using the software program.



BUILDING INSTRUCTIONS

Your MovieMaker Set comes complete with camera, software and a very special assortment of LEGO bricks and special effect props! You can use the bricks to build into your very own LEGO movie studio! This section of the book shows you how to build the set and special props. It comes with everything you need to make your very own LEGO dinosaur movie! So, what are you waiting for? Start building!



The special elements to build and assemble include:

A movie studio The perfect place to make your own LEGO Movie. Animation or live action? The choice is yours. You can build your set and locations with the LEGO bricks in this set and any others you might have at home. And that's not all: your MovieMaker set comes complete with a cast of characters and crew, so you have a host of Mini figures who can star in your movie!

A collapsible building Crash this easy-to-assemble LEGO building and film the action. If you can't get it all in one take, don't worry, this set rebuilds in seconds!

Earthquake plates These road plates split apart to reveal the hot magma below. Speed your red stunt car through the cracks.

Mobile fan Used to generate wind effects in real movies, this fan keeps the LEGO cast and crew "cool" during the action scenes.

Dinosaur foot Film the giant dinosaur's foot as it stomps on the street.

Camera track You can build your own camera track. Just like in the movies, this track allows you to steady your camera, or pan left, right, up or down to create any perspective you want.

Guide stalks Look, no hands! With these guide stalks, you can move your characters and cars without showing your hands on camera. Create the illusion that things are moving all by themselves!

Mini buildings You can use these mini buildings to make the T-Rex or other objects look larger than they actually are.

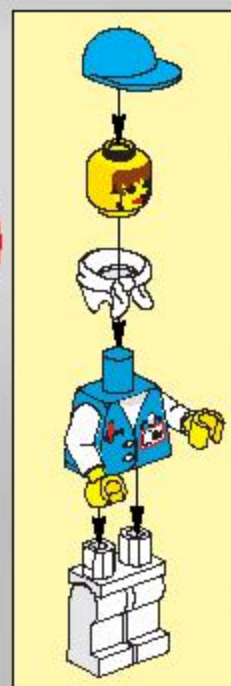
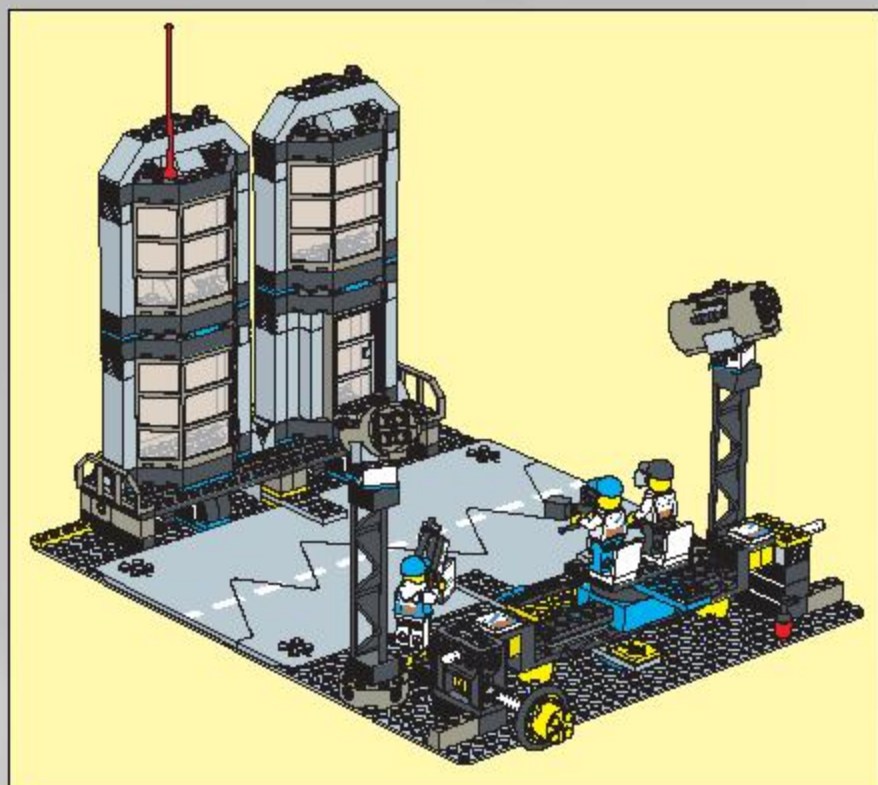

28

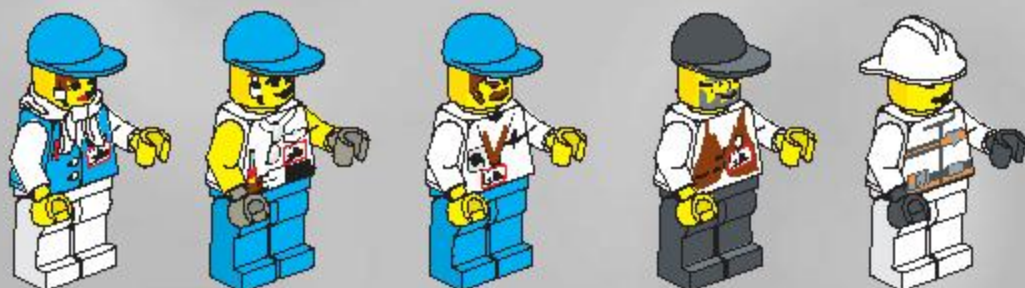

LEGO

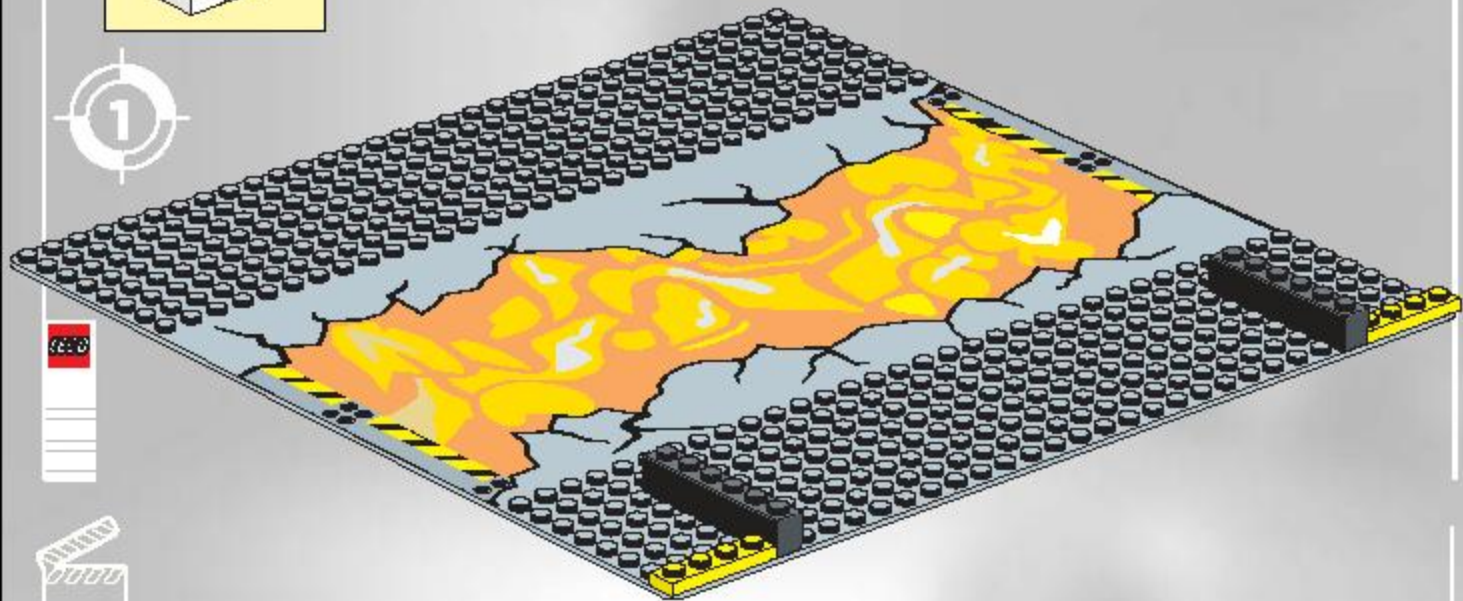



2

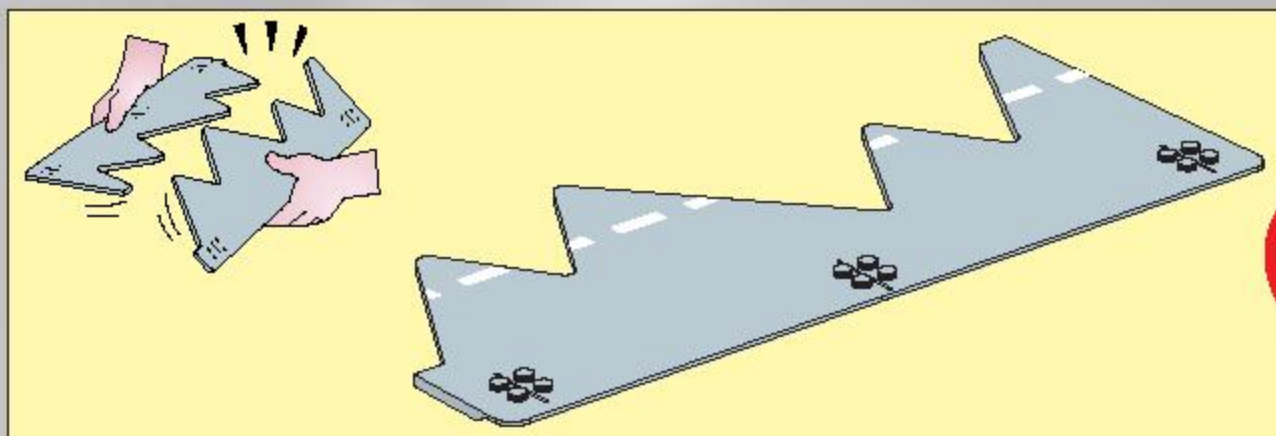
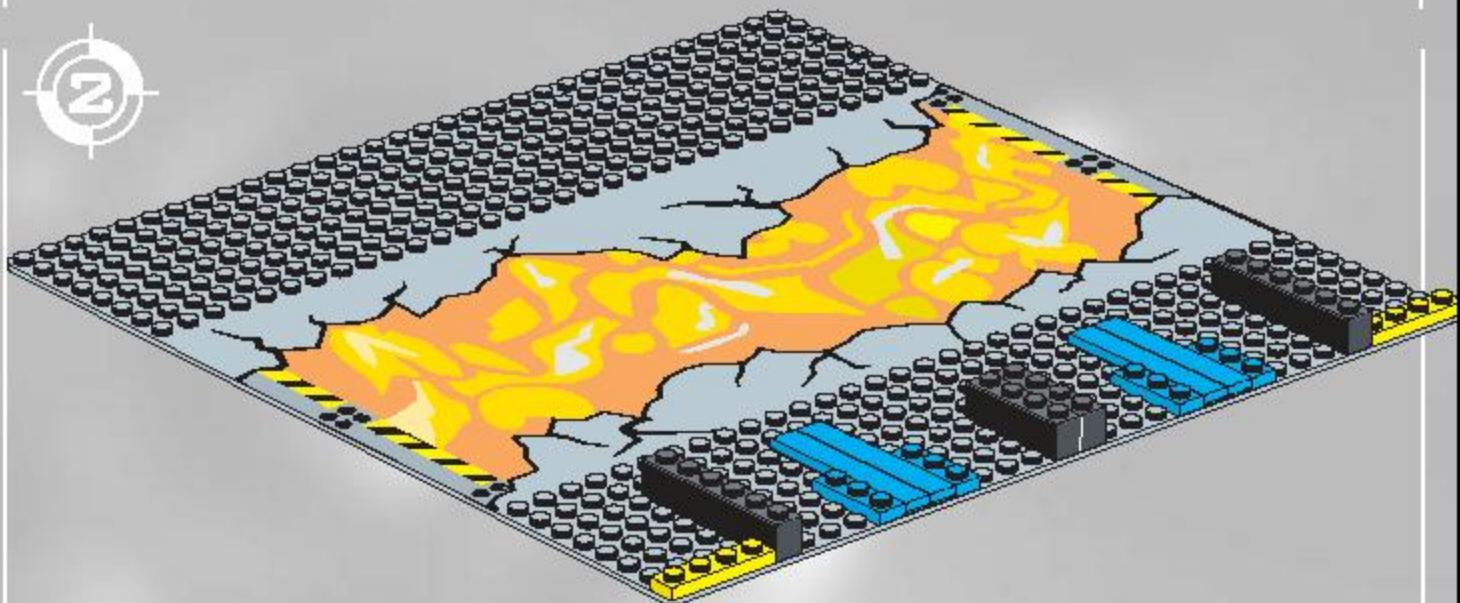

29

3

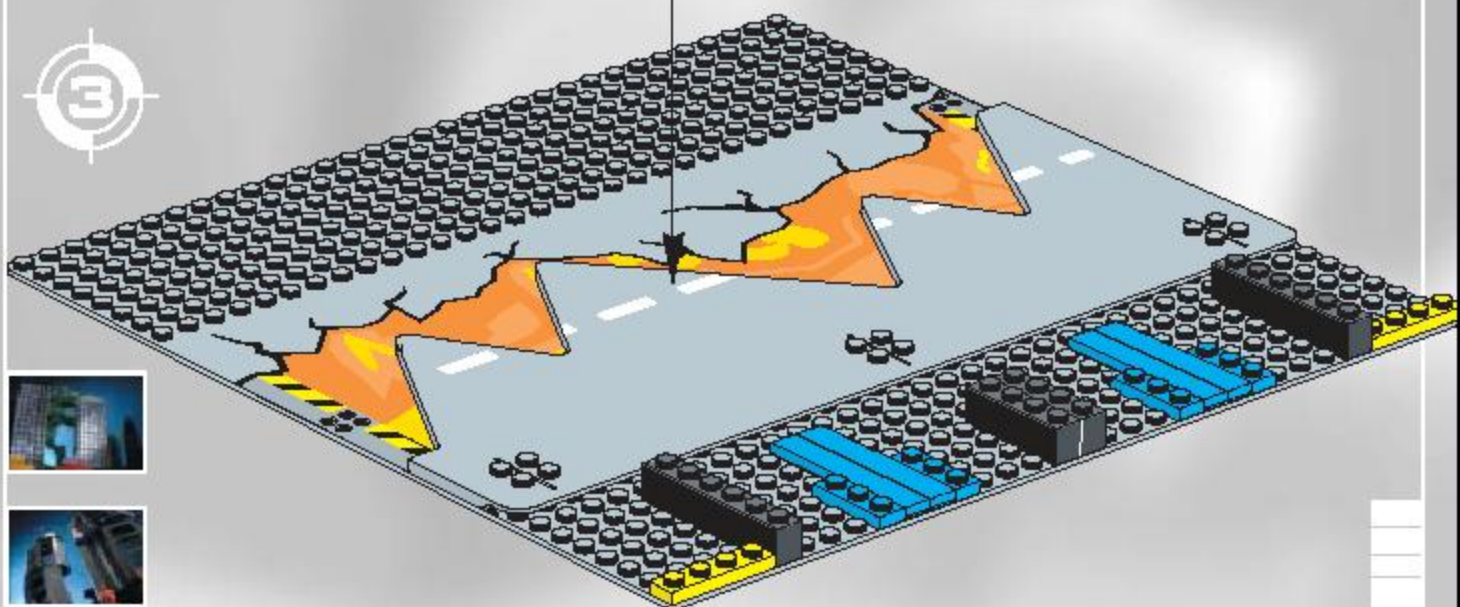

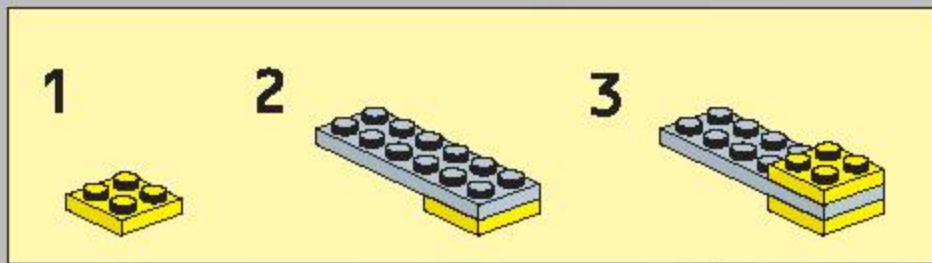

4

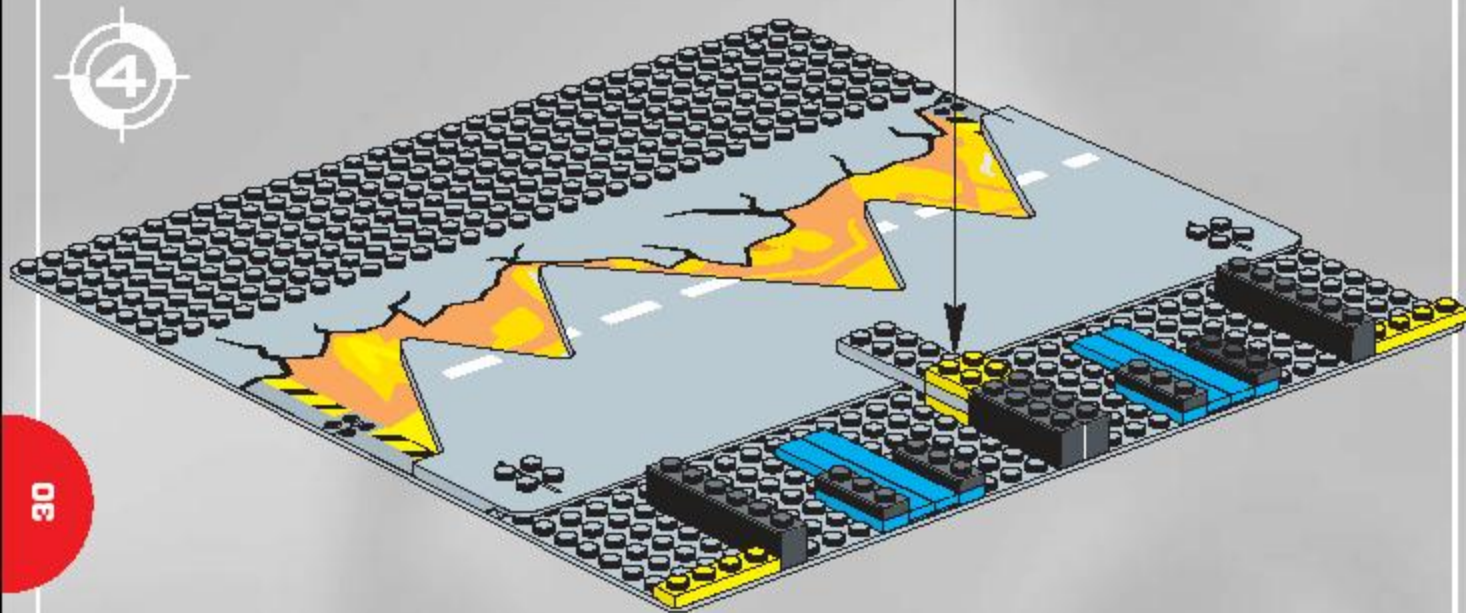

30

5

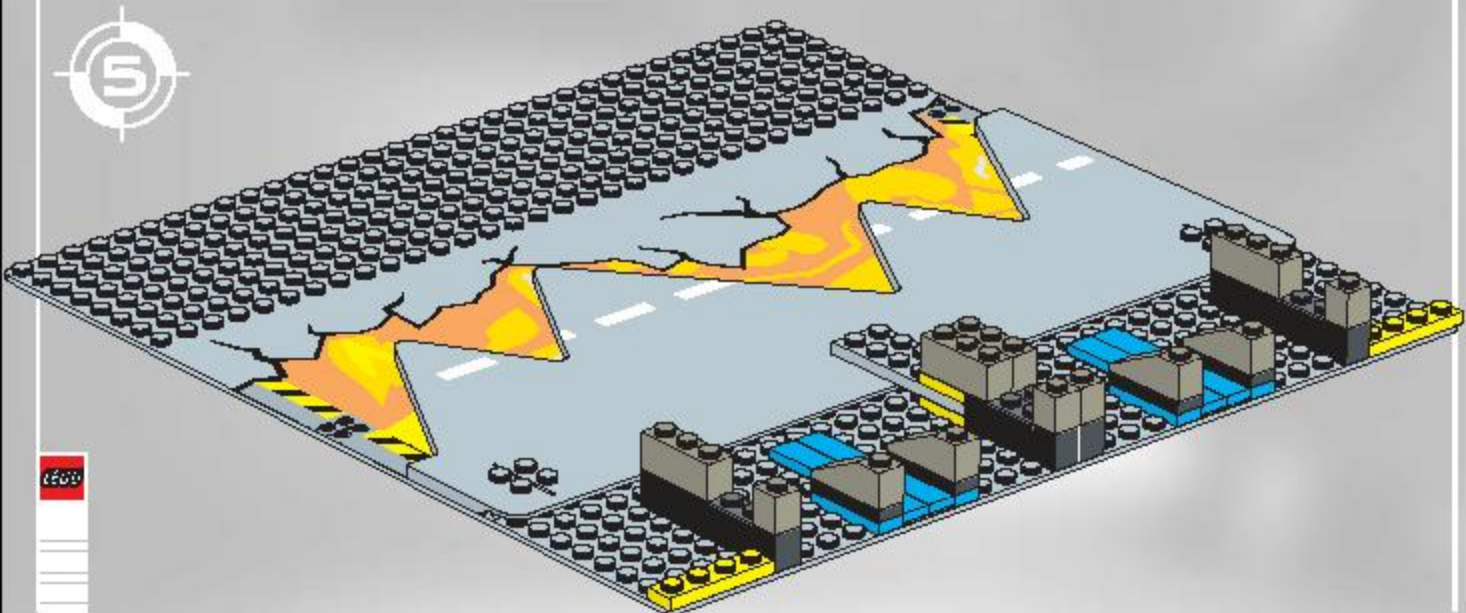

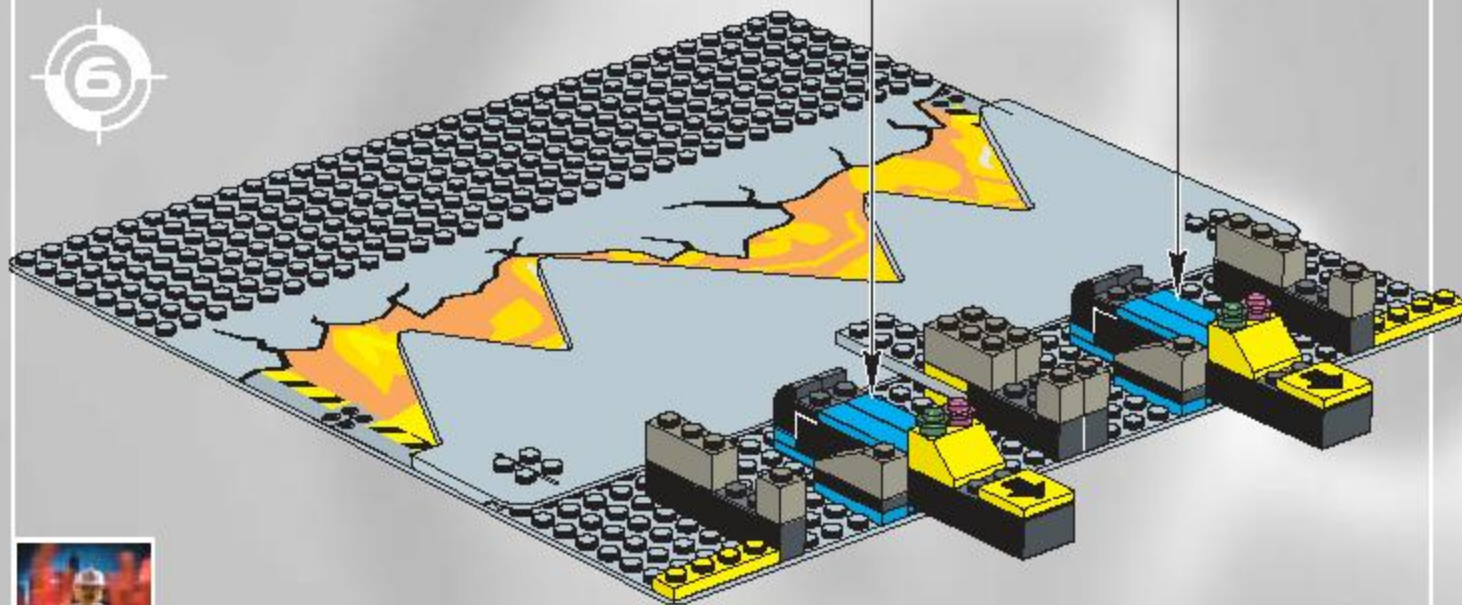
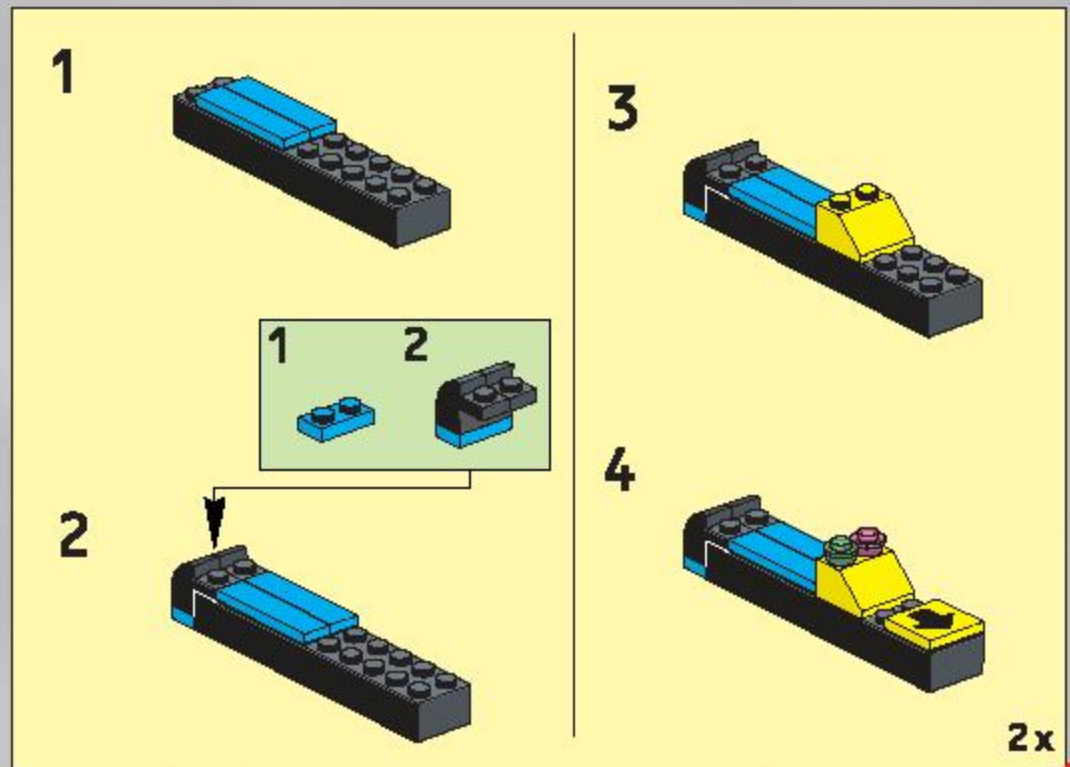



32

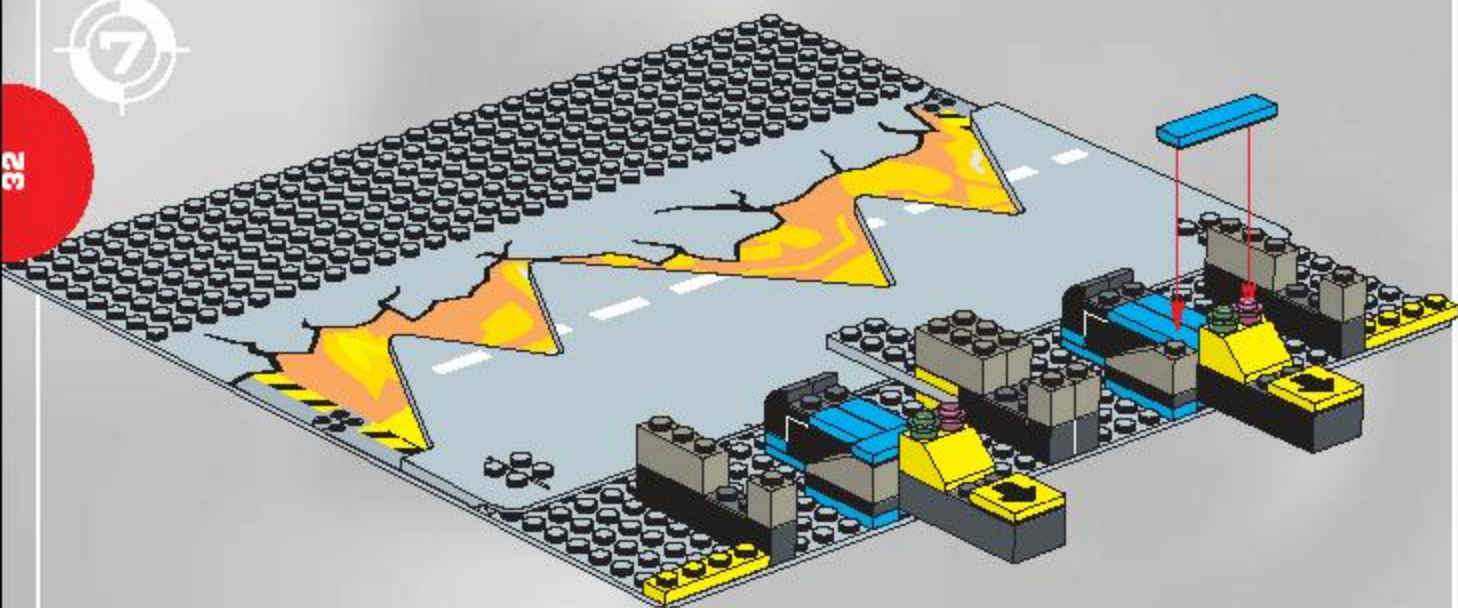

LEGO



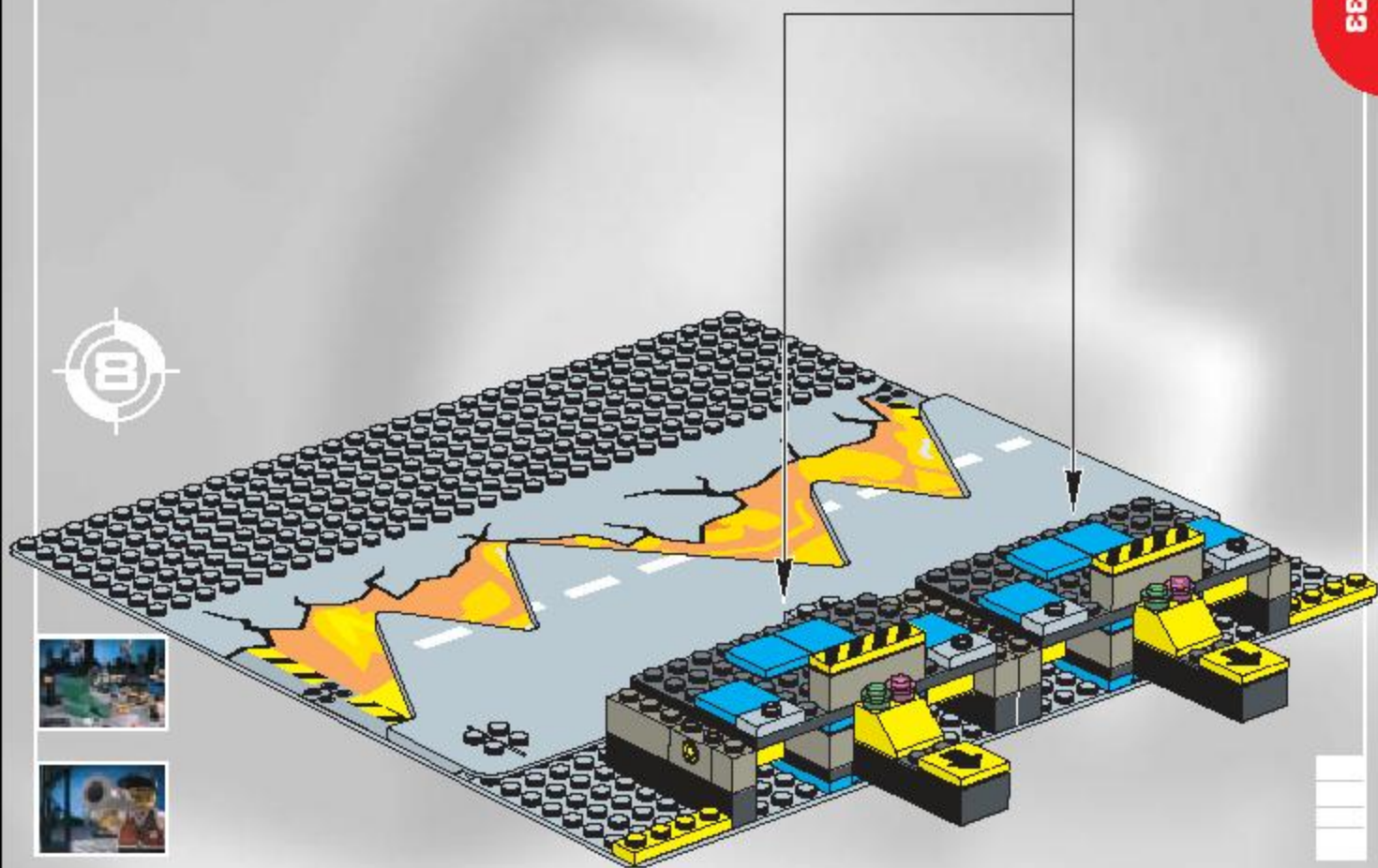
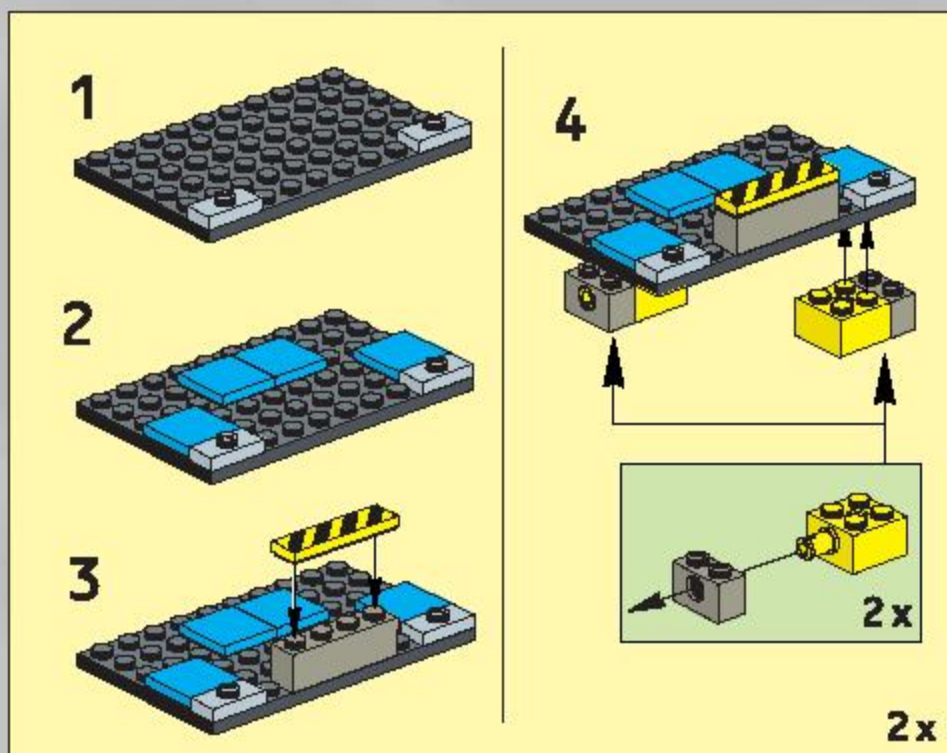

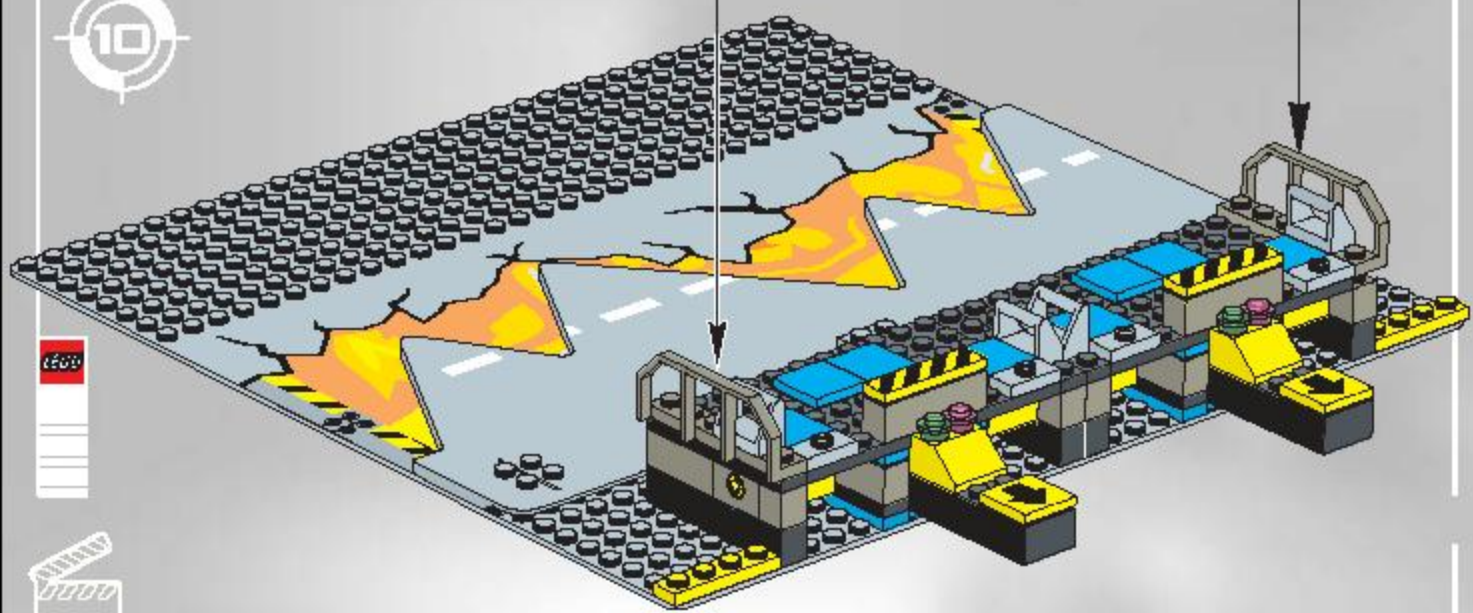
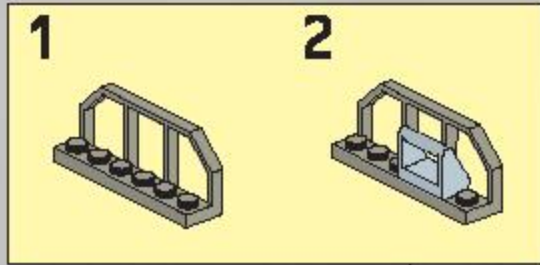
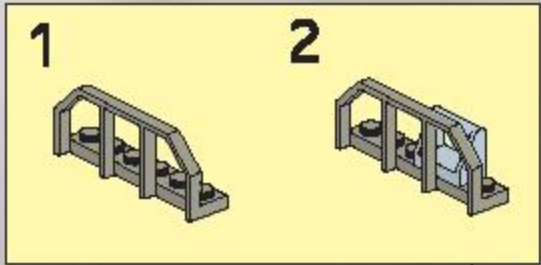
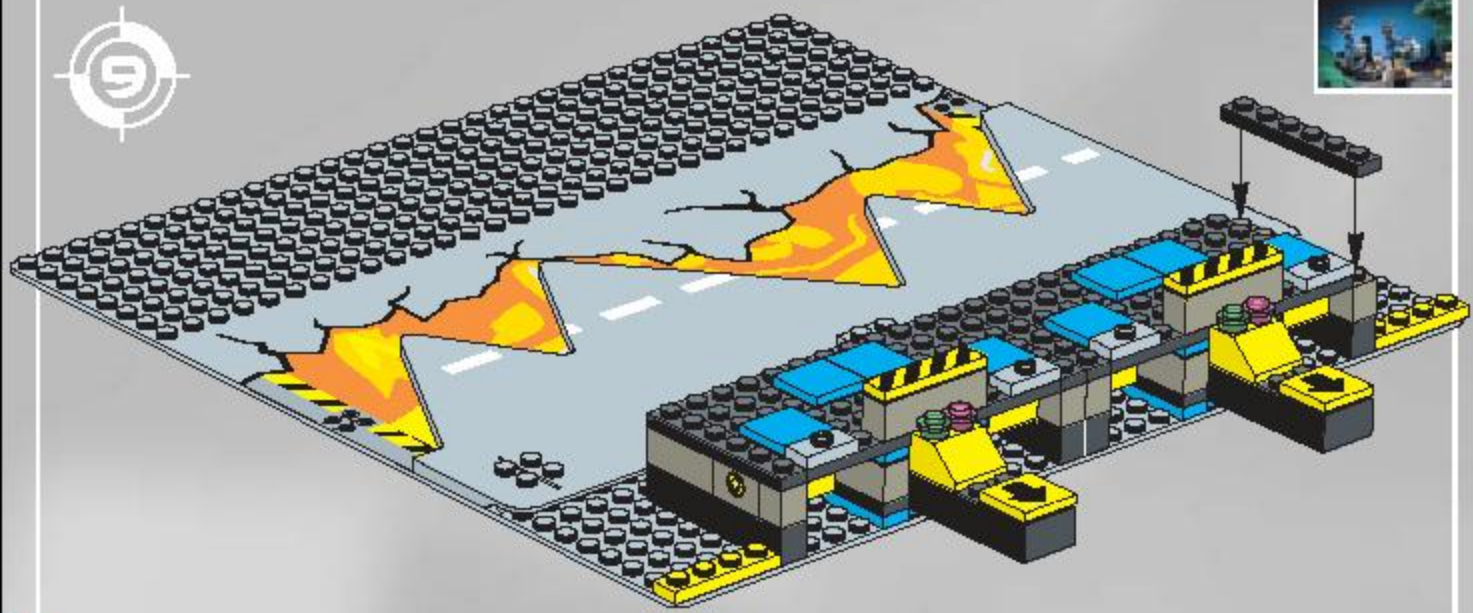



11



12

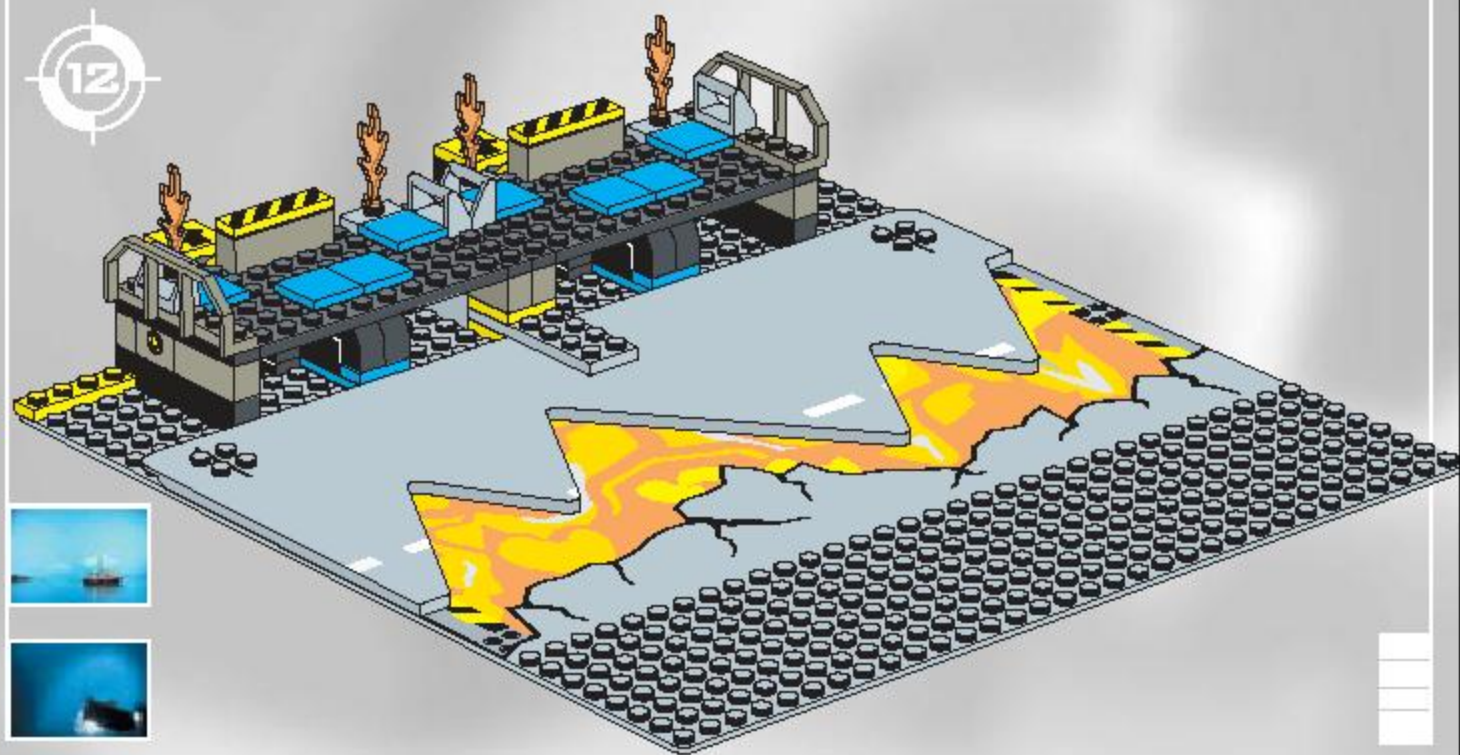



13

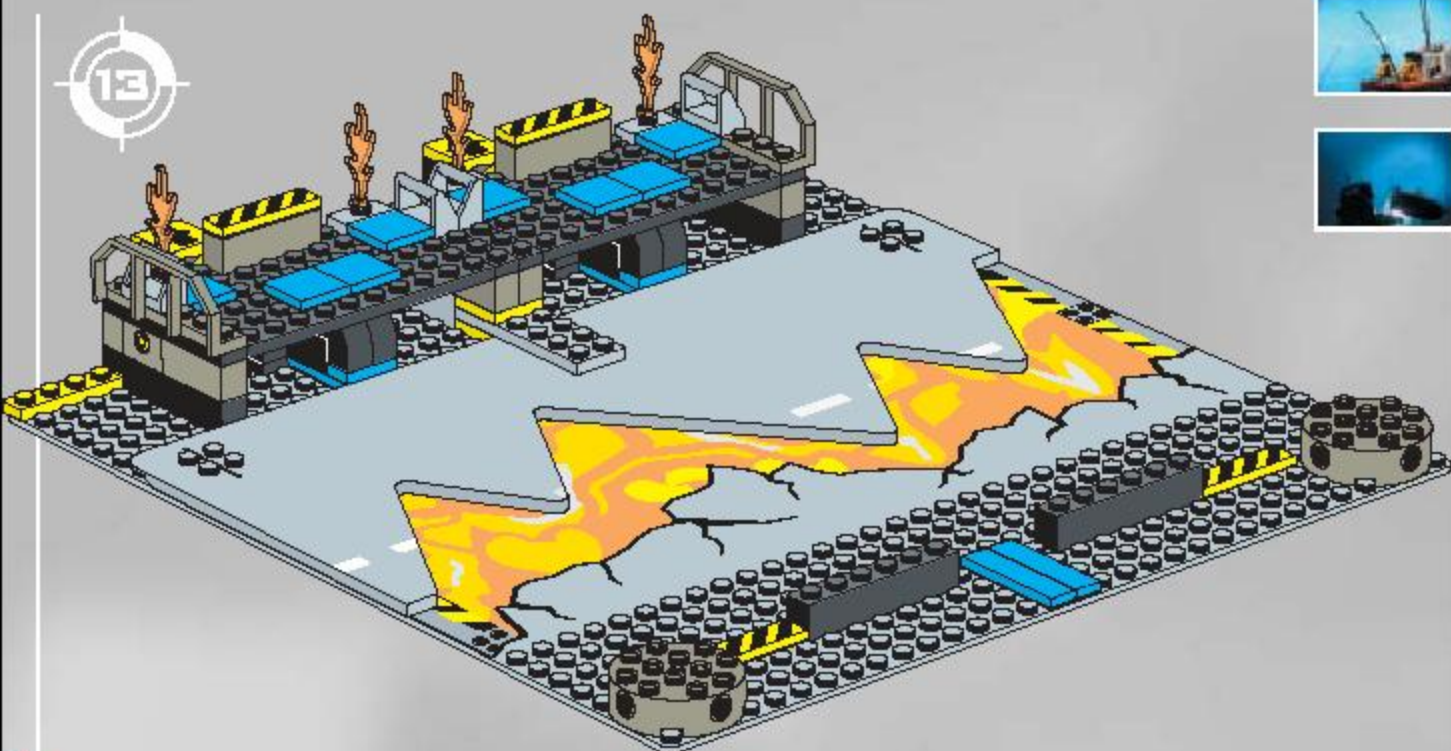

36

14

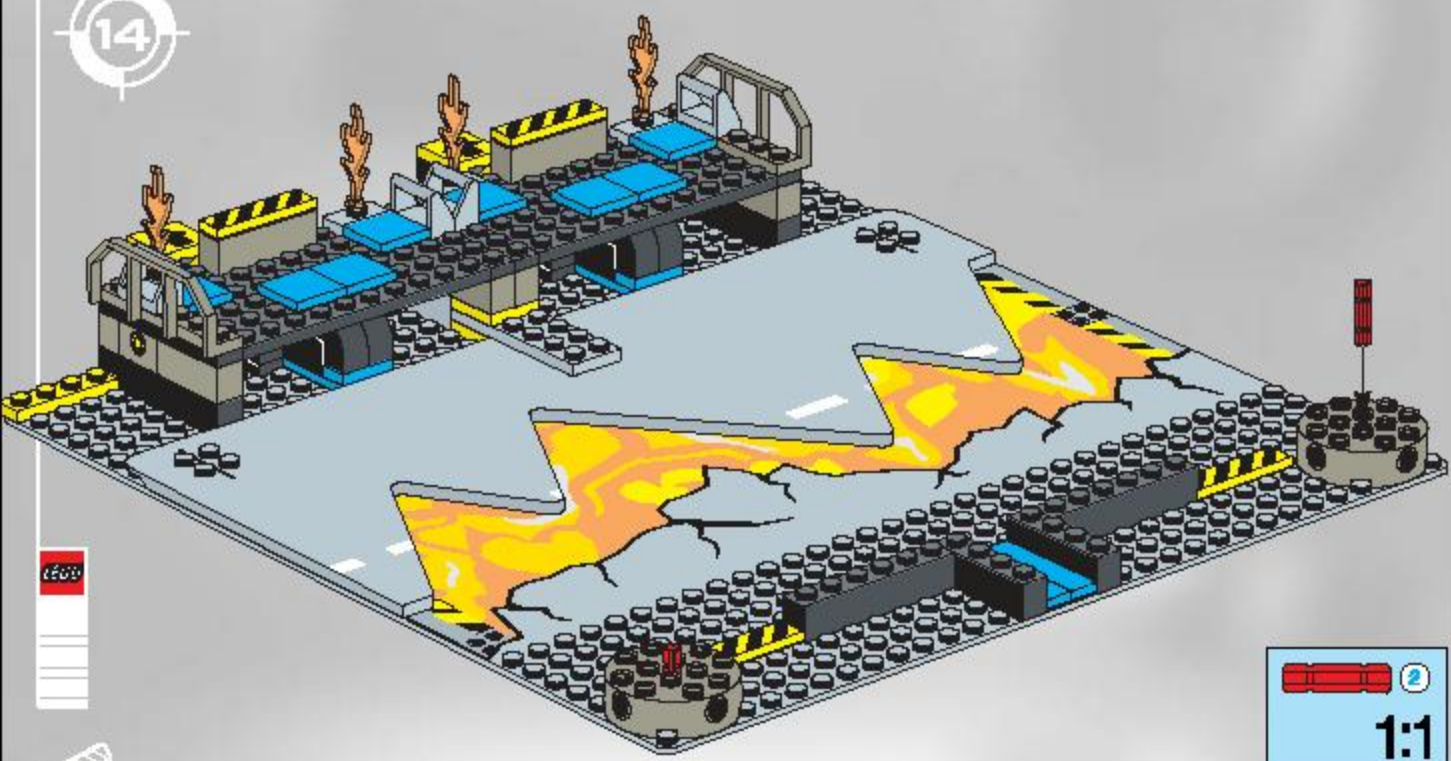
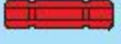



1:1

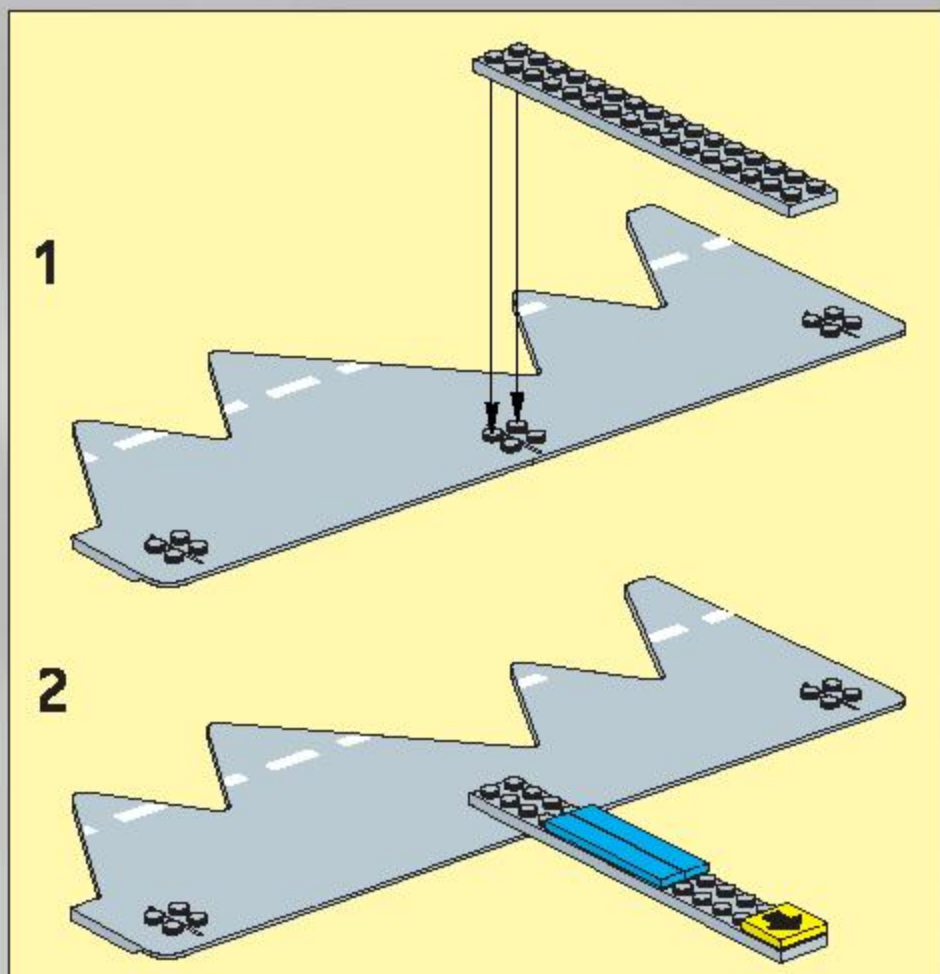



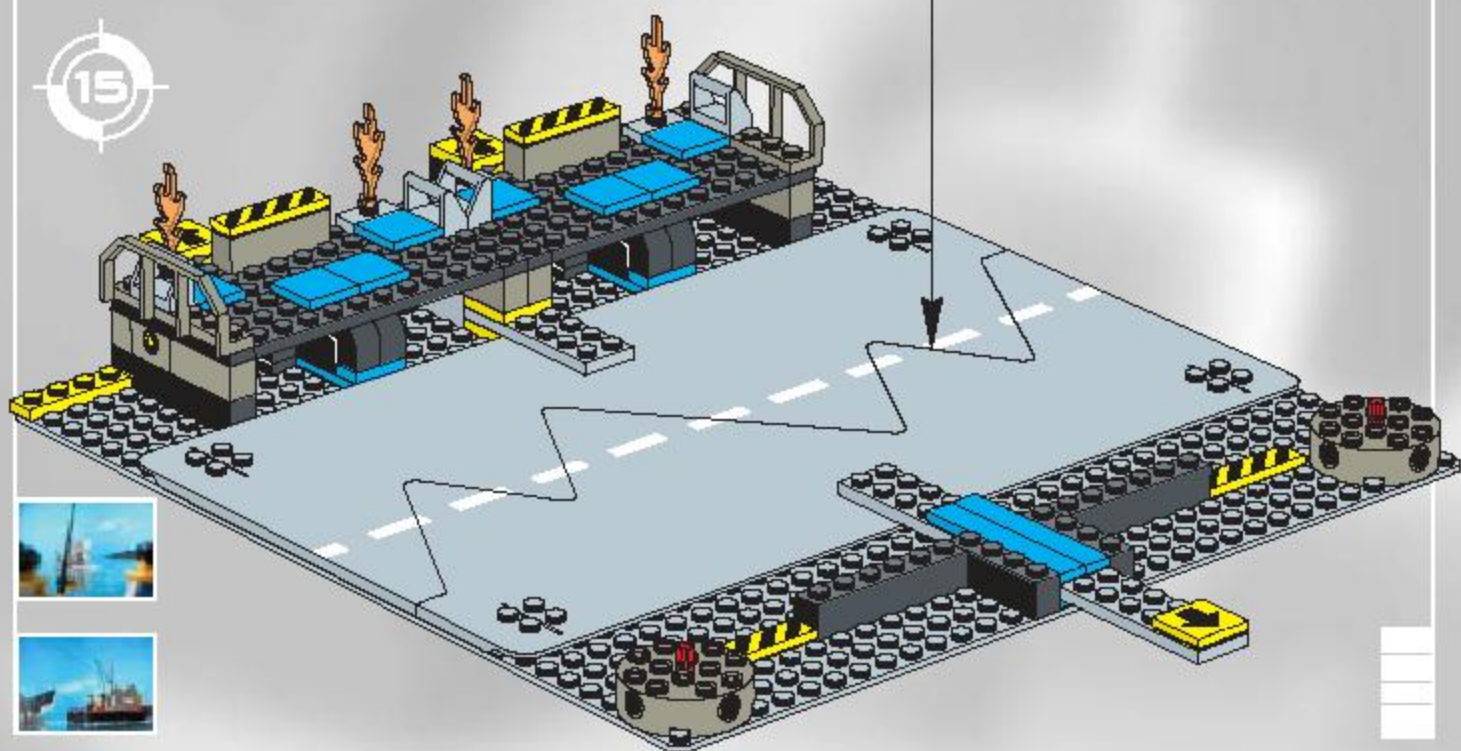

15





- 1 
- 2 

16

38

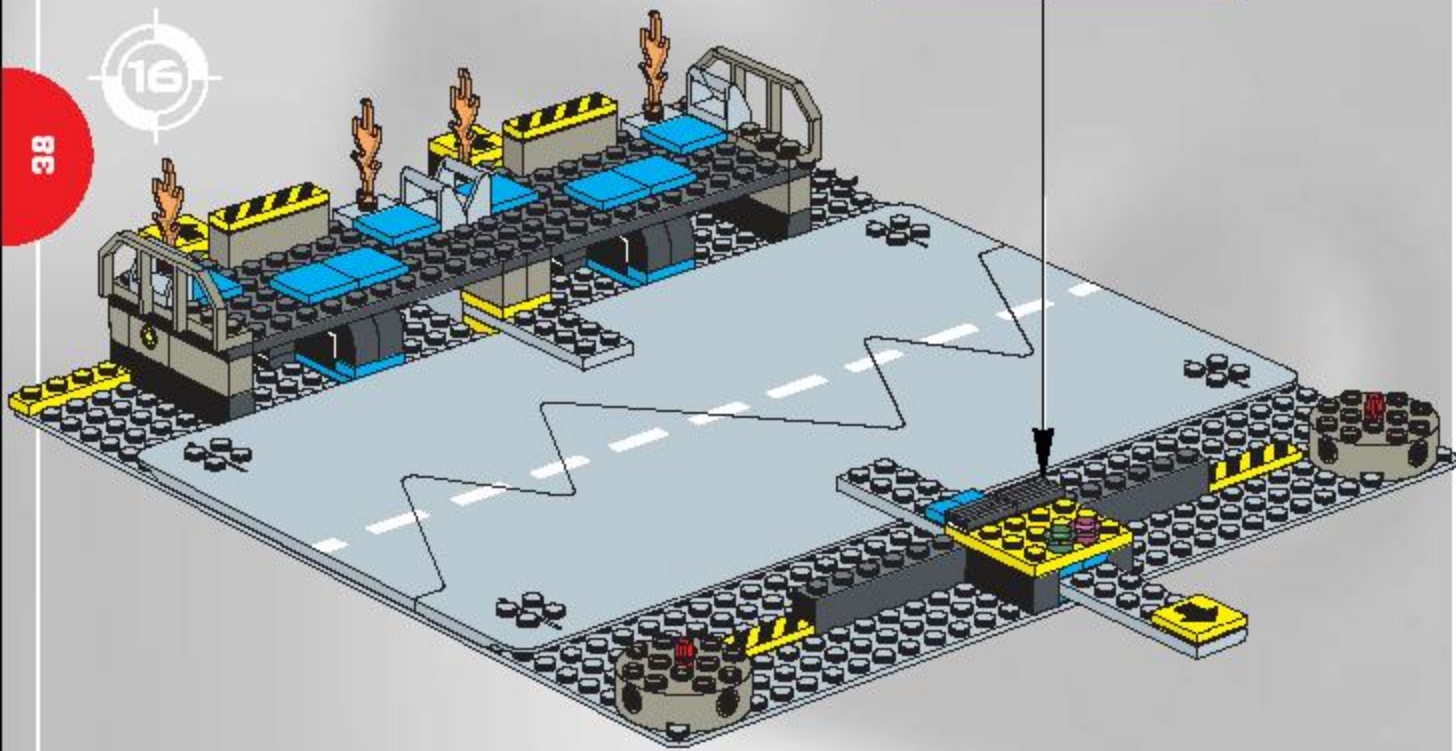



1

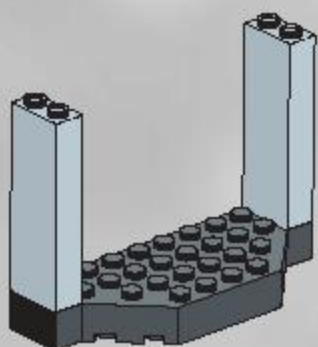

2

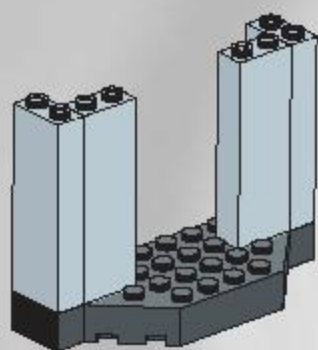

3

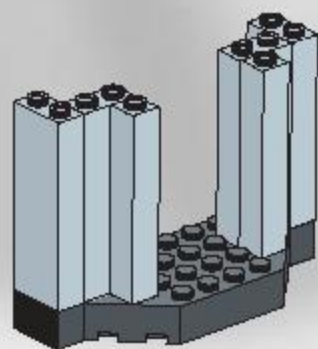

4

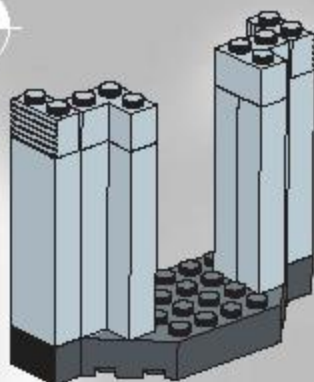

5

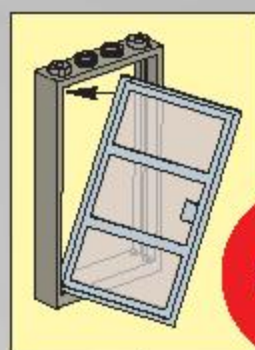
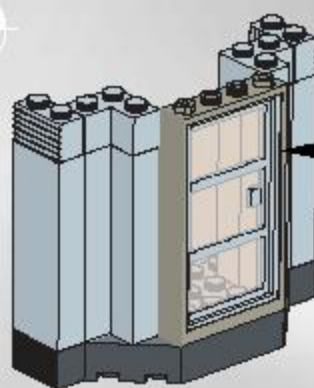

39

6

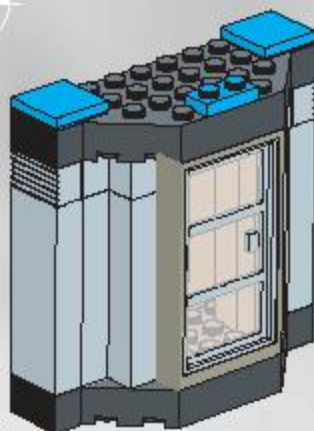



1

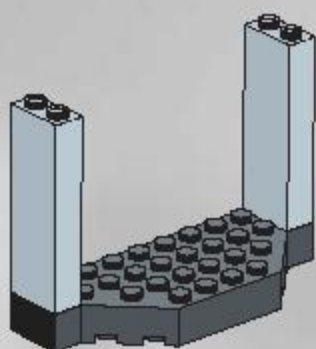

2

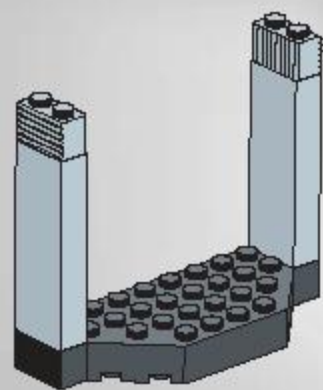

3

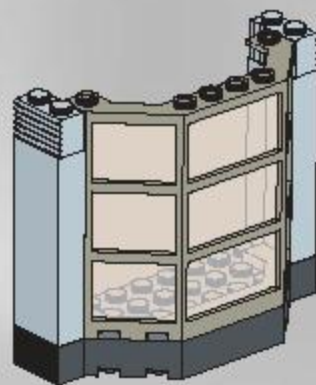

4





17

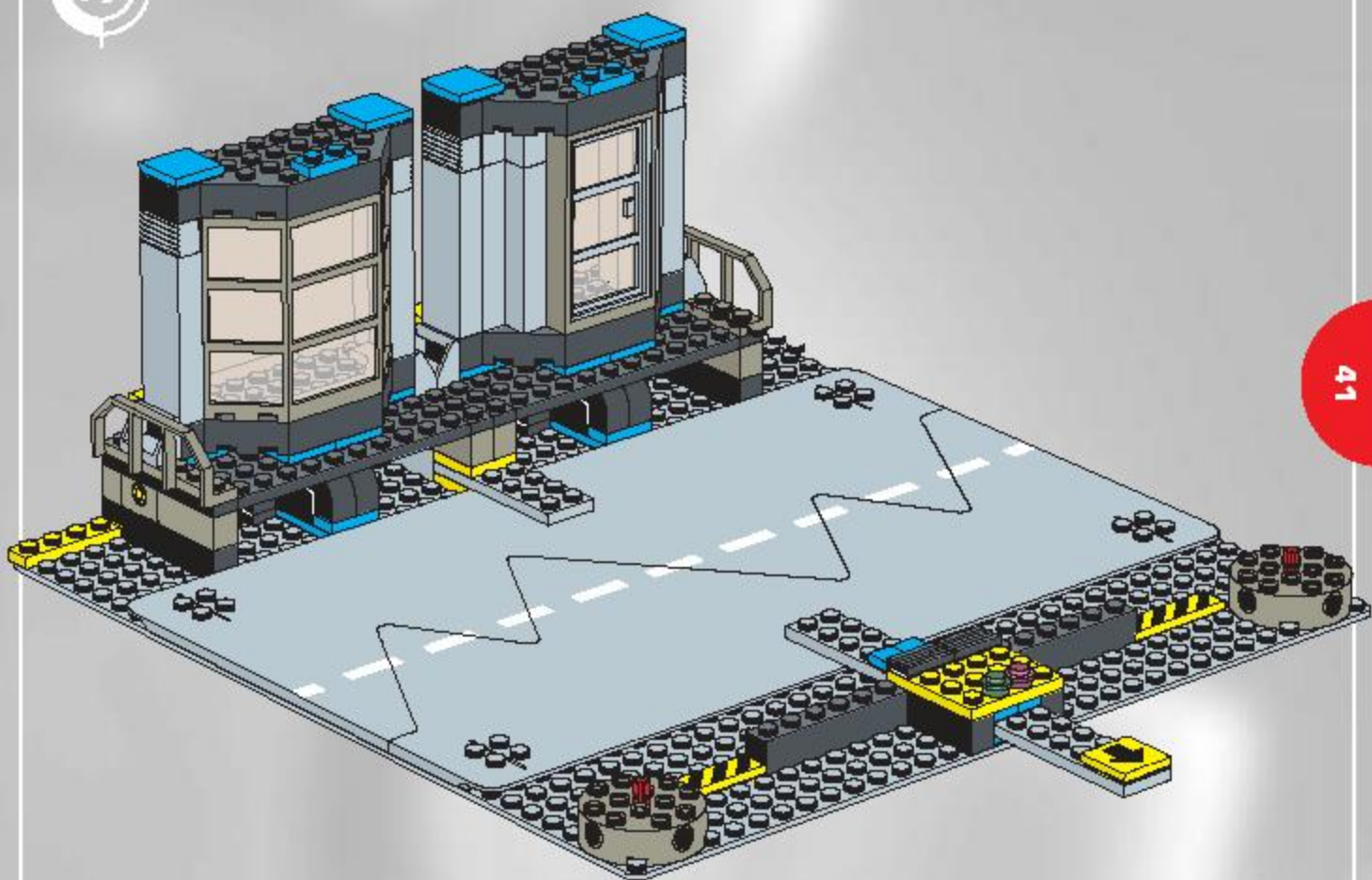

41



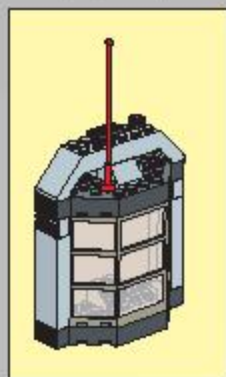

1

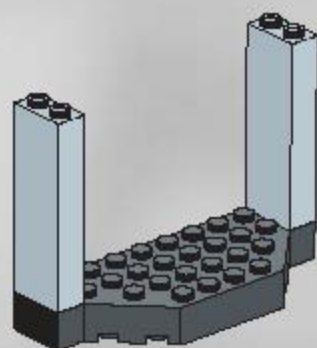

2

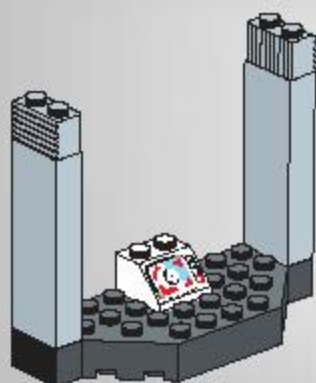

3

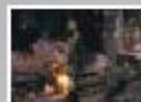
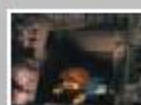
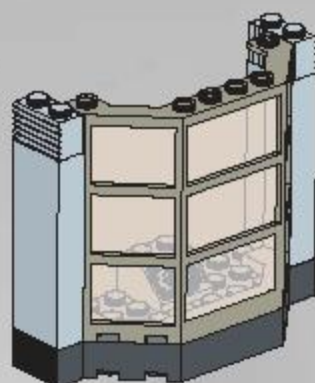

4

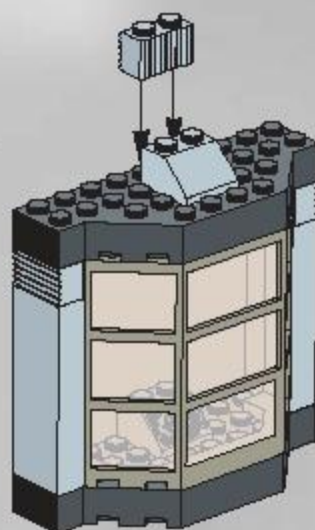

5

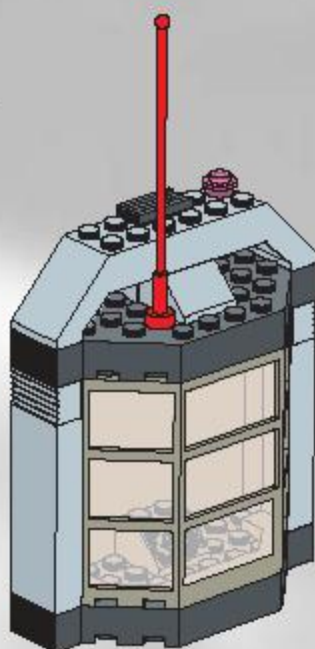



1

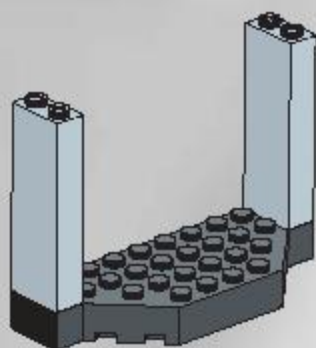

2

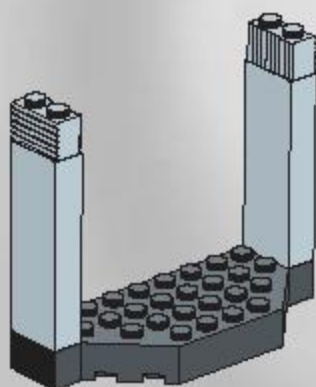

3

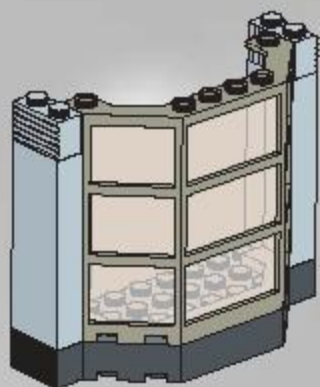

4

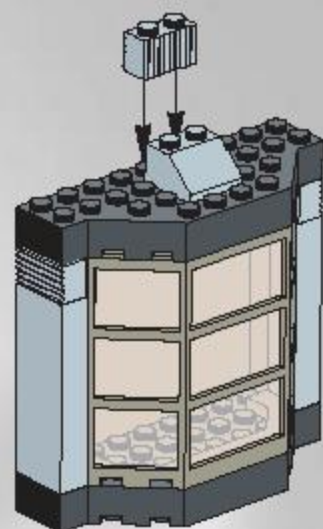

5





18

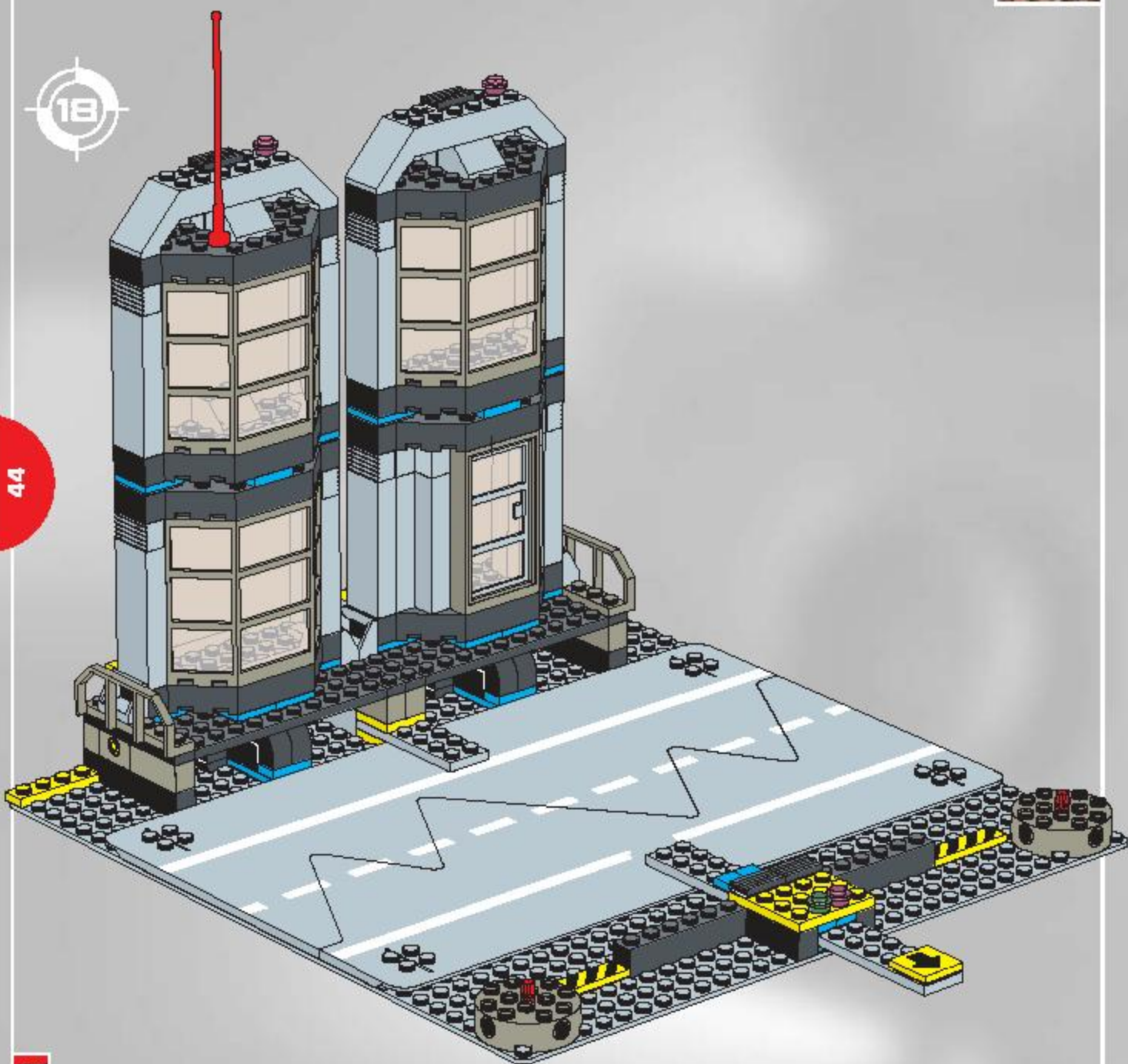

1

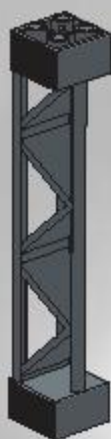

2

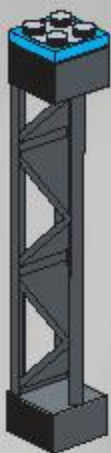

3

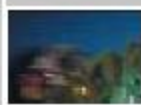
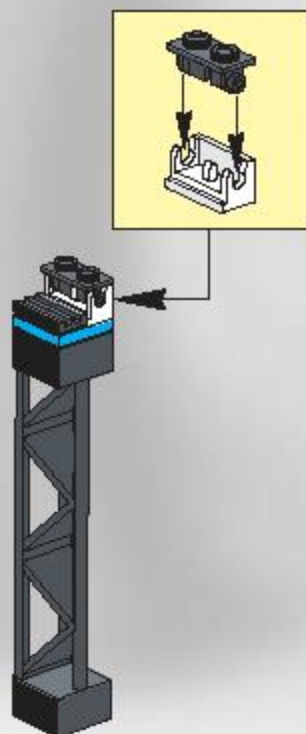

1

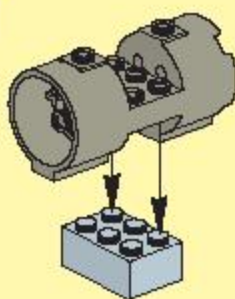

2

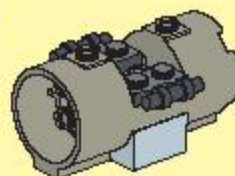

3



4

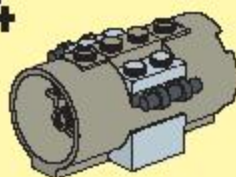

5

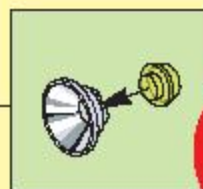

45

4

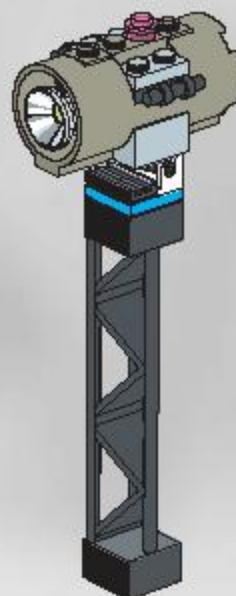



19

46





1

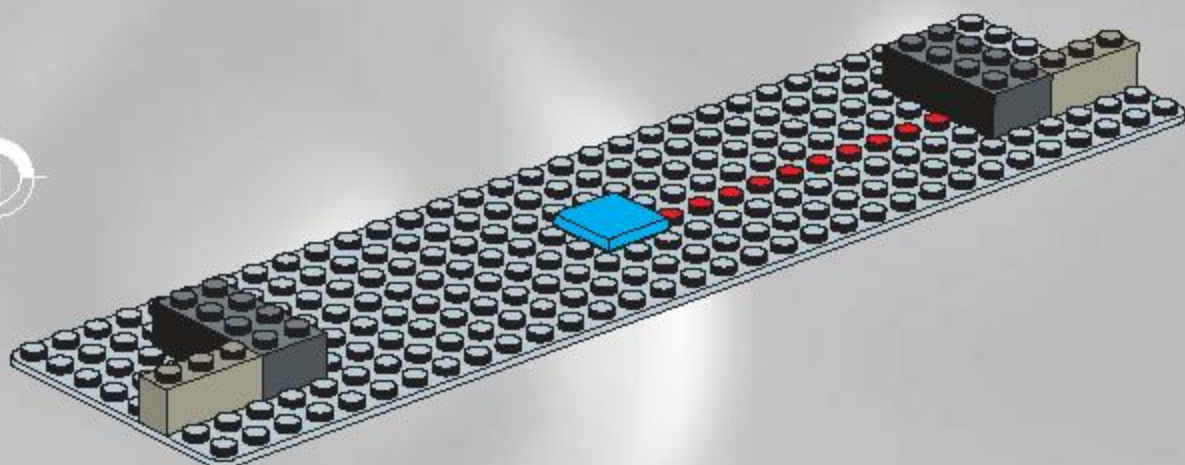

1

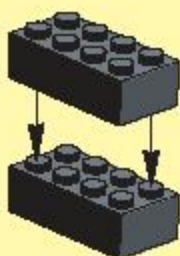

2

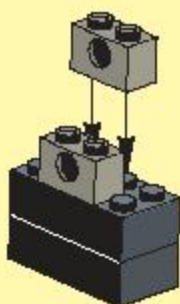

3



4



47

2

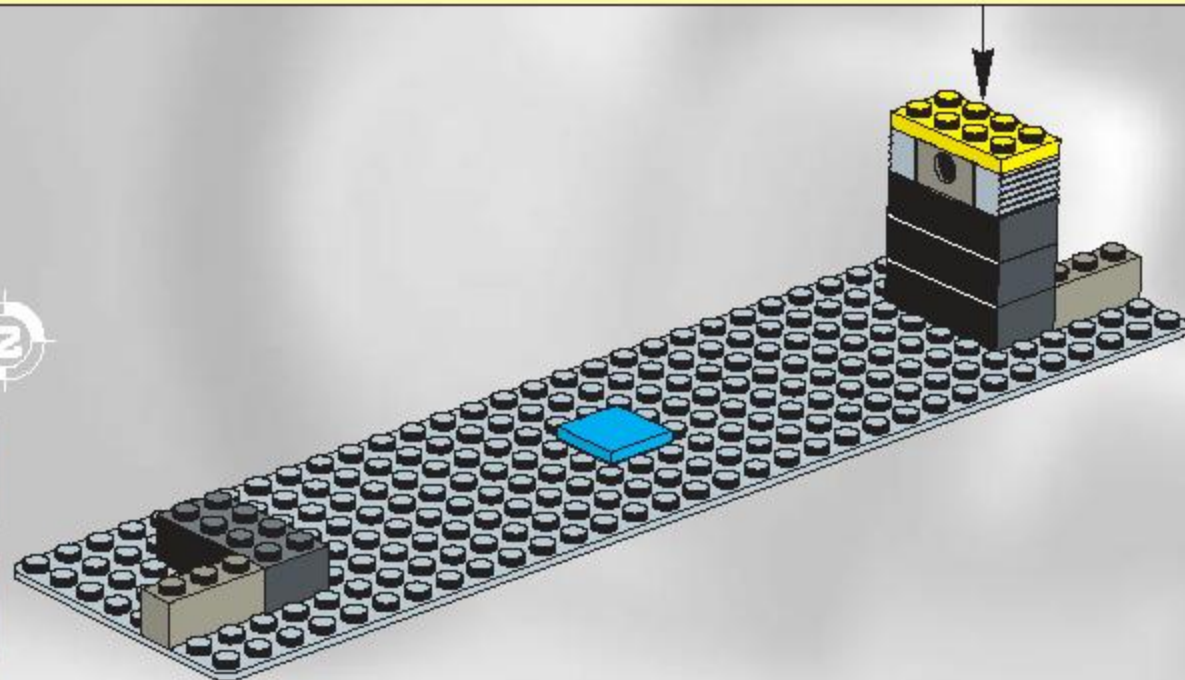

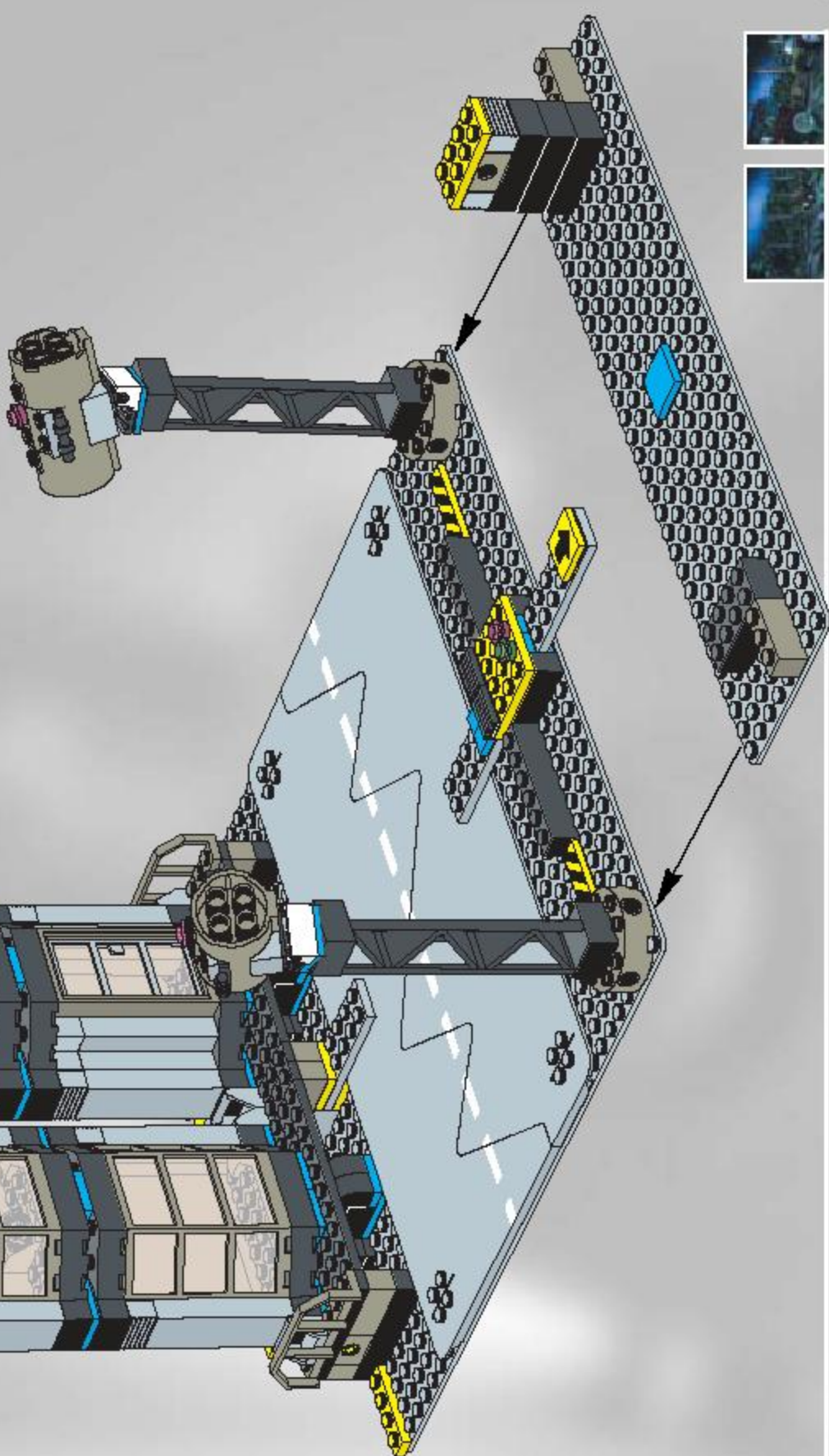

48





2x

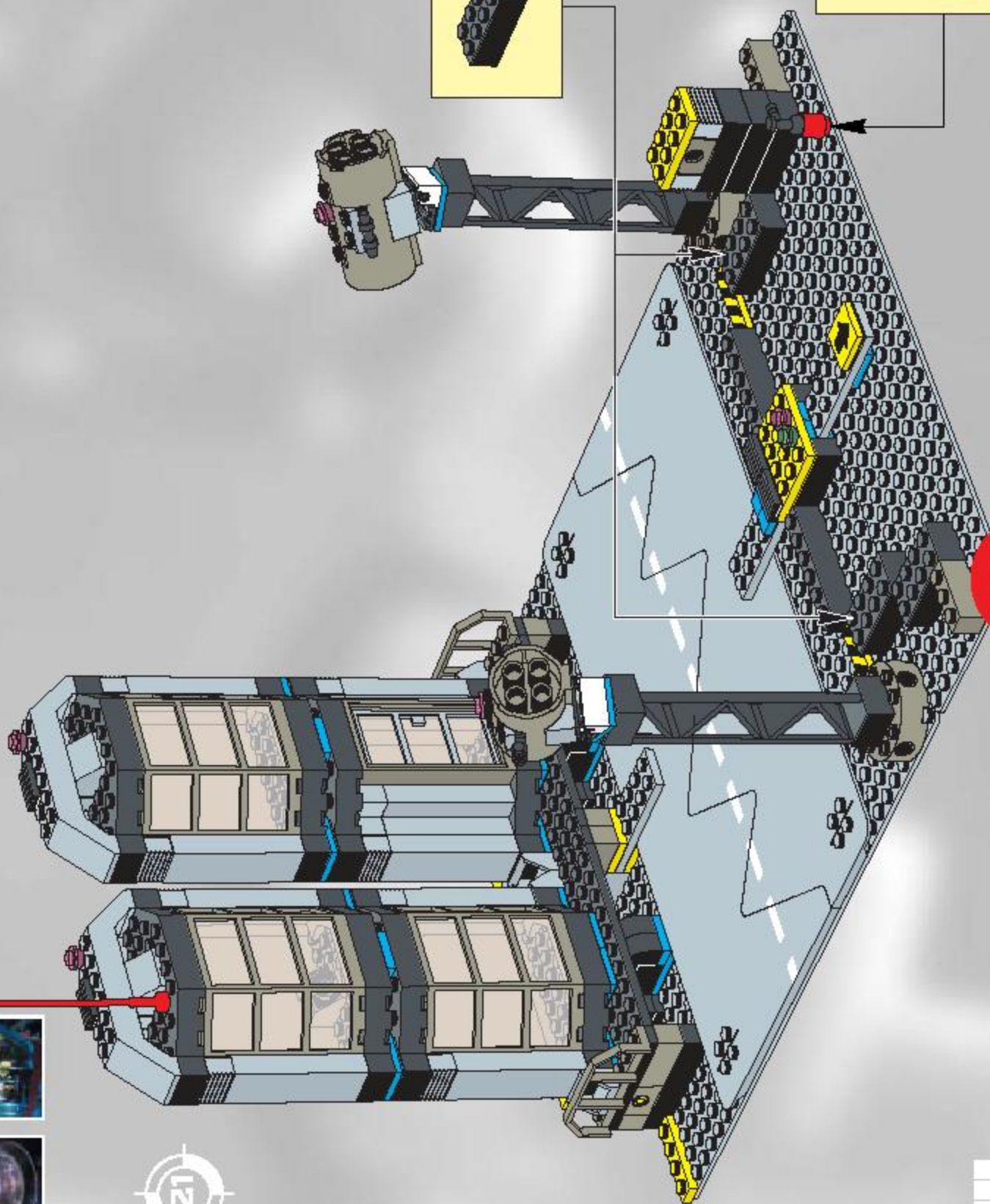
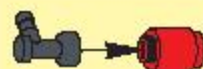

49



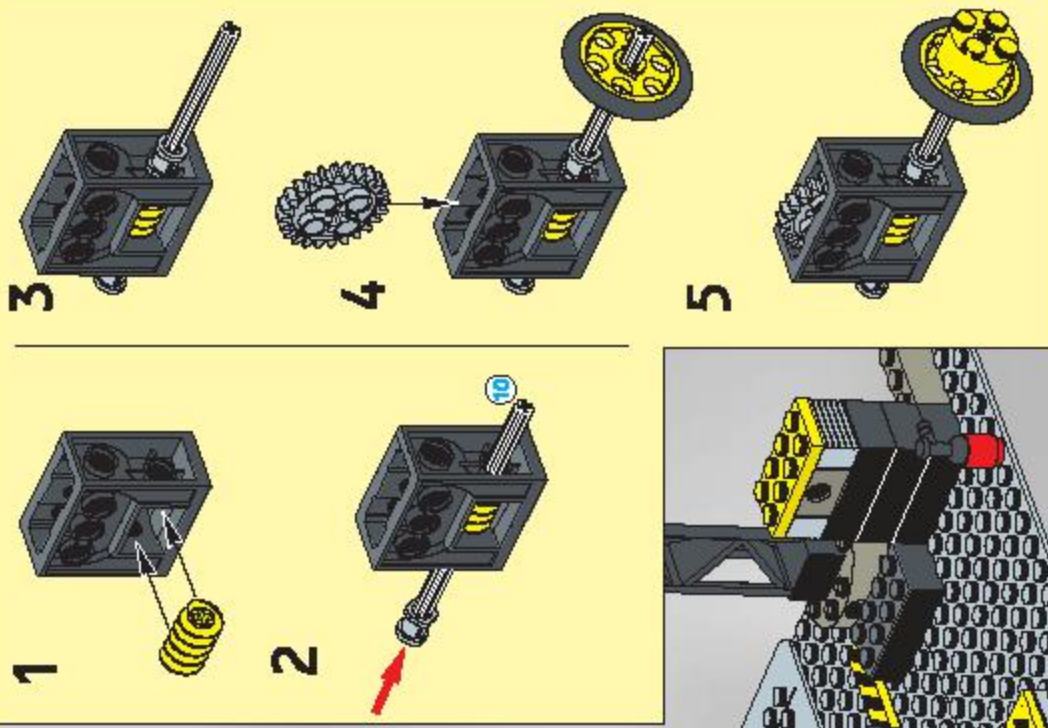

50

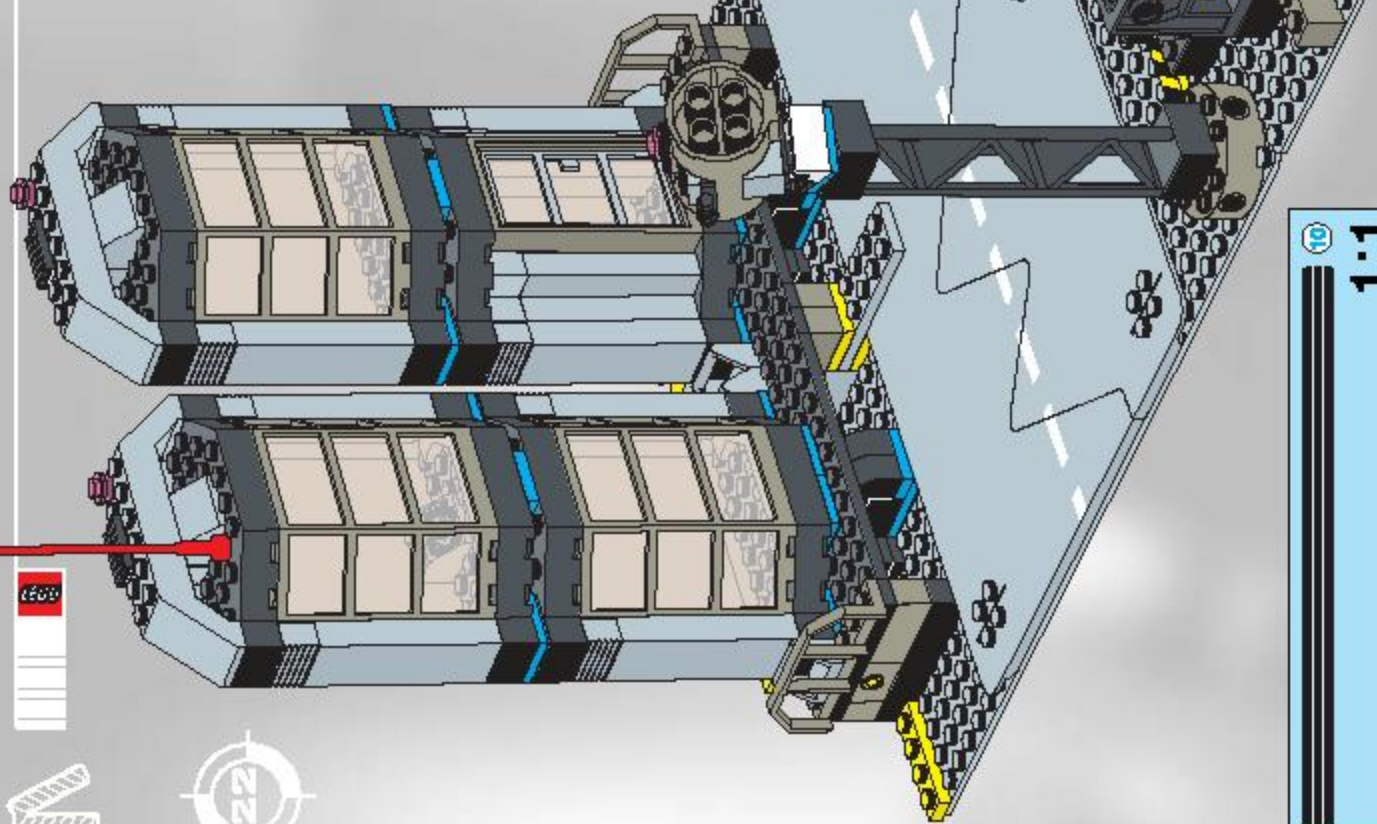

10
1:1



1

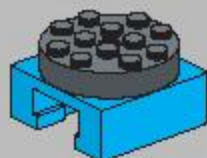

2

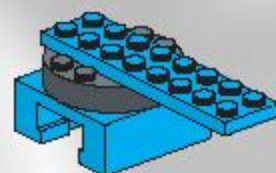

3

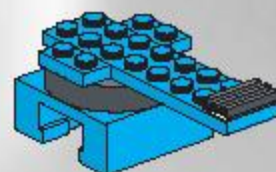

4

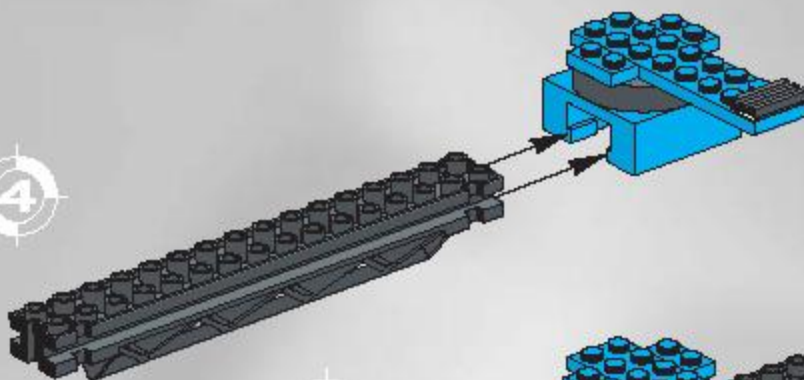

5

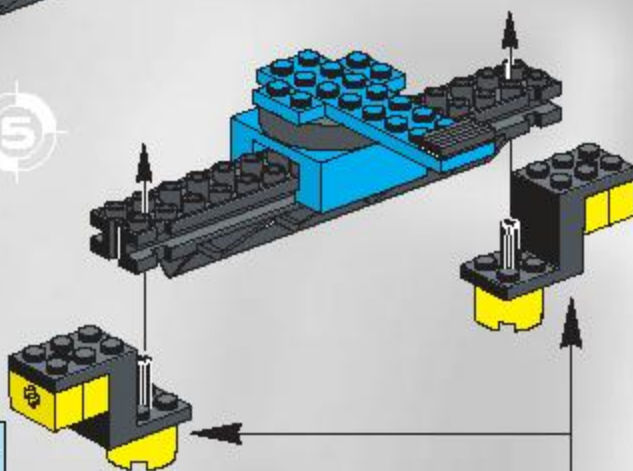

 3 1:1

1



2



3



2x



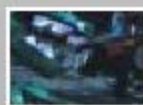

1



2

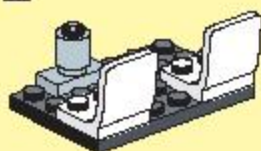

3

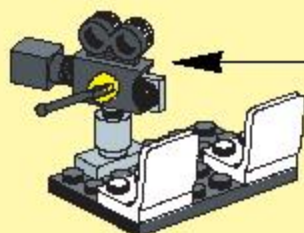

1



2



3



6

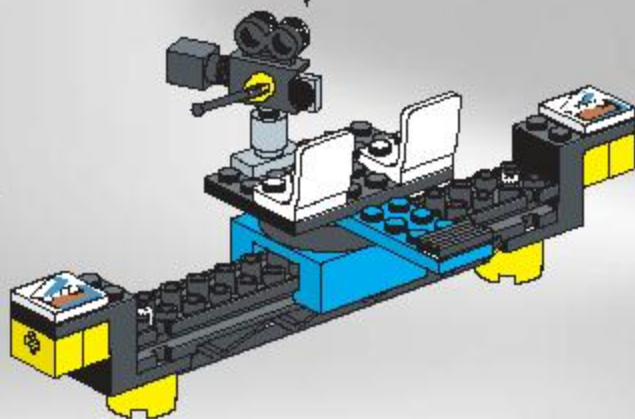

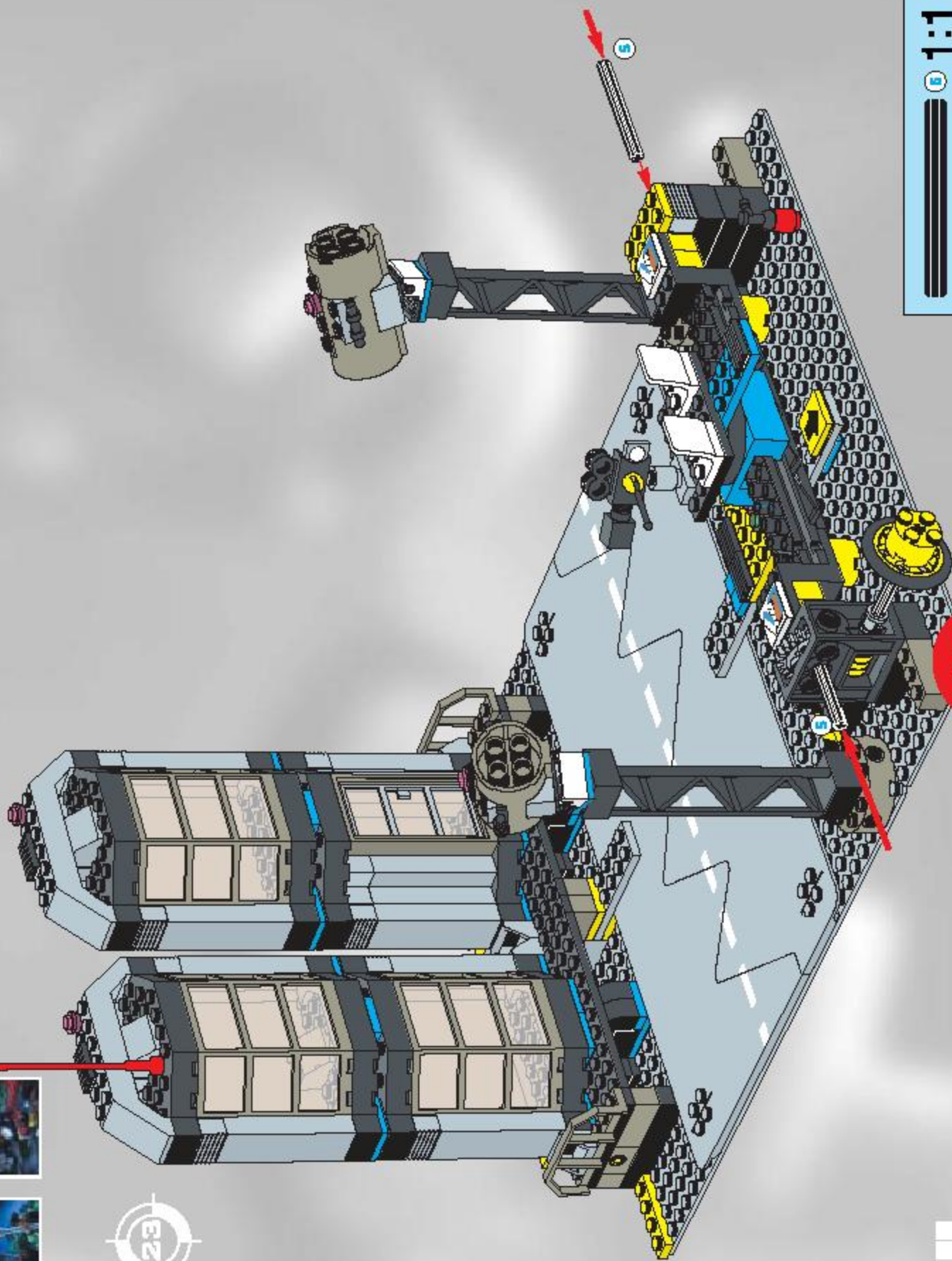

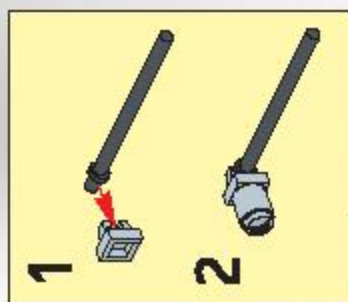
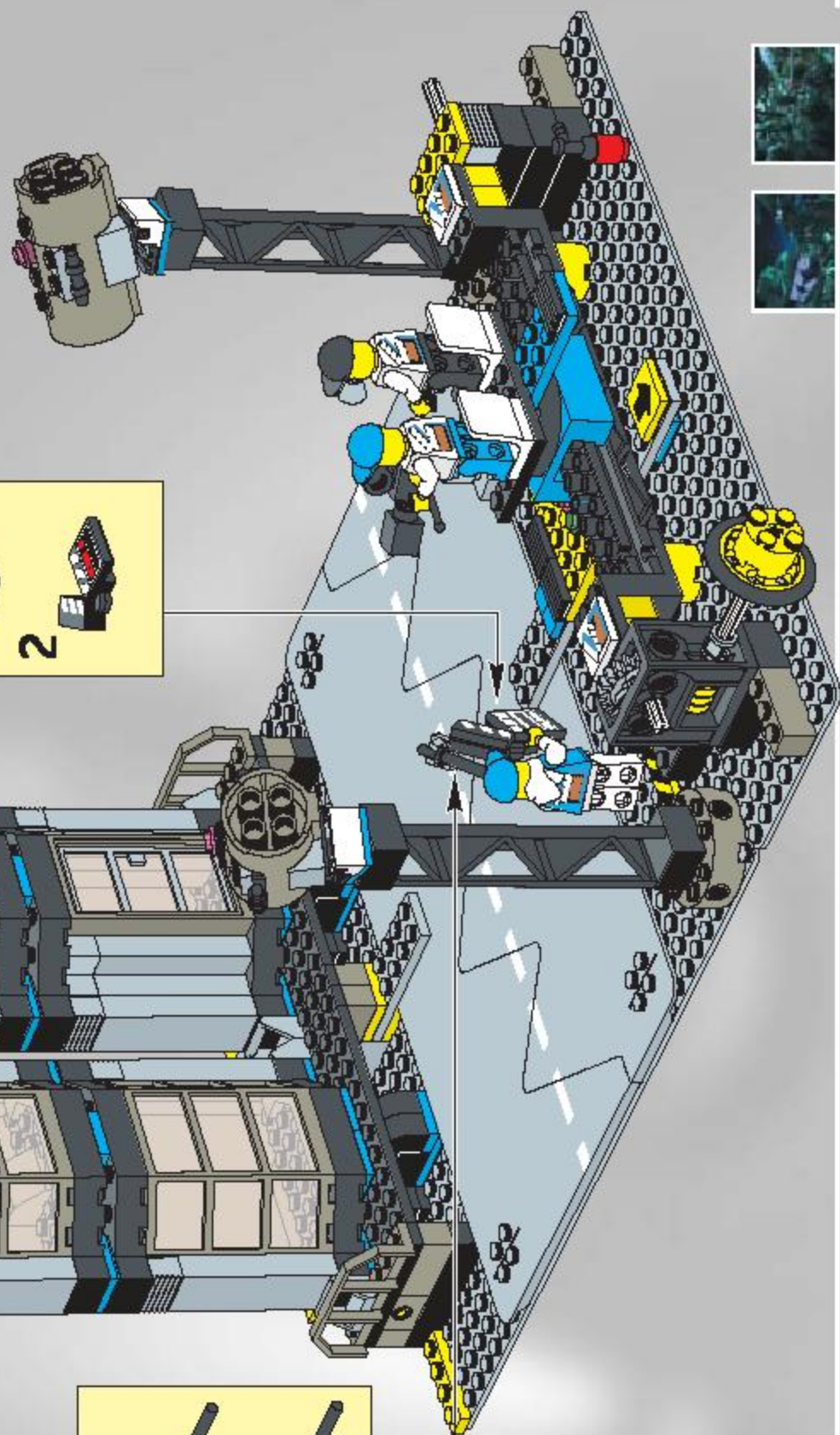

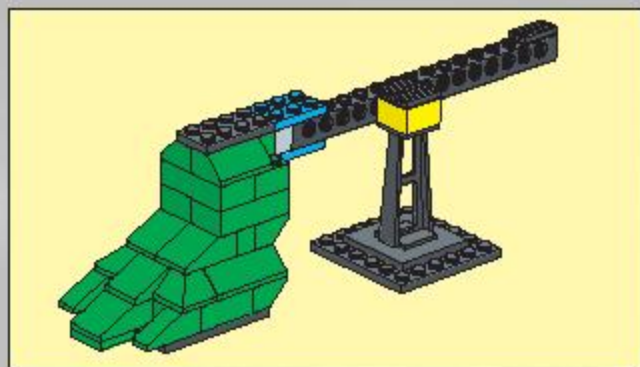

1

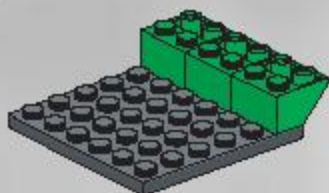

2

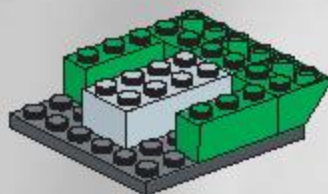

3

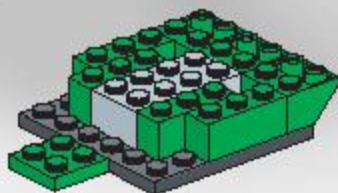

4

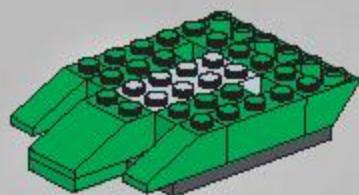

5

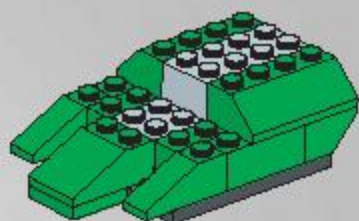

6

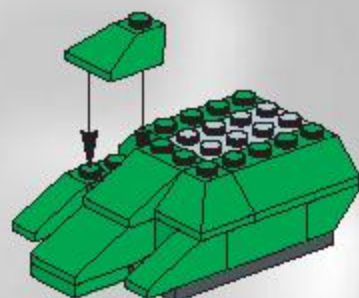

7

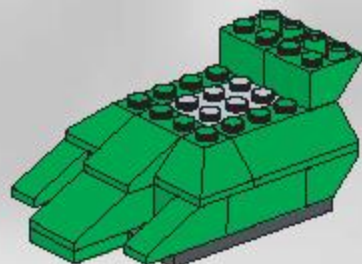



8

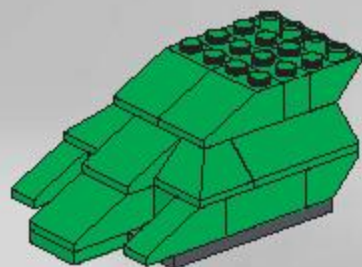

10

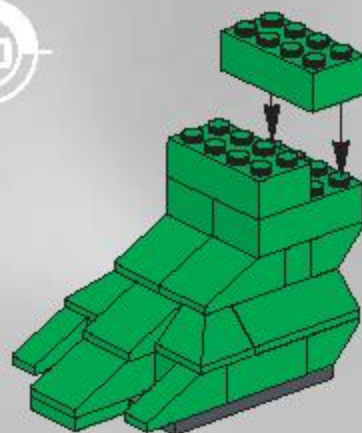

9

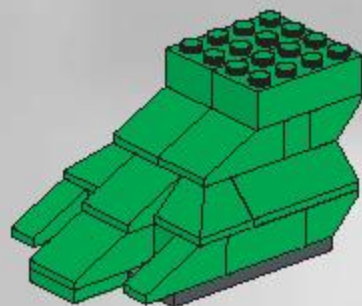

11

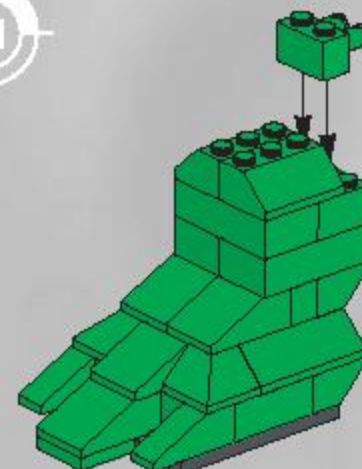



12

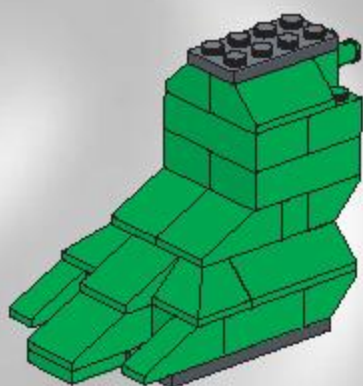

1



2

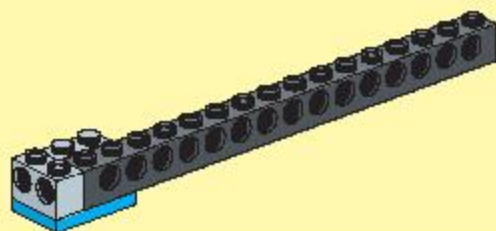

3

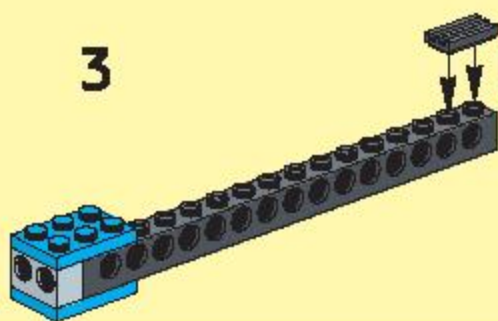

57

13

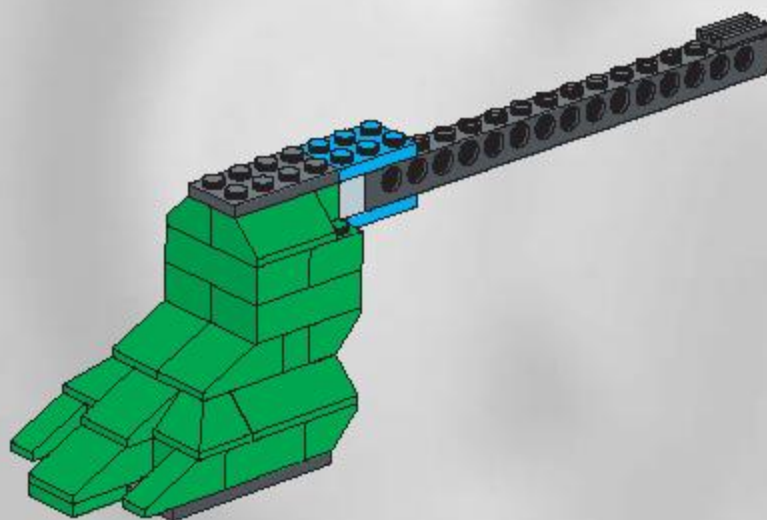

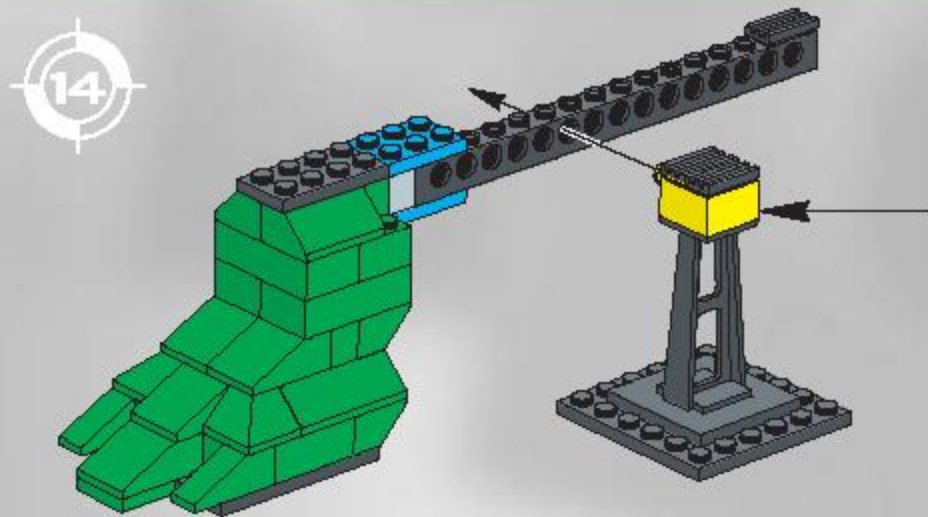
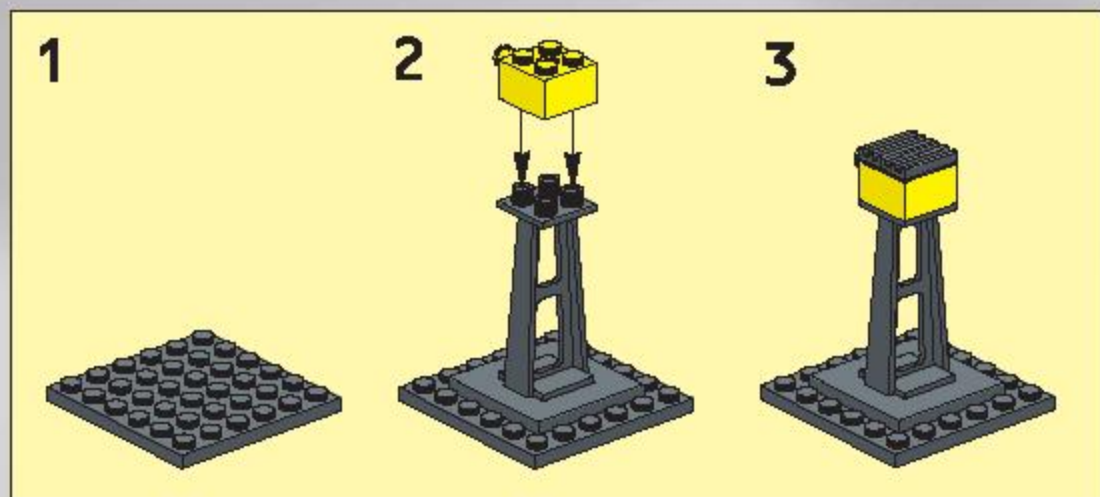



1

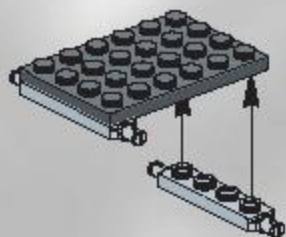

2

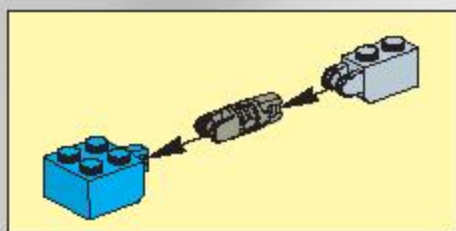
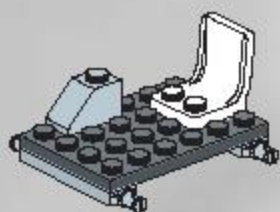

3

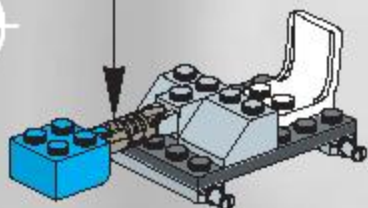

4

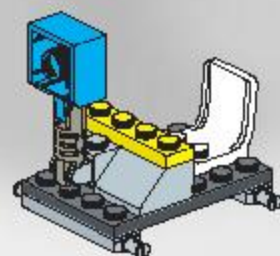

5



1



2



3



6

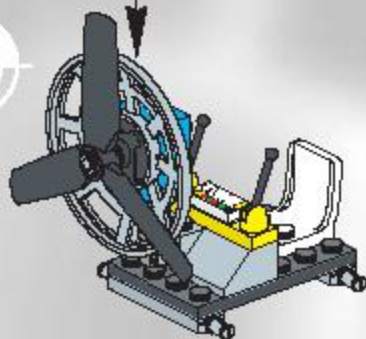

7



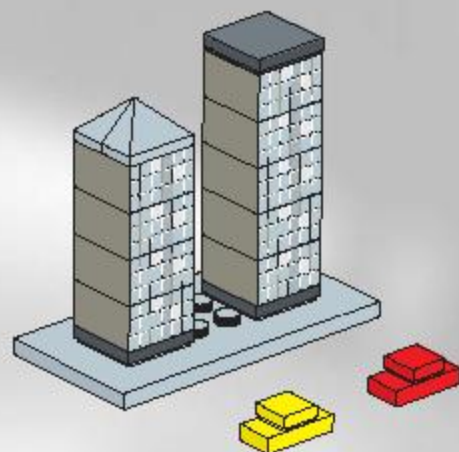
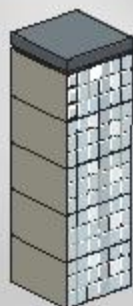
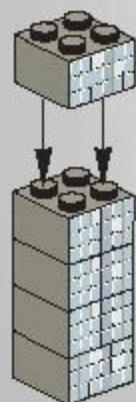
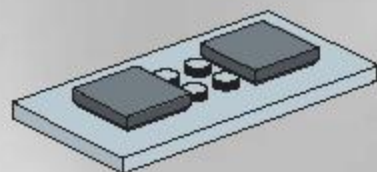
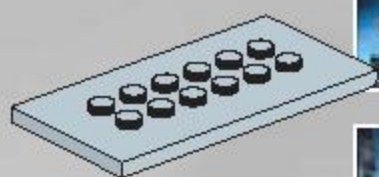
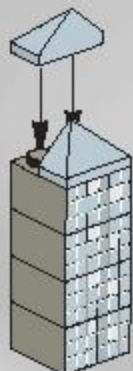
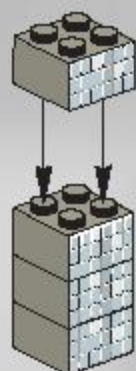

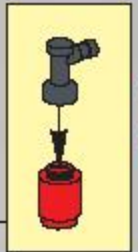
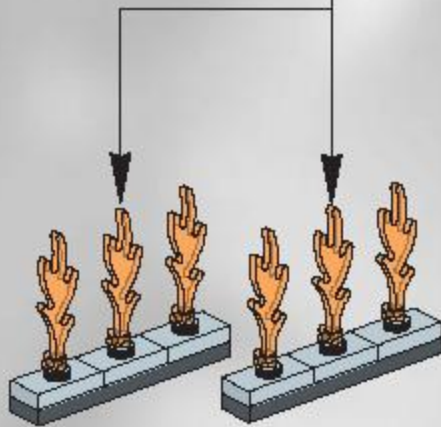
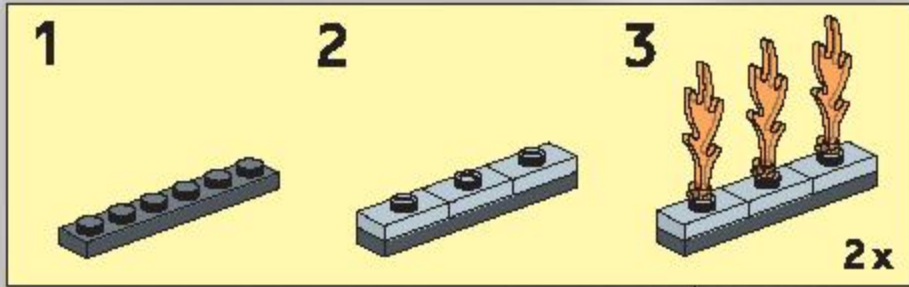
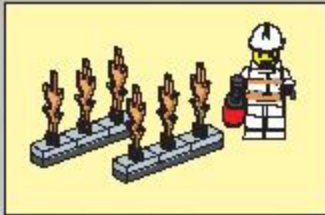



DIRECTOR'S HANDBOOK

HOW TO MAKE MAGNIFICENT MOVIES

So you want to make a movie?

Of course you do! We all love movies. We love going to the cinema or renting videos or watching movies on television. We laugh at Laurel and Hardy, Indiana Jones thrills us, and we figure out the mystery with Sherlock Holmes. When you are watching a movie, it feels as if you were there on the screen, doing all those things yourself. That's why it's such a great experience.





But how are movies made?

It is not as difficult as you might think. In fact, every great moviemaker started at home, just like you. What's more, they didn't have one big advantage that you have – the LEGO & Steven Spielberg MovieMaker Set. In this set, you have everything you need to make all sorts of movies – comedies, thrillers, science fiction, mysteries, perhaps even something a little spooky. I'll be there to help you every step of the way, with a couple of friends...

We've already shown you how to use the Steven Spielberg MovieMaker Set software in the manual and there are more practical tips in the Tutorial section of the software. I am now going to talk you through the process of making a movie. Just to remind you, I'm the Director, and I know just about everything there is to know about making a movie, from pre-production to the premiere. And once you've finished reading this book, so will you.

So let's begin our great moviemaking adventure!

Wait a minute, did I say you have everything you need to make a movie right here in this MovieMaker Set? Actually, there is one element missing. Did they leave something out? No, there is something that you need to provide. But I know you have it. It's inside your head. Can you guess what it is?

Imagination...



YOUR MOVIE



THE IDEA

Every movie begins with an idea. Before you can shoot a movie, you need a story script. For a story you need an idea of what your movie will be about. Who has this idea? The scriptwriter. Scriptwriters are people who sit at their desks all day, thinking of ideas, turning them into stories and then into scripts. It's your turn now! It isn't always easy. But I'm going to give you some tips to spark your imagination.

How do scriptwriters come up with ideas?

Does your teacher ask you to write stories at school or for homework? And do you sit there, sometimes staring into space and sucking your pen with no idea of what to write? Don't worry, that happens to professional scriptwriters too! But when they really can't think of anything, they have a little trick that they use. It's kind of a secret, but I'm going to share it with you.

What if...?

Yes, that's it: "What if...?" That is the secret of coming up with story ideas. You take an ordinary situation and you ask yourself, "What if something unusual happened?" For example: "What if I was walking to school one day and the ground started to shake? What would I do? Would I look for a place of safety where I could hide until the earthquake was over?"



Phil Maker's Fascinating Film Facts

Did you know that 398 movies have been made or adapted from Shakespeare's plays? That makes William Shakespeare one of the movie world's most popular writers, even though he's been dead for over 300 years!



What if a perfectly peaceful seaside resort was suddenly terrorized by a killer shark? That's the idea behind the *Jaws* movies.

All these questions put you in a situation where you have to do something, where you have to act. And that is how you start a story.

But what if... you still cannot think of any story ideas?

Many movies that you see in the cinema started with a writer asking a "what if?" question. But if you can't think of one, don't worry. Not all movies come from original ideas. Quite a few of them are based on stories that already exist.

Some of these stories come from books like *Tarzan*, *Jurassic Park*, and *The Jungle Book*. And some are based on TV shows, like *Pokémon* or *The Rugrats*, or they might be based on the adventures of comic book heroes, like Batman and Superman, or on video games. And sometimes, movies are new versions of old movies remade all over again, because someone thinks they can do it differently, like the Dracula story for example.



Many movies have been made about a character named "Tarzan" - but did you know that Tarzan started out as a character in a book?

TRY IT

create your own ideas file in which you can keep all your moviemaking notes.

- write down your movie ideas, make some photocopies of the Ideas Sheet at the back of this book. use one sheet for each idea be inspired by:
- good ideas from existing TV shows or movies. if you don't like the endings, just change them!
- exciting stories you might have read in books or comics.
- "what if?" ideas of your own!

THE CHARACTERS AND THE PLOT

Every story is made up of two elements – the characters and the plot – the people who are involved in the story and what happens to them. The characters can be good or bad, and the plot charts the different things that they get up to. Keep your audience in suspense by adding unexpected twists and turns to your story.

Characters

Every movie has a hero or heroine. This is the main character, or person, at the center of the story. He or she is the person that everything happens to.

Sometimes there is more than one hero, like Batman and Robin, for example. When that happens, it helps to make them different, so that people can tell them apart easily. Batman is grown-up and wealthy, while Robin is a teenage orphan.

You can be the hero of your movie if you want to. Often however, the hero is a made-up character with some special skills or powers. Tarzan can communicate with animals and survive in the jungle. Superman has superhuman powers and can fly.



Robin Hood is a hero who stole from the rich to give to the poor. His enemies were stronger than him, but somehow he always managed to outsmart them!



Here are some LEGO Mini figures who would make good heroes:

1. "Hotshot" Harry
2. Johnny Thunder
3. King Leo

Phil Maker's Fascinating Film Facts

There have been more than 200 Sherlock Holmes movies made since 1900, which makes this master detective the character most often portrayed in a movie!

So, give your heroes the ability to do something interesting, and more importantly, give them skills that will be useful to them during the story.

Villains and "bad guys"

But the hero isn't the only important character in a movie. In any story, the hero has to struggle. If he easily achieves whatever he wants, then there is really no story. And, if he has to struggle, that means he needs someone to struggle against – a villain or "bad guy".

Have you seen any *Batman* movies? Batman always has a really strong villain working against him, like the Penguin or the Joker.

Villains don't always have to be people

Who are the "villains" in *Jurassic Park*? The dinosaurs, of course. In movies about natural disasters, the heroes are "fighting" against storms, tornadoes and earthquakes, so these elements are the villains. It is important to make the villains bigger or stronger than the heroes. This makes the story more interesting and keeps the audience in suspense. The struggle between the heroes and the villains is what your story is all about.

Who will be the hero? Who will be the villain?

It's up to you! Of course, the hero and villain are not the only characters; there will be other characters in your story as well. We call them secondary characters. Don't add too many secondary characters because the audience can easily become confused if they cannot tell one character from the next. Don't forget that you can use the Mini figures from this or other LEGO sets as your characters.

Here is a tip: don't have your hero "win" too soon. To make the movie interesting, it's good to keep your audience guessing. It helps if your hero spends a lot of the movie losing before winning in the end!



Try It

- Try to think of the sorts of skills and traits that would make a good hero.
- Now think about what types of traits an effective villain would have. "cast" a hero and villain from your LEGO Mini figures. What sort of skills will each character have?
- Now go back to your Ideas Sheets and pick out your favorite movie idea. Make a cast list with the hero, villain, and the secondary characters. Write down each character's skills and traits and file them in your Ideas file.

THE SCRIPT

There are three phases in the making of a movie: pre-production, production and post-production. The phase we are in now is pre-production, which is everything that needs to happen before the camera starts rolling. If you get everything absolutely right in pre-production, it is much easier to make the movie.

Scripting your movie

Now, let's talk about scripts. A script is made up of two parts: the dialogue and the screen directions. The dialogue tells you what people say and the screen directions tell you what they do, or sometimes, how they feel. Each scene normally starts with a screen direction, which tells you who is in the scene at the beginning and what they are doing. Screen directions also tell you if somebody else comes into the scene or if anything important happens.

The writer of this script has marked up his directions in red ink for clarity.

Phil Maker's Fascinating Film Facts

The shortest script since the introduction of speech in movies was the 1976 film *Silent Movie* (strangely enough this wasn't a silent movie!). The script had only one spoken word throughout – "Non!" – which is French for "No!"

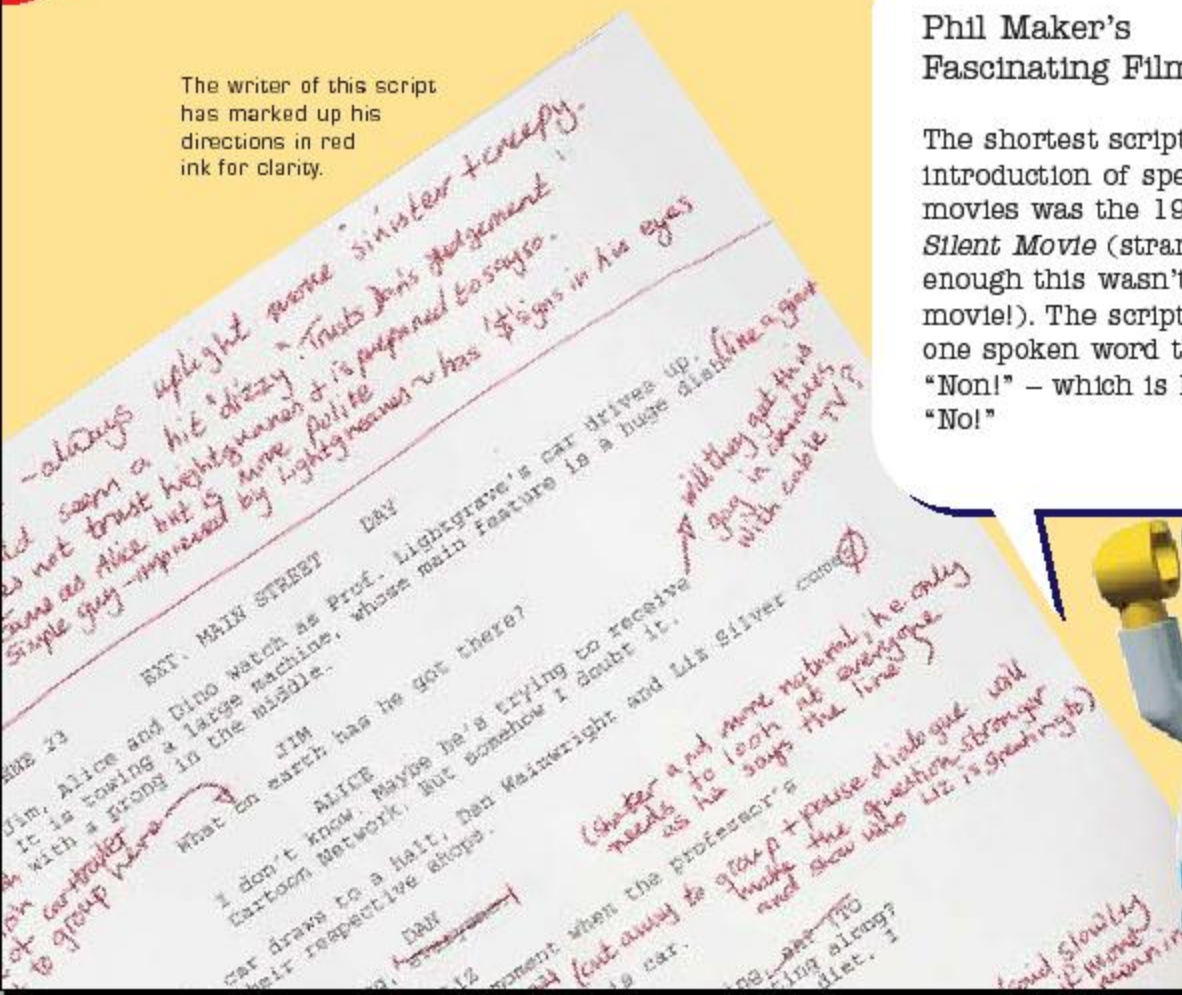

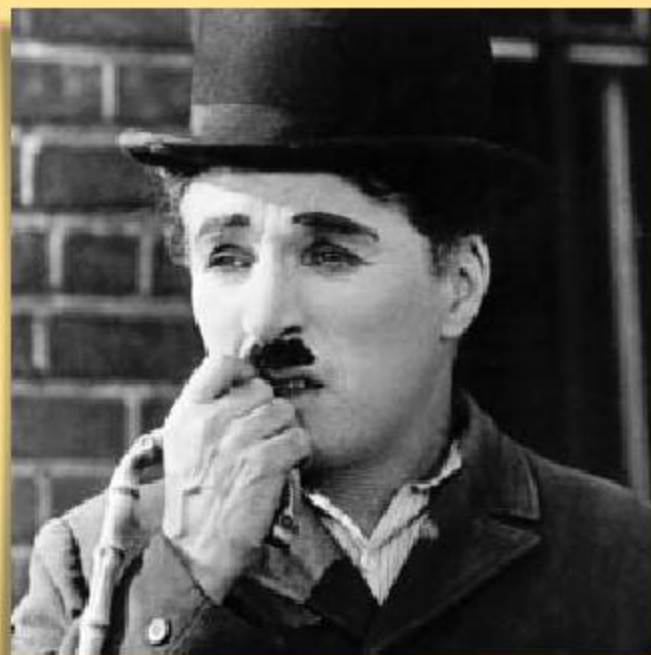

Charlie Chaplin's tramp is probably the most famous silent movie character.



Speeches

A ten-line speech can take up a long time on screen, so keep speeches short. Remember to keep all the characters involved, and give them something to do. You don't normally have to say whom a character is talking to, unless it is unclear.

The first movies ever made didn't have any speech at all – the whole story was told through the actions of the characters. Silent movies are still made today, but not very often. The script for this sort of movie needs to have a lot of detailed directions for the actors, so that they can tell the story through their actions.

How many scenes should a script have?

A scene is a part of a story that takes place in a particular location at a specific time. You should use as many scenes as you need to tell the story! Start small for your first movie – you'll have plenty of time to make longer movies after you've mastered the basics.

Read through your script with friends, doing – or pretending to do – the screen directions, and time how long it takes. You could even act it out for an audience to see whether they understand it. You might have to add some more lines to make the story stronger, or if it feels a little long, take some out.

It's worth spending time on your script to get it right. As the old Hollywood saying goes, "Every great movie is based on a great script."

Try It

- Pick a scene from your favorite movie and try to write a script for it in your own words. Why not write a script for the characters in your Steven Spielberg MovieMaker Set?
- Alternatively, go back to your "Ideas Sheet" and your favorite movie idea. Create a full character list for the movie, and then go ahead and write a script made up of the dialogue and directions.
- Feeling adventurous? Try writing your script as a silent movie. Which script do you like better?

CASTING AND LOCATIONS

Casting and deciding on locations are the last things you do in the pre-production phase of moviemaking. Once you have your finished script, you know how many characters there will be. Some will have leading roles and will be on screen for much of the movie. Some will be supporting characters. Some will only have a few lines or none at all; these are known as walk-ons or extras. Casting is the process of deciding which actors will play the roles in the movie.

On location!

Once the director has a finished script, it's time to look for locations where each scene will be shot. Why not create your own locations using everyday objects? The possibilities are endless! You can also make props and even characters out of LEGO bricks and modeling clay. Just use your imagination and you'll find things you can use for your movie all around you!

Real moviemakers create their own locations too. They add props and paint canvas backdrops to hang at the back of the set. So, if the movie setting is a village at the foot of a mountain, the outside backdrop is painted to show sky and clouds with the mountain. You can use this same technique to make backgrounds for your LEGO sets. Paint the scenes directly on pieces of stiff cardboard that you can stand up behind the set.



Here are some homemade locations. The Mars background is made from aluminum foil.



The grass in the soccer scene is made from a green towel, and the background is a scene painted on to cardboard.

These are the materials used to create the sets on the opposite page.

Sometimes moviemakers build their sets in a studio. This is especially true for interior scenes, such as inside houses or shops or offices. When I build rooms in a studio, I make them so that I can remove whole walls to give myself more room to shoot. The audience doesn't realize that those walls are missing, of course, because I make sure the camera is always pointing the other way!

If you're using a set made of LEGO bricks, it's easy to take out a wall and move the camera in for a really tight shot! Maybe you can use some LEGO sets that you have already built in your movie: pirate ships, castles or spaceships. You choose – it's your movie!

Usually, I end up using a combination of sets and locations. I might start by filming a location shot on the street outside. But the inside would be built in a studio. I would shoot the interior shots later. At the editing stage, I would put the two scenes together. You can use the same technique when you are using different sets, built at different times.

TRY IT

- Look at your script and decide on the sets that you're going to need.
- Now go ahead and create the sets and locations. Build extra props for the set with LEGO bricks, modeling clay or painted cardboard. And don't forget the backdrops!
- Make a note of the location of each scene and the most important props in your script.

Phil Maker's Fascinating Film Facts

The largest number of extras employed in a movie was 300,000! They were employed for one of the scenes in the 1982 movie *Gandhi*. The edited sequence of the extras ran for just 125 seconds of the finished movie.



READY TO ROLL

We're getting there! There is one last decision to make before you're ready to roll – live action or animation? I'll explain what these are so you can choose what's best for your movie.

Live action

There are two types of moviemaking. The first, which is also the easiest, is just letting the camera record while you make the action happen. This is called live action. It is perfect for recording fast action, like a building falling to the ground or a speeding car. Live action is also used when actors are simply acting out their roles and no "special effects" are needed. You can move the characters and props in your LEGO set by using the black plastic stalks included in this set. Try using live action to film yourself and your friends and family acting out a play, or singing and dancing, or just talking.

Animation

The second type of moviemaking is animation. In animated movies, the characters are usually drawn or perhaps made out of clay. The Wallace and Gromit movies, *Toy Story* and *Chicken Run* are all examples of animated movies. Animation takes a long time but can give you wonderful effects. You can make characters fly or stay under water or change shape completely if you are using animation! LEGO Mini figures are ideal for a certain kind of animation, known as "stop motion animation". Turn to the manual for more information on how to film an animated movie.



The characters in the *Wallace and Gromit* films are made of clay.

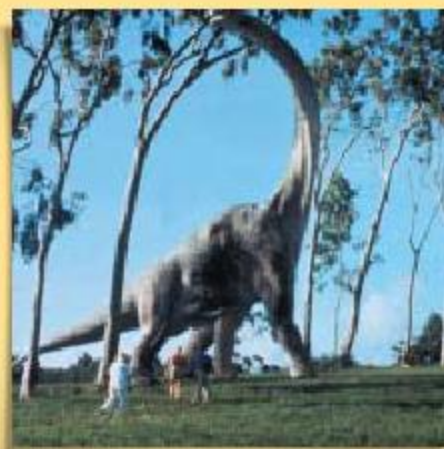

The dinosaurs in *Jurassic Park* are animated by computers.





1. To animate a character, start by positioning your camera firmly on the side of your set, so that it doesn't move. Then, place your character in a starting position.



2. Move your fingers away from view and take a shot.



3. Move the character a tiny bit. Move your fingers away from view and take a shot.

Repeat this process until the movement has been completed. You can then go to your Edit Screen and play back your animation!

Move the character you want to animate slightly, then take a shot with the camera. Move it again and take another shot. Keep repeating this process. When you look at the final movie, your character will appear to move by itself. You can use LEGO bricks to hold the figure in position. Otherwise, try using modeling clay or double-sided tape. Just make sure that you can't see the clay or tape in the shot! To make up a second of film you need to take 15 shots.

Mixing techniques

For action shots, like a building falling down, you need to use live action. It's easy, just point the camera at the building as it topples over. For other sequences, such as a dinosaur opening its mouth, it is much better to use stop motion. If you used live action, your fingers would be caught on film as they moved the dinosaur's mouth. Sometimes, the best solution is to mix the two techniques. Some movies, such as *Who Framed Roger Rabbit?* and *Jurassic Park* do just this.

Phil Maker's Fascinating Film Facts

In the classic movie *King Kong*, the giant gorilla in the movie was actually six 18 inch models. The movements of the gorilla were filmed using stop motion animation.

Try It

- Make some live action greeting cards, shoot a short scene and e-mail it to friends and family for special occasions.
- You can customize the cards further by adding some text with a special message (read about how to do this in the manual page 17).

LIGHTS-CAMERA-ACTION!

You have your script, your cast, your sets and your "locations". It is time to start shooting your movie. But where should you begin? What are you going to shoot first? How are you going to do this? It is a good idea to get some friends to come and help you with your movie. They can be your "crew"! You can make a movie by yourself, but a "crew" is going to make things a lot easier and a lot more fun!

Creating a storyboard

OK, so now you know what you want the movie to look like! You need to share your thoughts with the cast and crew – to show them how you imagine the movie is going to look. The best way to do this is to draw a storyboard..

Here is the storyboard of one of the great LEGO Movies in the software.

actors

props

location

script

lighting

I'm hungry!

GREAT MOVIES

Shark Bite Synopsis



A boy and a girl - gone fishing in a fishing boat. The boy is fishing and the girl is helping to clean up the boat.



In an underwater shot, we see the shadow of a shark, showing us we are in the water. The shark is swimming towards the boat and the boy and girl.



Suddenly the shark breaks through the surface and attacks the boat with its mouth wide open and big jaws. A large part of the boat is splintered.



The girl - caught with shark. She is with the fishing net. The shark appears to be the main focus but the boy is looking at the fishing net and the shark. The shark is eating the boy while the boat is sinking.



The boy and girl jump into the water and escape from the splintered boat. The shark is eating the boy and the girl is looking at the shark.

You do not have to be a fantastic artist to create a storyboard, you just need to get your basic ideas across.

A storyboard is the director's way of putting the movie on paper before it is made. Just as the script tells the story in words, the storyboard does the same thing in pictures.

The crew will be able to follow the sequence of shots and understand how you want the finished movie to look. It will also help you, the director, keep all the scenes in your head – which can sometimes be quite difficult, because a director has so many things to remember. To make a storyboard, you draw each scene on paper with short notes. The finished item will look like a comic strip.

STORYBOARD SHEET



Make a drawing in each box to show what will happen in each scene. Write in any sound effects in the line above the box. Write the dialogue on the lines below and any additional notes that might be helpful. Photocopy this page as many times as you'd like to create new stories!

<p>sound effects</p> <p>dialogue:</p> <p>background / location notes:</p>	<p>sound effects</p> <p>dialogue:</p> <p>background / location notes:</p>	<p>sound effects ROAR</p> <p>dialogue:</p> <p>background / location notes:</p>
<p>sound effects GRRRR!</p> <p>dialogue:</p> <p>background / location notes:</p>	<p>sound effects CRACKLE</p> <p>dialogue:</p> <p>background / location notes:</p>	<p>sound effects</p> <p>dialogue:</p> <p>background / location notes:</p>

There are _____ pages in this story. This is page _____.

Try It

Can you see your movie in your head? Photocopy the storyboard sheet from the back of this book and try drawing three of the shots from your movie on to it.

- Go to the film screen and shoot those three scenes using your Steven Spielberg MovieMaker Set. View them on the Edit screen and see your movie taking shape.
- Can you think of other ways to shoot the same scene? Try drawing out the new approaches, shooting them and see which one works best.
- When you've done this, make a storyboard for the whole movie, trying out different shots and effects with your LEGO PC Movie camera.

Phil Maker's Fascinating Film Facts

The largest production crew on a movie was the 556 craftsmen and technicians used in the 1965 movie *Tokyo Olympiad*.



LIGHTING



Lighting is a very important part of moviemaking because it helps create the mood. Different kinds of lighting are used to create different effects, and the position of the lights is important. Choose between natural daylight and electric light. Try both and see what works best for your movie.

Let there be light!

Each shot in a movie is lit differently depending on its location. Is the scene you are shooting set during the day or the night? Is it inside or outside? These are all factors that influence where the light is coming from, and how bright it has to be.

Bright lights are placed outside windows to make it look as though sunlight is streaming into a room. Other lights are hung above the set to recreate the effect of an electric light bulb. Remember that all light casts shadows and that you can use these shadows to create atmosphere. Shadows are especially effective in adding a scary atmosphere in thrillers.

Suppose you're shooting a scene where the LEGO actress is sunbathing. Somebody stands between her and the sun, casting a shadow over her. When she looks up, it is hard to see who it is because of the bright light behind them. This could be a scary moment. What if the shadow did not belong to another person but to a huge creature?

Filters

You can achieve lots of additional light effects by using filters. These are colored strips of plastic that are placed in front of the lights. You can use colored cellophane candy wrappers and a flashlight to create filters. Just hold the candy wrappers in front of the flashlight and shine it on to your movie set. Be very careful not to let the wrapper get too hot and never let it touch the bulb. There are some great hints about lighting effects in the Masterclass on page 96.



Have fun with shadows – you can use them to show things are not always what they seem!



The light cast by a candy wrapper filter on a flashlight makes this rescue helicopter look as if it has switched on some "emergency" red lights.

Phil Maker's Fascinating Film Facts

In the early days of moviemaking, lighting was very expensive; moviemakers in California used the dry, sunny climate to their advantage by building indoor sets outside. That way, they could shoot whole movies without lights, which saved a lot of money!



Exposed!

One way I like to create lighting effects is by changing the exposure on the camera. This is a little tricky to understand, so let me explain. The exposure is the amount of light that passes through the lens of the camera. Too little light makes it dark and too much has the reverse effect, making it very bright. These techniques are called "underexposure" and "overexposure". The exposure can be altered using the slider controls on the Film Screen. If you reduce the amount of light going through the camera lens, you can create the effect of "night time" even though there is plenty of natural daylight.

Black and white

Before color film was developed, all movies were shot in black and white. Today, black and white photography is used in the same way as lighting, to create an effect in a movie. This technique is often used to represent the past – a moment from history, such as a famous battle or a memory from a character's childhood. You can use the saturation slider on your Film Screen to shoot in black and white.

Try It

Here are some lighting effects to try out yourself!

- Film a "night" scene in daylight by altering the exposure of your camera.
- Take a flashlight and shine it at different angles and heights on to your set. Shoot each effect and study how the changes in lighting create different moods.
- Write a movie script that includes a historical scene and shoot it in black and white by altering the saturation level of your camera.



CAMERA SHOTS AND ANGLES



Wide shot



Mid shot



Close-up shot

The camera is the most effective tool that directors have to create movies. The director chooses each and every shot, its size and its angle. Using different angles and tilts in each shot can change the mood and intensity of a scene.

Shots in the dark

The wide shot is used to establish each scene in a movie. For example, this wide shot tells us we are in a medieval kingdom. The audience instantly knows where the movie is located from this shot. A new wide shot will be shown when the location has changed.

The mid shot takes the audience closer. Move closer again, and pick out characters and objects using either the close-up or the big close-up. These are the shots used to show close-up action and conversation.

When you want to see everything that's happening in a scene, you can place the camera farther away. When you want to concentrate on a character's reactions, put the camera right up close.

You don't always have to show a whole scene happening. Sometimes it's very effective to show the point of view of one of the characters. Use a combination of shots and perspectives to add variety to your movie.

Using tracks

The camera does not have to remain still while shooting. It can move around. The most popular camera movement is "tracking". This is when the camera moves forwards, backwards or side to side. All you have to do is mount the camera on the track and push it slowly in any chosen direction.

You can vary your tracking speed according to the mood of the scene. If you want your hero to enter the cave of a dangerous dragon you can try to build up the tension and mystery by tracking slowly into the cave.

The track can also be used to take the audience from a wide shot to a close-up. Suppose our hero is opening up a suspicious-looking box. To make the scene more dramatic, track the camera closer and closer to the box as the lid is lifted, to reveal the contents in a big close-up.

Pans and tilts

The MovieMaker Set tracking system lets you make other impressive camera movements – called “pans” and “tilts”. A pan is when the camera lens moves across from left to right or vice versa. For example, two actors face each other across a table and the camera pans between them as they speak. You can achieve pans by turning the mounted camera on its turntable. A tilt moves the camera up or down. “Tilt” your camera by turning the wheel at the side of your camera stand, as shown in the photo.

Camera movements are used to build up the drama or the funny moments in a movie. There are all kinds of interesting effects you can try out using your camera – see the Masterclass on page 97.

Try It

- to build up drama before revealing the identity of a mystery character, tilt up slowly from his feet, revealing more of him. Last of all, reveal his face!
- to make a building look really tall, tilt slowly from the top of it to the bottom.



Phil Maker's Fascinating Film Facts

In the 1981 film *Raiders of the Lost Ark*, one scene required a well of snakes. However, once the snakes were on set, there still were not enough of them. Director Steven Spielberg had several hoses cut up to be used as well. If you look closely in the movie, you can tell which are the real snakes and which are fake.



SHOOTING OUT OF SEQUENCE

When you read a book, you usually start with the first page and go through to the last page. But a movie is made out of order and one of the reasons why you edit it is to put it back into the right order. Different scenes are shot on different sets and locations. It is easier to shoot all the scenes that take place in one location together, as this means that the crew only has to move the equipment once.



Master shot

Different shots

It is not only the locations that are shot out of sequence. A scene is made up of several different shots and the director will often shoot these out of order. It would waste a lot of time if the camera and the lights were turned around to shoot each line of dialogue or each piece of action separately.

A typical scene in a movie is made up of different shots: a master shot and the other shots, such as wide shots and close-ups that we talked about earlier. Make a note on your storyboard of all the different shots that you will need before filming. Of course, you might want to change a certain shot at the editing stage. Just remember that the audience will want to see a character's face when they are talking, but not when there are other more exciting things going on in the scene!

Phil Maker's Fascinating Film Facts

In the 1957 movie *Jailhouse Rock* the character Vince, played by Elvis Presley, starts out being convict number 6239 (it's printed on his shirt). But in later shots he becomes convict number 6240! In the same movie, the lead guitarist in one of the scenes is wearing sunglasses for all the long shots, but appears without them in all the other shots.





Close-up shot

Making a scene!

A master shot records a scene in one take, from beginning to end. It shoots the actors, their dialogue and their actions from start to finish without interruption. At the end of the master shot, the director shouts "Cut!" and then shoots the whole scene again in close-up, concentrating on each actor individually or on the action. If two actors are having a conversation, one actor will speak all his lines in one take while the camera is pointed at him. The other actor will wait until the camera is turned around and pointed at her before she speaks all her dialogue, from beginning to end. This is called the "reverse shot" or "reverse close-up".



Can you spot the continuity error in the bottom shot?

A scene is complete when the master shot, close-ups and reverse shots have all been filmed. At the editing stage, the director decides on the combination of master shots and other shots that work best for the movie.

Continuity

In each shot, the actors must repeat their dialogue and action in exactly the same way each time so that the various shots look as though they were filmed together. The same attention must be paid to actors' costumes and where they stand. Making sure that everything looks and sounds the same in each and every shot is called "continuity".

TRY IT

- Write a short LEGO movie scene where a dinosaur is bothering the heroine. Write a shot list for the scene.
- Shoot all the dinosaur shots and then all the heroine shots.
- Now edit them together. Watch out for continuity errors; make sure costumes and props used in the different shots remain the same.
- The next time you watch a movie, look at the different shots in the scene. They might give you some ideas for your own movies. Watch carefully; you might even spot some continuity errors!

SOUND

Most movies have a soundtrack, which is made up of the dialogue, sound effects and music. These three sound elements are all present together in the final movie, but are actually recorded at different times. Dialogue, or speech, is recorded during the shooting, and music and effects are added later during the editing stage of the movie.

Direct sound

When a movie is shot, the dialogue that is recorded at the same time is called direct sound. The director always calls for quiet from the rest of the crew during shooting because the microphone on a movie set is very sensitive and can pick up all kinds of sounds.

When you shoot live action with the MovieMaker Set, you can record sound directly through the LEGO PC Movie Camera. You may want to have your friends or family speak lines of dialogue as you'll be busy operating your camera and moving your props and characters around.

Indirect sound

When you shoot using the stop motion technique, the camera does not record sound. Don't worry, this does not mean that all your stop motion shots are going to be silent. You can dub in the voices and sounds later as indirect sound, using your LEGO PC Movie Camera.

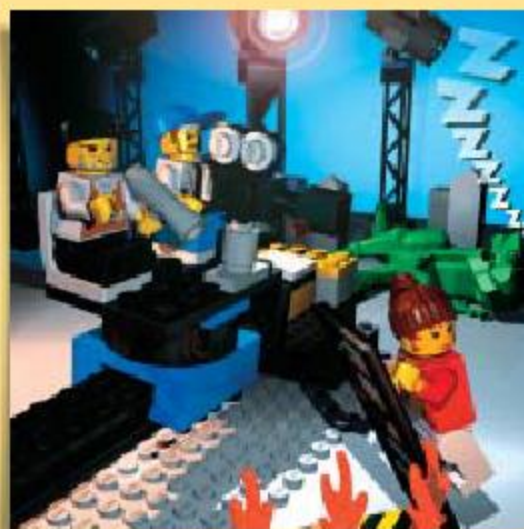

Make sure that there is no background sound while you are shooting... like snoring for example!

Phil Maker's Fascinating Film Facts

You might think that Hollywood is the place where most films are made, but this is not strictly true. The United States produces around 550 films a year, but "Bollywood", the Indian Hollywood, produces over 800 films a year. Most of them are musicals and some have as many as 10 songs.

Animation movies and cartoons have the voices added once the shoot is complete. The movie is usually projected in front of the actors, who gather around a microphone and speak the lines using the character's voice.

Voice-over

Sometimes one voice narrates a whole movie from beginning to end, describing the characters and the action that takes place. This is called a "voice-over" and is used in a lot of movies instead of speech.

Music

The soundtrack of a movie can also include music that is added after the shoot has finished. You can add music from your favorite CD using the Edit Screen. You may want to play the music yourself, directly into the microphone. There is also a special feature called Smart Sounds®, which I will talk about later on page 88.



Add dialogue to animated movies by doing voice-overs for the spoken parts.

Try It

- Time your movie, or any one of the scenes you've filmed, using the timeline and then write a short voice-over script that describes what is happening.
- Rehearse it to make sure it is the right length and then record it as indirect sound through your LEGO PE Movie camera.
- Now re-shoot the same movie or scene using direct sound; make sure you practice before you start rolling!
- Which sound technique do you think works best for your script? Why? Look through your movie ideas and try to decide which would work best with direct sound and which would work best with indirect sound.
- Try to shoot one of your films with a combination of the two!



STUNTS AND SPECIAL EFFECTS

Exploding buildings, crashing cars, erupting volcanoes – all these spectacular effects are created using a variety of tricks and techniques.

Stunts

A scene that shows people falling through windows, jumping off buildings or crashing cars can be dangerous. That is why a director will hire a professional stunt team to do these stunts under strict safety guidelines.

Special effects

Stunning effects can also be achieved using a computer or special props. Making actors disappear, making spaceships get sucked into swirling black holes, and making superheroes fly are just some of the amazing effects that can be created.



Computers were used extensively for the special effects in *Jurassic Park*.

Phil Maker's Fascinating Film Facts

In Clint Eastwood's 1990 movie *The Rookie* there were more stuntmen than actors! There were 87 stuntmen in total and only 37 actors with speaking parts!



Interesting effects

You can achieve some of these effects using your LEGO PC Movie Camera. Use stop motion animation to construct an entire building brick by brick before your audience's very eyes. Or film one character being transformed into another. This effect is called "morphing". You can do these with the Animate button on the Film Screen of the MovieMaker Set software. You can also make characters and props move in different ways using stop motion animation.

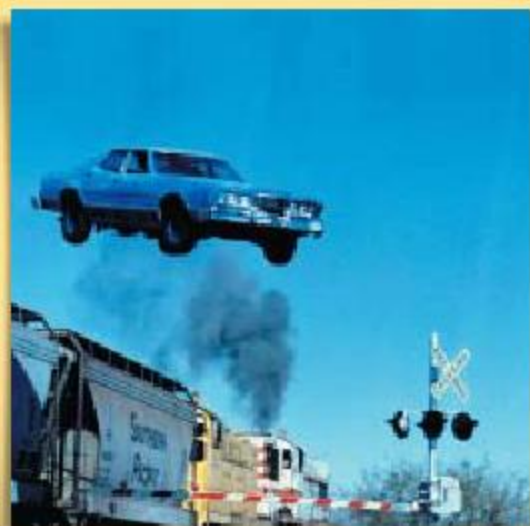

Stunts like this are filmed live using specially trained stuntmen.

Models are used to achieve lots of special effects. Often scaled-down replicas are used, since it is easier to film a small model against the desired backgrounds than the real thing, and less dangerous.

You have a number of "special effect" props in your MovieMaker Set, including models of skyscrapers which are perfect for a rampaging creature to crush, or for a giant dinosaur foot to stamp down on.

Masks

Another special effect you have installed in your software is the "mask". This is a shape that is cut out and placed over the scene. If your villain is looking through a keyhole, for example, a keyhole shape can be placed over the frames. It will look like the camera is looking through the keyhole. If your hero is a spy who is looking through a pair of binoculars, a binocular shape is cut out and put over the scene. There are also masks that make it look like it's raining. I've already made these and other masks for you – try them out; they're stored as pictures on the Edit Screen. Have a look through the masks and play around with the effects. Can't find the right mask? You can make others using a simple graphics program – check out the tips and tricks in the software for instructions on how to do this.

This is what the rain mask looks like on the screen.

Try It

Morphing is cool! Here's how to do it!

- Go to the Film Screen. Attach the LEGO stuntman to a baseplate and film him for a few seconds.
- Stop shooting, remove him and put the actress in exactly the same place. Film her for the same amount of time. Your camera must not move.
- Go to the Edit Screen. Join the two shots together. Find the "dissolve" transition on the Edit Screen and put it between the two shots. Run the movie and watch as your stuntman changes into your actress.



EDITING YOUR MOVIE



A clapperboard is made up of a pair of hinged boards that are clapped together in front of the camera before and after a piece of film has been shot. It's a way to let the cast and crew know when the scene is being shot. At the editing stage, the information written on the boards shows where each shot belongs in the movie.

The editing stage is when you put together the different parts of your movie. It's also your chance to add professional touches to make your movie look magnificent! The process of editing is very simple. You join shot number one to shot number two, and shot number two to shot number three, and so on, until all the shots are joined up.

Editing

The great thing about editing is that if you don't like certain scenes, you can cut them out! And if you don't like the finished movie, you can start over again and retake whatever you want.

All your shots are clearly displayed on the Edit Screen. If the shots are out of sequence, you can use your storyboard as a guide for putting them back in the right order, or refer to your shot list. Sometimes you can get interesting results from editing your shots in a different order. Do not be afraid to experiment during editing – the results might surprise you!



The Edit Screen

TRY IT

- Go to the Edit screen and change the order of your first five shots.
- view the edited shots and see if they improve or change your story in an interesting way
- why not go on and film some extra scenes to link the new order of shots to make up a different storyline?

Take 2

It is important to keep looking at what you have shot on the Edit Screen, just in case there are problems. If you see something wrong in any of your shots, like an actor being too far away or a loose brick lying around, shoot it again. This is called Take 2. Shoot it until you get it right, and don't worry if you have to go to Take 3 or Take 4. Some directors go to hundreds of takes!

Remember, you can use the expanding button to zoom in and view your Edit Screen in more detail. It can help if you are finding the editing a little tricky.

How long is your movie?

The Timeline at the top of the Edit Screen lets you know how long your movie is. The Timeline also tells you the length of each shot that you have edited. This will help you when you edit the sound and the picture together, so that you can add just the right amount of sound effects and background music in the right place.

Phil Maker's Fascinating Film Facts

Mike Todd's movie *Around the World in 80 Days* was shot in 140 different locations throughout the world! Just imagine the tough job of the Editor on that movie!



EDITING THE SOUND

And now it's time for some sound editing. This is going to be fun! Editing the sound for your movie is exactly the same as editing the pictures. You join the end of one sound to the start of another.

Sound effects

There are several sounds that are already provided on the Edit Screen; Sound Effects and Smart Sounds®. You can also record your own sounds to add to the soundtrack.

Music

If you want music playing in your movie, then use the Edit Screen to record directly from your favorite CD on to the Music Track. You can also record live music or sounds through your microphone, read about how to do this in the manual on page 19. For example, you could ask somebody to sing a song. Or you could use a pre-recorded track in the Smart Sounds® library.



Even in noisy scenes such as this, the direct sound is not always loud enough or effective enough and additional effects need to be added at the editing stage.

Phil Maker's Fascinating Film Facts

In moviemaking, the sound recorder on the set concentrates on capturing dialogue rather than sound effects. Often many of the props used are not real so they don't make realistic sounds – tools are made of plastic, marble floors can actually be wood. It is then the job of the foley artist to replace or enhance live sounds to make them sound real and to cover up any accidental background sounds.

What sort of sounds would you add to this animated scene?



Sound adds to the mood of a movie. A horror movie might have scary music and screams on its soundtrack, while an action movie will have loud explosions and a pulsing music beat. A jungle adventure could have a whole range of exotic animal noises. A sad movie might include somber violin music.

Choose music and sounds that will fit your movie. For a comedy, add funny sound effects and silly music to get laughs from your audience. Check out all the sounds available in the software or create your own using a microphone. Don't forget to make background sounds softer when there is dialogue – read the manual, page 21, to find out how to do this.



TRY IT

- Have fun with the sounds and music. You can make the dinosaur bark like a dog by adding a "dog bark" from Sound Effects, or have some music from Smart Sounds play during the scene. Now add some sounds from the edit screen to your movie – try different effects and see what works best.
- Remember that you can use a combination of sound and visual effects to change the pace and mood of the movie. Try shooting a short scene of the stuntman being chased by the dinosaur. Use some music in the background to add speed and tension.
- Think about the pace of the scenes in your film, make notes about this on your script, then try to decide on the type of sounds and music that might work with each scene.

TRANSITIONS AND CREDITS

Add transitions and credits to give your movie a professional polish. But use them wisely: too many different transitions or too much text on screen will make your movie look confusing!

Transitions

Now that you have done your editing, you'll know how simple it is to join one shot to another and move your story forward, shot by shot, scene by scene. Another way to link shots is to use a "transition" – better known to moviemakers as a "fade".

Fades are used in movies to move from one shot to another. You can mix, dissolve through, or fade in and out. The dissolve transition can be used to make one LEGO Mini figure morph into another. There are many other transitions available on the Edit Screen and it is best to experiment with them all during the editing stage. You will be able to create all kinds of weird and surprising effects. Whatever fades you use, try to find a sound effect or music to make them more effective. Transitions can also be used for special effects to make characters disappear.

Phil Maker's Fascinating Film Facts

The longest film title ever was... wait for it... *Night of the Day of the Dawn of the Son of the Bride of the Return of the Revenge of the Terror of the Attack of the Evil, Mutant, Hellbound, Zombified, Flesheating, Sub-Humanoid Living Dead – Part 4* (1993).



Which of these two title fonts works best for a spooky movie? Choose your titles to fit the subject of your movie. Remember, the title is the first thing your audience will see, and it will set the scene for the movie.

Credits

The credits are the words you see written up on the screen at the beginning and end of the movie. The most important credit of all is the title.

The Edit Screen lets you type out your credits in a variety of fonts. Take your time and try out different styles of lettering to see which one fits your movie. Remember, you can change them around as much as you like until they look perfect!

When you edit, the opening titles of your movie will appear over the opening shots. You might want to shoot an opening title sequence for your movie to make it more effective – such as a landscape still, or a picture you've created. Watch the title sequences of your favorite movies to get some ideas for this.

After all their hard work, the cast and crew deserve a mention in the credits. Of course, the director is the most important person on the set, so his or her name goes first! Next comes the cast list – the actors who starred in the movie. The crew credits often come at the end, so that the audience can appreciate the work of everyone involved. You can also use credits to thank other people who have helped you.

When you have edited your front and end credits and added the all-important "The End" caption, your movie is finally complete. It's a wrap!

Use the credits to say "thank you" to the people who helped you make your movie!

Try It

- Type out the opening credits for your movie, choose a fun font and edit the credits into your movie, with a transition between each one. Choose a dramatic fanfare of music to accompany them. Now try making your credits roll down.
- Try out different fonts and backgrounds, then pick the one that fits your movie best!
- Remember that text can be used for other things, too. It can set the scene at the start of the movie, or translate dialogue in a foreign language. Look through your script, and see if you can use either of these effects in your movie. Then make a note in your script of the text you want to add.



SCREENING YOUR MOVIE

You've done it! You've made your first movie! This is your big moment! It is time to show your masterpiece to the world! Why not hold a grand premiere? Screen your movie to an invited audience of the stars, the crew and your family and friends. You could even make special souvenir invitations, programs and tickets, so that your guests have a reminder to take home with them!



Phil Maker's Fascinating Film Facts

The largest audience to attend a world premiere was the 23,930 people who went to see the Robert Altman film *Brewster McCloud* on December 5, 1970.

Show your movie

Make sure everyone has a good view of the screen. Create the atmosphere of a real movie theater at home. Provide popcorn and soft drinks for everybody and then show them to their seats. Dim the lights and click on the Show Movie button. Enjoy the show!

You can also access an e-mail site through the LEGO & Steven Spielberg MovieMaker Set that lets you send your movie to an even bigger audience, both at home and abroad. Once you have done this, your movie could be an international hit. See page 23 of the Manual for more information about the LEGO Studios website and e-mailing movies.

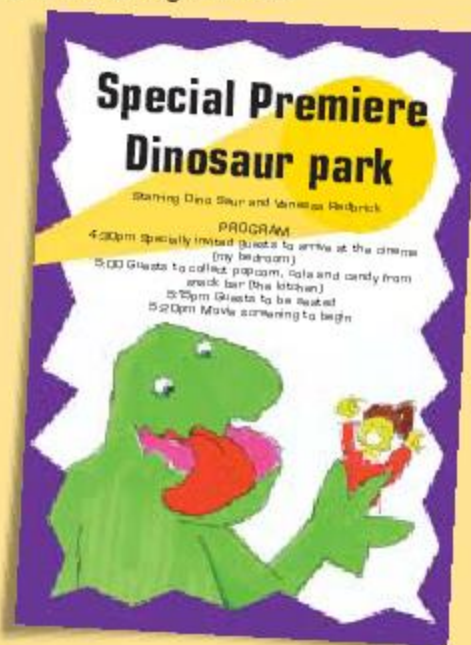

WHAT NEXT?

Your first movie was a big success. The audience loved it. Now it's time to move on to your next project.

Subject

Your first job is to pick a subject. Will it be a mission to Mars or an Arctic adventure, a thriller or a fairy tale? Will it be set in outer space or in your own bedroom, or in an imaginary location? Who will be the stars? You decide! Be more ambitious this time, use different effects and a wider variety of shots (get inspired by the Masterclass sections at the end of this book).

Location

You have a wide range of LEGO locations to choose from. As far as the cast, you can start with the big selection of LEGO Mini figures, as well as other real life stars among your friends and family! Take your time – write your script, draw your storyboard, plan your shots, and create your sets and locations. Then let the fun begin all over again!

The LEGO Studios website

Don't forget to log on to the LEGO & Steven Spielberg MovieMaker Set website where you can watch other people's LEGO movies, and get lots more cool hints and tips! You can access the website directly by clicking on the www button on the Show Screen, or from the start menu in your software.

Happy shooting!



There are so many characters to choose from if you're making a LEGO movie!



You can set your movie under water.



Or, how about using a city setting?



MASTERCLASS I



ADDITIONAL SOUND EFFECTS FOR YOU TO CREATE

Create your very own sound library. Record the following sounds and any others you can think of for use in your moviemaking! Don't forget to make a note of what the sounds are and the order in which you have recorded them.

Sound	What you need	How to create it
Rain	Rice and cookie sheet	Sprinkle the rice on to the cookie sheet.
Crackling fire	Cellophane	Crumple the cellophane.
Bumps and thumps	Old telephone book	Punch it or stamp on it.
Screech	Balloon	Blow up the balloon, then slowly let the air escape as you stretch the sides of the neck of the balloon.
Footsteps	A pair of shoes	Hold a shoe in each hand by the top. Hit the bottom of the heels together first, then the toes to sound like walking footsteps.
Leaves in trees	A paper bag/newspaper	Gently rustle the paper.
Galloping horse	Two clean and empty yogurt containers	Click down on a hard surface with the yogurt containers to the rhythm of a horse galloping slowly.
Underwater noises	A glass of water and a straw	Place the straw into the water and blow gently.
Breaking wood	Styrofoam plate	Break the plate.
Waterfall	A faucet	Let the water run, but don't forget to switch it off when you've finished.
Train whistle	Empty bottle	Put your bottom lip against the bottle and blow into it gently.

MASTERCLASS 2

ADDITIONAL ANIMATION EFFECTS FOR YOU TO CREATE

You can make your LEGO Mini figures express moods and feelings using stop motion animation! Try these suggestions and make up some others of your own!

Happy

Animation: Animate your Mini figure jumping up and down with joy, with their arms raised up.

Sound: Fast, upbeat music.

Surprised

Animation: Animate your Mini figure jumping back in shock. If they are wearing a hat, make it leap off their head as they jump back.

Shot: Close-up as the Mini figure jumps back, then turn the camera to show what has surprised them.

Sound: Scream.

In love

Animation/Shot: Close in to middle of Mini figure's chest and cut to an animation of a beating heart made of red modeling clay.

Sound: Romantic music.

Angry

Animation: Mini figure waving their fist.

Shot: Zoom in on the Mini figure.

Sound: Growling.

Frightened/cold

Animation: Repeated shots of the Mini figure shaking from side to side.

Shot: Move the camera gently from side to side.

Sound: The sound of chattering teeth can be created by tapping the back of a pen on a hard surface.

MASTERCLASS 3

CREATING ATMOSPHERE USING LIGHTING

Dark and moody or sunny and cheerful? Create atmosphere with some of these lighting effects:

- A red filter on a flashlight can give the effect of flames or fire.
- A blue filter in front of a flashing light creates the effect of a police car.
- A light blue filter could be used to make an underwater effect – don't forget to add some water noises, too!
- Use a yellow filter to "create" sunlight.
- Draw attention to the star of the show by putting them in the spotlight; just shine your flashlight directly on them as you shoot!
- Want to add a little mystery to the scene? Suppose you are about to reveal the villain for the first time. You could shoot a wide shot of a shadowy scene and pan over to the mysterious evil figure coming out of the shadows.
- Bright light behind a character can make a figure look angelic.
- Shine a flashlight up and under a character's face to make them look sinister.



MASTERCLASS 4

ADDITIONAL EFFECTS USING DIFFERENT CAMERA SHOTS

The LEGO PC Movie Camera is very flexible and can be placed at any angle. Try some of these effects to give your movie a really professional touch:

- To make a character look powerful, try shooting with the camera looking up from below. Try filming your hero in this way.
- To make a character look threatening, you shoot him from a low angle, with the camera looking up from below. This is a great shot to use for your villain as he carries out his nasty deeds.
- A camera that looks down from high up makes an actor appear small and threatened. This is a great shot to use when a weaker character is confronted by the villain.
- You can create the effect of an earthquake or a spaceship crash. Just use the plastic stalks to move your LEGO Mini figures from side to side in live action and knock over props on the set. You can also gently wobble the camera as you shoot.
- Try filming a toy car as it races past. Shoot the scene again, this time with your camera mounted on the car, then shoot it again from the side. Go to the Edit Screen and alternate between little bits of each shot. This adds pace and excitement to the scene.
- You can build up suspense before revealing an important shot. Imagine someone has been knocking at the door and it begins to open. Pan slowly around the room and even more slowly across the door before revealing the mystery person entering the room.



IDEAS SHEET

My "what if?" idea:

Hero:

Villain:

Secondary Characters:

Locations needed:

The "struggles" that the hero needs to go through:

What happens at the end?

OTHER STORY IDEAS



STORYBOARD SHEET



Make a drawing in each box to show what will happen in each scene. Write in any sound effects in the line above the box. Write the dialogue on the lines below and any additional notes that might be helpful. Photocopy this page as many times as you'd like to create new stories!

sound effects: _____

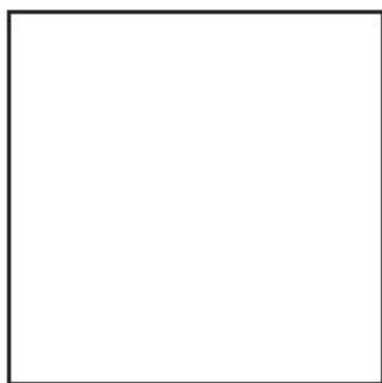

dialogue: _____

background/location notes: _____

sound effects: _____

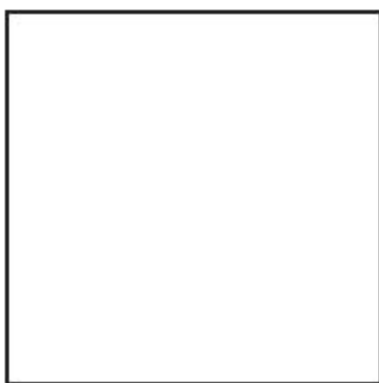

dialogue: _____

background/location notes: _____

sound effects: _____

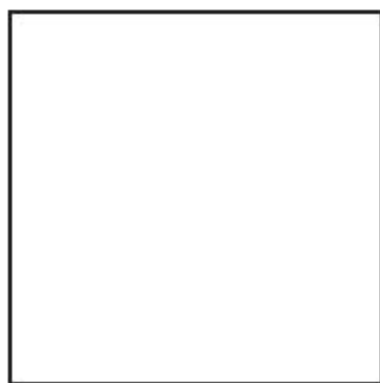

dialogue: _____

background/location notes: _____

sound effects: _____

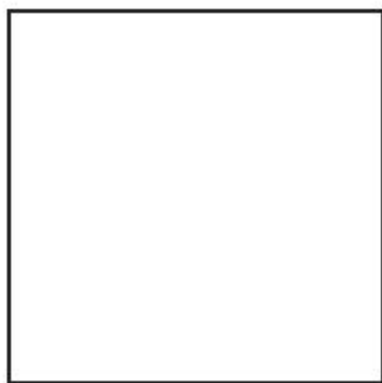

dialogue: _____

background/location notes: _____

sound effects: _____

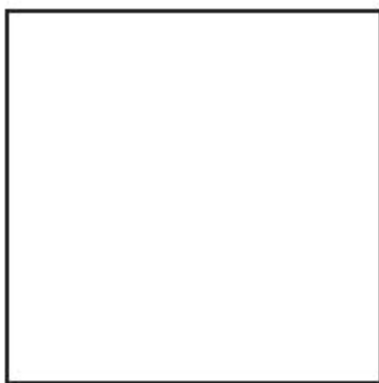

dialogue: _____

background/location notes: _____

sound effects: _____

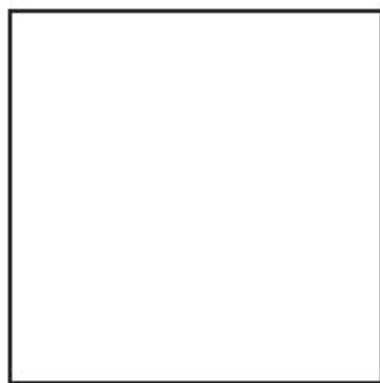

dialogue: _____

background/location notes: _____

OTHER STORY IDEAS



LEGO**STUDIOS**

LEGO STUDIOS SETS



Movie Backdrop Studio

1351

With the rotating backdrop on this cool set, you can film a high speed chase, as the car and police helicopter speed past the skyscrapers.

Explosion Studio

1352

This bank robbery set is especially designed to come apart and explode! Build whatever you want from your LEGO collection and try using this set to make it "blow up" on screen.



Car Stunt Studio

1353

Crazy about car stunts? When you build this set, your hero can race over an exploding bridge and fly through the air.



Dino Head Attack

1354

For a thrilling close-up, build this giant, snapping T-Rex head with jaws that you can open and close. Watch out - someone looks hungry!



Temple of Gloom

1355

Just what every good adventure needs - a trapdoor! But will it lead to a hidden passage, or a scary secret chamber? You're the director, so it's your call.



Stunt Man Catapult

1356

Your stuntman has nothing to fear. This special set will catapult him through the flames without burning a single hair. You can use the catapult to create more daredevil stunts - have a fling!



Cameraman

1357

This extra cameraman will come in handy when you are shooting a big blockbuster.



HOW TO USE YOUR LEGO PC MOVIE CAMERA ON THE INTERNET

Not only can you use your LEGO PC Movie Camera to make fantastic movies - you can also use it on the Internet! You can use your camera to have "face-to-face" conversations with friends, family, or even other budding LEGO movie directors around the globe.

A number of companies provide free software that you can use to communicate on the Internet. You can find audio and video clips, swap ideas, share information, and send and receive real-time video on the Internet.

You can get more information and instructions for downloading free software at:

<http://www.lego.com/studios>

...the ...

...the ...

...the ...

...the ...

...the ...

...the ...

...the ...

...the ...

...the ...

...the ...

...the ...

...the ...

...the ...

...the ...

...the ...

...the ...

...the ...

...the ...

LEGO STUDIOS

1349



4130016

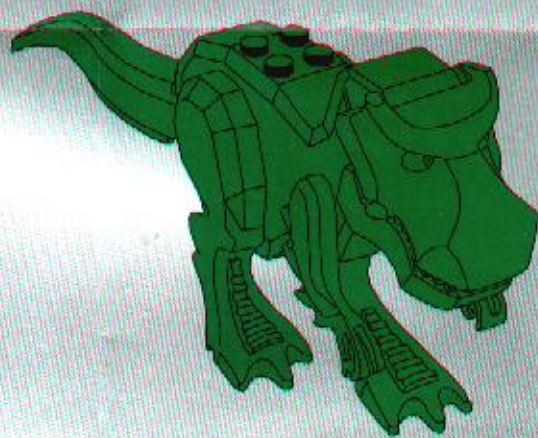
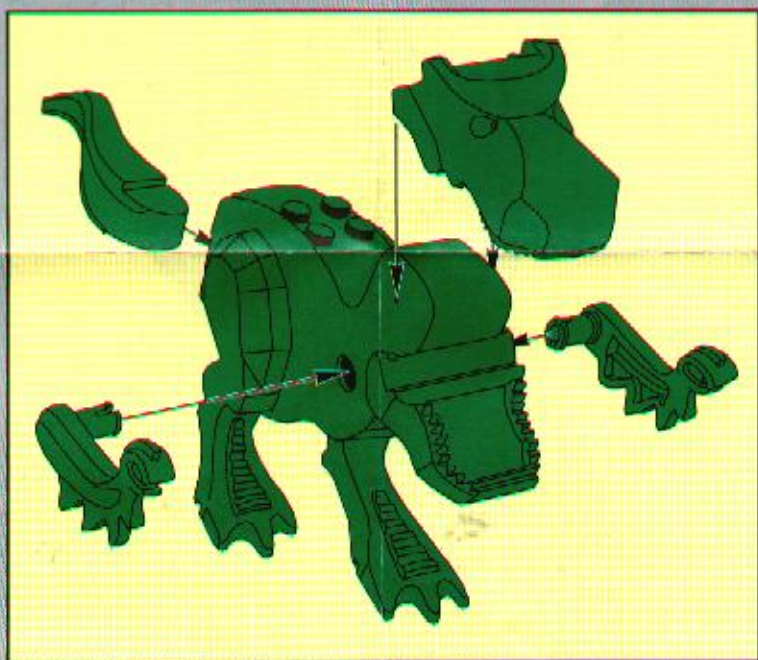

1



2



3

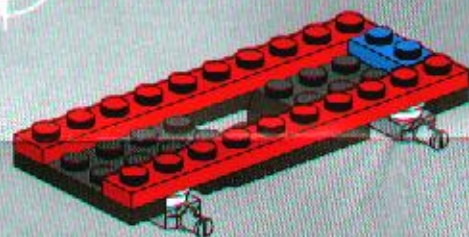

4

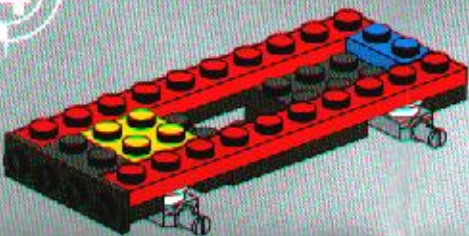

5

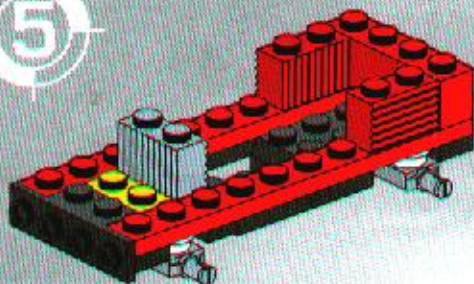

6

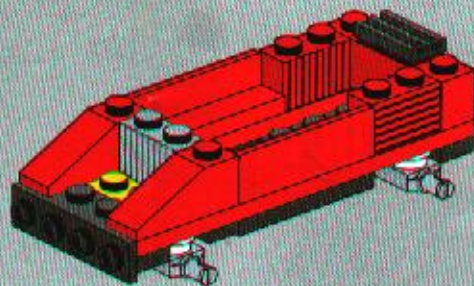

7

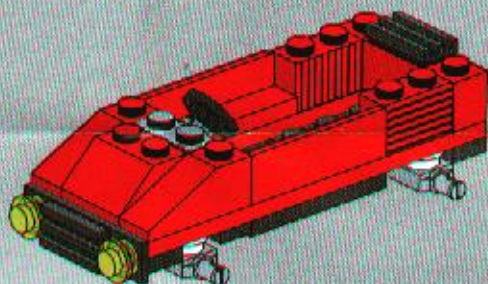

8

