

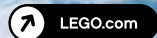

STAR WARS™

75138



EN IMPORTANT: Never modify the elements or use other projectiles than provided with this toy.
DE WICHTIG: Die Elemente dürfen nicht verändert werden. Es dürfen ausschließlich die mit dem Spielzeug mitgelieferten Geschosse verwendet werden.
FR IMPORTANT : Ne jamais modifier les éléments ni utiliser d'autres projectiles que ceux fournis avec ce jouet.
IT IMPORTANTE: non modificare gli elementi o utilizzare proiettili non forniti con questo prodotto.
NL BELANGRIJK: Verander niets aan de elementen en gebruik geen andere projectielen dan de bij het speelgoed geleverde.
ES IMPORTANTE: No modifique los elementos ni utilice otros proyectiles diferentes a los suministrados junto con este juguete.
DA VIGTIGT: Elementerne må ikke ændres, og der må ikke bruges andre projektiler end dem, der følger med legetøjet.
IS MIKLIVÆGT: Aldrei skal breyta einungum vörunnar eða nota önnur skot en þau sem fylgja þessu leikfangi.
FI TÄRKEÄÄ: Älä koskaan tee osiin muutoksia tai käytä lelussa muita kuin sen sisältämiä ammuksia.
SV VIKTIGT: Modifiera aldrig delarna och använd aldrig andra projektiler än de som medföljer denna leksak.
NO VIKTIG: Elementene må ikke endres, og det må aldri brukes andre prosjektiler enn dem som følger med leketøyet.
PT IMPORTANTE: Nunca modifique os elementos nem utilize projécteis que não tenham sido fornecidos com este brinquedo.
EL ΣΗΜΑΝΤΙΚΟ: Ποτέ μην τροποποιείτε τα στοιχεία του παιχνιδιού και μην χρησιμοποιείτε άλλα βλήματα εκτός από αυτά που συνοδεύουν αυτό το παιχνίδι.
JA 重要: 部品を改造したり、本製品に付属の発射体以外のものを使用しないようにしてください。
ZH 重要提示: 切勿更改组件或使用非由本玩具附带的弹丸。
KO 중요: 이들 부품을 수정하거나 이 완구와 함께 제공된 것이 아닌 발사체는 결코 사용하지 마십시오.
RU ВАЖНО: Запрещается вносить изменения в элементы или использовать другие снаряды, отличные от тех, которые поставляются с данной игрушкой.
PL WAŻNE: Nigdy nie modyfikować elementów ani nie używać innych pocisków niż dostarczonych z zabawką.
CZ UPOZORNĚNÍ: Nikdy neupravujte součástky a nepoužívejte jiné projektily než ty, které jsou dodávány s touto hračkou.
SK UPOZORNENIE: Nikdy neupravujte súčastičky a nepoužívajte iné projektily než tie, ktoré sú dodávané s touto hračkou.
HU FONTOS: Az elemeket nem szabad módosítani, és a játékhöz adott lövedékek helyett sem szabad másat használni.
UA УВАГА: Ніколи не модифікуйте елементи. Використовуйте тільки снаряди, що входять у комплект цієї іграшки.
HR VAŽNO: Nemojte nikad mijenjati elemente ili koristiti druge projektilne osim onih koji bili priloženi uz ovu igračku prilikom kupnje.
SR ВАЖНО: Немојте да модификујете елементе и не користите друге пројектиле осим оних који долазе уз ову играчку.
MK ВАЖНО: Никогаш не менувајте ги елементите и не користете други пројектили од тие што ви се дадени со играчката.
SL POMEMBNO: Nikoli ne spreminjajte elementov in uporabljajte le izstrelke, ki so bili priloženi tej igrački.
RO IMPORTANT: Nu modificați nicodată elementele și nu utilizați alte proiectile decât cele furnizate cu această jucărie.
BG ВАЖНО: В никакъв случай не видоизменяйте елементите и не използвайте други снаряди освен предоставените с тази играчка.
LV SVARĪGI: Nekad nepārveidojiet rotālietas elementus, vienmēr izmantojiet tikai tās komplektā iekļautās lodītes.
ET OLULINE: Mänguasja osi ei tohi teistega asendada, kasutada võib ainult kaasasolevat heitkeha.
LT SVARBU: Niekuomet nekeiskite elementų ir naudokite tik tuos šovinius, kurie yra pridėti prie šio žaislo.
TR ÖNEMLİ: Hiçbir zaman parçalarda değişiklik yapmayın veya bu oyuncakla verilenler dışında fırlatıcılar kullanmayın.
AR ملاحظة مهمة: تجنب تعديل العناصر أو استخدام مقذوفات أخرى خلاف الرفقة مع هذه اللعبة.
ID PENTING: Jangan pernah memodifikasi elemen atau menggunakan pelat lain selain yang disediakan bersama mainan ini.
MS PENTING: Jangan ubah suai elemen atau guna peluncur lain selain daripada yang disediakan untuk alat mainan ini.

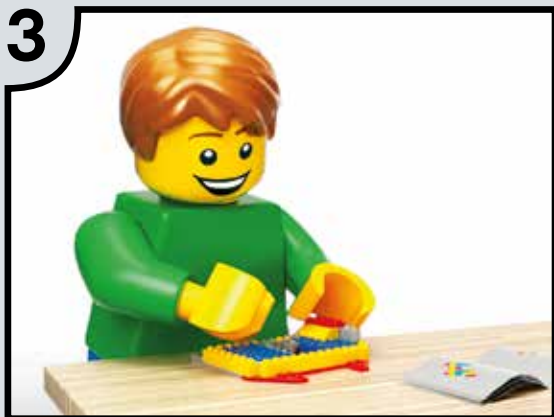
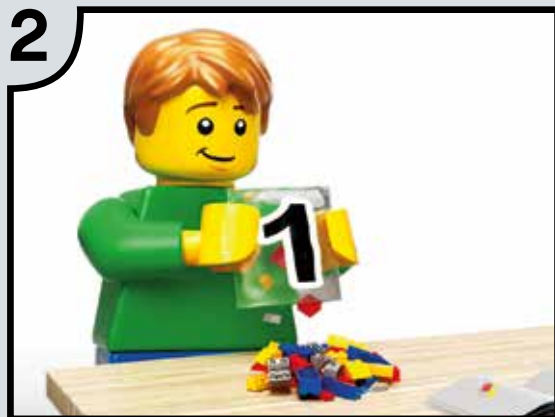

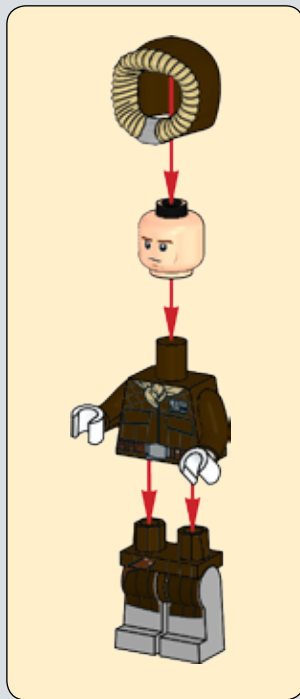
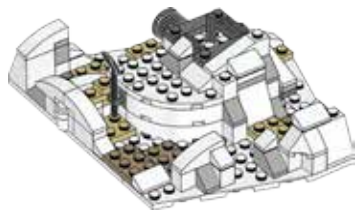



1x



1x

1

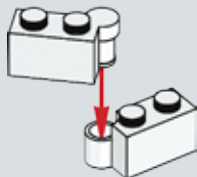

1x

2

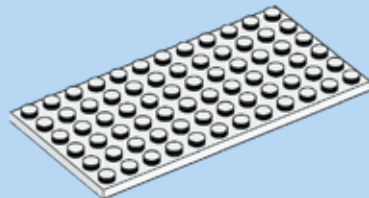
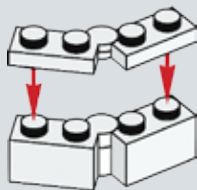

1x

3

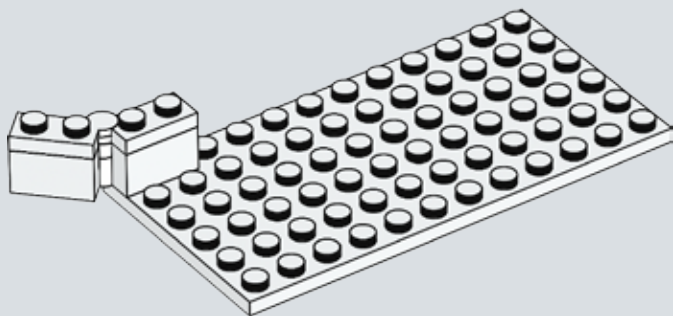

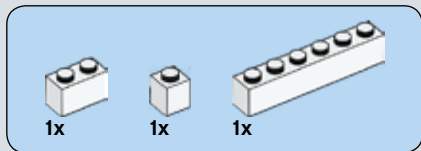

4

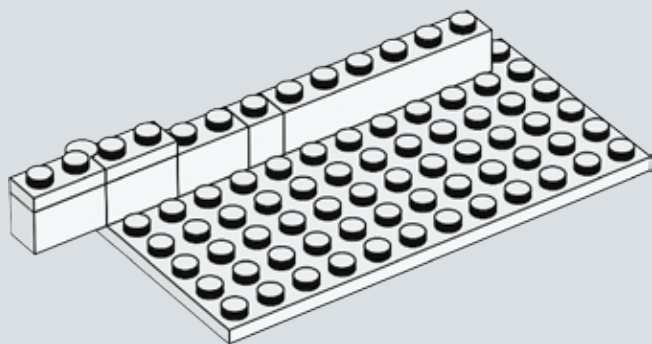

6



5

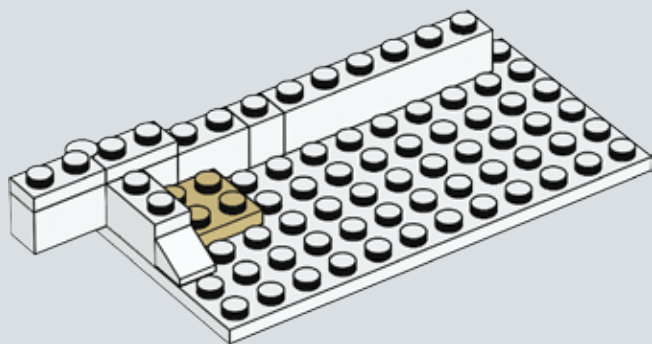



2x



1x

6

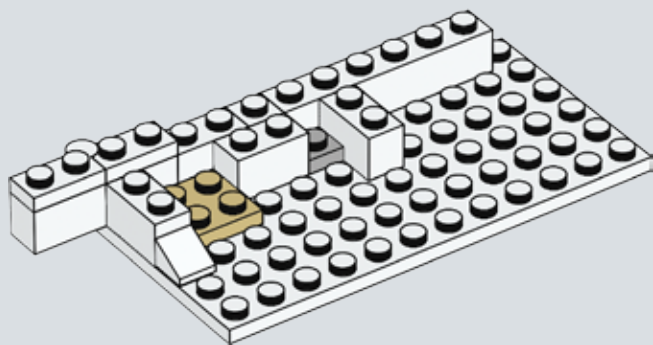

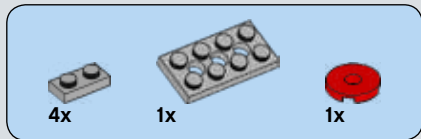

7

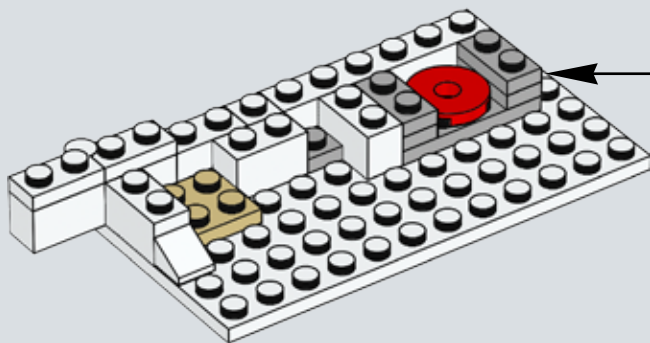

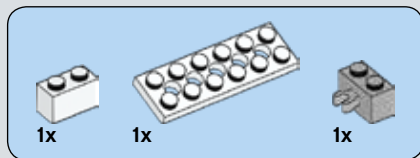

8

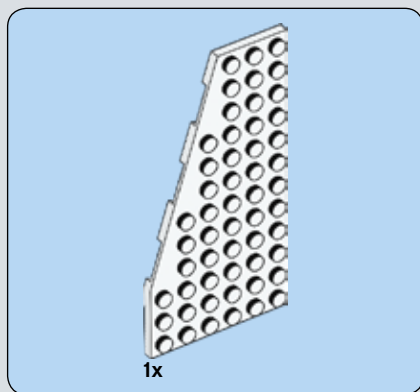
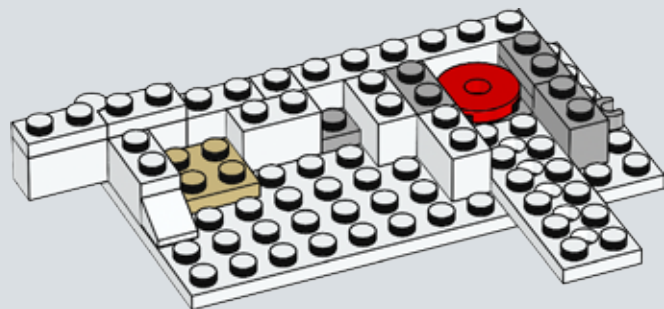

9

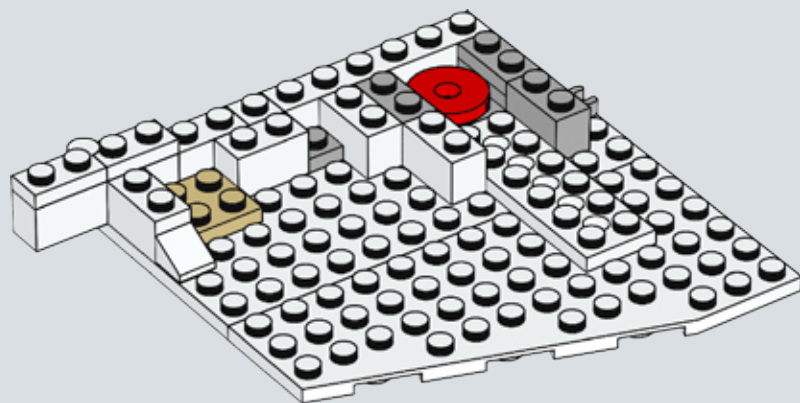

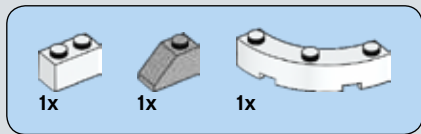

10

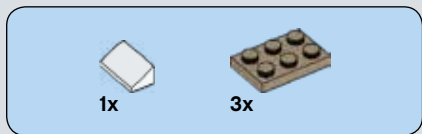
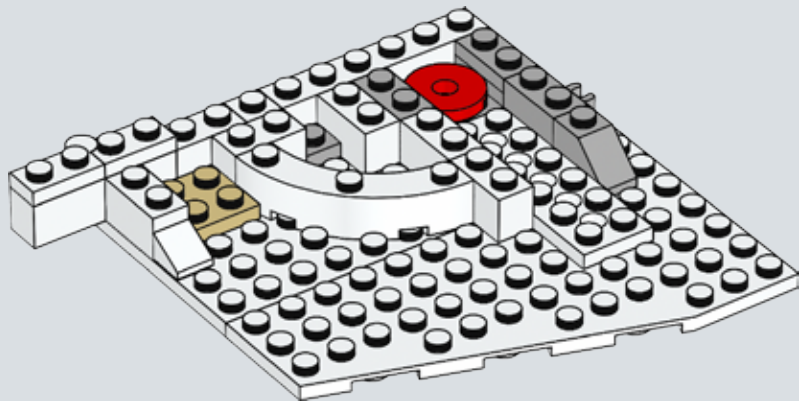

11

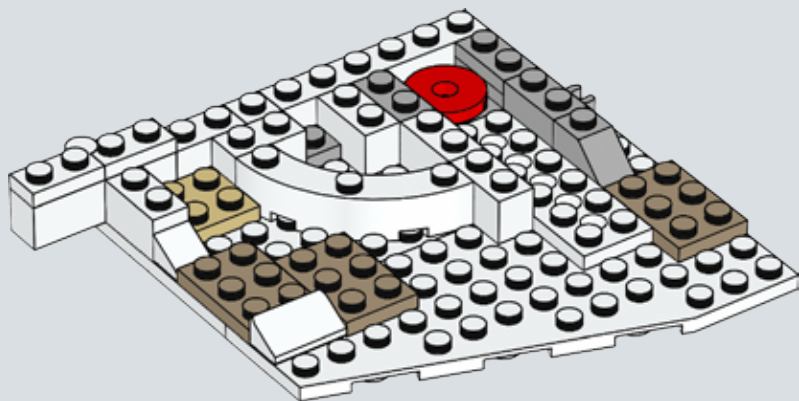

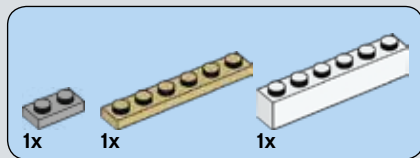

12

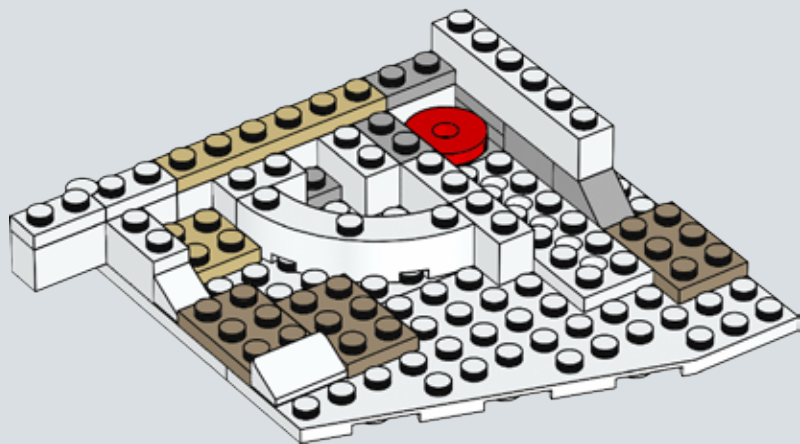



1x



2x



1x



1x

13

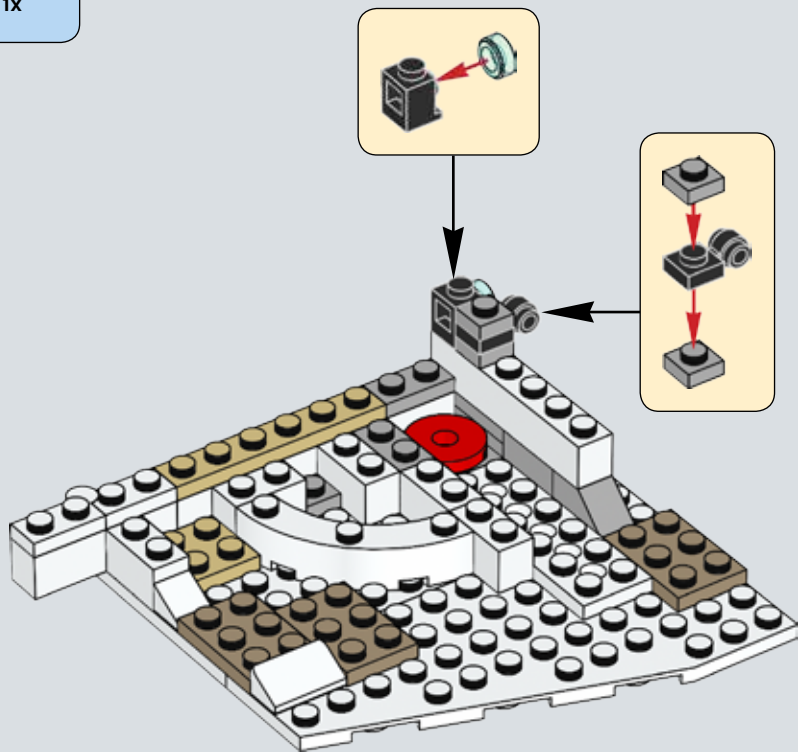



1x



1x

14

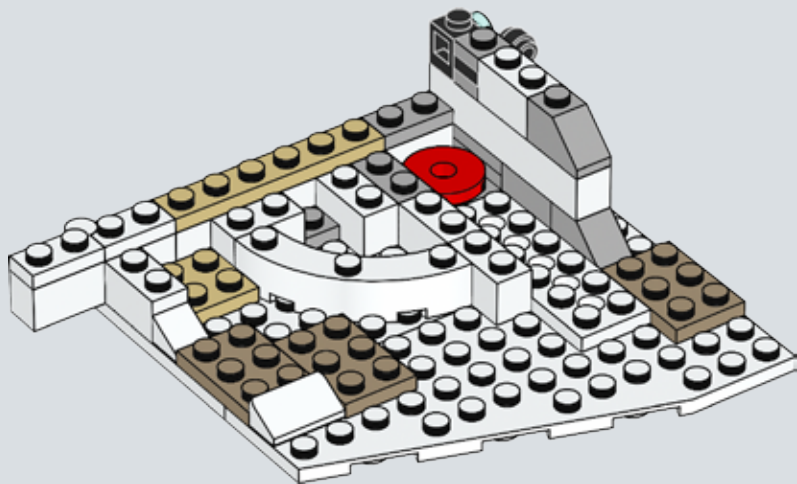

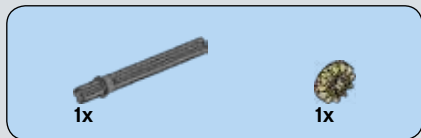

15

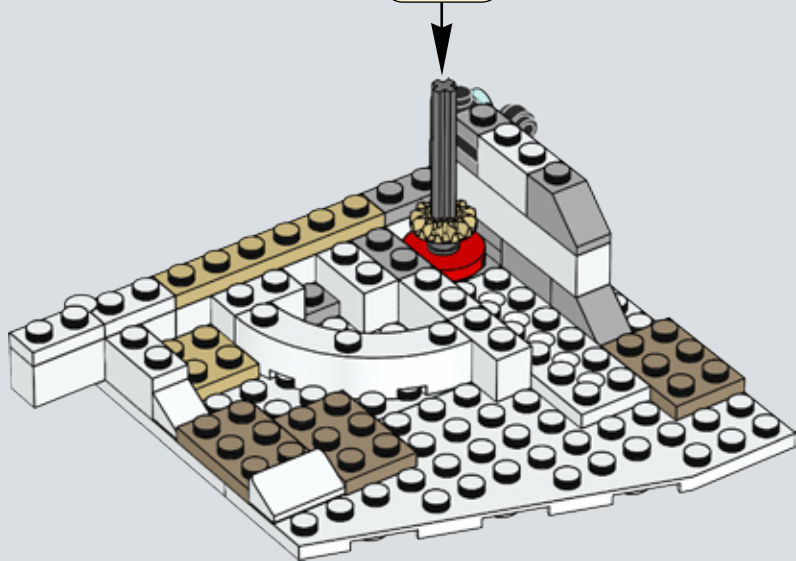
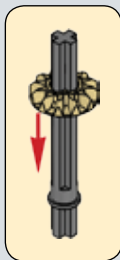



1x



1x



1x



1x



1x

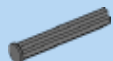

1x



1x

16

1

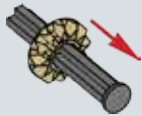

2

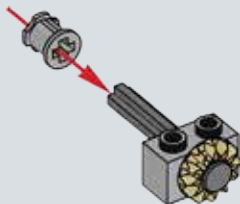

3

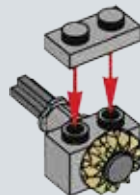

4

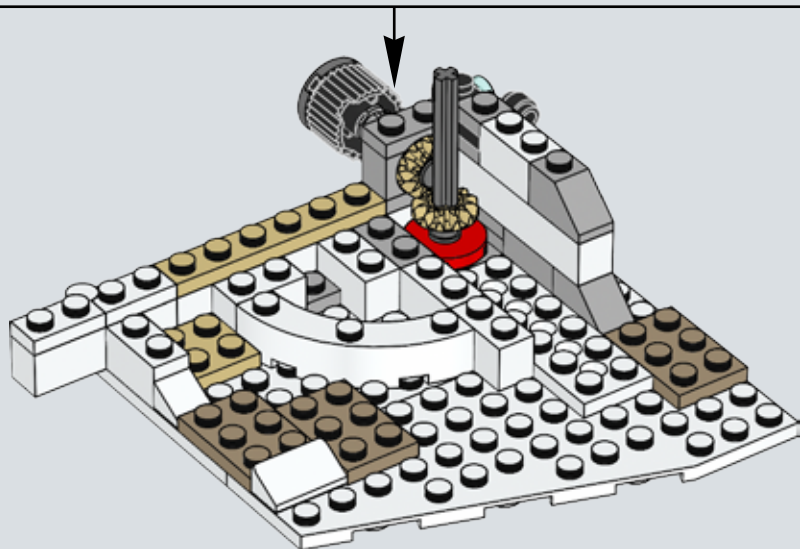
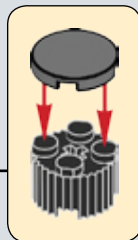
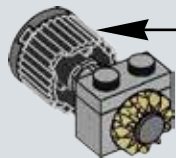

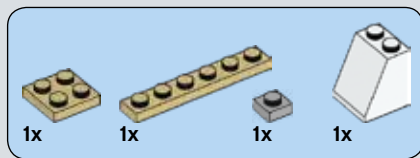

17

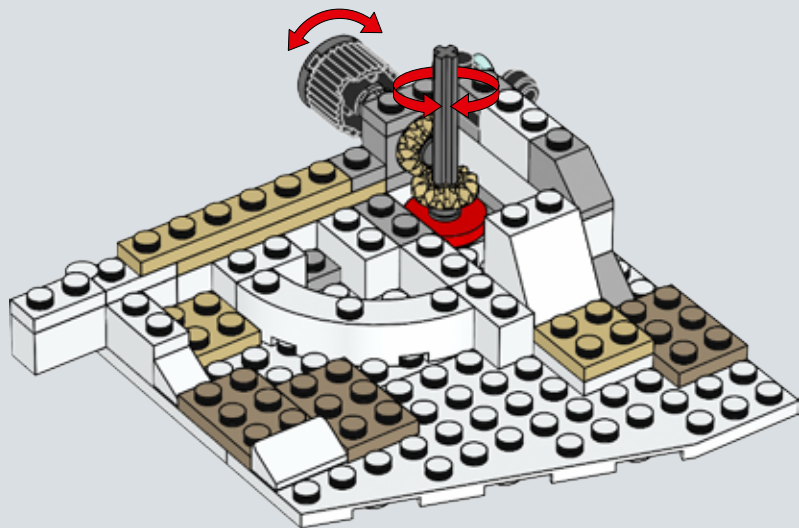

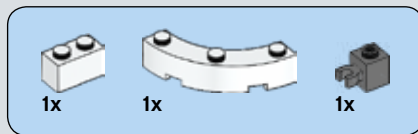

19

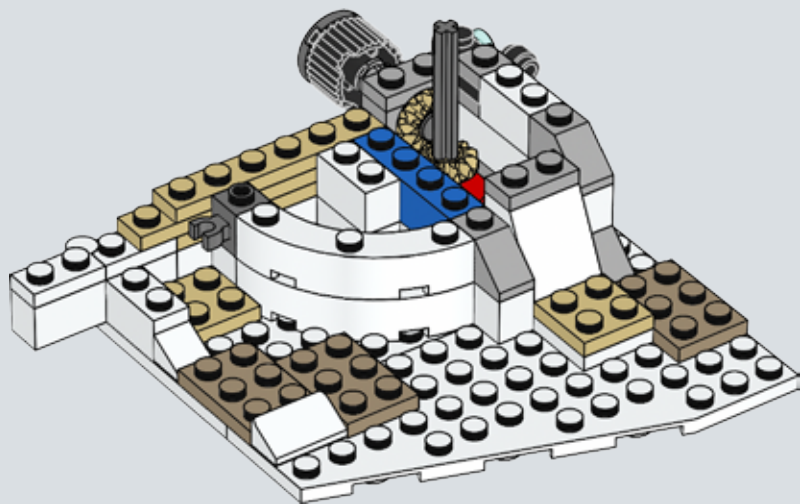

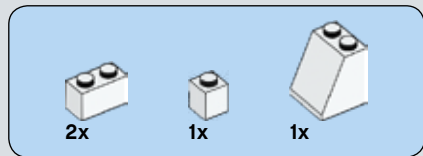

20

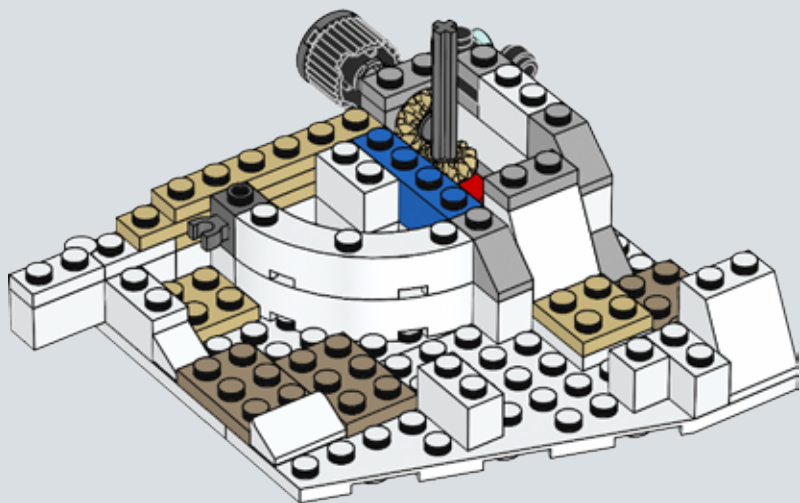

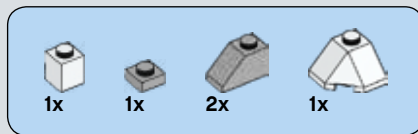

21

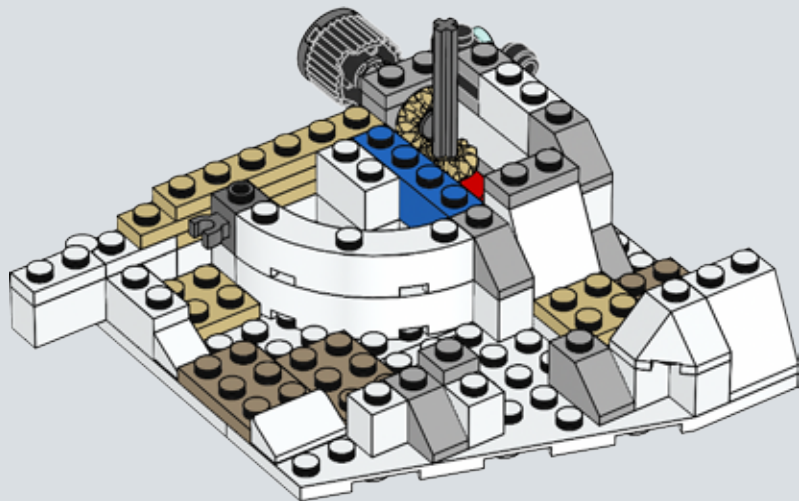



1x



2x



1x

22

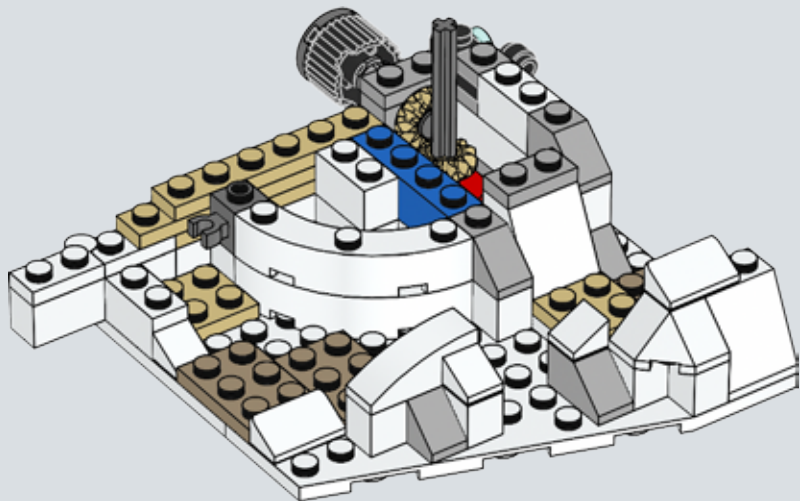

22

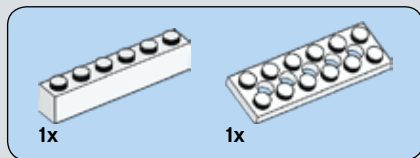

23

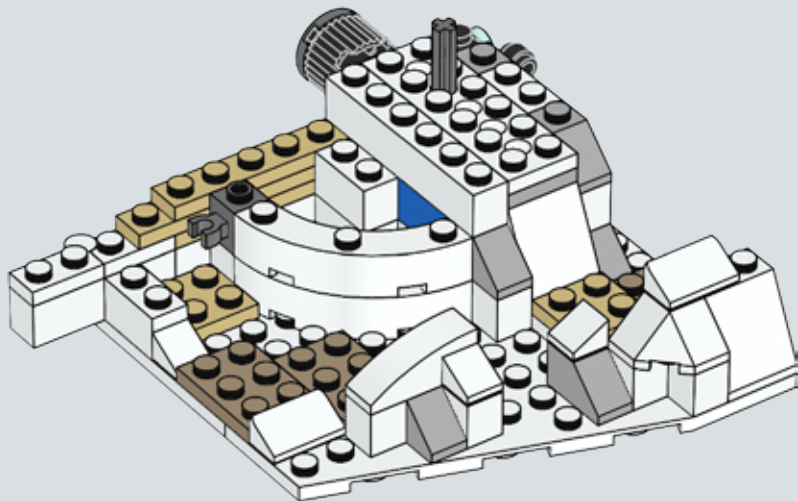

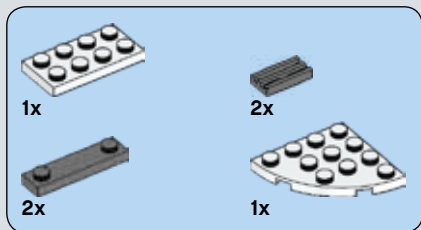

24

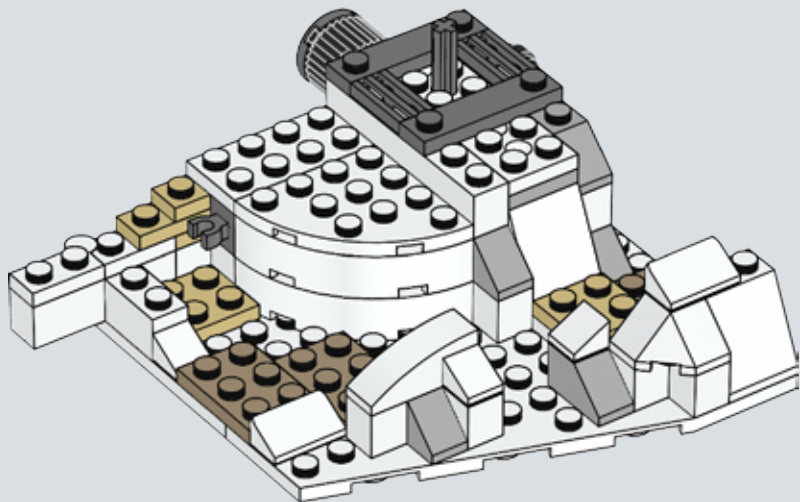



25

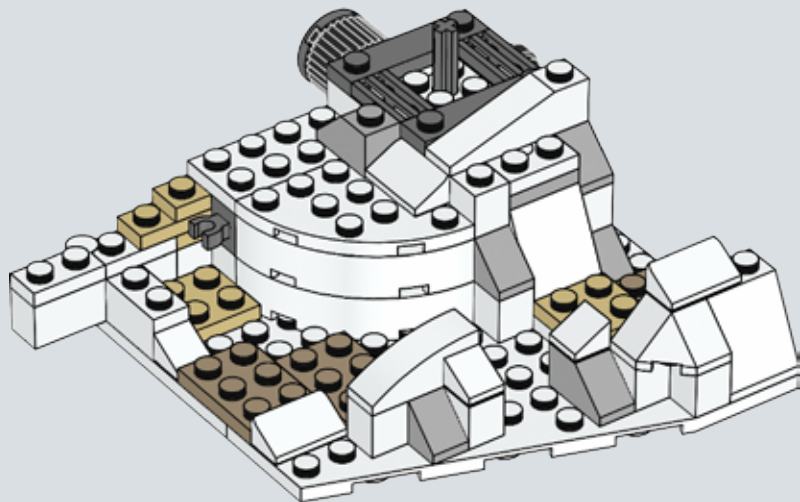



1x



1x



1x

26

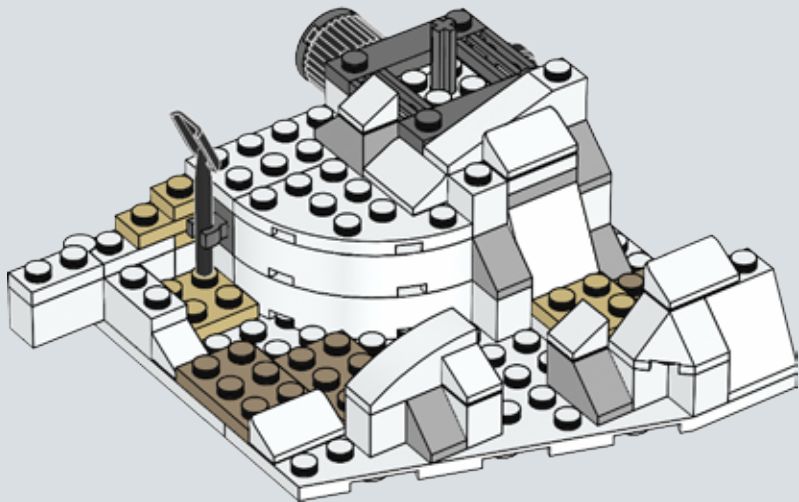

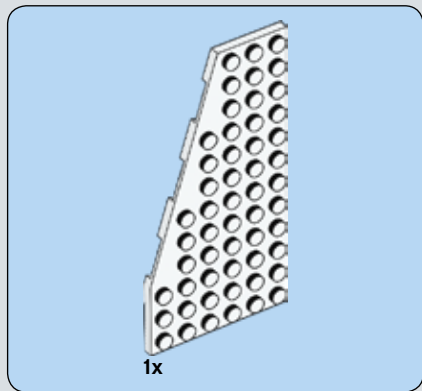

27

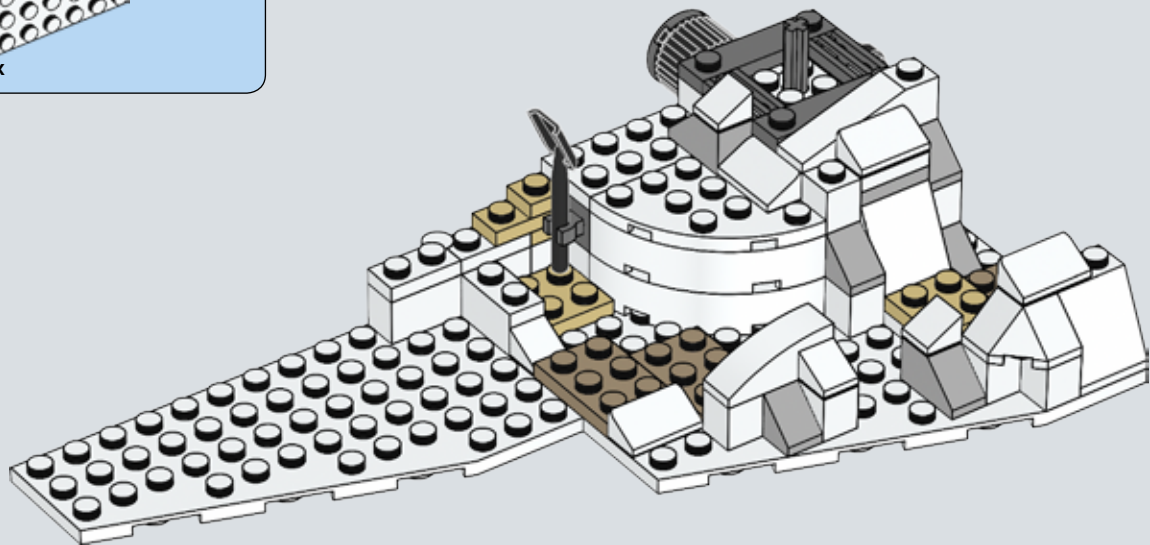



1x



2x



1x

28

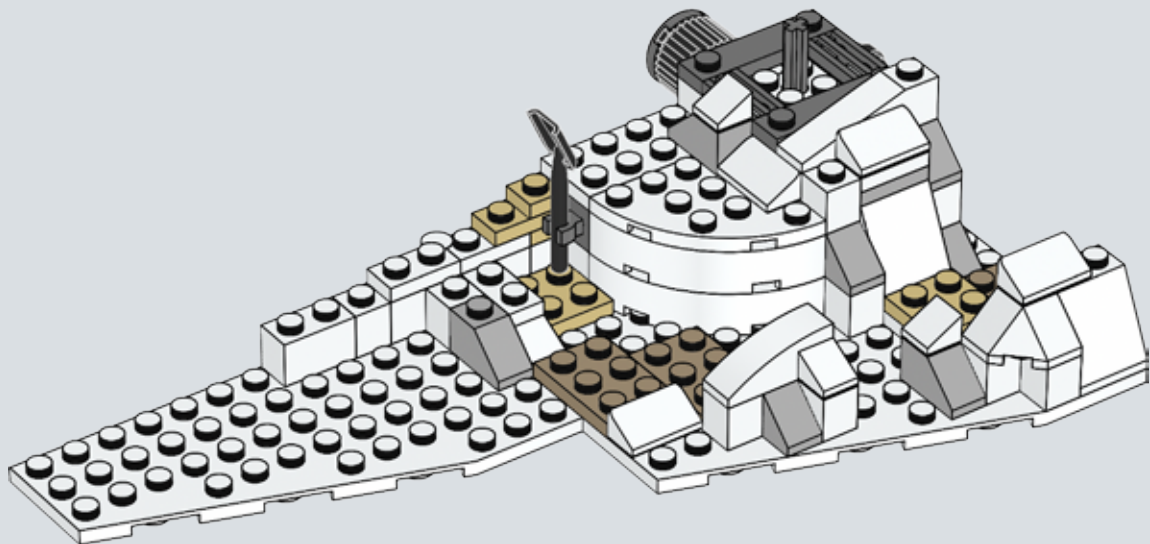



29

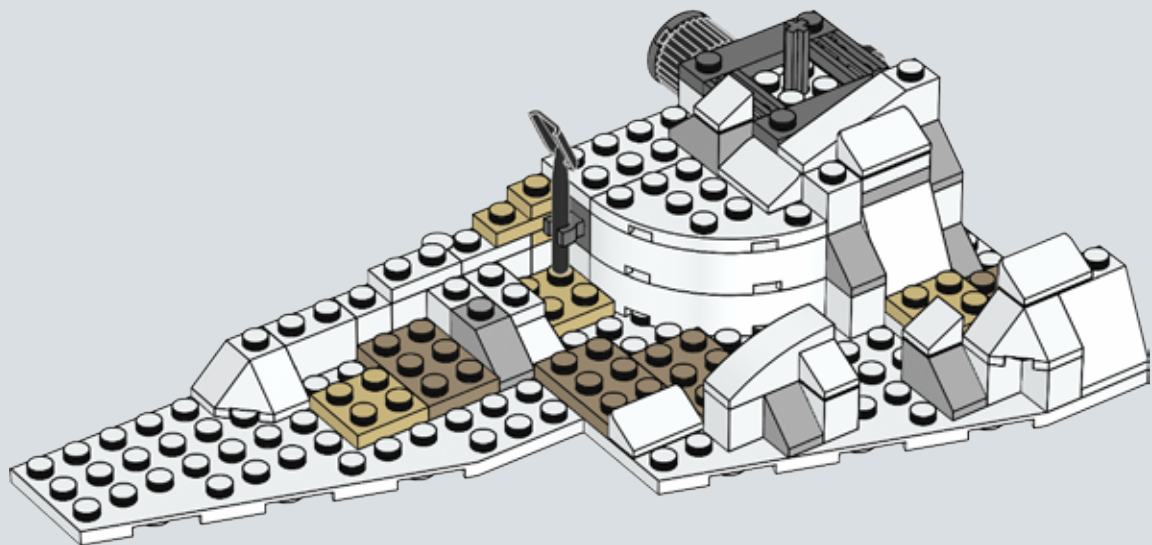



3x



1x

30

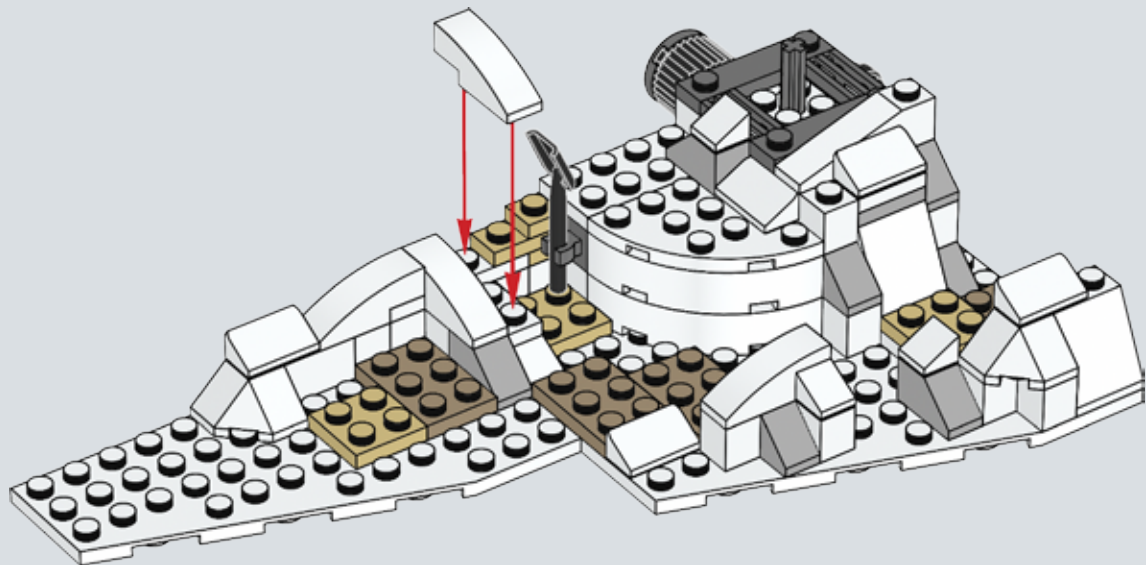



1x



1x

31

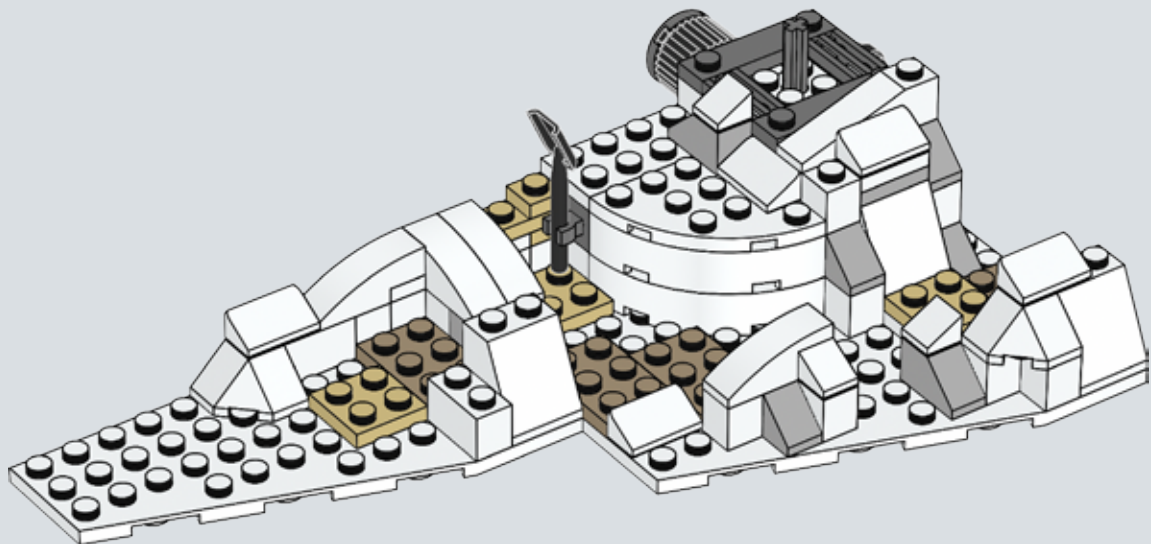



2x

32

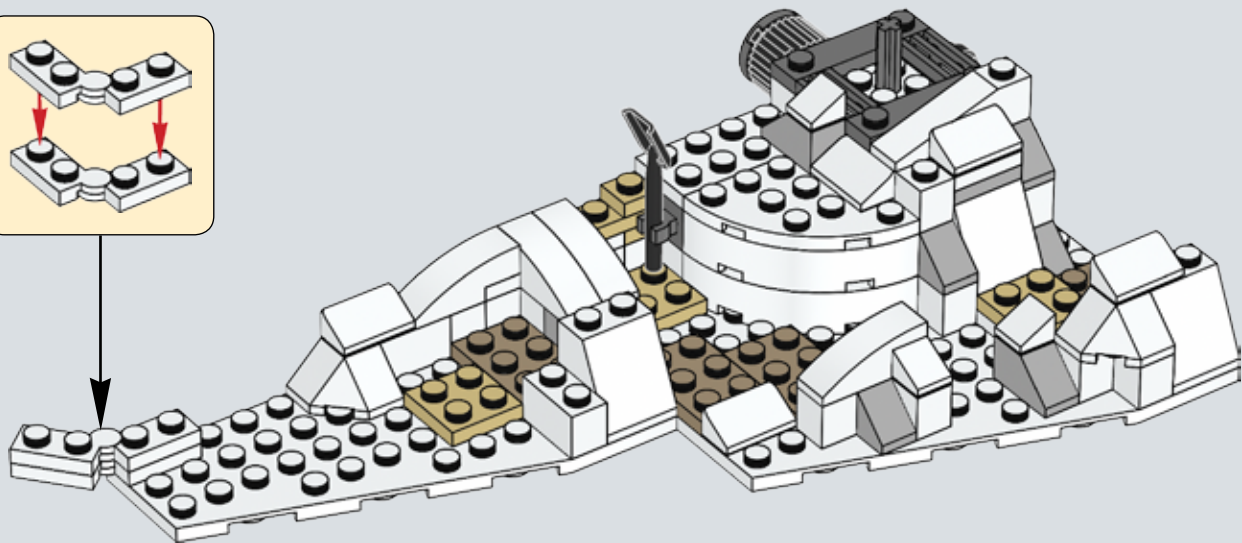
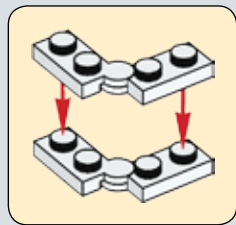

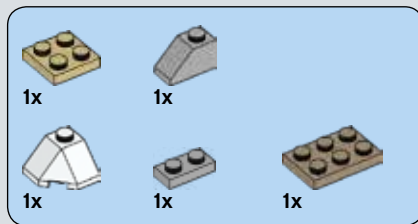

33

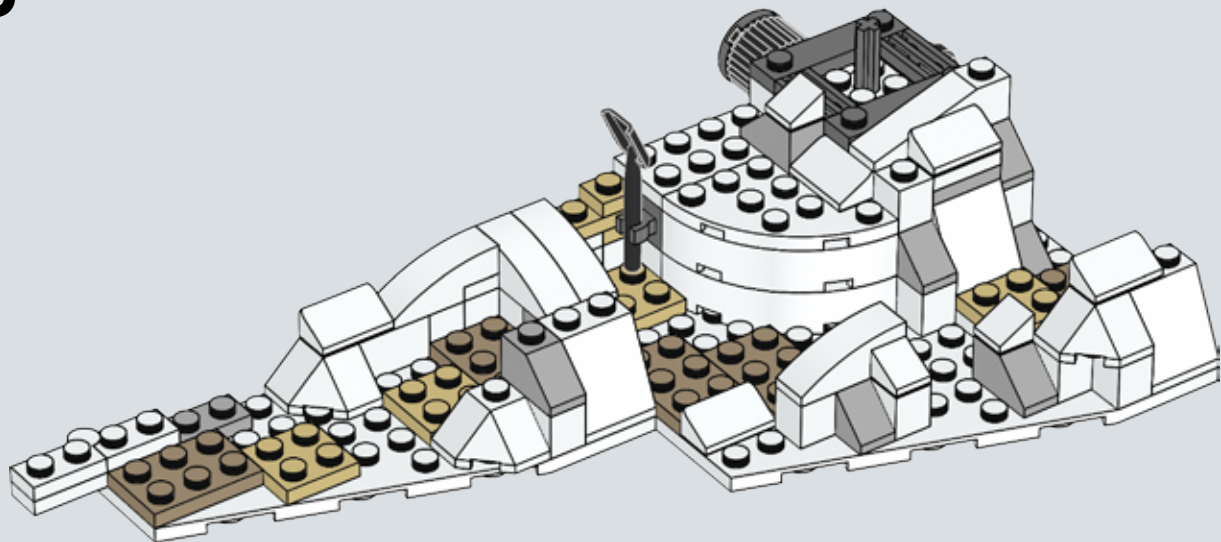



1x



1x

34

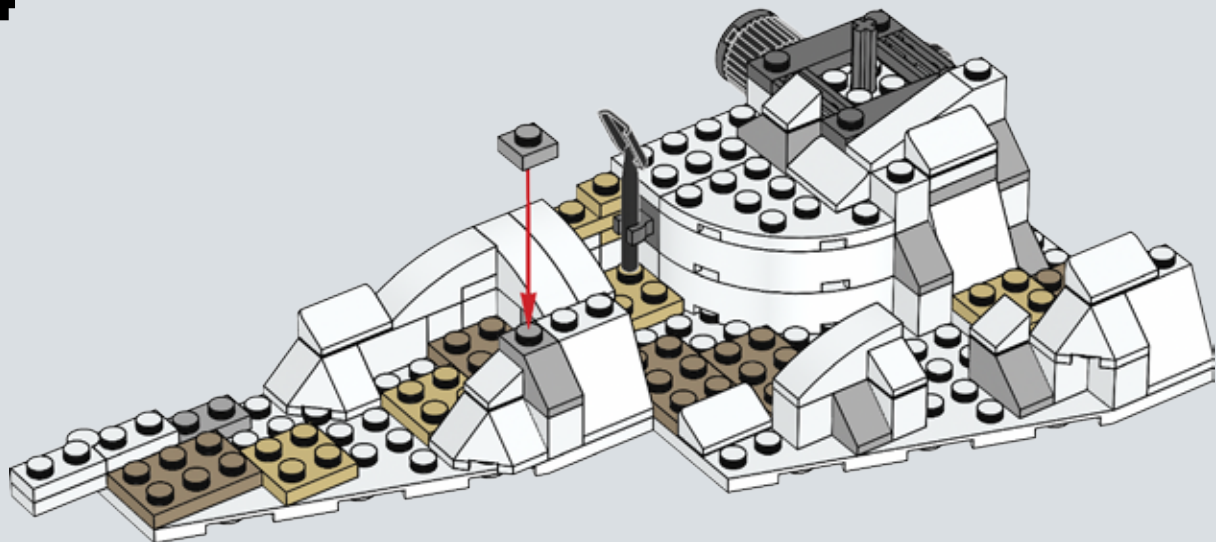



3x

35

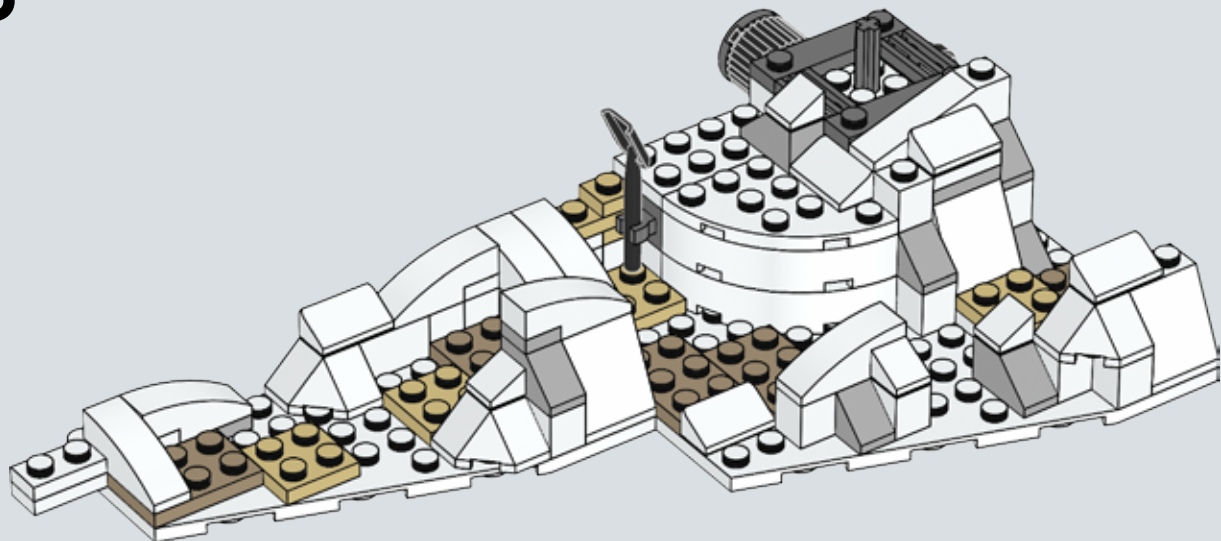

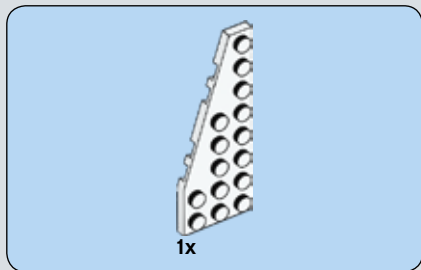

36

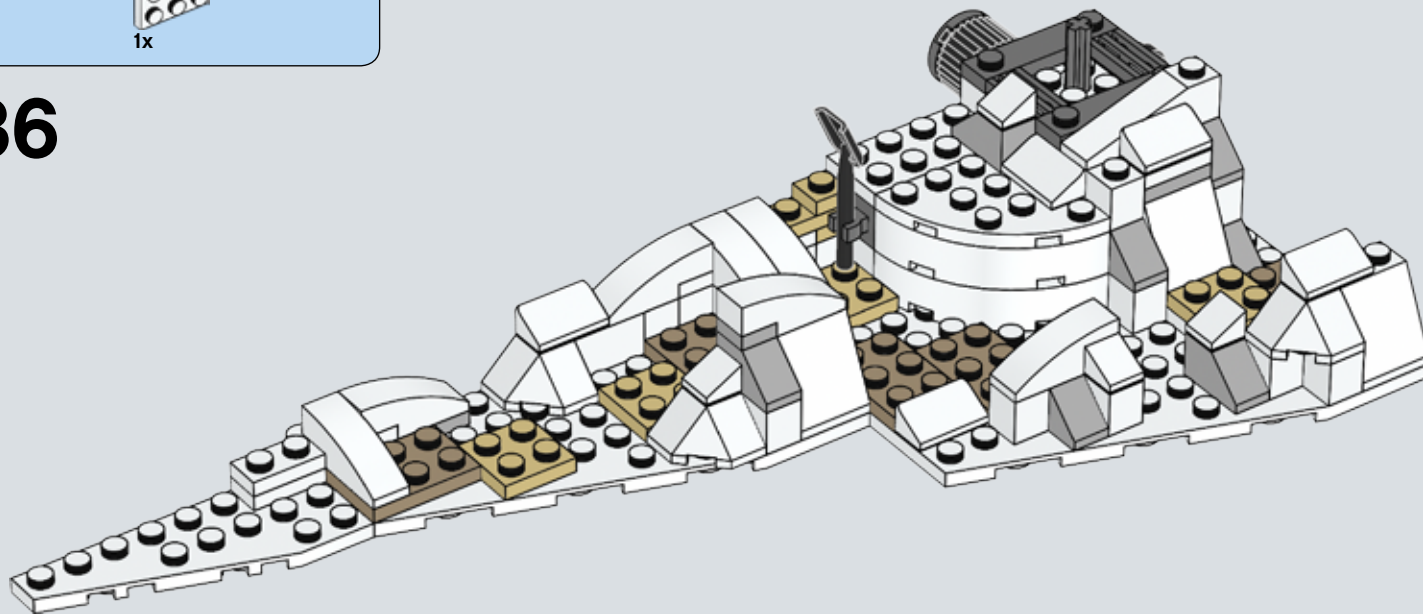



1x



1x



1x

37

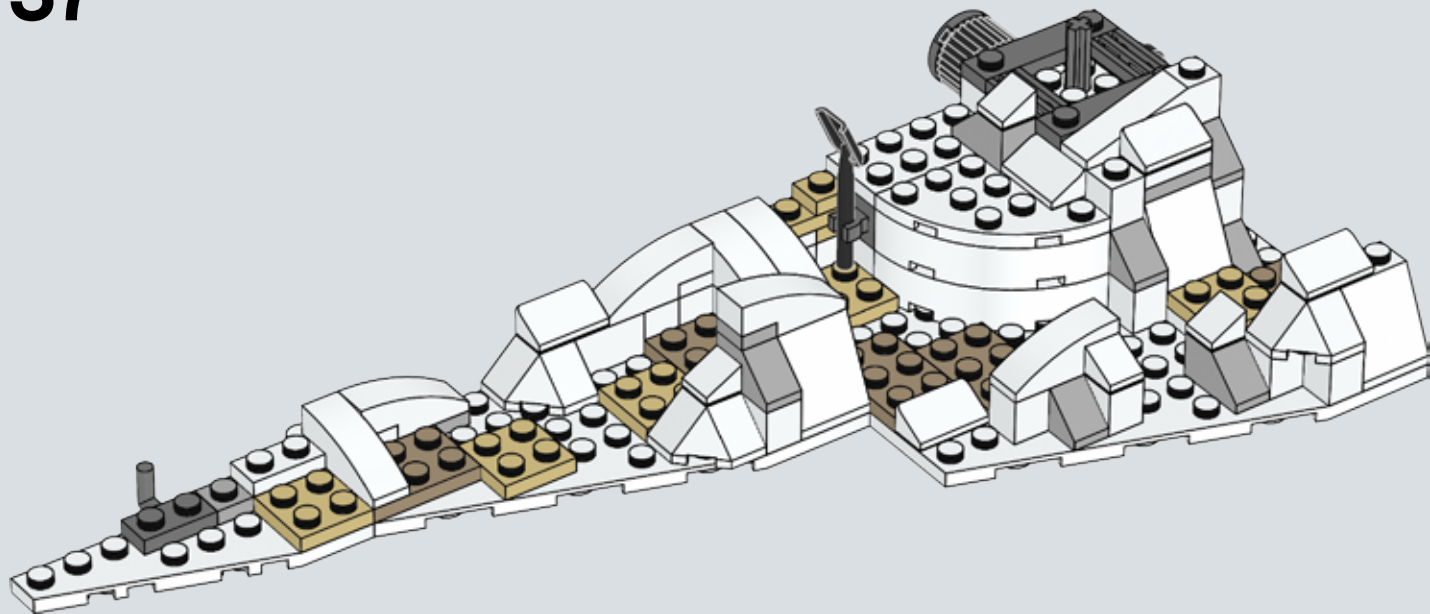



1x



1x



1x



1x

38

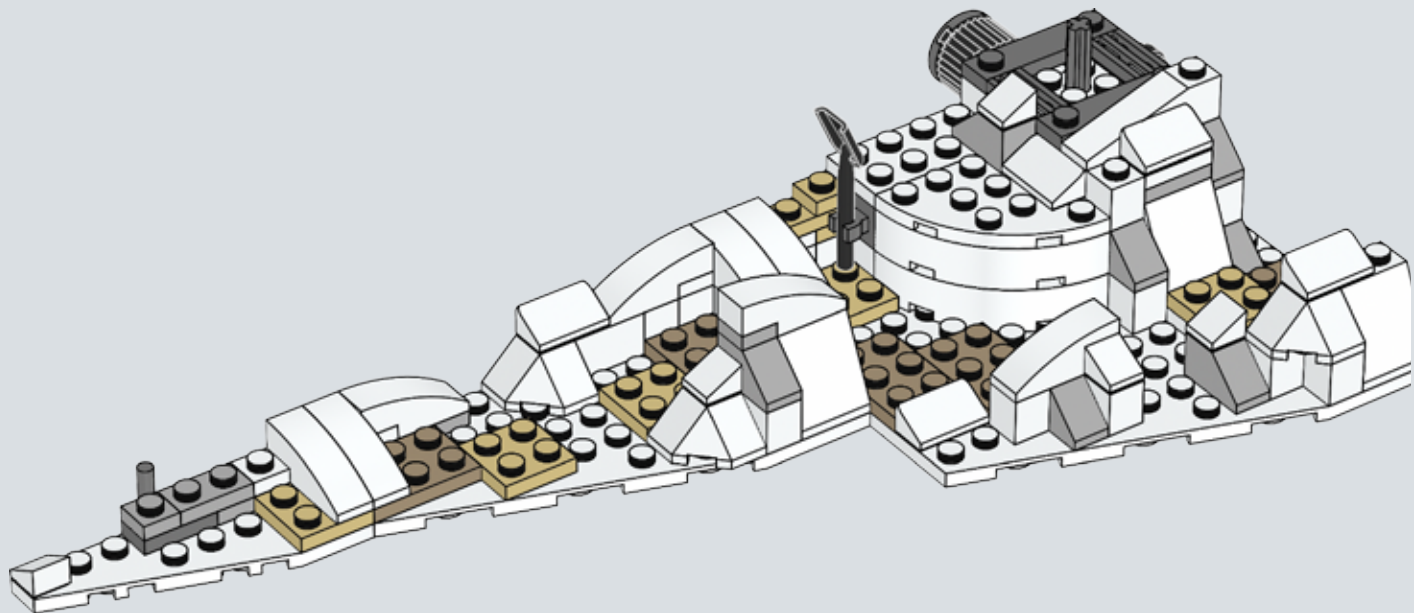

38

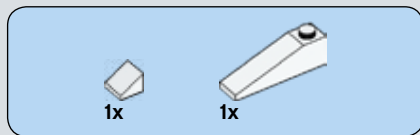

39

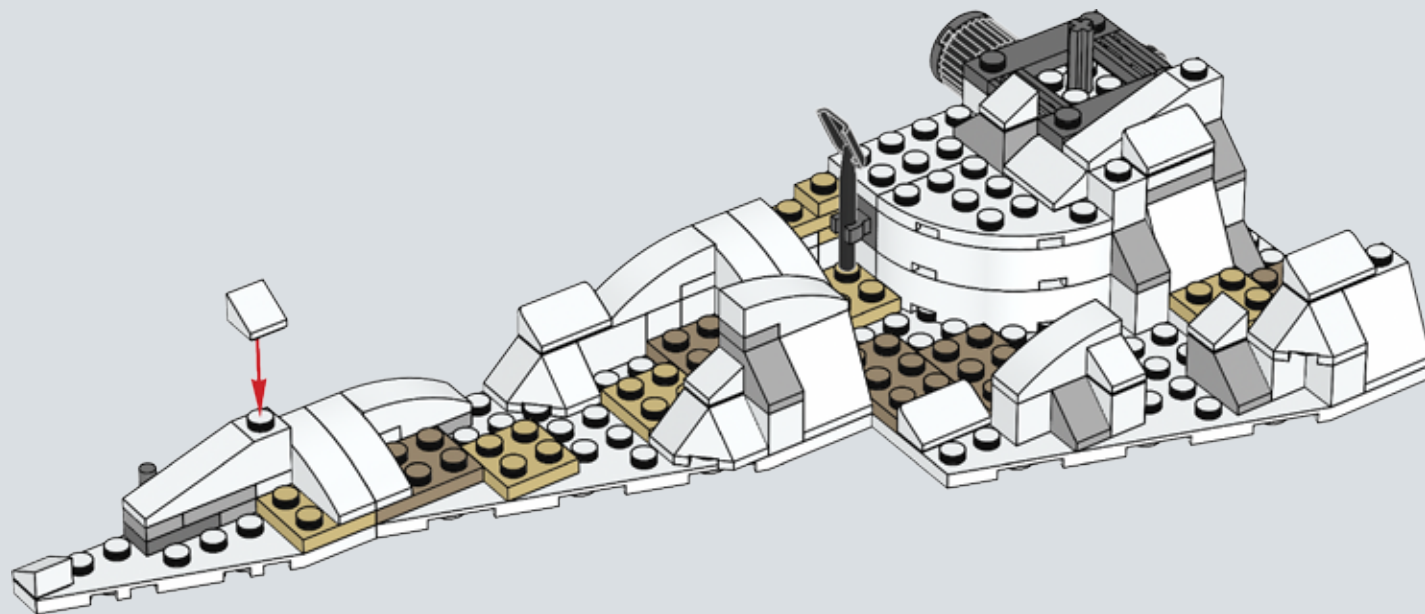

40

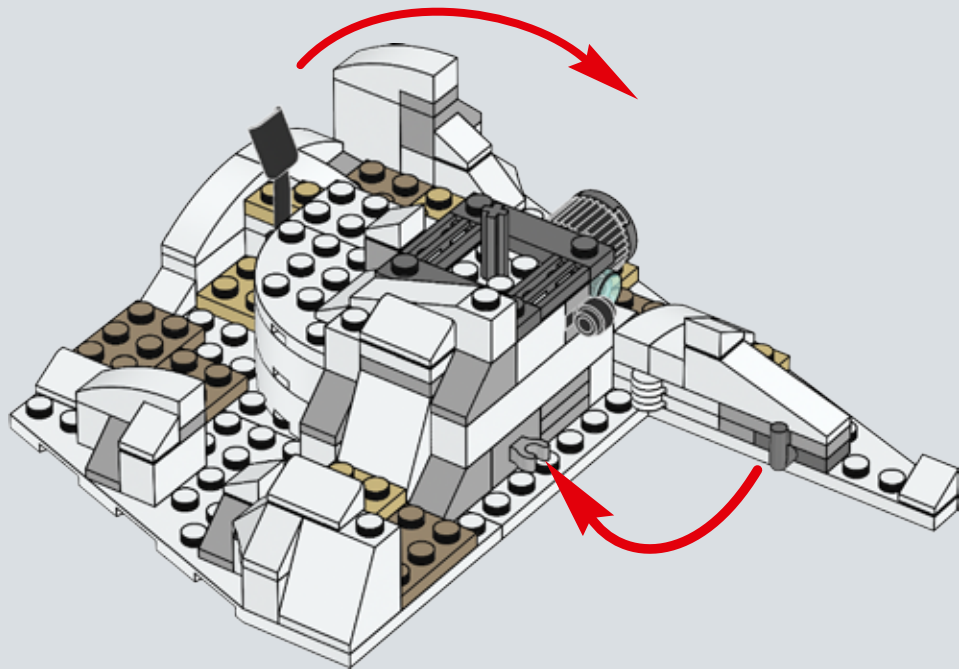
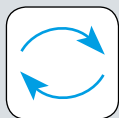

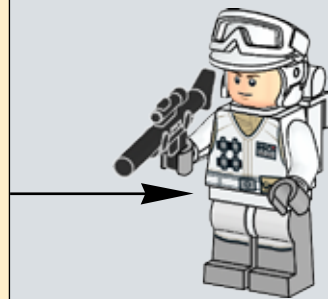
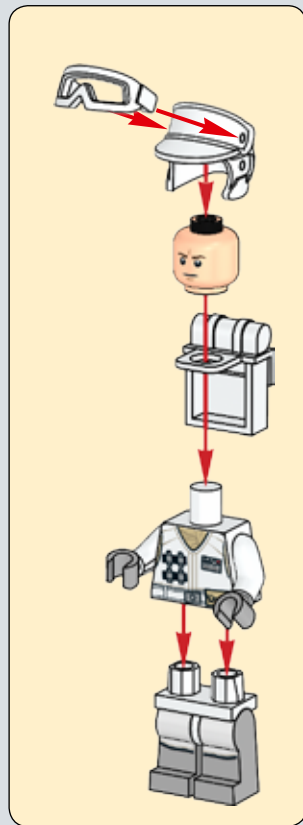
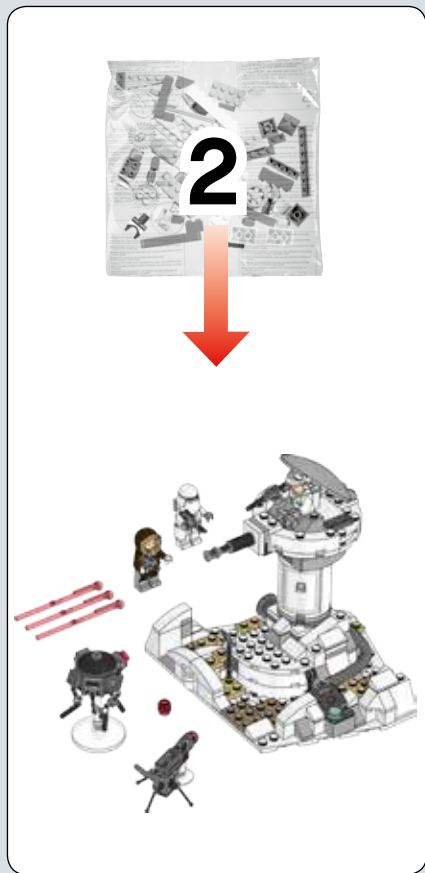

1

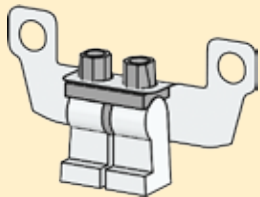

2

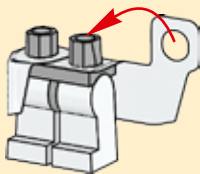

3

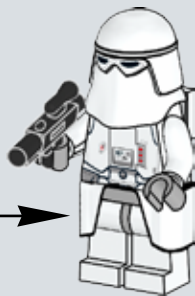
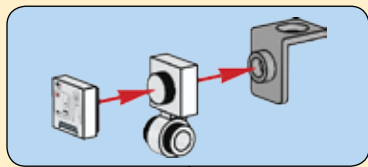
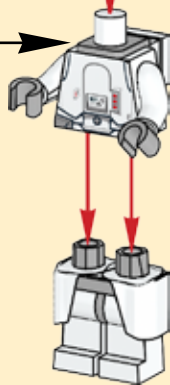

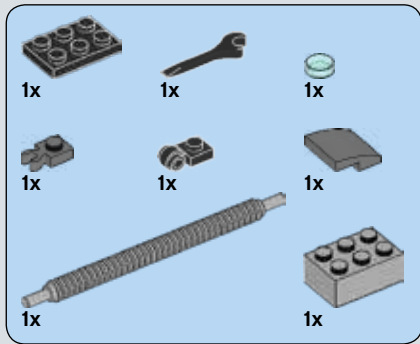

41

1

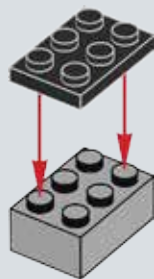

2

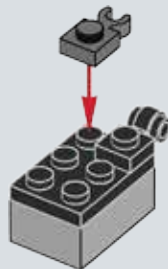

3

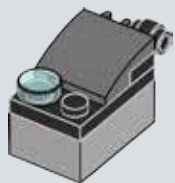

4

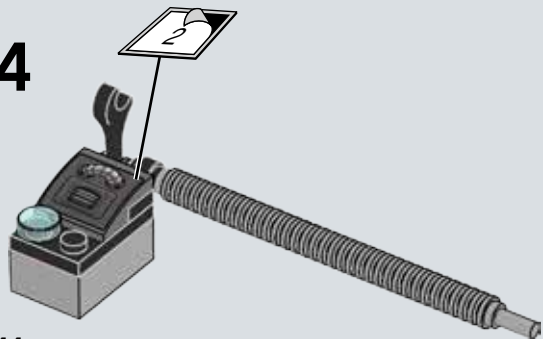

44

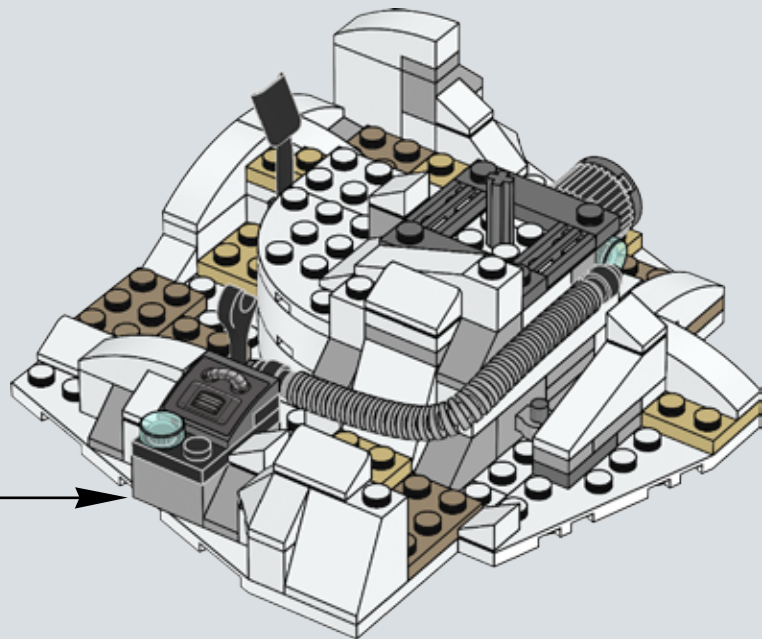

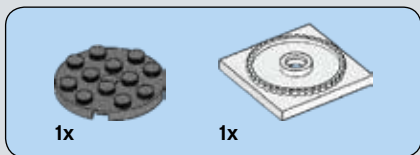
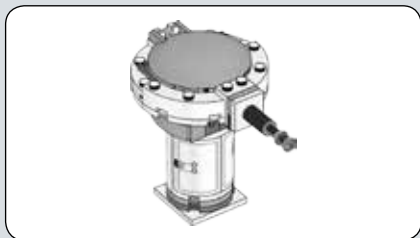

42

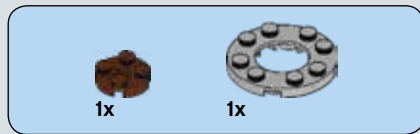
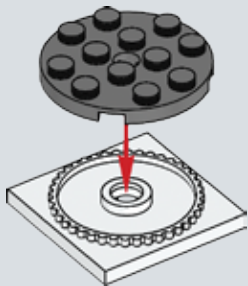

43

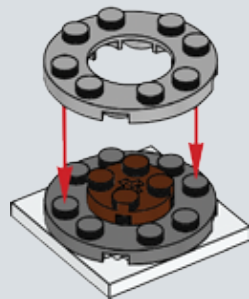

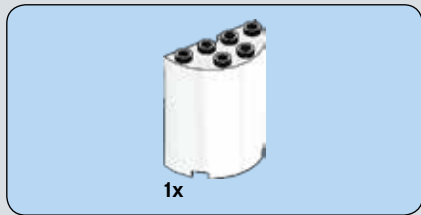

44

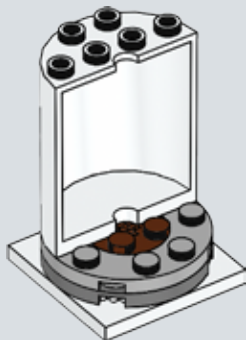

46

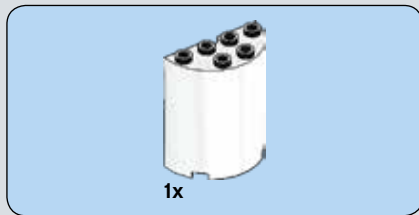

45

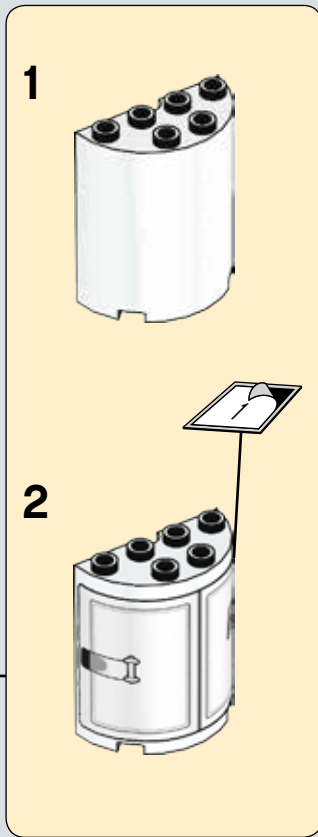
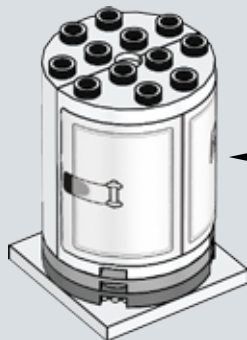



2x

46

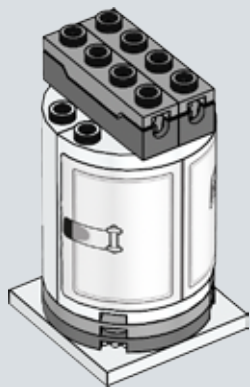

2x

47

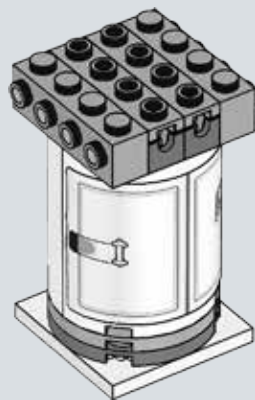



1x

48

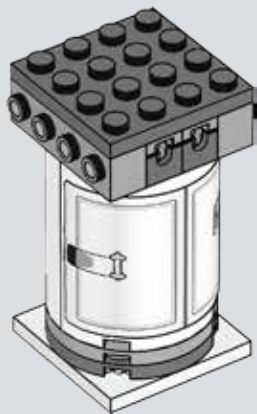

48



2x

49

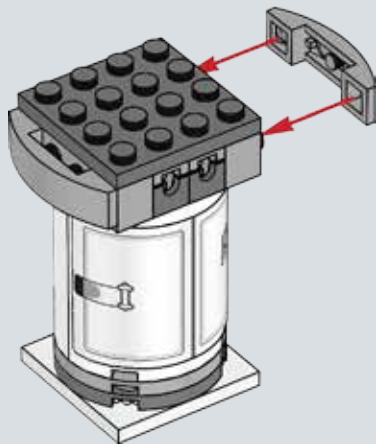



50

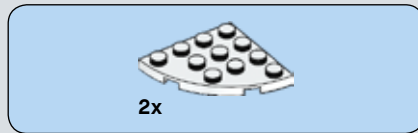
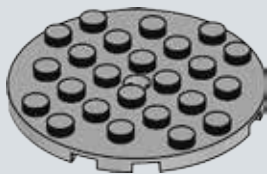

51

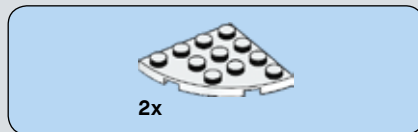
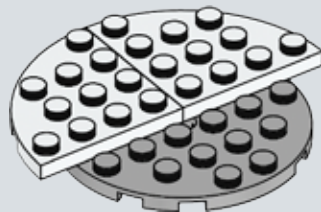

52

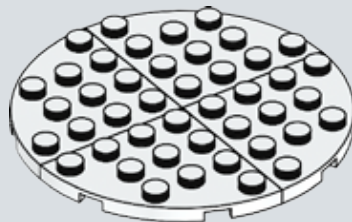



1x



1x

53

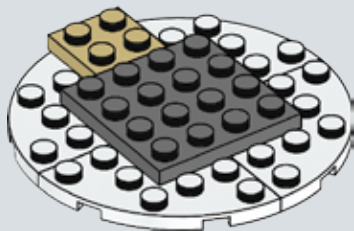

2x

54

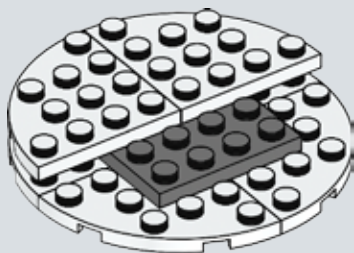

1x



2x

55

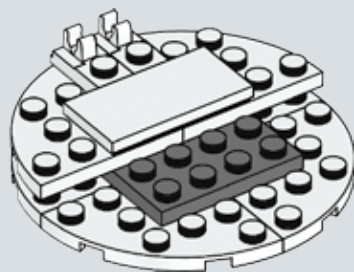



2x



2x

56

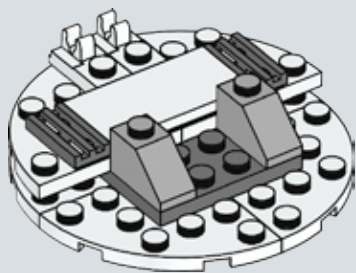

2x

57

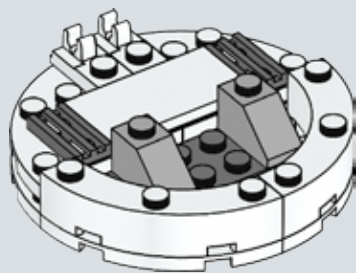

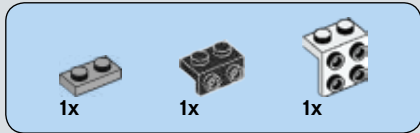

58

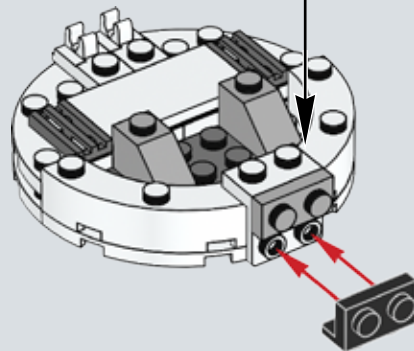
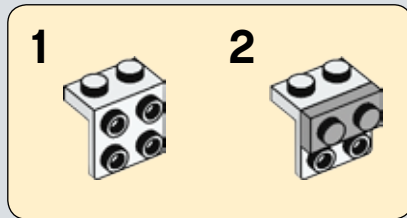

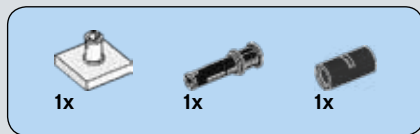

59

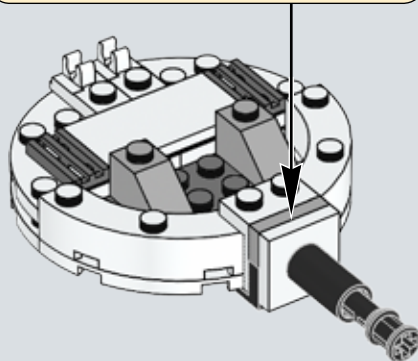
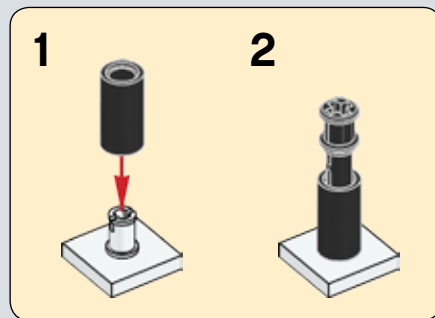

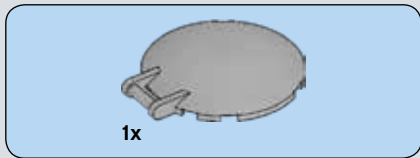

60

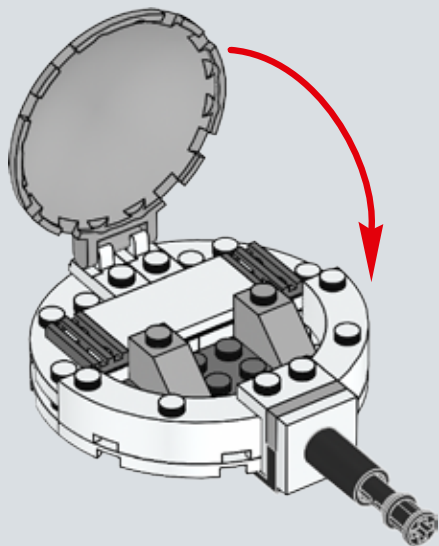

61

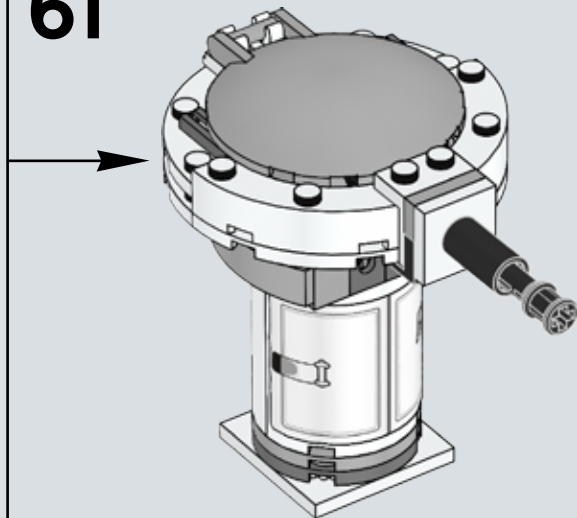

62

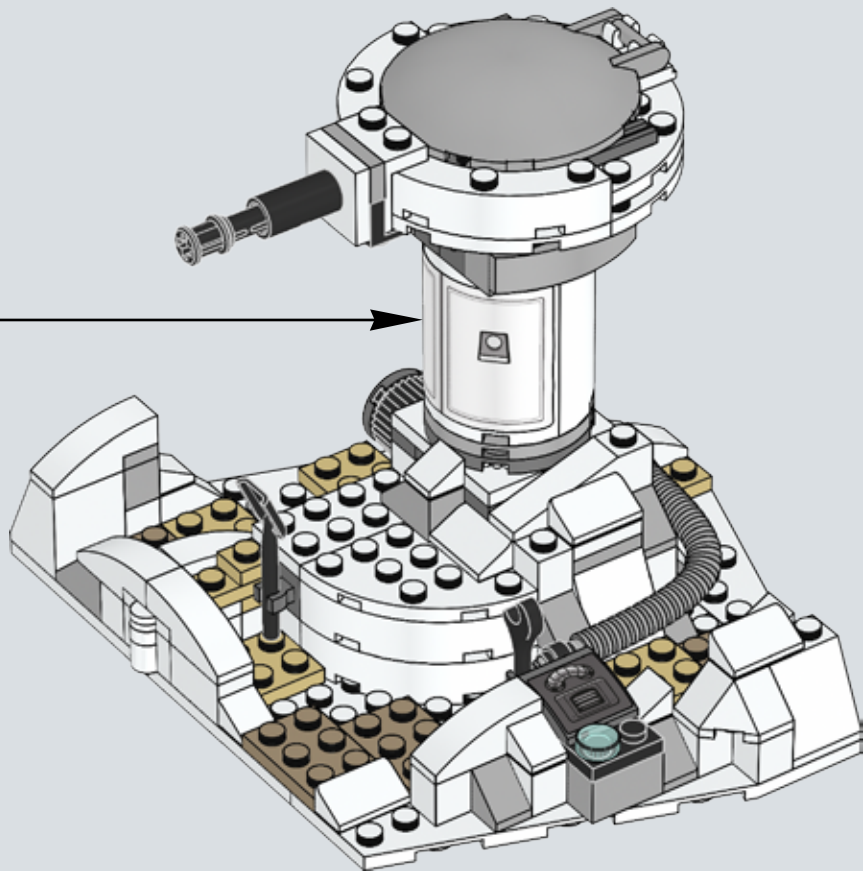
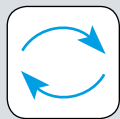

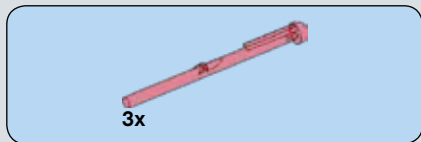

63

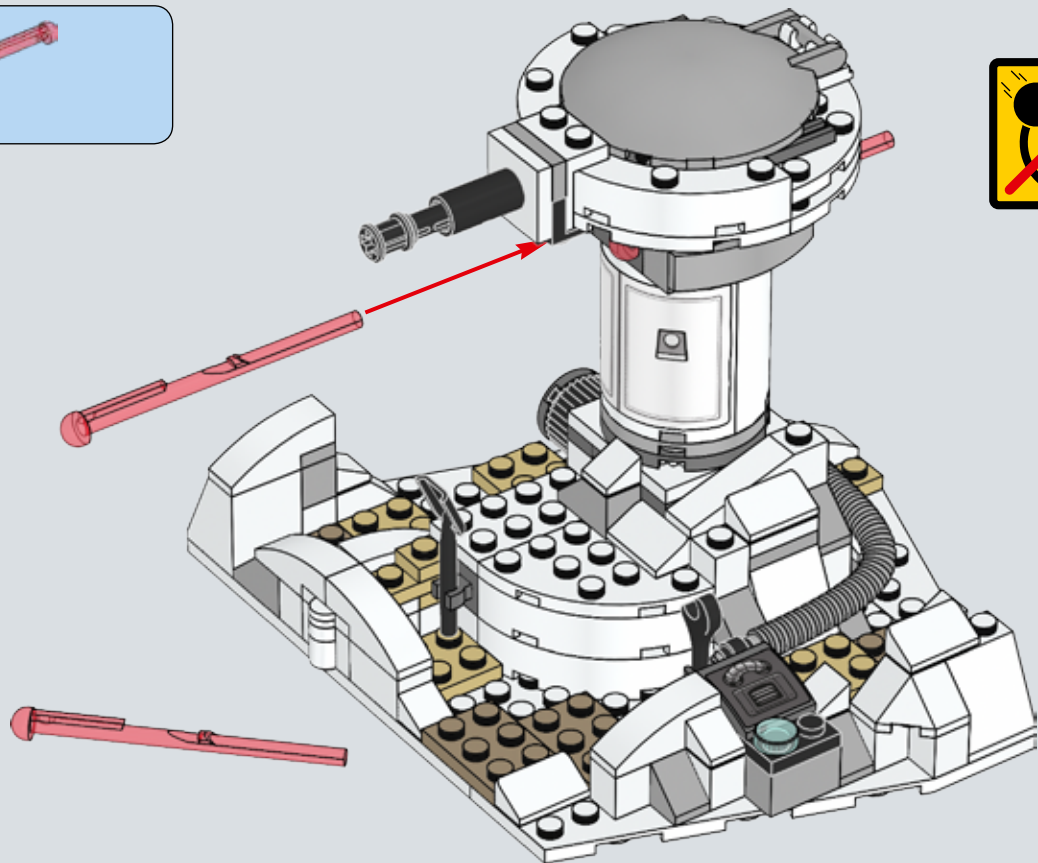

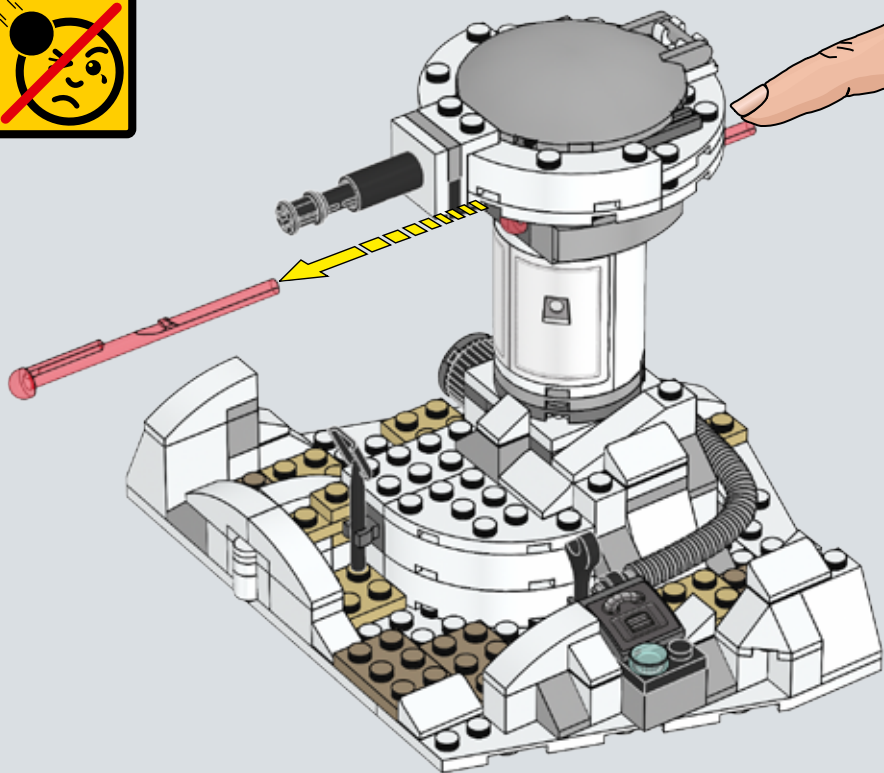



1

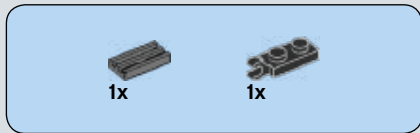
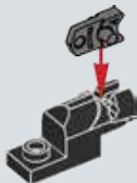

2

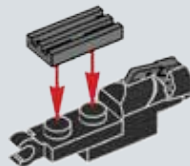



3x



2x



1x



1x

3

1



2



3

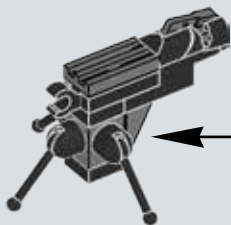
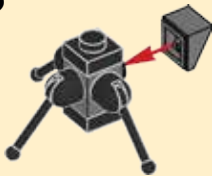

1x

4





1x



1x

5

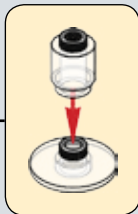
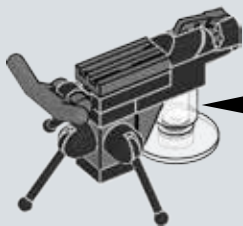

3x

6

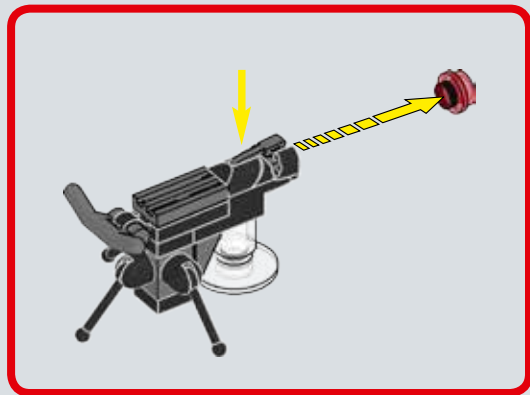



1

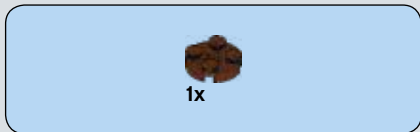

2

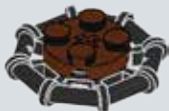

3



4

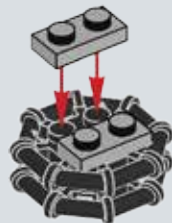



5



6

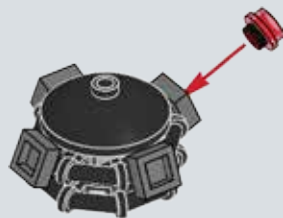

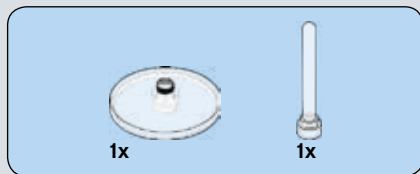



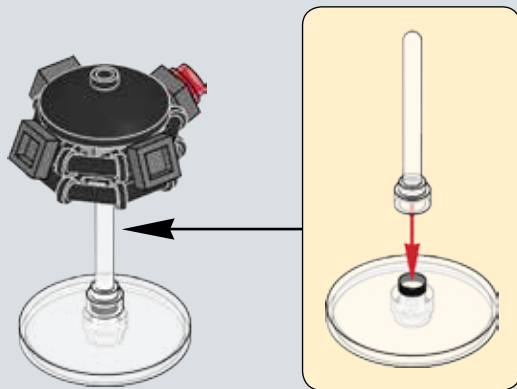



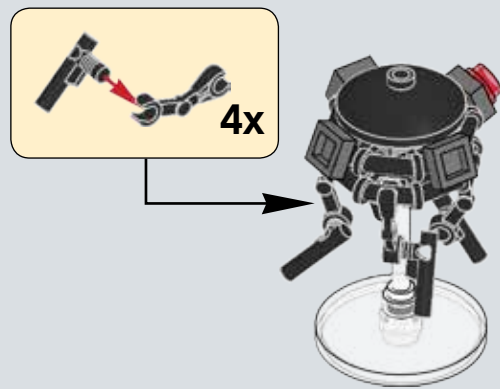

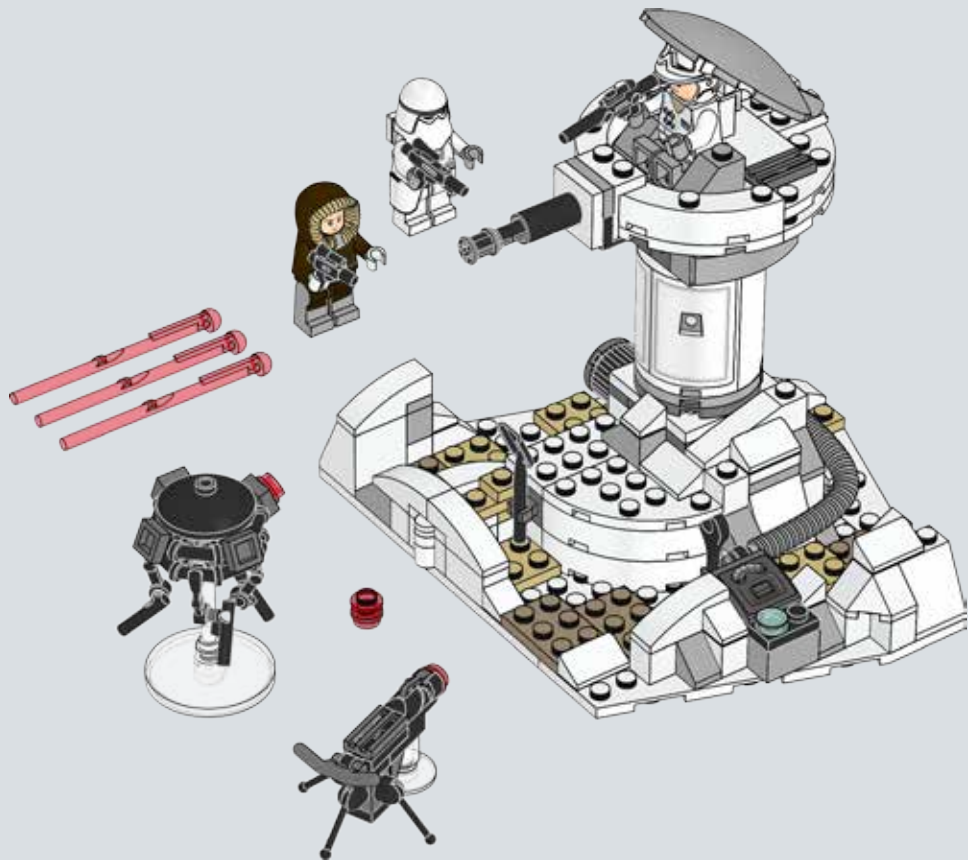







































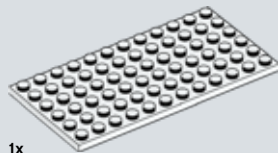









7



8





 1x 6138945	 5x 300501	 3x 4234525	 1x 302001	 3x 73587	 1x 4498713	 1x 4189009	 2x 4565452
 1x 4221858	 7x 4504369	 3x 6056447	 1x 4560178	 1x 407026	 1x 4535739	 1x 4498712	 6x 4114084
 1x 6077624	 1x 6011456	 8x 4249112	 7x 4178429	 2x 302426	 1x 4140801	 1x 6016172	 3x 4124067
 1x 4549059	 12x 300401	 2x 6106024	 2x 4527947	 1x 4609050	 1x 4180087	 2x 4141475	 1x 6102138
 1x 6075664	 2x 4598527	 2x 4515359	 3x 300901	 4x 4537551	 1x 6102734	 1x 4120020	 1x 301023
 5x 4547489	 1x 6117940	 1x 246001	 1x 4611927	 1x 6024730	 1x 400626		
 1x 6115179	 1x 383101	 3x 6102776	 4x 4215470	 2x 4632571	 1x 302126		
 1x 4598712	 1x 4256097			 1x 4526982	 2x 6018805		
 1x 4632566				 4x 4223247			



1x

4656652



1x

3006840



1x

4187750



1x

4166082



2x

4211159



5x

3005741



3x

6054526



2x

6022171



5x

6035540



1x

4211622



8x

4211399



1x

4211760



1x

6129028



1x

6115357



1x

4641682



1x

4211440



12x

4211398



10x

4211614



1x

6115345



1x

6030922



1x

4211386



2x

6048898



2x

4622803



2x

4211636



1x

6028015



1x

4211444



1x

6015349



1x

6097092



1x

6056596



1x

6051334



1x

4504378



4x

6071226



1x

4210700



1x

4580437



1x

6056296



1x

4611703



1x

4261908



1x

6071261



1x

6083620



2x

4598769



1x

4528323



1x

4508553



2x

4243831



5x

4210631



1x

4587212



1x

6021888



1x

6058705



1x

6118815



1x

6125056



1x

6135577



Customer Service

Kundenservice

Service Consommateurs

Servicio Al Consumidor

LEGO.com/service or dial



00800 5346 5555 :



1-800-422-5346 :



MASTER YOUR FORCE

TRY THE
FORCE
BUILDER
APP!



COMING 2016



Download on the
App Store



GET IT ON
Google play



STAR
WARS™

Screen images simulated. Free app download. Ask parents' permission first.
Simulierte Schirmbilder. Kostenloser App-Download. Bitte frage erst deine Eltern um Erlaubnis.
Images d'écran simulées. Téléchargement gratuit de l'appli. Demande d'abord l'autorisation d'un parent.
Capturas de pantalla simuladas. Descarga gratis la app. Pide antes permiso a tus padres.
Imagens de ecrã simuladas. Descarregamento grátis de app. Pede primeiro permissão aos teus pais.
A képernyőképek nem valódiak. Az app ingyenesen letölthető. Először kérj engedélyt a szüleitől!
屏幕图像已模拟。免费 app 下载。先请求家长的许可。

Apple, the Apple logo, iPad, iPhone and iPod touch are trademarks of Apple Inc.
Google Play is a trademark of Google Inc.