



Friends



41112





LEGO.com/friends



1

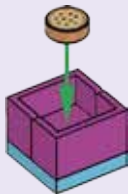

2



3





1

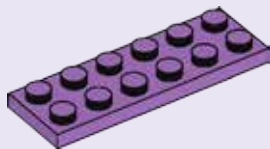

2

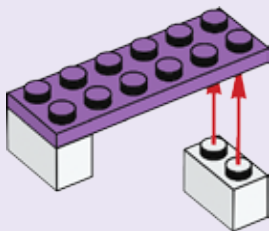



3

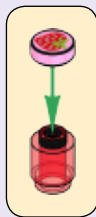

4





5





1



2

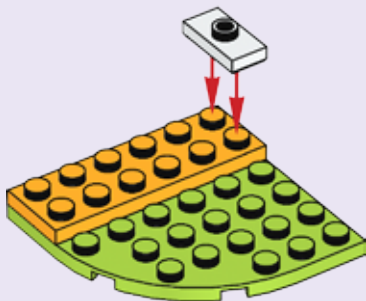

1

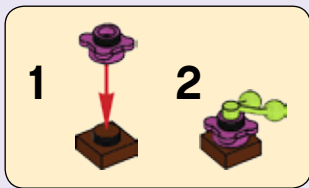
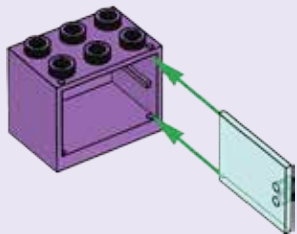

2

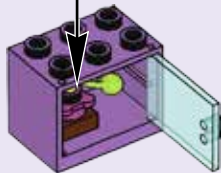

3

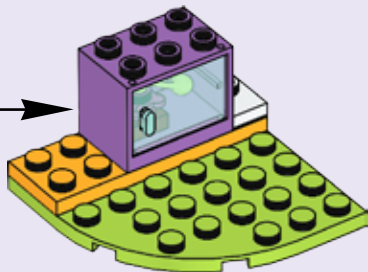

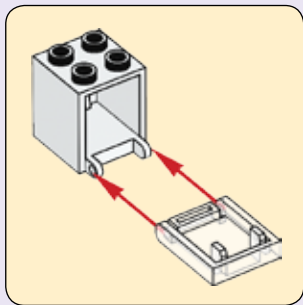

4

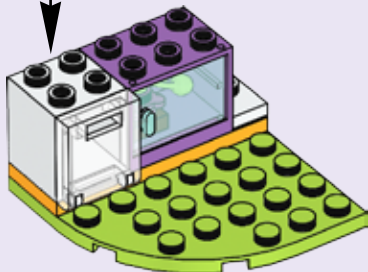

5



6

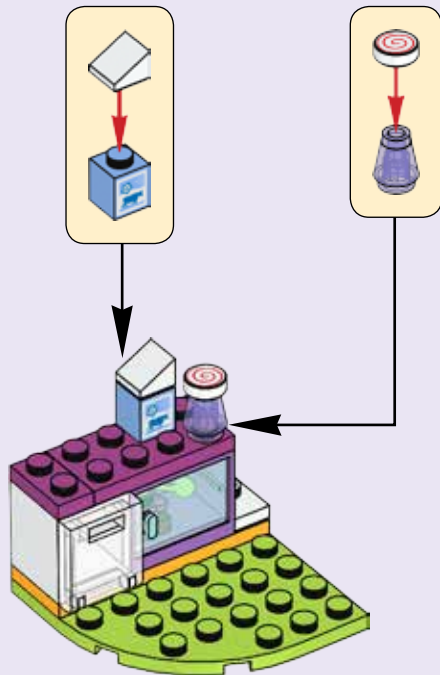

7



8



9

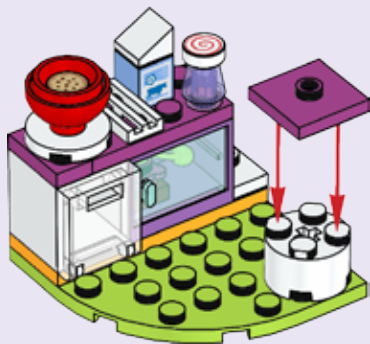

10

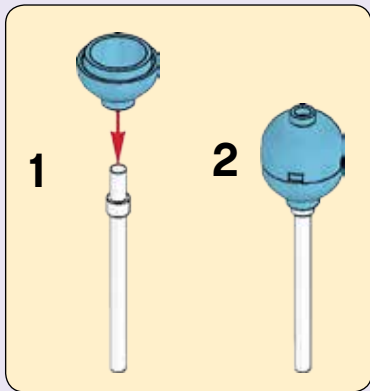





Friends

41112



41111



41113



41114



41110



LEGO.com/friends



2x
300401



1x
4504369



1x
241201



1x
6051511



1x
6037277



2x
6093053



1x
434501



1x
4600294



1x
6081986



1x
614301



1x
6065839



4x
614121



1x
6129601



1x
3006841



1x
4218499



1x
4619596



2x
6087084



1x
6103415



1x
6056292



1x
6037658



2x
6131870



3x
6078932



1x
6133256



1x
4219773



1x
6097509



1x
6133238



1x
4243920



2x
4221744



1x
4211159



1x
6055381



2x
6055384



1x
6036500



1x
6132411



1x
4625032



1x
4567340



1x
6035703



1x
4625027



1x
6133250



1x
6132838



Customer Service

Kundenservice

Service Consommateurs

Servicio Al Consumidor

LEGO.com/service or dial



: 00800 5346 5555

: 1-800-422-5346



Friends



4116



4110



4115



4118



4119

Stephanie



41111

41119

LEGO.com/friendstour



Friends



Apple, the Apple logo and iPad are trademarks of Apple Inc.
Google Play is a trademark of Google Inc.



Mia



41118



LEGO.com/friendstour