



# STAR WARS

75072



SERIES 2

# MICROFIGHTERS

2

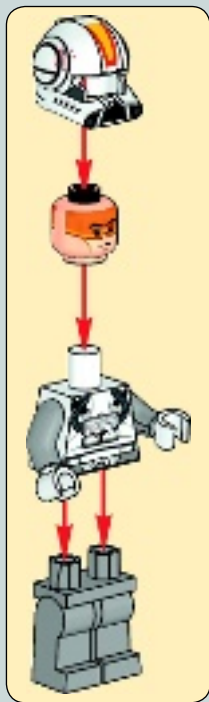

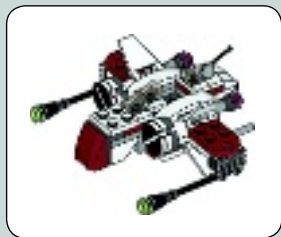

1

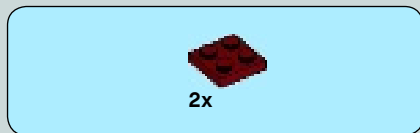

2

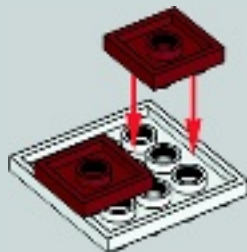

3



2x



2x

3

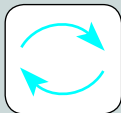

4



1x



2x

4



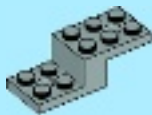

1x

5

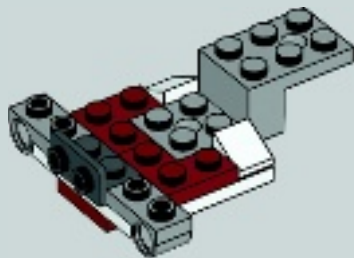



1x

6

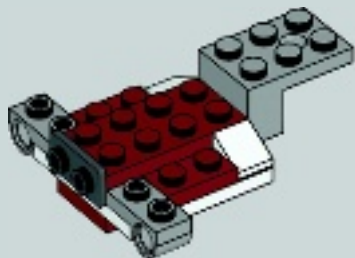

6



2x



2x

7

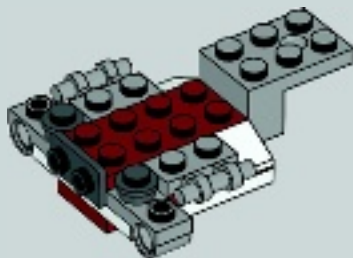



1x



2x

8

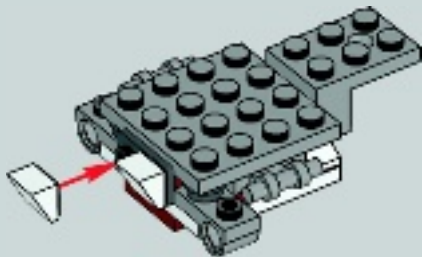

8





1x



2x



1x

# 9

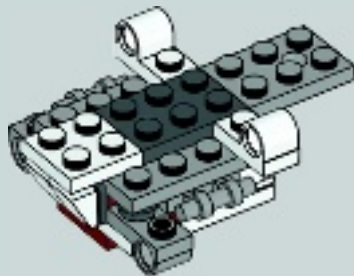



1x



1x



2x

# 10

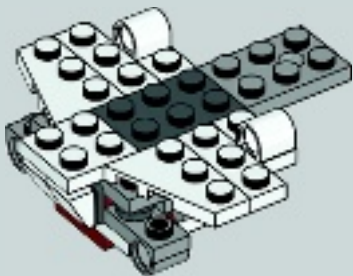

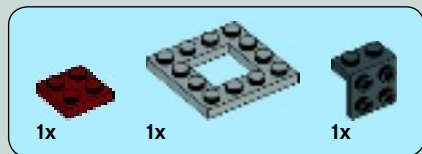

11

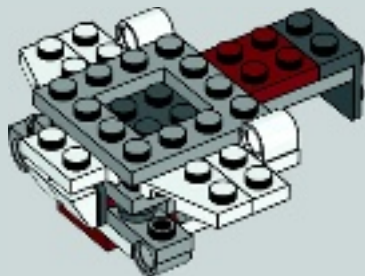



1x

# 12

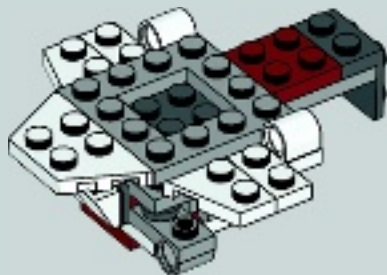



2x

# 13

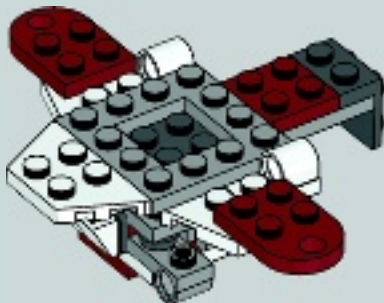

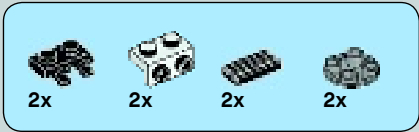

14

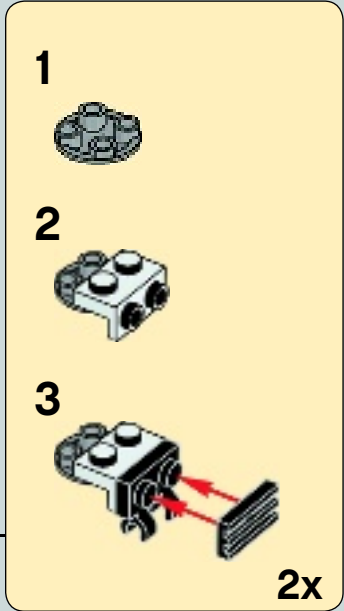
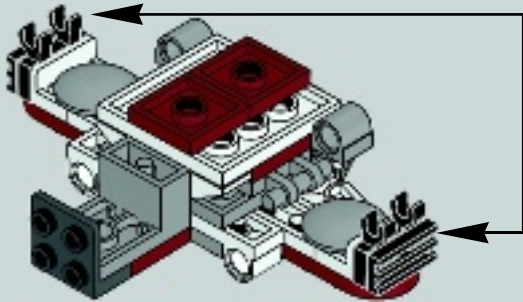



2x

15

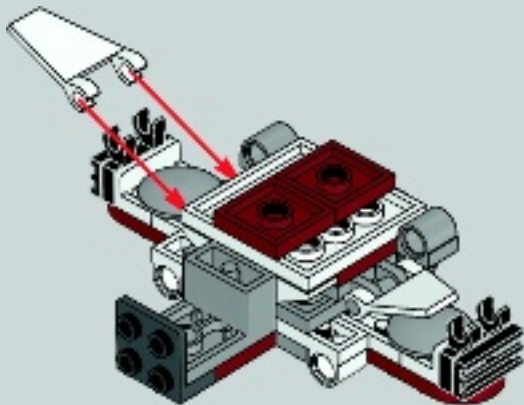



2x



2x

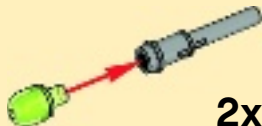

2x



# 16

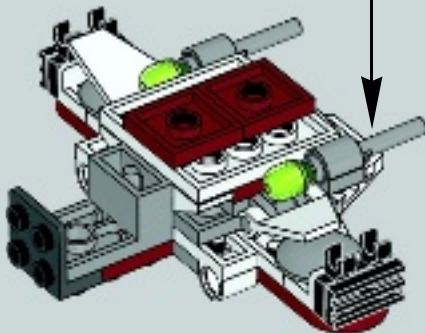





2x

# 17

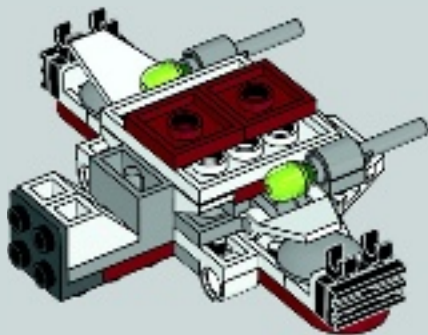



1x



1x

# 18

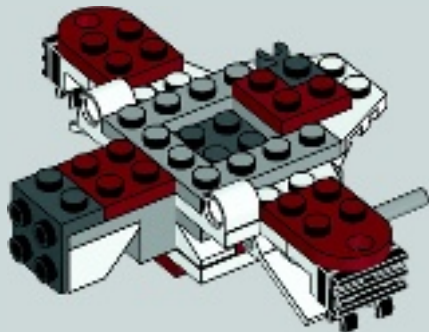
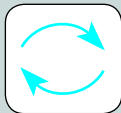



2x



2x

# 19

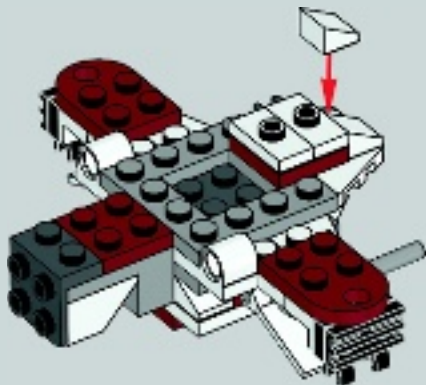



2x



1x

# 20

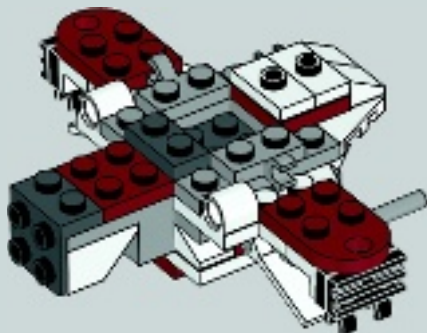



2x

# 21

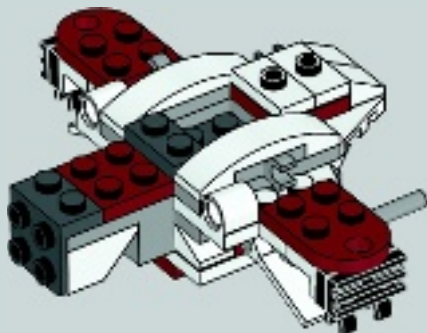



1x



2x

# 22

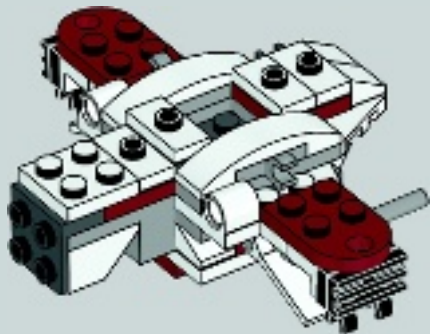



1x



3x

# 23

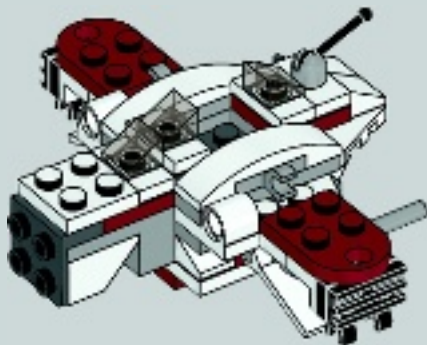



2x



1x

# 24

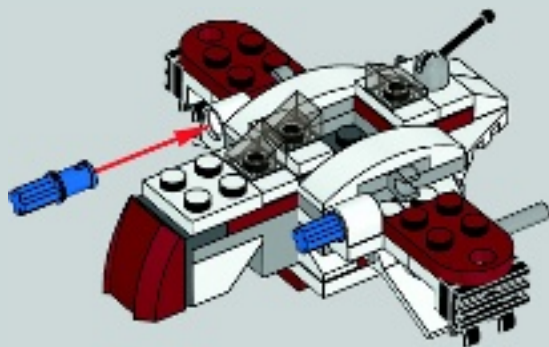





2x



2x



2x

# 25

1



2



2x

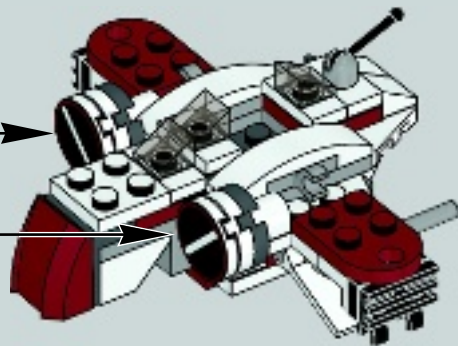



2x



2x



2x



2x

# 26

1



2

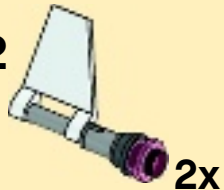

2x

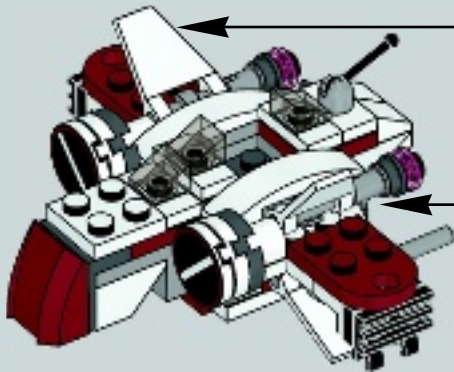

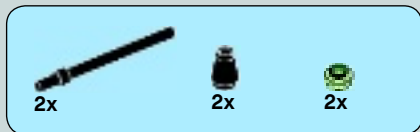

# 27

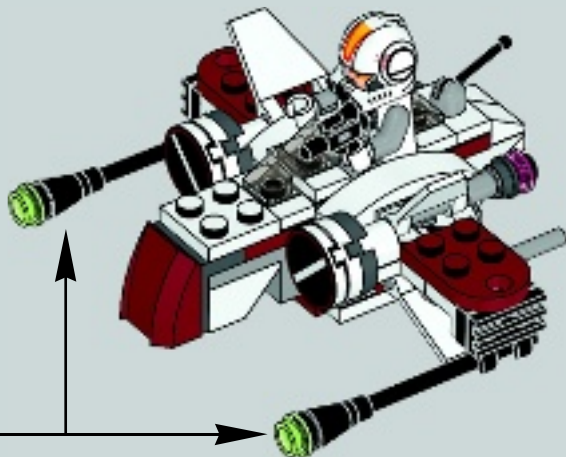
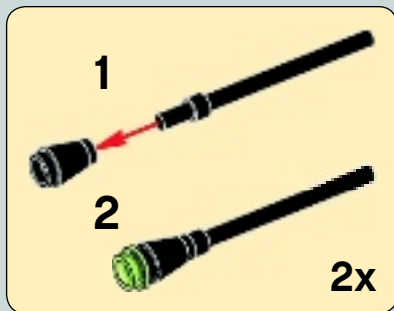

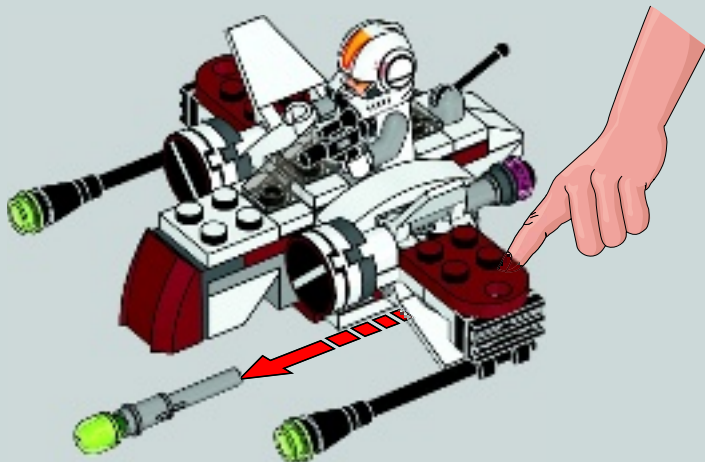

6x 4504369	1x 4243812	4x 6023099	1x 4609050	1x 6028811	1x 4221775	1x 4587212	2x 4211042
2x 366501	1x 4249506	1x 6063556	3x 4244368	1x 4612621	1x 4227657	1x 4211063	1x 6096721
2x 6023806	2x 6018774	1x 6097106	2x 4599535	1x 462621	4x 4520320	1x 6117972	2x 6057034
4x 6051511	1x 4179875	2x 4206482	3x 4585751	1x 4243797	2x 6089147	1x 6000606	2x 4570481
2x 302201	1x 4179874	2x 4529236	3x 4585479	2x 6028812	1x 4211043	4x 4210633	
2x 362301	2x 403201	2x 241226	1x 4539071	2x 4211632			
2x 6057414	2x 6096585	2x 4556158	2x 4568753	2x 4278273			
		2x 6081988	1x 6039200				



**Customer Service**  
**Kundenservice**  
**Service Consommateurs**  
**Servicio Al Consumidor**  
**LEGO.com/service or dial**



An advertisement for LEGO Star Wars Microfighters. The background is a dark space scene with a bright sun in the upper right, green laser beams, and various spacecraft. At the top center is the LEGO logo and the text "STAR WARS". Below this are two boxes of Microfighters: the first is a white and red ship (set 1053) and the second is a white and blue ship (set 1054). At the bottom are four more boxes: a white and orange ship (set 1055), a white and grey ship (set 1056), a white and red ship (set 1057), and a white and red ship (set 1058). Each box features the LEGO logo, "STAR WARS", the age range "6-12", and the set number. The word "MICROFIGHTERS" is written in a stylized font at the bottom center.

**LEGO**

**STAR  
WARS**



**MICROFIGHTERS**

STAR WARS © & ™ 2015 Lucasfilm Ltd. © 2015 The LEGO Group. ™ & © WBEI.

Apple, the Apple logo, iPad, iPhone and iPod touch are trademarks of Apple Inc., registered in the U.S. and other countries. App Store is a service mark of Apple Inc.

Google Play is a trademark of Google Inc.



# STAR WARS

# Download the Microfighters App!



# MICROFIGHTERS



# WIN

GO TO [WWW.LEGO.COM/PRODUCTFEEDBACK](http://WWW.LEGO.COM/PRODUCTFEEDBACK) AND  
GIVE US YOUR SHORT **FEEDBACK** ABOUT THIS  
LEGO® SET FOR A CHANCE TO WIN  
A COOL LEGO PRIZE.



## [LEGO.com/productfeedback](http://LEGO.com/productfeedback)

### GEWINNE



Erzähle uns auf  
[www.LEGO.com/productfeedback](http://www.LEGO.com/productfeedback)

etwas über die Erfahrungen, die  
du mit diesem LEGO® Set gemacht  
hast, und sichere dir die Chance auf  
einen coolen LEGO Preis!

### GAGNE



Rends-toi sur  
[www.LEGO.com/productfeedback](http://www.LEGO.com/productfeedback)

et donne-nous quelques commen-  
taires sur ce produit LEGO® pour  
avoir une chance de gagner un  
prix LEGO !

### GANA



Visita  
[www.LEGO.com/productfeedback](http://www.LEGO.com/productfeedback)

y envíanos tu opinión acerca de este  
set LEGO®. ¡Participarás en el sorteo  
de un premio LEGO!

### 获取奖品



登录  
[www.LEGO.com/productfeedback](http://www.LEGO.com/productfeedback)

给出关于此乐高®套装的简短反馈，  
就有机会获得炫酷乐高奖品

LEGO and the LEGO logo are trademarks of the LEGO Group. ©2015 The LEGO Group.  
© & ™ Lucasfilm Ltd.

6127055