



CLASSIC

10697



7 LEGO.com/classic







LEGO.com/brickseparator





Easy building
Einfach zu bauen
Construction facile
Construcción fácil
Kezdő építőknek
简单拼砌



Medium building
Mittelschwer
Construction intermédiaire
Construcción intermedia
Construção intermédia
Gyakorló építőknek
中级拼砌



Advanced building
Fortgeschritten
Construction avancée
Construcción avanzada
Construção avançada
Tapasztalt építőknek
高级拼砌



LEGO.com/
classic

Page/ 页码

58



Page/ 页码

6





Page/ 页码
25

Page/ 页码
64



Page/ 页码
34





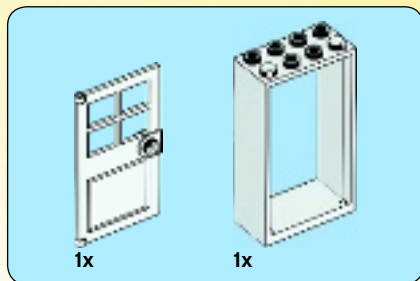

1

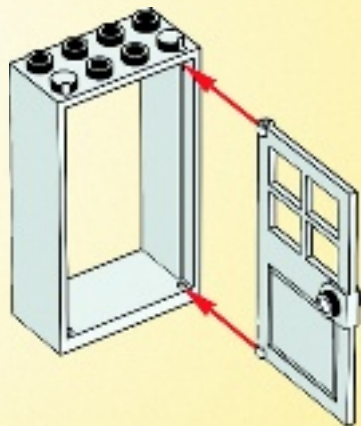

2



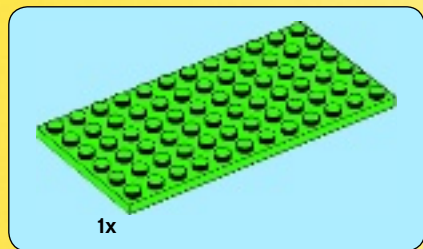

3

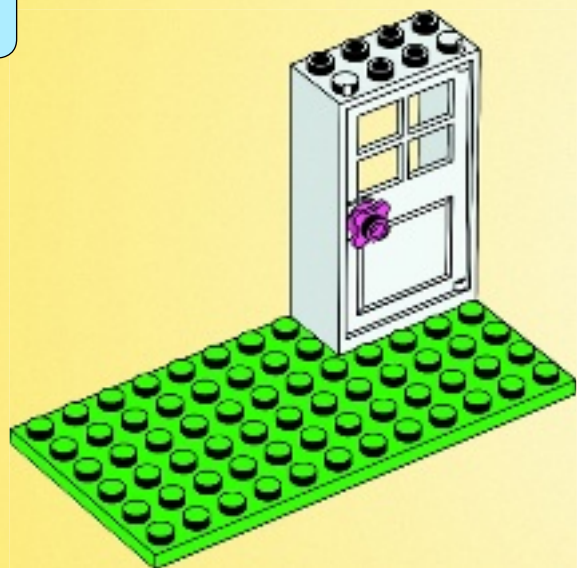



1x



1x

4

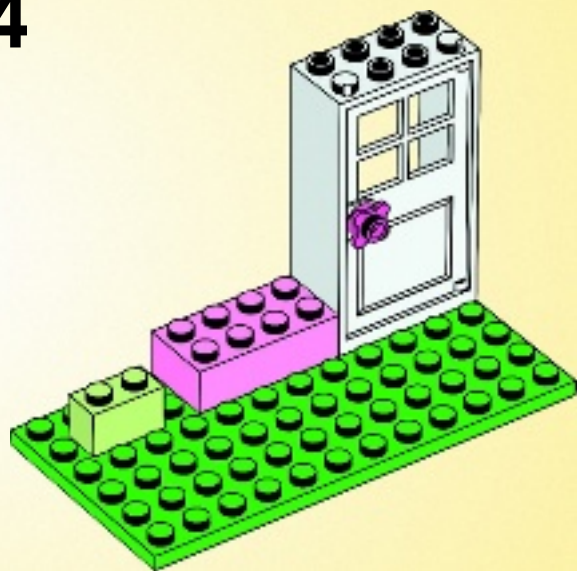

1x

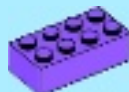

1x

5

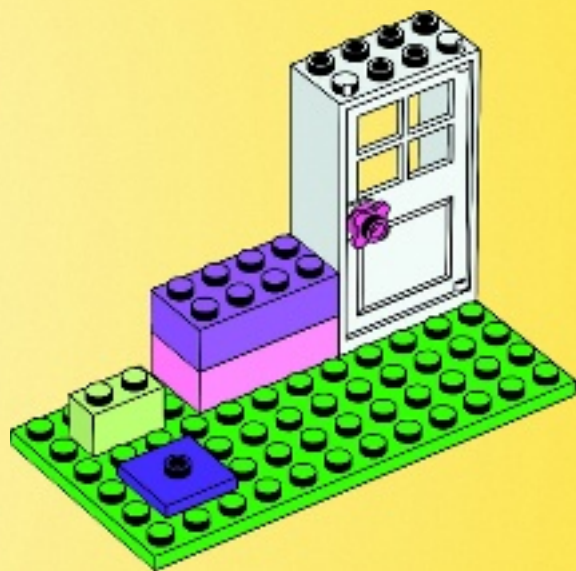

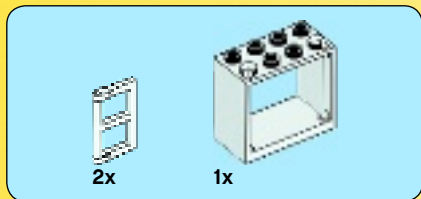

6

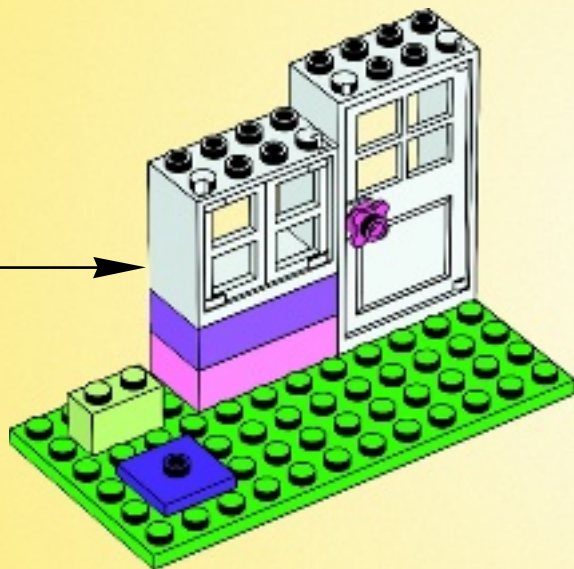
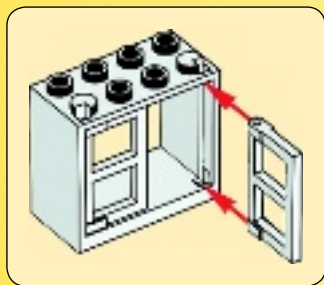



7





2x



2x

8





2x

9





1x



1x

10

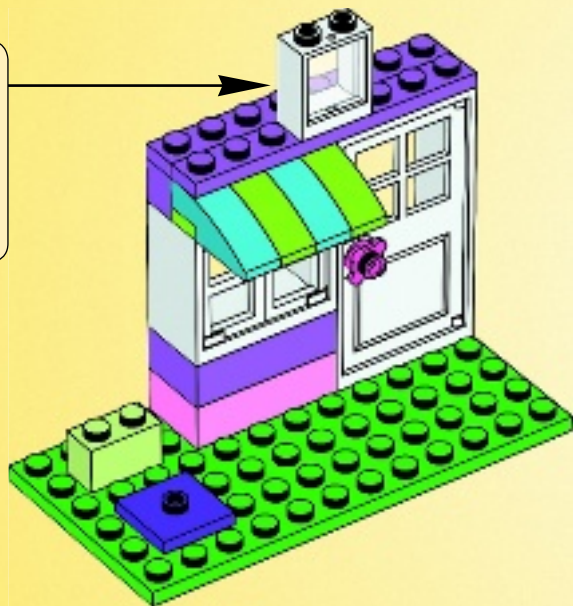
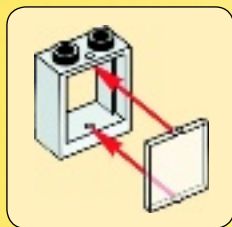



2x

11

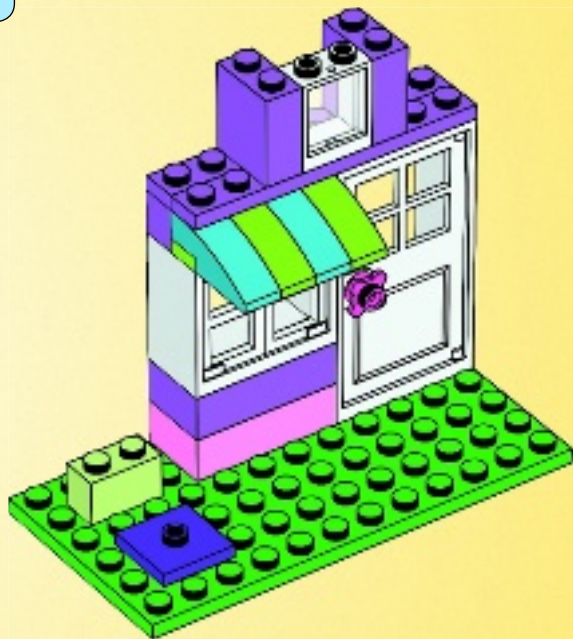



2x

12

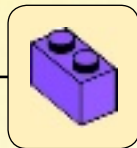
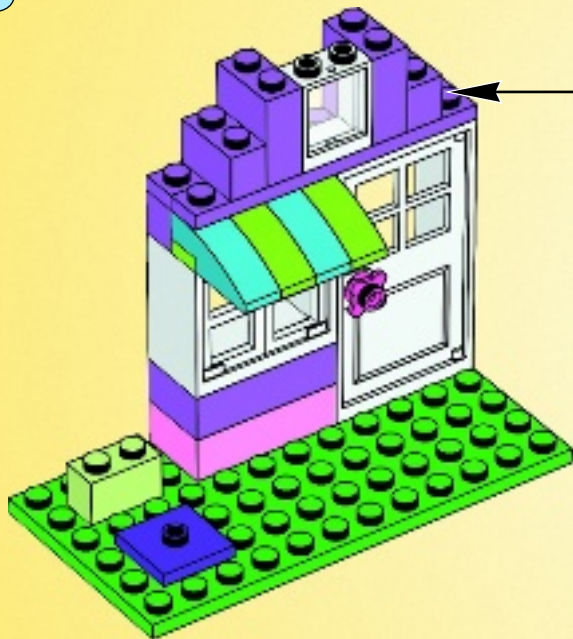



2x

13





2x

14





2x



1x

15





2x

16





1x



1x

17

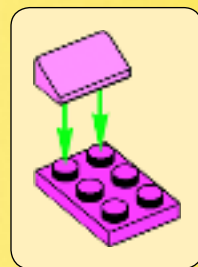



1x



1x



1x

18

1





1x



1x

19



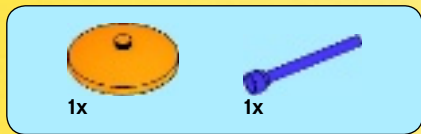

20

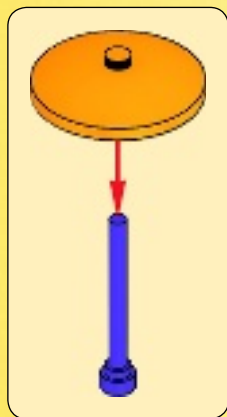

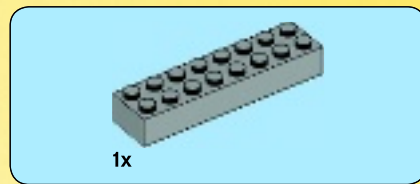

1

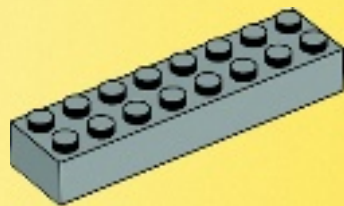



1x



1x

2

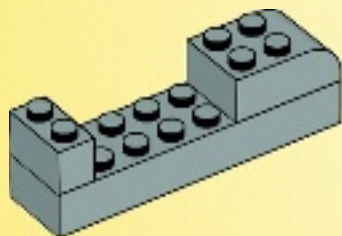



1x



2x

3

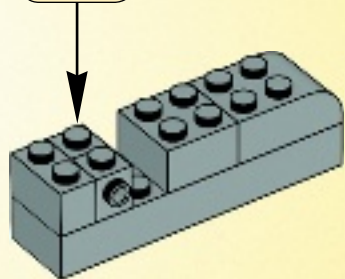

2x

4

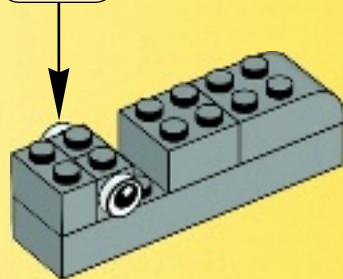



5

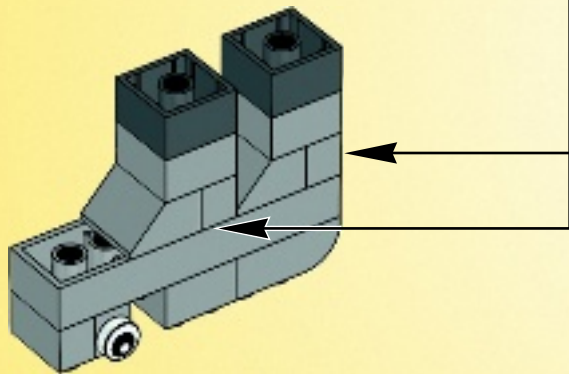
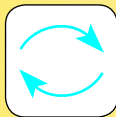
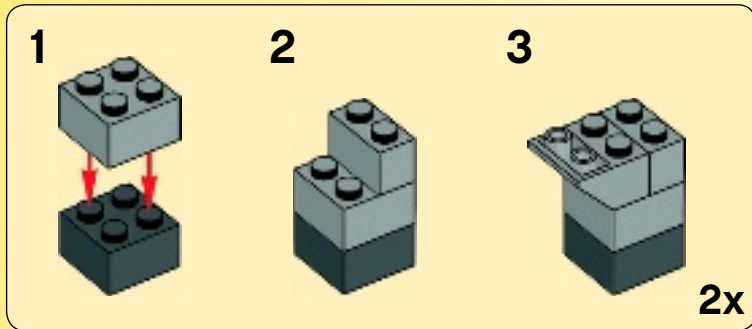



1x

6

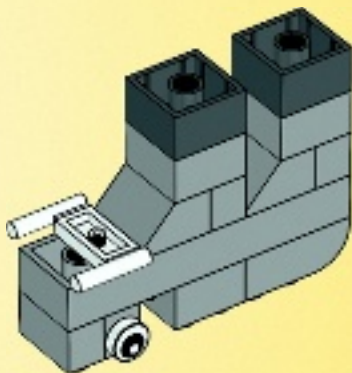



1x



2x

7

1

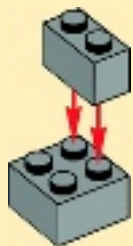

2

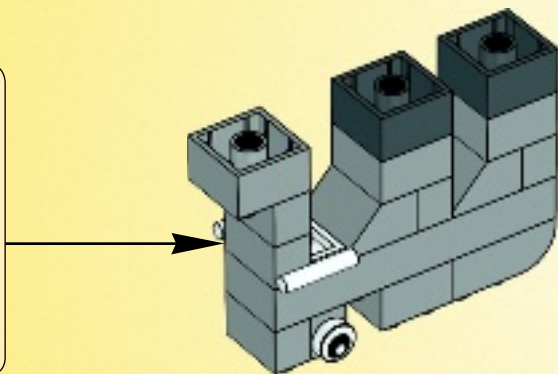
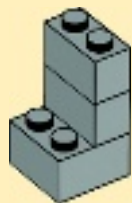



1x

8

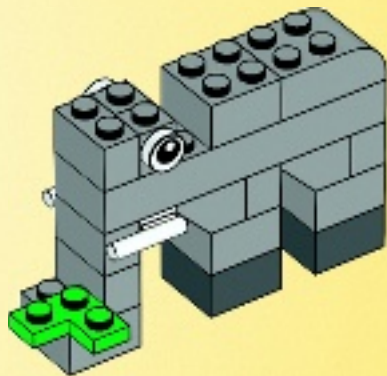
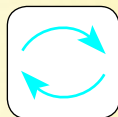

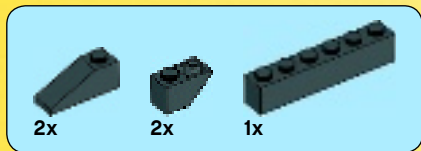

9

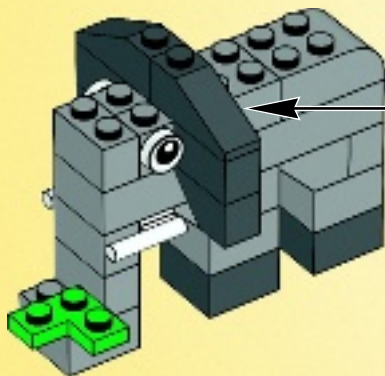
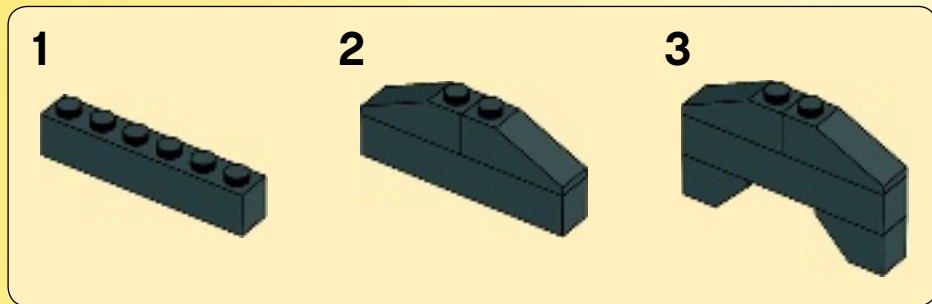



2x

10

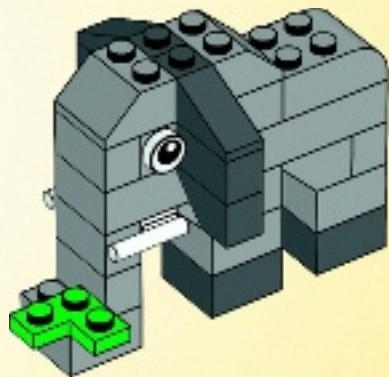

1x

11

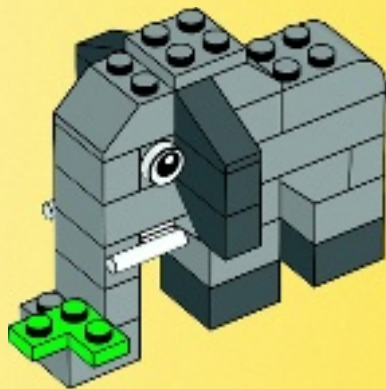



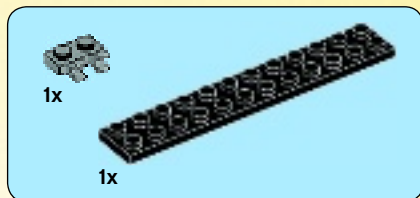

1

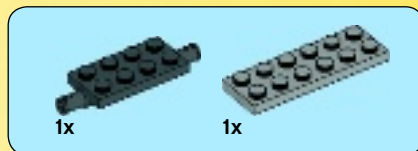
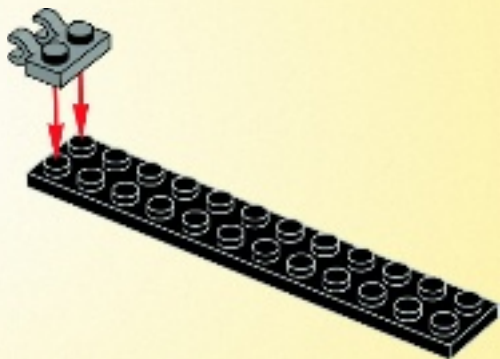

2





3

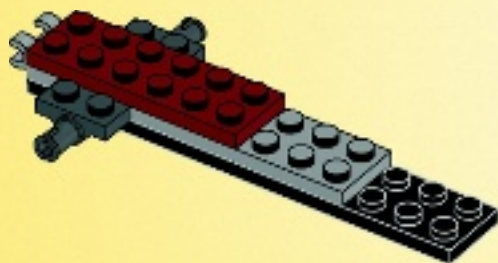



1x



1x

4

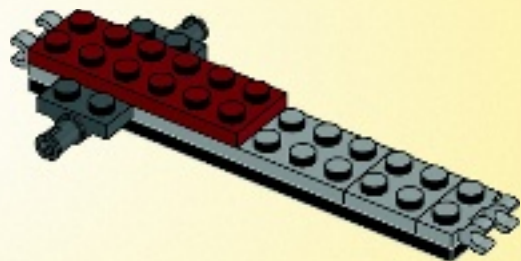

2x



1x

5

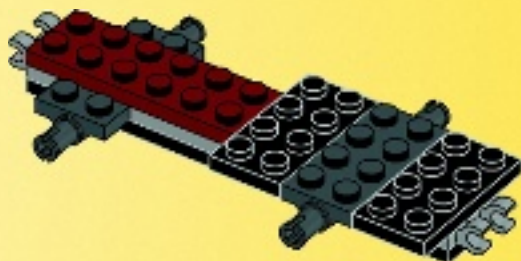

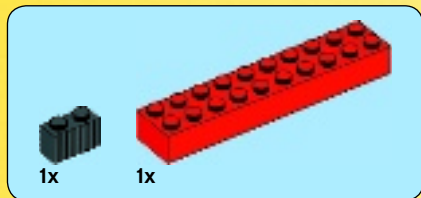

6

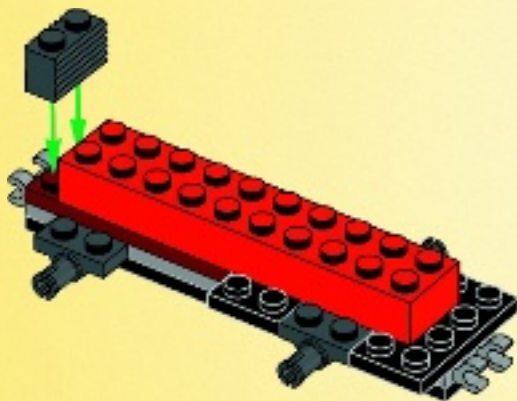



7

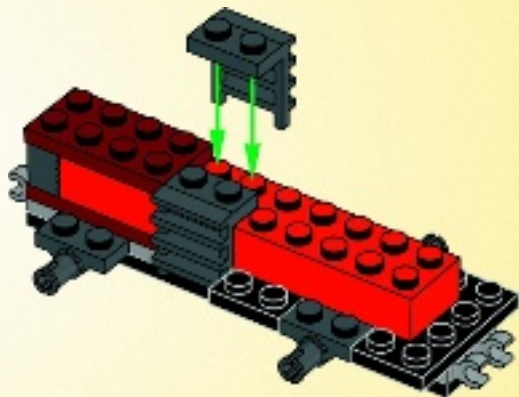

8

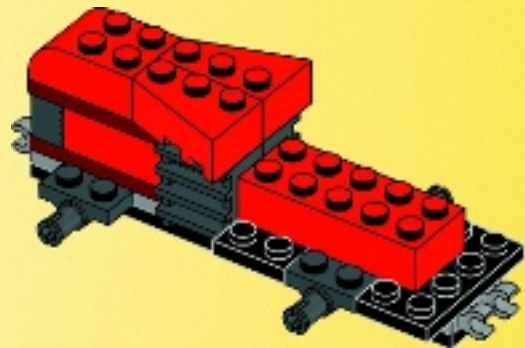



2x

9

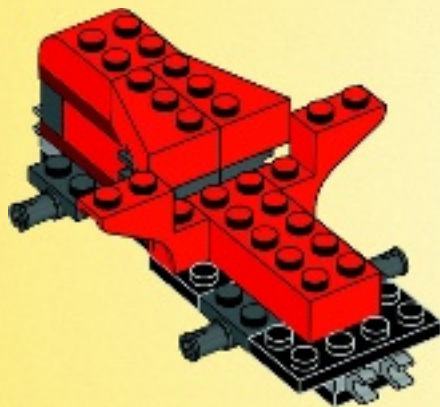



2x

10

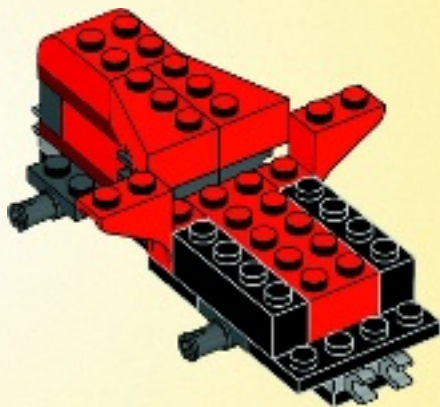

1x



2x

11

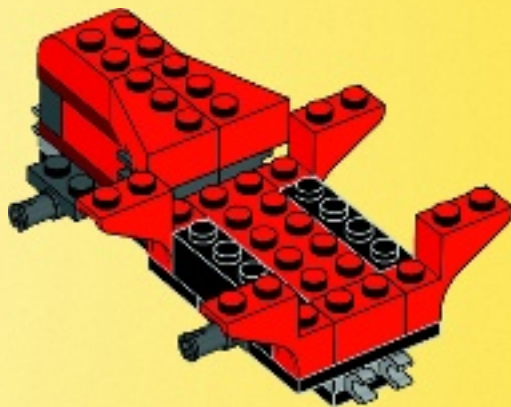



3x

12



3x

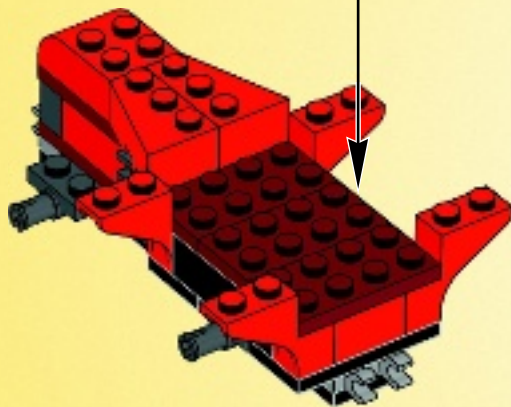

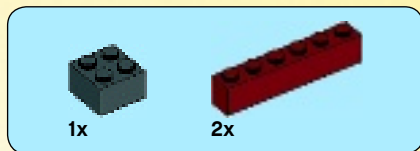

13

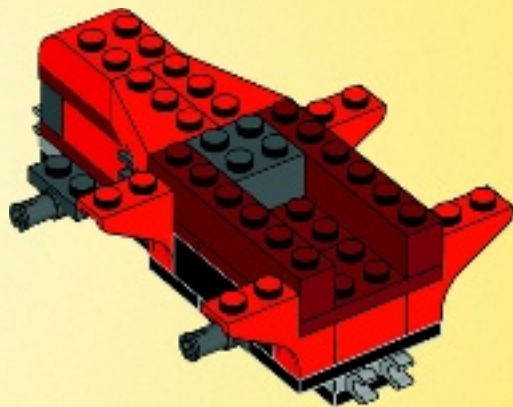

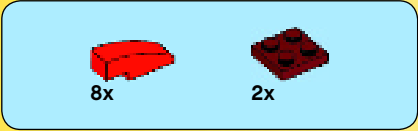

14

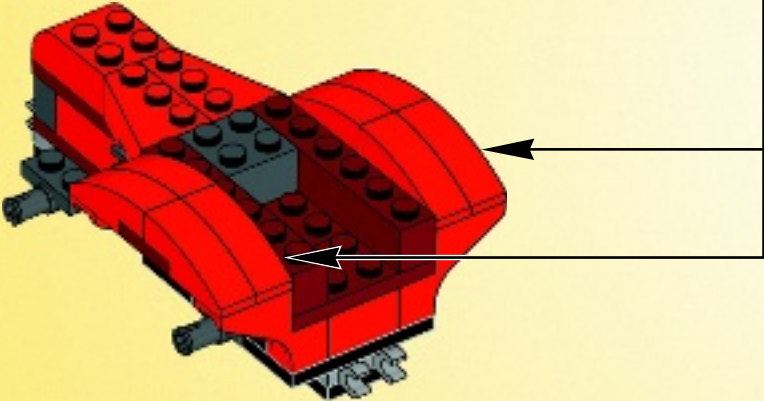
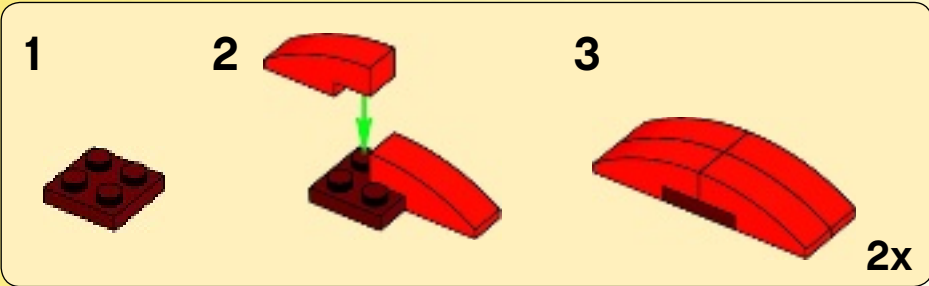



2x



2x



2x

15

1



2



1



2

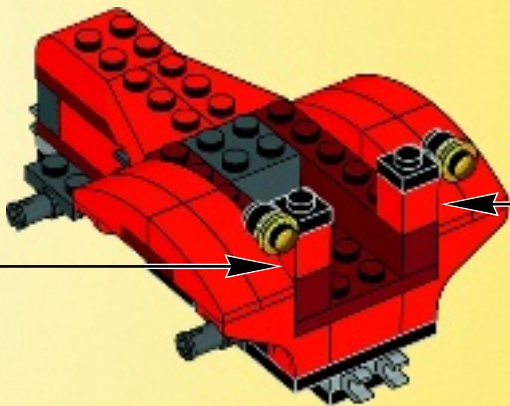



1x



1x

16

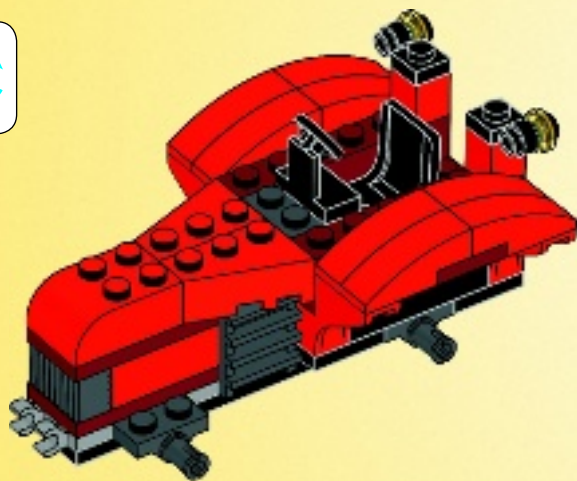
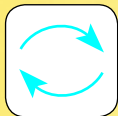

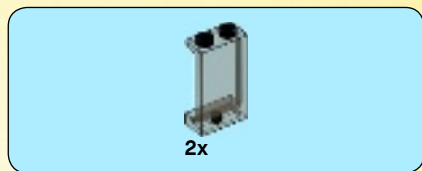

17

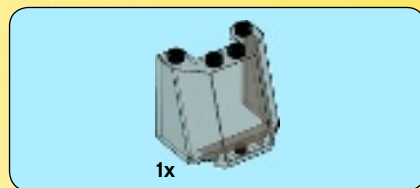
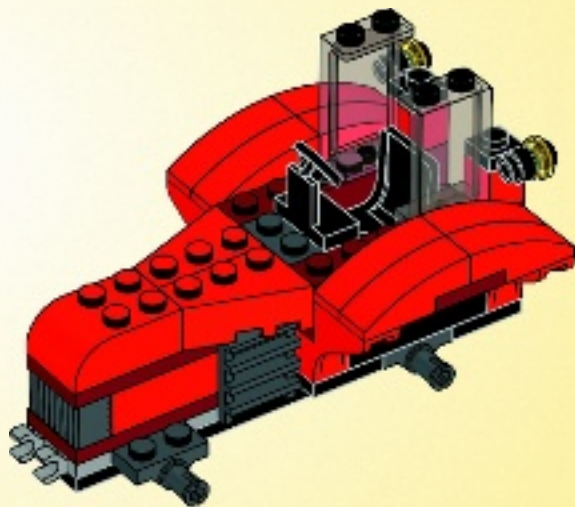

18

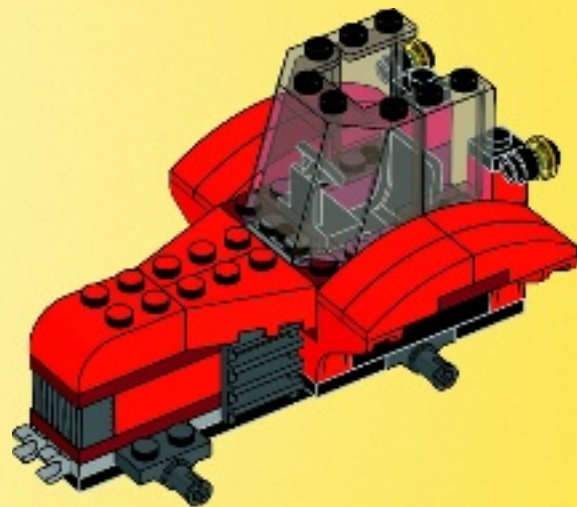



1x



1x

19

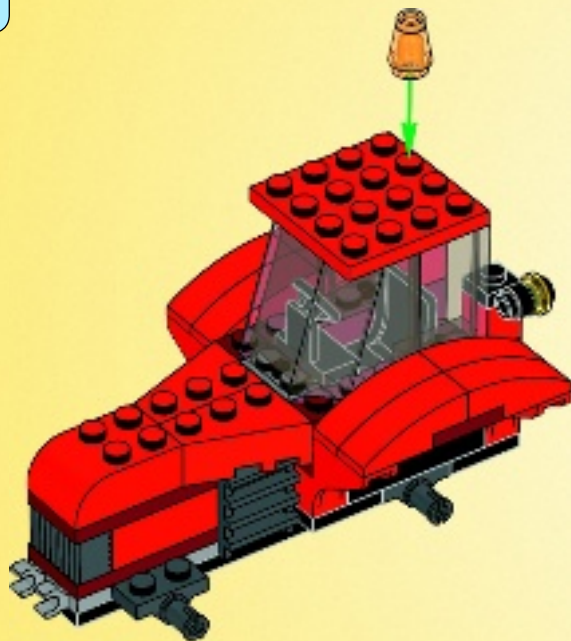



1x



1x

20

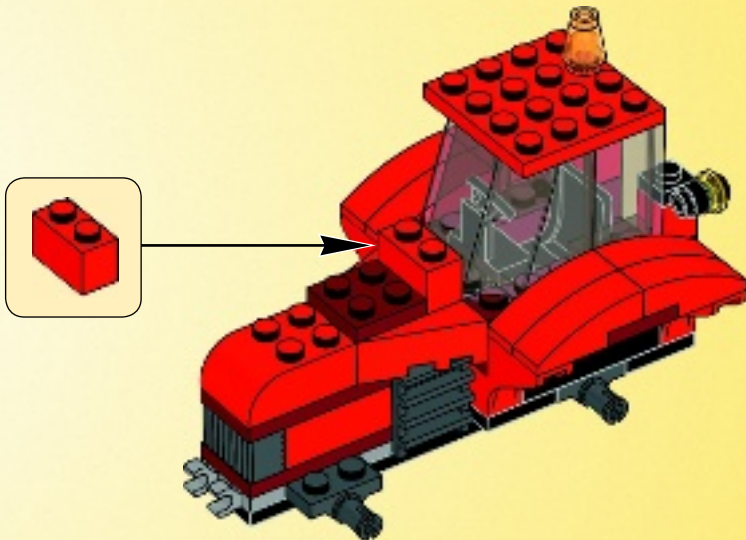



2x



1x



1x

21

1



2



3

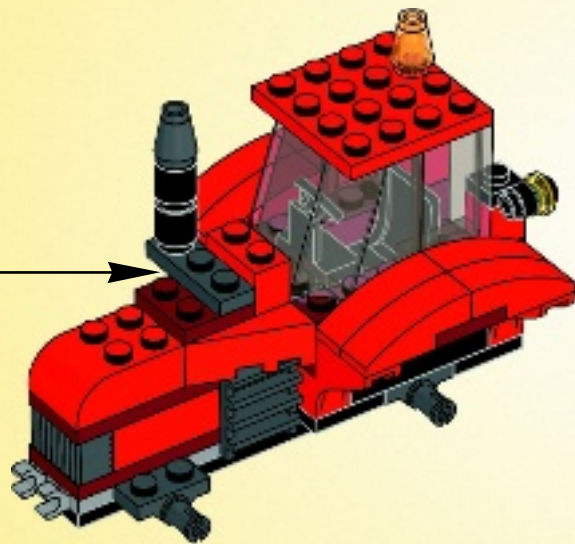



1x

22

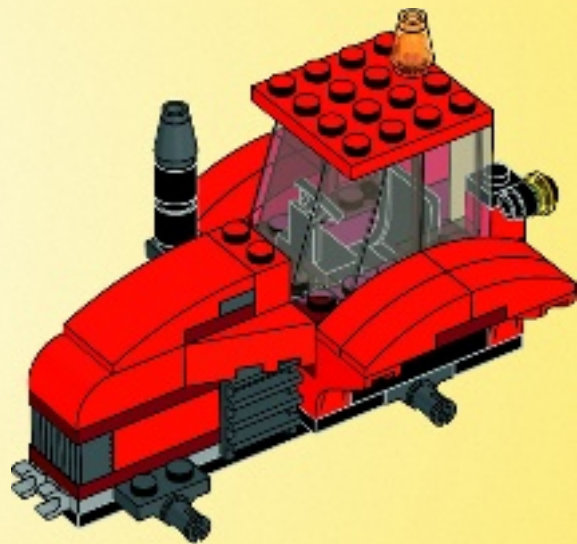



23

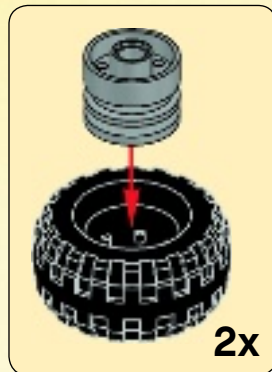
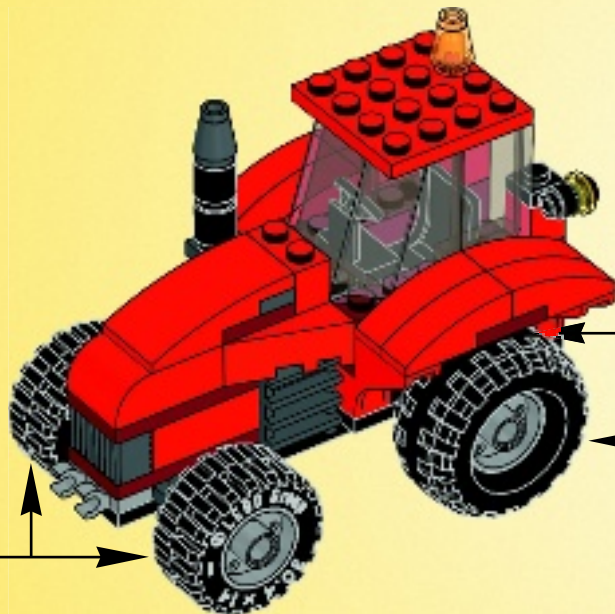
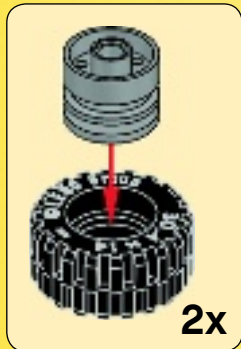



1x

1



1x



1x

2

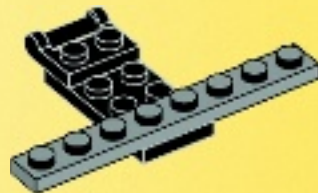



1x

3

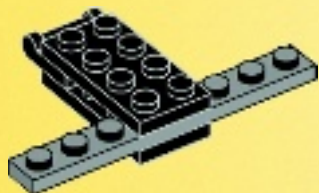

2x

4

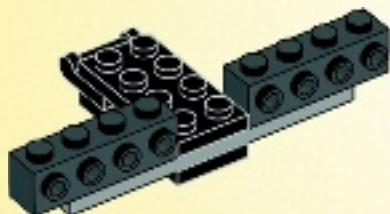



2x

5

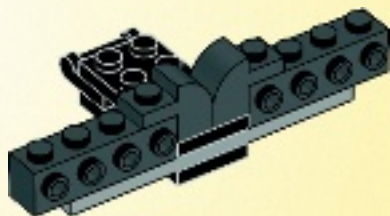

2x

6

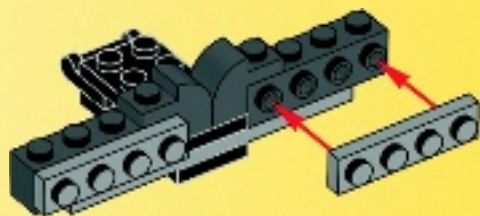

24

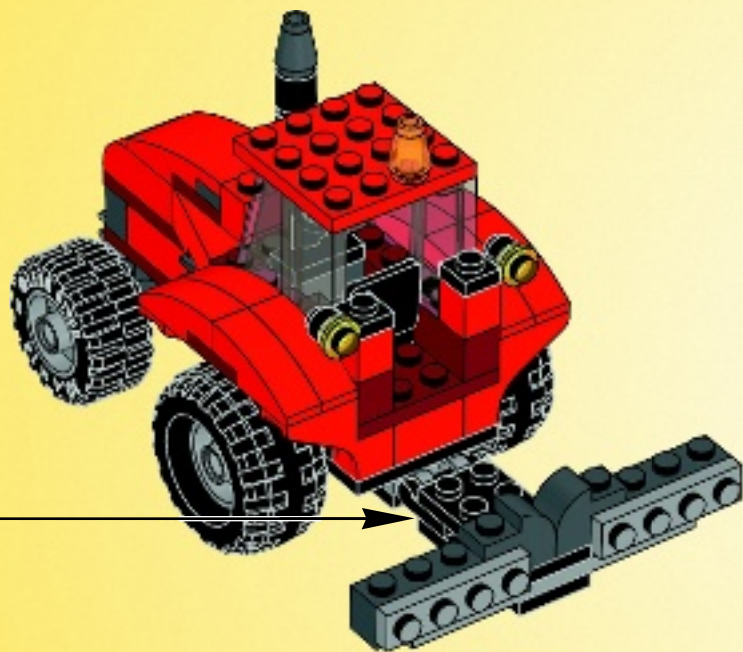
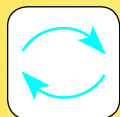



4x

25

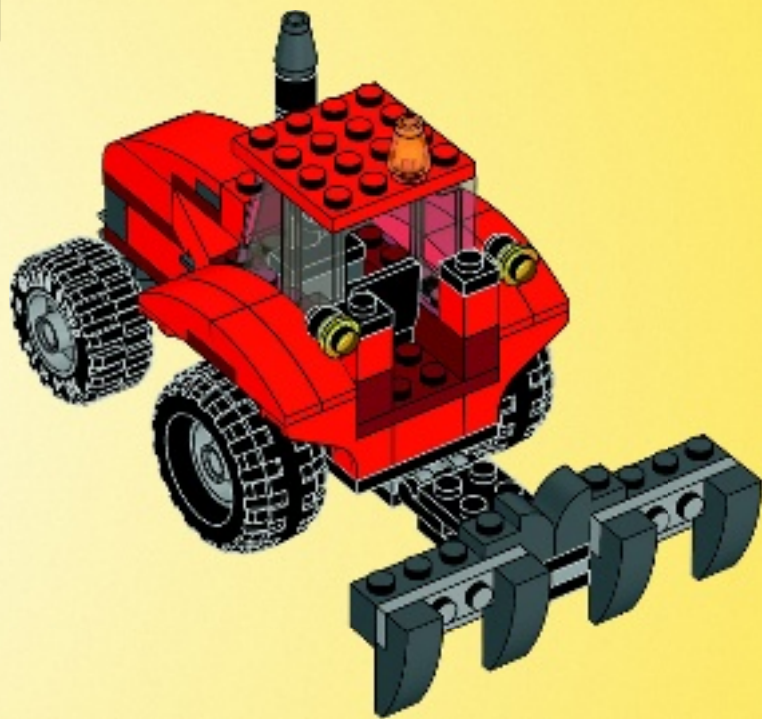



1x



1x

1

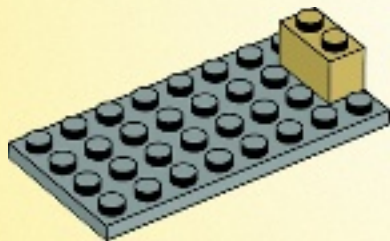



2x



1x

2

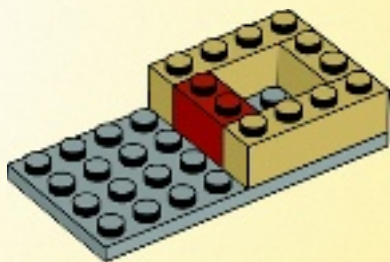

2x



1x

3

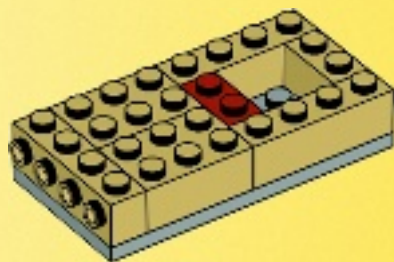



2x



1x

4



2x

5

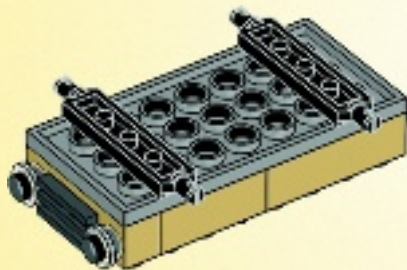
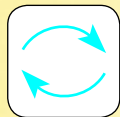



6

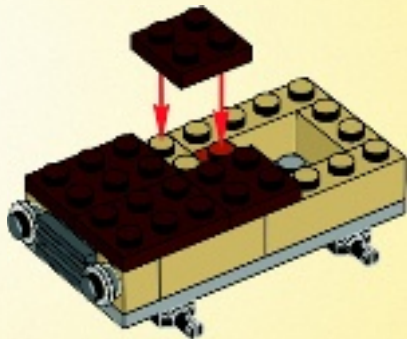
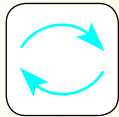

7

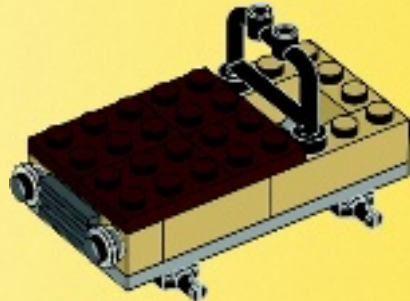



2x



1x

8





1x

9

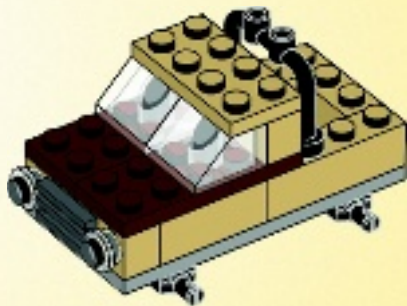

4x



4x

10



4x

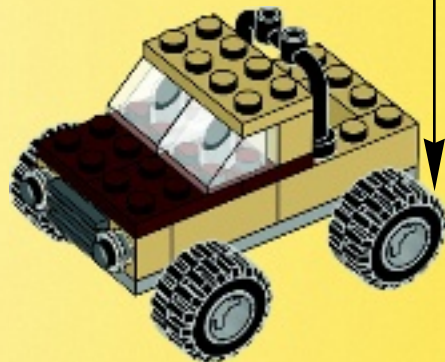



1x

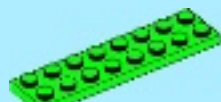

1x

1

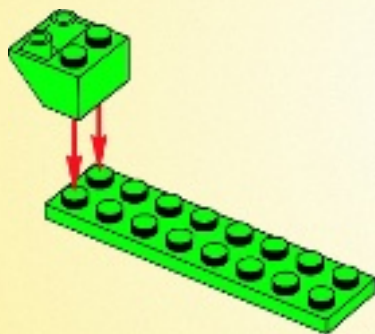

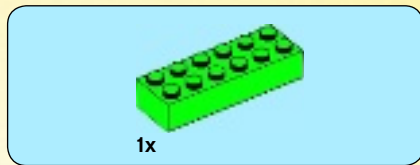

2

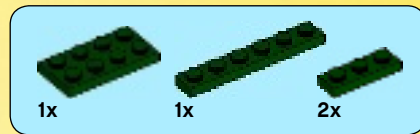
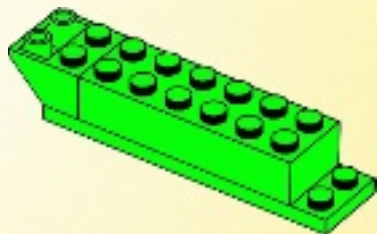

3

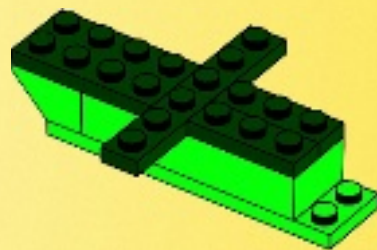



4

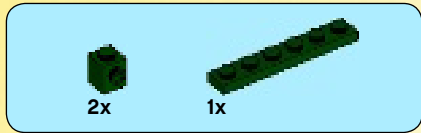
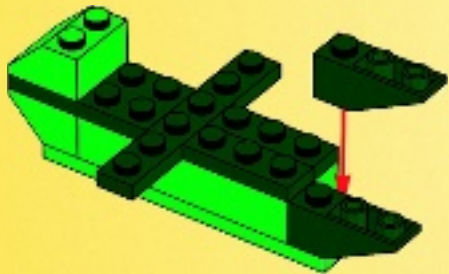

5

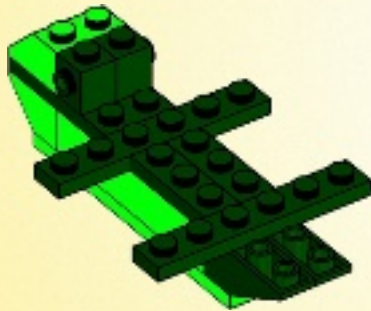



1x

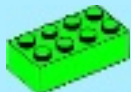

1x

6

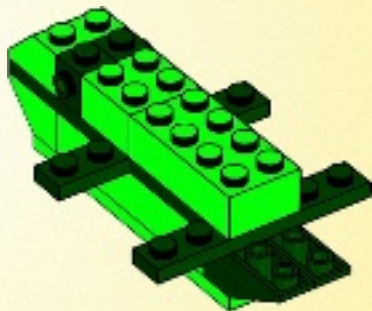

4x

7

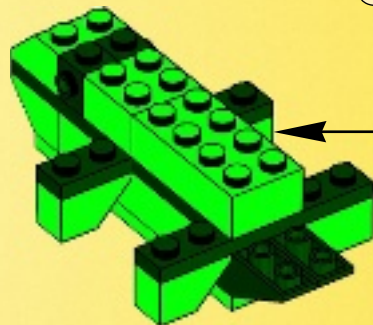

4x



4x

8



4x

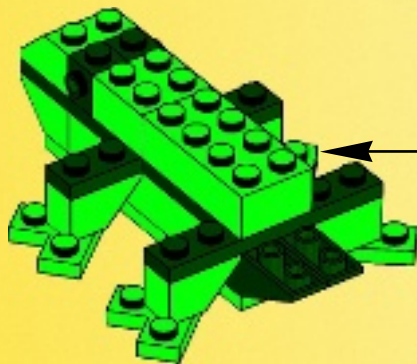

4x



4x

9

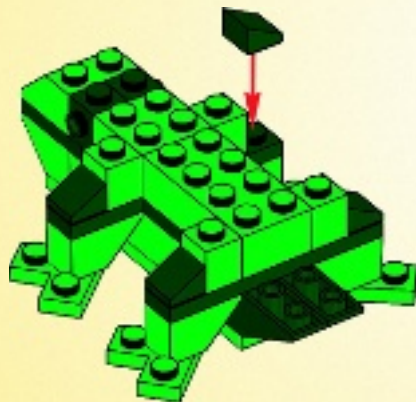

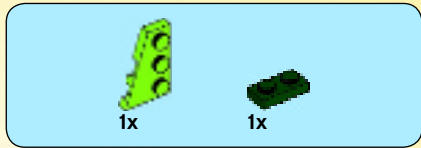

10

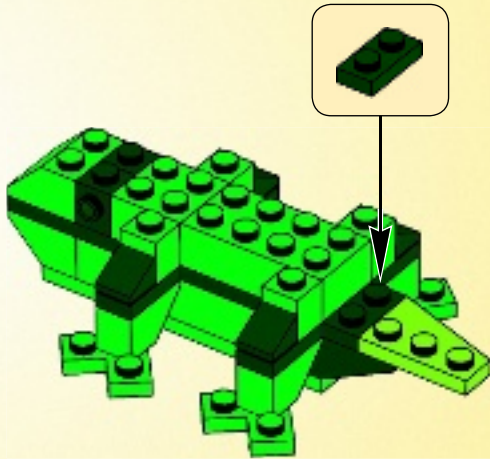

11

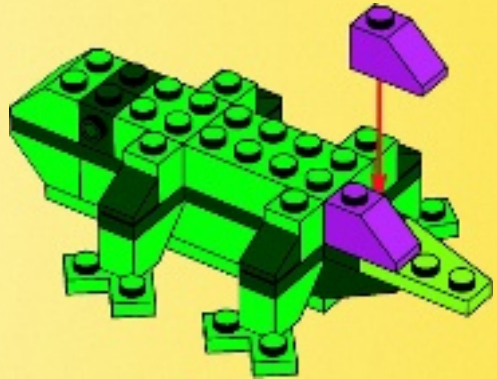



12

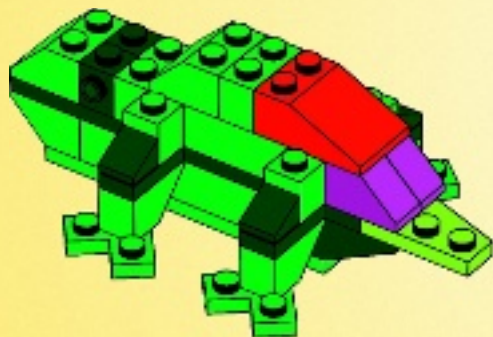



4x

13

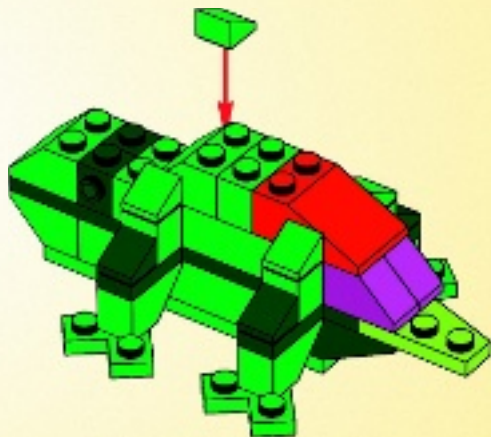

2x

14

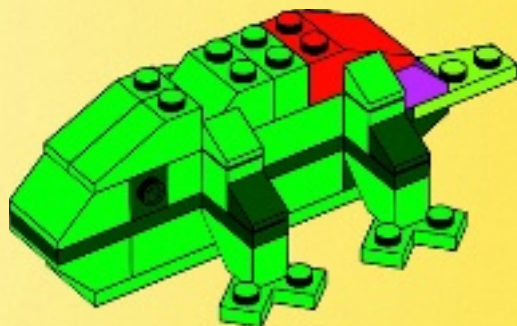



2x



2x

15



2x

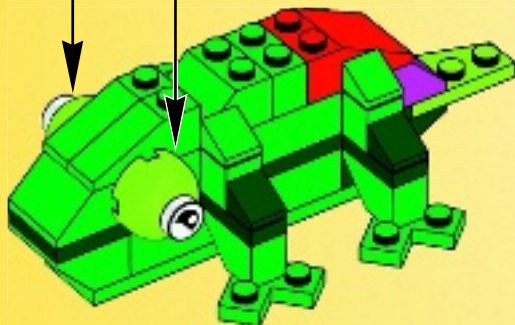

2x



2x



1x

16

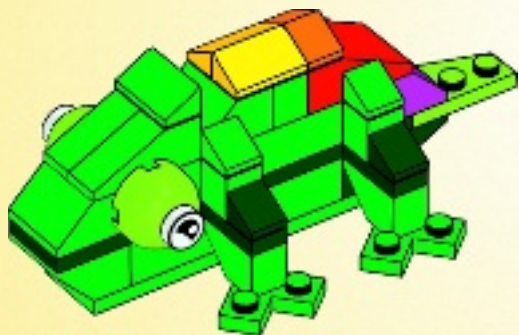

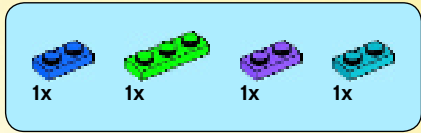

17

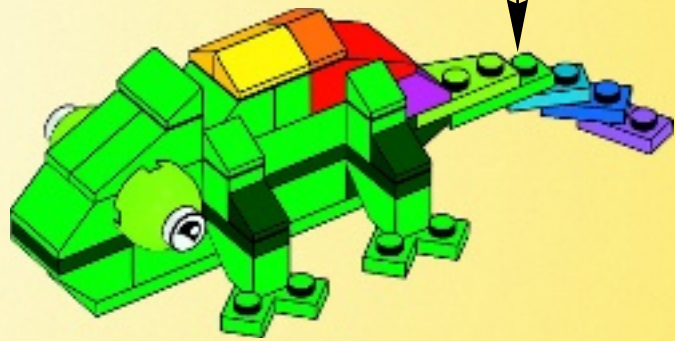
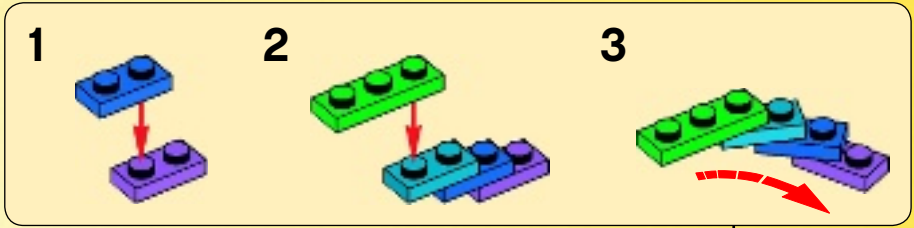



More ideas online:
LEGO.com/classic

More ideas online:
Weitere Ideen online:
Plus d'idées en ligne :
Más ideas en Internet:
Mais ideias online:
Online még több ötletet találsz:
更多在线构思:
LEGO.com/classic





CREATOR



31026



31031



31036



3 IN 1

LEGO.com/creator

LEGO CLASSIC



10696

10692



10701

10699



10693

10694



4x
300501

8x
300401

12x
300301

4x
300201

8x
301001

8x
300101

4x
300901

2x
300801

2x
6099548

2x
6029156

6x
462401

2x
4121932

2x
6023806

4x
306801

2x
371001

2x
4181142

1x
303201

2x
4520842

2x
4521210

1x
4521943

3x
4528140

1x
4584888

2x
383901

4x
4218749

8x
4109995

8x
4114306

8x
4162465

8x
4159739

4x
4113916

4x
4201062

4x
4113915

4x
4114084

4x
4114309

2x
6116614

2x
4569547

4x
4114319

1x
4181134

1x
4615599

8x
300521

12x
300421

8x
300321

8x
300221

4x
301021

8x
300121

2x
300921

2x
300821



1x
4617857



4x
306221



1x
4526929



1x
4527765



4x
428621



4x
329821



4x
6056816



8x
4251162



4x
621521



2x
4613174



4x
4113858



1x
4243814



3x
614121



8x
300323



4x
362223



4x
300223



4x
301023



4x
300123



4x
300923



1x
6037384



8x
4121936



4x
303923



4x
302323



4x
371023



4x
4600182



3x
4243815



2x
383223



12x
300523



12x
300423



1x
6055328



4x
300524



8x
300424



8x
300324



4x
362224



8x
300224



4x
301024



8x
300124



1x
4181143



2x
300824



1x
4639693



1x
4218725



4x
306224



4x
4550348



4x
303924



4x
243124



3x
614124



4x
300526



4x
300426



8x
300326



4x
300226

4x
292126

4x
306226

8x
301026

4x
300126

2x
300926

4x
302026

2x
379526

2x
244526

4x
306926

4x
4565323

4x
371026

4x
4632571

4x
4185620

1x
243226

4x
4225201

4x
459926

1x
407926

1x
408326

6x
4578677

4x
4568644

4x
4619323

2x
4506553

2x
292626

1x
73081

1x
4144567

2x
368026

4x
300528

8x
4107736

8x
300328

4x
4109679

8x
4109674

4x
4112838

8x
4106356

4x
4111844

1x
4181135

2x
4143953

4x
4546705

3x
6000071

4x
4142989

4x
303928

4x
4142717

4x
4107637

5x
4157120

2x
4107758

1x
303428

8x
4645394

8x
4579659

4x
6000743

2x
6000748



2x
622740



3x
3005740



2x
6024020



2x
4521504



1x
4594686



4x
306541



4x
306543



4x
306544



3x
3005740



4x
4567333



4x
6081496



4x
4173805



8x
4121739



12x
4153825



4x
4118787



8x
4153826



4x
4118827



8x
4153827

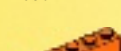

2x
4189007



2x
4118828



1x
4654448



2x
6010736



1x
4167504



1x
4543458



4x
4504371



4x
4160593



2x
4650690



4x
4226179



4x
4198311



4x
6096995



4x
4220634



4x
4164022



8x
4220632



4x
4220631



8x
4234716



8x
4165967



4x
4537919



4x
4212454



2x
4279734



4x
6030276



4x
4650630



4x
4537928



4x
4164021



4x
4187743



3x
4183133



1x
4539907



1x
4539908



4x
4519195



4x
6056373



4x
6056382



4x
4625626



8x
4518889



4x
6037650



2x
6022656



3x
6056292



4x
6115085



2x
4654105



4x
6099347

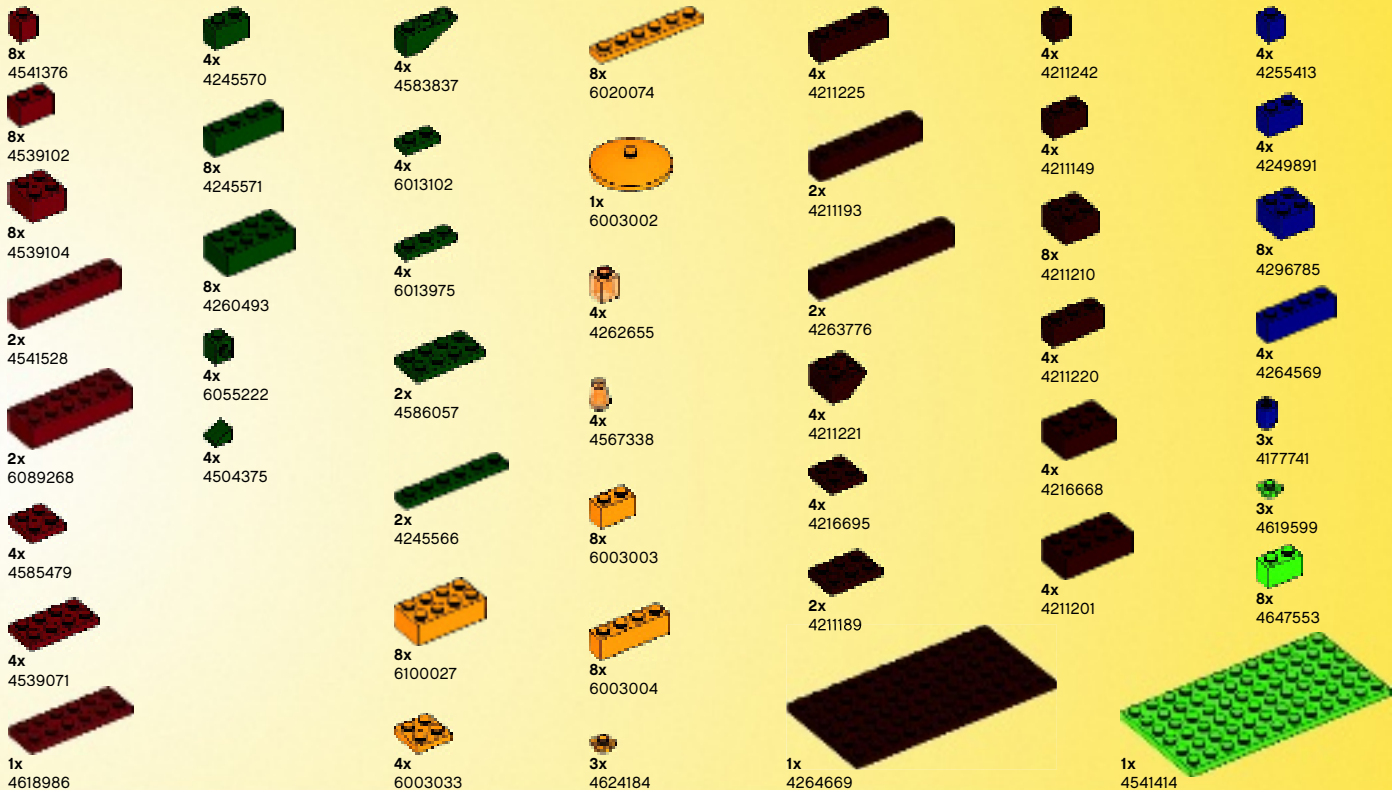

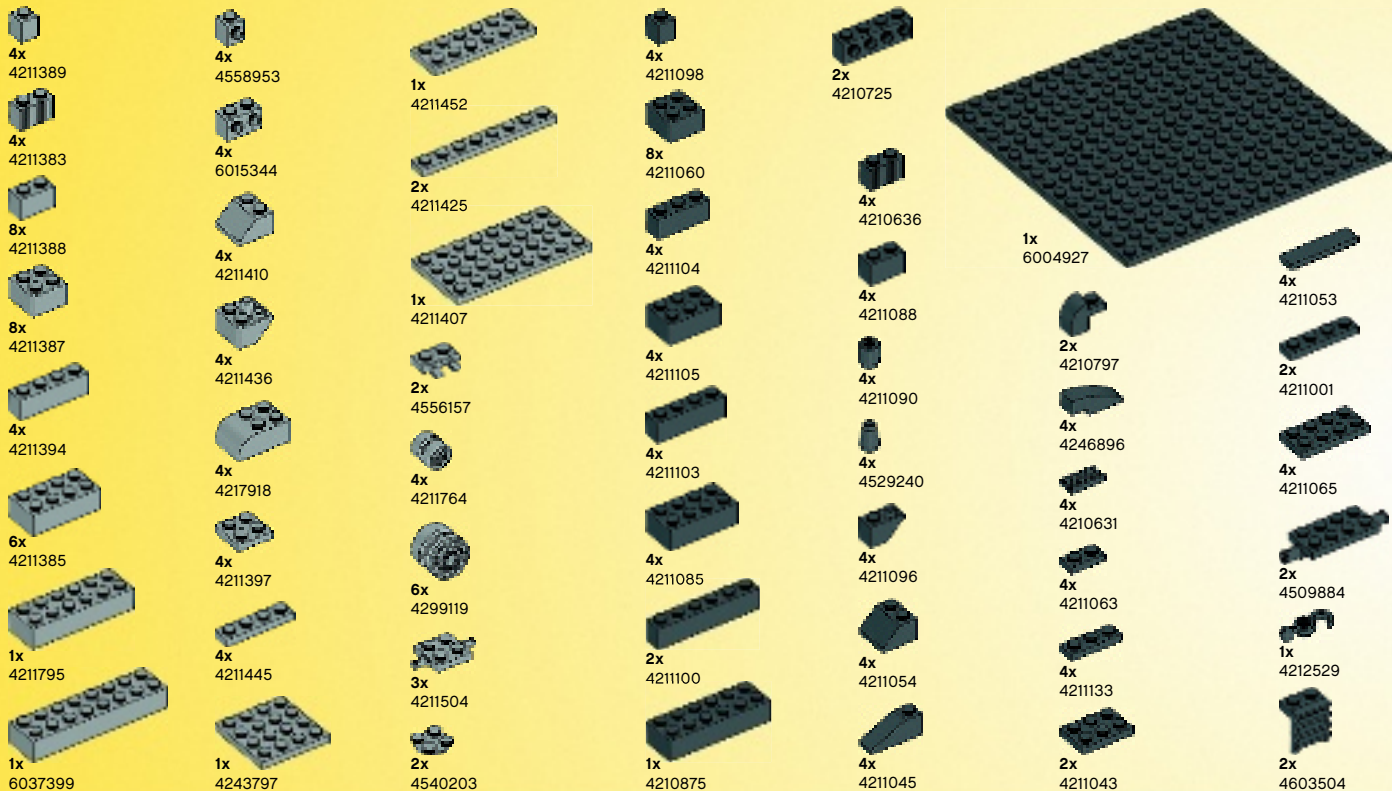



Customer Service

Kundenservice

Service Consommateurs

Servicio Al Consumidor

LEGO.com/service or dial



: 00800 5346 5555

: 1-800-422-5346

WIN

GO TO WWW.LEGO.COM/PRODUCTFEEDBACK AND
GIVE US YOUR SHORT **FEEDBACK** ABOUT THIS
LEGO® SET FOR A CHANCE TO WIN
A COOL LEGO PRIZE.



LEGO.com/productfeedback

GEWINNE



Erzähle uns auf
www.LEGO.com/productfeedback

etwas über die Erfahrungen, die du mit
diesem LEGO® Set gemacht hast, und
sichere dir die Chance auf einen coolen
LEGO Preis!

GAGNE



Rends-toi sur
www.LEGO.com/productfeedback

et donne-nous quelques commentaires
sur ce produit LEGO® pour avoir une
chance de gagner un prix LEGO !

GANAN



Visita
www.LEGO.com/productfeedback

y envíanos tu opinión acerca de este set
LEGO®. ¡Participarás en el sorteo de un
premio LEGO!

获取奖品



登录
www.LEGO.com/productfeedback

给出关于此乐高®套装的简短反馈，
就有机会获得炫酷乐高奖品