

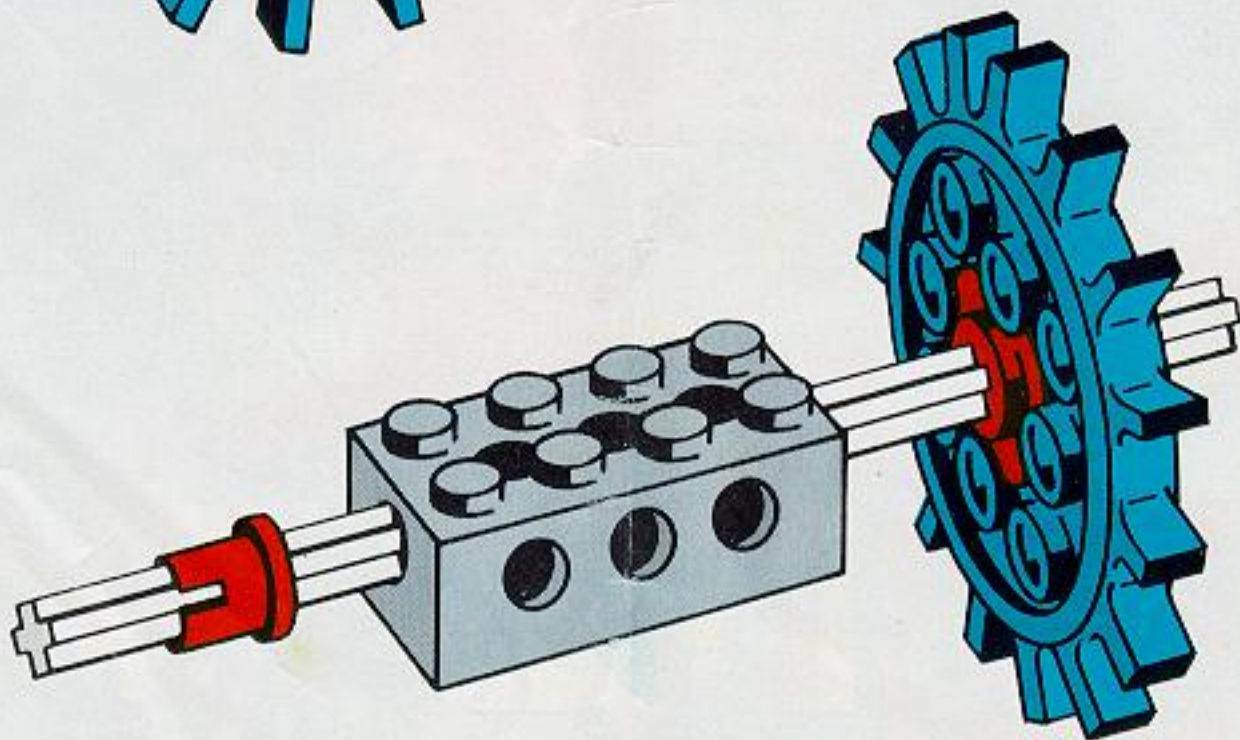

LEGO
System

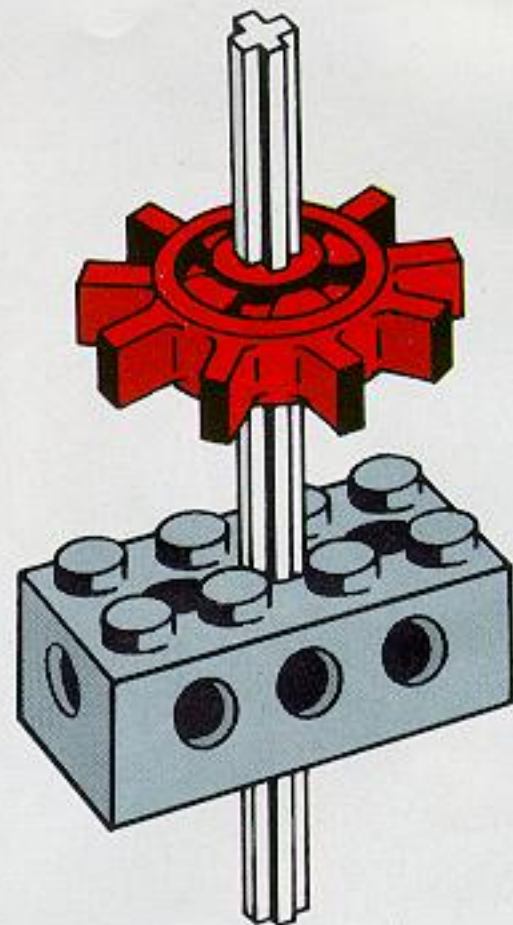

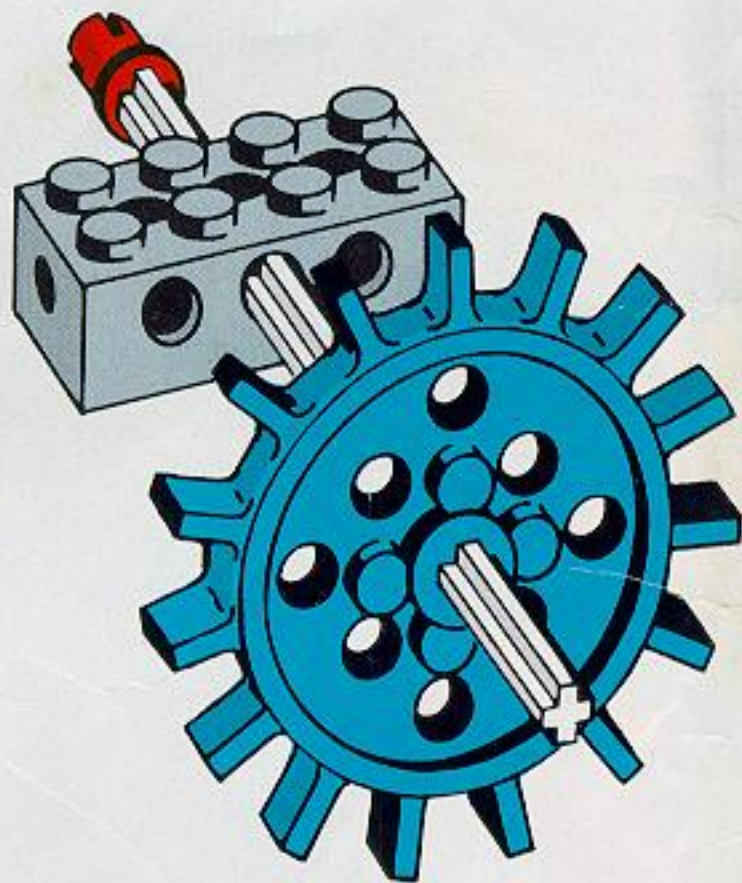

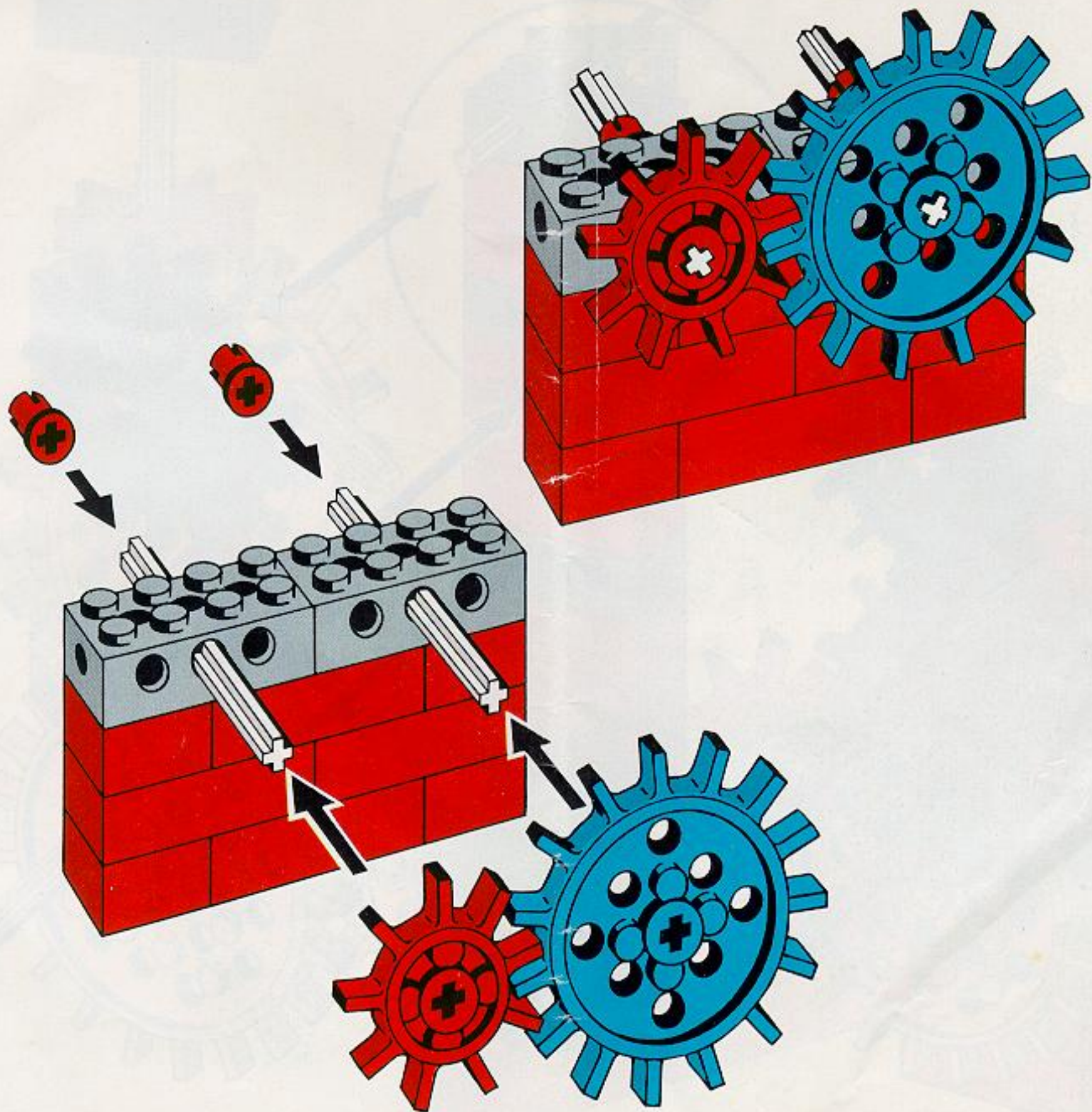

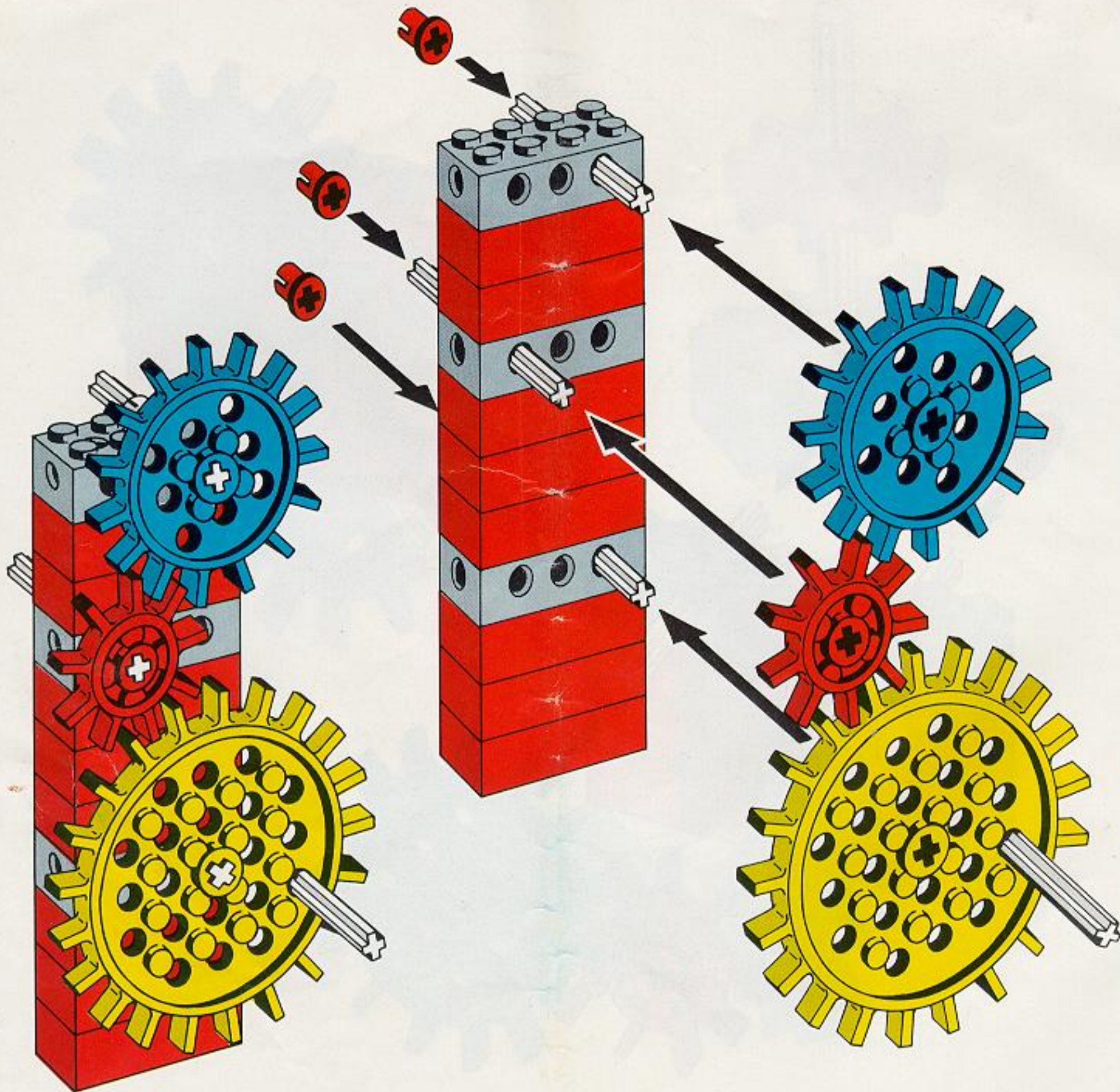

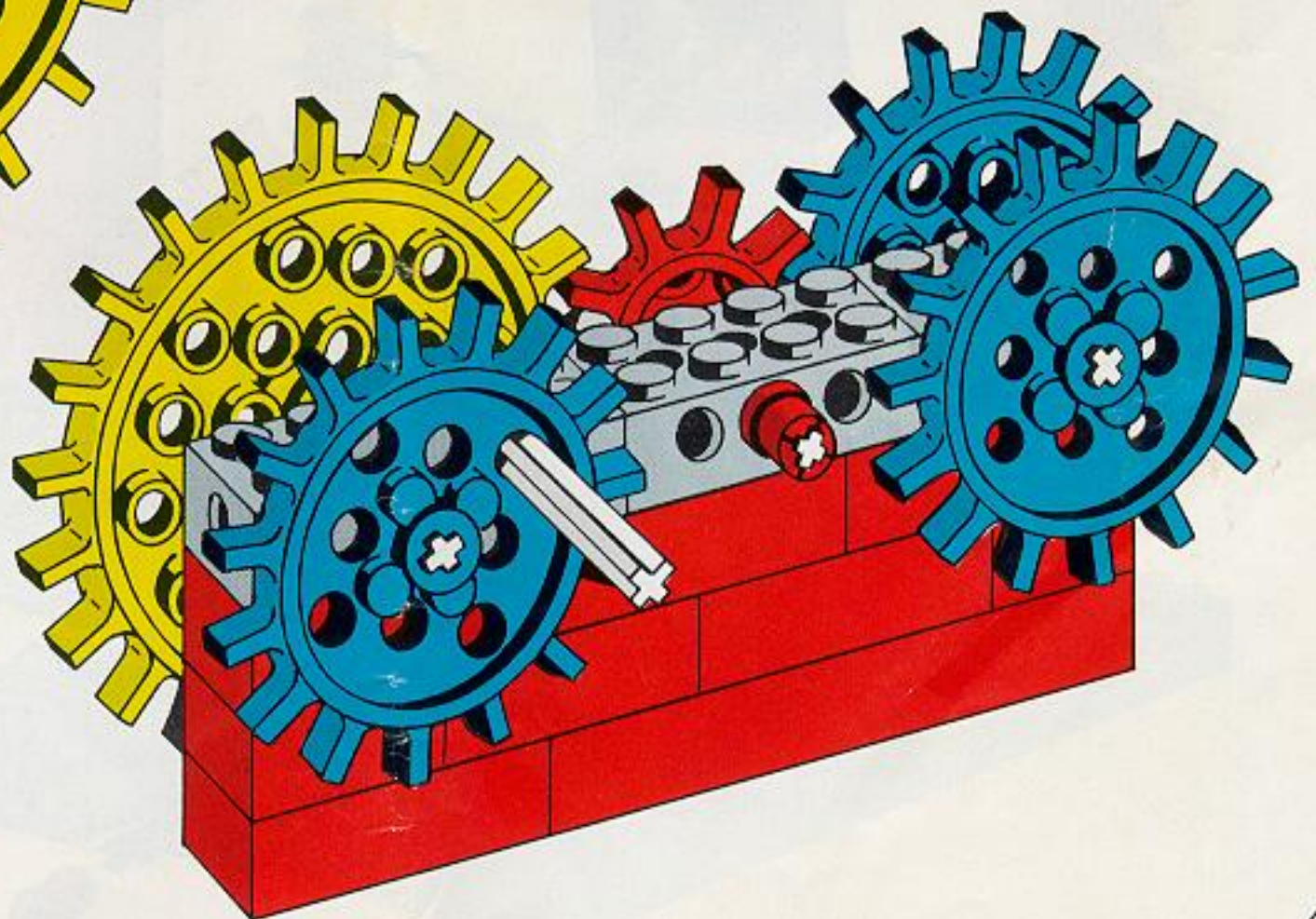
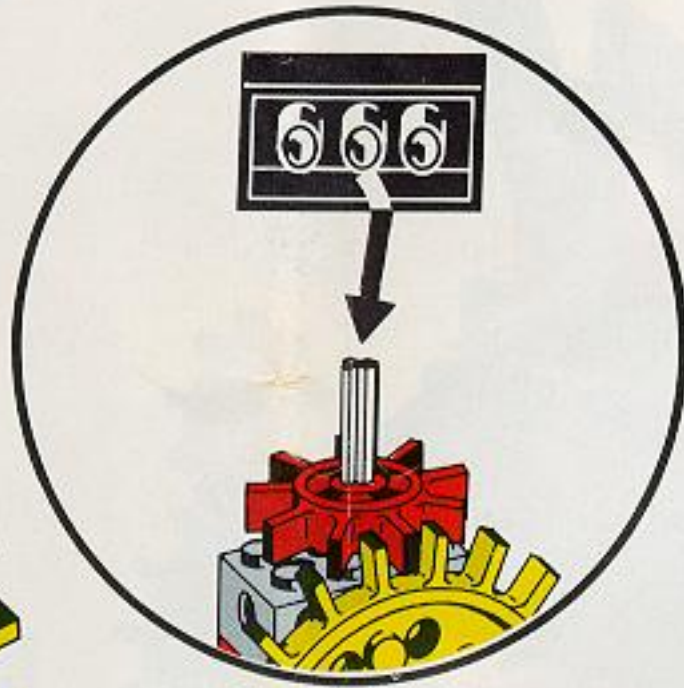
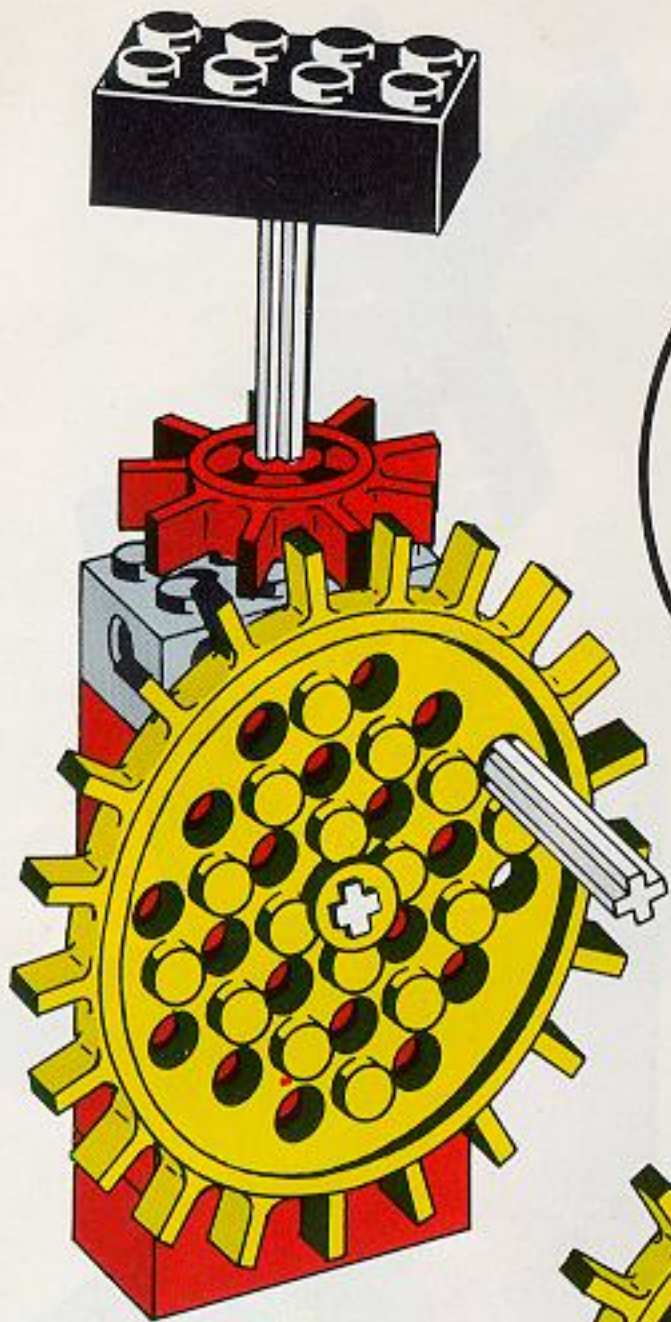

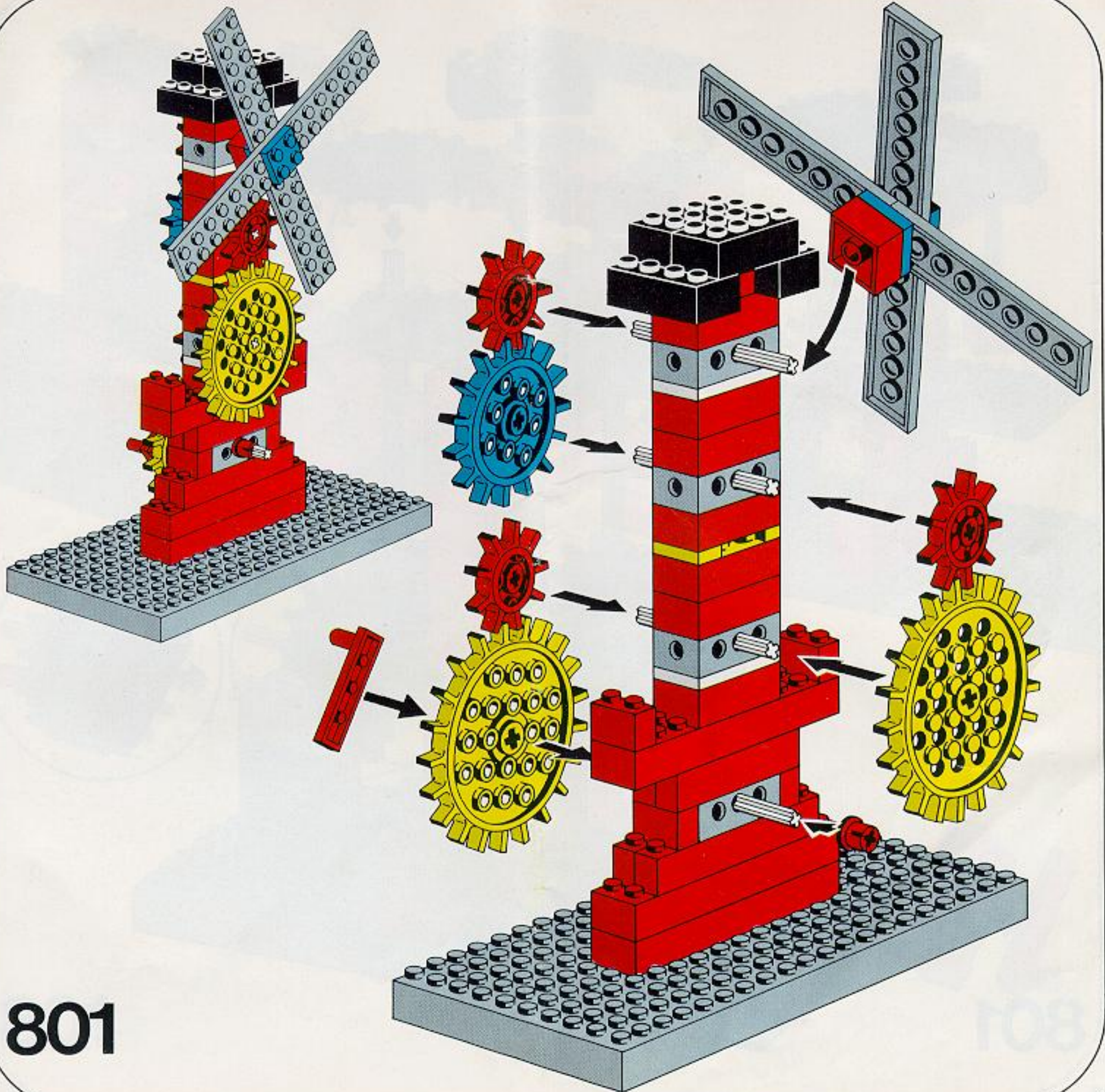

801

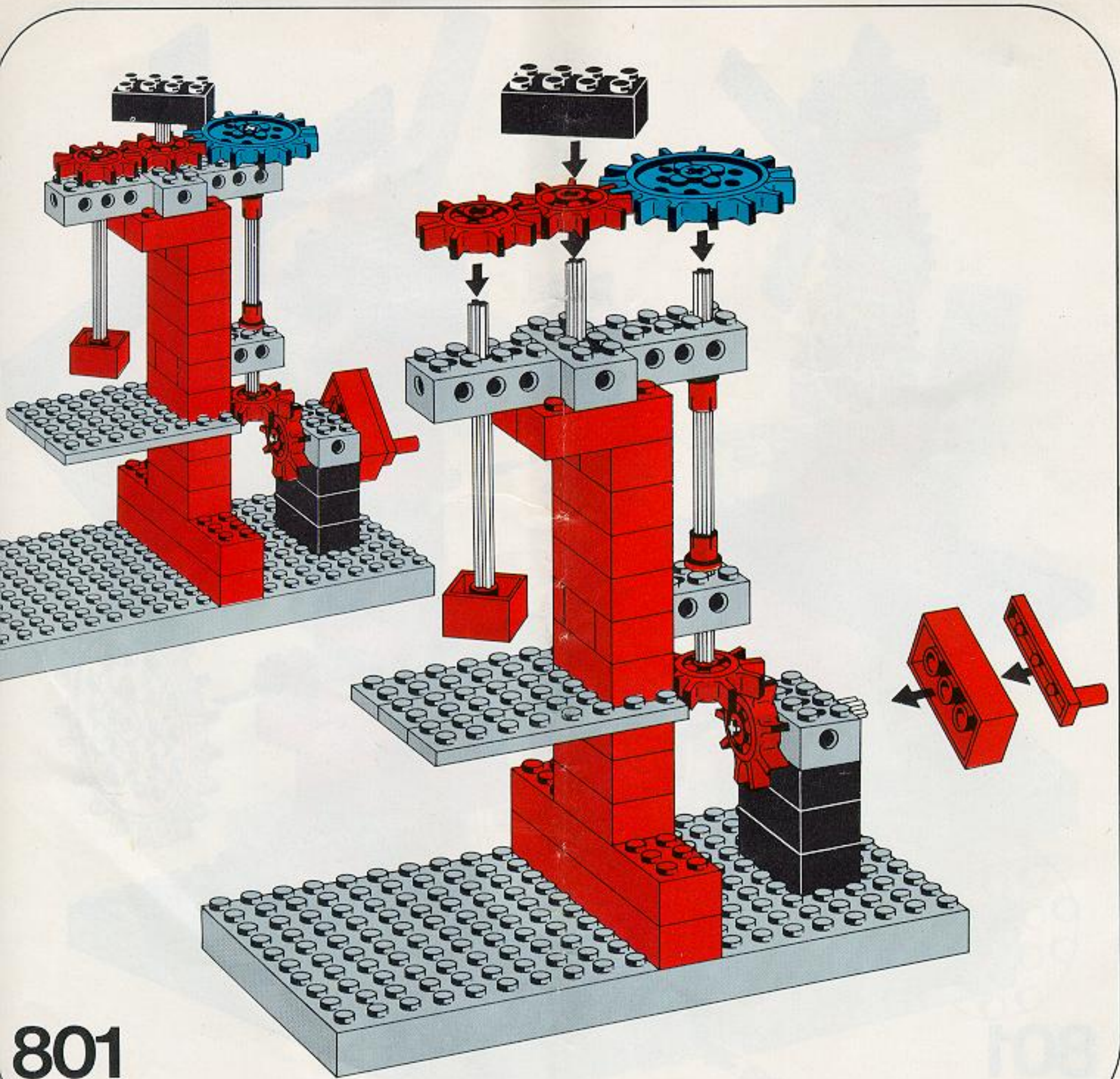

801

108

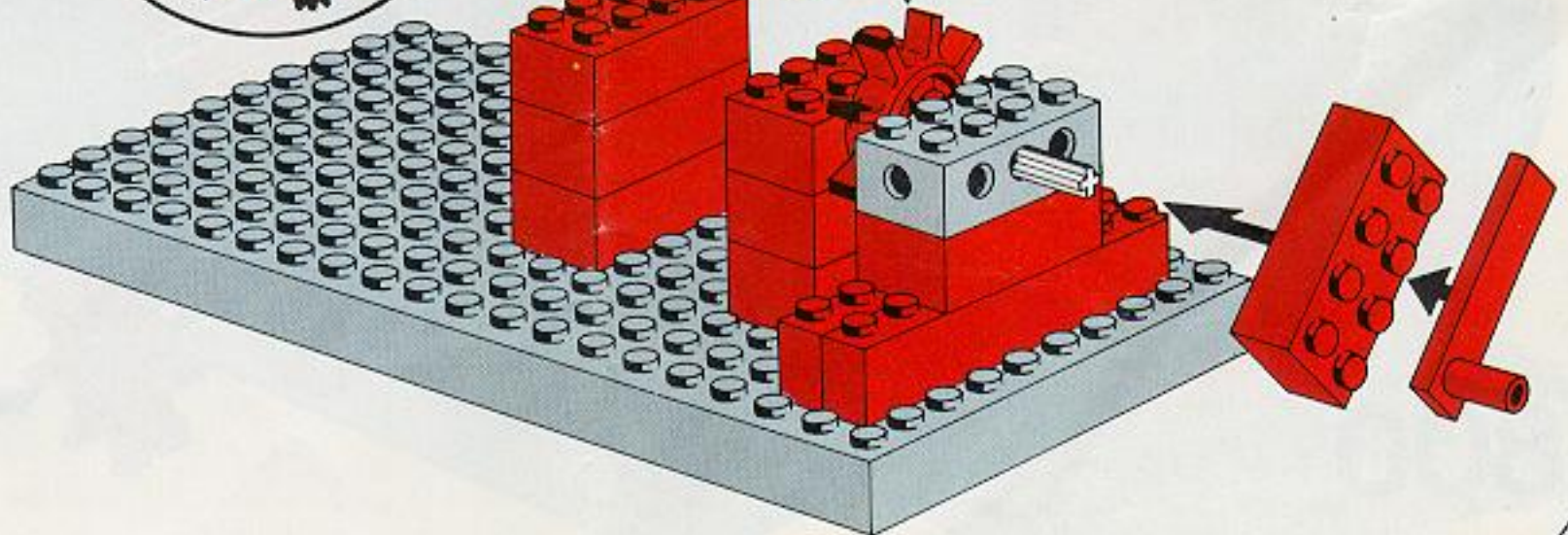
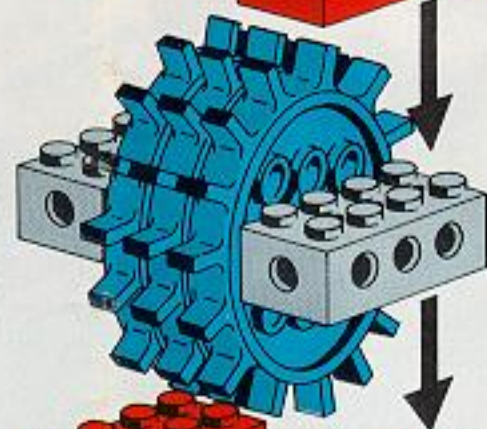
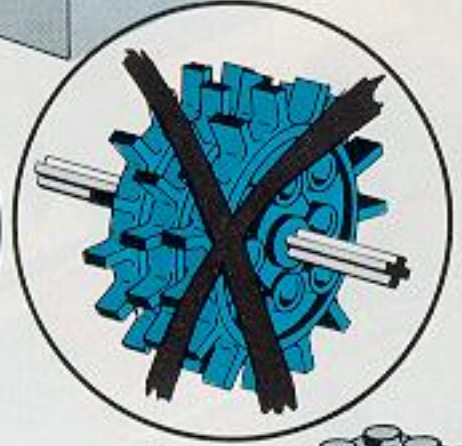
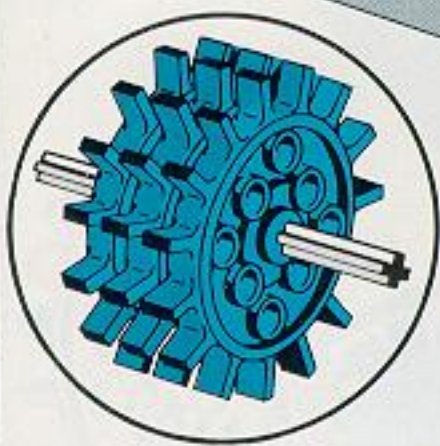
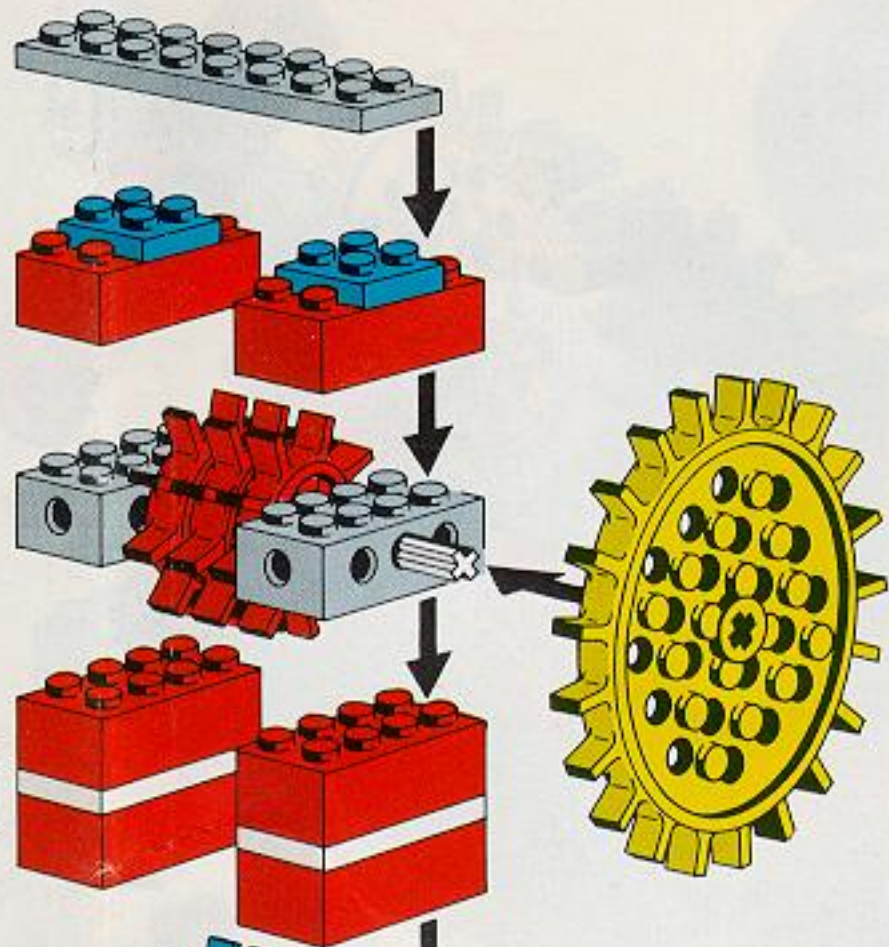
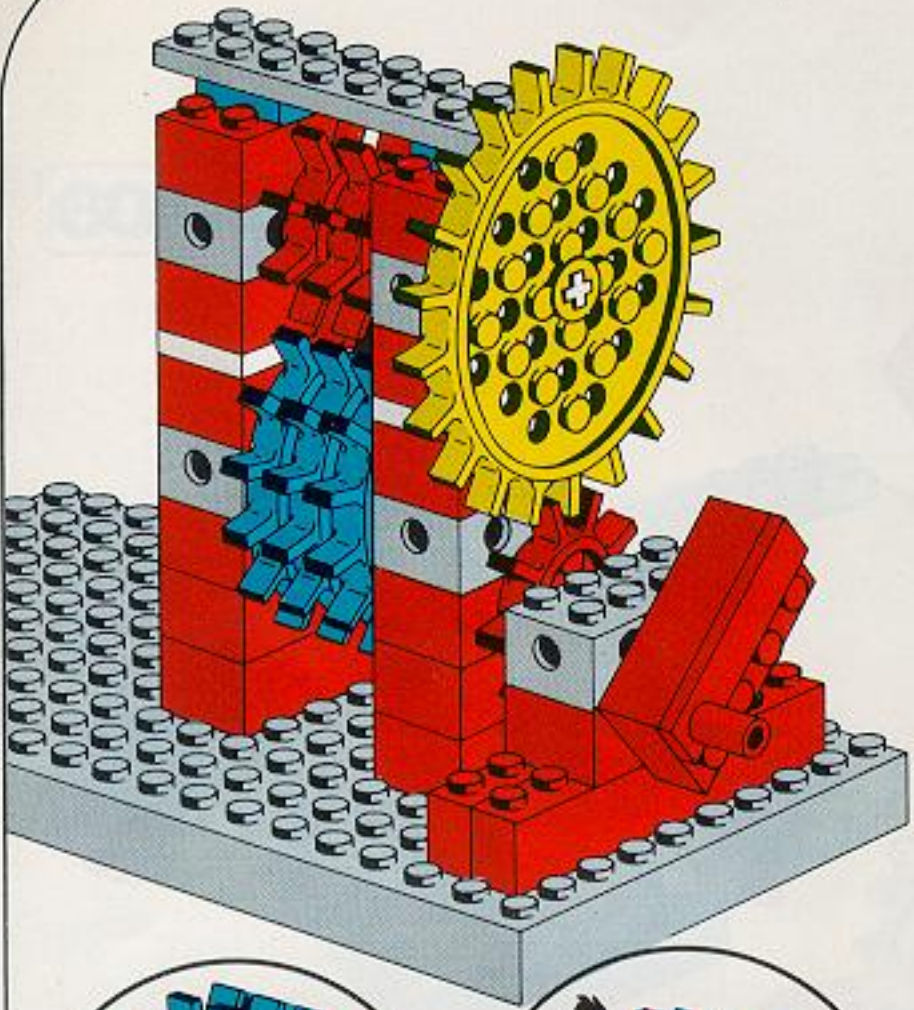

801

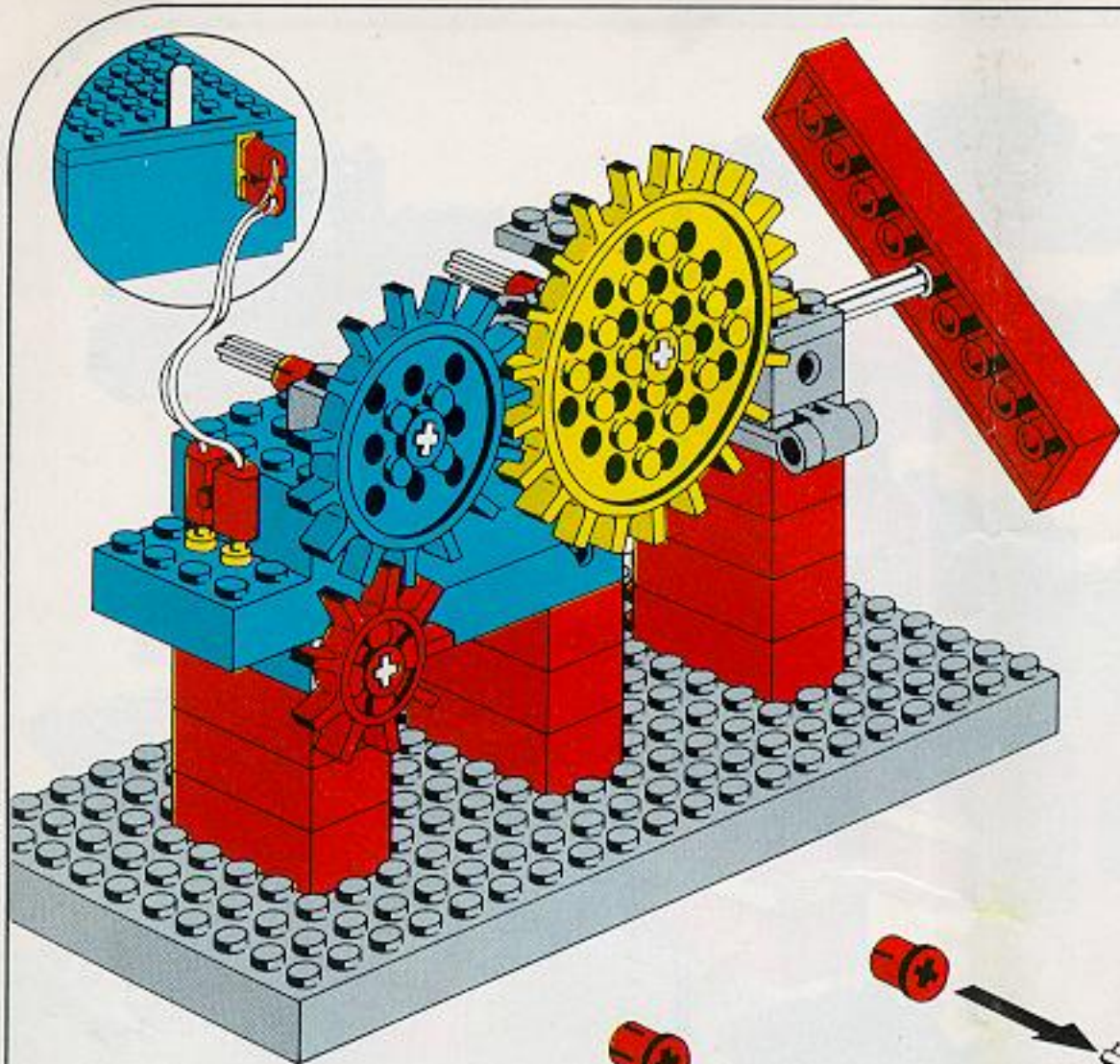

801+   = 800

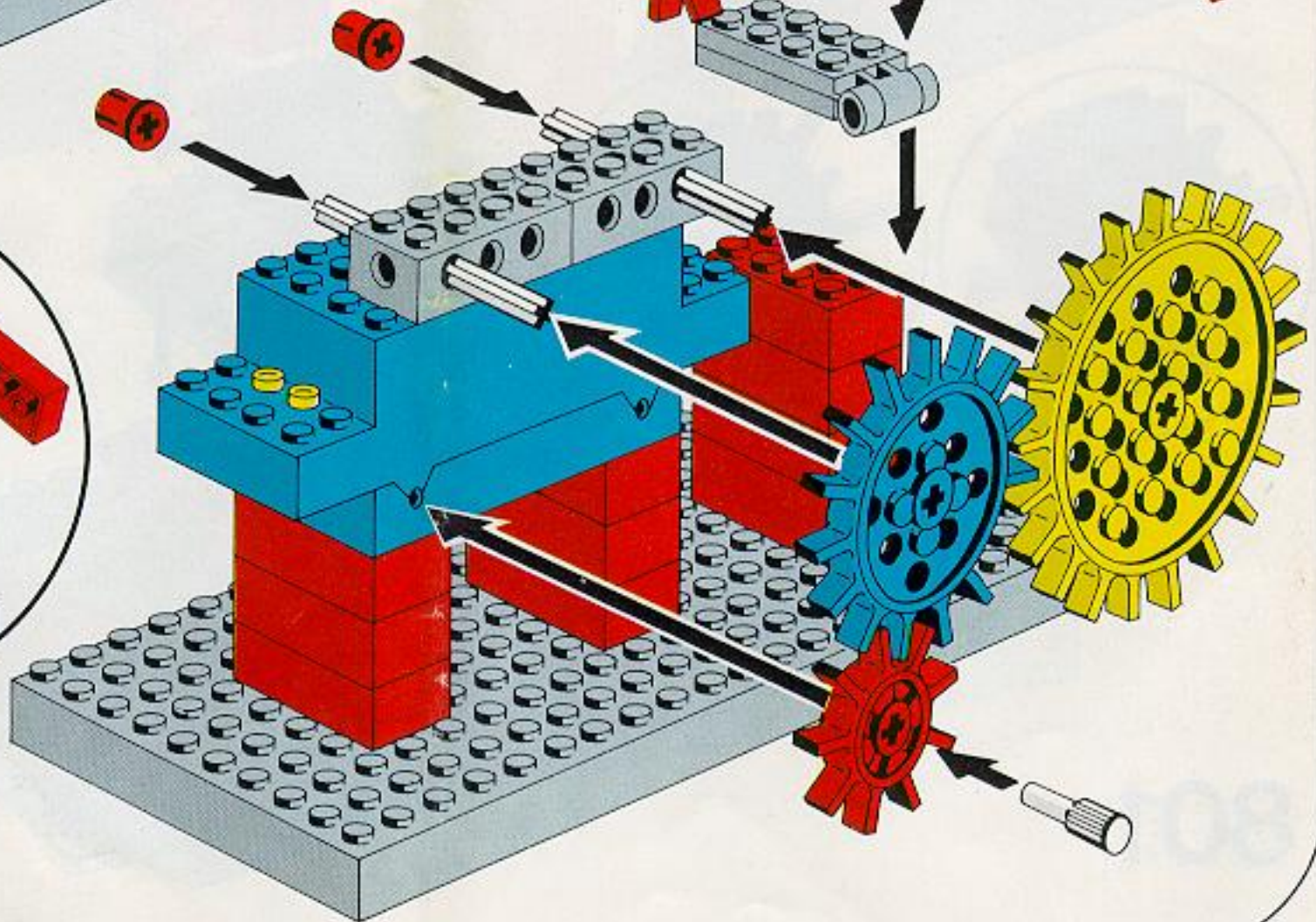
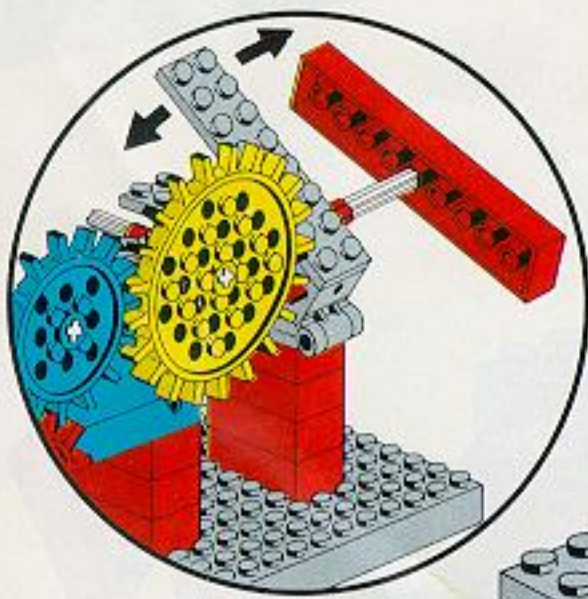
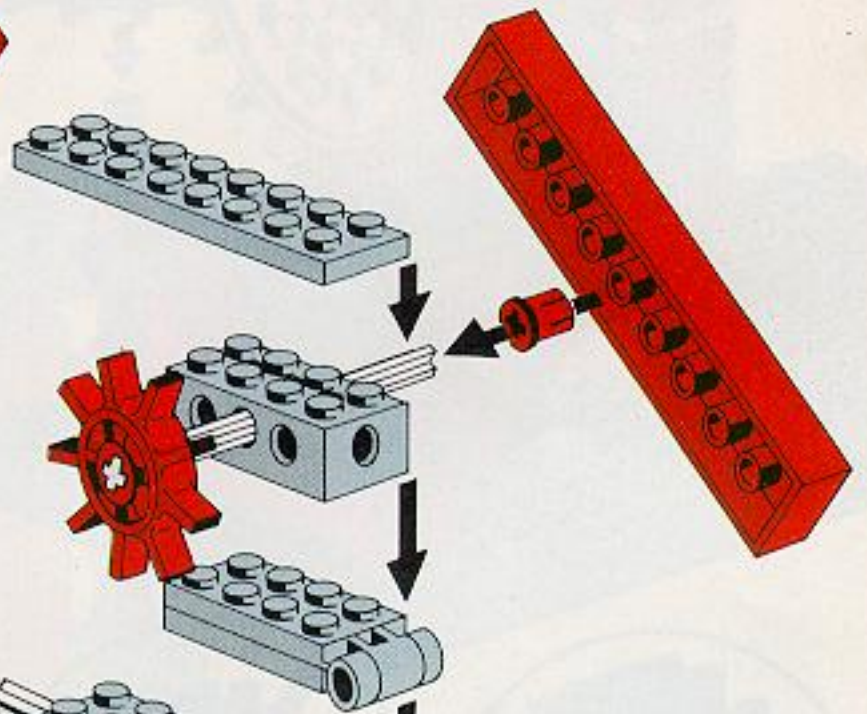

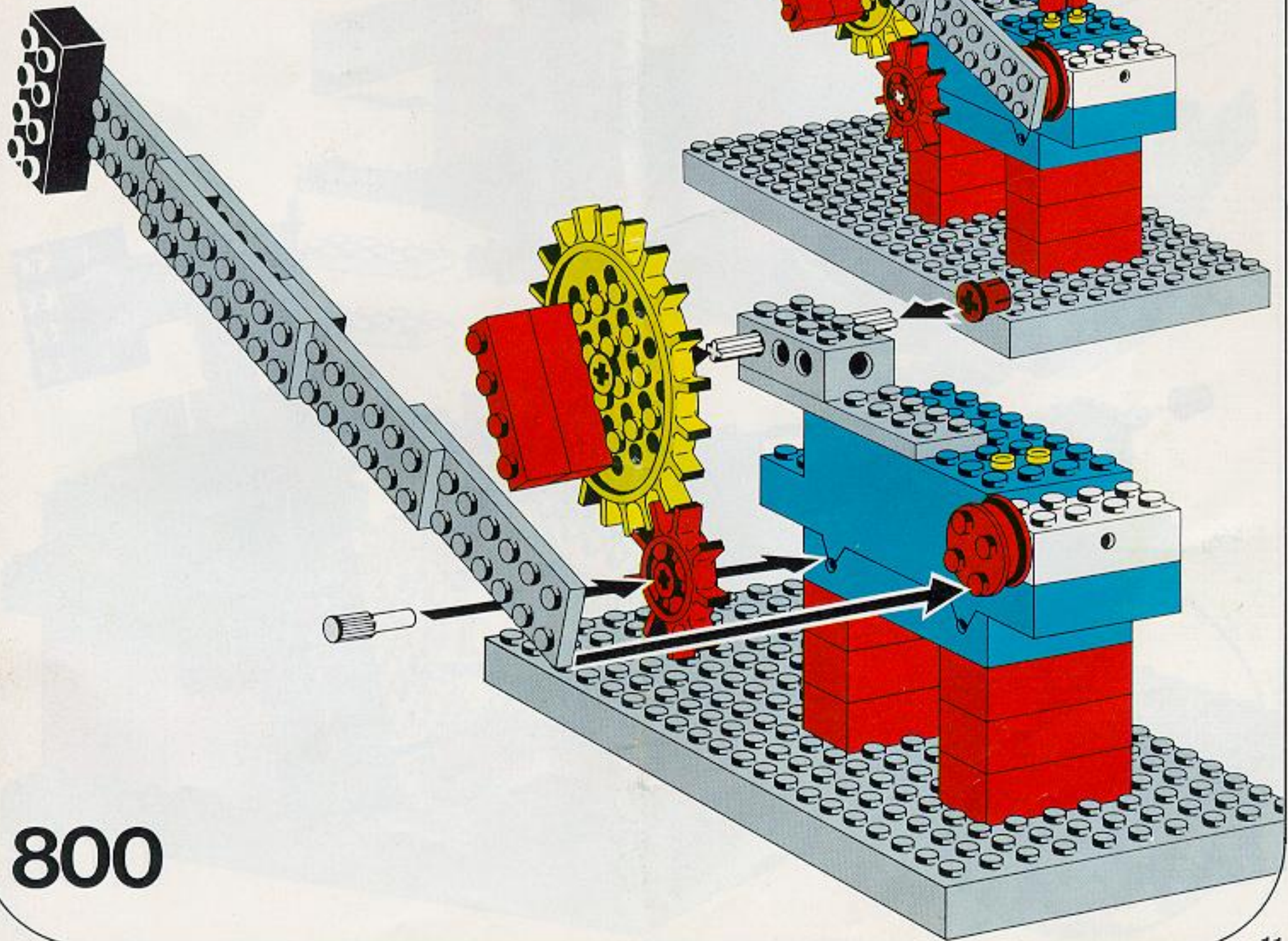

800

801+  =800

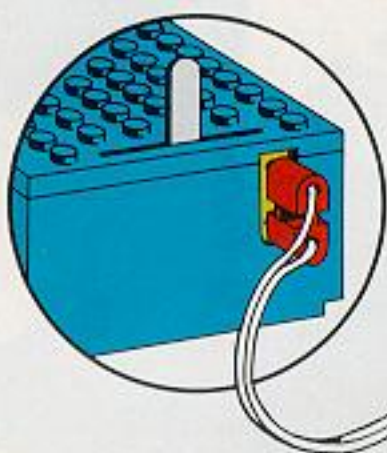

800



801+   =800

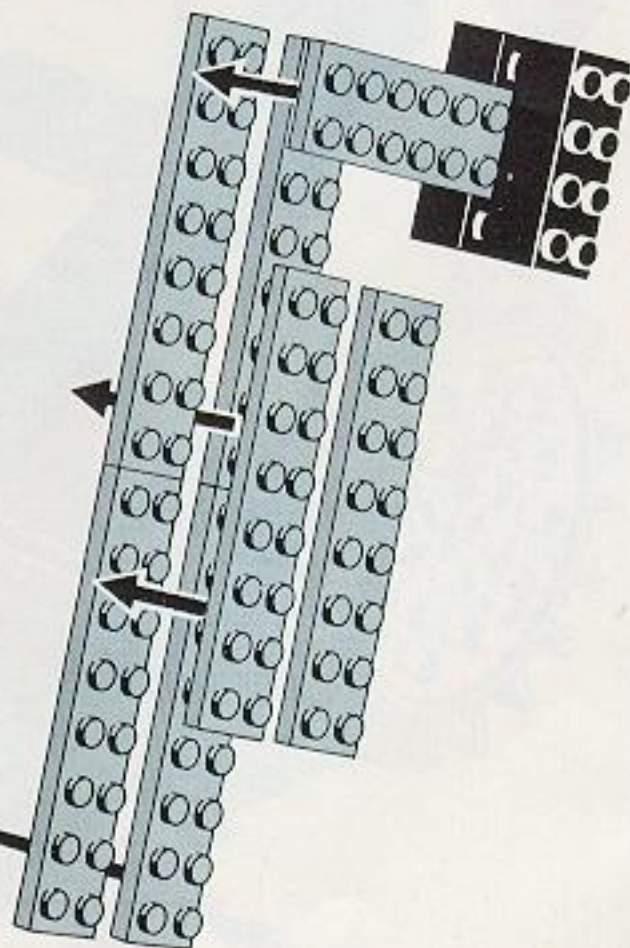
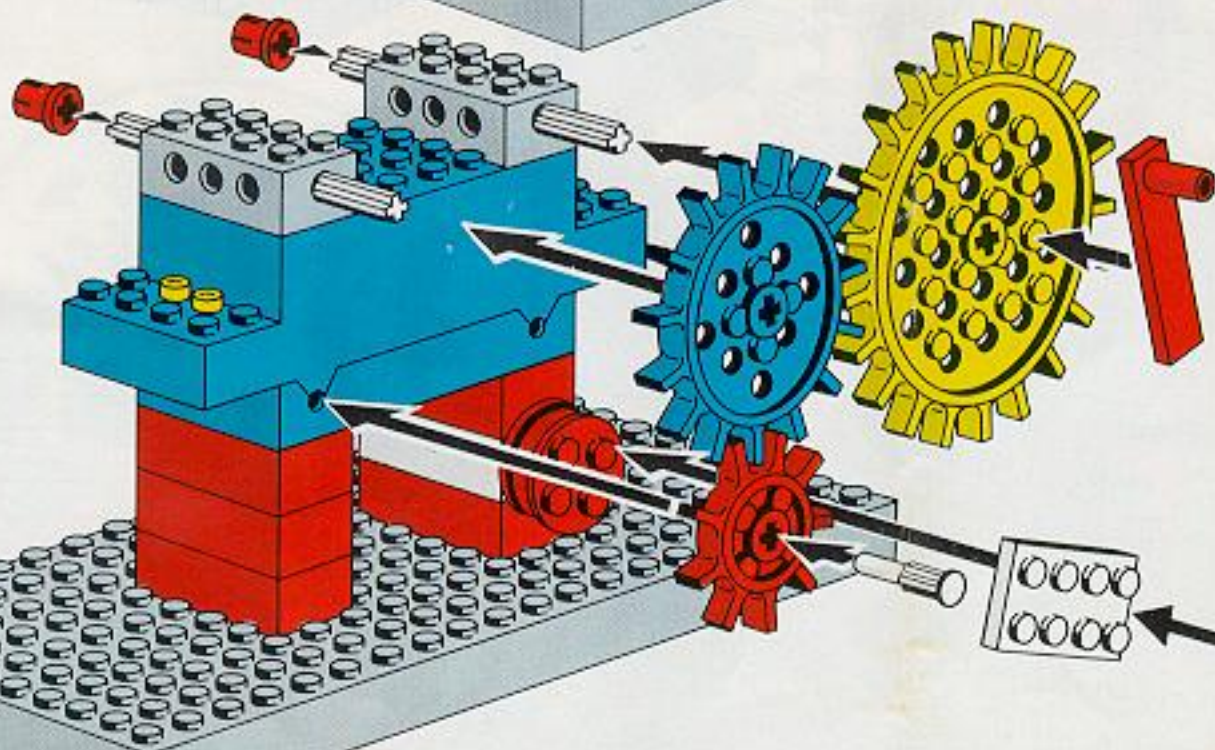
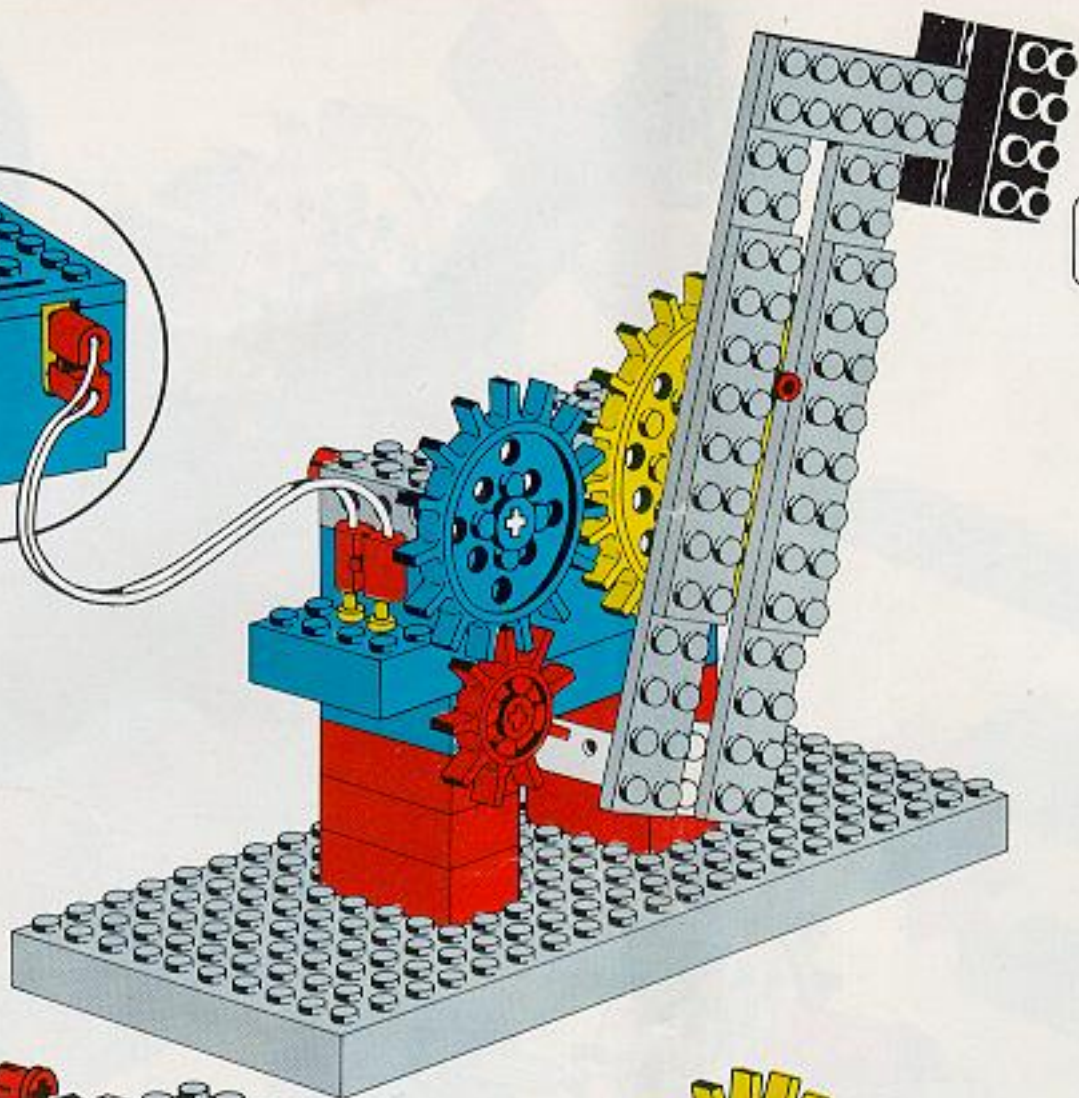

800



800

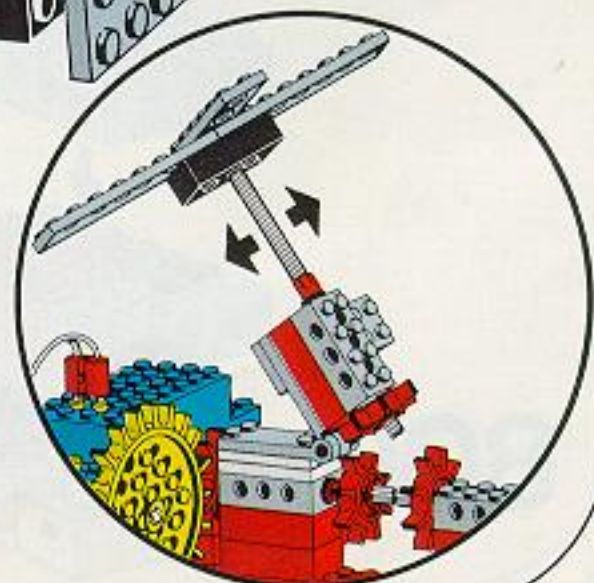
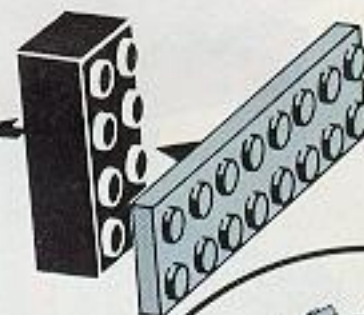
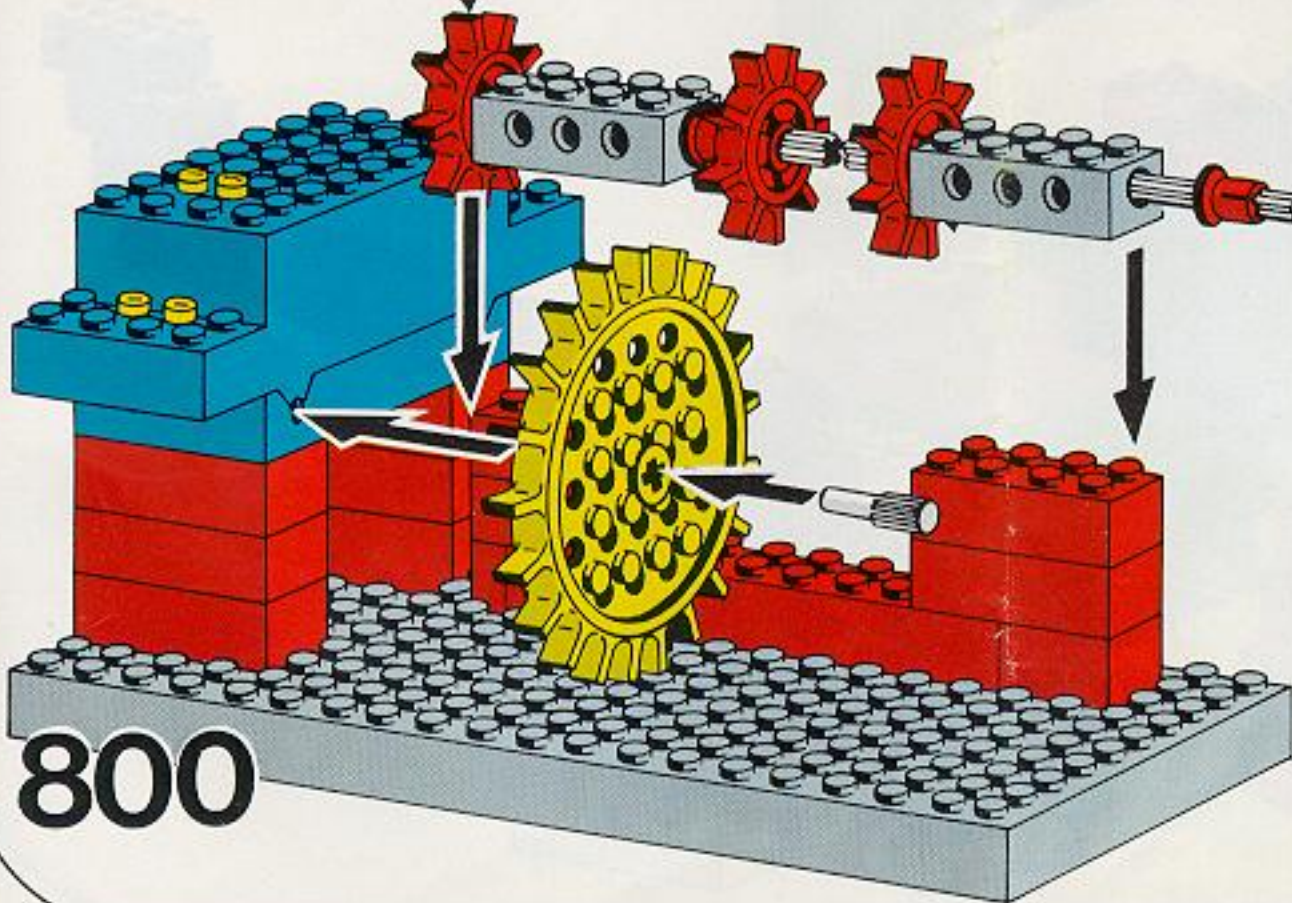
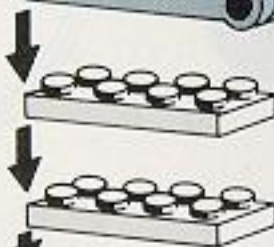
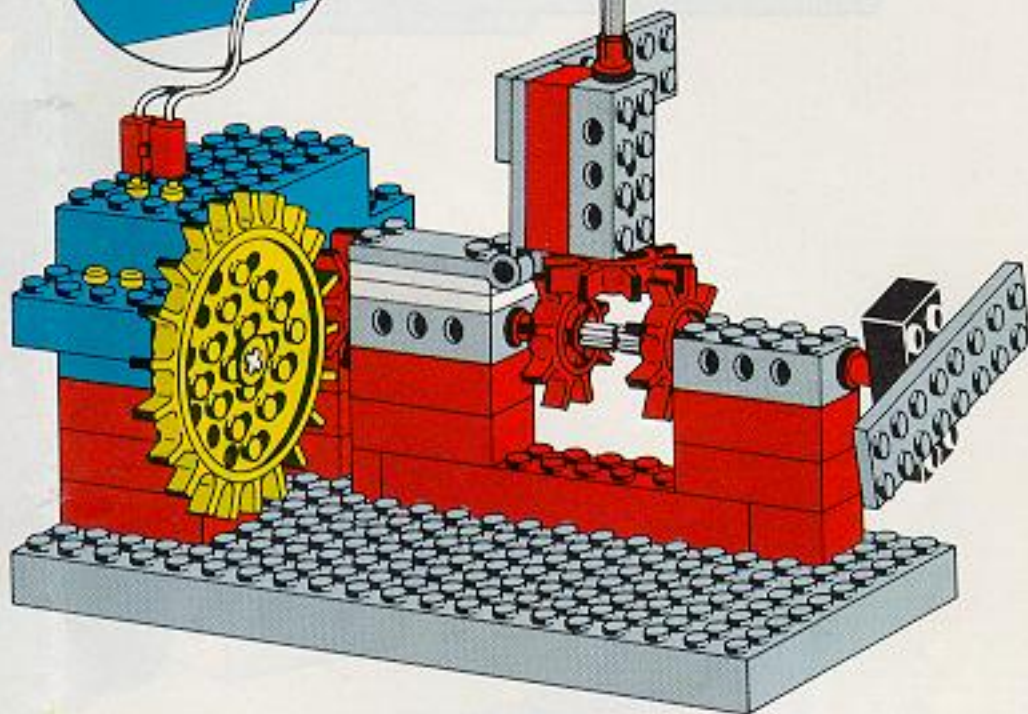
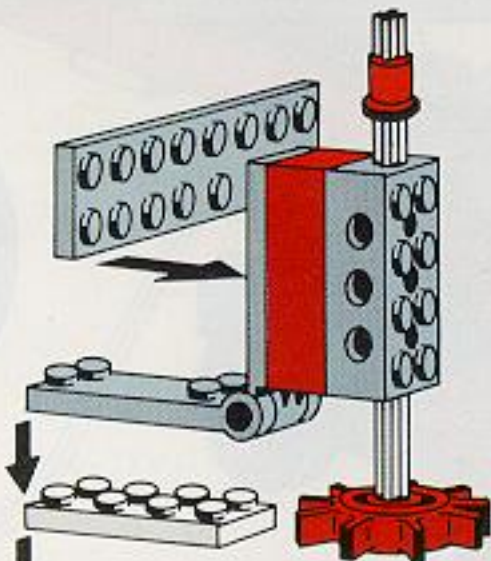
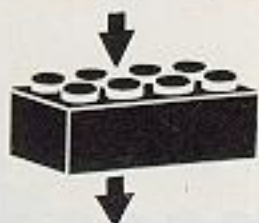

801+  = 800



800

801+   =800

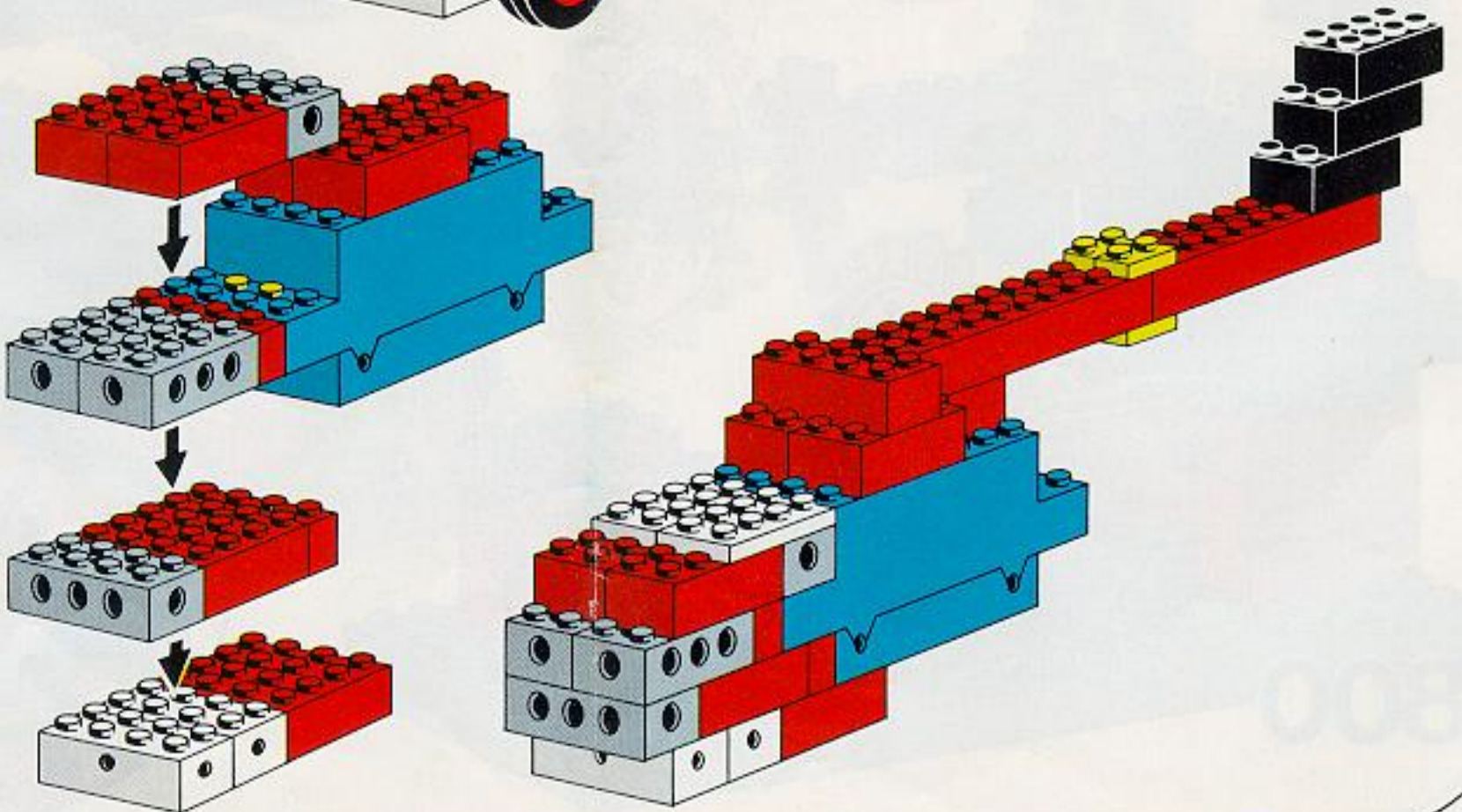
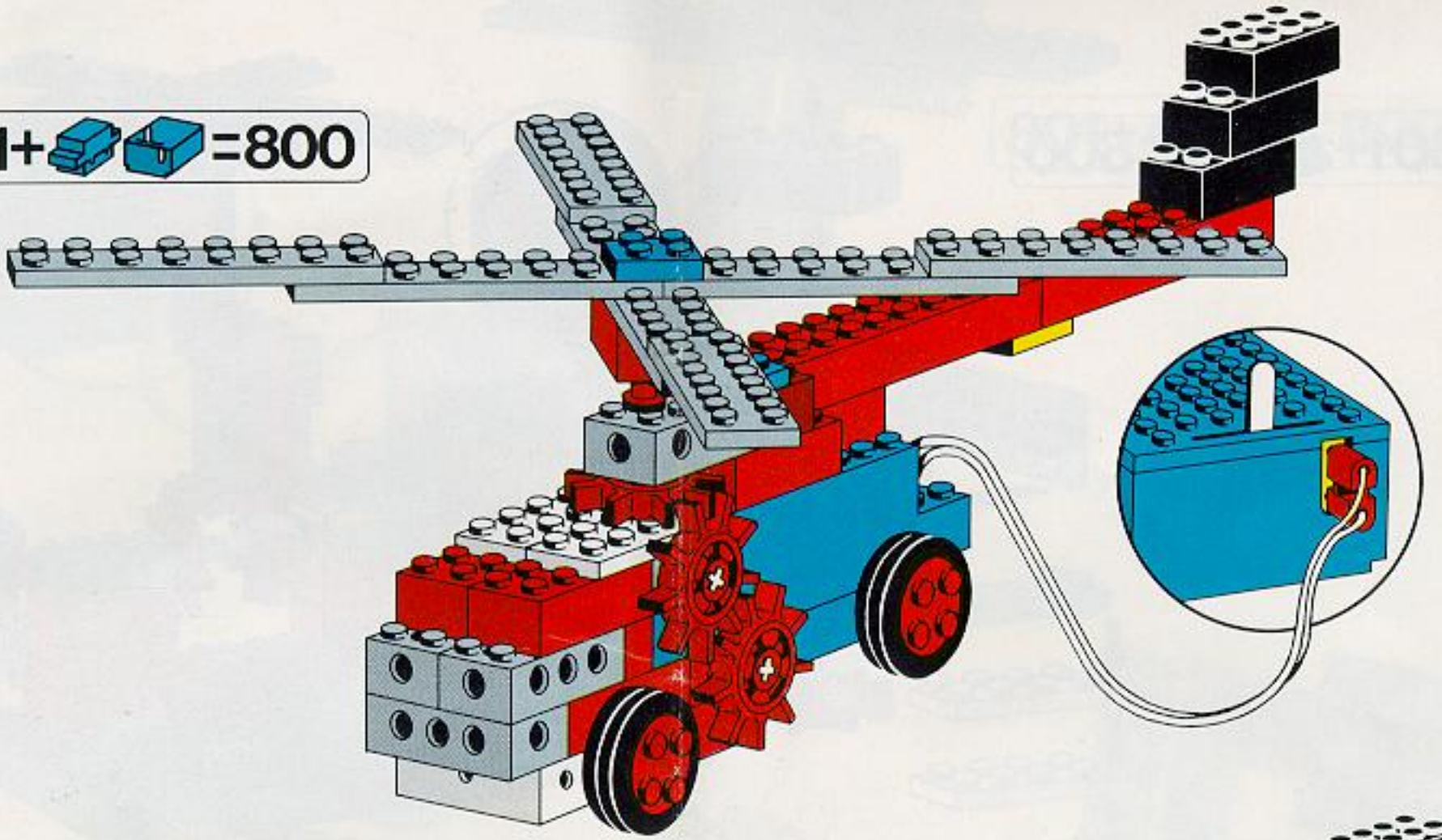

800

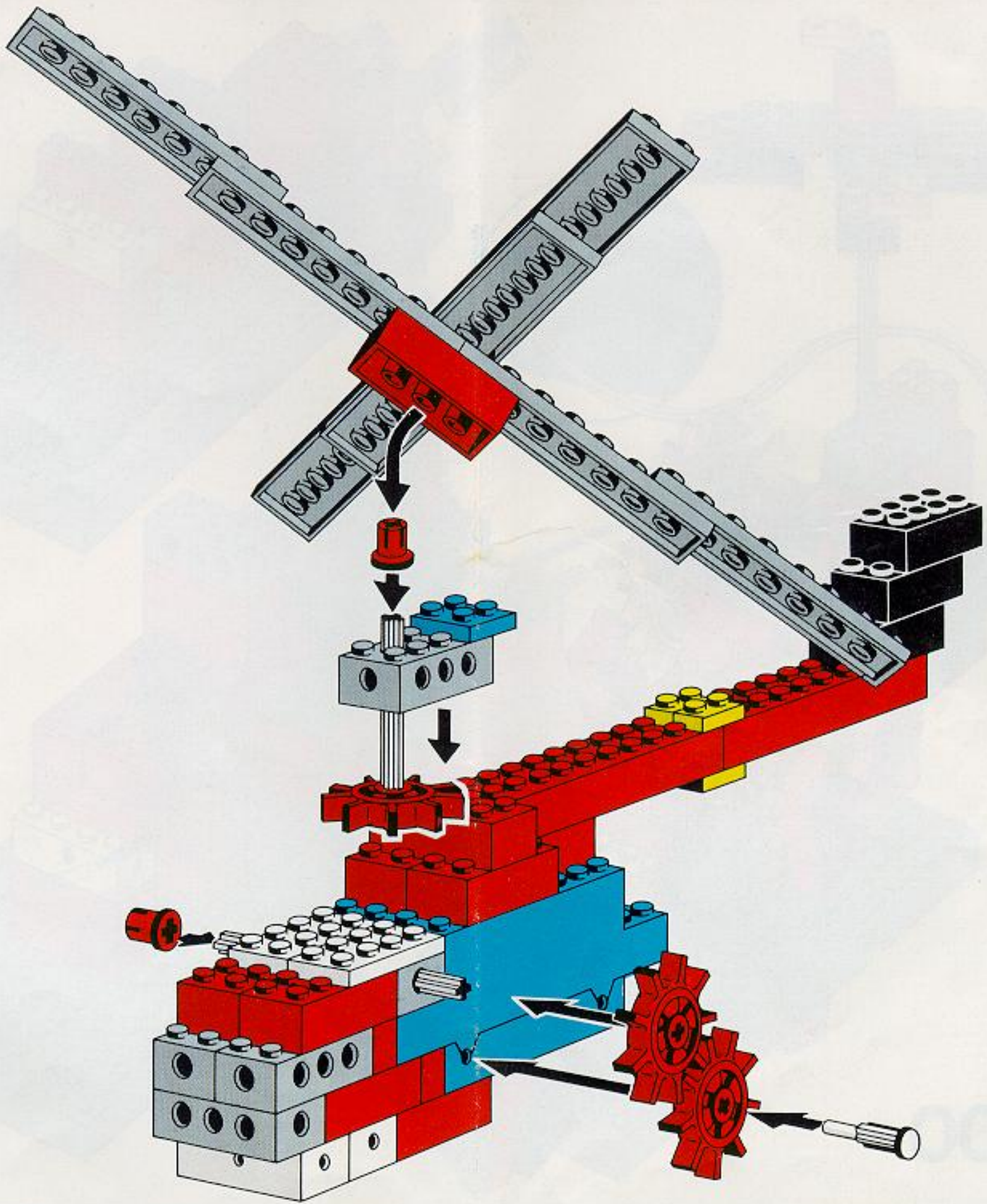

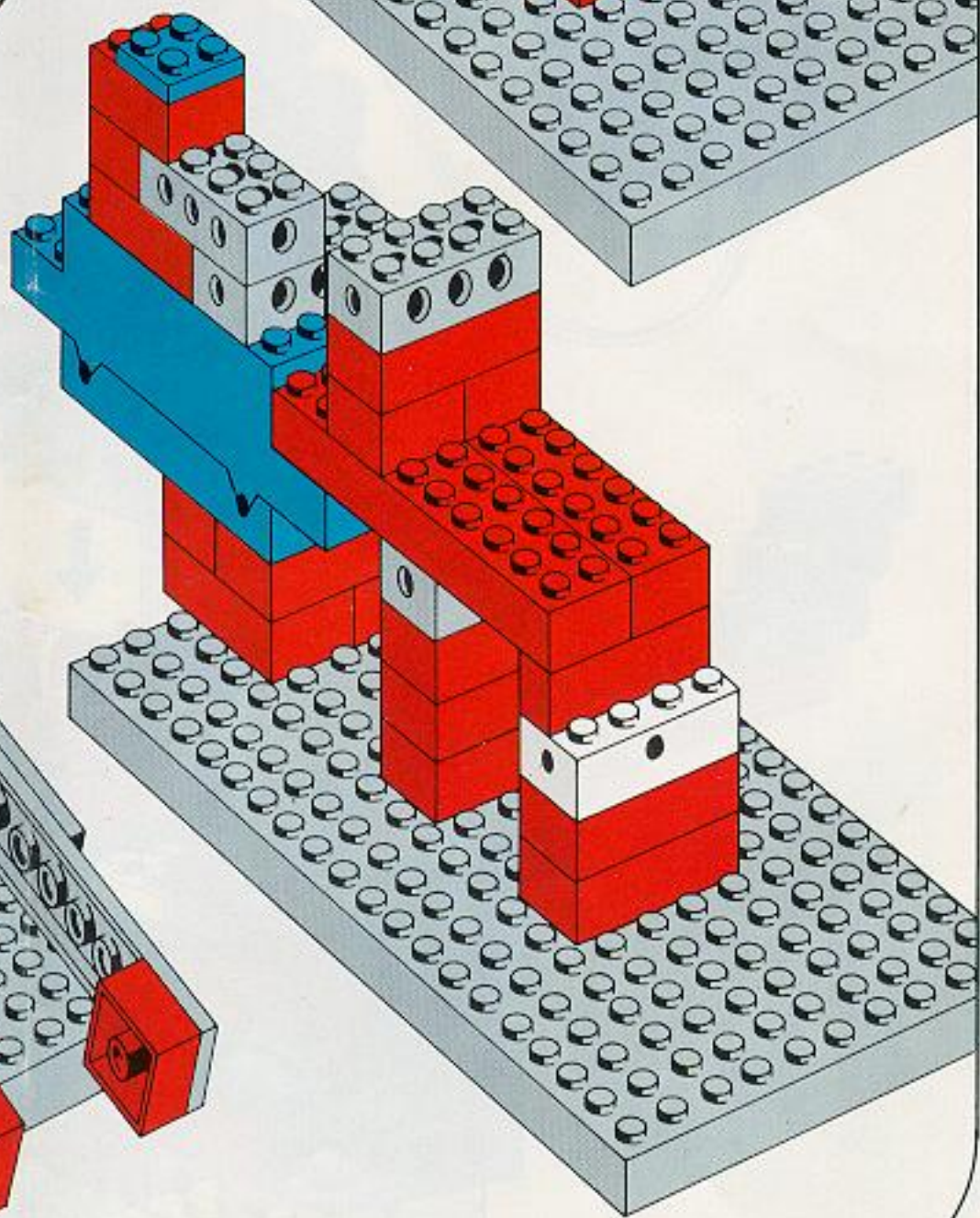
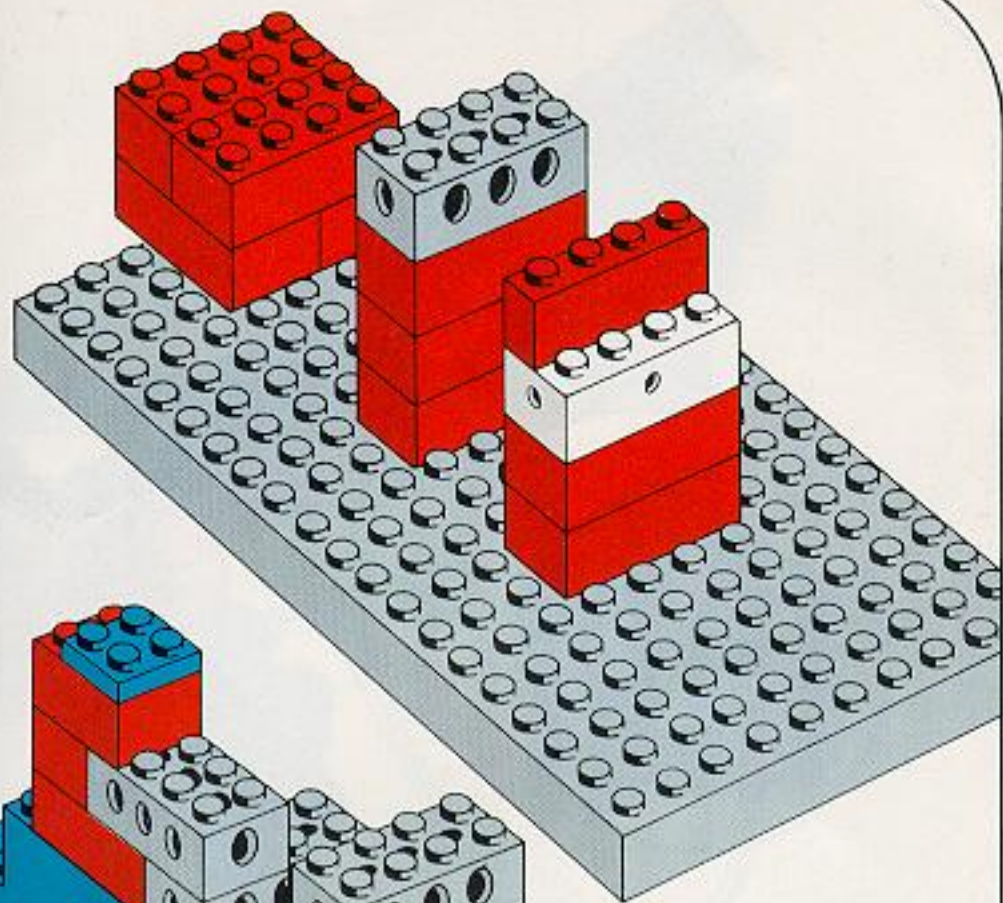
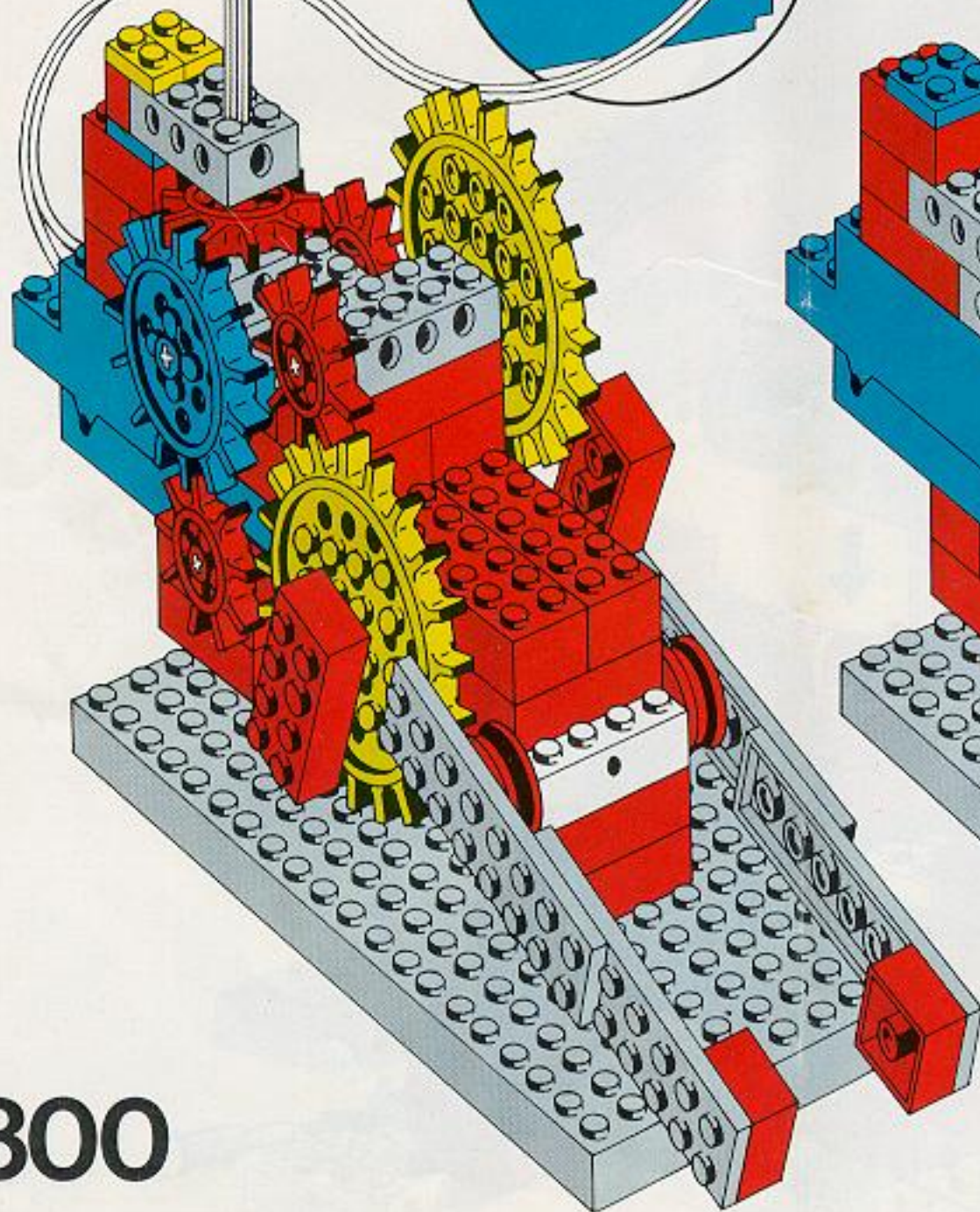
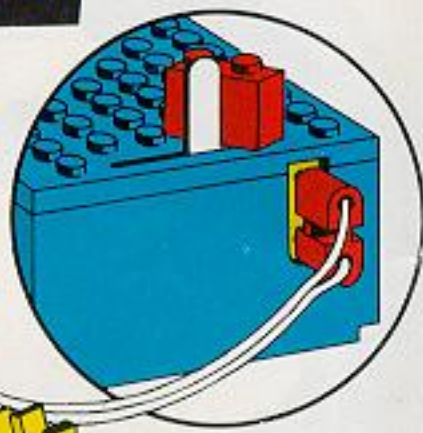
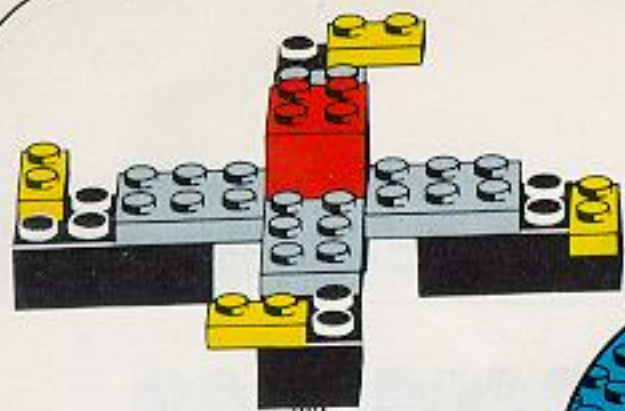

800

801+   = 800

