

The LEGO logo is displayed in its characteristic white, bold, sans-serif font with a black outline, set against a red square background.

565

Moon  
Landing



94536



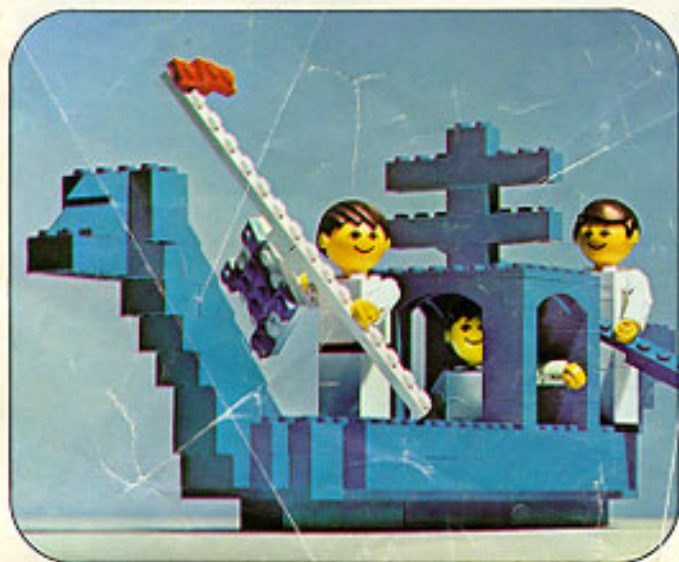

© 1975 LEGO System A/S



Printed in Germany for H. O. Parsow & Hamburg

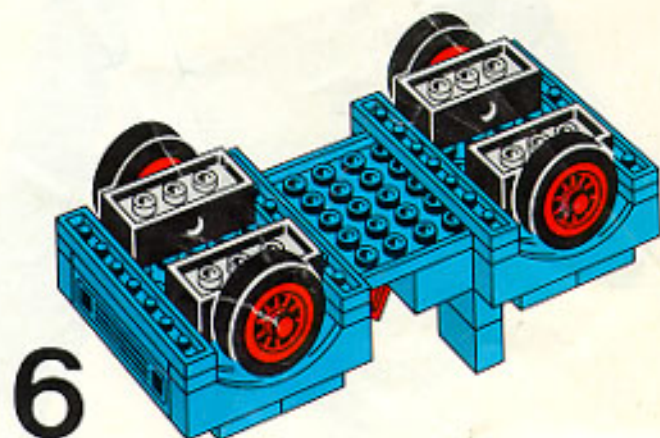
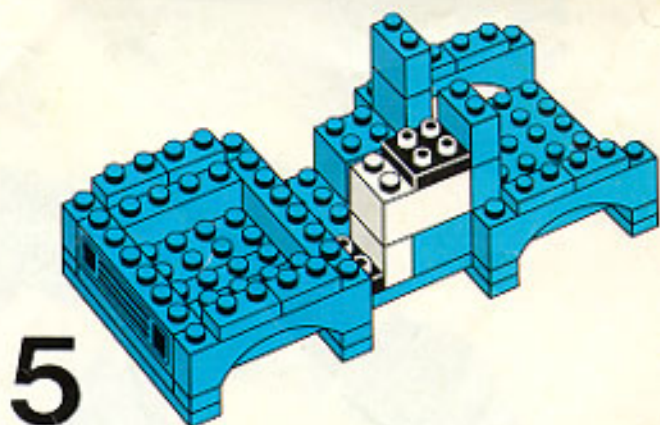
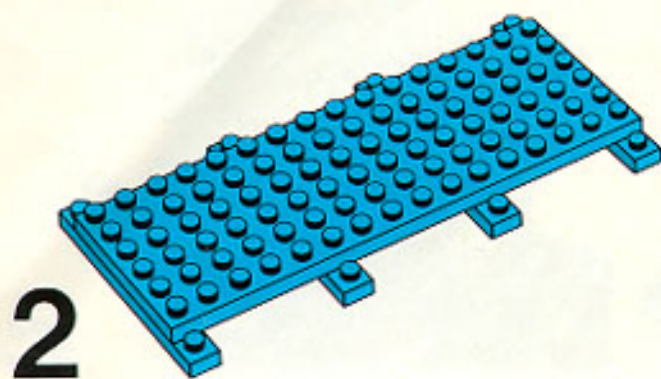
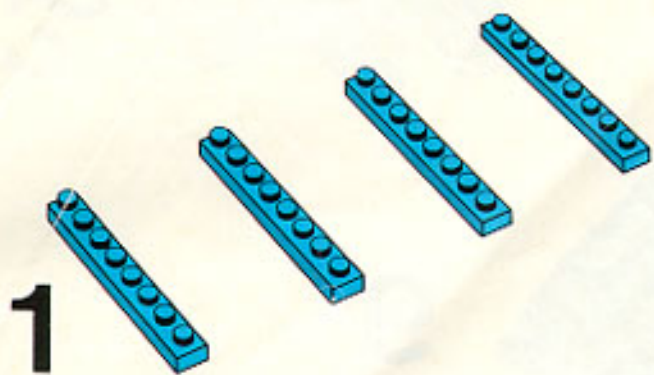

3

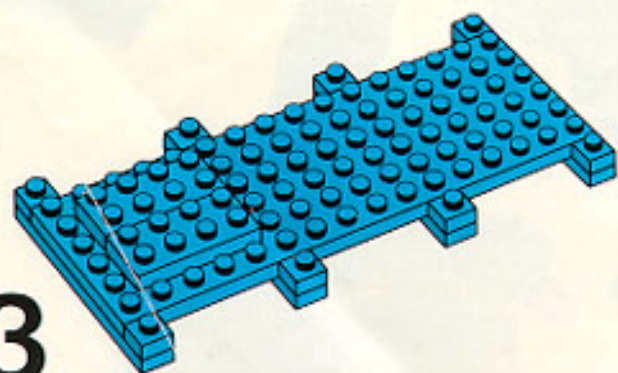

7

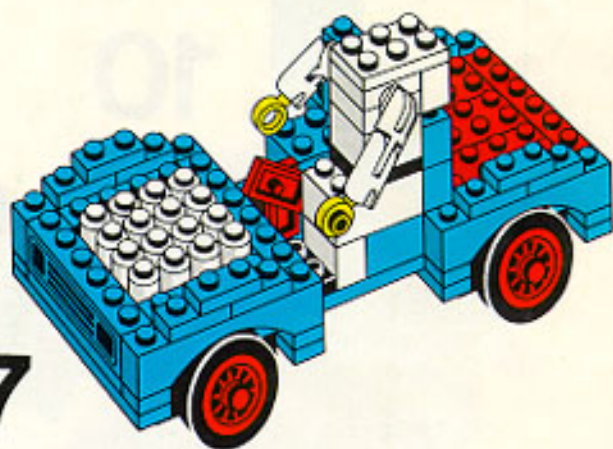

4

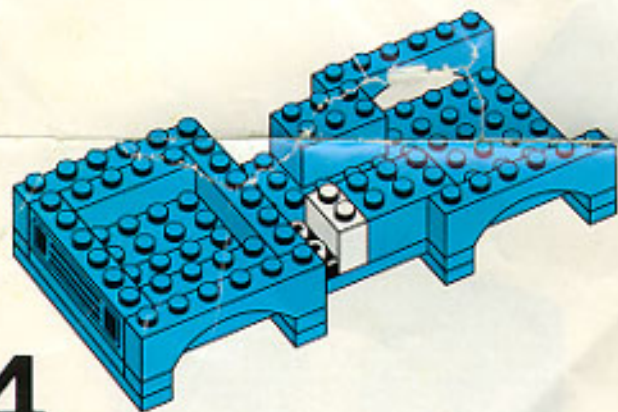

8

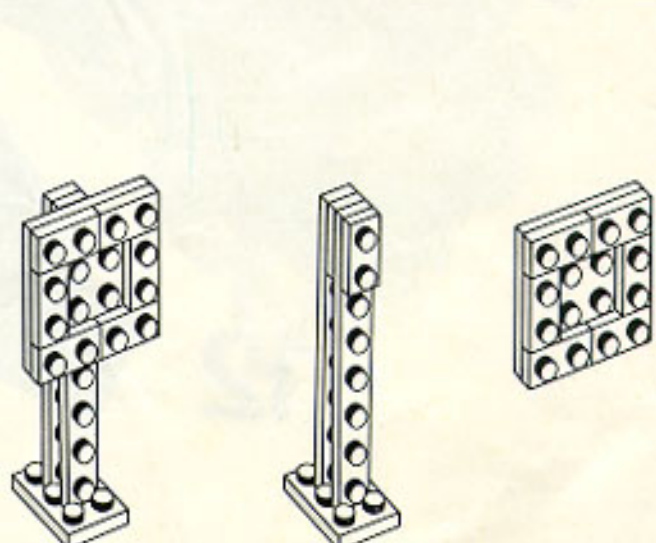
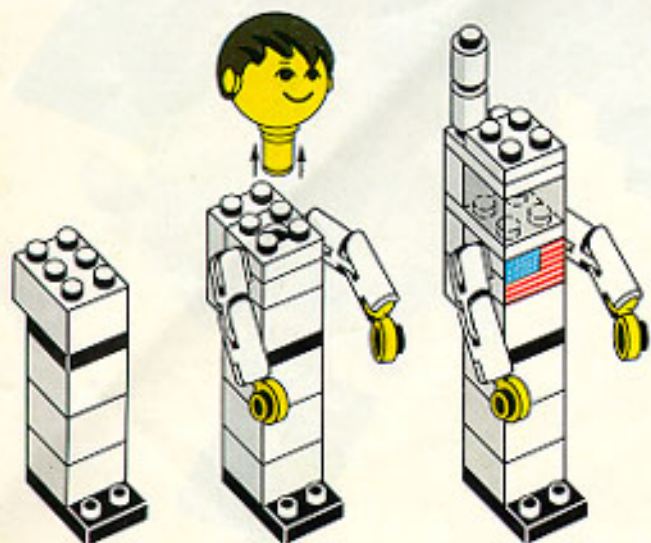
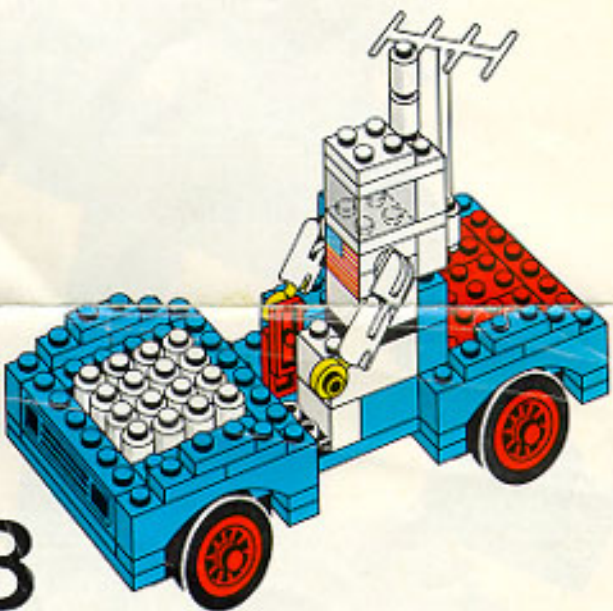

1

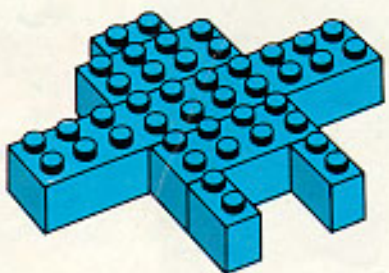

2

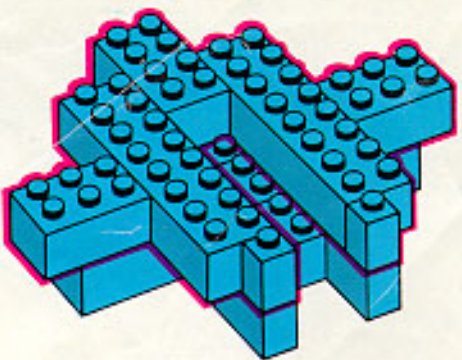

3

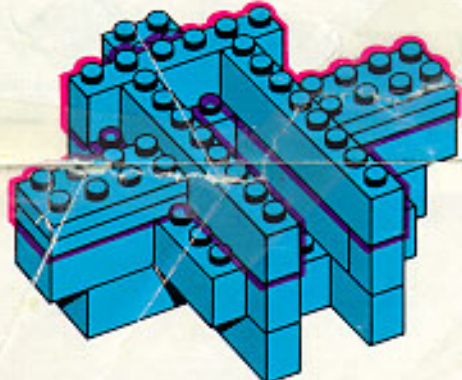

4

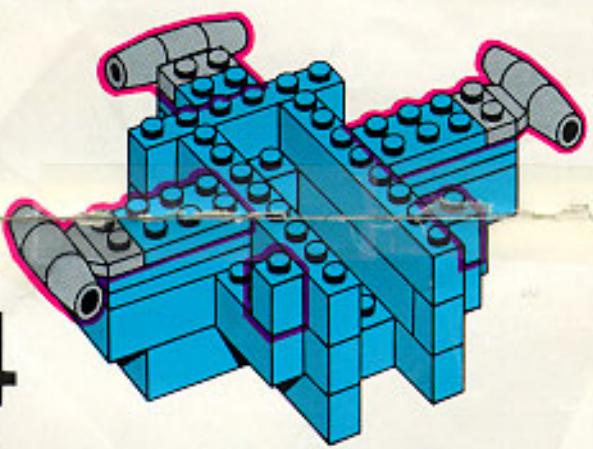

5

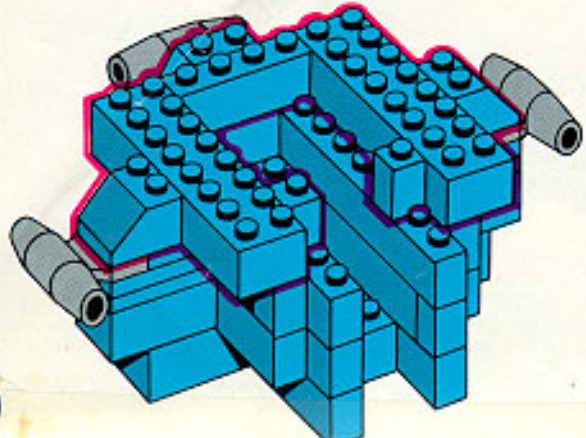

6

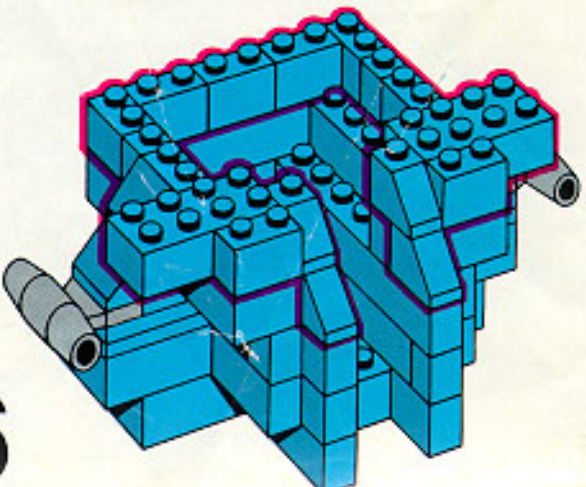

7

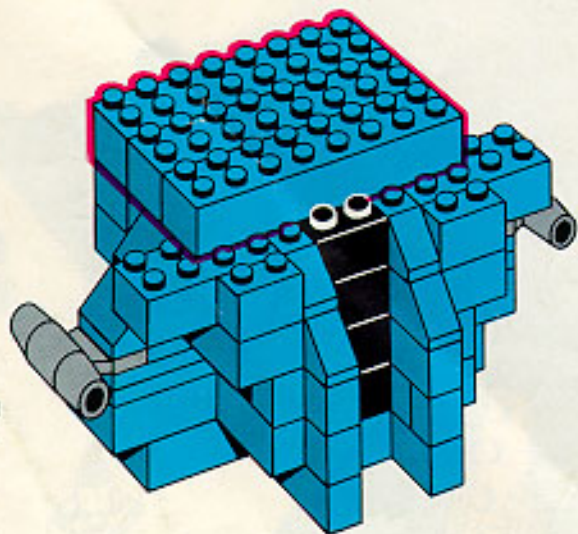

8

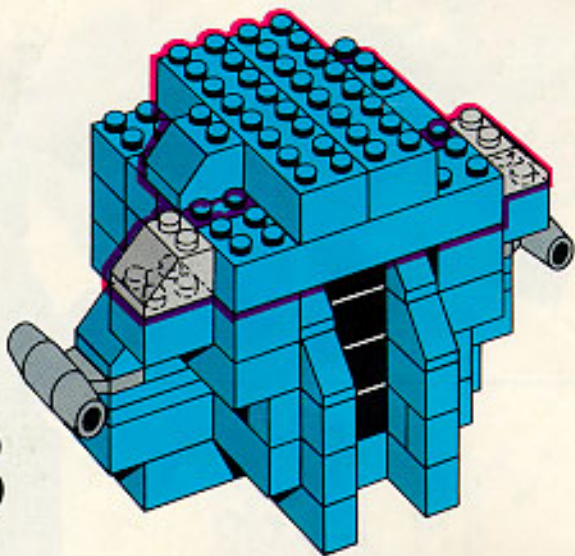

9

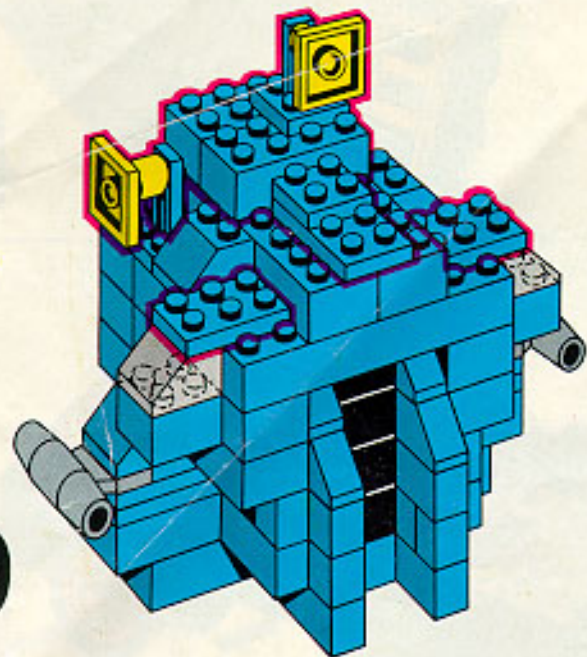

10

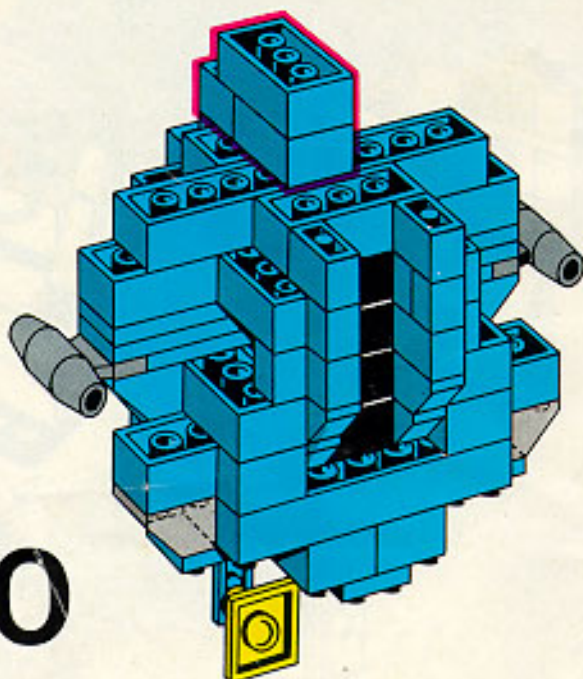

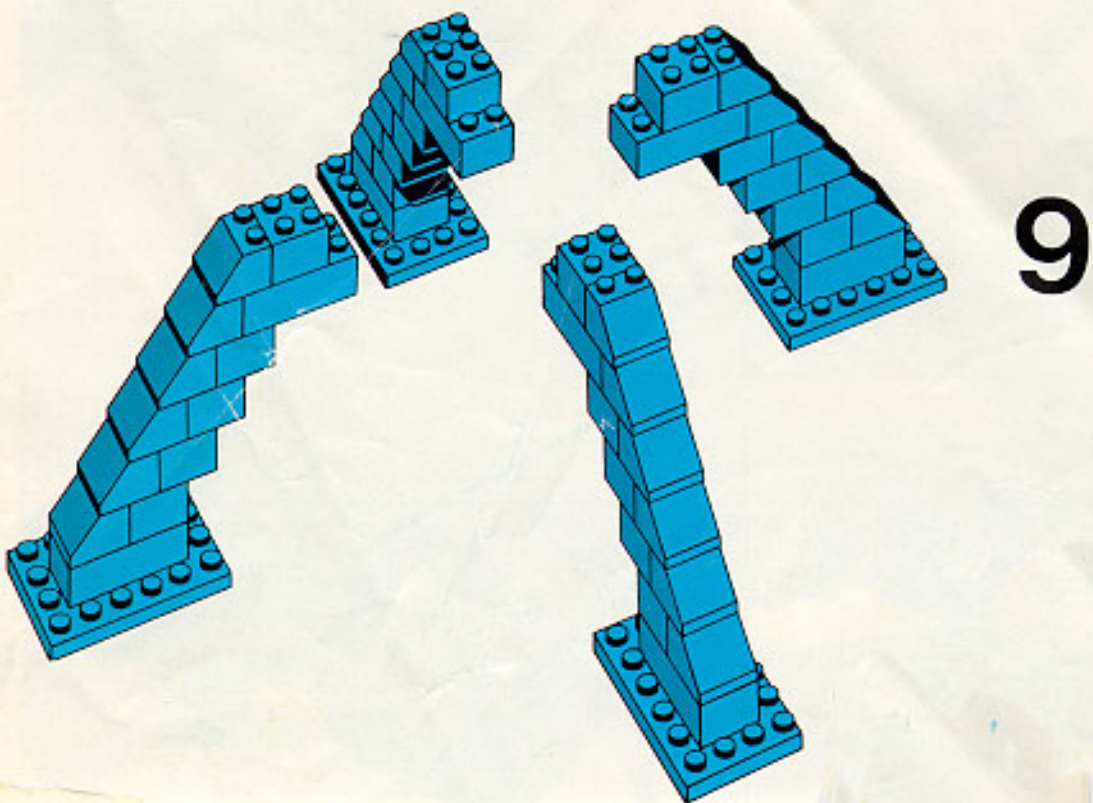
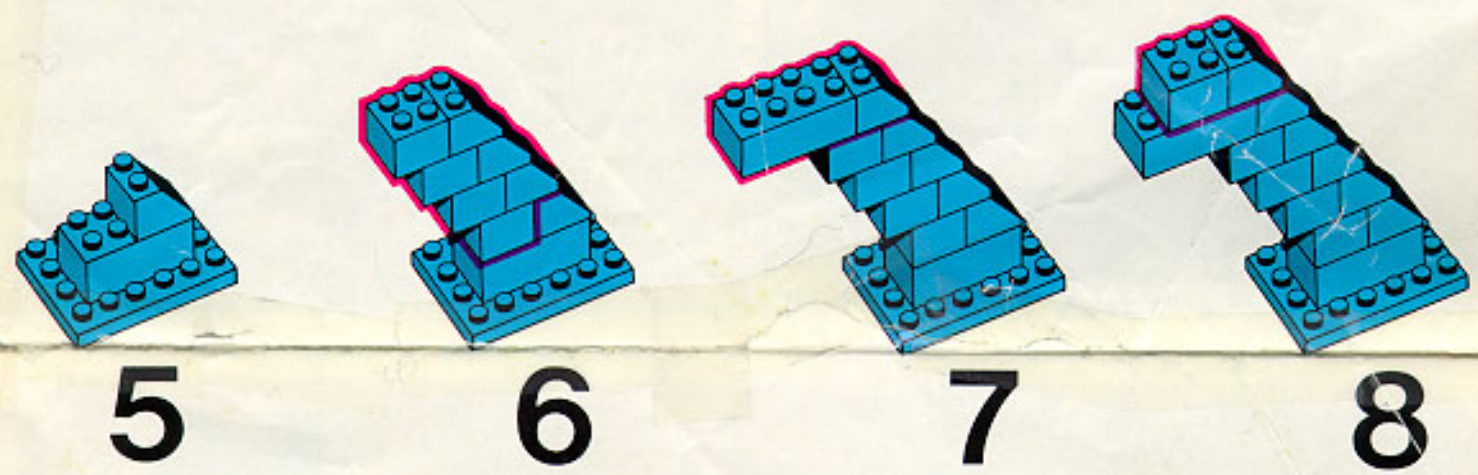
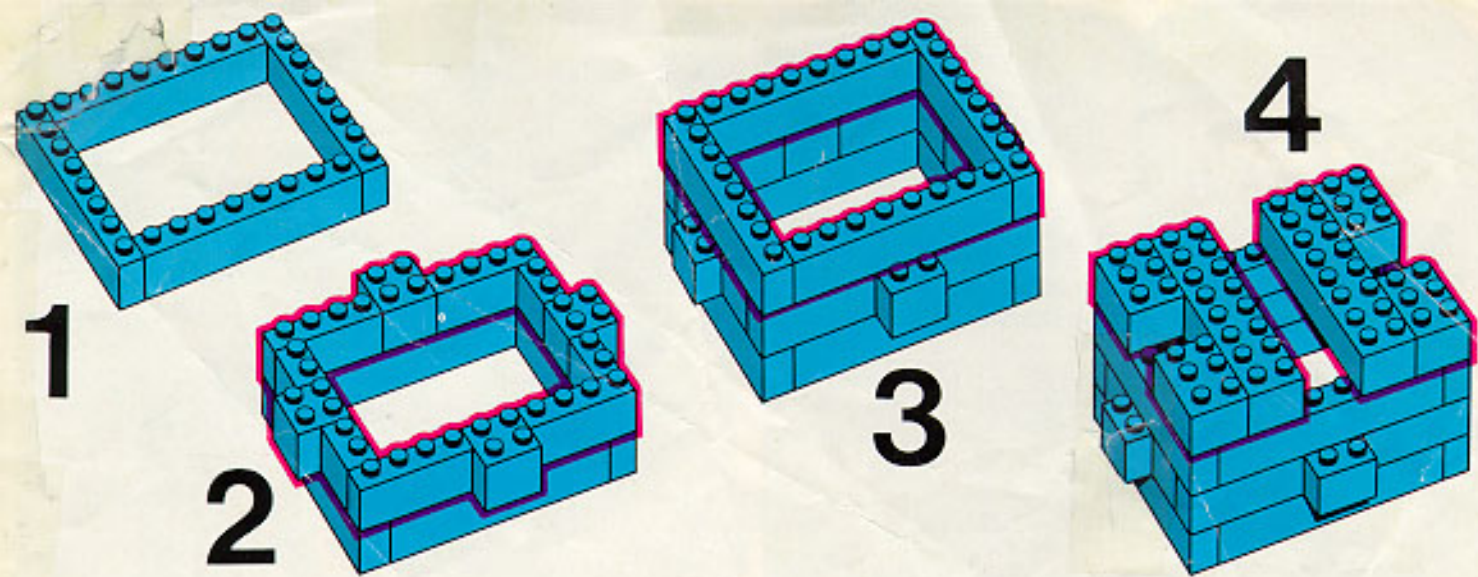

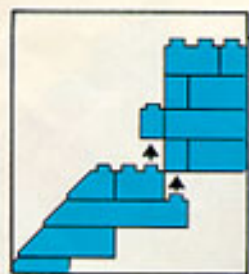

10

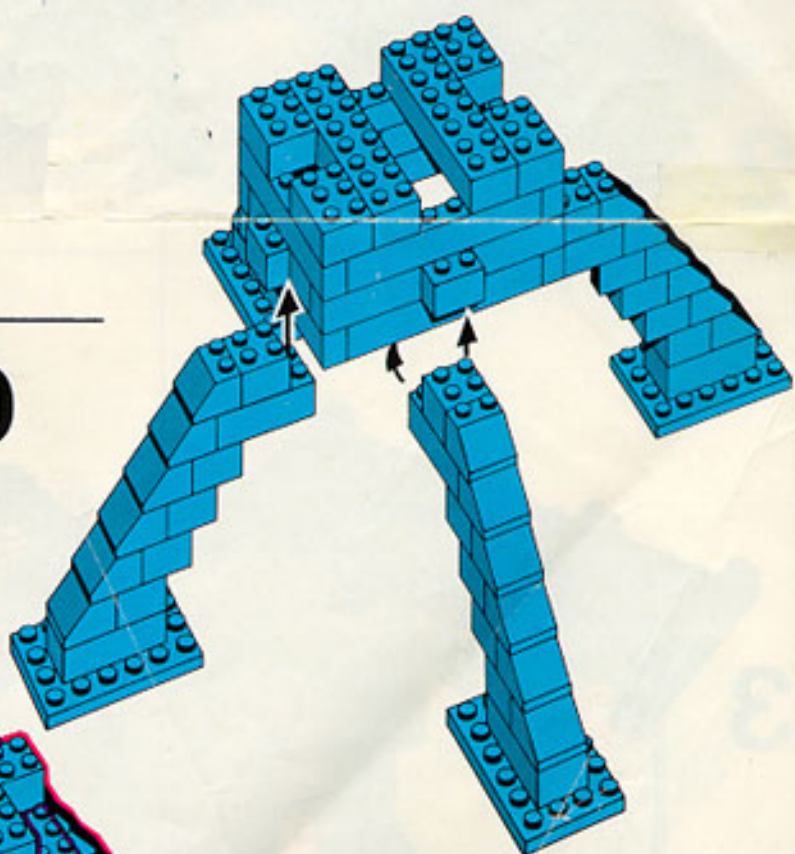

11

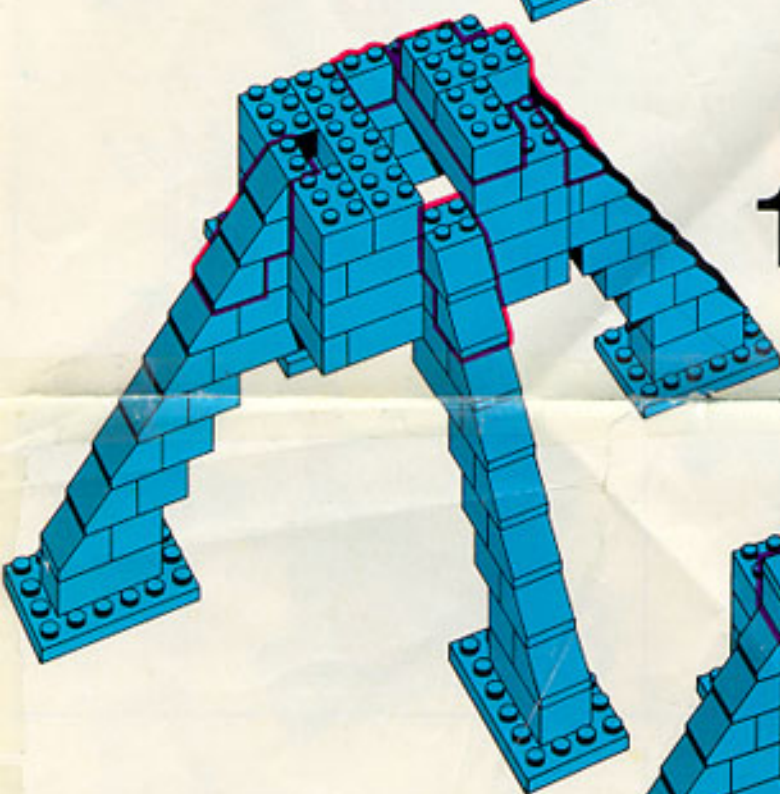

12

