

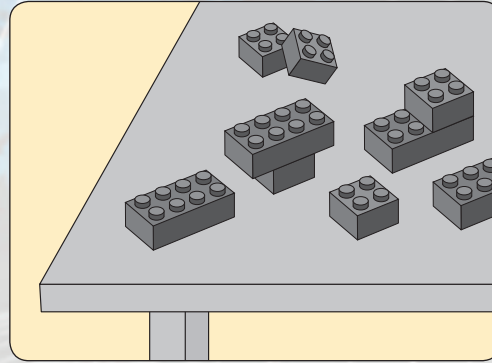

9485

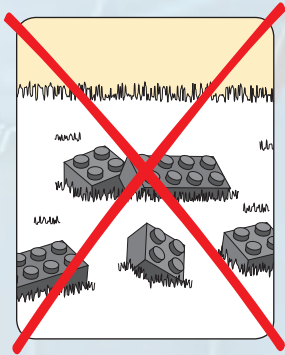

1



2



2

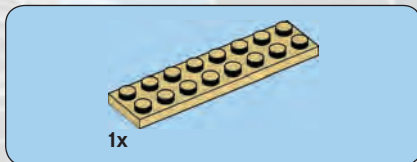
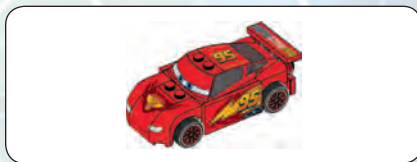
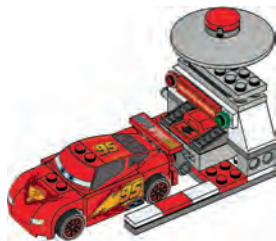

1





2

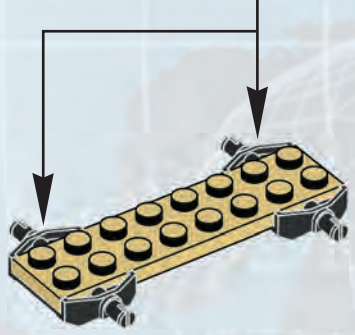

4

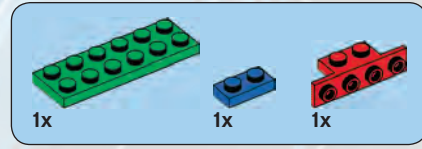

3

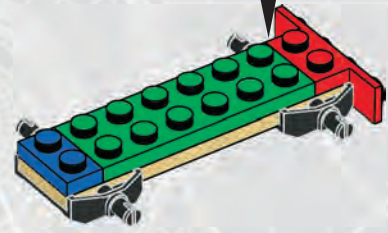
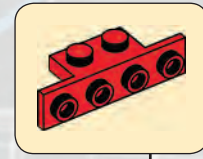

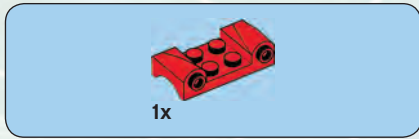

4

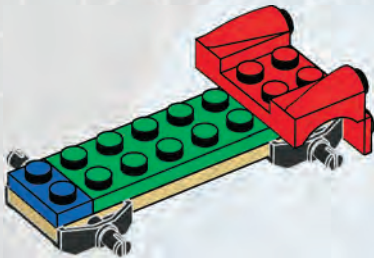

5

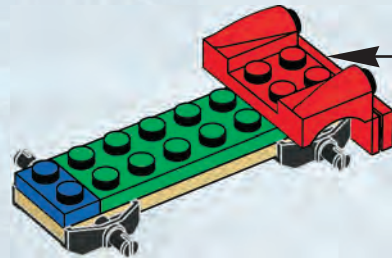

5

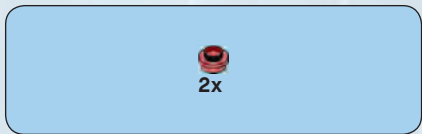

6 *waypoint*

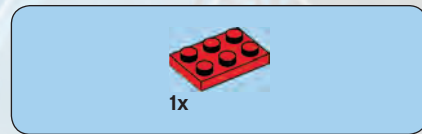
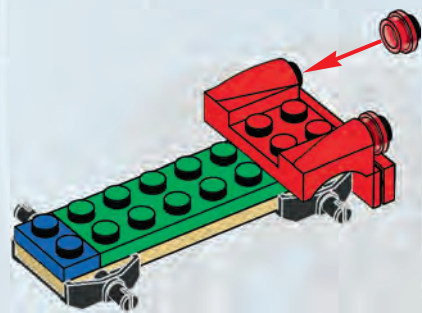

7

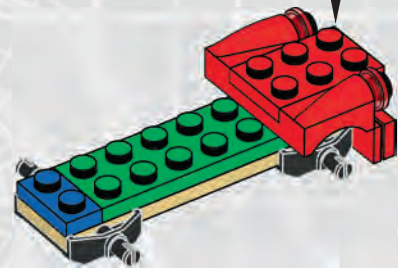

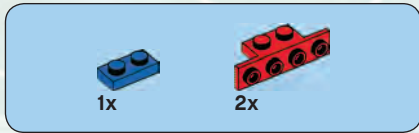

8

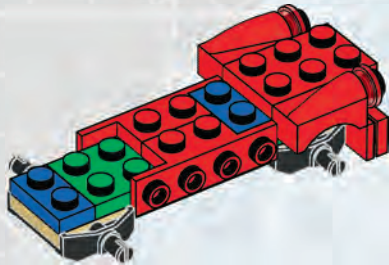

9

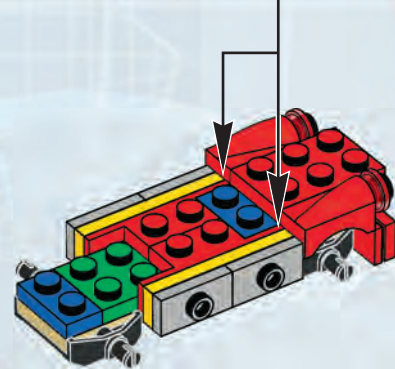
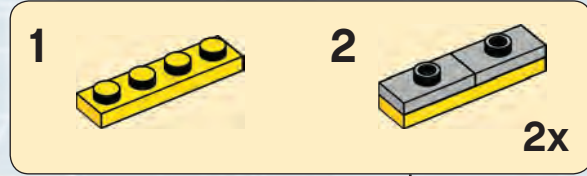

7

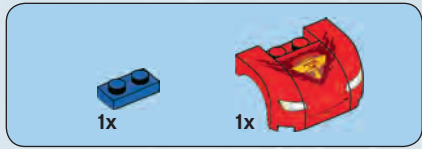

10

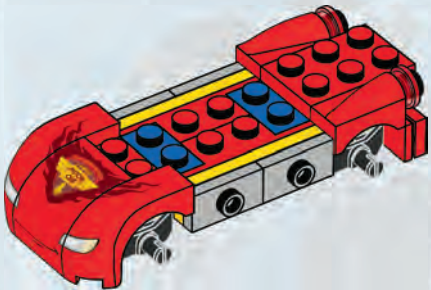

11

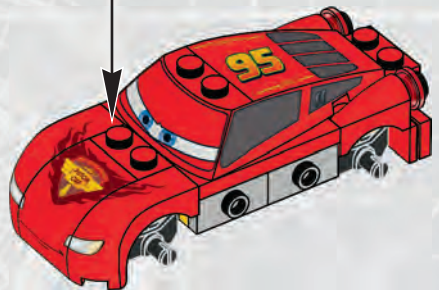

2x



1x

12

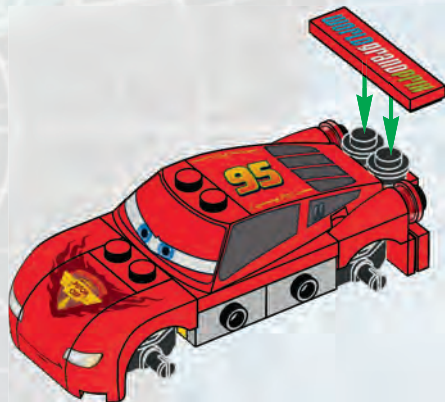

4x



4x

13



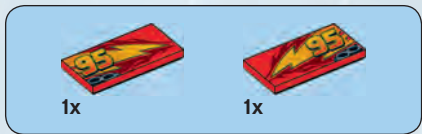

14

Waypoint

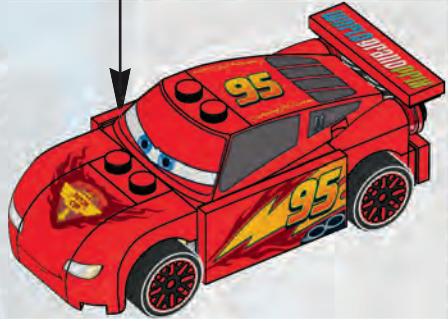
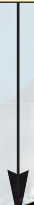

10

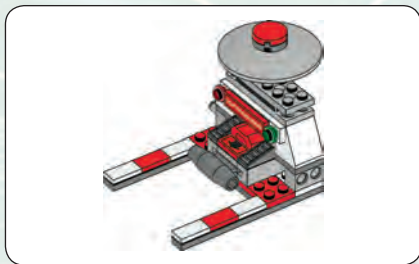

1



2

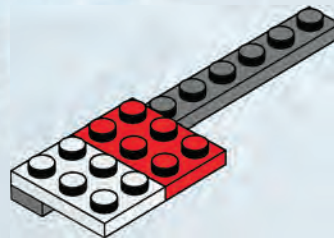



3

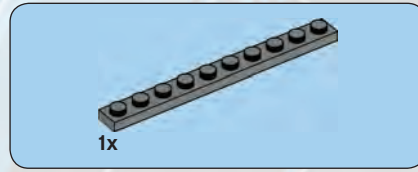
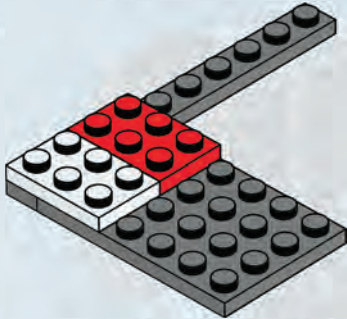

4

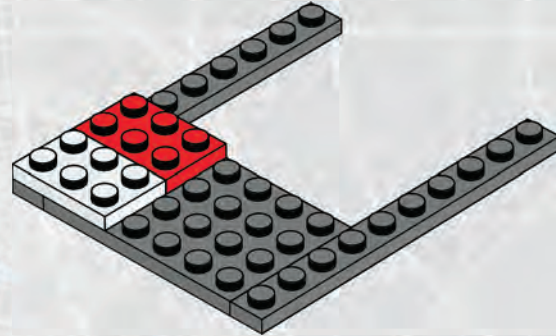



1x

5

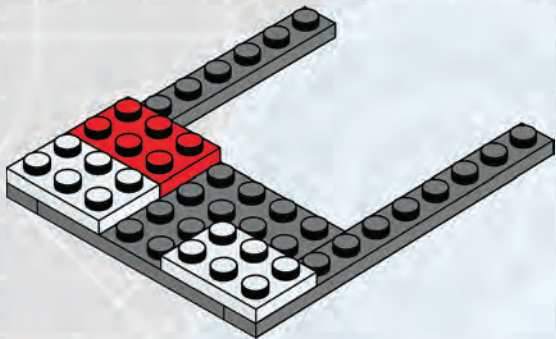

1x

6

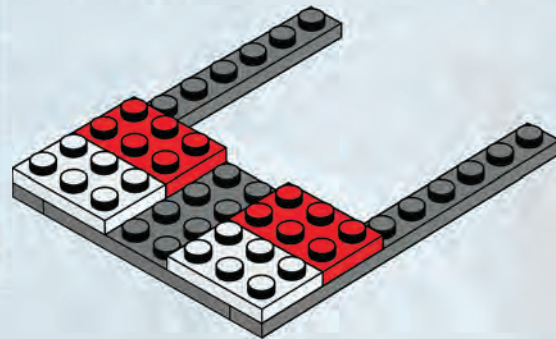



7 *waypoint*

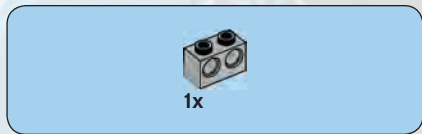
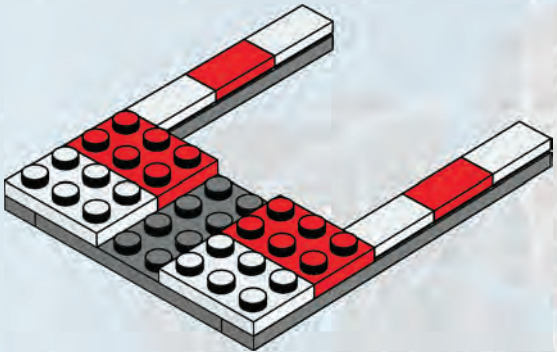

8

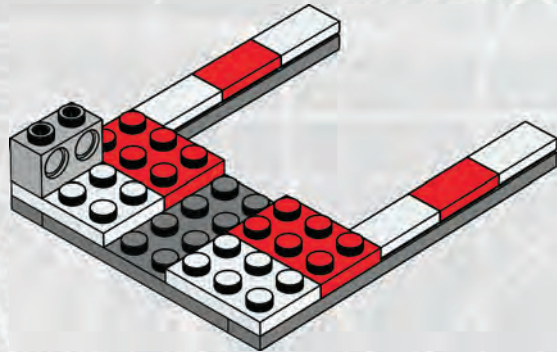

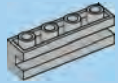

1x



1x

9

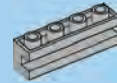
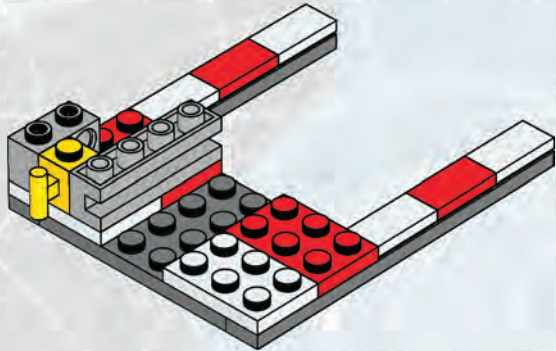

1x

10

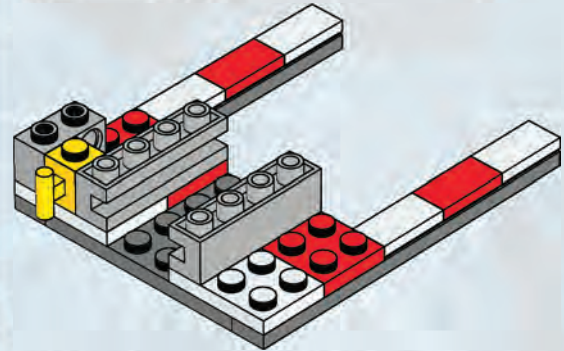



1x



1x

11

waypoint

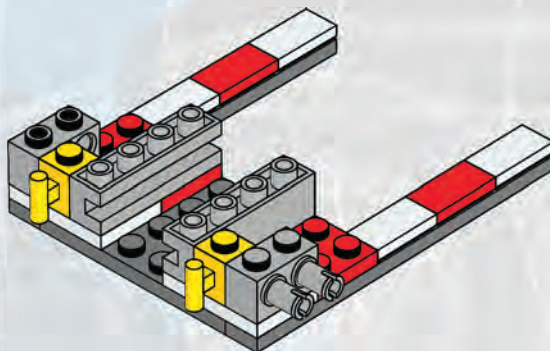

16



12

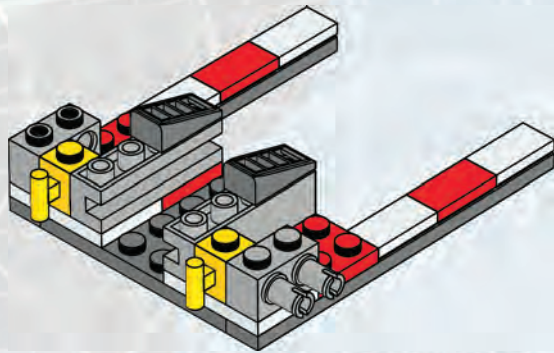

13

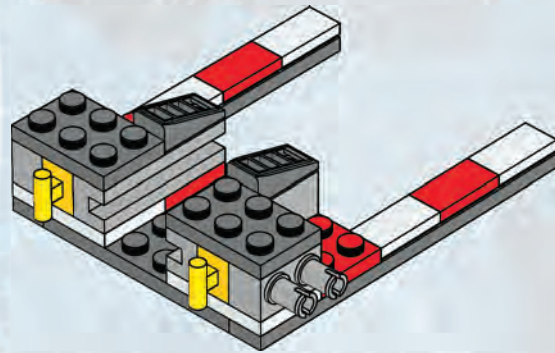

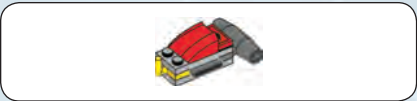

1

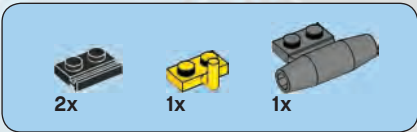

2





3

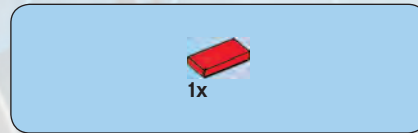
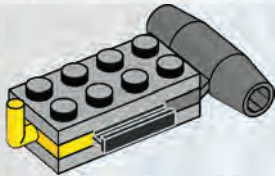

4

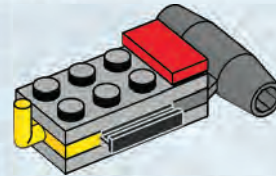

waypoint 7

5

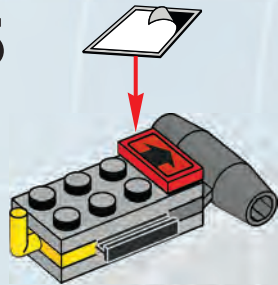

6

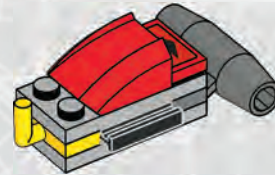

14

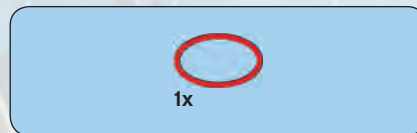
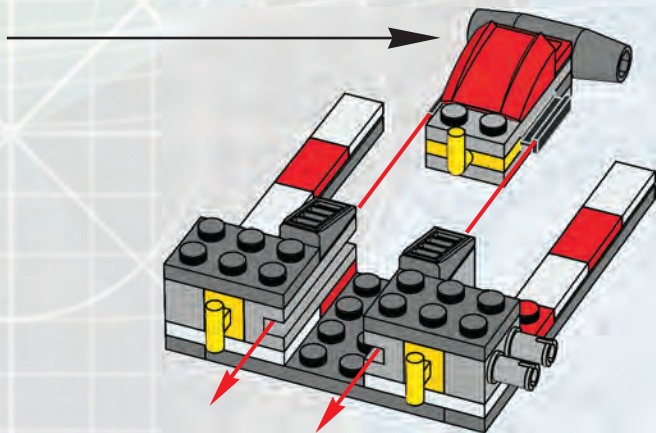

15

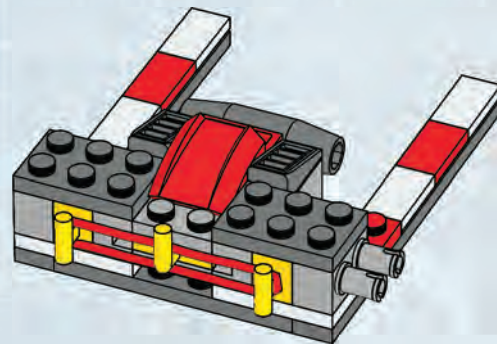



16

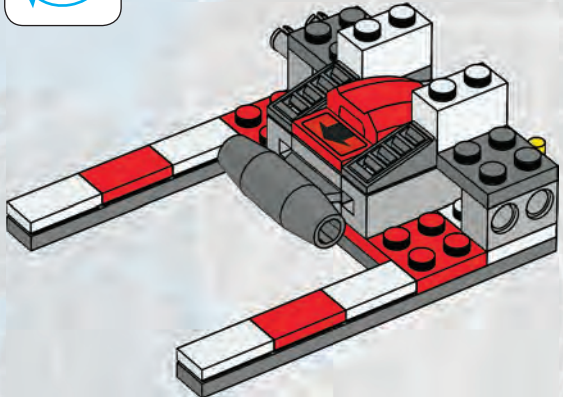



2x



2x

17

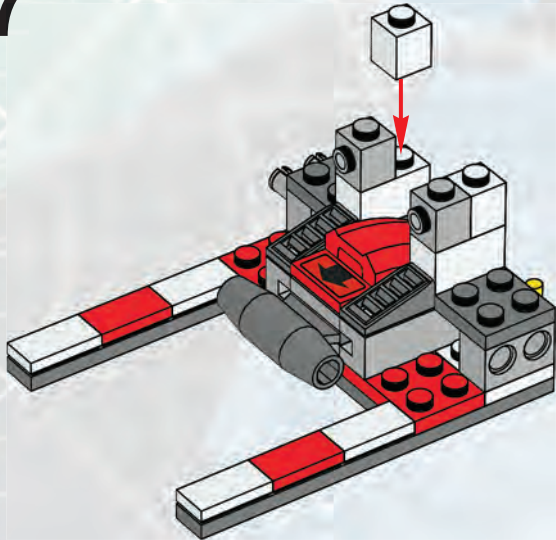

2x

18

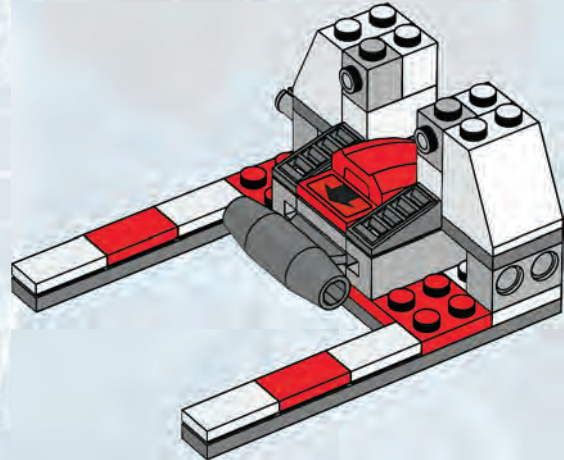



1

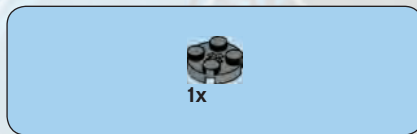

2





3

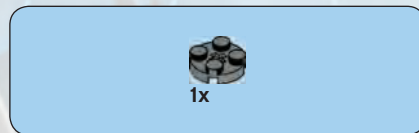
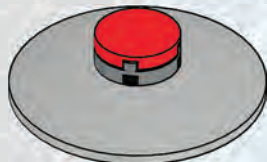

4

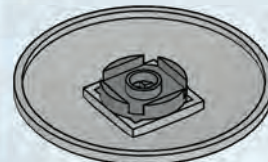

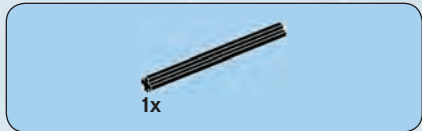

5

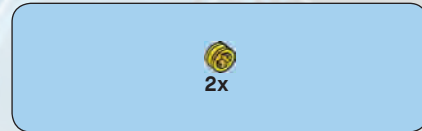
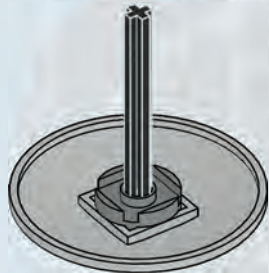

6

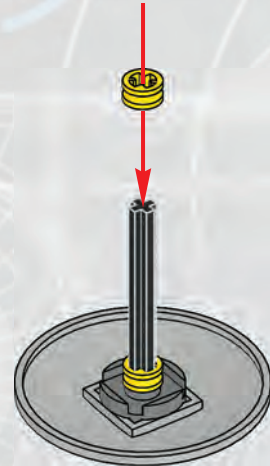

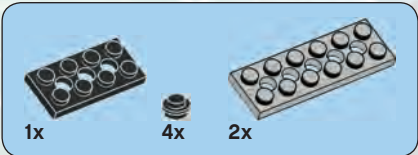

7

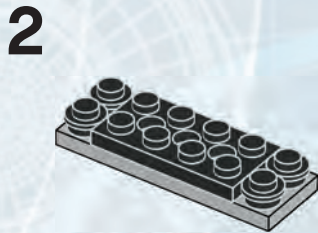
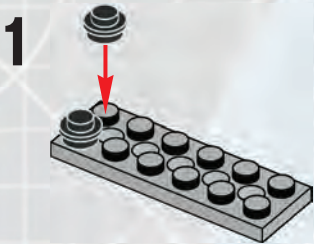

waypoint

1

4

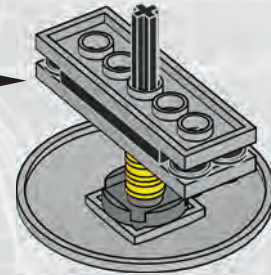
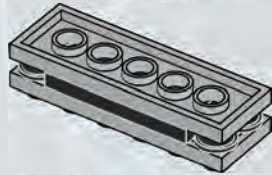
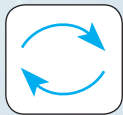

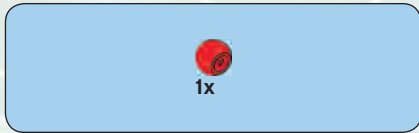

8

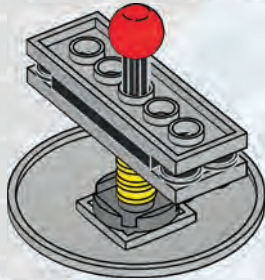

*target
acquired*

19

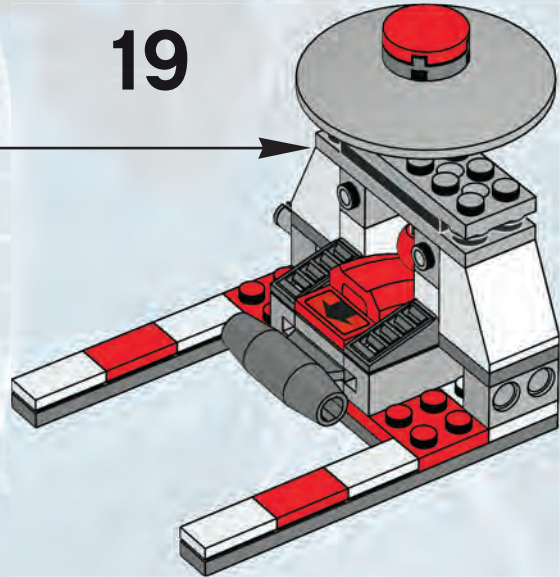

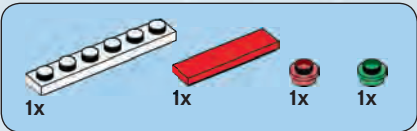

20

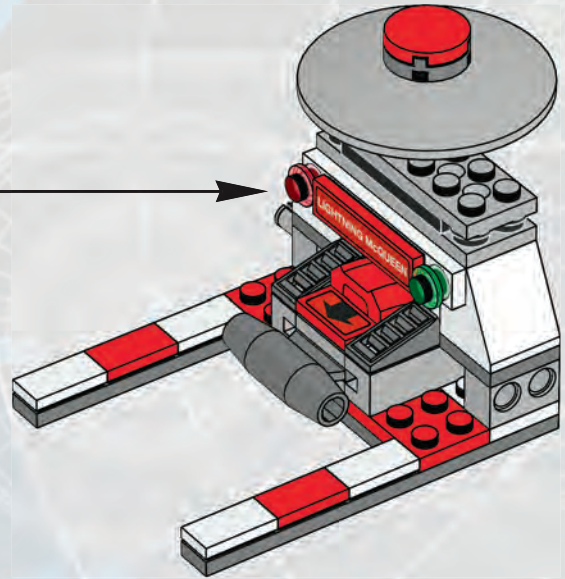
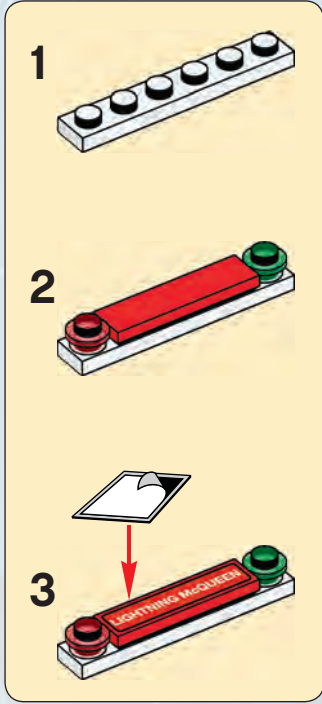

30

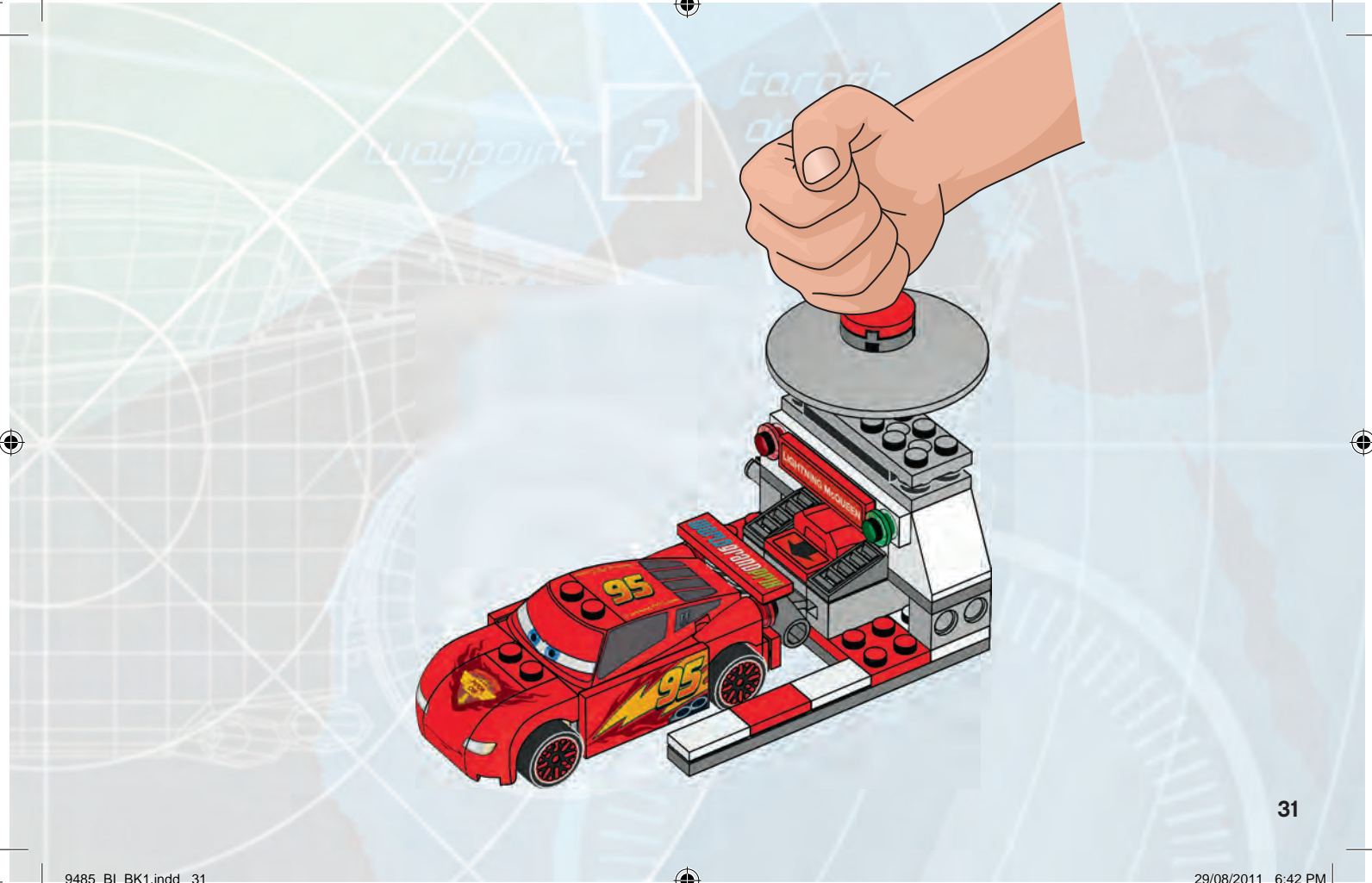

LEGO

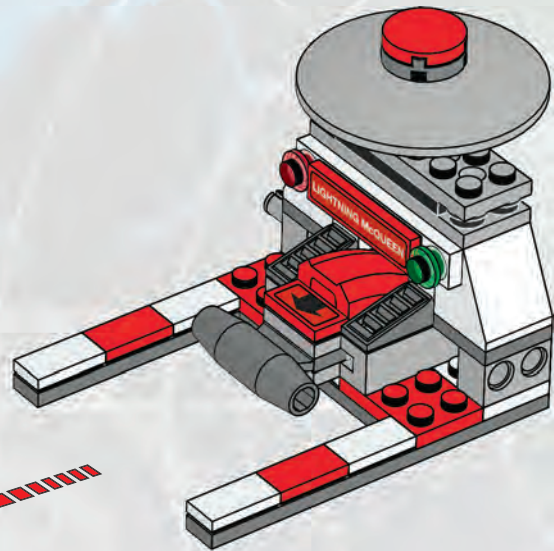

2011



8639



8423, 8639, 8679



8426



8487



8200, 8487



8487



8206, 8484, 8679



8206, 8679



8487



8424



8639



8423, 8679



8638



8638



8487



8638



8638



8638

2011



8201, 8487



8639



8639



8486



8426, 8639



8639



8426



8638



8486



8679



8679



8679



8679



8424

2012



9486



9485



9486



9481



9480



9483



9484



9485



9479



9484



9486



9483



9486



9485



9486



9485



9478



9483



9484



 www.LEGO.com

6003662

LEGO and the LEGO logo are trademarks of the LEGO Group. ©2012 The LEGO Group. © Disney/Pixar



9485



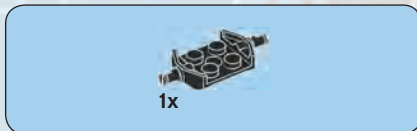
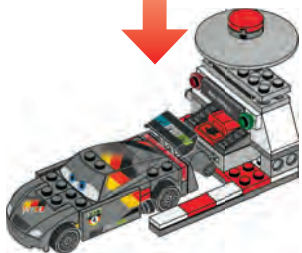

1





2

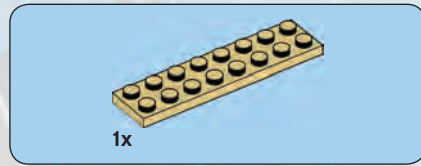

3

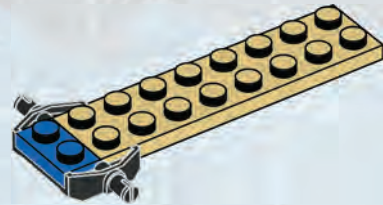



4

Waypoint

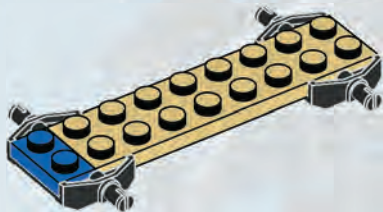

4



5

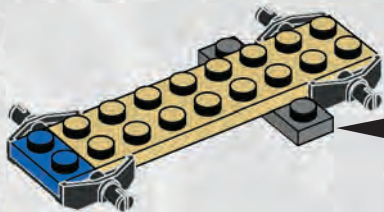
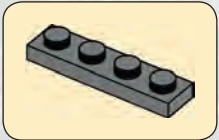



2x



2x

6

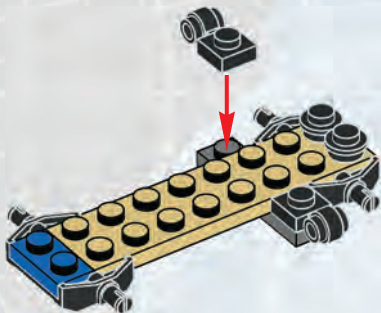

1x



2x

7

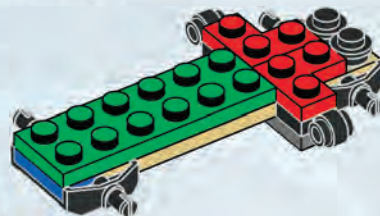



8

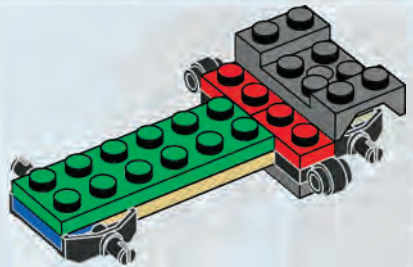

6



9

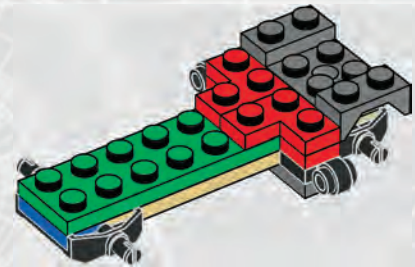



1x



2x

10



2x



4x

11



1



2

2x

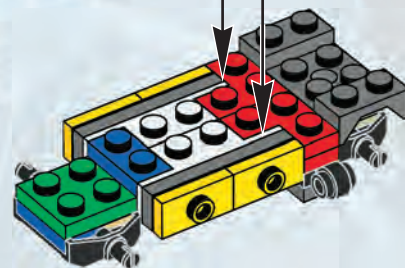



12

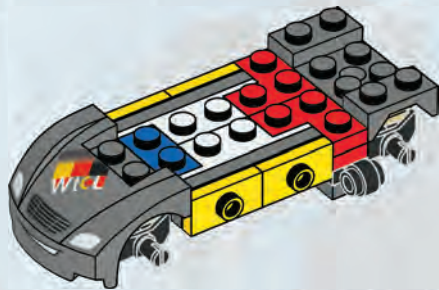

13

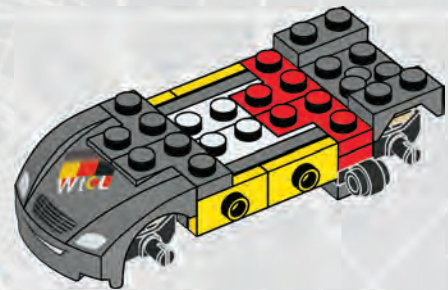

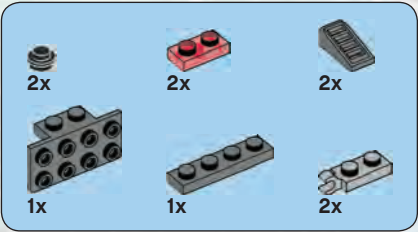

14

1



2

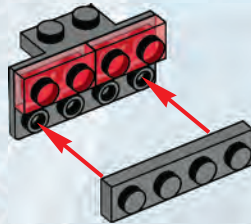

3

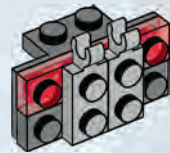

waypoint 7

4

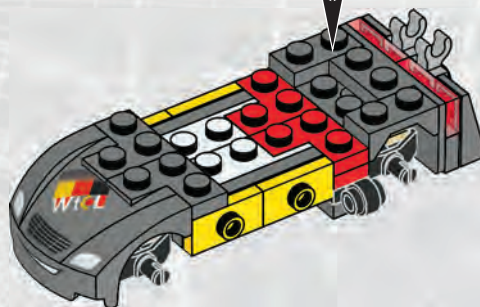



15



16

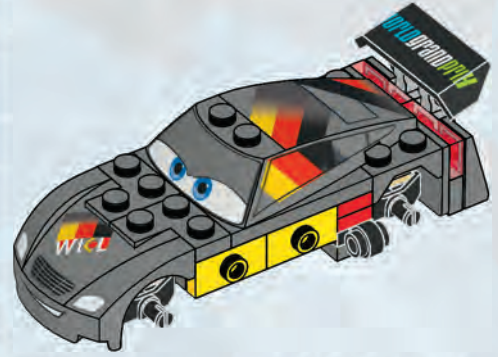



4x



4x

17

aypoint



12



1x



1x

18

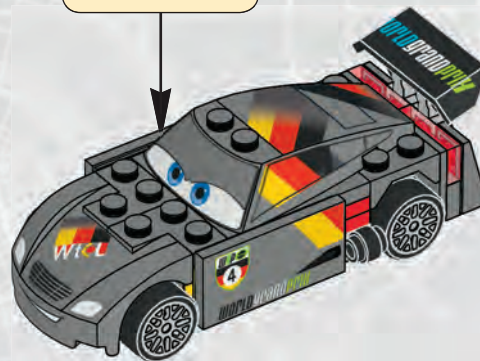

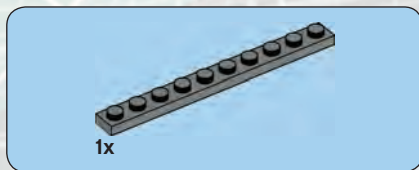
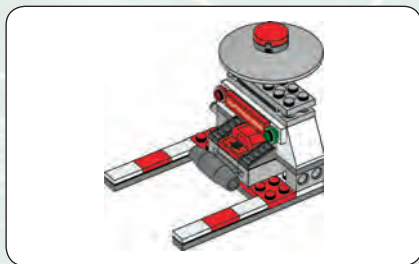

1



2

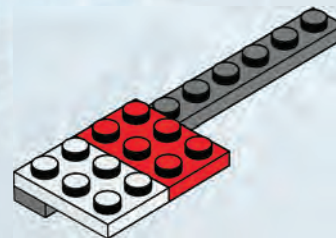



3

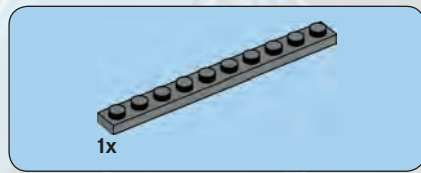
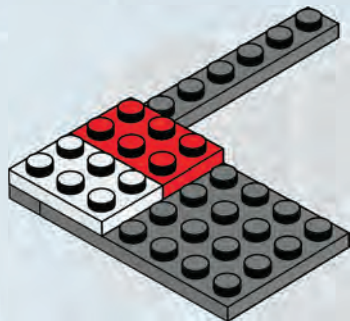

4

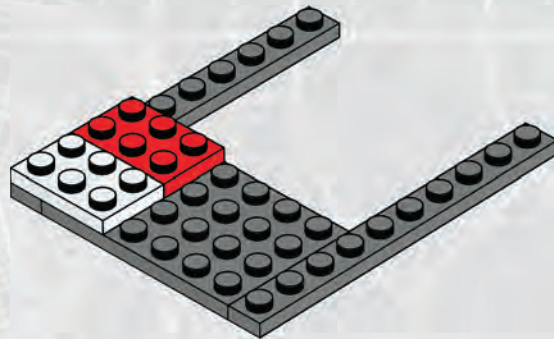



1x

5

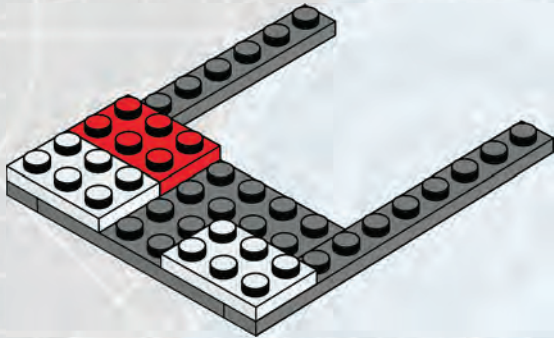

1x

6

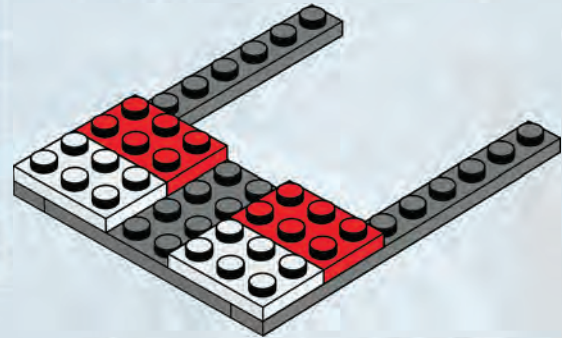

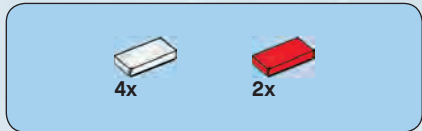

7 *waypoint*

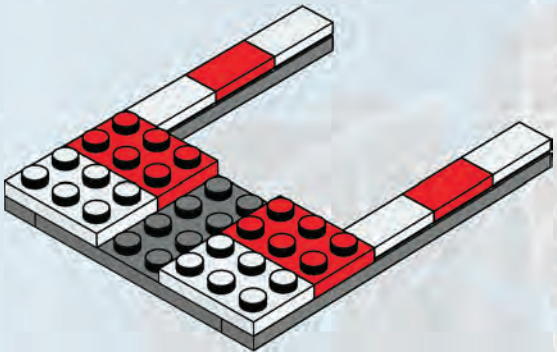

8

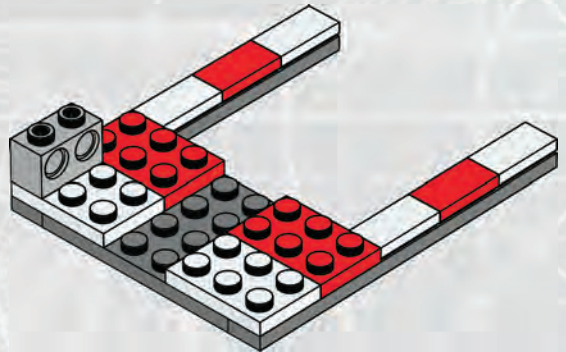

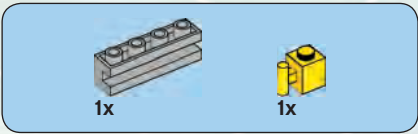

9

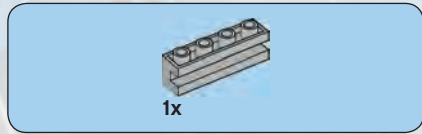
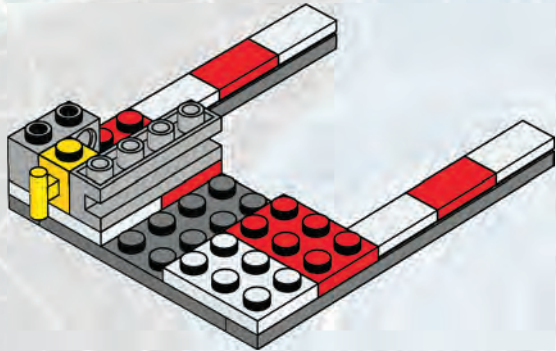

10

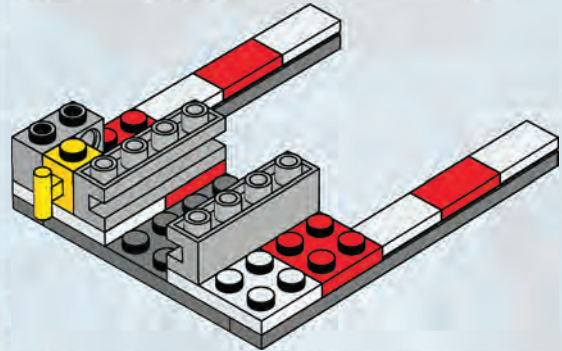



1x



1x

11

waypoint

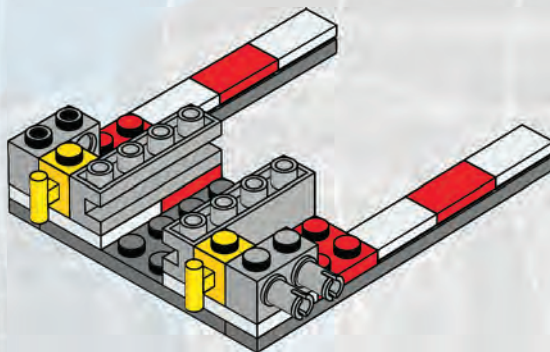

18



2x

12

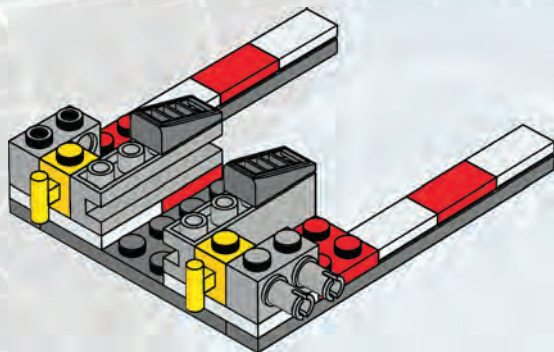

2x

13

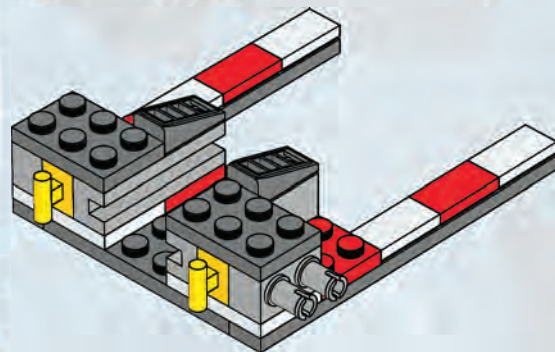

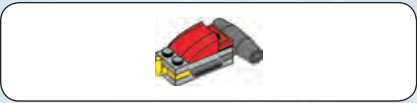

1x

1

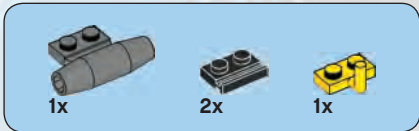

1x

2x

1x

2

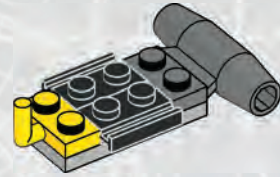

20



3

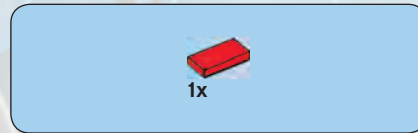
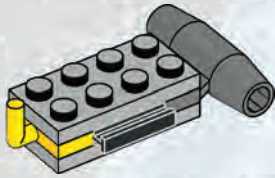

4

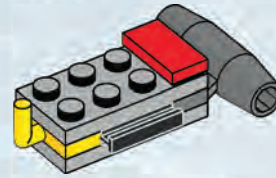

waypoint 7

5

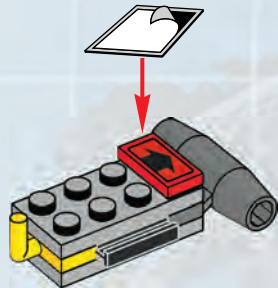

6

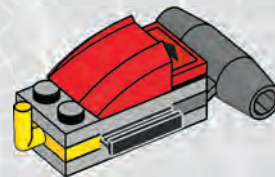

waypoint 2

14

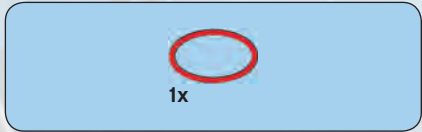
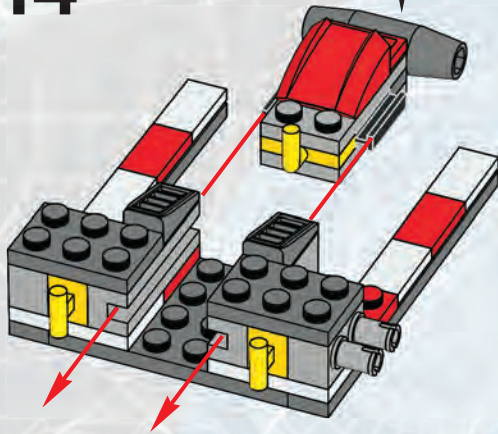

15

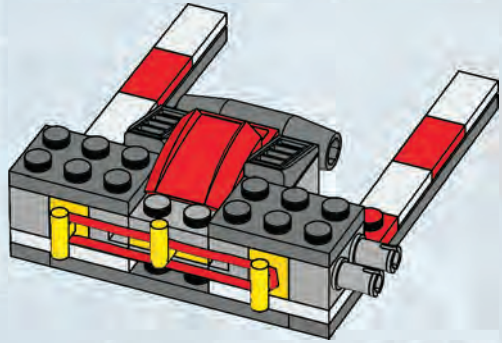



2x

16

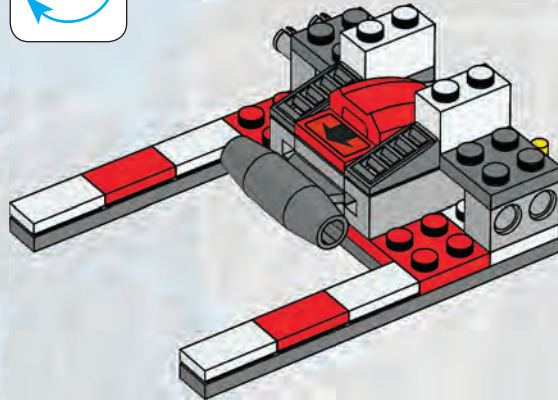
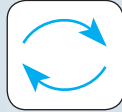

24



2x



2x

17

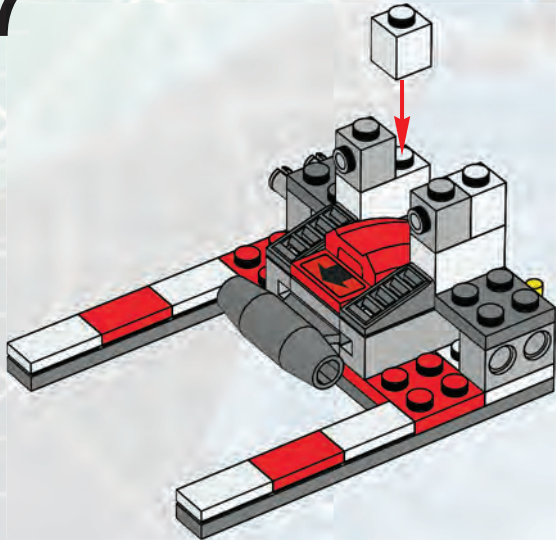

2x

18

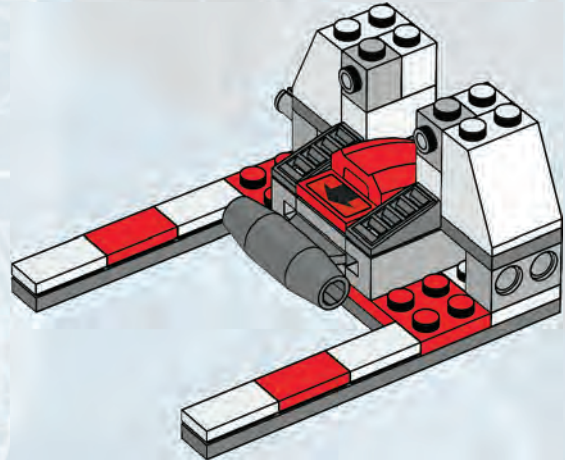



1

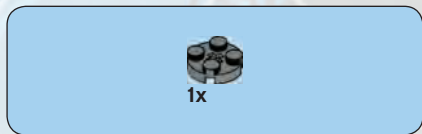

2





3

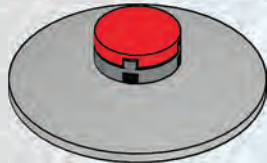

4

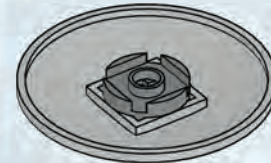
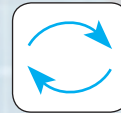



5

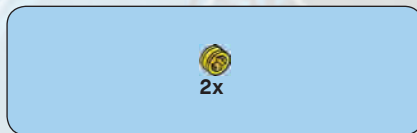
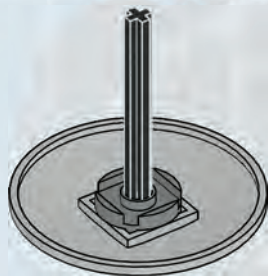

6

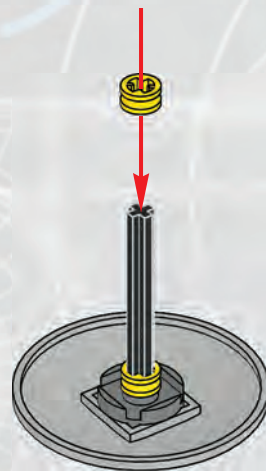

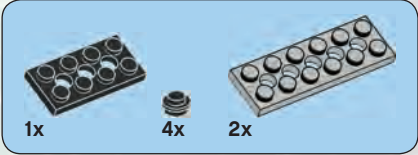

7

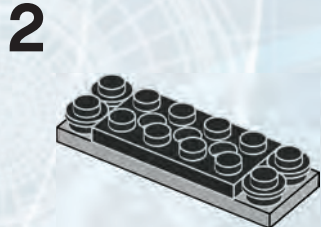
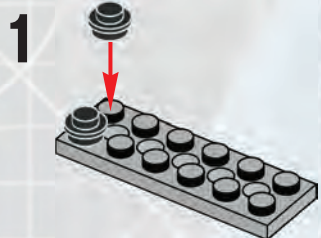

waypoint

1

4

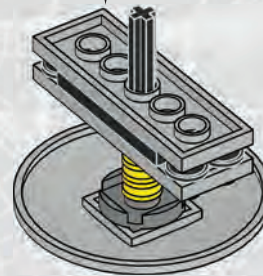
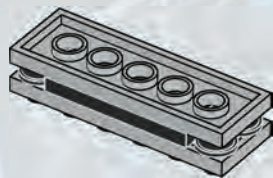
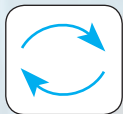

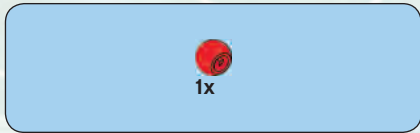

8

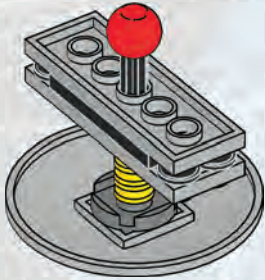

*target
acquired*

19

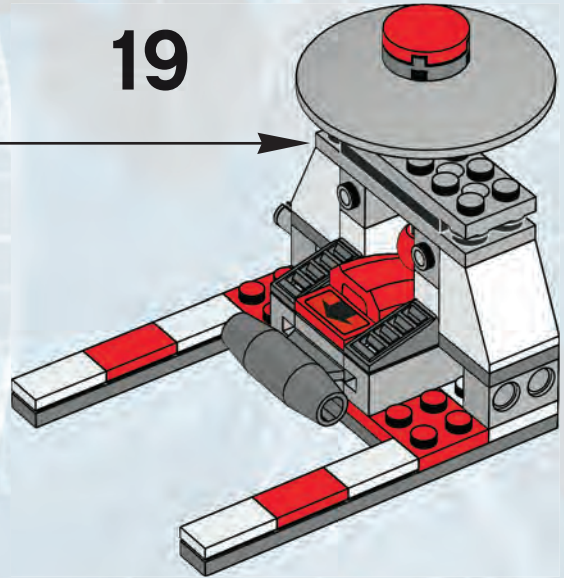

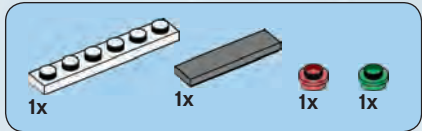

20

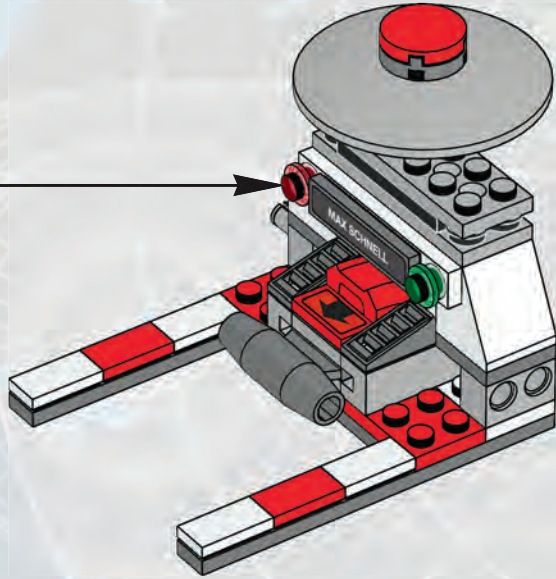

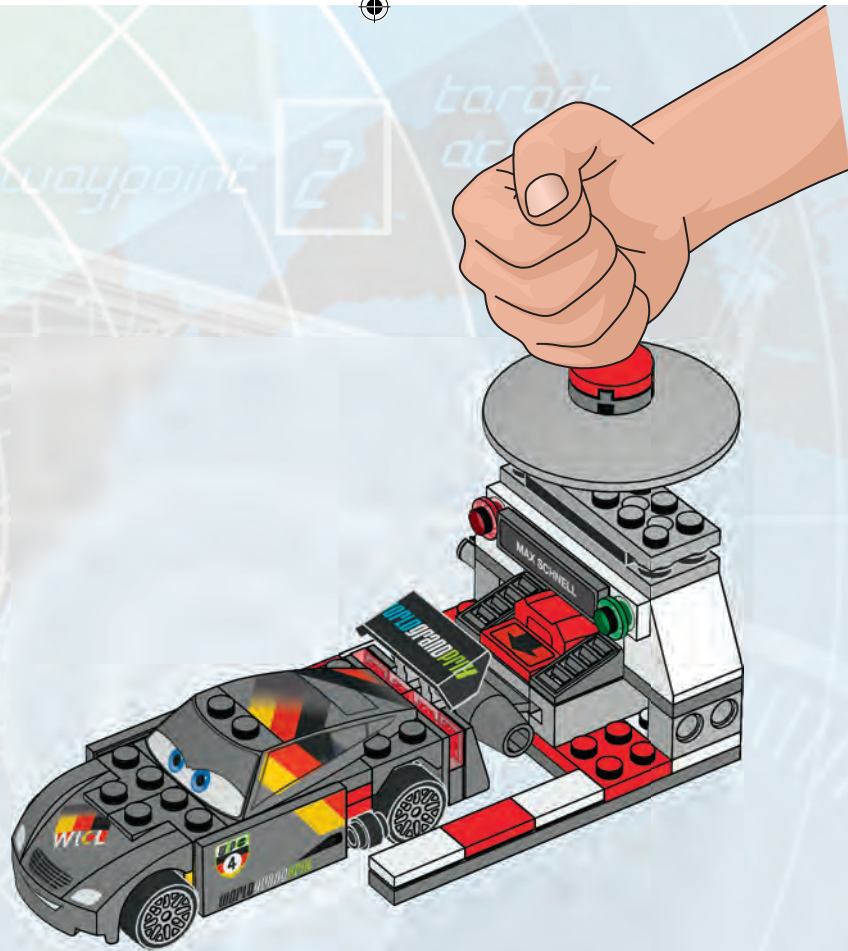

Wingspan

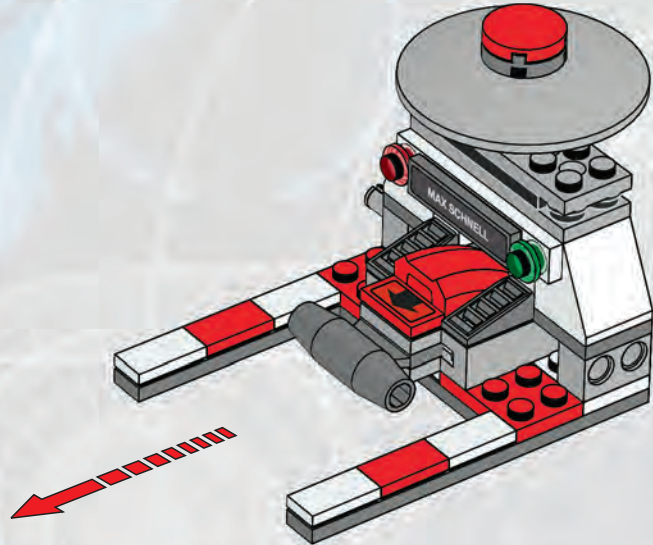

LEGO.com/cars





9480



9481



9486





www.LEGOclub.com



LEGO® Club Email



LEGO® Club Magazine

LEGO club™

FREE! GRATIS! GRATUIT!

SIGN UP ONLINE!

www.LEGOclub.com



00800 5346 5555*



1-866-534-6258 • 1-877-518-5346

US & Canada only

Canada seulement

- * Freephone. Mobile charges may apply.
- * Numéro sans frais. Des frais peuvent s'appliquer avec les téléphones cellulaires.
- * Gebührenfrei, Kosten für Anrufe aus Mobilfunknetzen können abweichen.
- * Gratis telefoonnummer vanaf vaste lijn.
- * Det er et gratis nummer, når du ringer fra fasttelefon.
- * Det är gratis, när du ringer från en fast telefon.
- * Numéro sans frais. Des frais peuvent s'appliquer avec les téléphones portables.

BH14

YES! I want to join the LEGO® Club FREE! **OUI!** Je veux m'abonner au LEGO® Club GRATUITEMENT ! **Ja!** Ich möchte Mitglied im kostenlosen LEGO® Club werden.
Ja! Ik wil graag GRATIS lid worden van de LEGO® Club. **Ja!** Jeg ønsker å melde meg inn i LEGO® Club gratis! **Ja!** Jag vill gå med i LEGO® Club GRATIS!

First name • Prénom Vorname • Voornaam Fornavn • Förnamn											
Last name • Nom de famille Name • Achternaam Etternavn • Efternamn											
Date of Birth • Date de naissance Geburtsdag • Geboortedatum Fødselsdato • Fødselsedatum											
Street • Adresse Straße, Hausnr. Straat, huisnr. • Adress											
City • Ville Ort • Woonplaats Poststedt • Postort						State Prov. County					
Zip/Postcode Code Postal • PLZ Postcode Postnummer						Country Pays Land					
Email • Courriel E-Mail • E-post											

Mail to: / Poster à:	LEGO® Club P.O. Box 1157 Enfield, CT USA 06083-1157	Send till: LEGO® Club Norge Postboks 58 1314 Vøyenenga
Mail to:	LEGO® Club 33 Bath Road Slough SL1 3UF United Kingdom	Skickas till: LEGO® Club Sverige Ubox 841 202 29 Malmö
Per Post an:	LEGO® Club Postfach 14 15 D-36243 Niederaula	Poster à: LEGO® Club 21 rue de la banque 75 002 PARIS FRANCE
Stuur op naar:	LEGO® Club Postbus 40250 3504 AB Utrecht	

- Fill in your email address and we will send you a membership confirmation and monthly email newsletters. If you do not wish to receive the newsletters please tick here. Remplis ton adresse e-mail et nous t'enverrons une confirmation d'adhésion ainsi que le bulletin e-mail mensuel. Si tu ne désires pas recevoir le bulletin, coche cette case. Vuli je e-mailadres in en we sturen je een bevestiging van je lidmaatschap en maandelijkse e-mail nieuwsbrieven. Als je geen e-mail wilt ontvangen, kruis dan dit vakje aan.
- If you do not wish to receive additional mailings from the LEGO Club please tick here. Si tu ne désires pas recevoir de courrier supplémentaire du Club LEGO, coche cette case. Als je geen verdere post van de LEGO Club wilt ontvangen, kruis dan dit vakje aan.
- Ich möchte per E-Mail den monatlichen LEGO Club Newsletter erhalten. Önsker du at vi skal sende en liten hilsen til barnet ditt for å bekrefte medlemskapet, ber vi deg kryssje av i feltet, samt oppgi e-postadressen som hilsen skal sendes til. Om du vill at vi ska skicka en bekräftelse på ditt barns medlemskap, ber vi dig sätta ett kryss i rutan och skriva den e-post adress som bekräftelsen ska skickas till.
- Om du vill få annan information från LEGO Gruppen, sätt ett kryss här. Dersom du ønsker å motta annen informasjon fra LEGO Gruppen, sett der et kryss her.

The English language version of the magazine can only be mailed to addresses in the US, Canada, the UK, and Republic of Ireland. Club membership is valid for two years and includes free copies of the LEGO Club Magazine and e-mail newsletters. In the US and Canada please allow up to 6 weeks for delivery of your first magazine. In the UK and Republic of Ireland please allow six to 14 weeks for delivery of your first magazine. By signing this form you consent the LEGO Club to use your child's data for LEGO mailings. The data will only be used for LEGO mailings and will not be sold, rented or otherwise disclosed to any company outside the LEGO Company except for disclosure to companies acting as our agents to help us provide services requested by the child. This coupon is valid for one membership per person, group or organization. Photocopies coupons are accepted. La version française du magazine peut être postée uniquement au Canada. L'abonnement est valide pour 2 ans et inclut des exemplaires gratuits du Magazine LEGO. Aux E-U et au Canada, attendez 6 semaines pour la livraison initiale. En remplissant ce formulaire, vous consentez à ce que LEGO utilise les informations de votre enfant pour des envois postaux de LEGO. L'information sera utilisée uniquement pour des envois postaux par LEGO et ne sera en aucun cas, vendue, louée, échangée ou divulguée à d'autres compagnies autres que la compagnie LEGO à l'exception des compagnies affiliées qui nous procurent des services auxquels l'enfant en a fait la demande. Formulaire photocopies acceptées. Mit der folgenden Unterschrift erkläre ich, für mein Kind den Beitritt als Mitglied zum kostenlosen LEGO Club, der von der LEGO GmbH, D-8527 Grabbrunn, betrieben wird. Die Mitgliedschaft beinhaltet die Zusendung des LEGO Club Magazines und kann beiderseits jederzeit beendet werden. Mit der Mitgliedschaft im LEGO Club sind keinerlei Verpflichtungen verbunden. Das deutschsprachige LEGO Club Magazin wird nur an Adressen in Deutschland, Österreich und der Schweiz versendet. Eine Anmeldebestätigung kann nur per E-Mail geschickt werden. Das Magazin erscheint fünfmal jährlich. Daher kann die Zustellung des ersten Heftes bis zu drei Monate dauern. Die Mitgliedschaft ist beidseitig jederzeit kündbar, ohne dass Ihnen Kosten entstehen. Sie können der werblichen Nutzung Ihrer Daten jederzeit widersprechen, Kündigung und Widerspruch können Sie telefonisch erklären (00800 / 5346 5555, Anruf gebührenfrei, Kosten für Anrufer aus dem Mobilfunknetz können an die LEGO GmbH senden). Het Nederlandse LEGO Club Magazine kan alleen worden gestuurd naar adressen in Nederland. Het lidmaatschap is 2 jaar geldig en geeft recht op toezending van het gratis LEGO Club Magazine en LEGO Club e-mails. Het eerste magazine zal binnen 12 tot 14 weken toegestuurd worden. Het lidmaatschap kan op ieder moment opgezegd worden en kan na 2 jaar gratis worden verlengd, tenzij LEGO met deze activiteit stopt. Uw gegevens worden uitsluitend gebruikt voor mailings van LEGO en zullen niet worden verkocht, verhuurd of op welke wijze dan ook verstrekt aan derden buiten de LEGO Groep, uitgezonderd de organisaties die namens ons optreden om de informatie te sturen waarvoor toestemming is verleend. Den norske utgaven av magasinet sendes kun til adresser i Norge. Medlemskap i klubben gjelder i 2 år og inkluderer gratisutgaver av LEGO Club Magazine. Pålegg minimum oppkøpsbeløp for leveringstid for første magasin. Ved å undertegne dette skjemaet, gir du ditt samtykke til at LEGO Club kan bruke opplysningene om barnet ditt i LEGO foresendelser. Dataene vil utelukkende bli brukt i LEGO foresendelser og vil ikke bli solgt, utleiet eller på annen måte gjøres tilgjengelig for selskaper utenfor LEGO gruppen, unntatt selskaper som er våre agenter og som hjelper oss å tilby tjenestene barnet ettertar. Dette skjemaet gjelder for ett gratis medlemskap per person, gruppe eller organisasjon. Den svenska versionen av tidningen kan endast skickas till adresser i Sverige. Club-medlemskapet är giltigt i 2 år och innefattar gratis exemplar av LEGO Club Magazine. Vånligen räkna med minimum 6 veckor för leverans av den första tidning. Genom att skicka in det här formuläret godkänner du att LEGO Club använder barnets uppgifter för LEGO utskick. Uppgifterna kommer bara att användas för LEGO utskick och kommer inte att säljas, hyras ut eller vidarebefordras till något företag som tillhör LEGO Gruppen, med undantag av företag som agerar som våra ombud för att tillhandahålla tjänster som barnet har begärt. Den här kupongen gäller för ett gratis medlemskap per person, grupp eller organisation. En complément ce bulletin d'adhésion, vous acceptez que LEGO Club utilise les données relatives à votre enfant pour l'envoi de courriers concernant LEGO. Ces données seront uniquement utilisées pour l'envoi d'information concernant LEGO et ne seront ni vendues, ni louées, ni utilisées par d'autres sociétés que le groupe LEGO, à l'exception des sociétés agissant pour le compte de LEGO en tant que sous-traitant de services divers. L'abonnement au LEGO Club est valable pour une période de 2 ans. Il inclut l'envoi par courrier du magazine LEGO Club et par email des newsletters. Un délai de 6 à 14 semaines est à prévoir pour la réception de votre premier magazine. Ce bulletin d'adhésion gratuit est valable pour l'inscription d'une seule personne. Les photocopies sont acceptées. ATTENTION! Le bulletin d'adhésion doit être rempli et signé par un parent ou un tuteur.

Parent's signature • Signature d'un parent ou d'un tuteur _____ Date _____
 Unterschrift Erziehungsberechtigter / Handtekening ouders _____ Datum _____
 Foreldres/foresattes underskrift • Föräldrars /förmyndares underskrift _____ Dato _____



6003667

LEGO and the LEGO logo are trademarks of the LEGO Group. ©2012 The LEGO Group. © Disney/Pixar

The LEGO logo is displayed in its characteristic white font with a yellow outline, set against a red square background.

9485



 **WARNING:** CHOKING HAZARD.
Toy contains small parts and a small ball.
Not for children under 3 years.

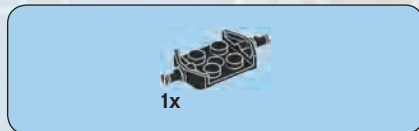

1



AVERTISSEMENT : RISQUE D'ÉTOUFFEMENT.

Le jouet contient des petites pièces ainsi qu'une petite boule.
Il ne convient pas aux enfants de moins de 3 ans.



ADVERTENCIA: PELIGRO DE ASFIXIA.

Juguete que contiene partes pequeñas y una pelota pequeña.
No recomendado para niños menores de 3 años.



2

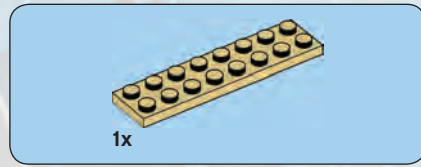

3

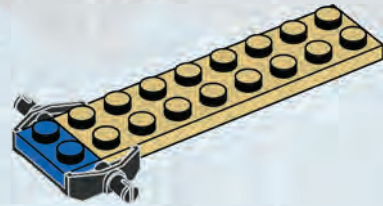



4

Waypoint

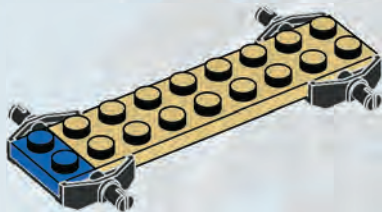

4



5

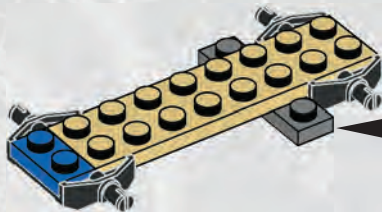
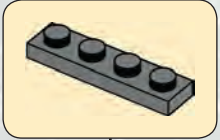



2x



2x

6

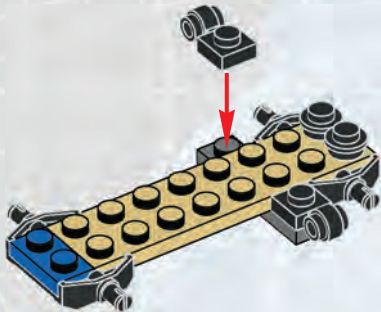

1x



2x

7

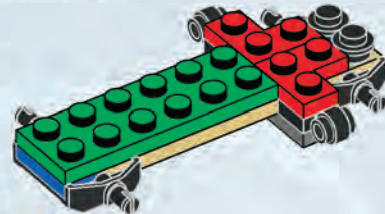



8

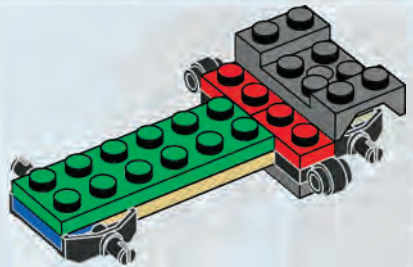

6



9

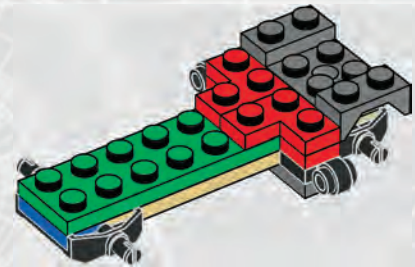



1x



2x

10



2x



4x

11



1



2

2x

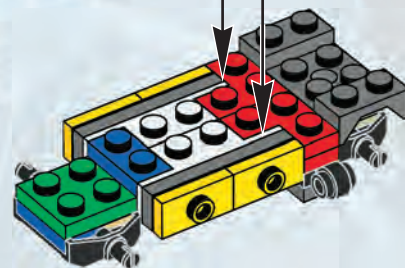



12

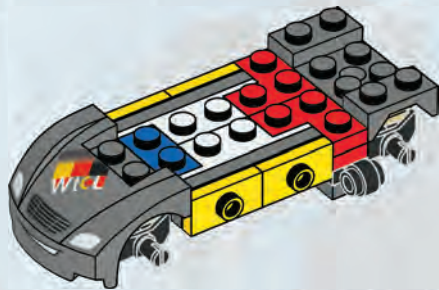

13

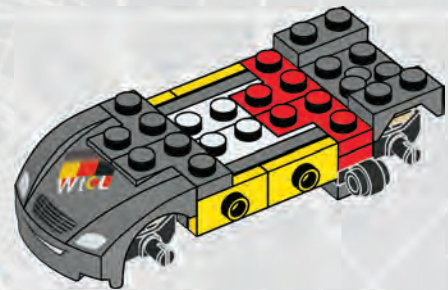

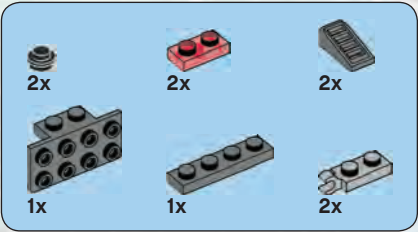

14

1



2

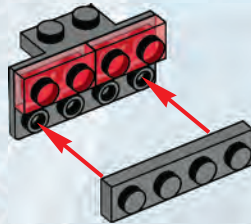

3

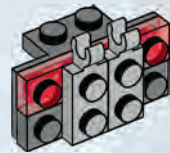

waypoint 7

4

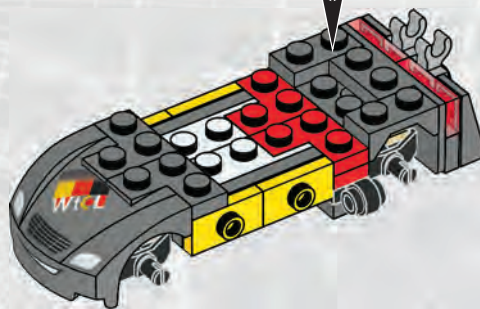



15



16

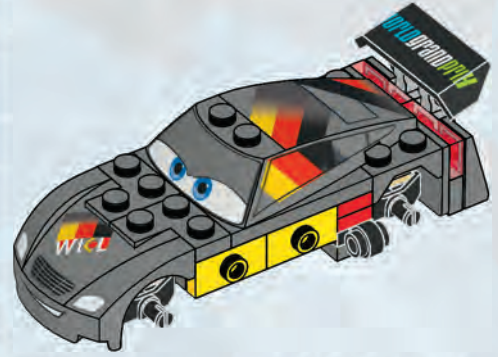



4x



4x

17



12



1x



1x

18

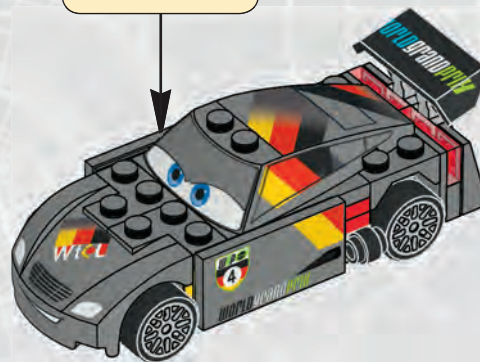

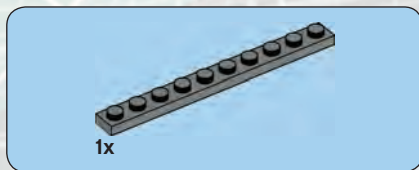
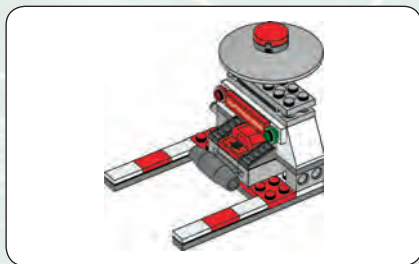

1x

1



1x

1x

2

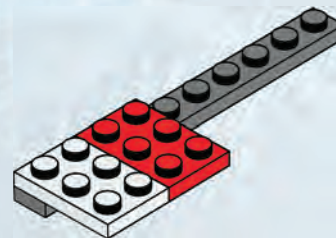



3

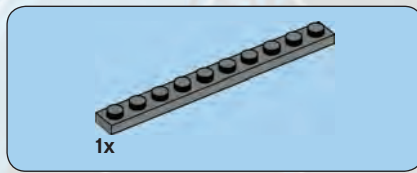
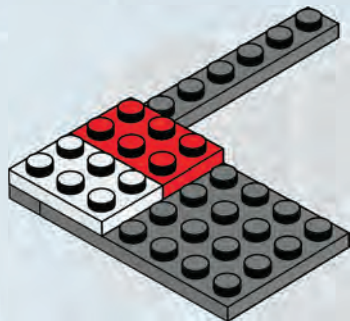

4

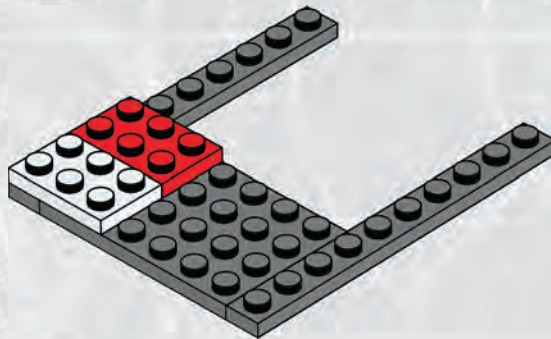

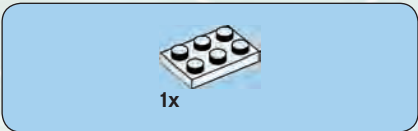

5

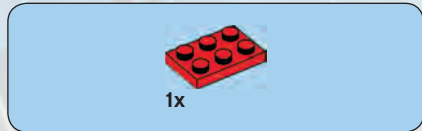
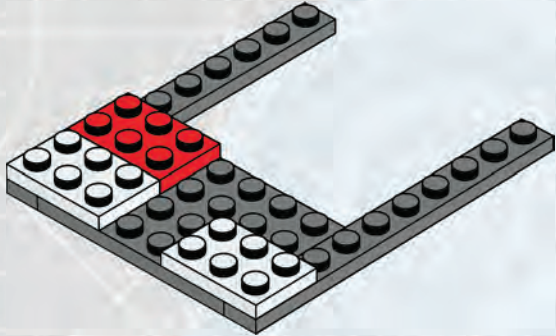

6

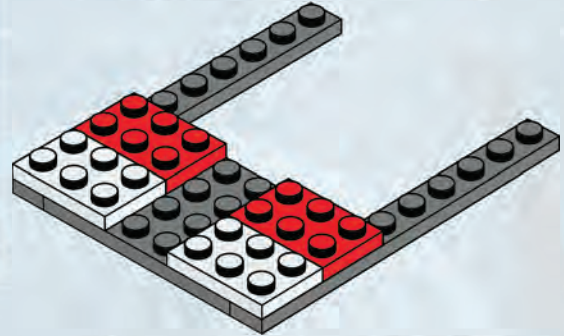



7 *waypoint*

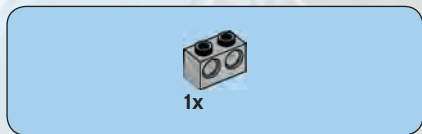
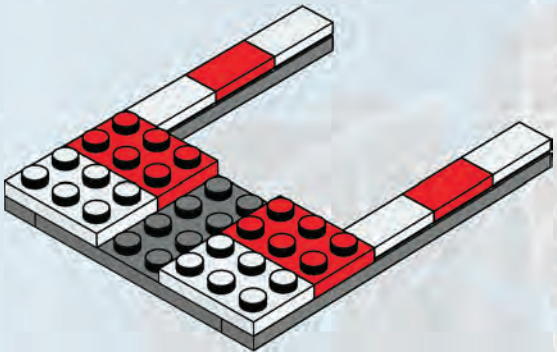

8

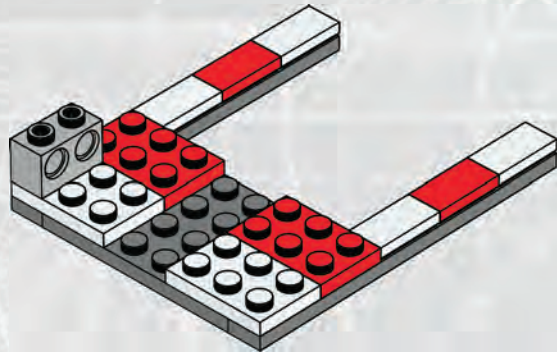

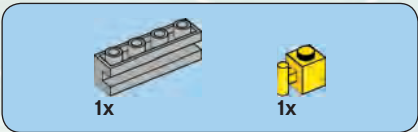

9

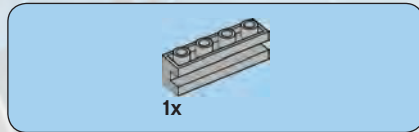
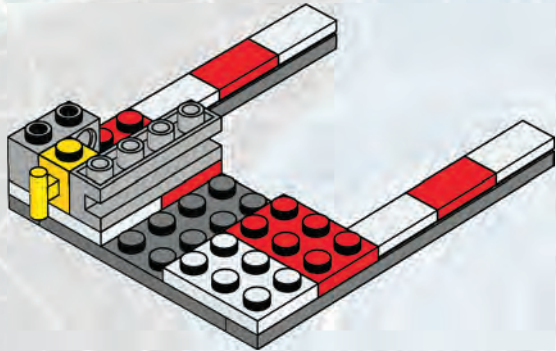

10

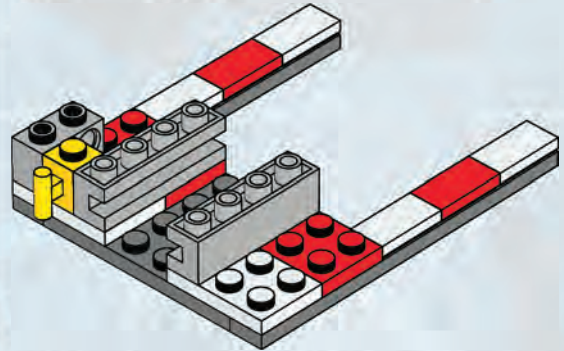



1x



1x

11

waypoint

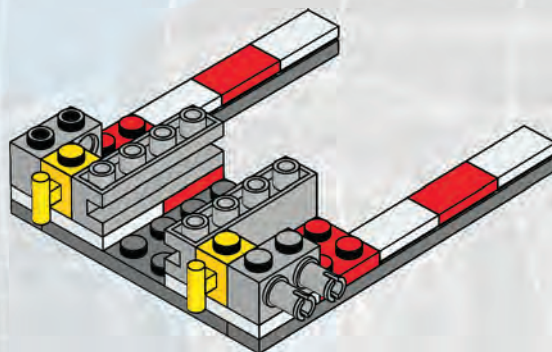

18



12

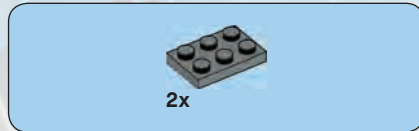
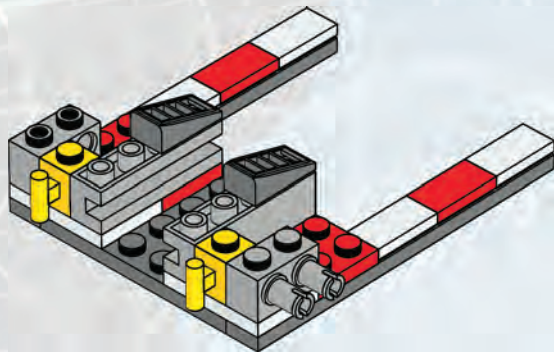

13

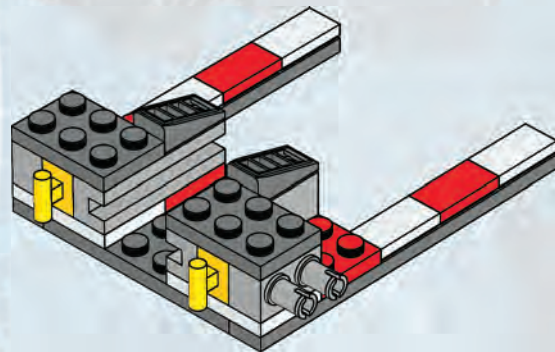

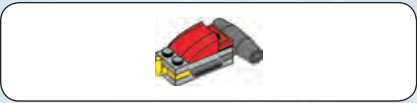

1x

1

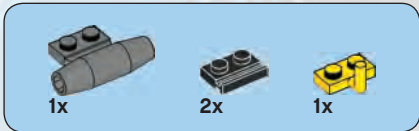

1x

2x

1x

2

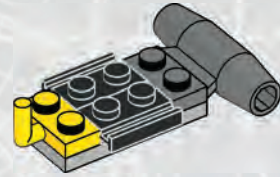



3

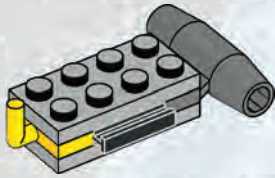

4

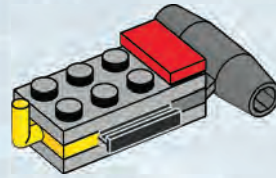

waypoint 7

5

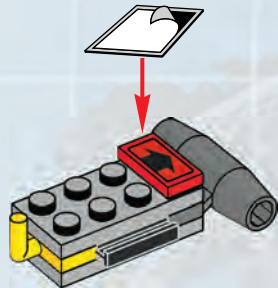

6

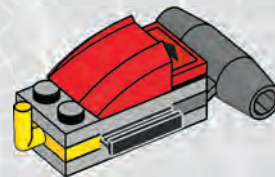

14

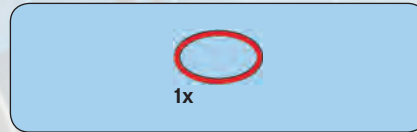
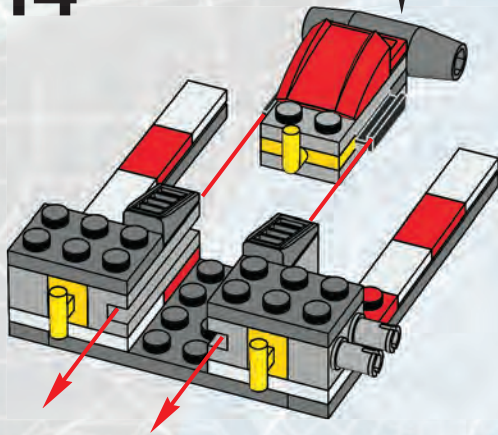

15

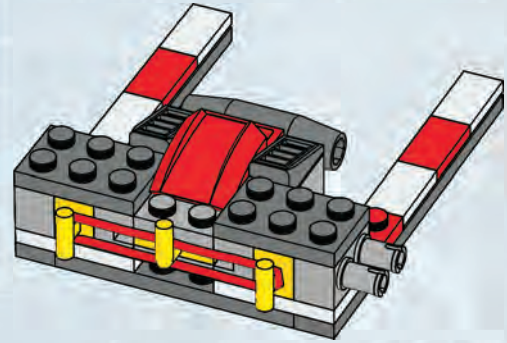



2x

16

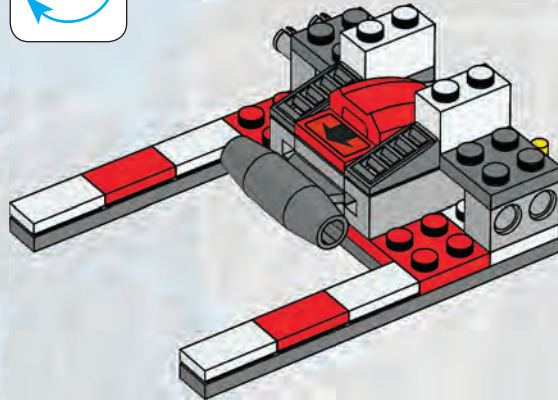
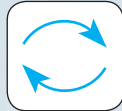

24



2x



2x

17

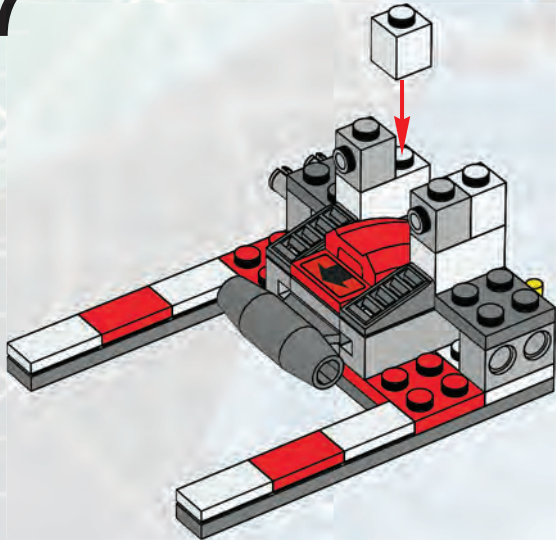

2x

18

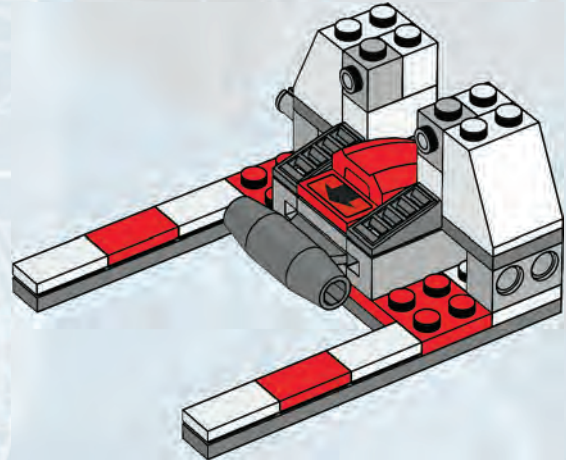



1

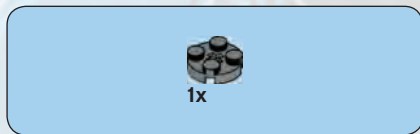

2





3

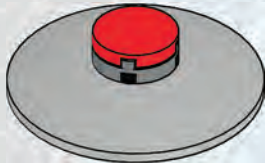

4

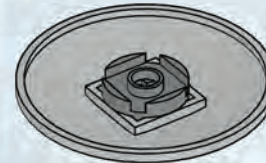
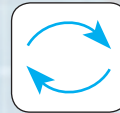



5

waypoint

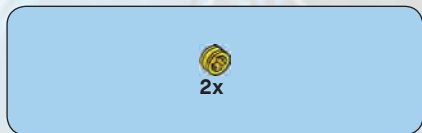

6

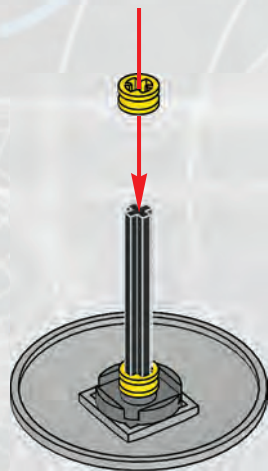

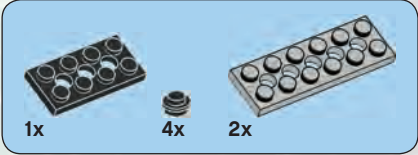

7

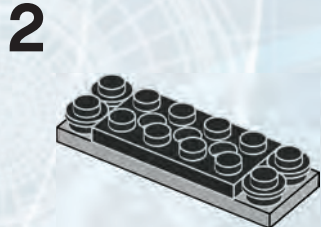
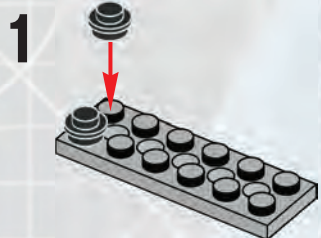

waypoint

1

4

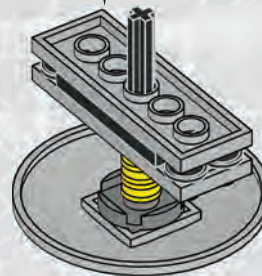
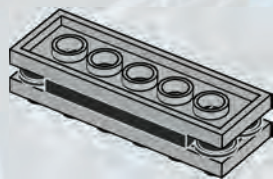
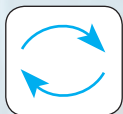

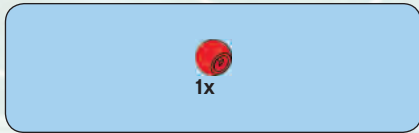

8

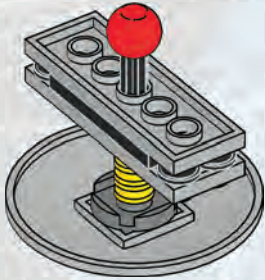

*target
acquired*

19

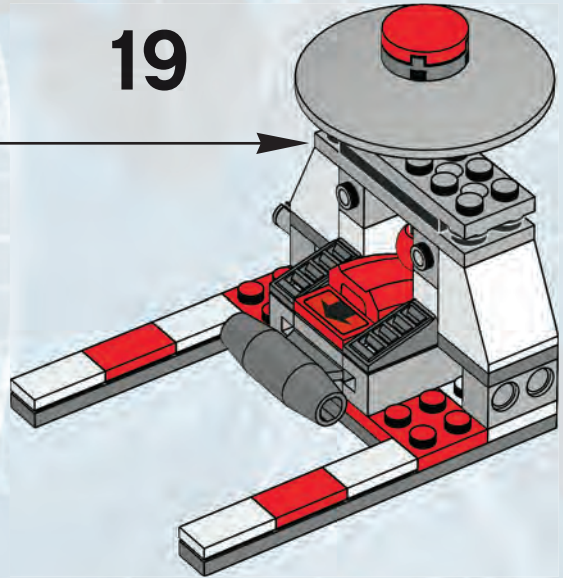

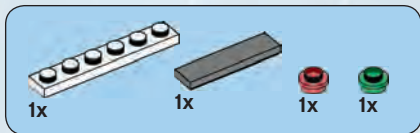

20

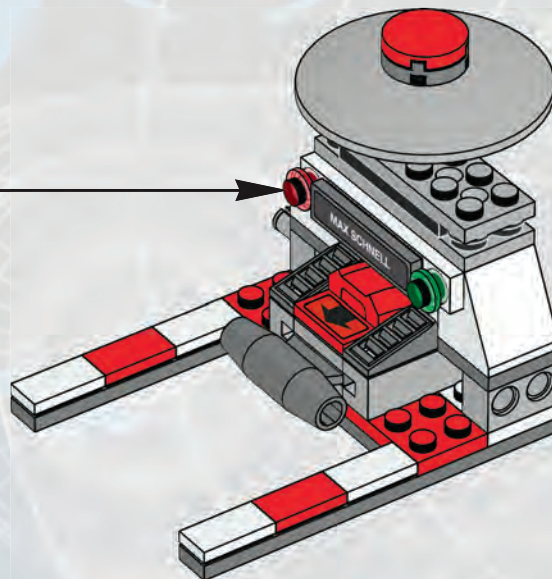

32

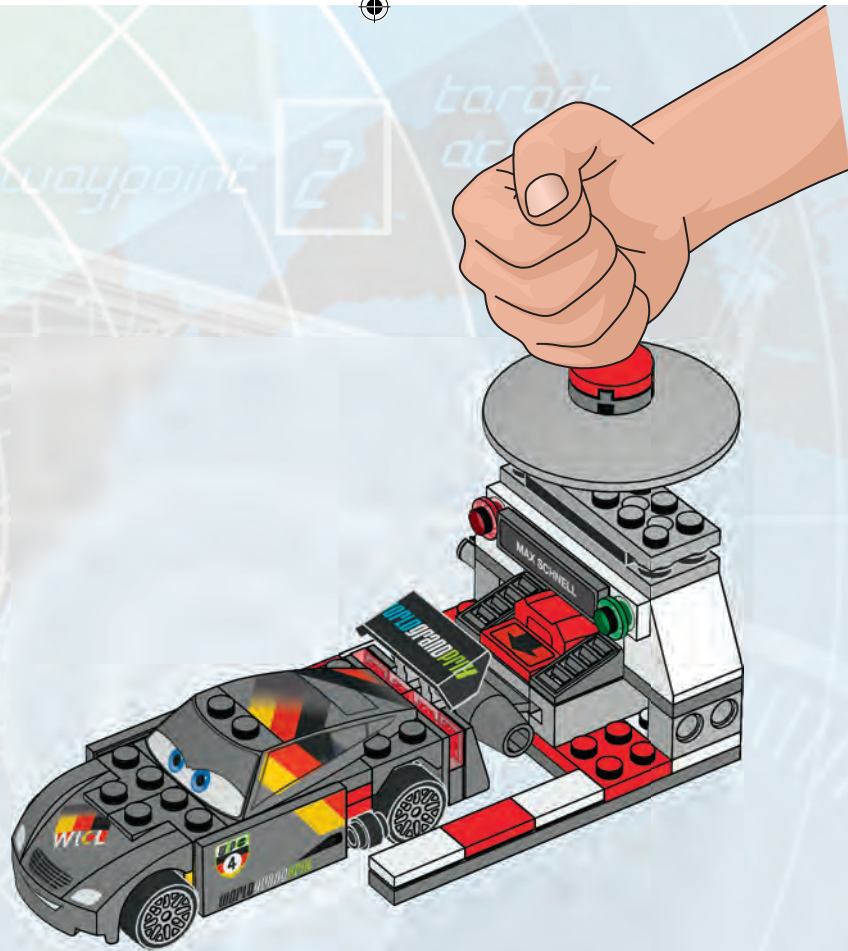

Wingspan

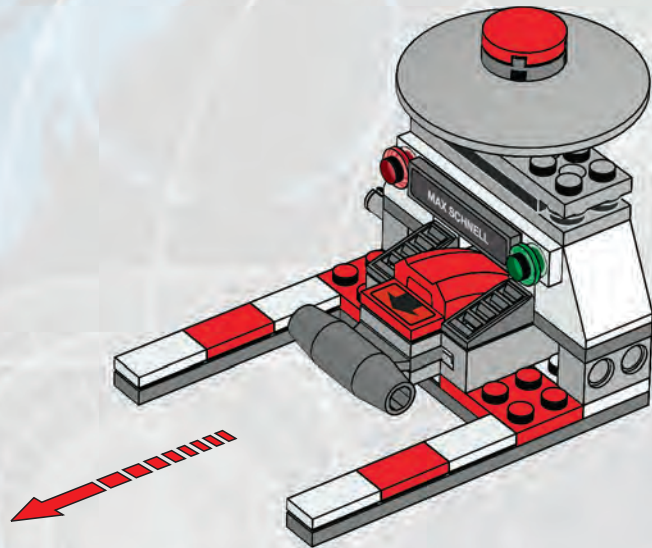

LEGO.com/cars







9480



9481



9486





www.LEGOclub.com



LEGO® Club Email



LEGO® Club Magazine

LEGO club™

FREE! GRATIS! GRATUIT!

SIGN UP ONLINE!

www.LEGOclub.com



00800 5346 5555*



1-866-534-6258 • 1-877-518-5346

US & Canada only

Canada seulement

- * Freephone. Mobile charges may apply.
- * Numéro sans frais. Des frais peuvent s'appliquer avec les téléphones cellulaires.
- * Gebührenfrei, Kosten für Anrufe aus Mobilfunknetzen können abweichen.
- * Gratis telefoonnummer vanaf vaste lijn.
- * Det er et gratis nummer, når du ringer fra fasttelefon.
- * Det är gratis, när du ringer från en fast telefon.
- * Numéro sans frais. Des frais peuvent s'appliquer avec les téléphones portables.

BI114

YES! I want to join the LEGO® Club FREE! **OUI!** Je veux m'abonner au LEGO® Club GRATUITEMENT! **Ja!** Ich möchte Mitglied im kostenlosen LEGO® Club werden.
Ja! Ik wil graag GRATIS lid worden van de LEGO® Club. **Ja!** Jeg ønsker å melde meg inn i LEGO® Club gratis! **Ja!** Jag vill gå med i LEGO® Club GRATIS!

First name • Prénom Vorname • Voornaam Fornavn • Förnamn											
Last name • Nom de famille Name • Achternaam Etternavn • Efternamn											
Date of Birth • Date de naissance Geburtsdag • Geboortedatum Fødselsdato • Fødselsedatum											
Street • Adresse Straße, Hausnr. Straat, huisnr. • Address											
City • Ville Ort • Woonplaats Poststed • Postort						State Prov. County					
Zip/Postcode Code Postal • PLZ Postcode Postnummer						Country Pays Land					
Email • Courriel E-Mail • E-post											

Mail to: / Poster à:	LEGO® Club P.O. Box 1157 Enfield, CT USA 06083-1157	Send till: LEGO® Club Norge Postboks 58 1314 Vøyenenga
Mail to:	LEGO® Club 33 Bath Road Slough SL1 3UF United Kingdom	Skicka till: LEGO® Club Sverige Ubox 841 202 29 Malmö
Per Post an:	LEGO® Club Postfach 14 15 D-36243 Niederaula	Poster à: LEGO® Club 21 rue de la banque 75 002 PARIS FRANCE
Stuur op naar:	LEGO® Club Postbus 40250 3504 AB Utrecht	

- Fill in your email address and we will send you a membership confirmation and monthly email newsletters. If you do not wish to receive the newsletters please tick here. Remplis ton adresse e-mail et nous t'enverrons une confirmation d'adhésion ainsi que le bulletin e-mail mensuel. Si tu ne désires pas recevoir le bulletin, coche cette case. Vuli je e-mailadres in en we sturen je een bevestiging van je lidmaatschap en maandelijkse e-mail nieuwsbrieven. Als je geen e-mail wilt ontvangen, kruis dan dit vakje aan.
- If you do not wish to receive additional mailings from the LEGO Club please tick here. Si tu ne désires pas recevoir de courrier supplémentaire du Club LEGO, coche cette case. Als je geen verdere post van de LEGO Club wilt ontvangen, kruis dan dit vakje aan.
- Ich möchte per E-Mail den monatlichen LEGO Club Newsletter erhalten. Ønsker du at vi skal sende en liten hilsen til barnet ditt for å bekrefte medlemskap, ber vi deg kryssje av i feltet, samt oppgi e-postadressen som hilsenen skal sendes til. Om du vill at vi ska skicka en bekräftelse på ditt barns medlemskap, ber vi dig sätta ett kryss i rutan och skriva den e-post adress som bekräftelsen ska skickas till.
- Om du vill få annan informasjon från LEGO Gruppen, sätt ett kryss här. Dersom du ønsker å motta annen informasjon fra LEGO Gruppen, sett der et kryss her.

The English language version of the magazine can only be mailed to addresses in the US, Canada, the UK, and Republic of Ireland. Club membership is valid for two years and includes free copies of the LEGO Club Magazine and e-mail newsletters. In the US and Canada please allow up to 6 weeks for delivery of your first magazine. In the UK and Republic of Ireland please allow six to 14 weeks for delivery of your first magazine. By signing this form you consent the LEGO Club to use your child's data for LEGO mailings. The data will only be used for LEGO mailings and will not be sold, rented or otherwise disclosed to any company outside the LEGO Group except for disclosure to companies acting as our agents to help us provide services requested by the child. This coupon is valid for one free membership per person, group or organization. Photocopies are accepted. La version française du magazine peut être postée uniquement au Canada. L'abonnement est valide pour 2 ans et inclut des exemplaires gratuits du Magazine LEGO. Aux E-U et au Canada, allouez 6 semaines pour la livraison initiale. En remplissant ce formulaire, vous consentez à ce que LEGO utilise les informations de votre enfant pour des envois postaux de LEGO. L'information sera utilisée uniquement pour des envois postaux par LEGO et ne sera en aucun cas, vendue, louée, échangée ou divulguée à d'autres compagnies autres que la compagnie LEGO à l'exception des compagnies affiliées qui nous procurent des services auxquels l'enfant en a fait la demande. Formulaire photocopié accepté. Mit der folgenden Unterschrift erkläre ich, für mein Kind den Beitritt als Mitglied zum kostenlosen LEGO Club, der von der LEGO GmbH, D-8527 Grabbrunn, betrieben wird. Die Mitgliedschaft beinhaltet die Zusendung des LEGO Club Magazines und kann beiderseits jederzeit beendet werden. Mit der Mitgliedschaft im LEGO Club sind keinerlei Verpflichtungen verbunden. Das deutschsprachige LEGO Club Magazin wird nur an Adressen in Deutschland, Österreich und der Schweiz versendet. Eine Anmeldebestätigung kann nur per E-Mail geschickt werden. Das Magazin erscheint fünfmal jährlich. Daher kann die Zustellung des ersten Heftes bis zu drei Monate dauern. Die Mitgliedschaft ist beidseitig jederzeit kündbar, ohne dass Ihnen Kosten entstehen. Sie können der werblichen Nutzung Ihrer Daten jederzeit widersprechen. Kündigung und Widerspruch können Sie telefonisch (00800 / 5346 5555, Anruf gebührenfrei, Kosten für Anrufer aus dem Mobilfunknetz) oder an die LEGO GmbH senden. Het Nederlandse LEGO Club Magazine kan alleen worden gestuurd naar adressen in Nederland. Het lidmaatschap is 2 jaar geldig en geeft recht op toezending van het gratis LEGO Club Magazine en LEGO Club e-mails. Het eerste magazine zal binnen 12 tot 14 weken toegestuurd worden. Het lidmaatschap kan op ieder moment opgezegd worden en kan na 2 jaar gratis worden verlengd, tenzij LEGO met deze activiteit stopt. Uw gegevens worden uitsluitend gebruikt voor mailings van LEGO en zullen niet worden verkocht, verhuurd of op welke wijze dan ook verstrekt aan derden buiten de LEGO Groep, uitgezonderd de organisaties die namens ons optreden om de informatie te sturen waarvoor toestemming is verleend. Den norske utgaven av magasinet sendes kun til adresser i Norge. Medlemskap i klubben gjelder i 2 år og inkluderer gratisutgaver av LEGO Club Magazine. Pålegg minimum opplyst utgjør leveringstid for første magasin. Ved å undertegne dette skjemaet, gir du ditt samtykke til at LEGO Club kan bruke opplysningene om barnet ditt i LEGO foresendelser. Dataene vil utelukkende bli brukt i LEGO foresendelser og vil ikke bli solgt, utleiet eller på annen måte gjøres tilgjengelig for selskaper utenfor LEGO gruppen, unntatt selskaper som er våre agenter og som hjelper oss å tilby tjenestene barnet ettertar. Dette skjemaet gjelder for ett gratis medlemskap per person, gruppe eller organisasjon. Den svenska versionen av tidningen kan endast skickas till adresser i Sverige. Club-medlemskapet är giltigt i 2 år och innefattar gratis exemplar av LEGO Club Magazine. Vånligen räkna med minimum 6 veckor för leverans av den första tidning. Genom att skicka in det här formuläret godkänner du att LEGO Club använder barnets uppgifter för LEGO utskick. Uppgifterna kommer bara att användas för LEGO utskick och kommer inte att säljas, hyras ut eller vidarebefordras till något företag som tillhör LEGO Gruppen, med undantag av företag som agerar som våra ombud för att tillhandahålla tjänster som barnet har begärt. Den här kupongen gäller för ett gratis medlemskap per person, grupp eller organisation. En complétant ce bulletin d'adhésion, vous acceptez que LEGO Club utilise les données relatives à votre enfant pour l'envoi de courriers concernant LEGO. Ces données seront uniquement utilisées pour l'envoi d'information concernant LEGO et ne seront ni vendues, ni louées, ni utilisées par d'autres sociétés que le groupe LEGO, à l'exception des sociétés agissant pour le compte de LEGO en tant que sous-traitants de services divers. L'abonnement au LEGO Club est valable pour une période de 2 ans. Il inclut l'envoi par courrier du magazine LEGO Club et par email des newsletters. Un délai de 6 à 14 semaines est à prévoir pour la réception de votre premier magazine. Ce bulletin d'adhésion gratuit est valable pour l'inscription d'une seule personne. Les photocopies sont acceptées. ATTENTION! Le bulletin d'adhésion doit être rempli et signé par un parent ou un tuteur.

Parent's signature • Signature d'un parent ou d'un tuteur : _____ Date _____
 Unterschrift Erziehungsberechtigter / Handtekening ouders • _____ Datum _____
 Foreldres/foresattes underskrift • Föräldrars/förmyndares underskrift _____ Dato _____

www.LEGO.com 6003669

LEGO and the LEGO logo are trademarks of the/son/tes marques de commerce de/son marcas registradas de LEGO Group. ©2012 The LEGO Group. © Disney/Pixar