

# STAR WARS™

## BATTLE OF HOTH™



3866





1x

# 1



2x



2x



2x

# 2

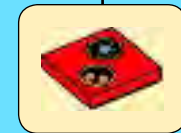
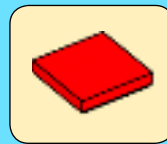



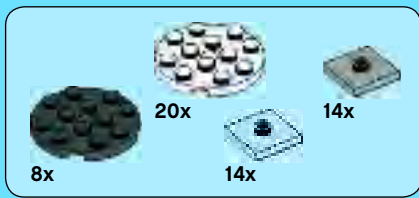

1

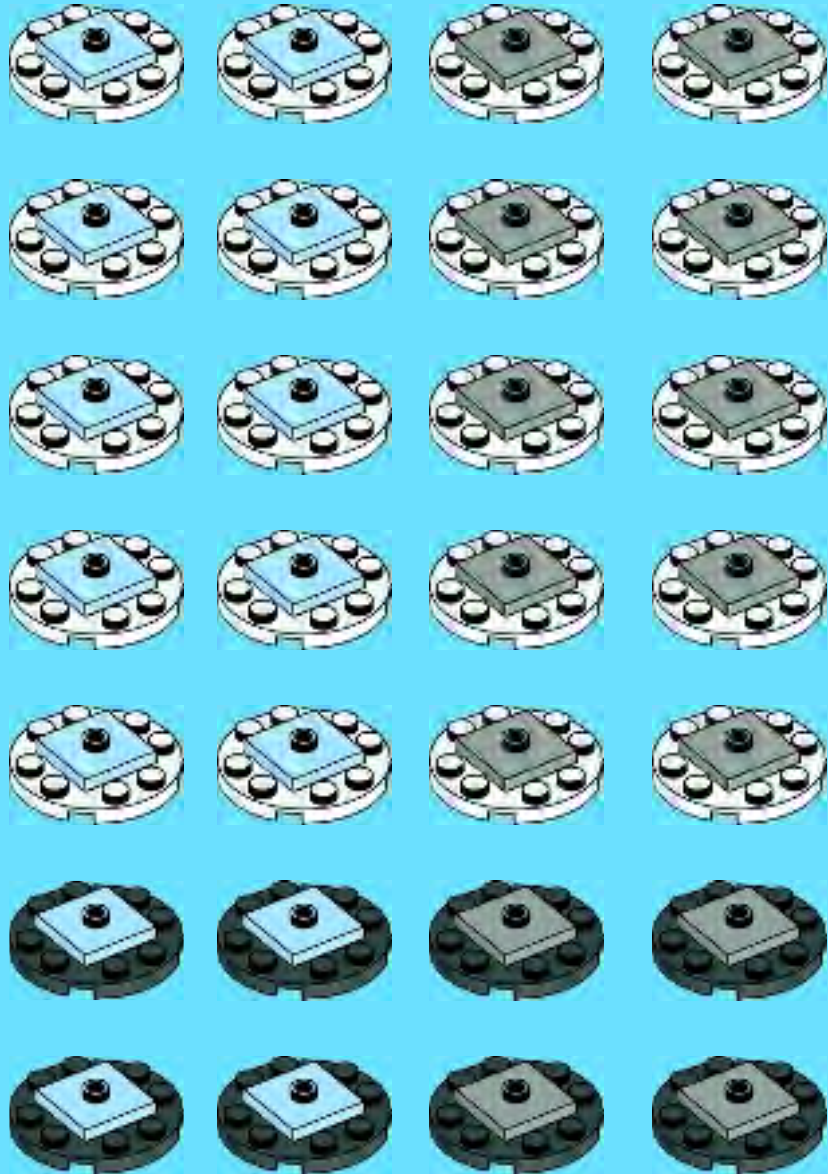

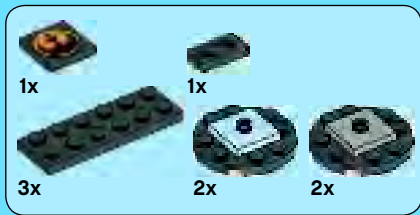

1

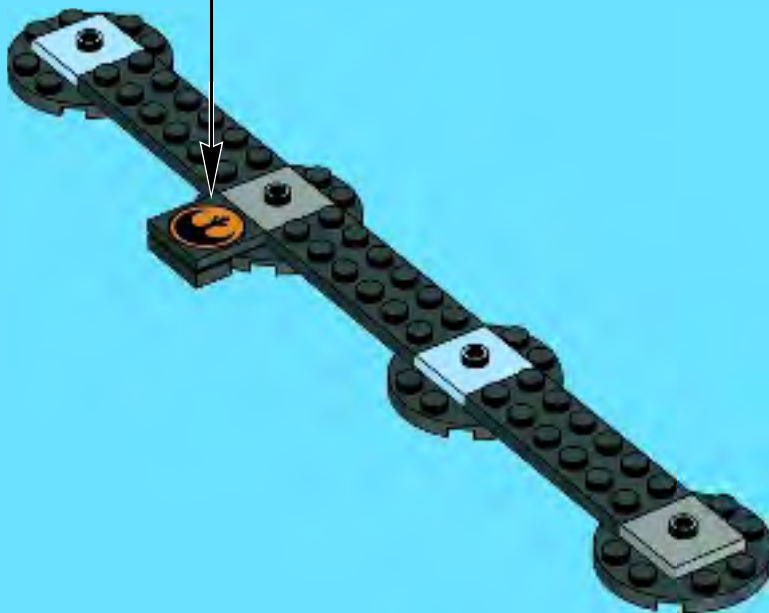

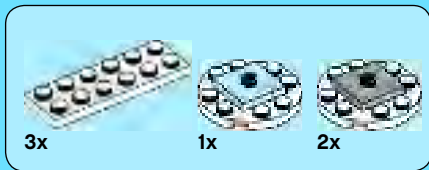

2

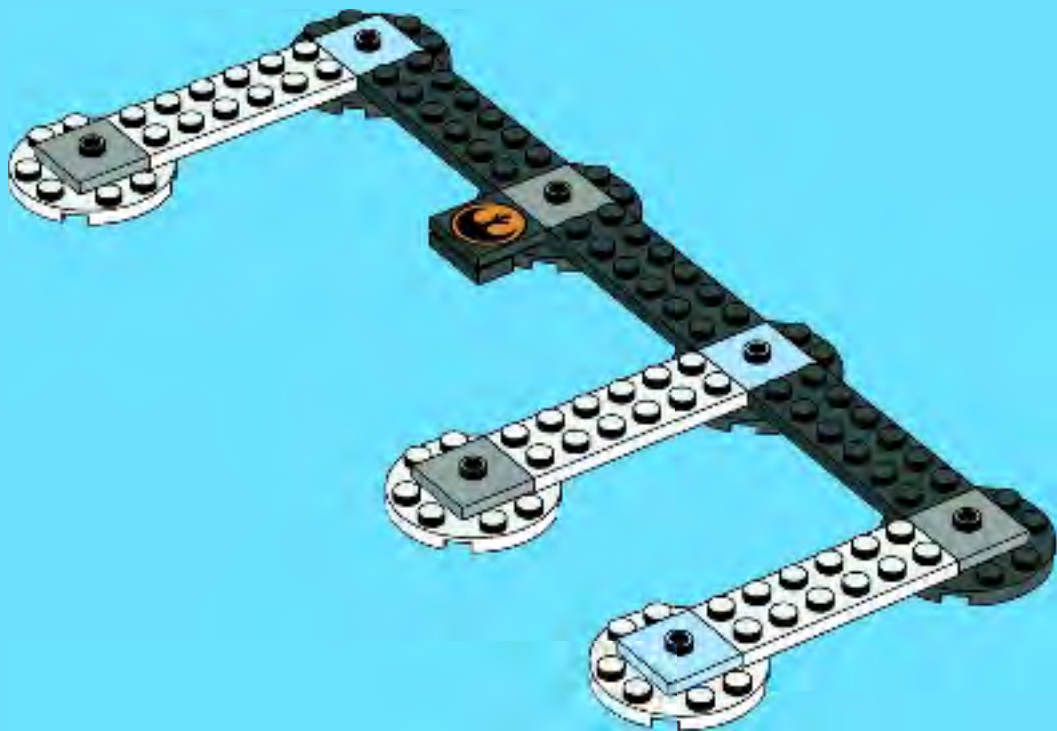

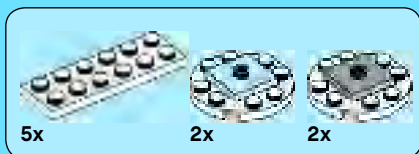

3

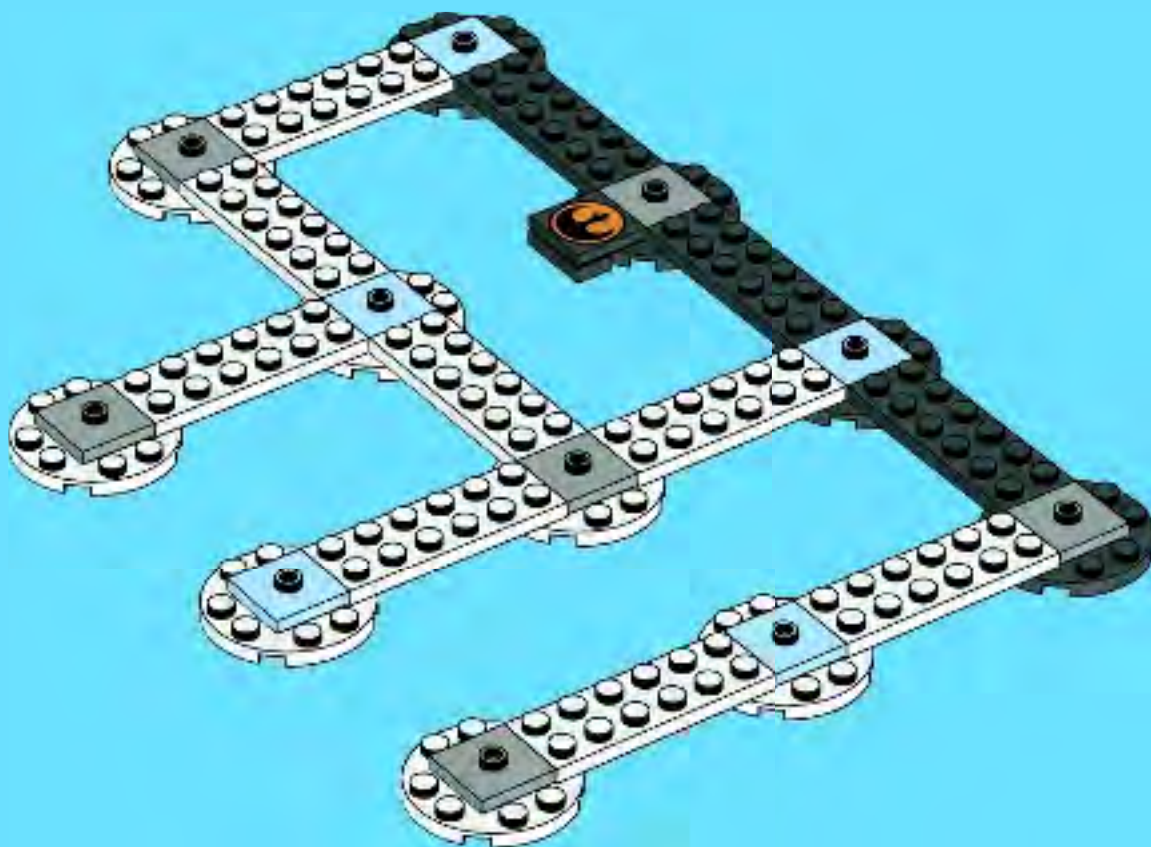



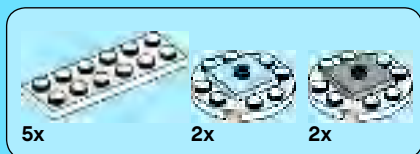

4

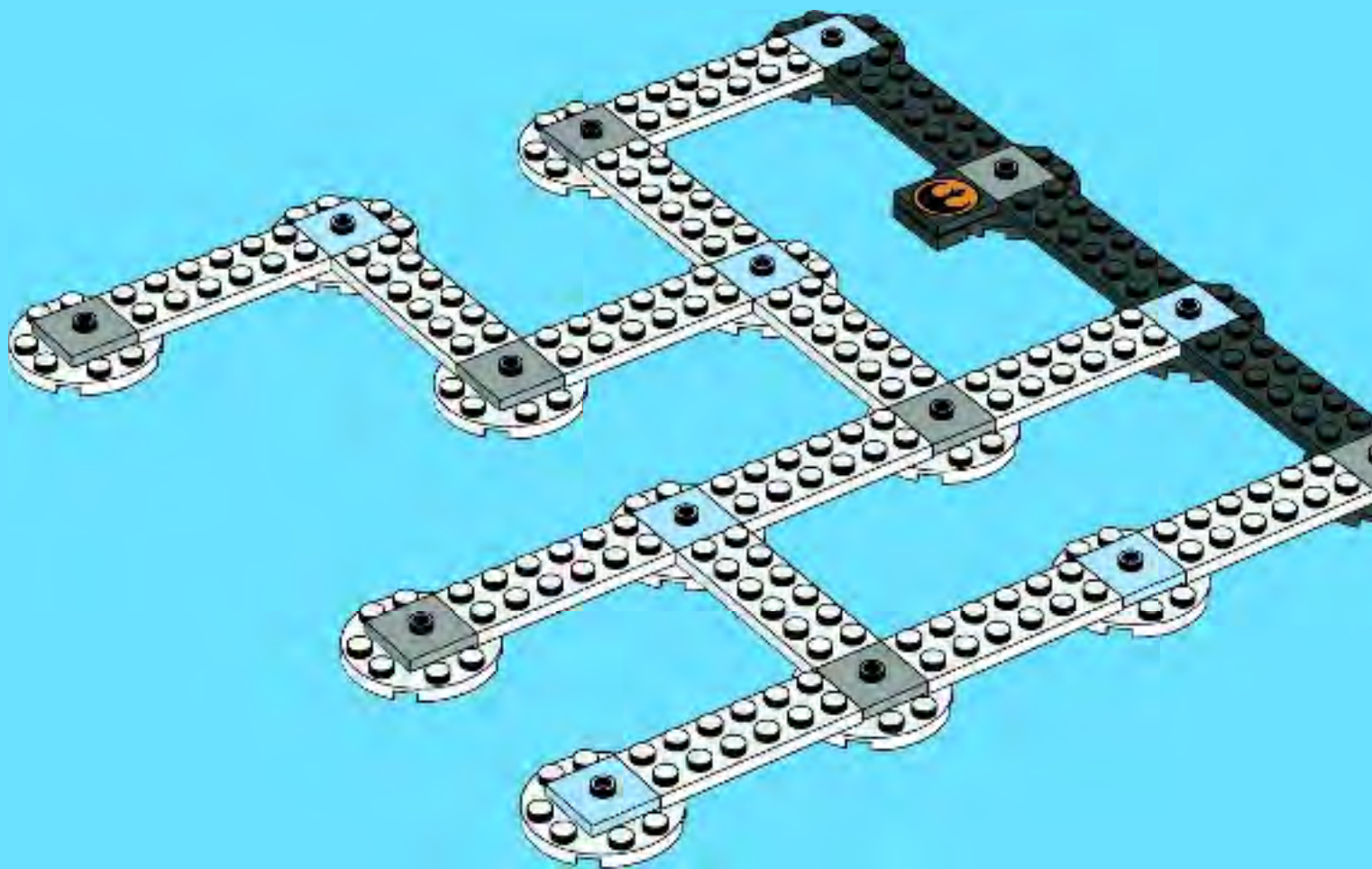

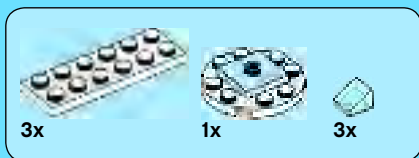

5

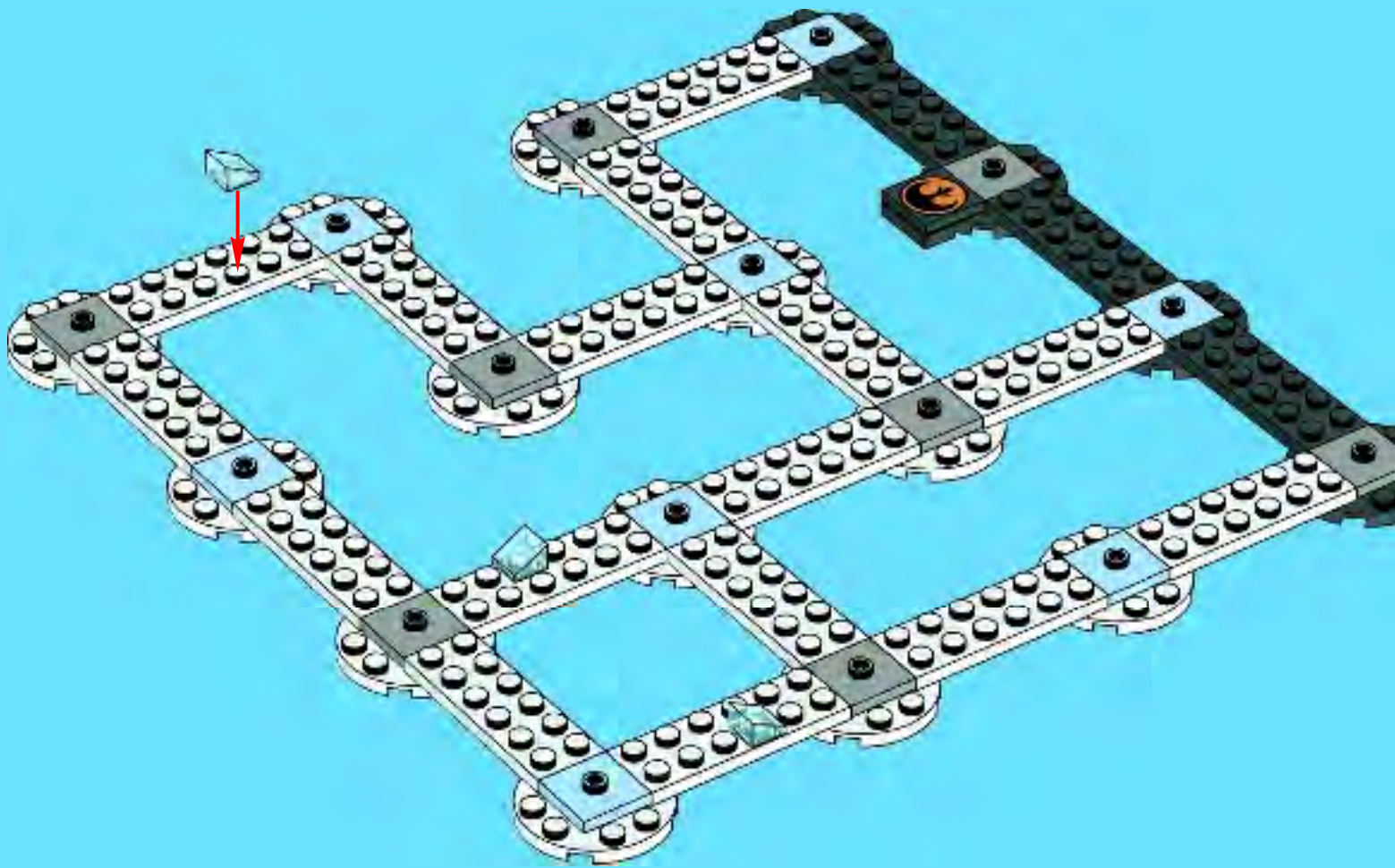

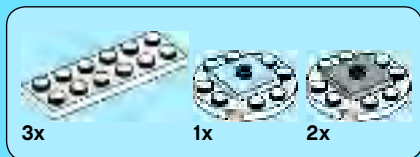

6

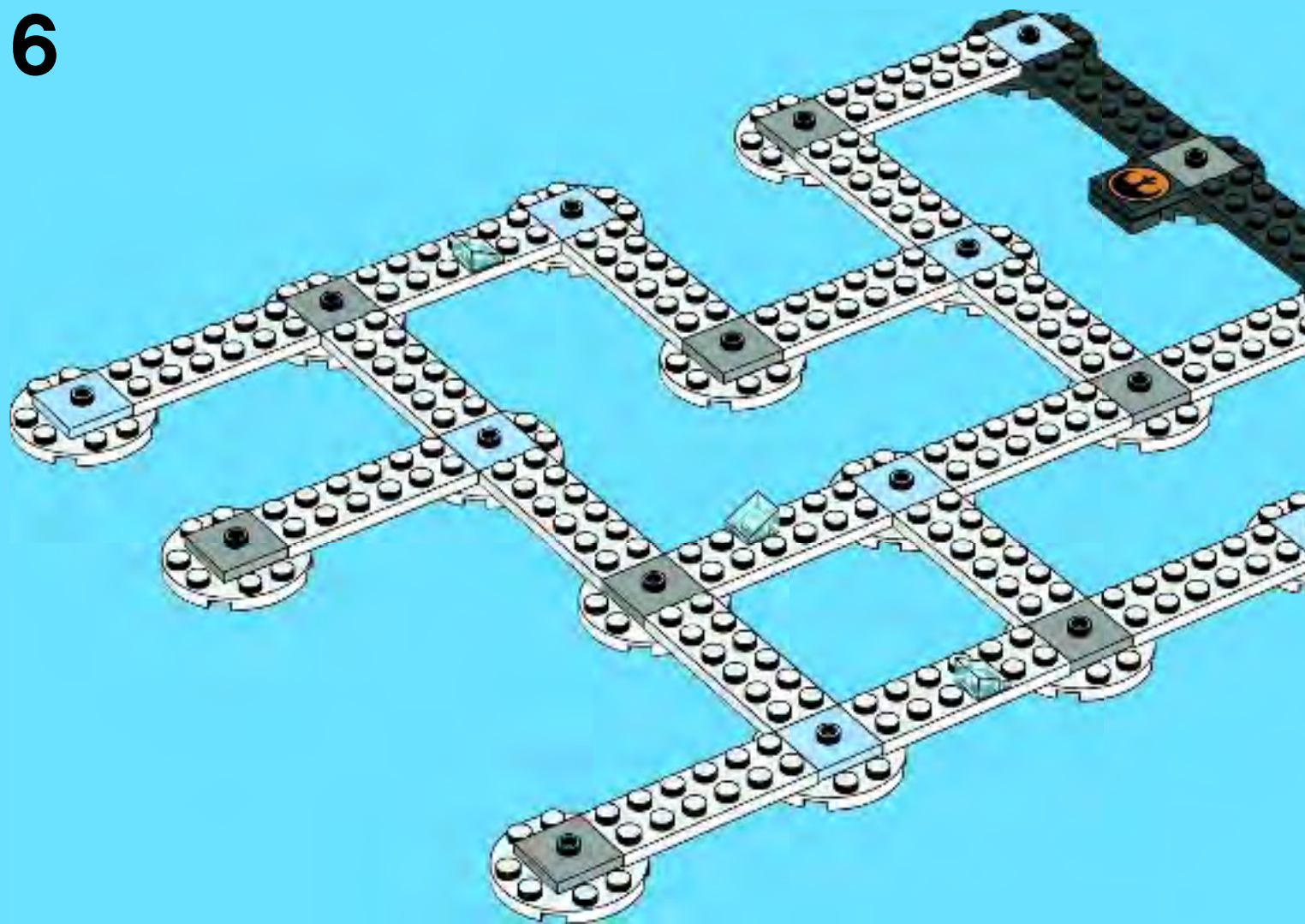



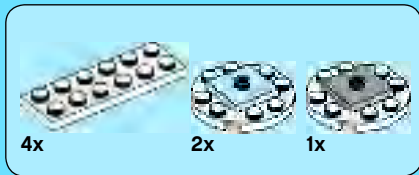

7

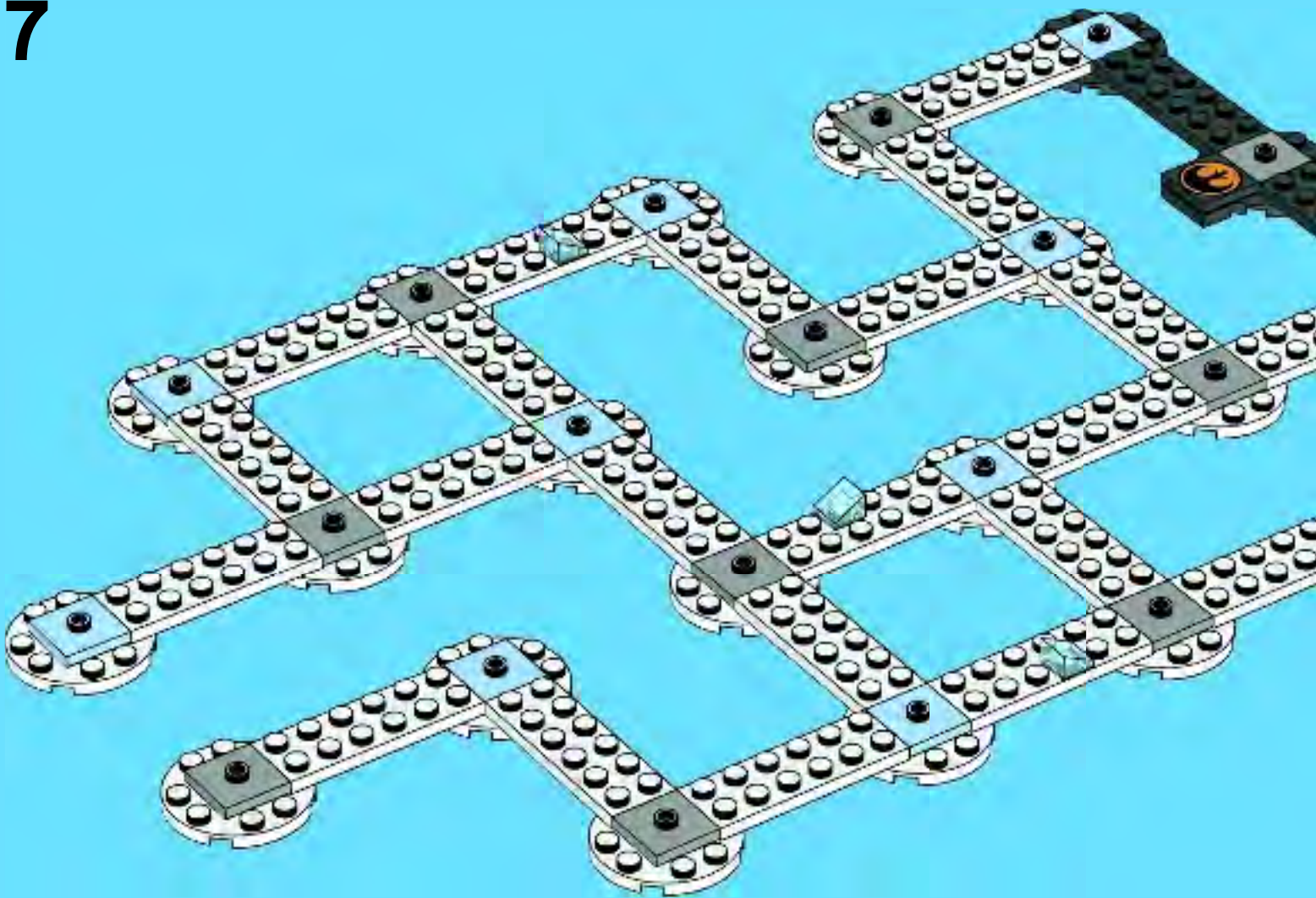



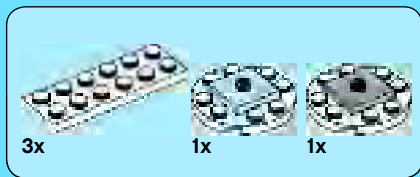

8

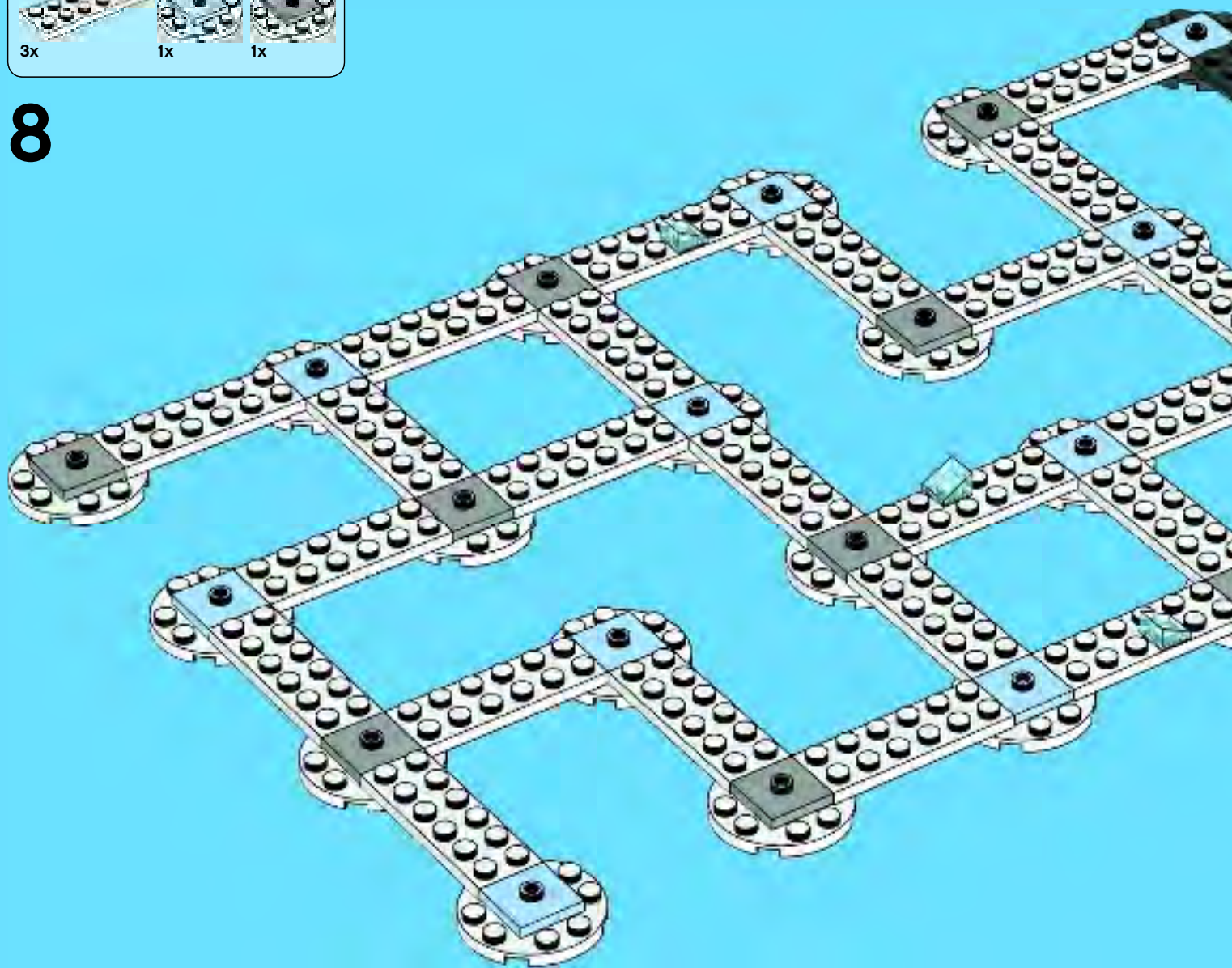

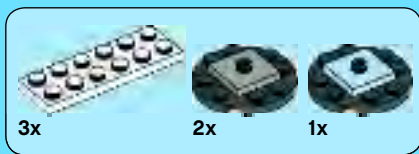

9

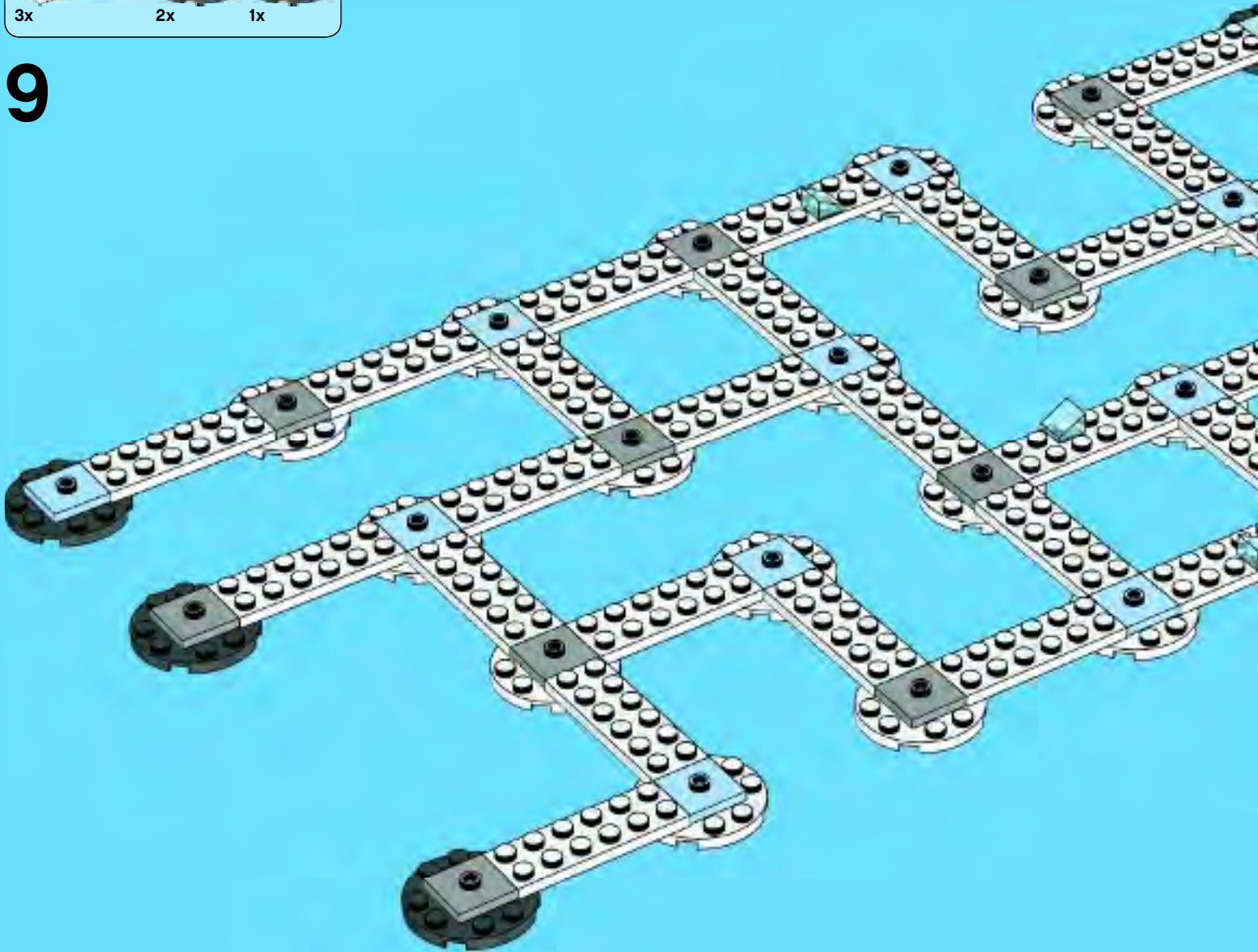







1

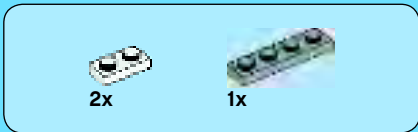
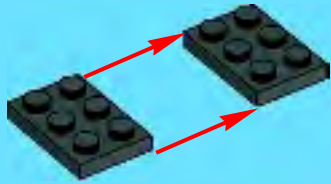

2

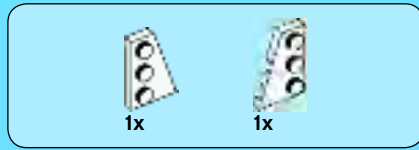

3



4







2x



2x

# 5



1x



2x



1x

# 6



1x

# 7

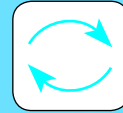

2x



1x

# 8

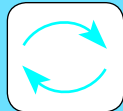

# 2x



1x



1x

1



1x

2



2x

3

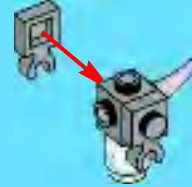

1x



1x

4

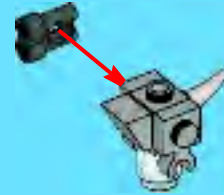



1x



1x

5

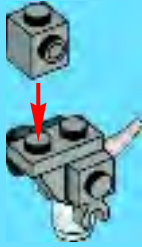

2x

6

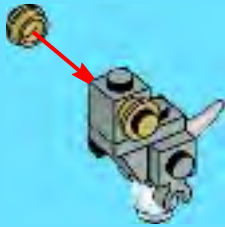

1x



1x

7

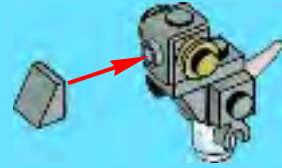

1x

8



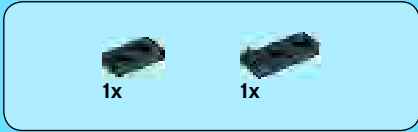
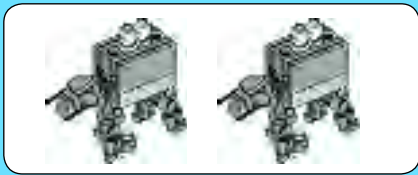

1

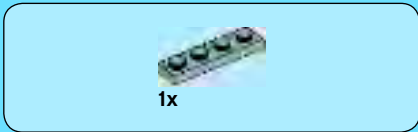
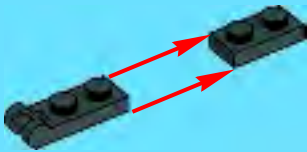

2

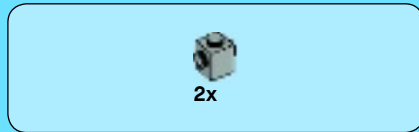

3

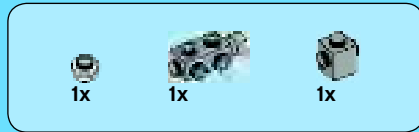
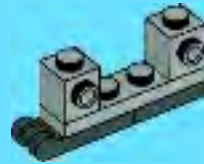

4

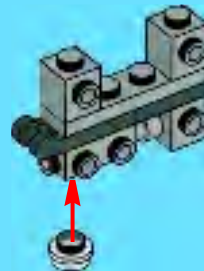





5

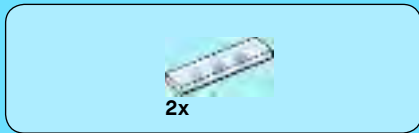
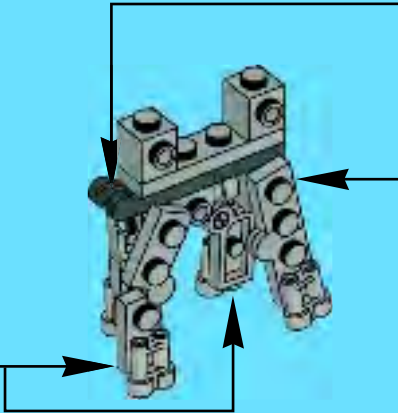
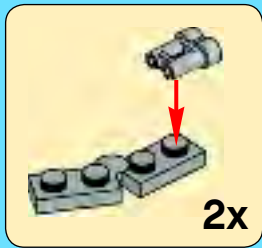
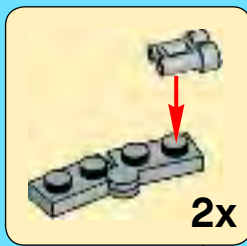

6

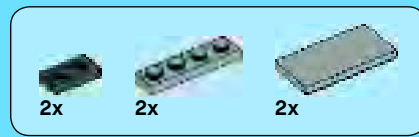
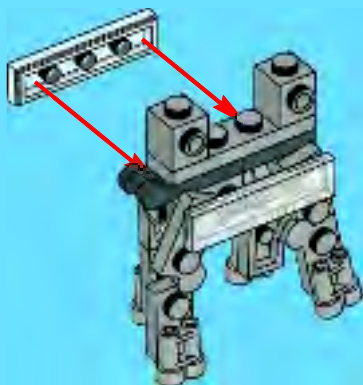

7

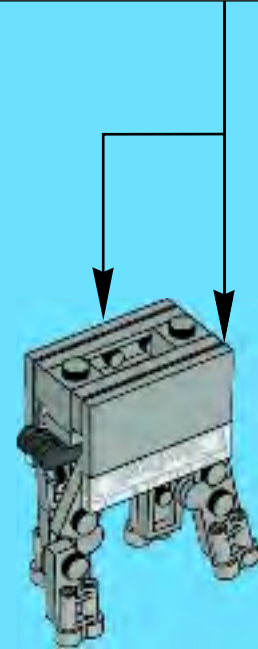
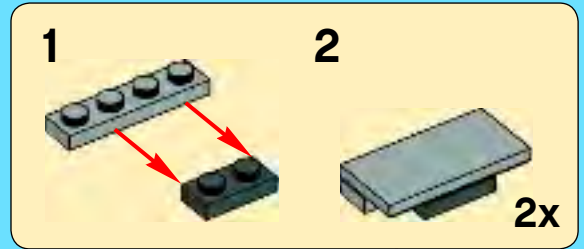



8

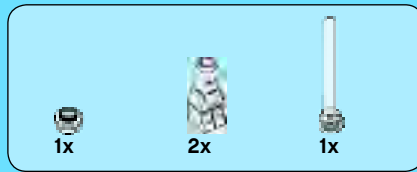
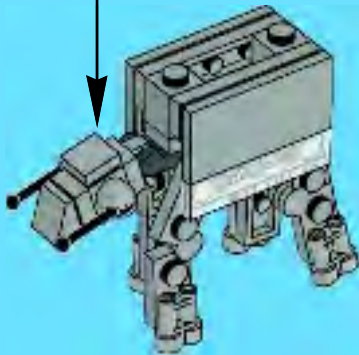
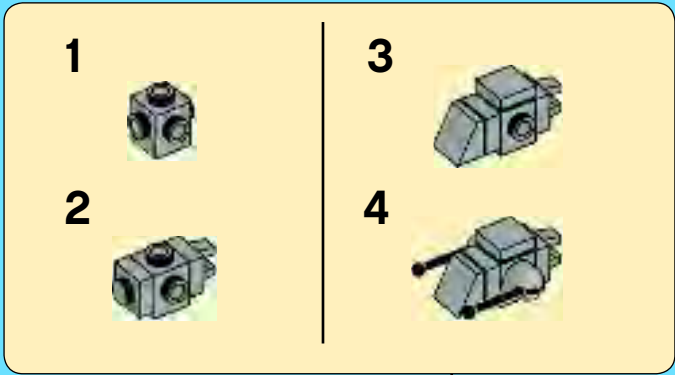

9

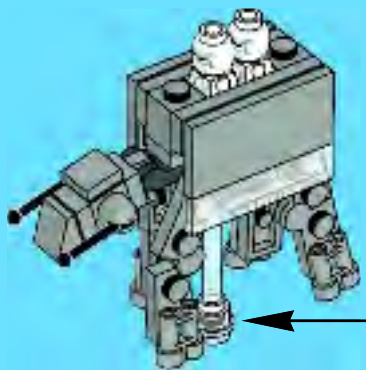
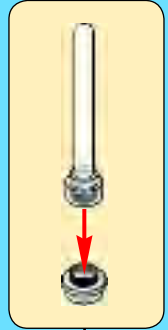

2x

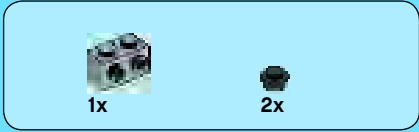

1

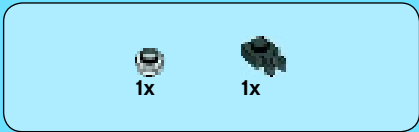

2

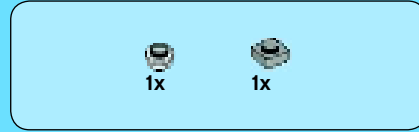

3

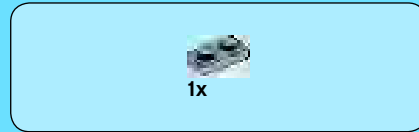

4





1x



1x

5

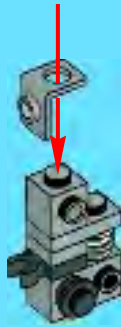

1x



2x



1x

6

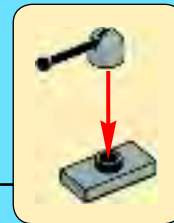
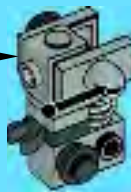
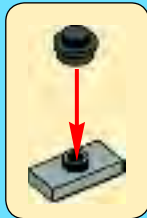





2x



1x

# 7



2x



2x



2x



1x

# 8

1



2



1



2





1

1



2

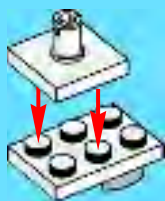

3



4



5



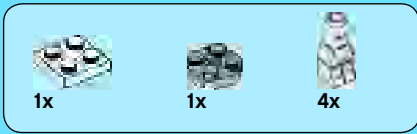

1

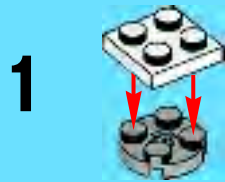

2

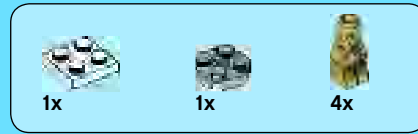

1

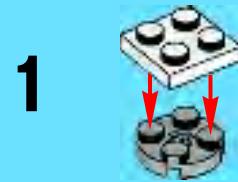

2



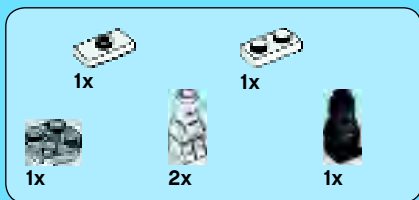

**1**

**1**



**2**



**3**

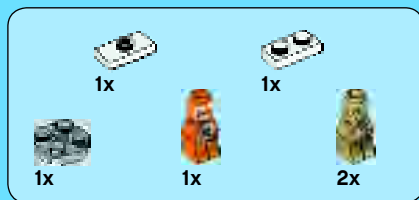

**1**

**1**



**2**



**3**



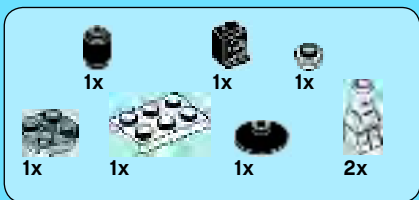

**1**

**1**



**2**



**3**



**4**

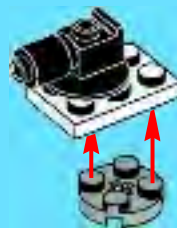

**5**





11

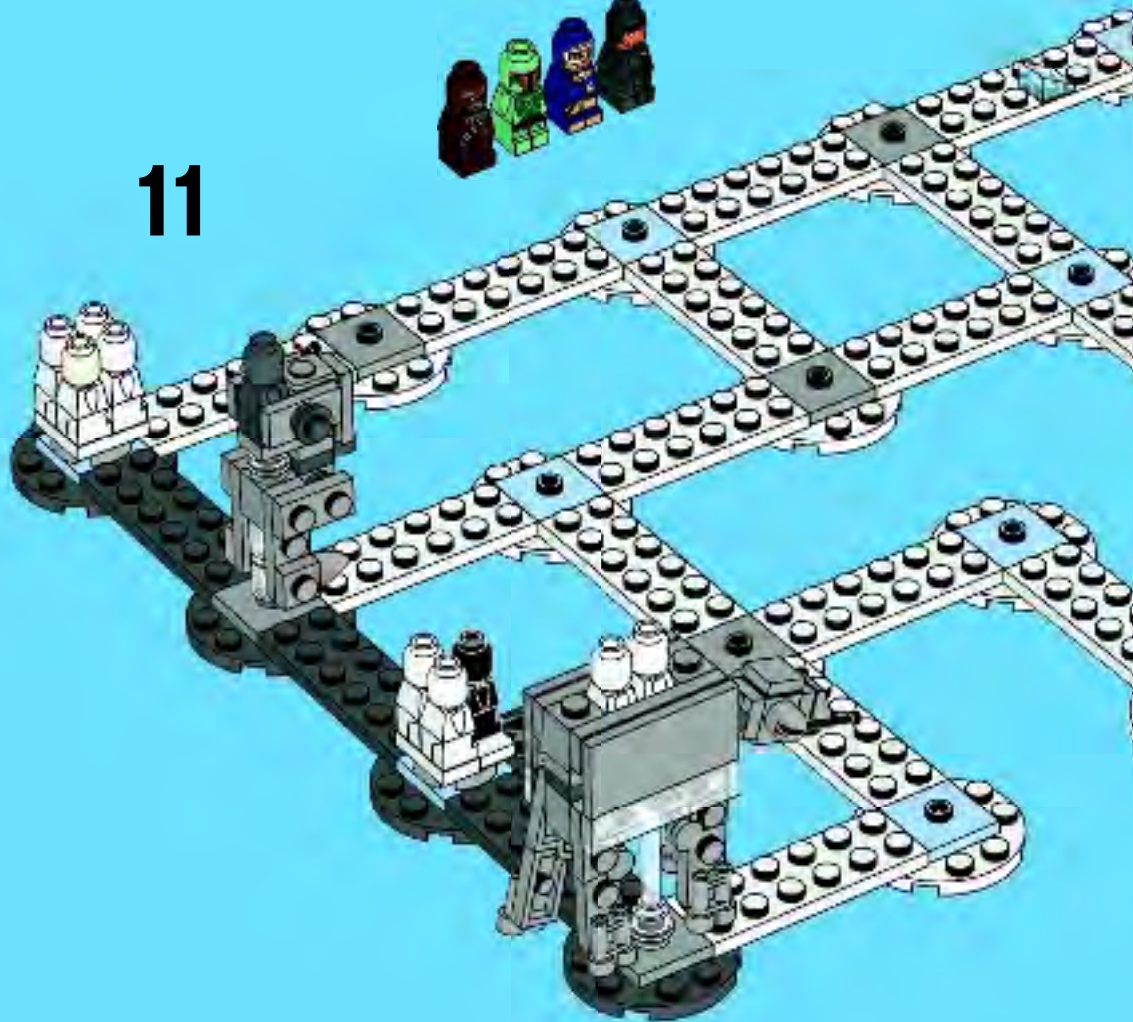
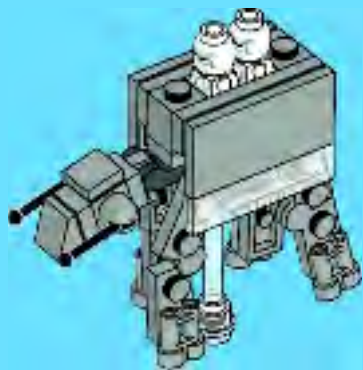

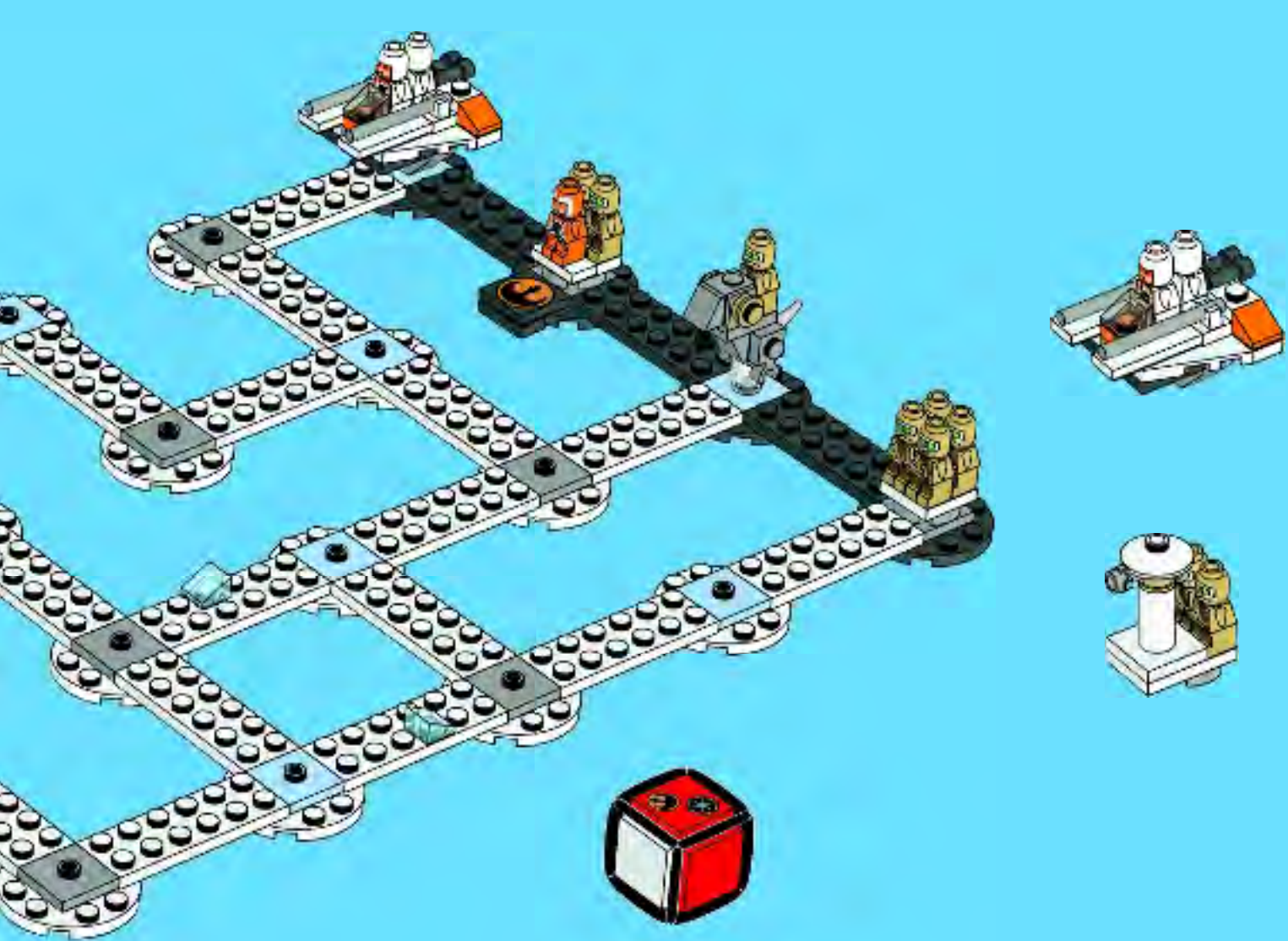

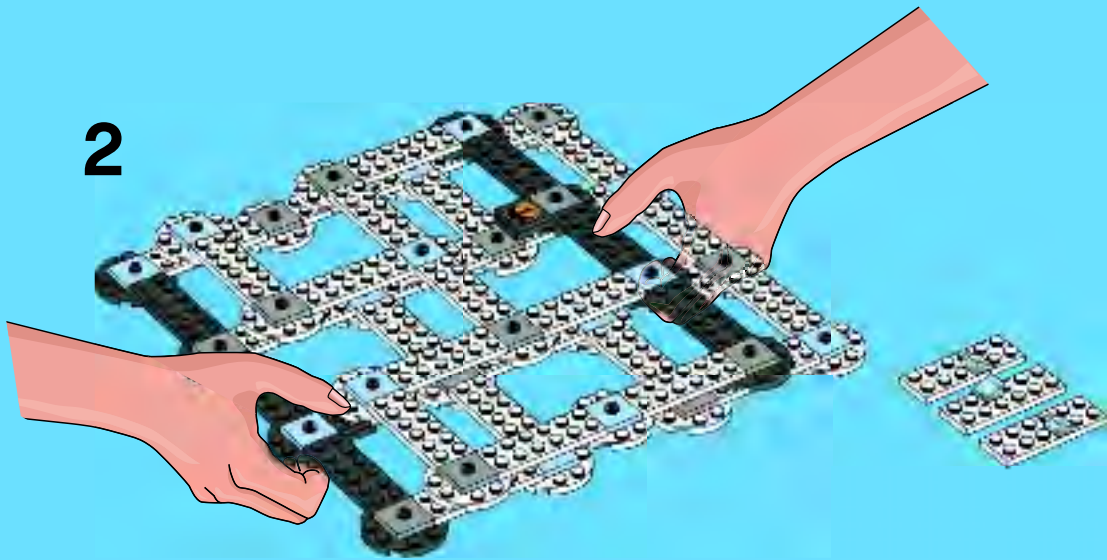
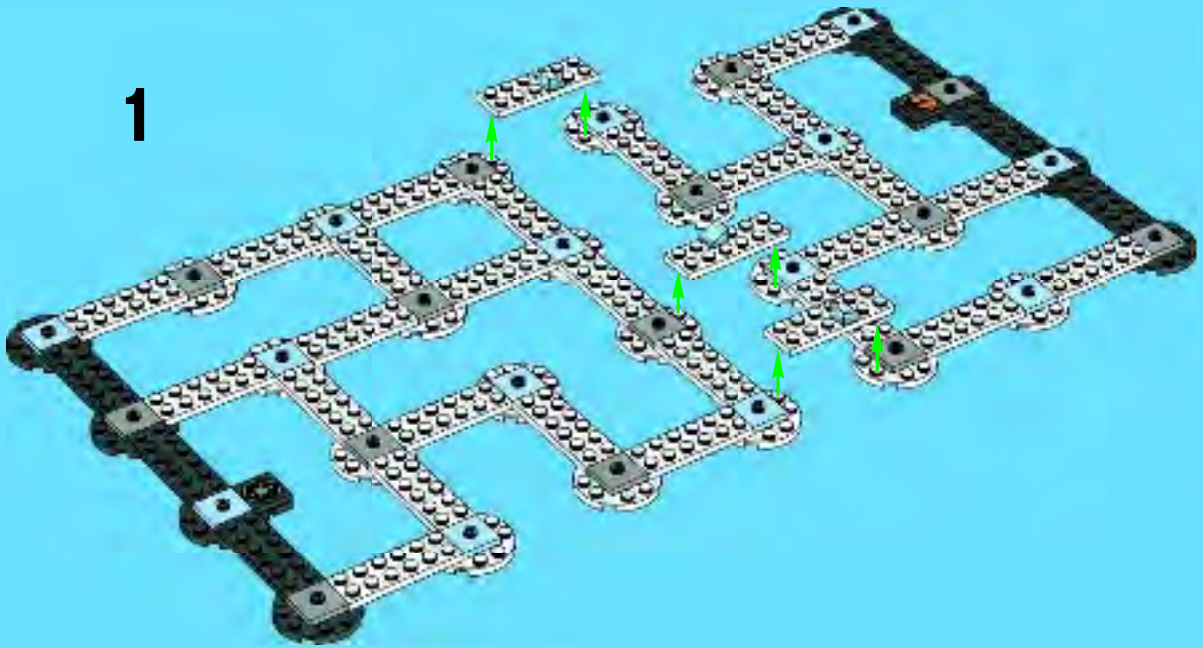



6x 302301	12x 4656053	4x 4657537	1x 4657459	8x 4219256	2x 4521187
2x 302201	4x 4668411	7x 3005740	4x 4521921	6x 4211475	1x 4659037
2x 362301	1x 4526981	2x 4656652	2x 4251563	5x 4221775	1x 4659038
2x 302101	3x 4161734	4x 4504371	3x 4211399	4x 4211628	3x 4210633
29x 379501	9x 4656057	2x 4524929	4x 4211398	8x 4550170	8x 4528323
4x 255501	2x 306821	1x 4655938	14x 4565393	1x 4640844	1x 4656048
2x 379401	2x 4656118	2x 4244368	2x 4211429	2x 4211760	3x 4211051
2x 306801	1x 4599453	1x 4655940	8x 4211445	8x 4211063	14x 4565385
1x 246001	1x 407026	3x 4611464	2x 4211369	2x 4211133	1x 4612901
4x 4558168	1x 306226	1x 4656049	2x 4211415	4x 4211043	2x 4625146
2x 4179874	1x 474026	1x 4655924	2x 4594238	6x 4211002	1x 4668410
2x 4179875	1x 4655937	3x 4211511	1x 4211414	1x 4587212	
1x 474001	1x 4539364	8x 4213567	2x 4211451		
20x 4515347	3x 3006840	2x 4211502	4x 4560183		

**Customer Service**  
**Kundenservice**  
**Service Consommateurs**  
**Servicio Al Consumidor**

[www.lego.com/service](http://www.lego.com/service) or dial



: 00800 5346 5555

: 1-800-422-5346

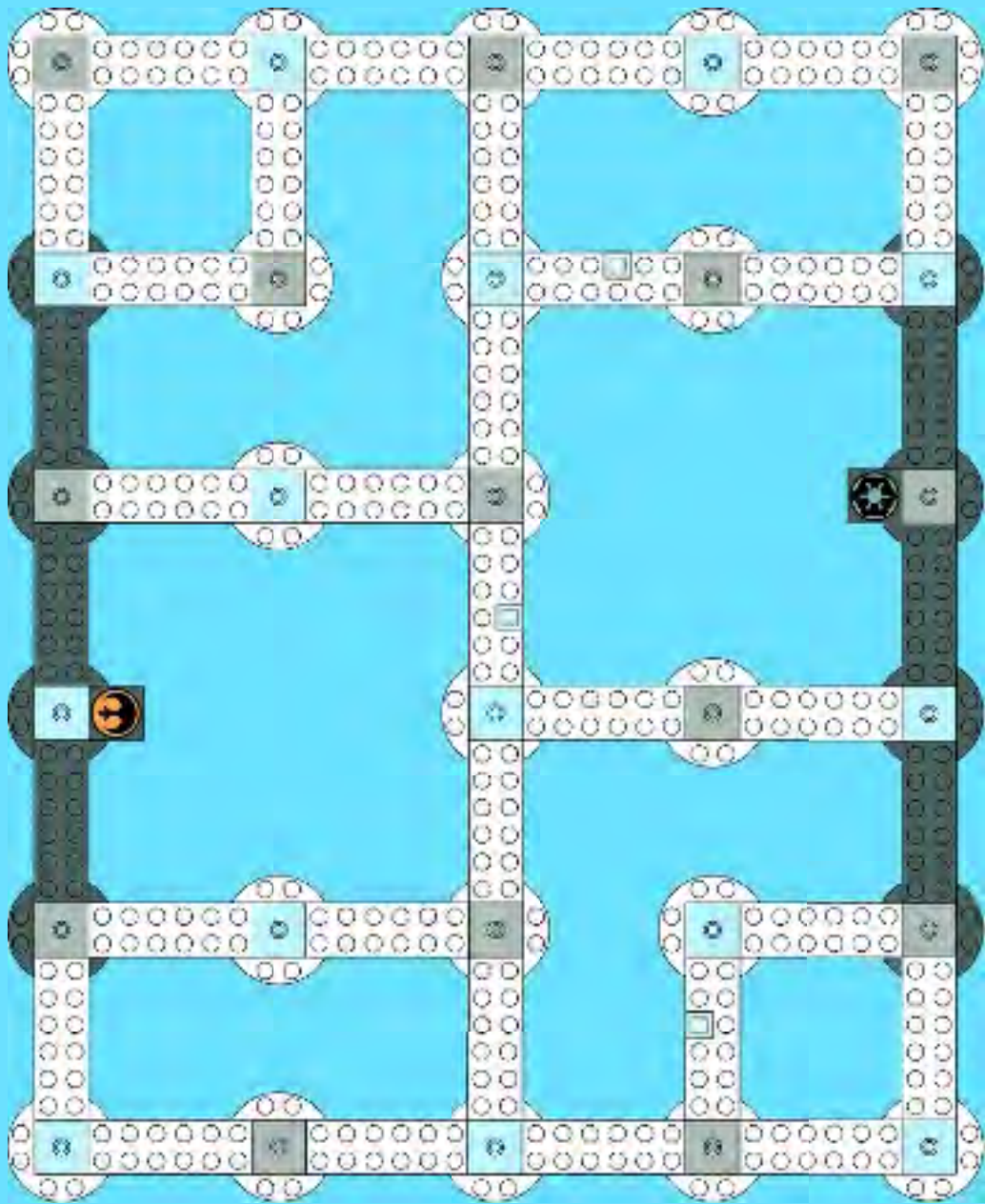



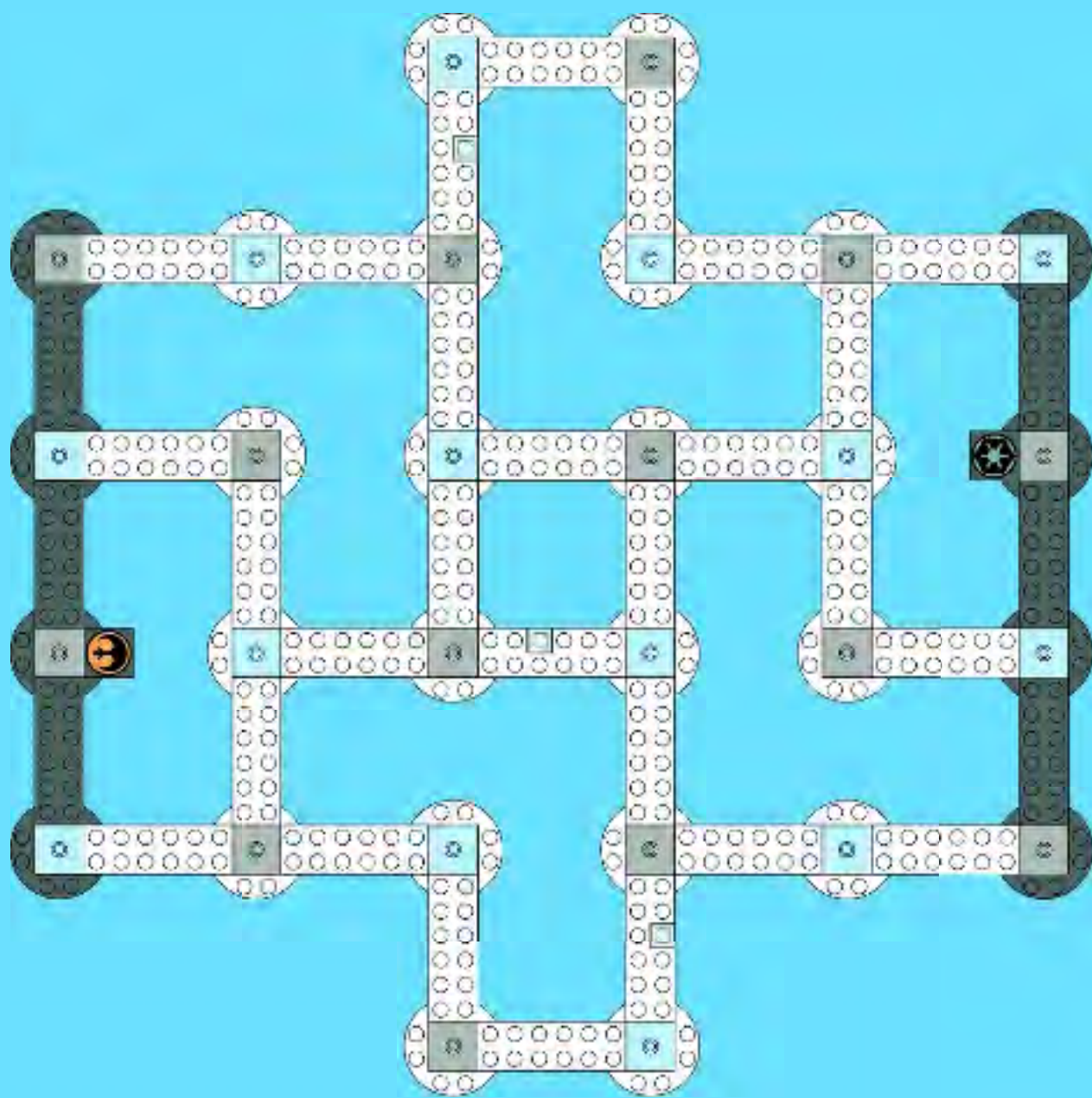

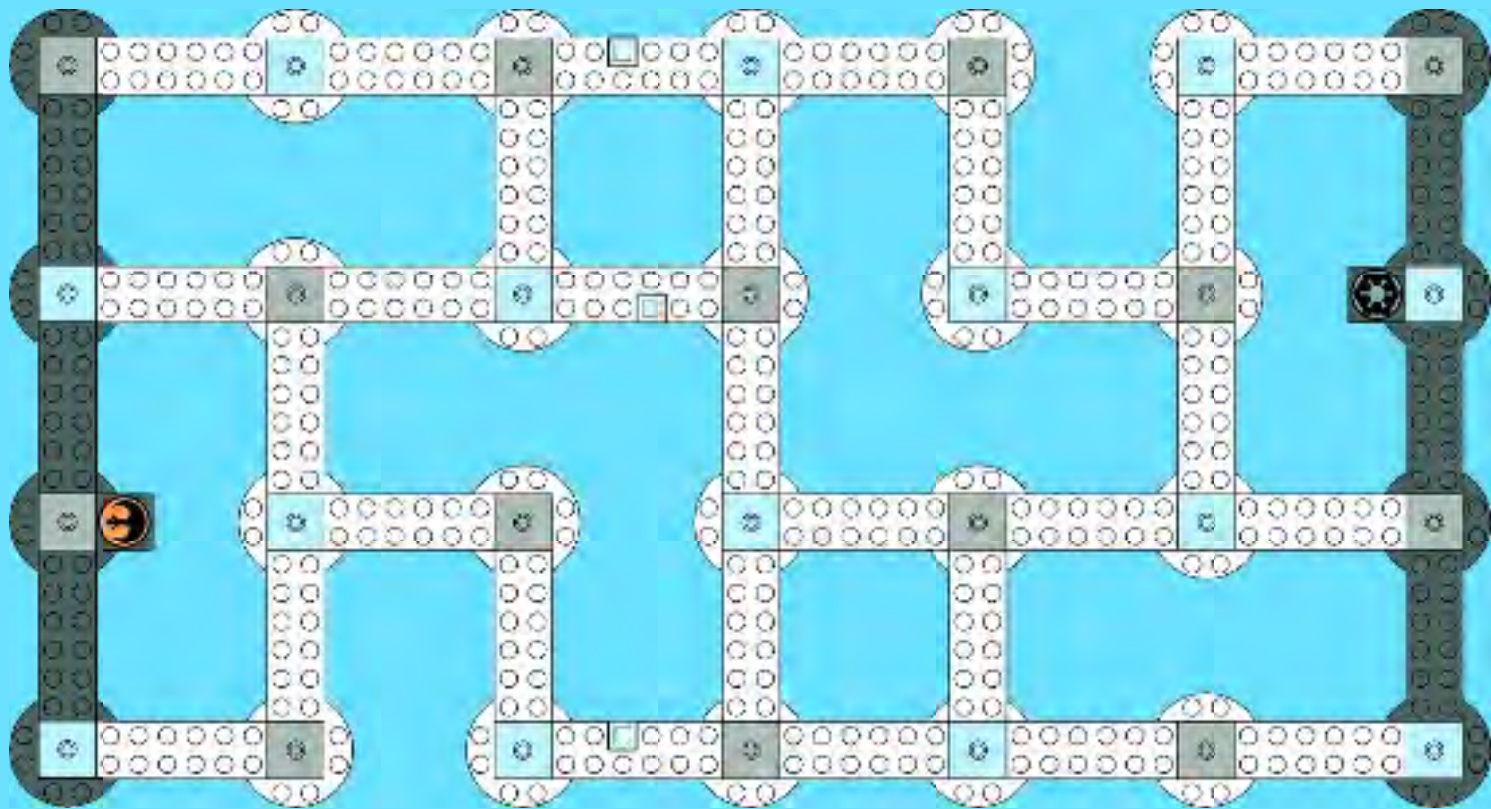



# HEROICA™



3858

3860

3859

3857



GAMES



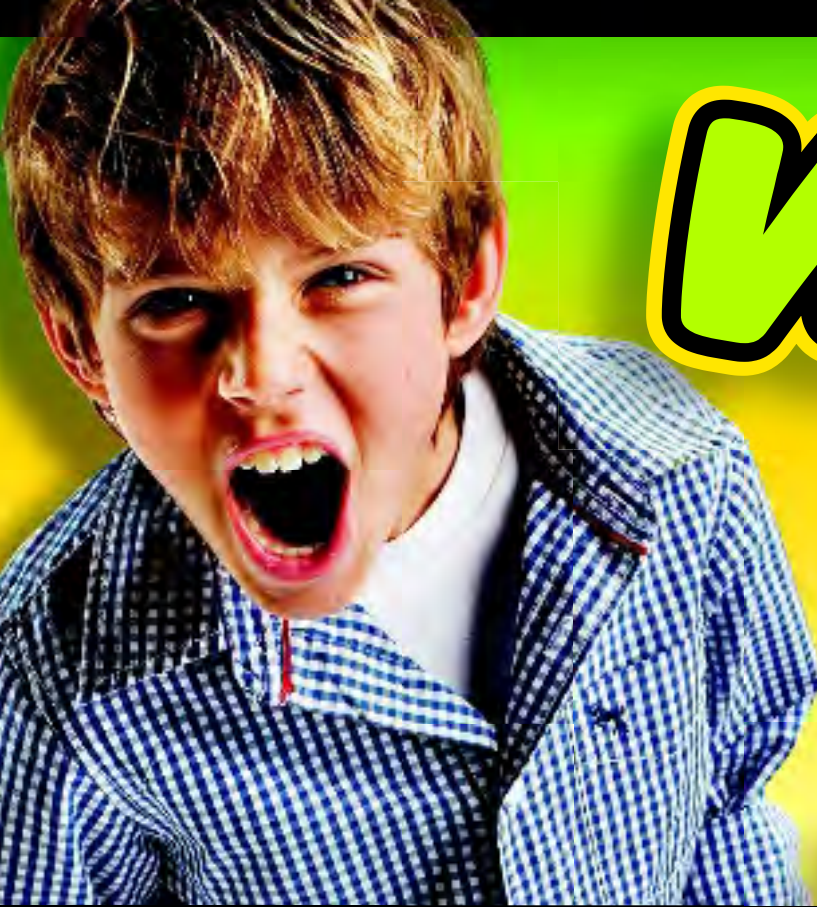

# WIN!

Go to [www.LEGOsurvey.com/product](http://www.LEGOsurvey.com/product) to fill out a survey for a chance to win a cool LEGO® Product.

No purchase necessary.

Open to all residents where not prohibited.



[www.LEGO.com](http://www.LEGO.com)



## [www.LEGOsurvey.com/product](http://www.LEGOsurvey.com/product)

### GEWINNE! WIN!

Nimm an der Umfrage auf [www.LEGOsurvey.com/product](http://www.LEGOsurvey.com/product) teil und hab die Chance ein cooles LEGO® Produkt zu gewinnen!

Die Teilnahme am Gewinnspiel führt zu keinerlei Kaufverpflichtungen. Teilnahme in allen nicht ausgeschlossenen Ländern möglich.

Ga naar [www.LEGOsurvey.com/product](http://www.LEGOsurvey.com/product), vul een enquêteformulier in en maak kans op een cool LEGO® product.

Geen aankoopverplichting. Iedereen mag deelnemen, uitgezonderd ingezetenden van landen waar een enquêteverbod geldt.

### GAGNE! 当てよう!

Visite [www.LEGOsurvey.com/product](http://www.LEGOsurvey.com/product) pour répondre à un questionnaire et avoir une chance de gagner un produit LEGO® très cool!

Aucune obligation d'achat. Ouvert à tous les résidents des pays autorisés.

[www.LEGOsurvey.com/product](http://www.LEGOsurvey.com/product) にアクセスして、アンケートにご記入ください。当選者にはレゴ®製品を差し上げます。

お買い上げの必要はありません。

禁止されていない限り、すべての皆様にご利用いただけます。