



# CITY

4207



1

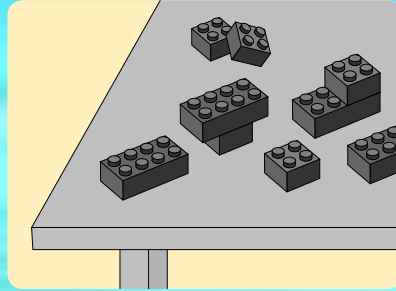
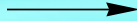
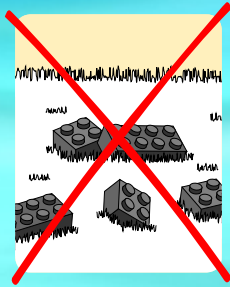

2

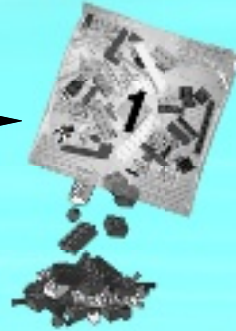
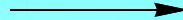

<http://lego.com/brickseparator>





1x

1

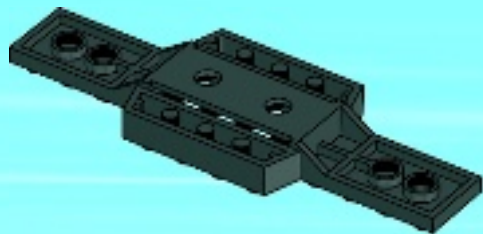

4



2x

2

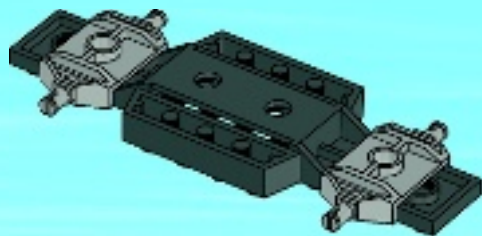



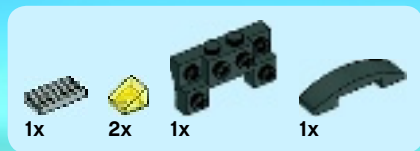

3

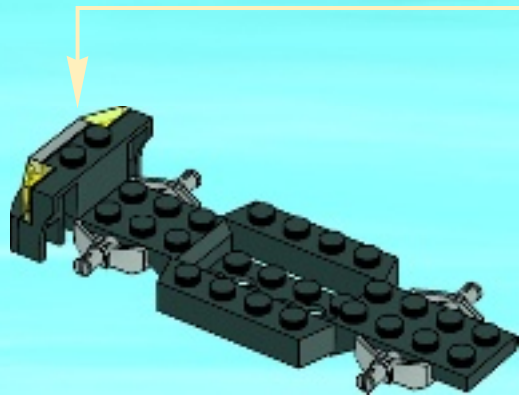
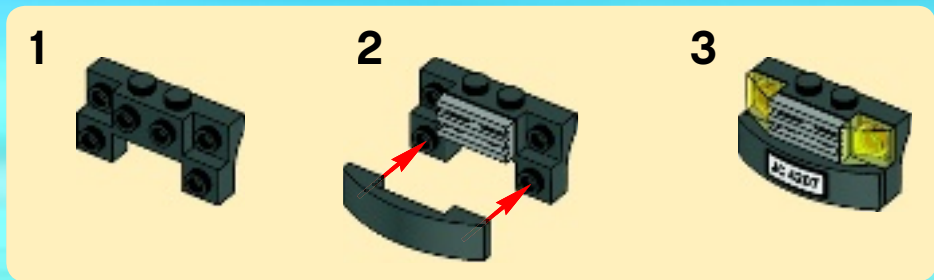



4

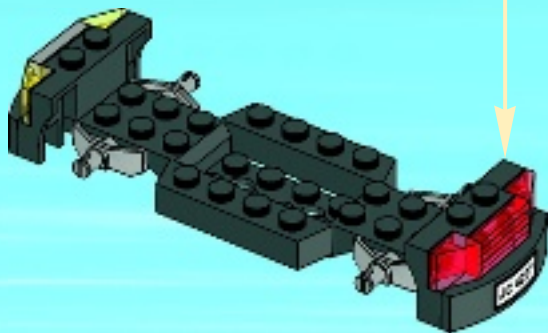
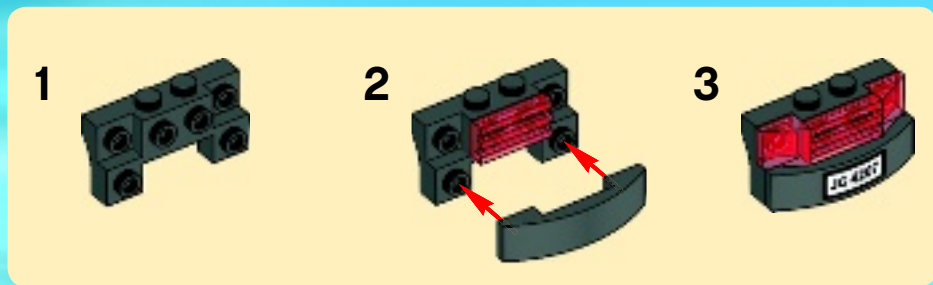



4x

5

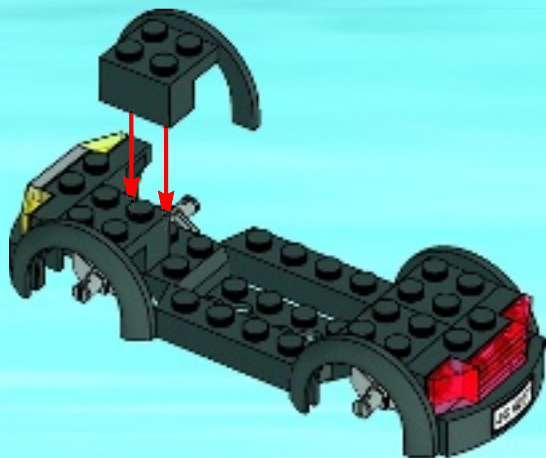

1x



1x

6





2x

7

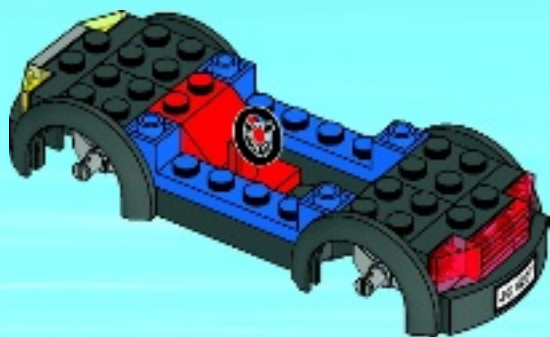

8

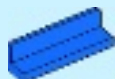

2x

8

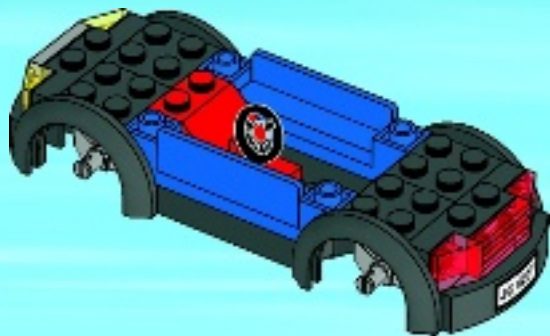

1x



1x

9

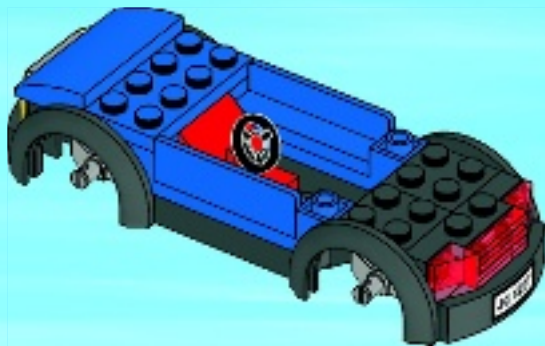



2x



1x

# 10

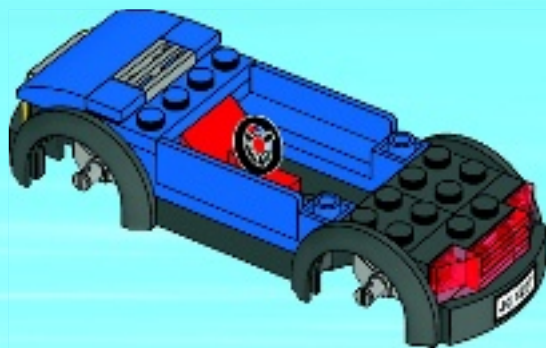





1x



2x

# 11



1x

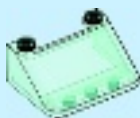

1x

# 12

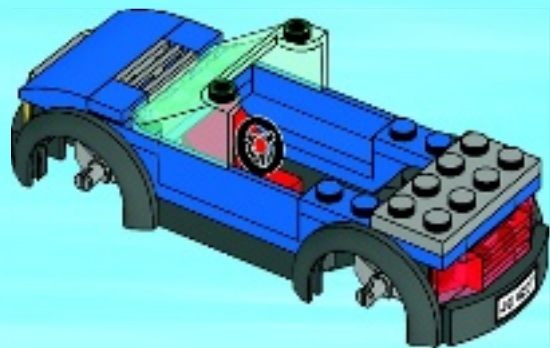



2x



1x

# 13

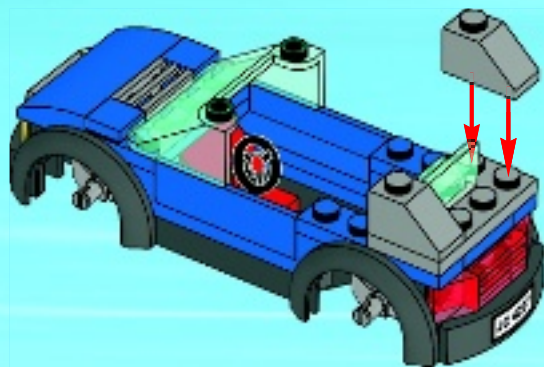

4x



4x



1x

# 14



4x



15

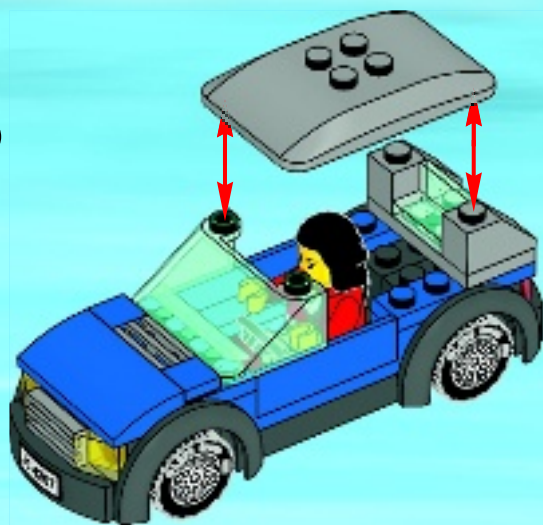



1x

1

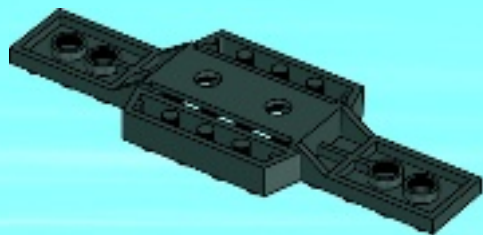



2x

2

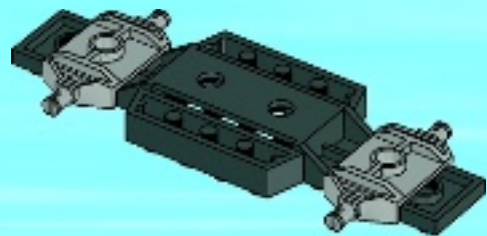

1x



1x

3

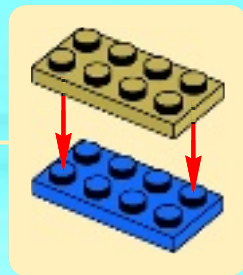



1x

4





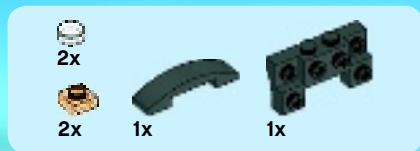

5

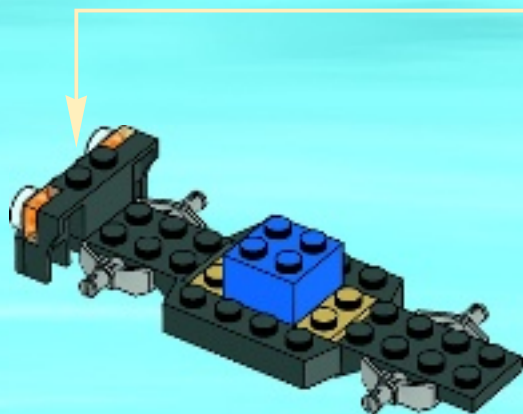
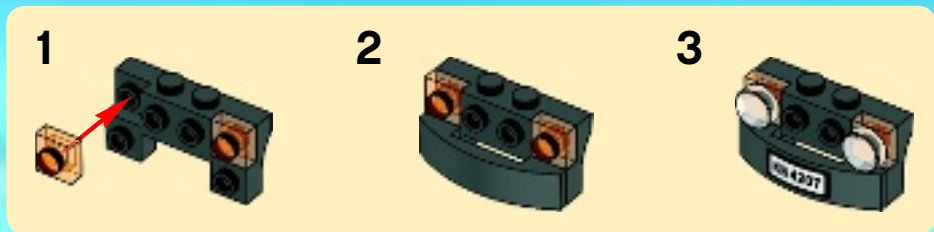

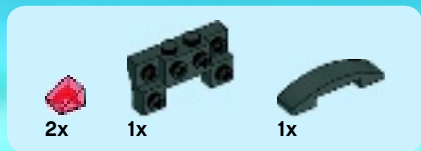

6

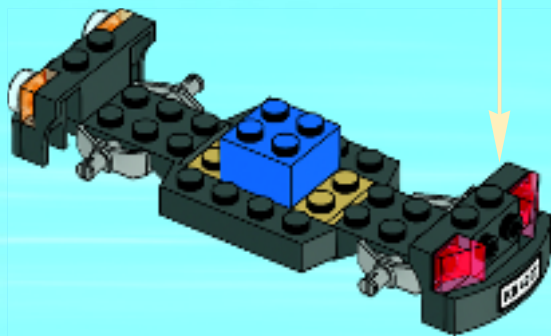



4x

7

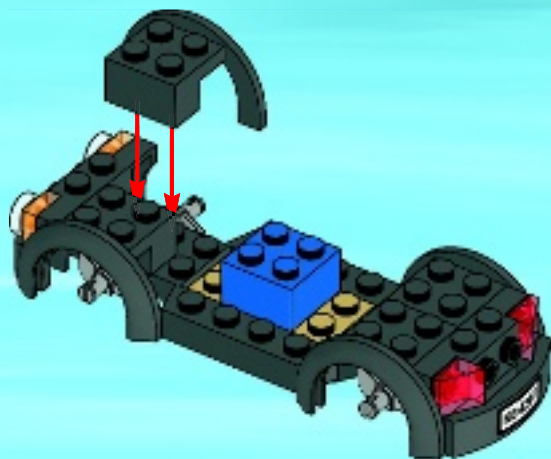

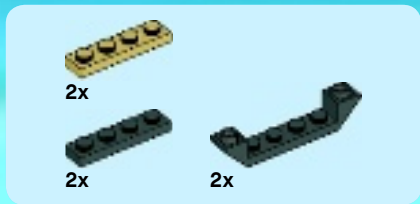

8

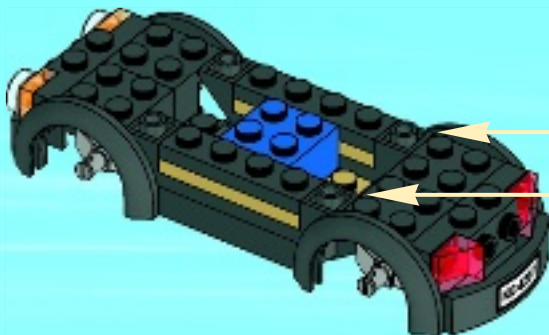
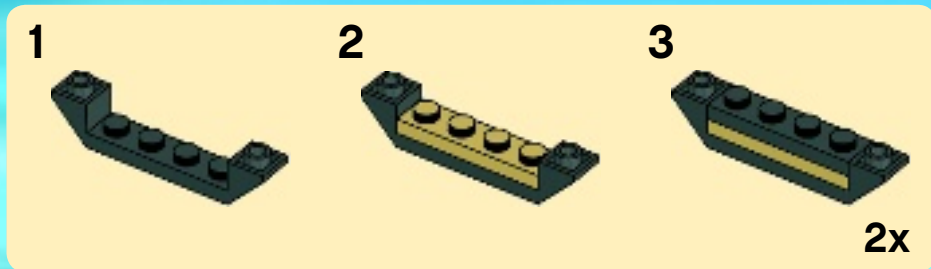

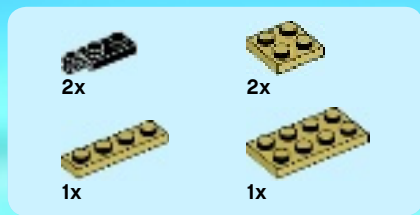

9

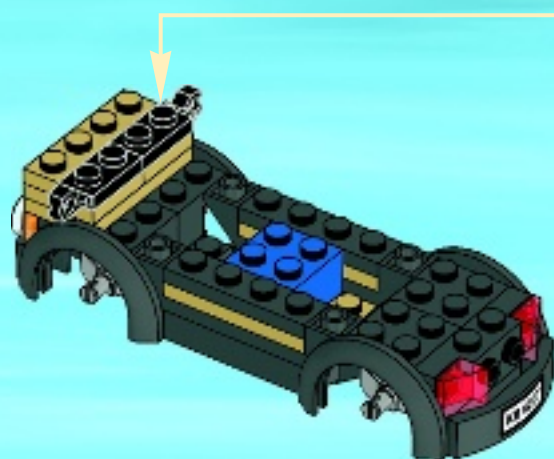
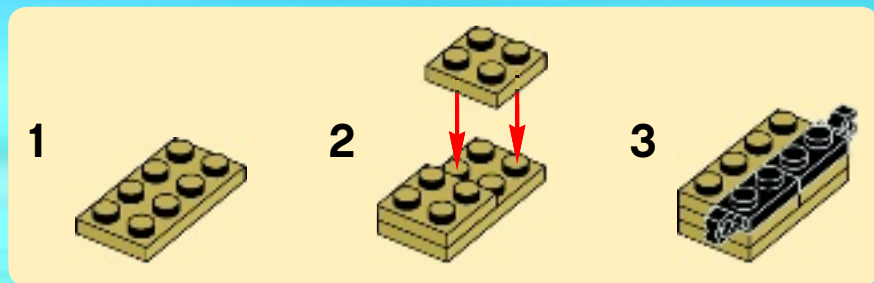



8x

10

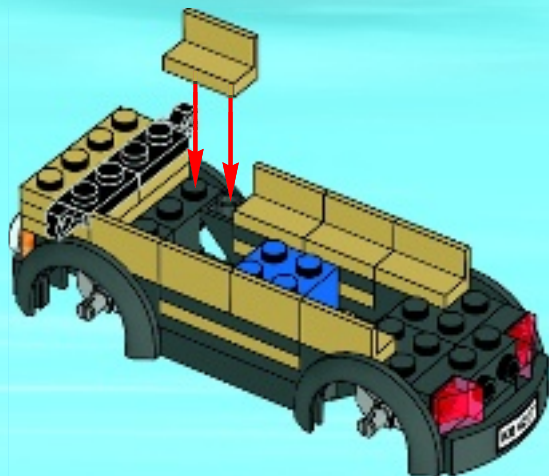





1x

11

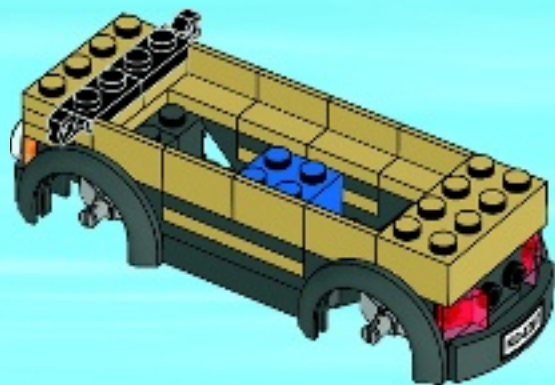

1x



1x

12

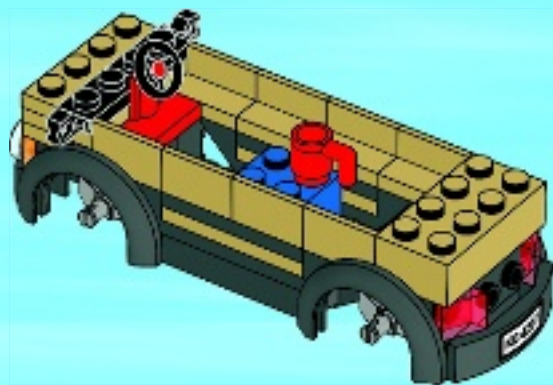



1x

# 13

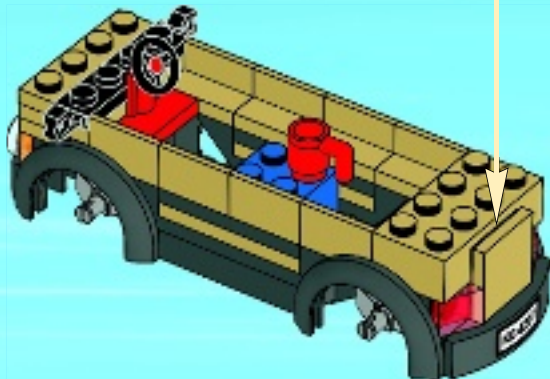



1x



1x

# 14

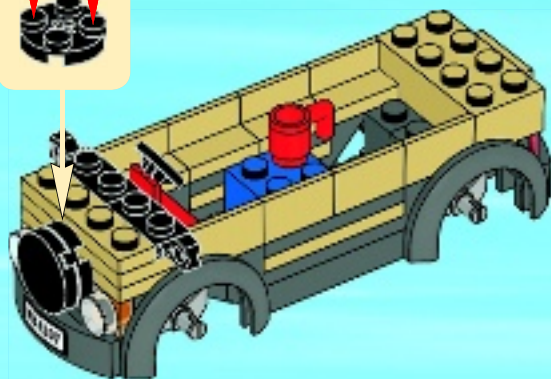
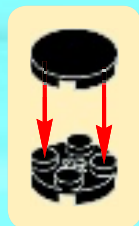

2x

# 15

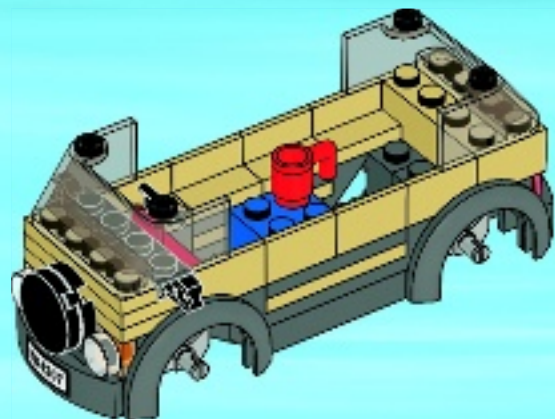



2x

1

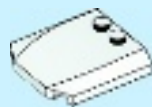
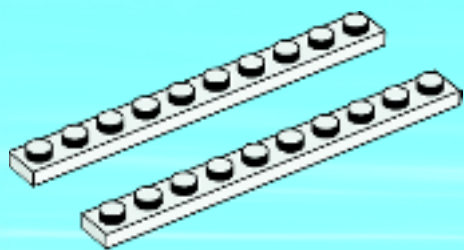

1x

2

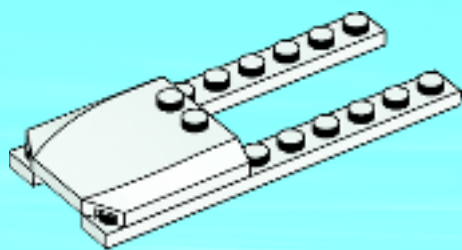



1x



1x

3

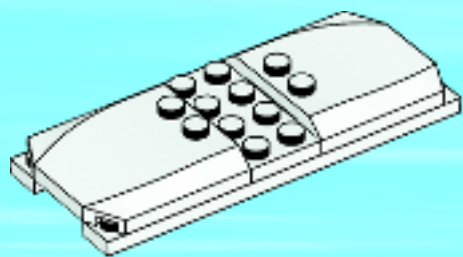

1x

4

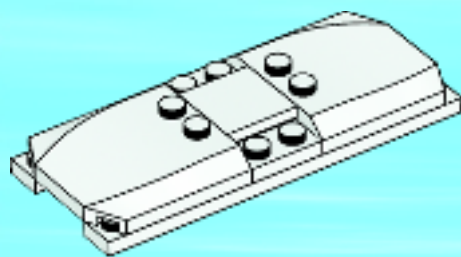



1x



1x

5

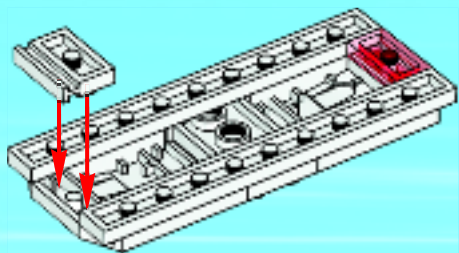

16

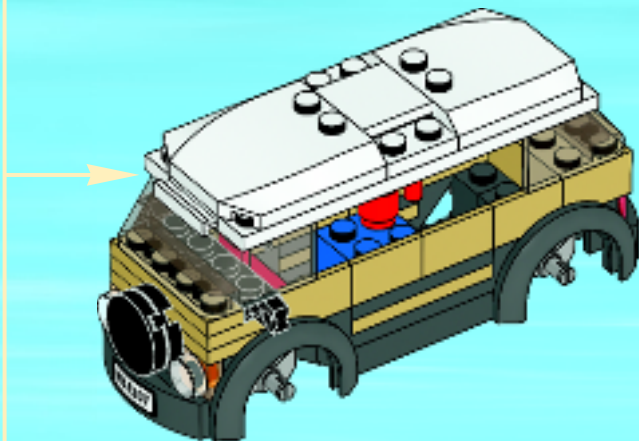





4x



4x

# 17

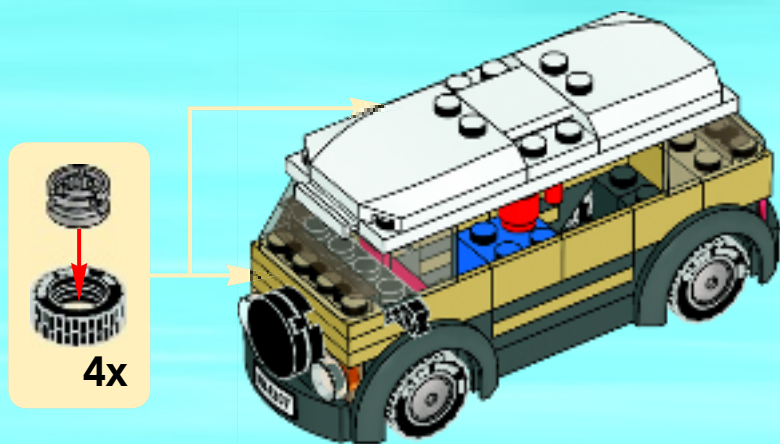

18

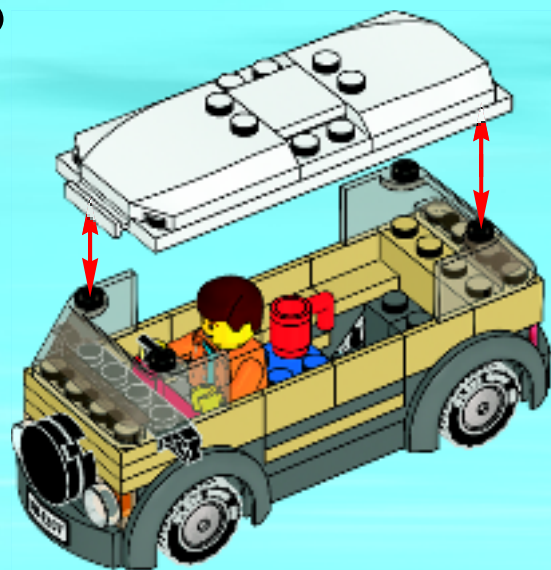



3



[www.LEGOclub.com/Max](http://www.LEGOclub.com/Max)

**LEGO club**™

**FREE\*! GRATIS! GRATUIT!**

\*Paid subscription in Australia and New Zealand.  
\*Abonnement payant en Australie et Nouvelle-Zélande.

©2012 The LEGO Group.



# WIN!

Go to [www.LEGOsurvey.com/product](http://www.LEGOsurvey.com/product) to fill out a survey for a chance to win a cool LEGO® Product.

No purchase necessary.

Open to all residents where not prohibited.



## [www.LEGOsurvey.com/product](http://www.LEGOsurvey.com/product)

### GEWINNE!

Nimm an der Umfrage auf [www.LEGOsurvey.com/product](http://www.LEGOsurvey.com/product) teil und hab die Chance ein cooles LEGO® Produkt zu gewinnen!

Die Teilnahme am Gewinnspiel führt zu keinerlei Kaufverpflichtungen. Teilnahme in allen nicht ausgeschlossenen Ländern möglich.

### WIN!

Ga naar [www.LEGOsurvey.com/product](http://www.LEGOsurvey.com/product), vul een enquêteformulier in en maak kans op een cool LEGO® product.

Geen aankoopverplichting. Iedereen mag deelnemen, uitgezonderd ingezetenden van landen waar een enquêteverbod geldt.

### GAGNE!

Visite [www.LEGOsurvey.com/product](http://www.LEGOsurvey.com/product) pour répondre à un questionnaire et avoir une chance de gagner un produit LEGO® très cool!

Aucune obligation d'achat. Ouvert à tous les résidents des pays autorisés.

### 当てよう!

[www.LEGOsurvey.com/product](http://www.LEGOsurvey.com/product) にアクセスして、アンケートにご記入ください。当選者にはレゴ®製品を差し上げます。

お買い上げの必要はありません。禁止されていない限り、すべての皆様にご利用いただけます。



[www.LEGO.com](http://www.LEGO.com)

6029691

LEGO and the LEGO logo are trademarks of the LEGO Group. ©2012 The LEGO Group.



# CITY

4207









1x

1

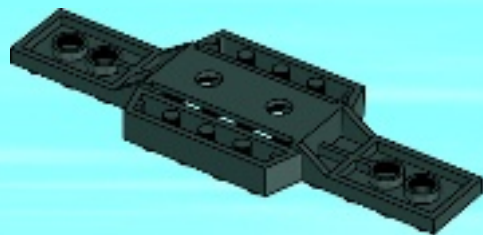

2x

2

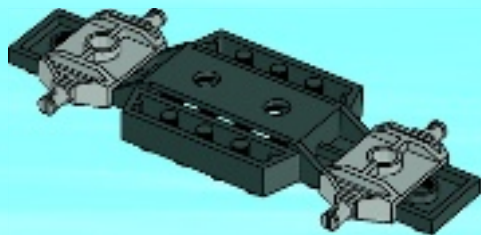

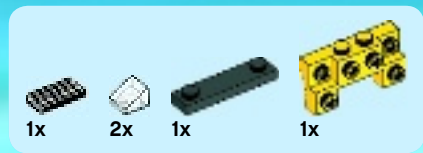

3

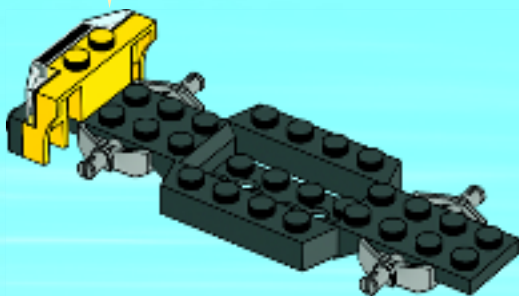





2x



1x



2x



2x



1x



1x



1x

4

1

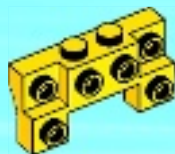

2



3



4

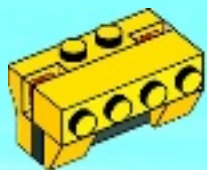

5

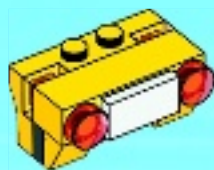

6



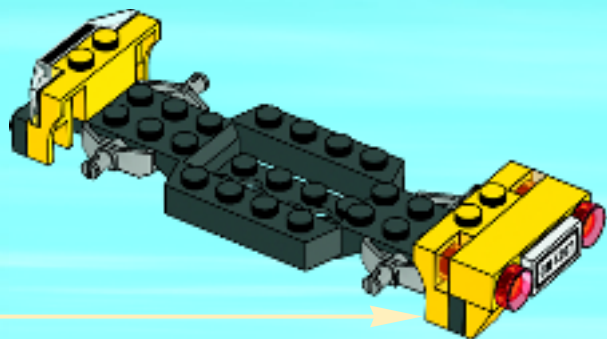

4x

5

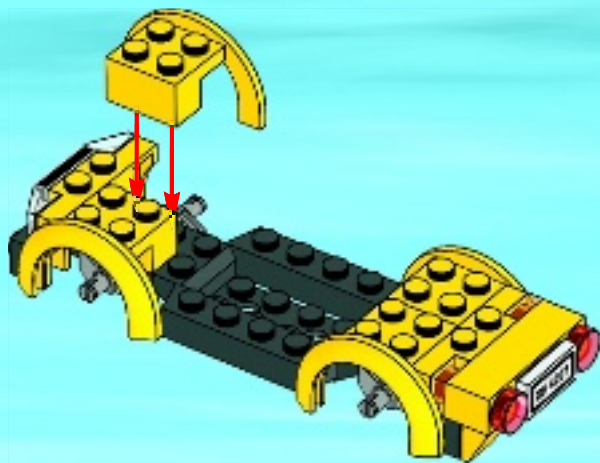



1x



1x

6

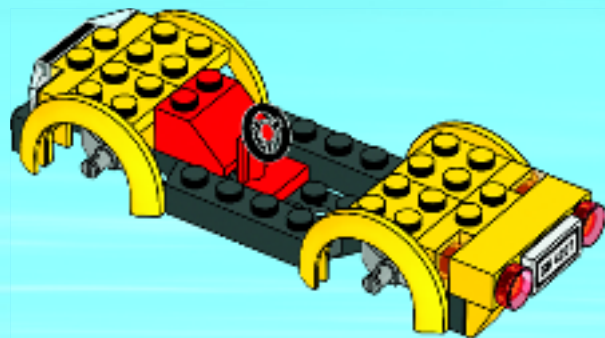



2x

7

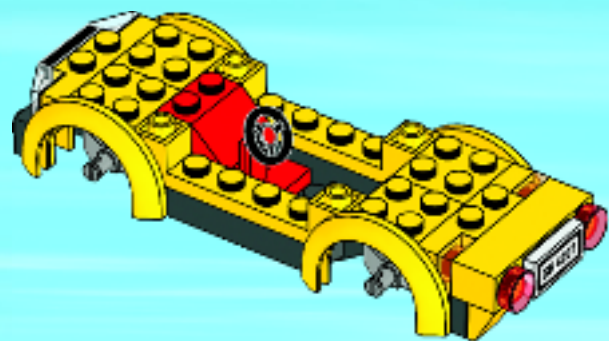

2x



2x

8

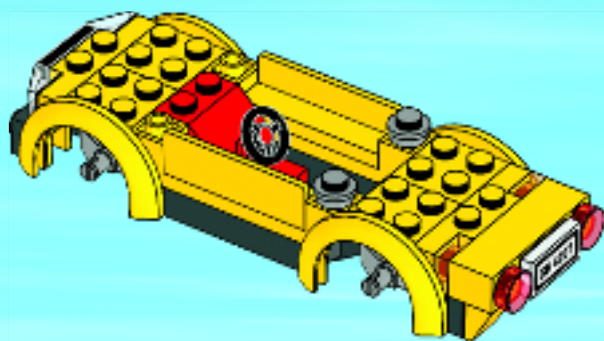



1x



1x

9





1x

10



1x

11





2x



2x

# 12

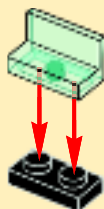

2x

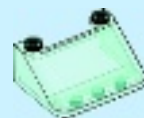
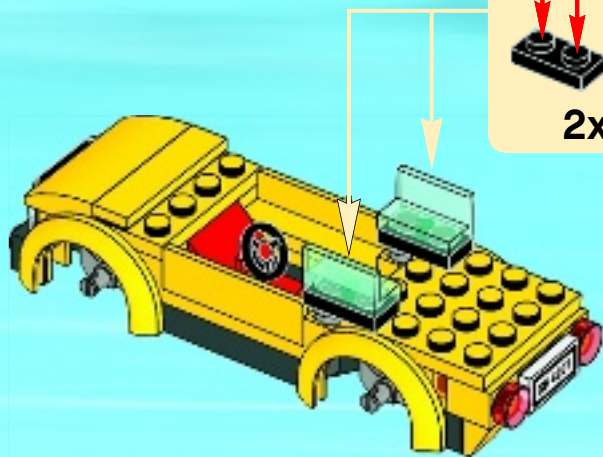

2x

# 13

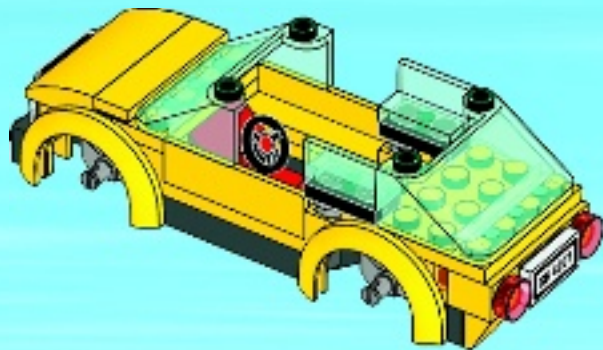





14

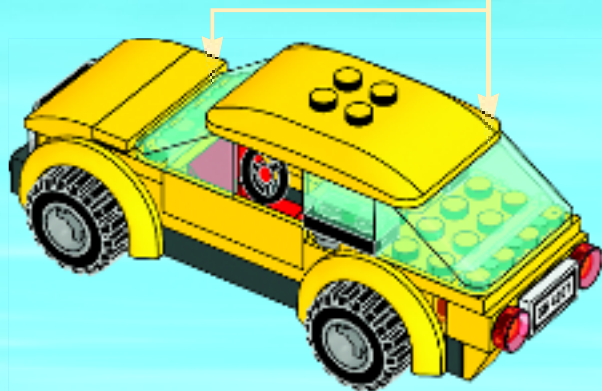
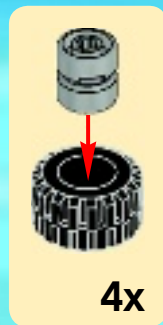

15

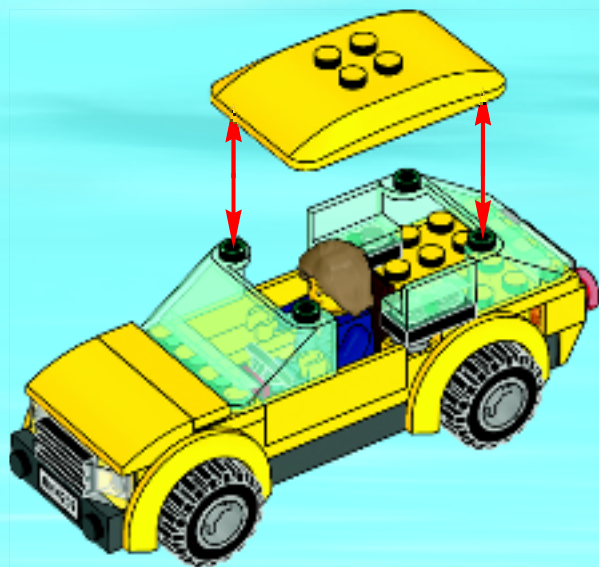



1x

1

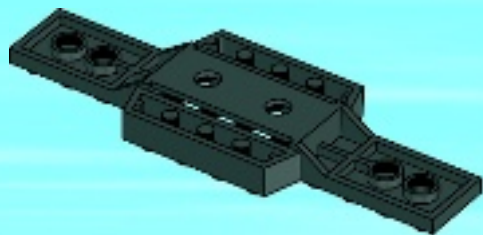

2x

2

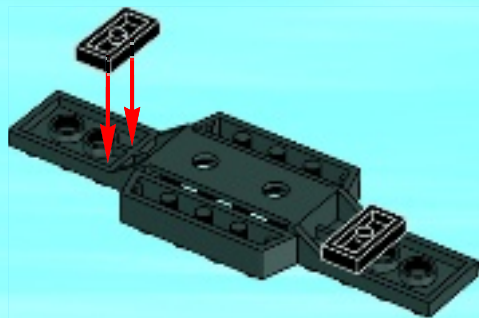



1x



1x

3

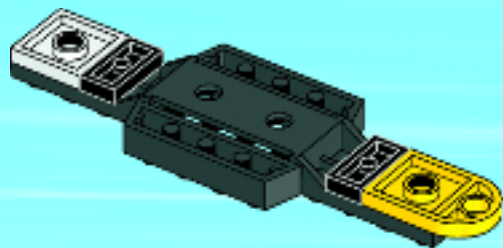

2x

4

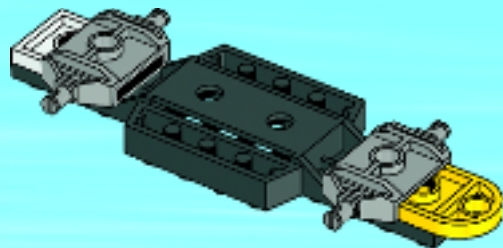

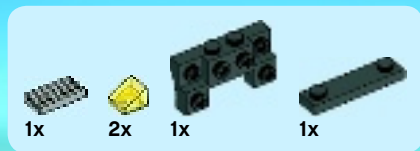

5

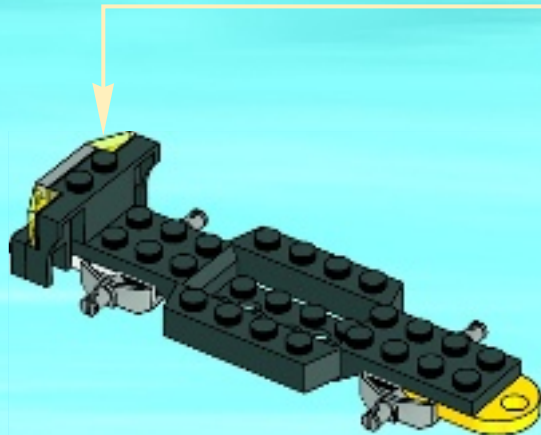
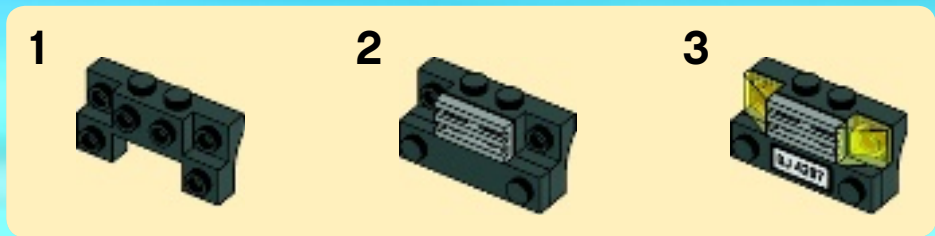



6

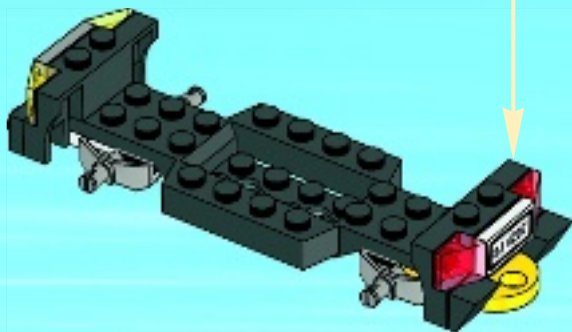



1x



1x

7

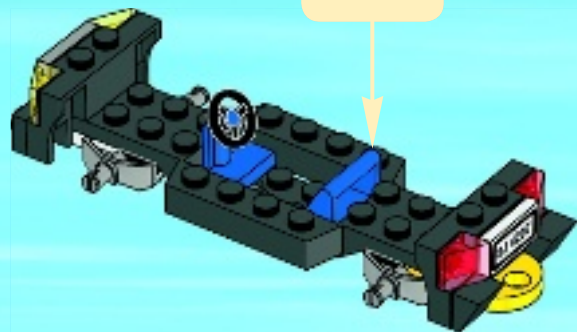

2x

8

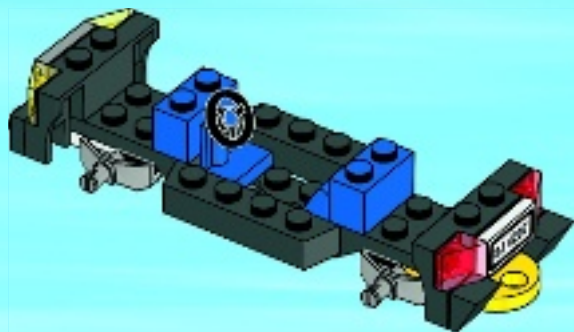



4x

9

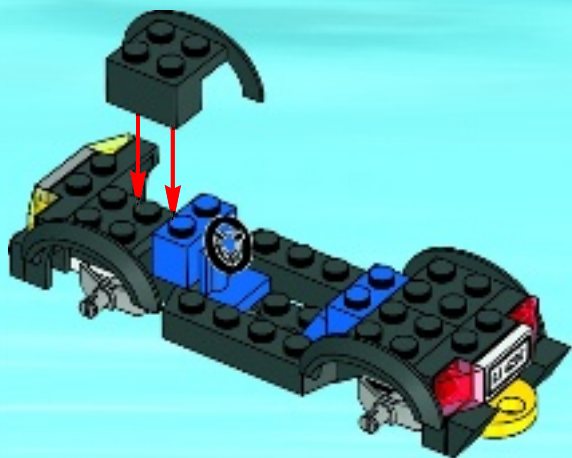





2x

10

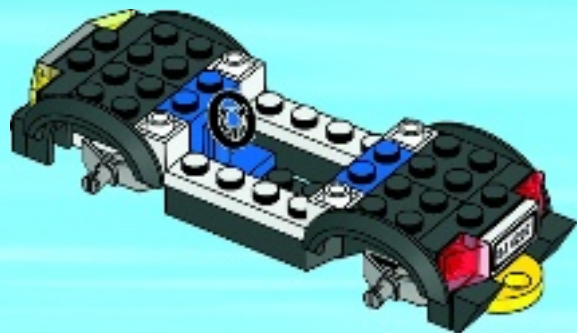

2x

11

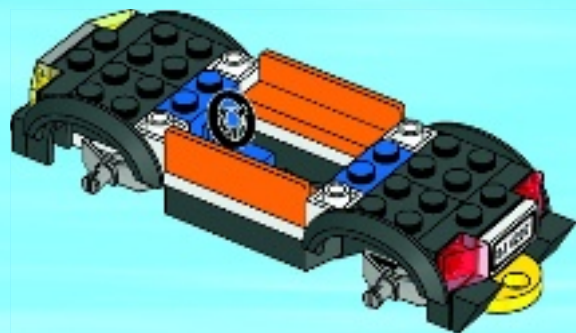



1x



2x

# 12





1x



1x

# 13



1x



1x

# 14

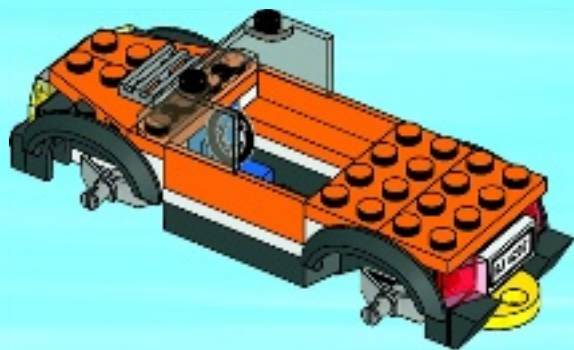



2x

15

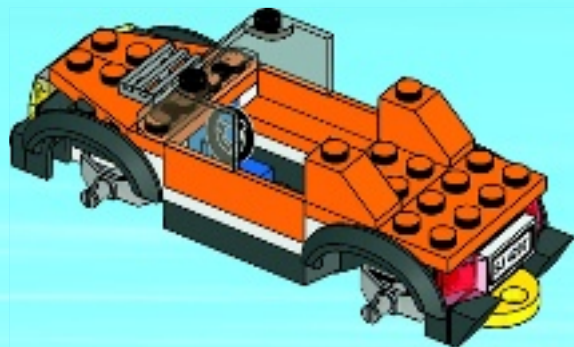



1x



1x

**1**



1x

**2**





1x



1x

3

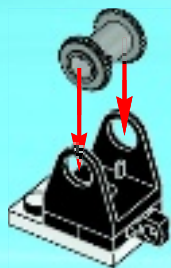

1x

4





1x

5

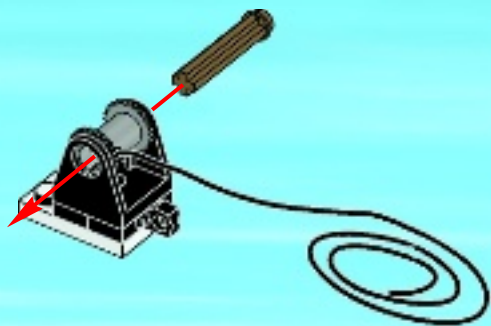

1x

6



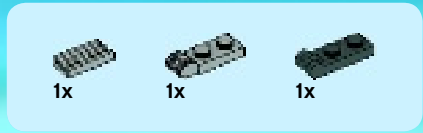

7

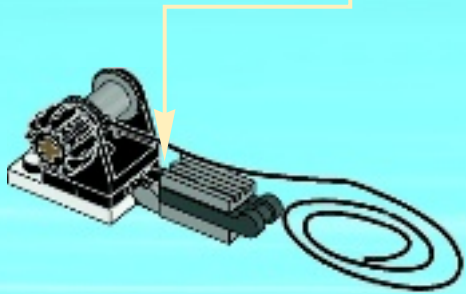
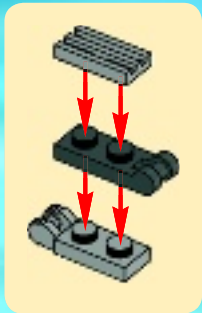

8







1x

9



16

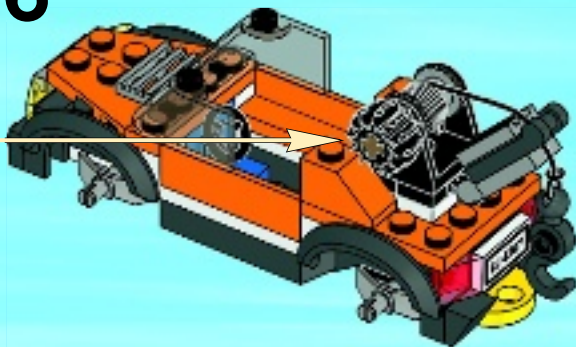

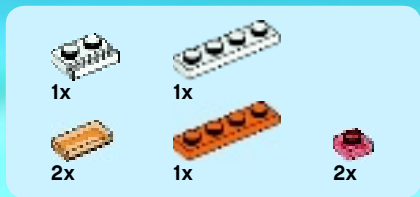

# 17

1

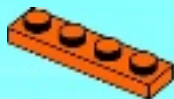

2

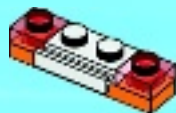

3

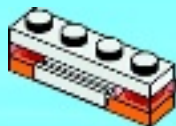

4



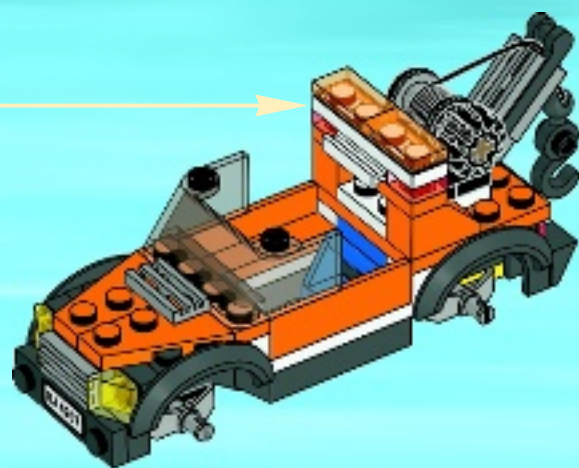



4x



4x

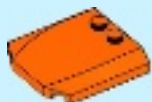

1x

# 18

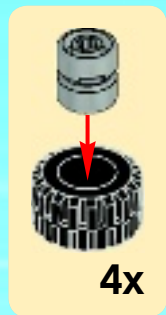

19

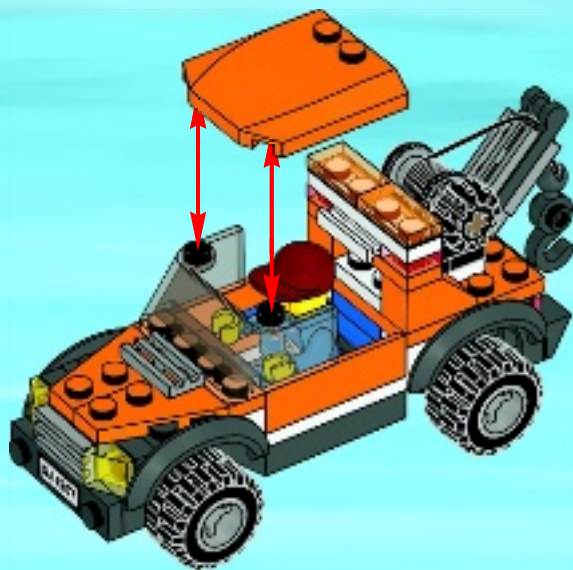

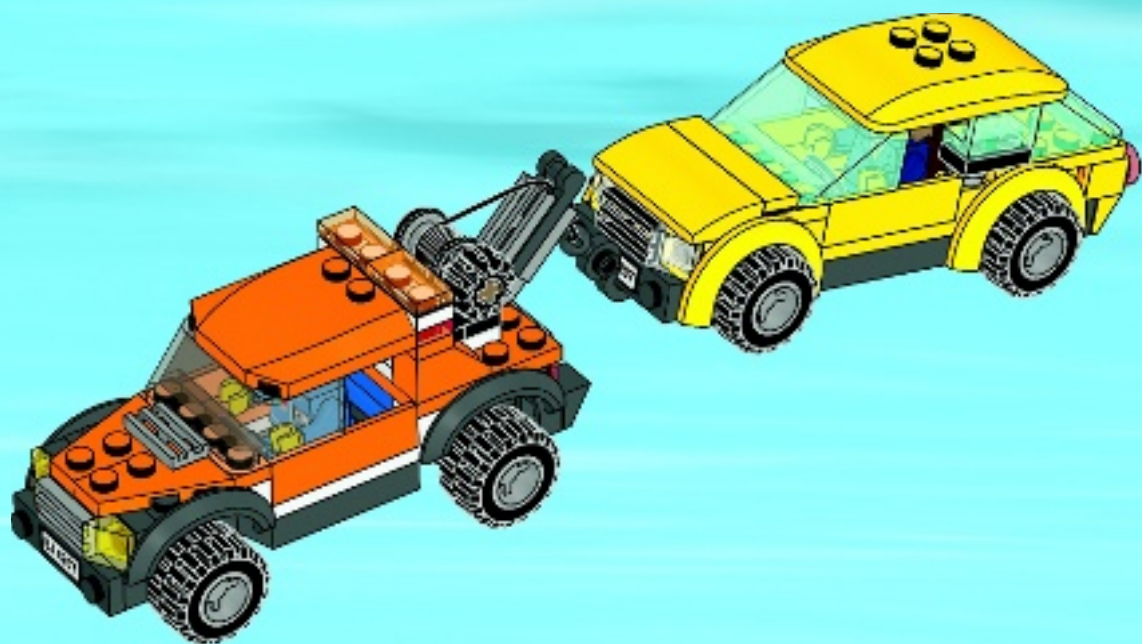



**LEGO** CITY



4204



4203



4202



4201



4200



# CITY

## EXPLORE LOTS OF MOVIES, GAMES AND FUN DOWNLOADS

- Hier findest du viele tolle Filme, Spiele und Downloads
- Découvre de nombreux films, jeux et téléchargements amusants
- Explora montones de películas divertidas, juegos y descargas
- Explora imensos filmes divertidos, jogos e downloads
- Fedezz fel vidám filmeket, játékokat és letöltési lehetőségeket



[www.LEGO.com](http://www.LEGO.com)





4207

# CITY



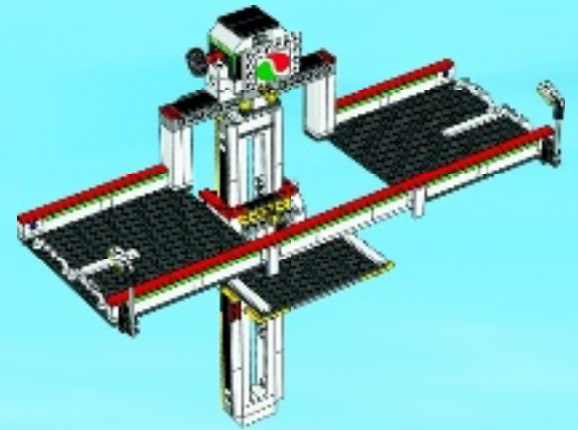
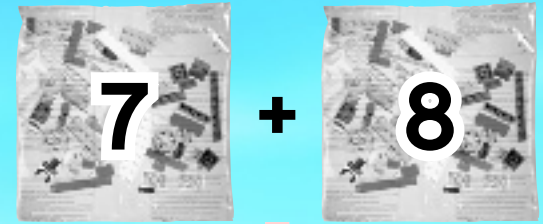
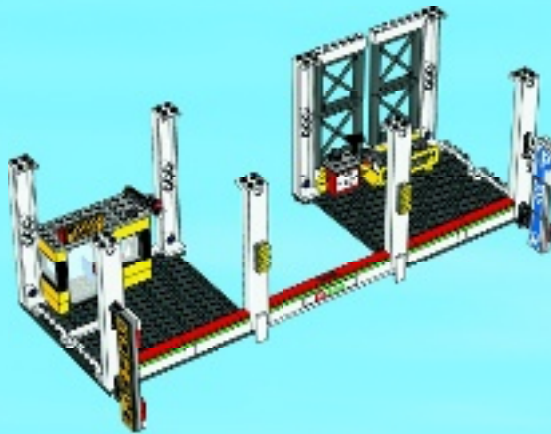
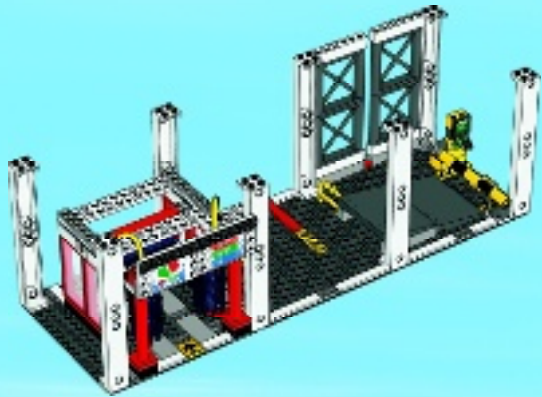
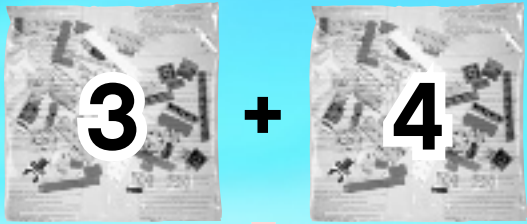





+

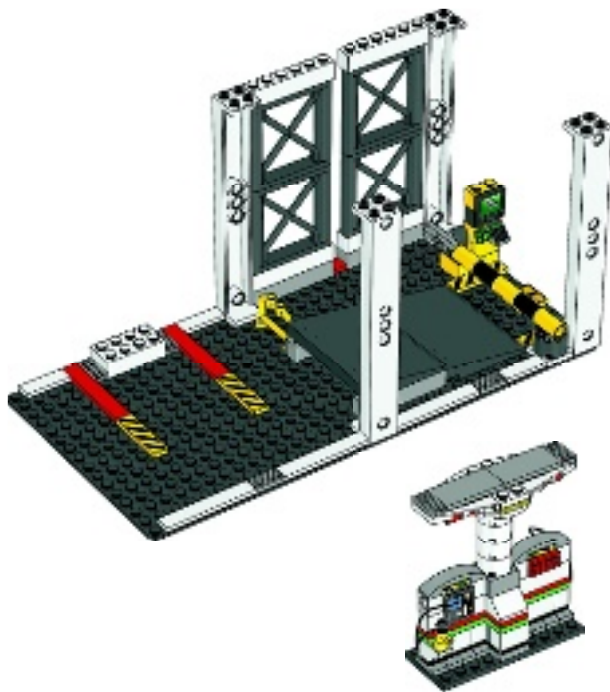

1

1x



2

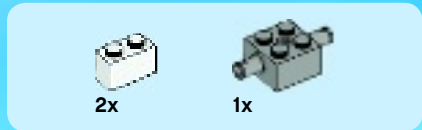



1x



1x

# 3

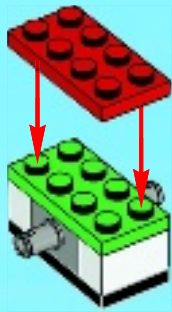

2x

# 4

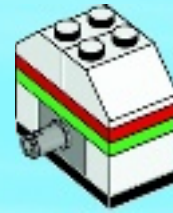



1x



1x

5

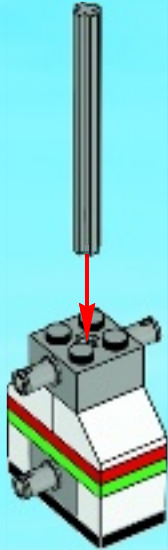

4x

6





1x

1



1x



1x



1x

2

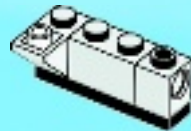

1x



1x

3

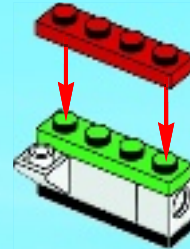



1x



1x

4

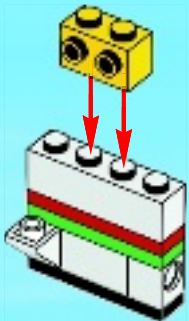

1x



1x

5

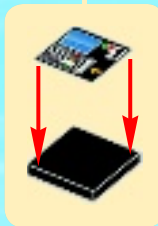
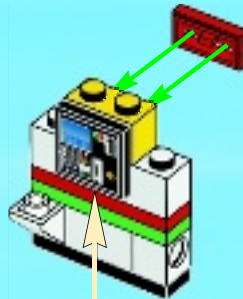

2x

6

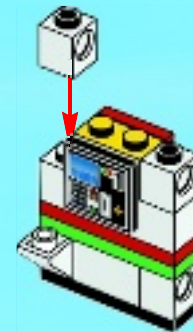



7

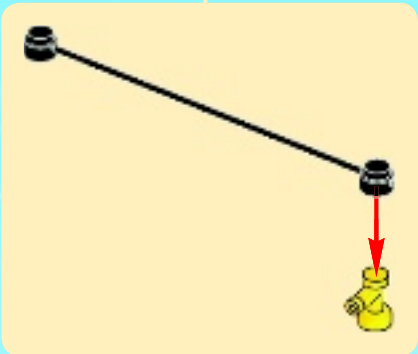

8



2x

9

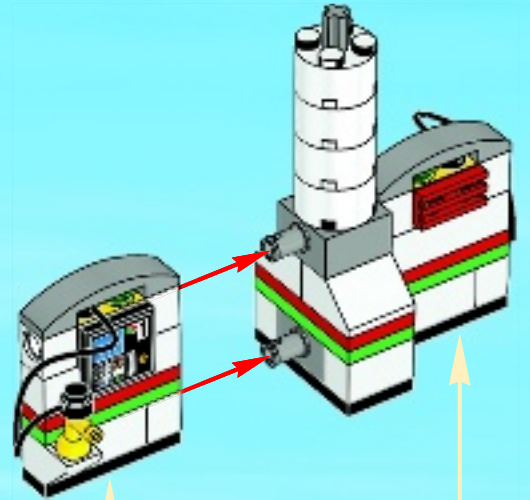



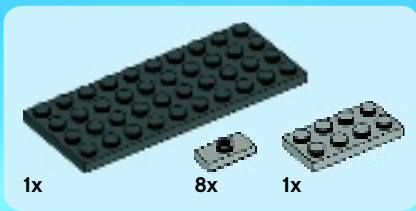

# 10

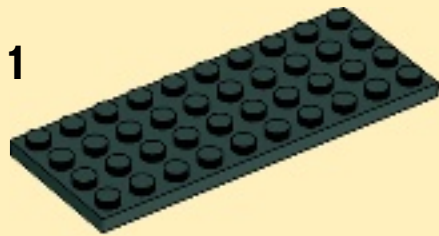



2x



1x

1

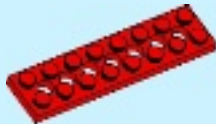

1x

2



1x



2x

3

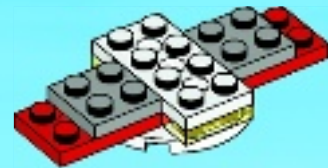

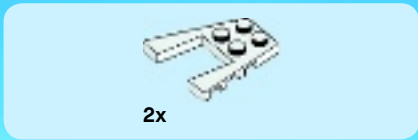

4

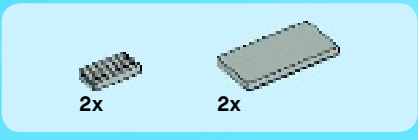

5

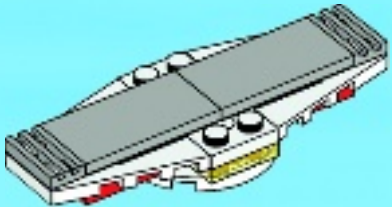

11

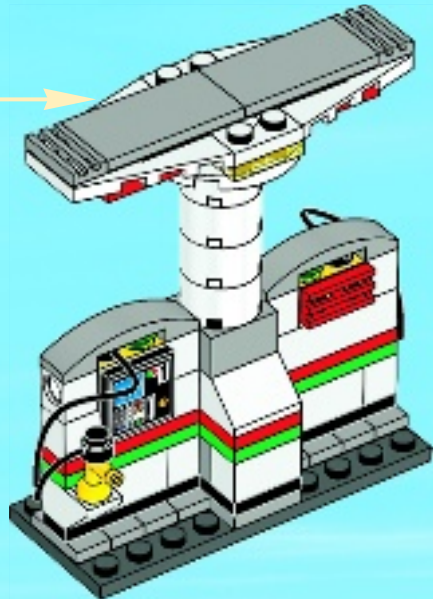

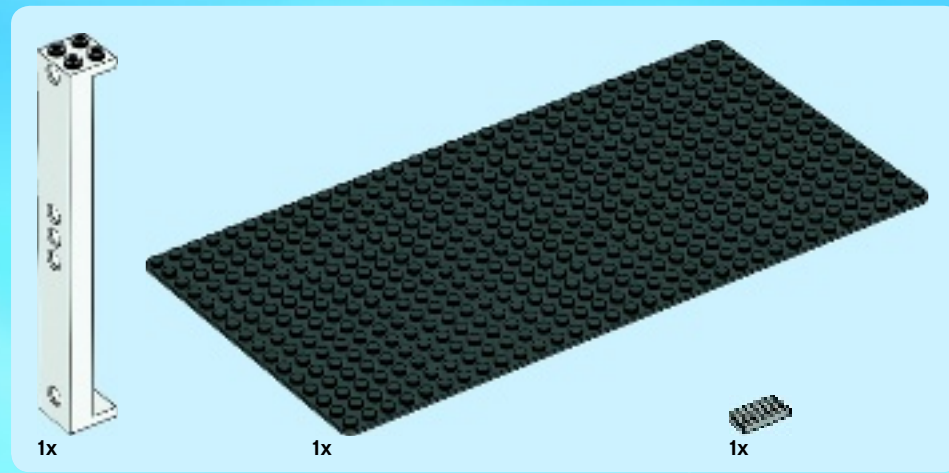

1

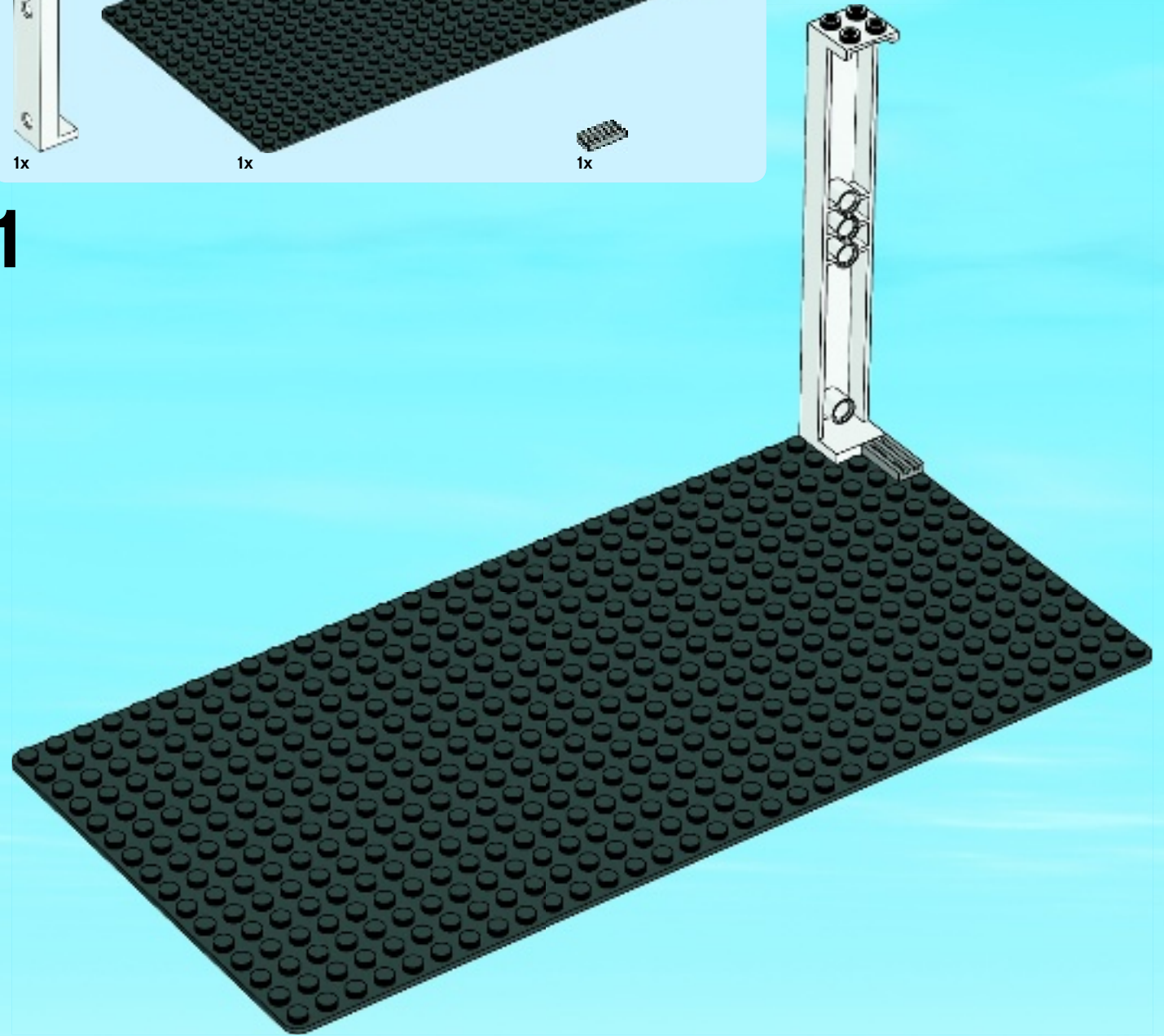



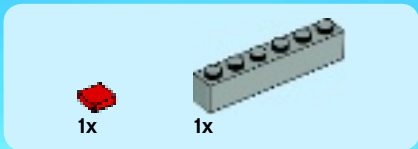

2

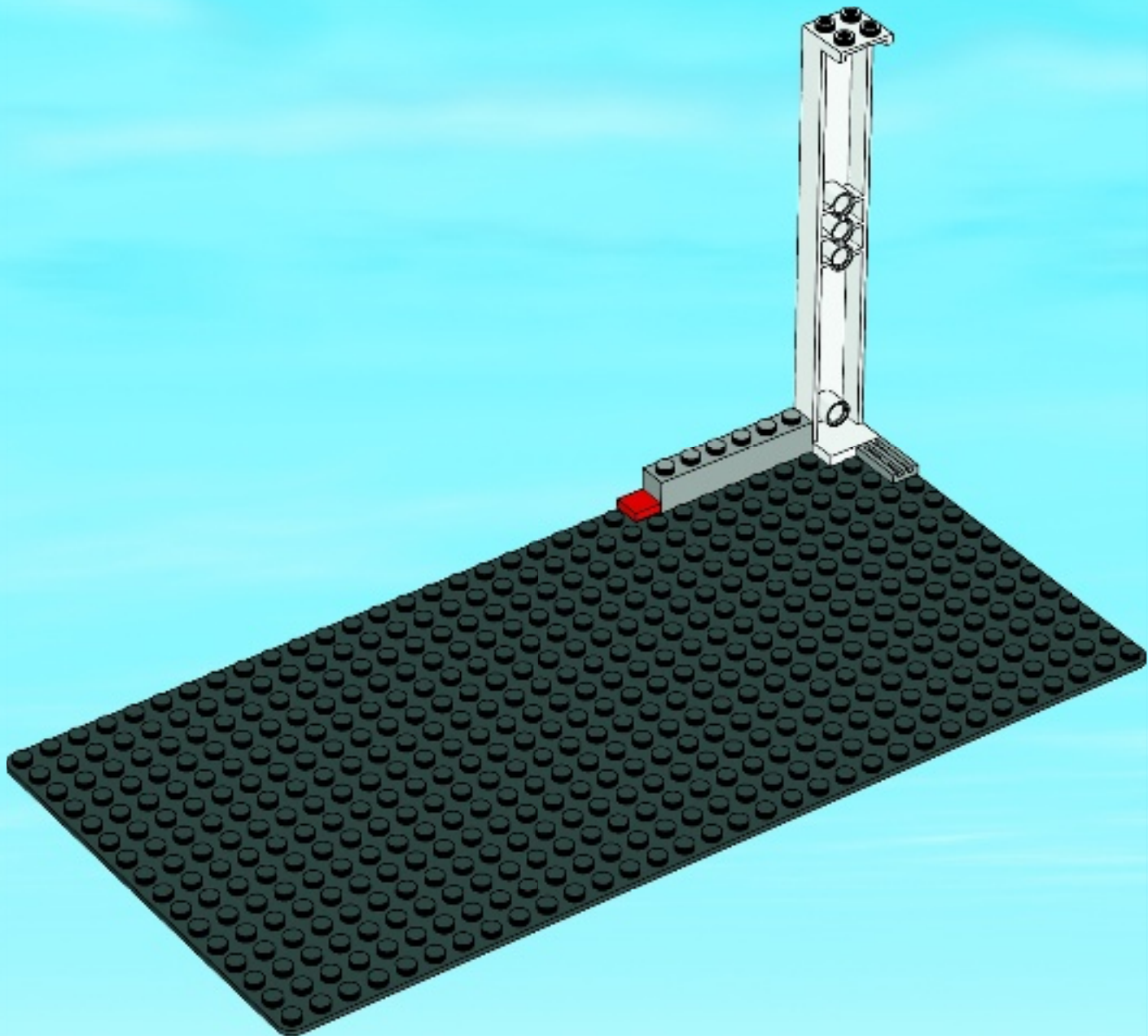

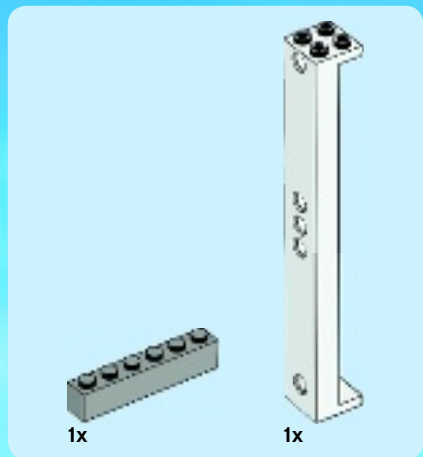

3

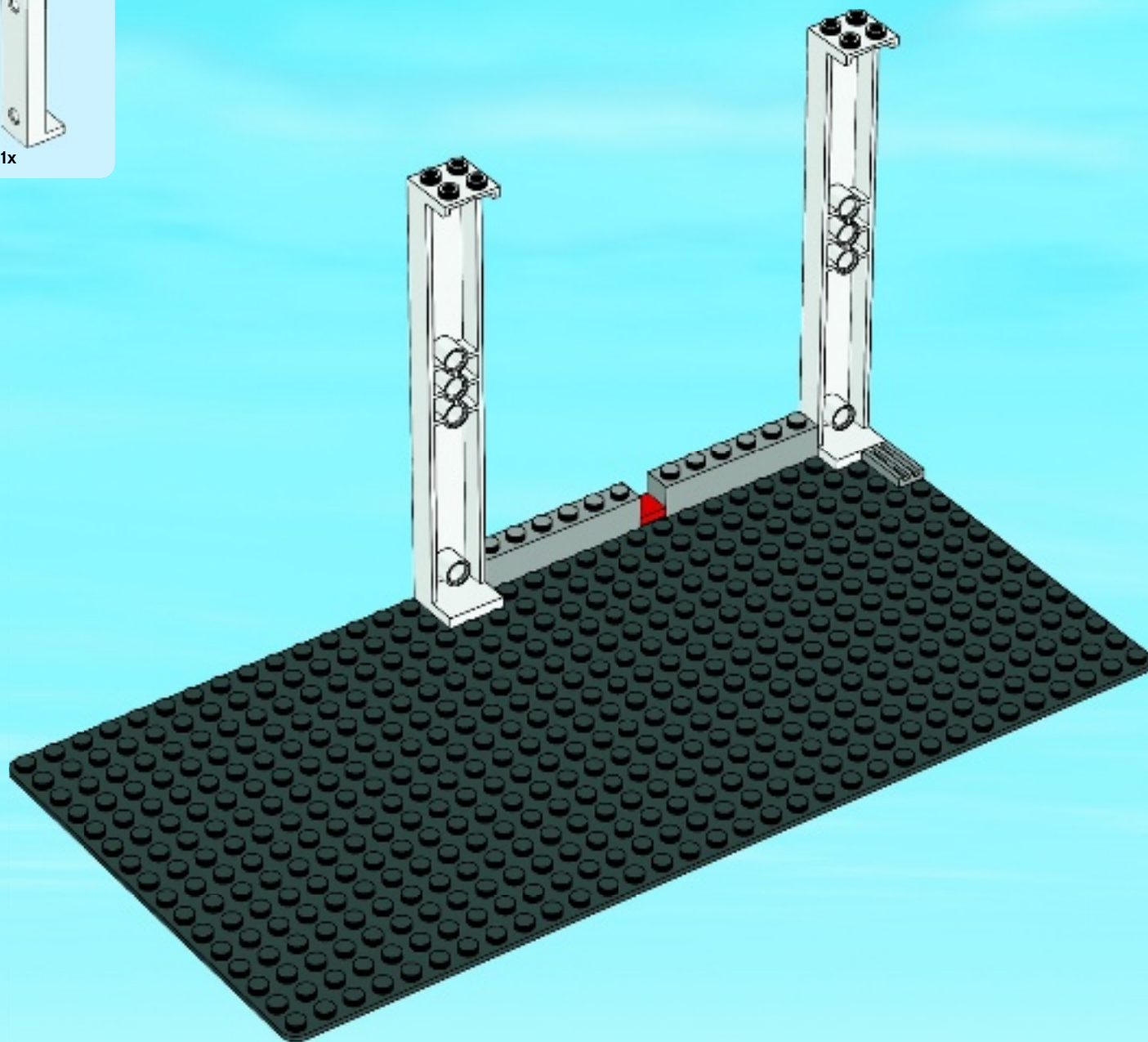

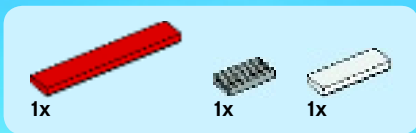

4

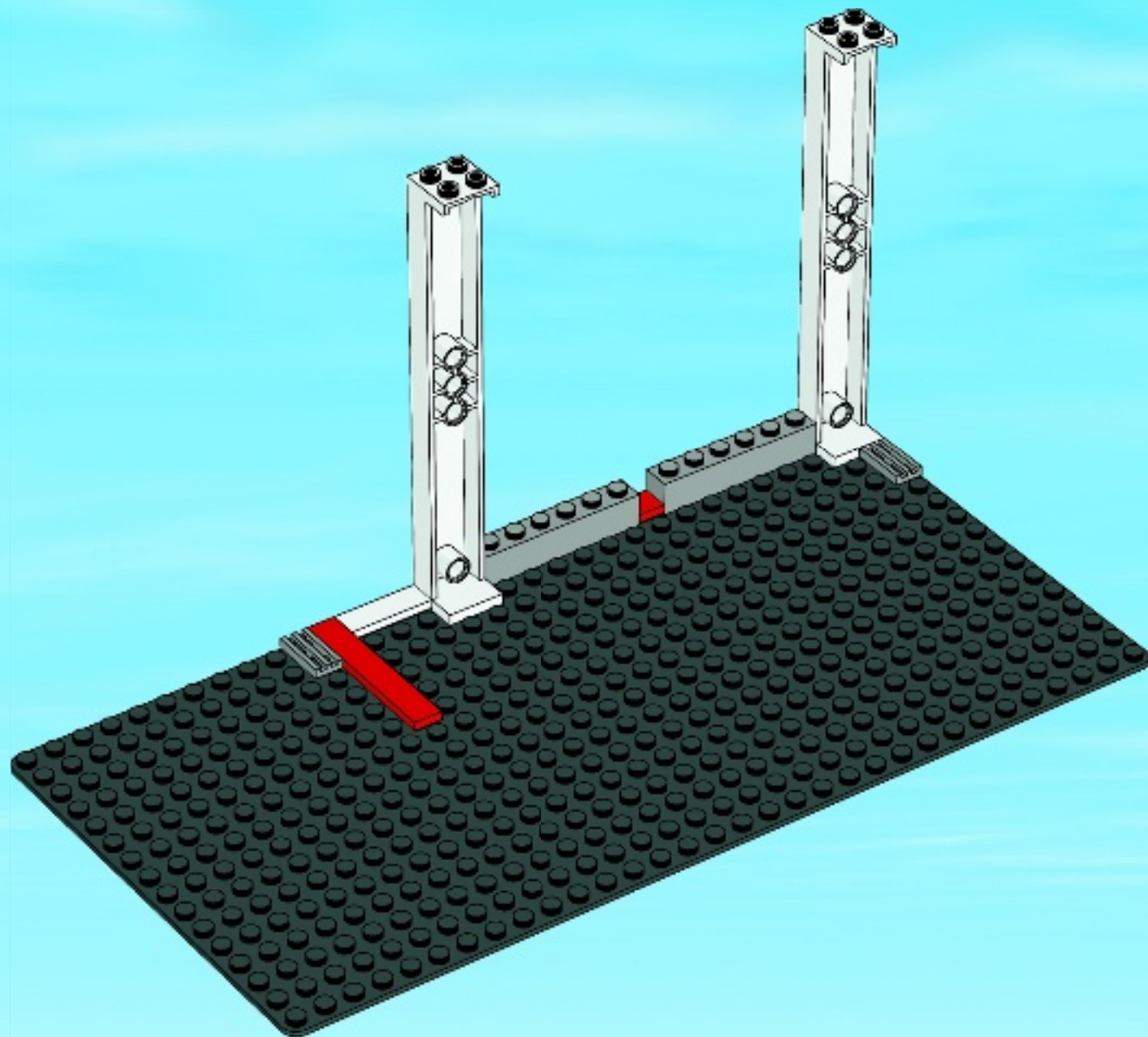



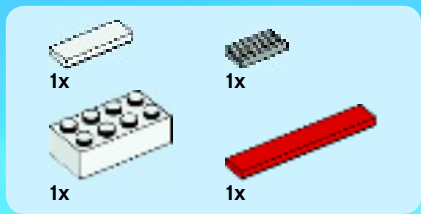

5

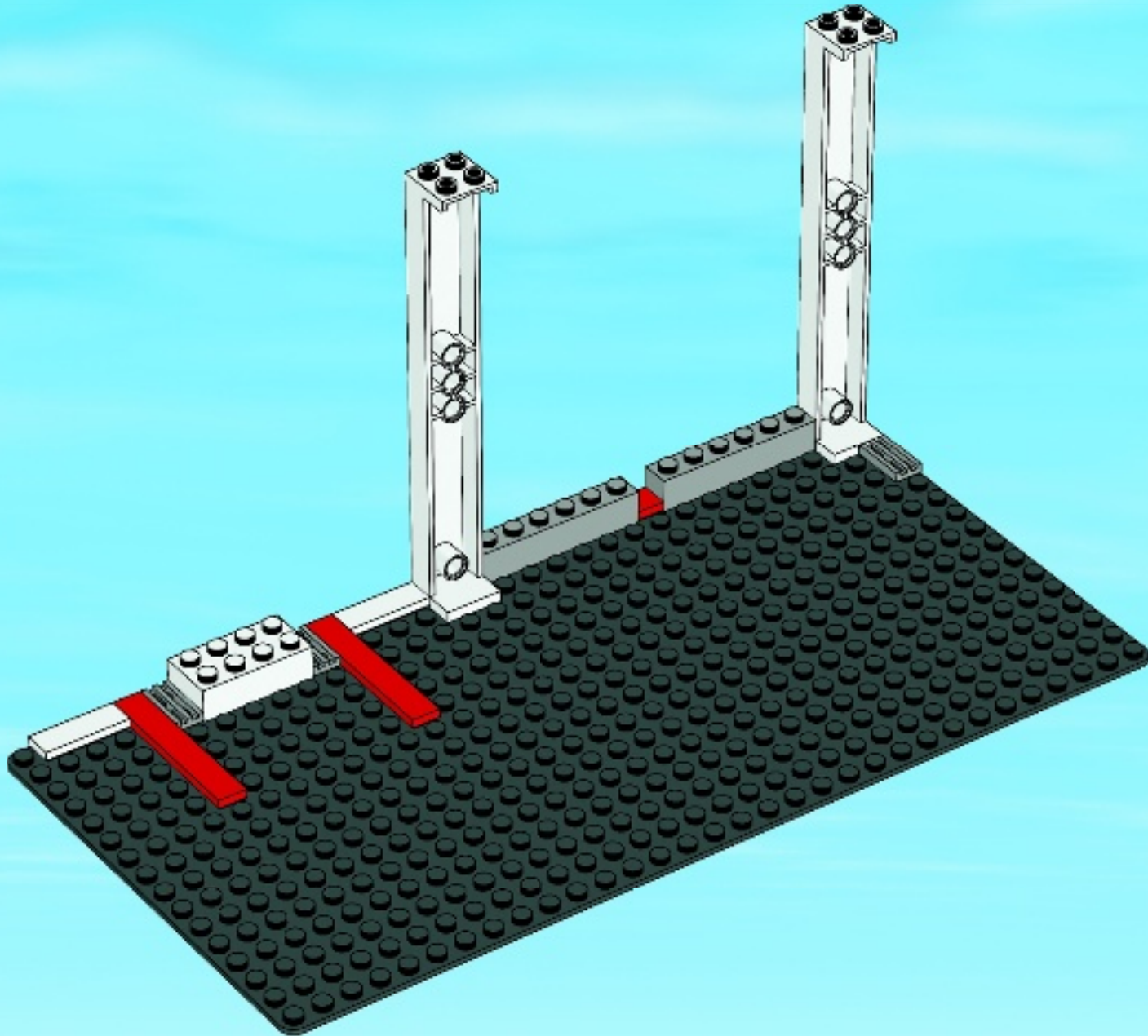





2x

6

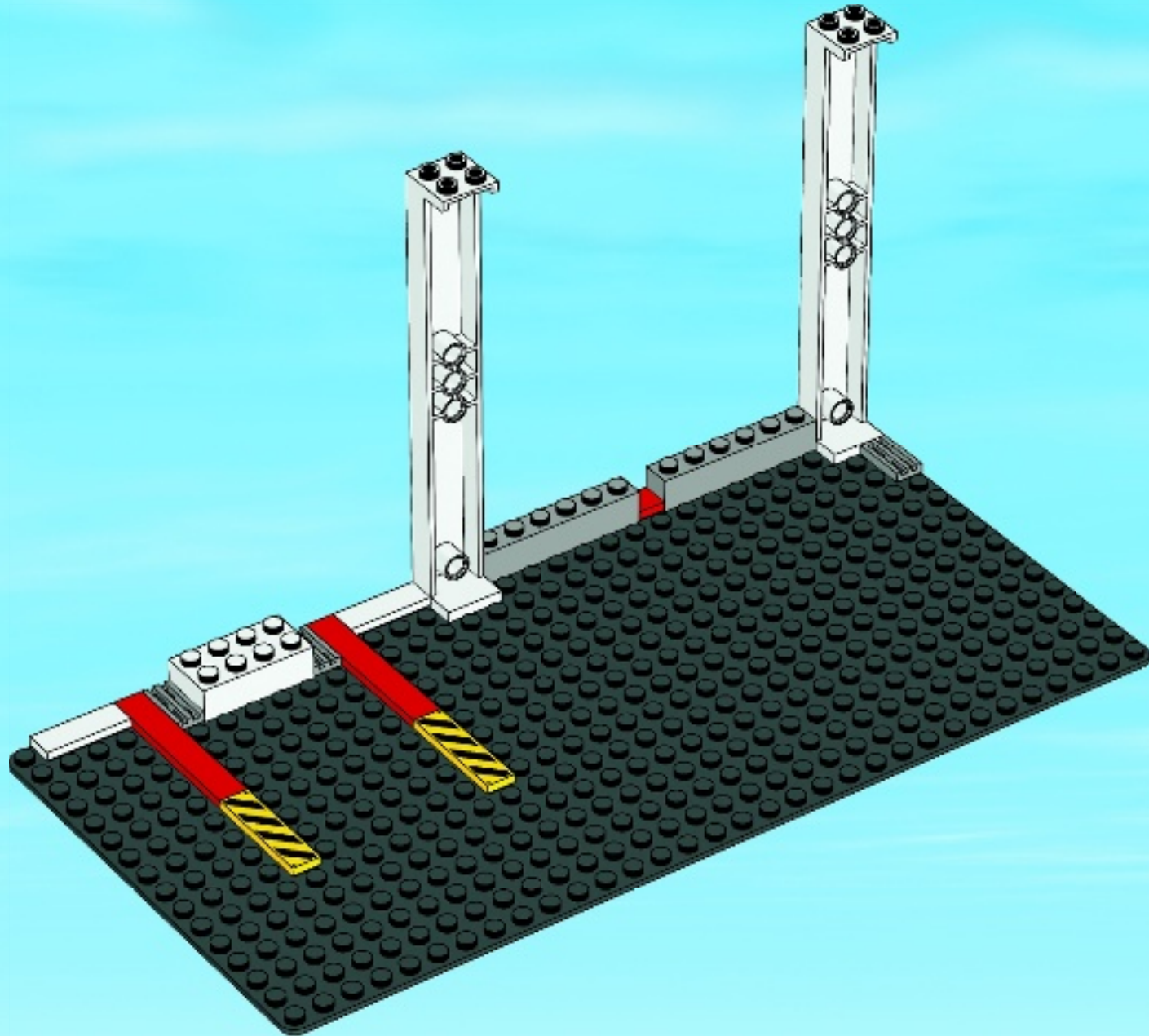

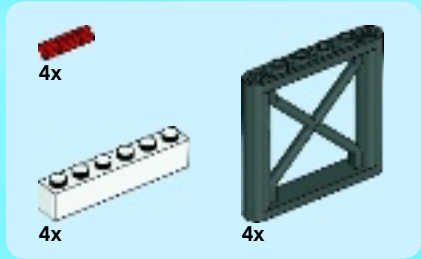

7

1

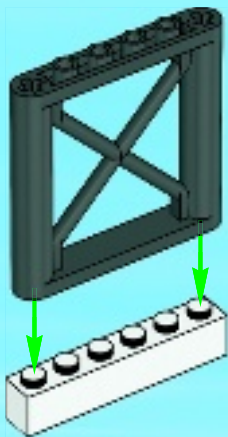

2

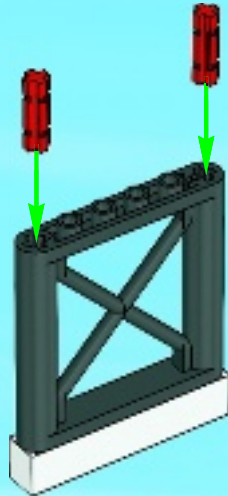

3

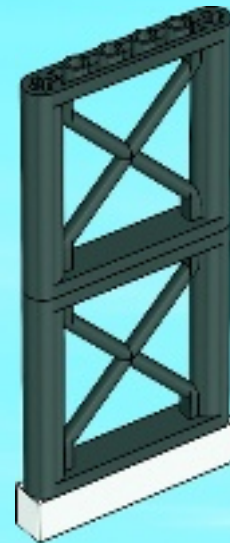

4

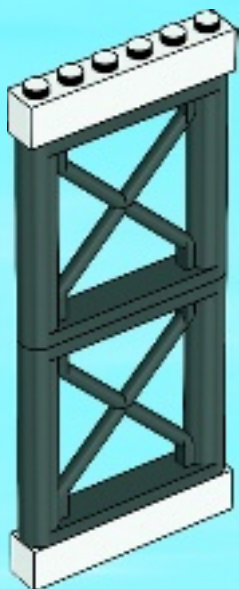

2x

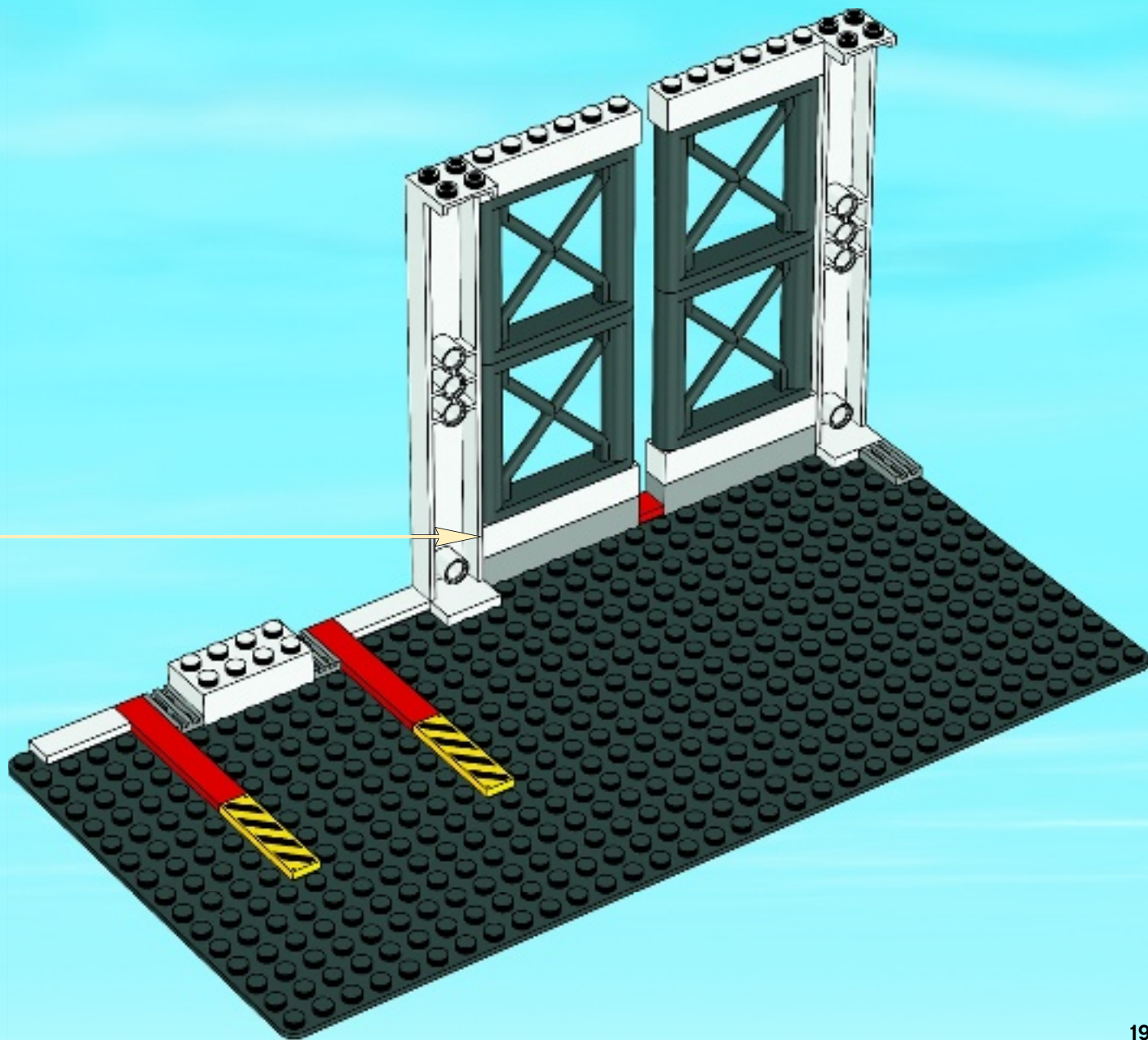



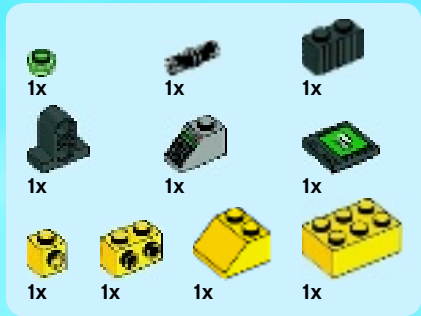

# 8

1

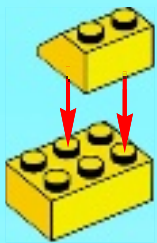

2

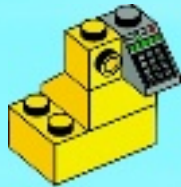

3



4

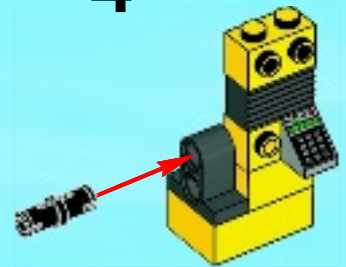

5

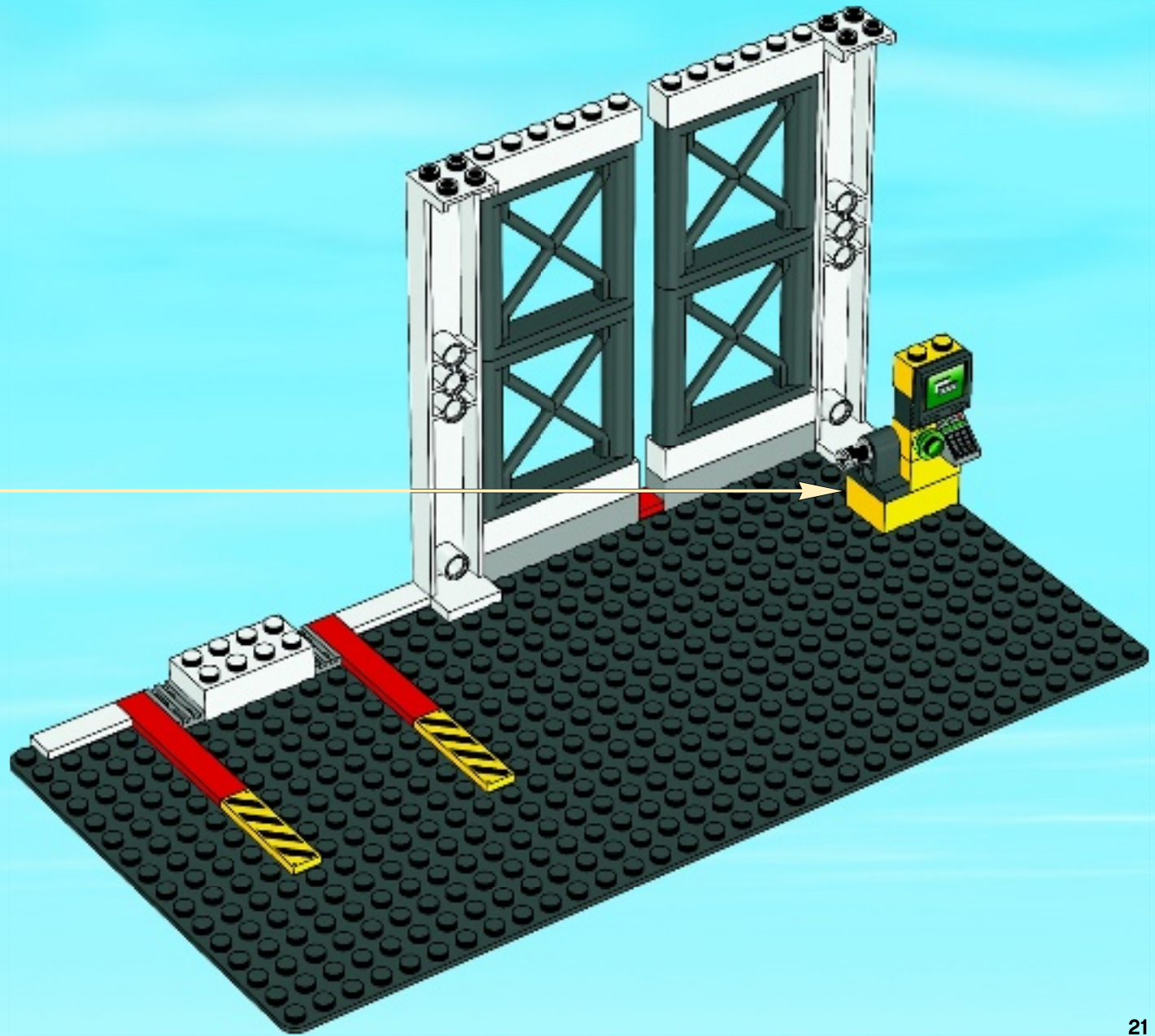



9

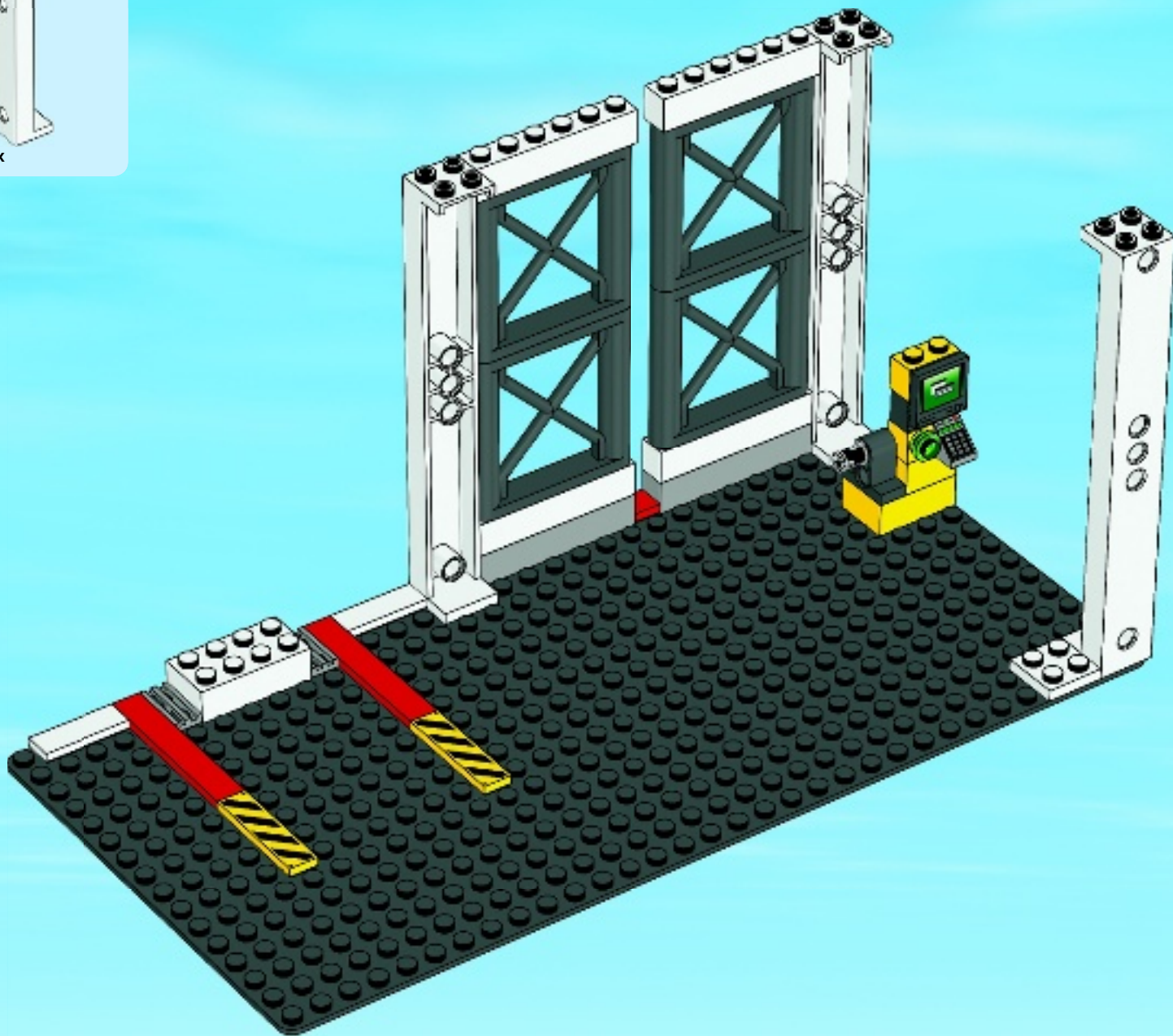





1x



2x

# 10

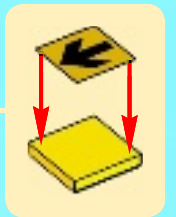
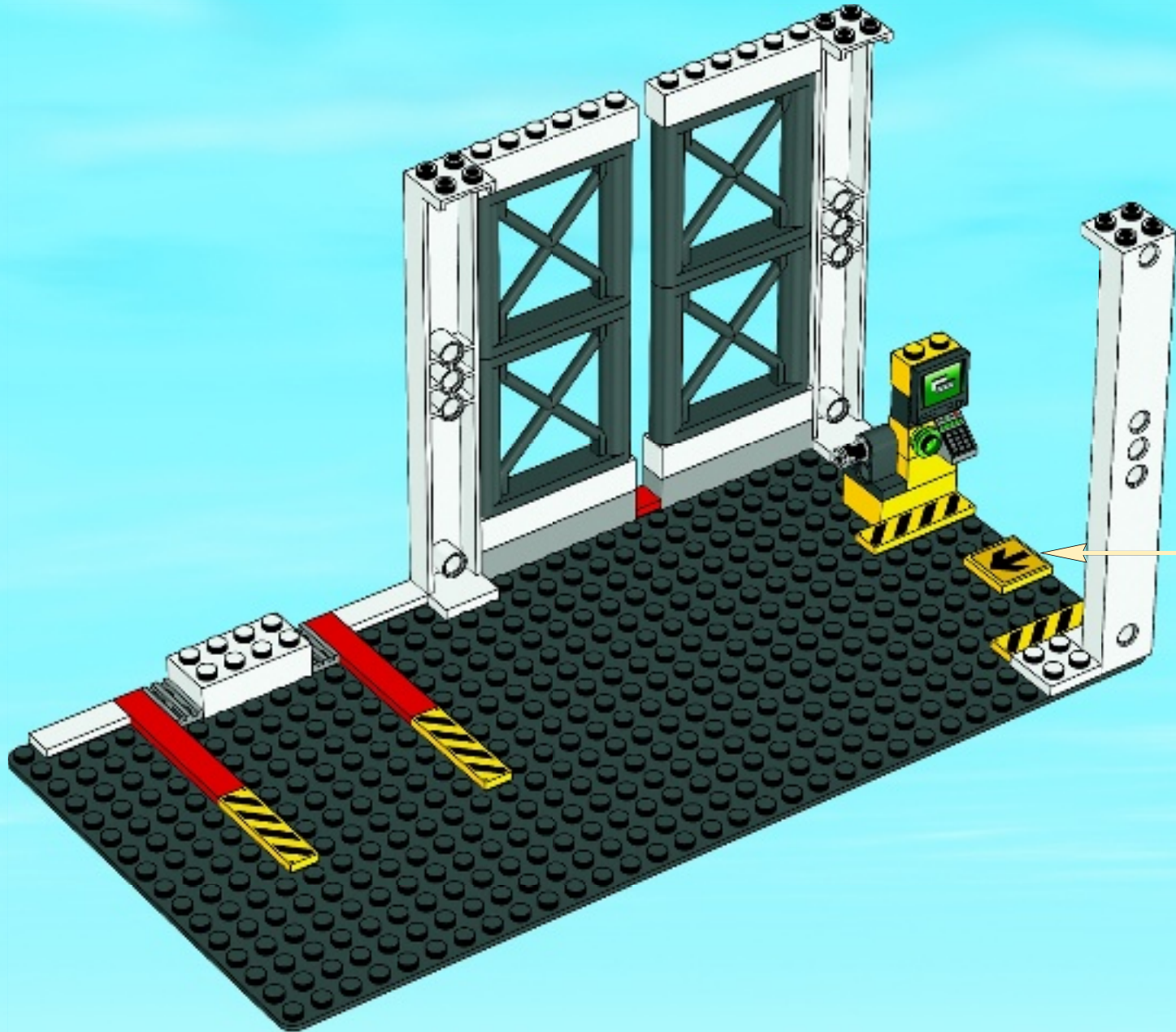



1x



1x

# 11

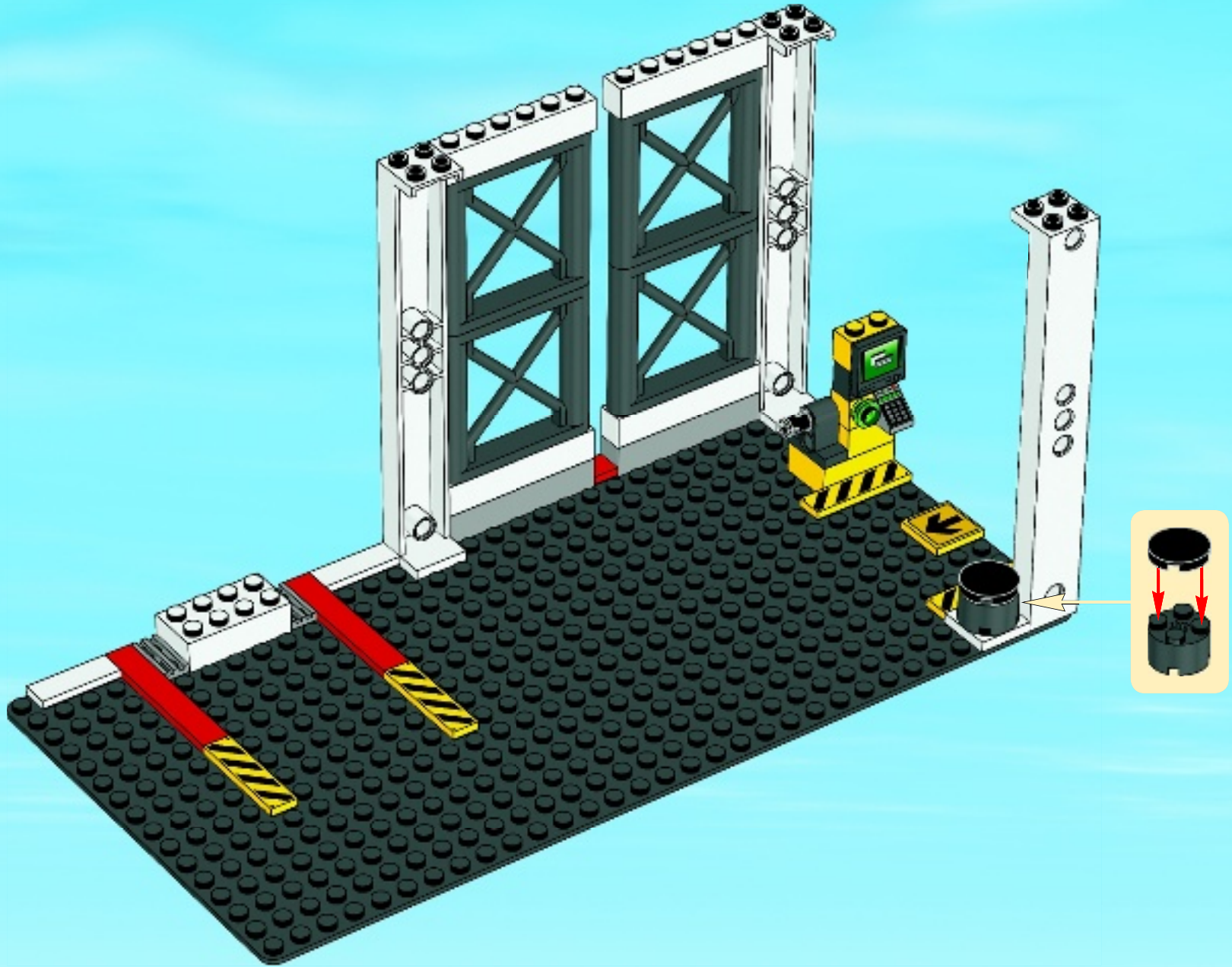



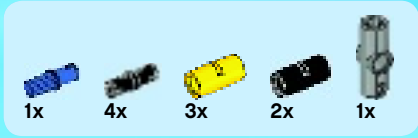

# 12

1

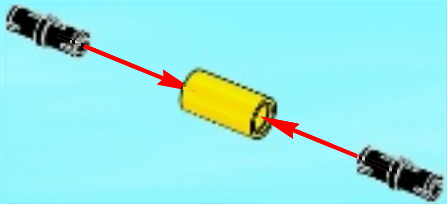

2

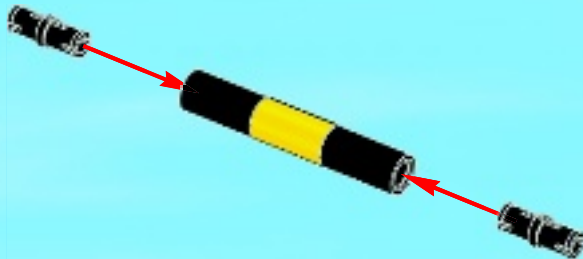

3

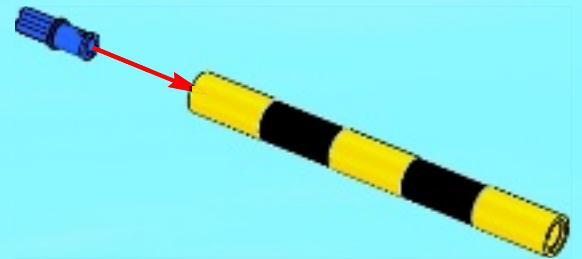

4

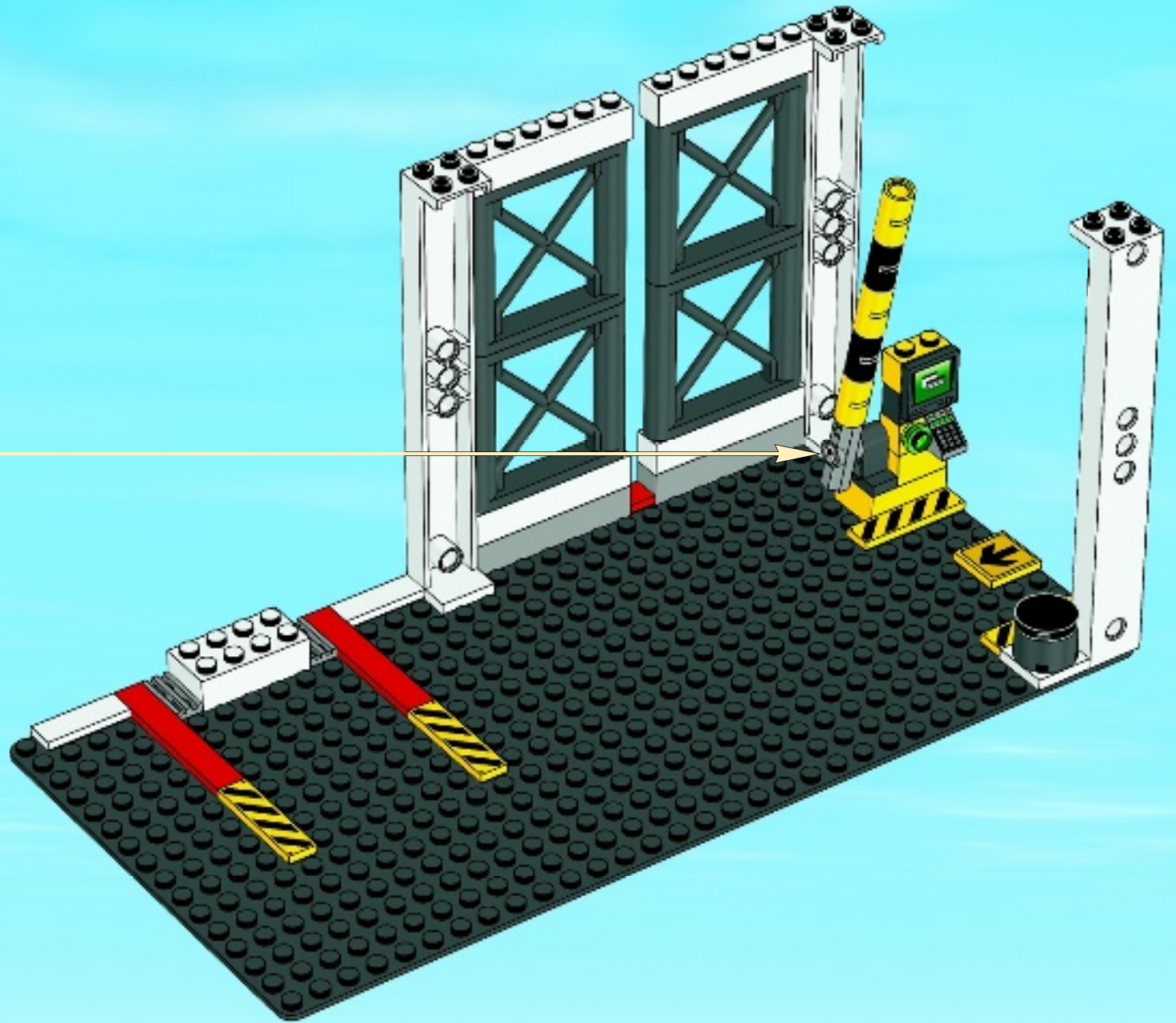
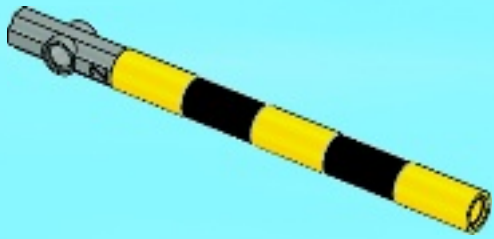

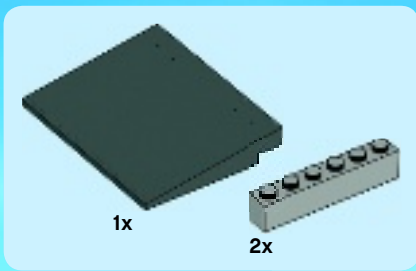

13

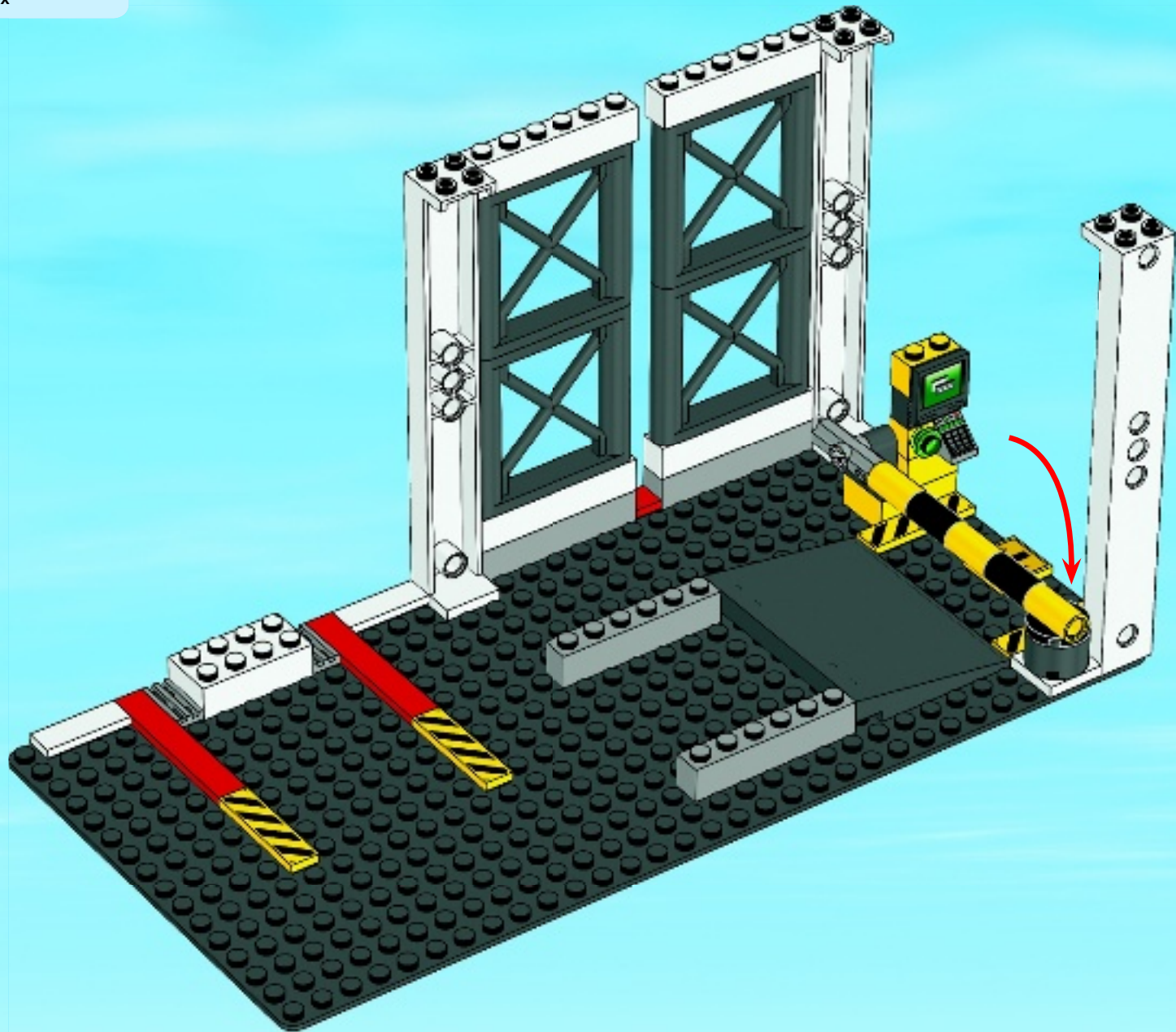



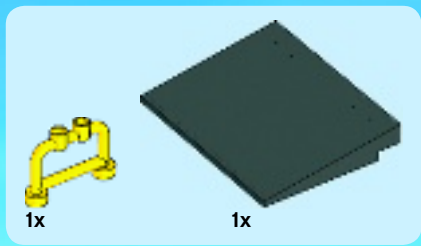

14

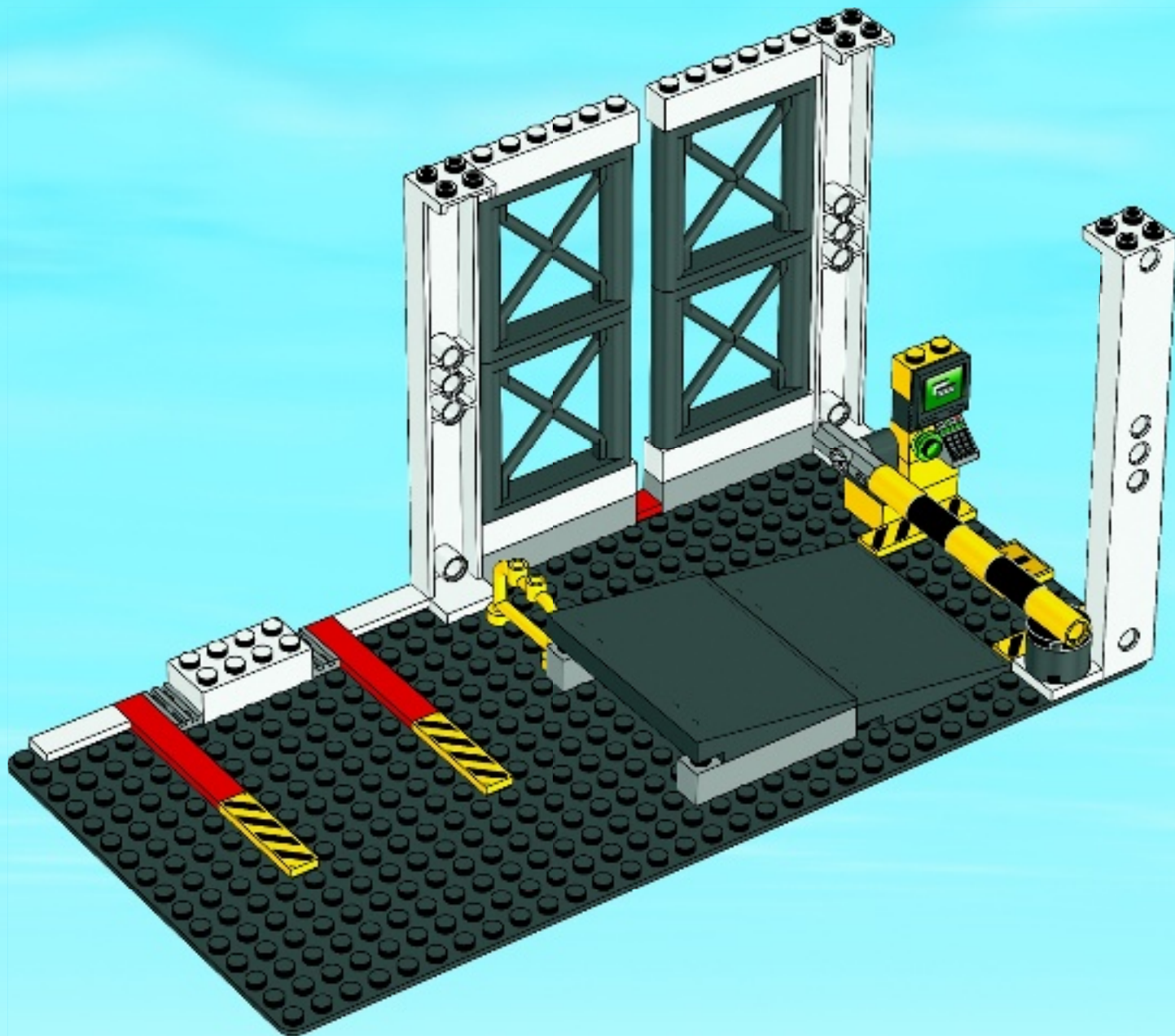

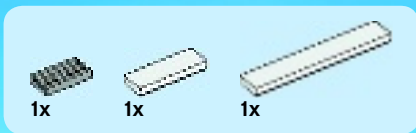

15

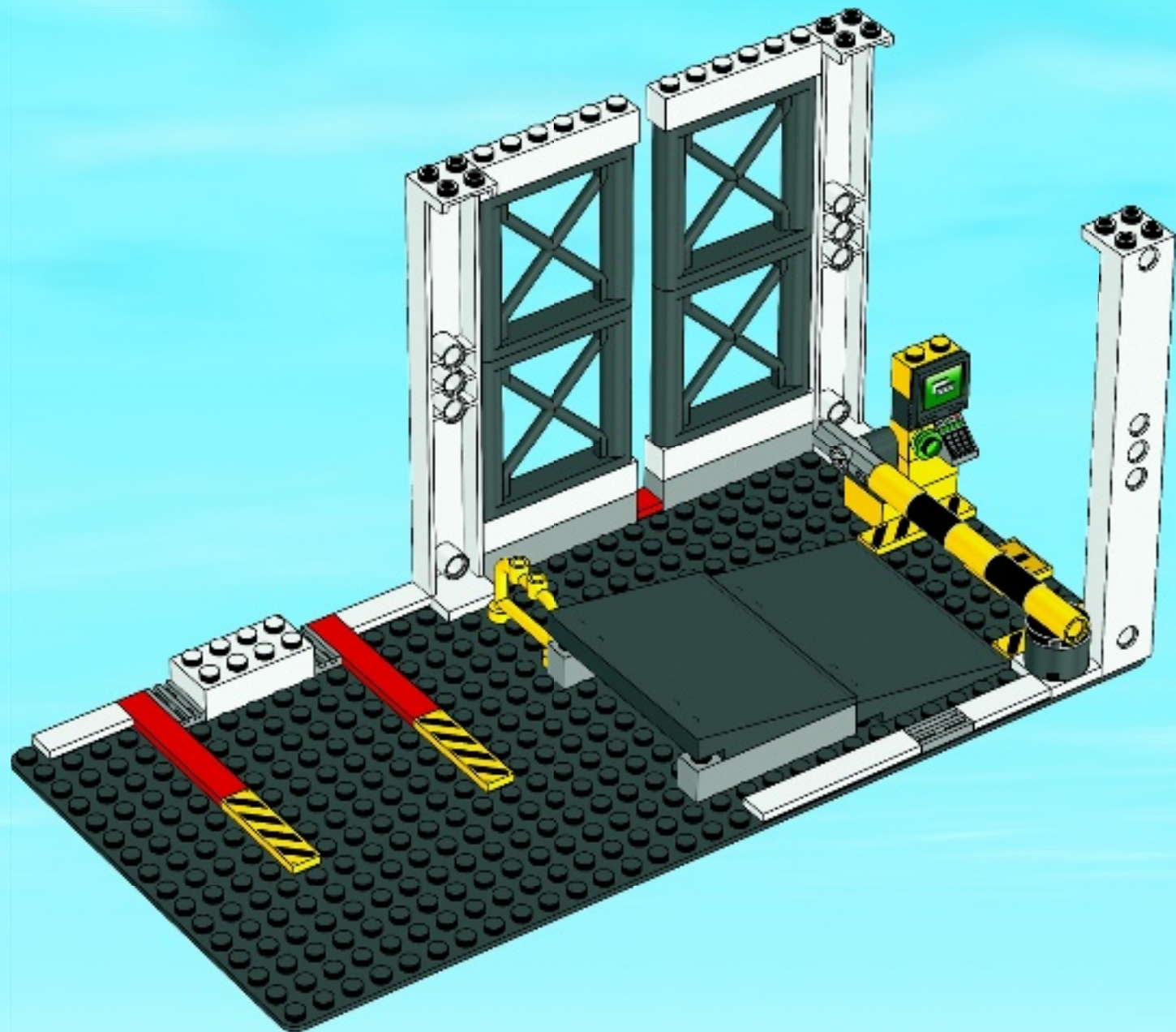



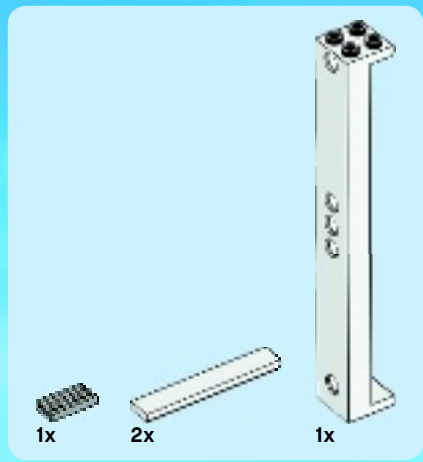

16

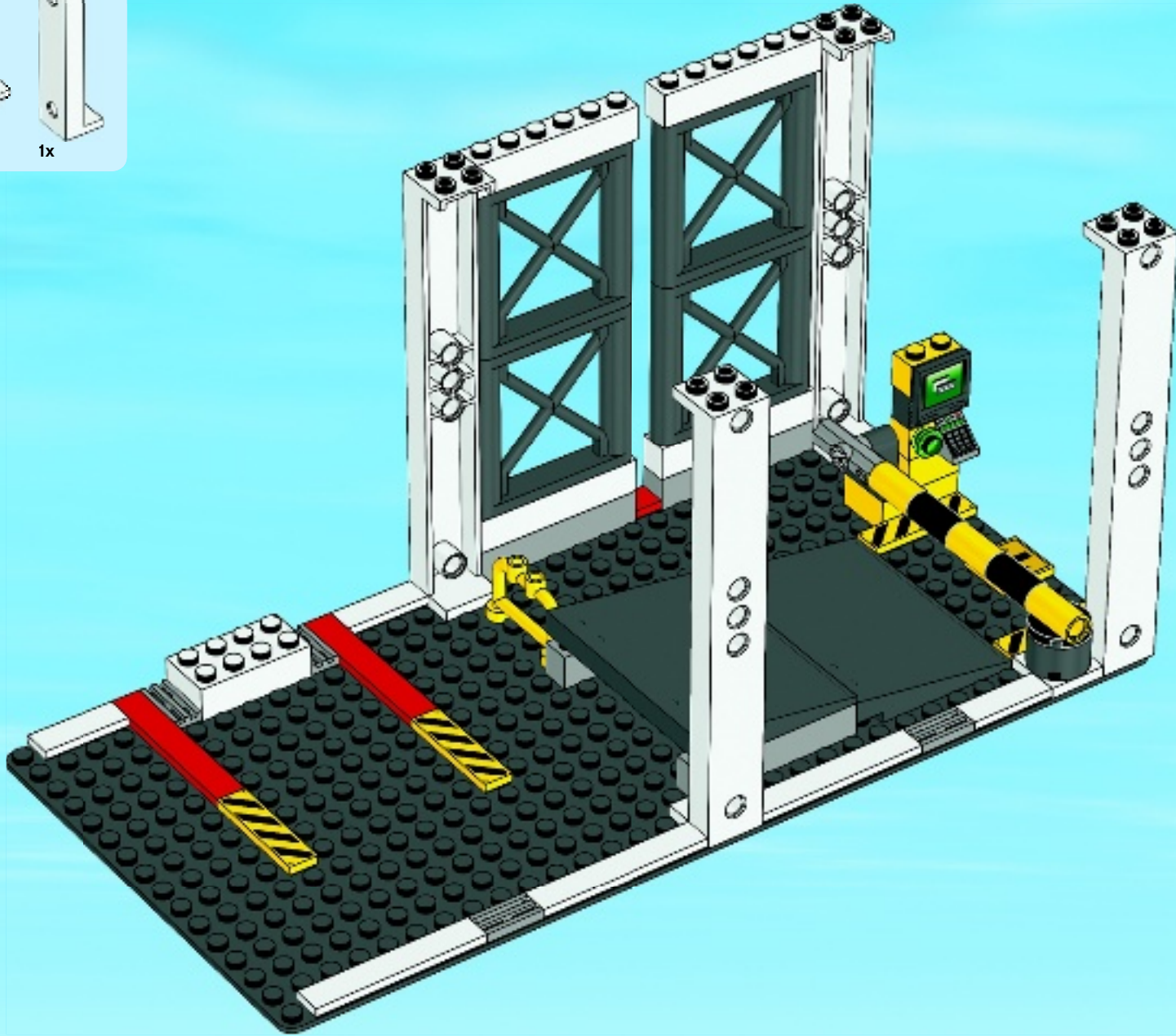

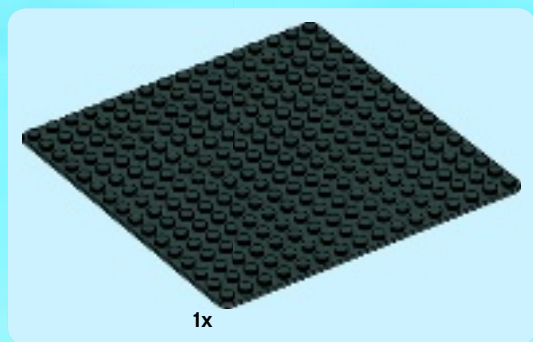
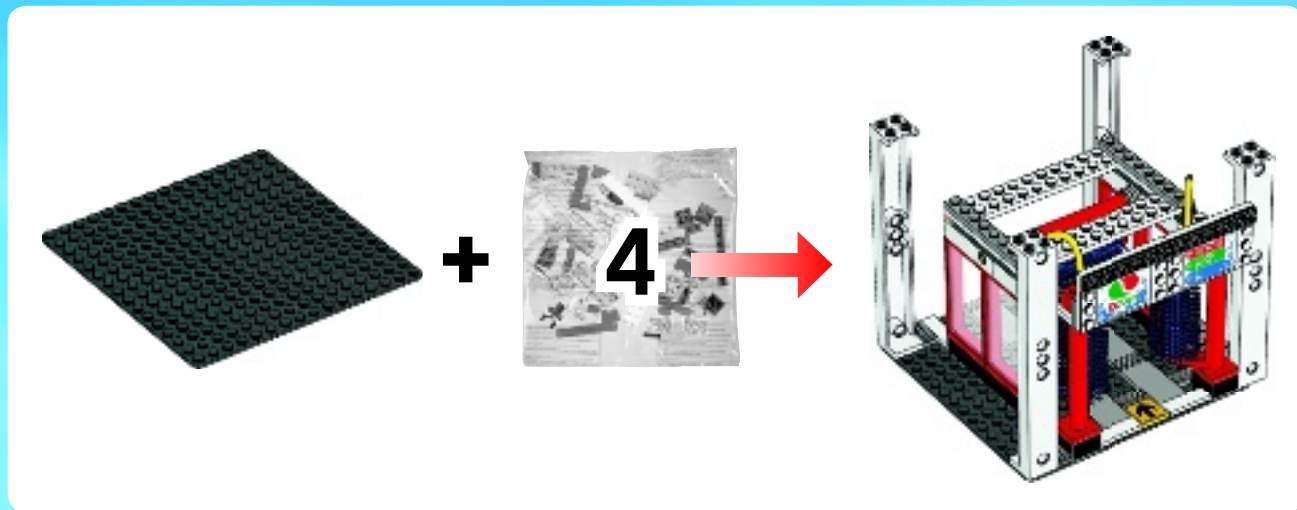

17

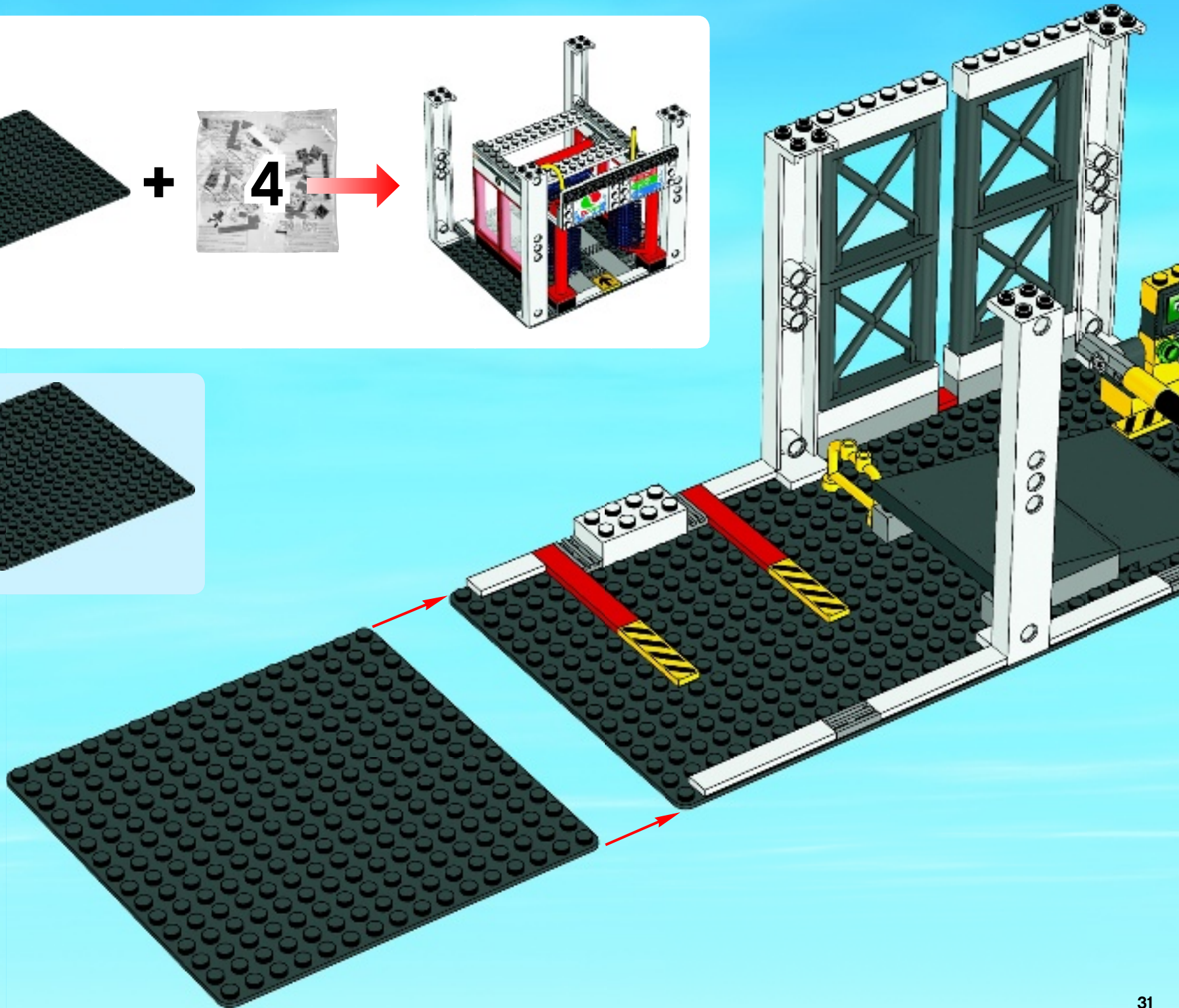



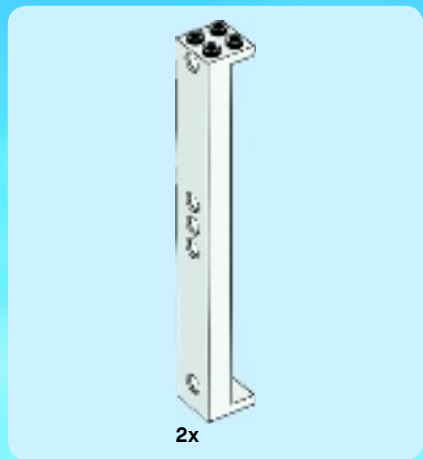

18

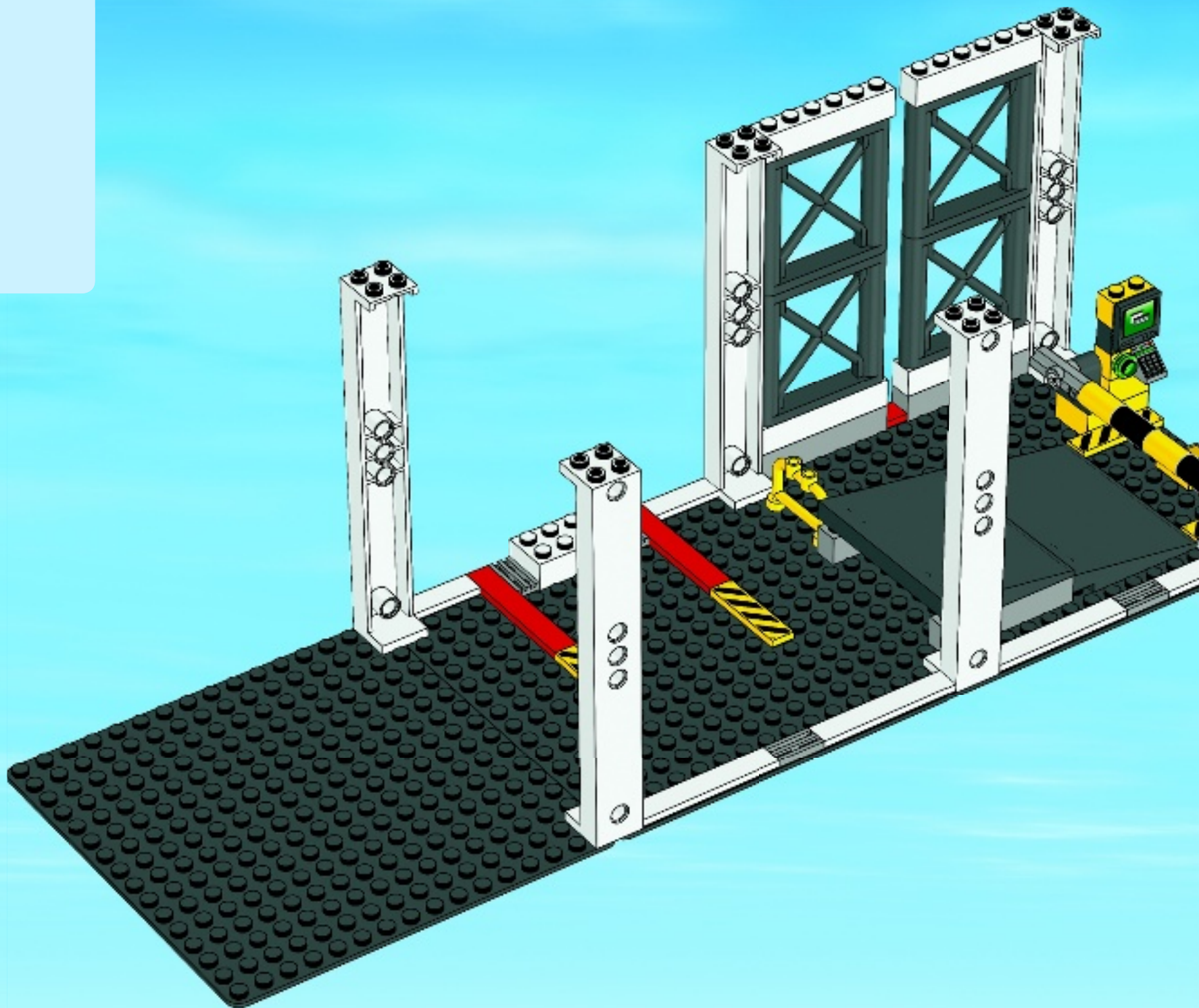

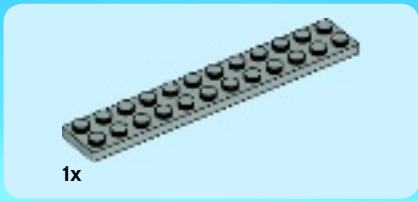

19

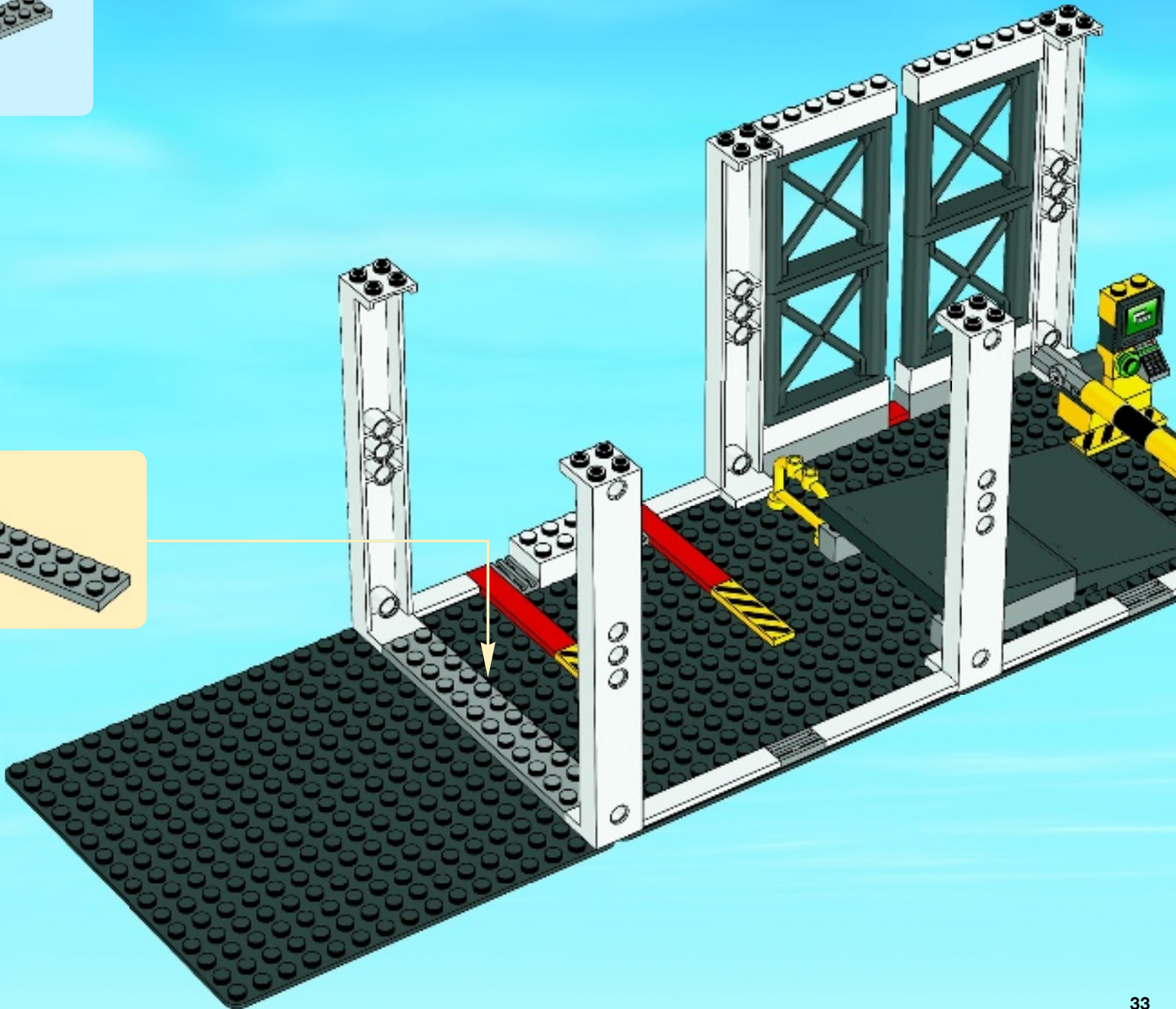
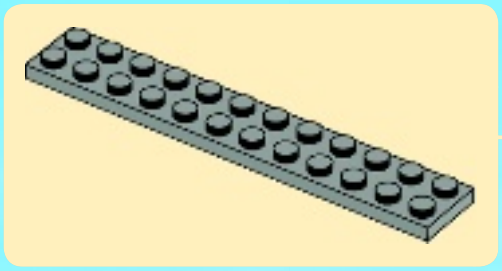





1x



2x

# 20

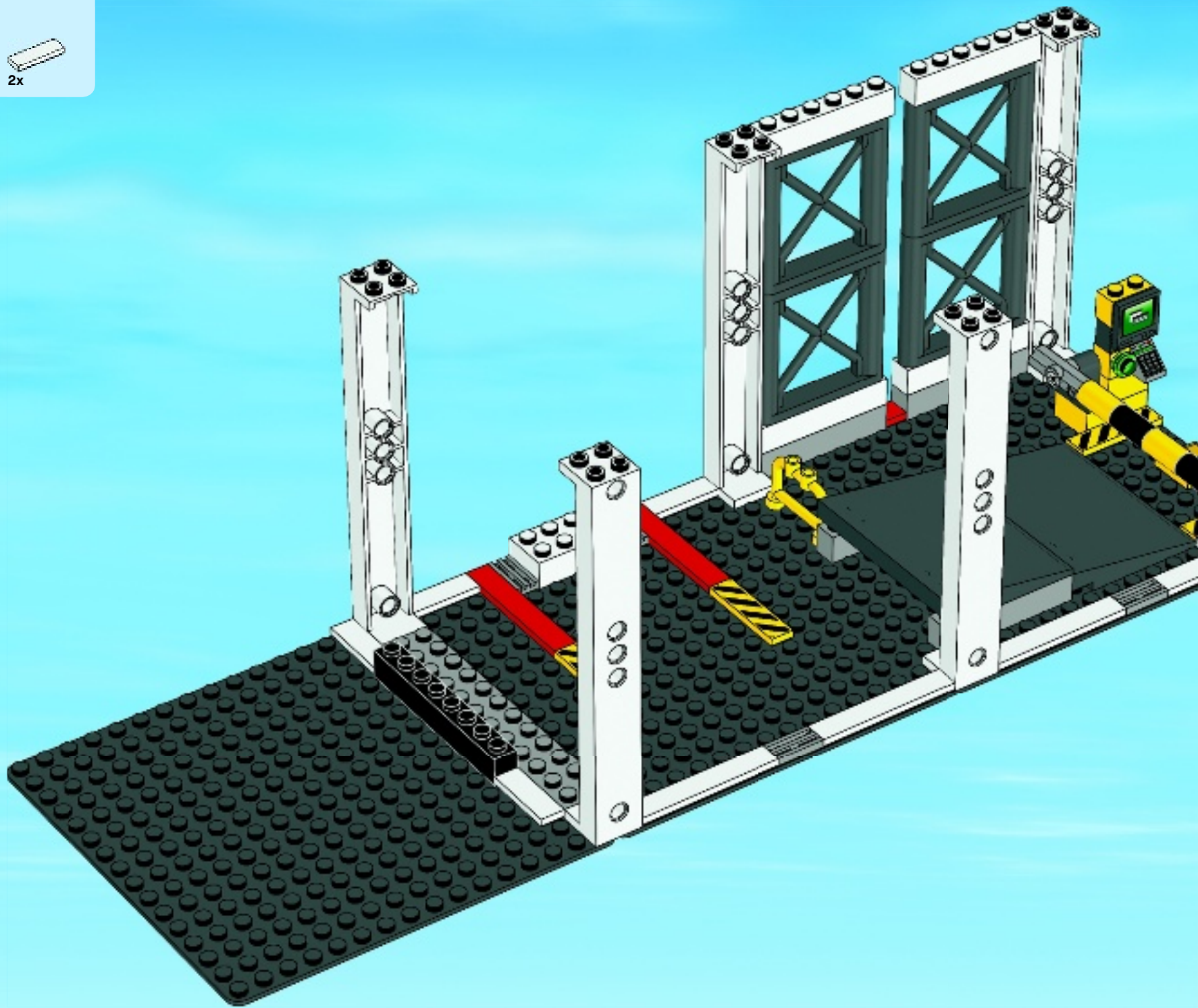







1x



2x

# 22

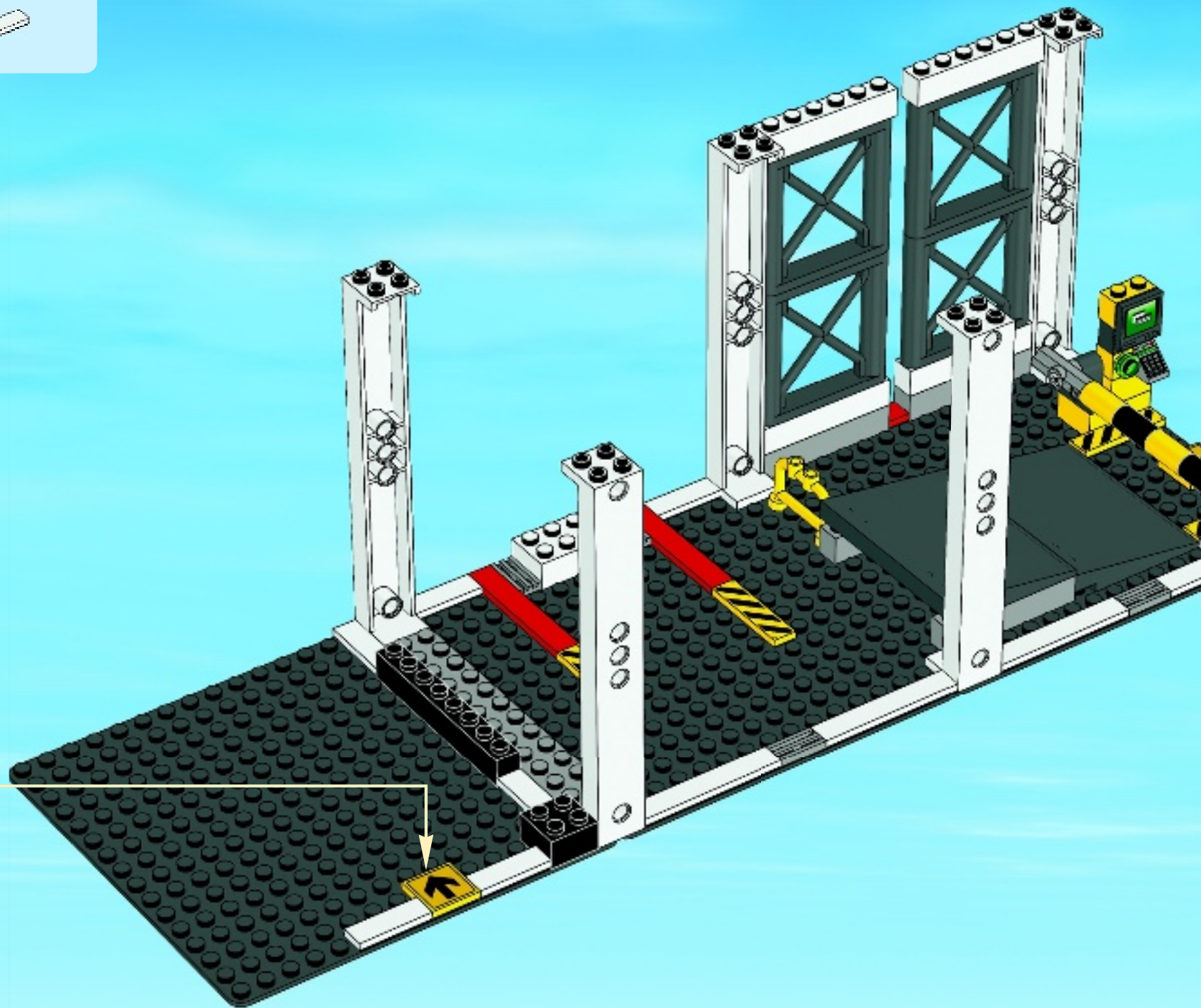
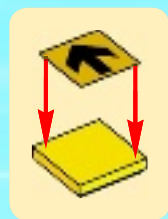





6x

4x

# 24

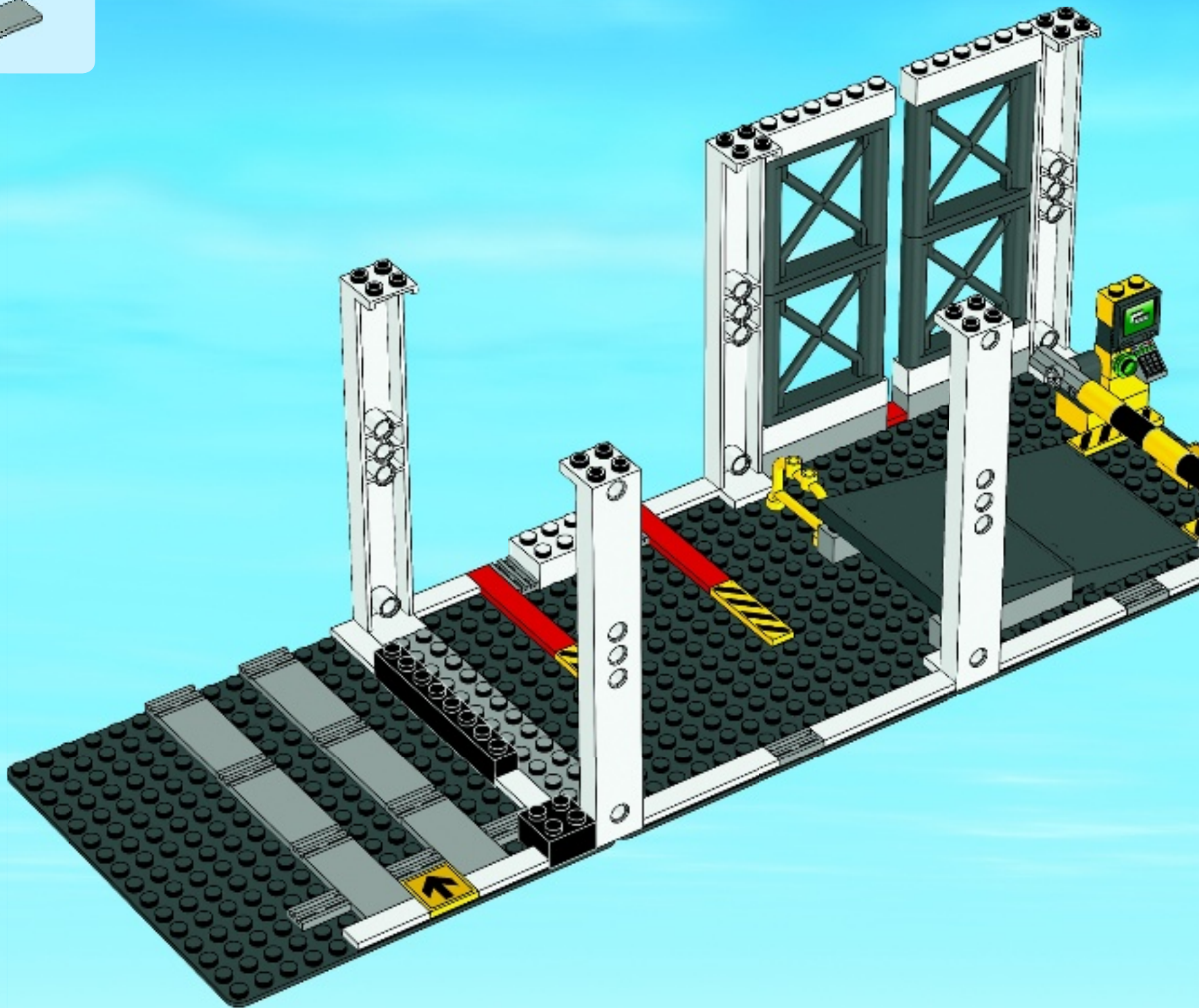





25

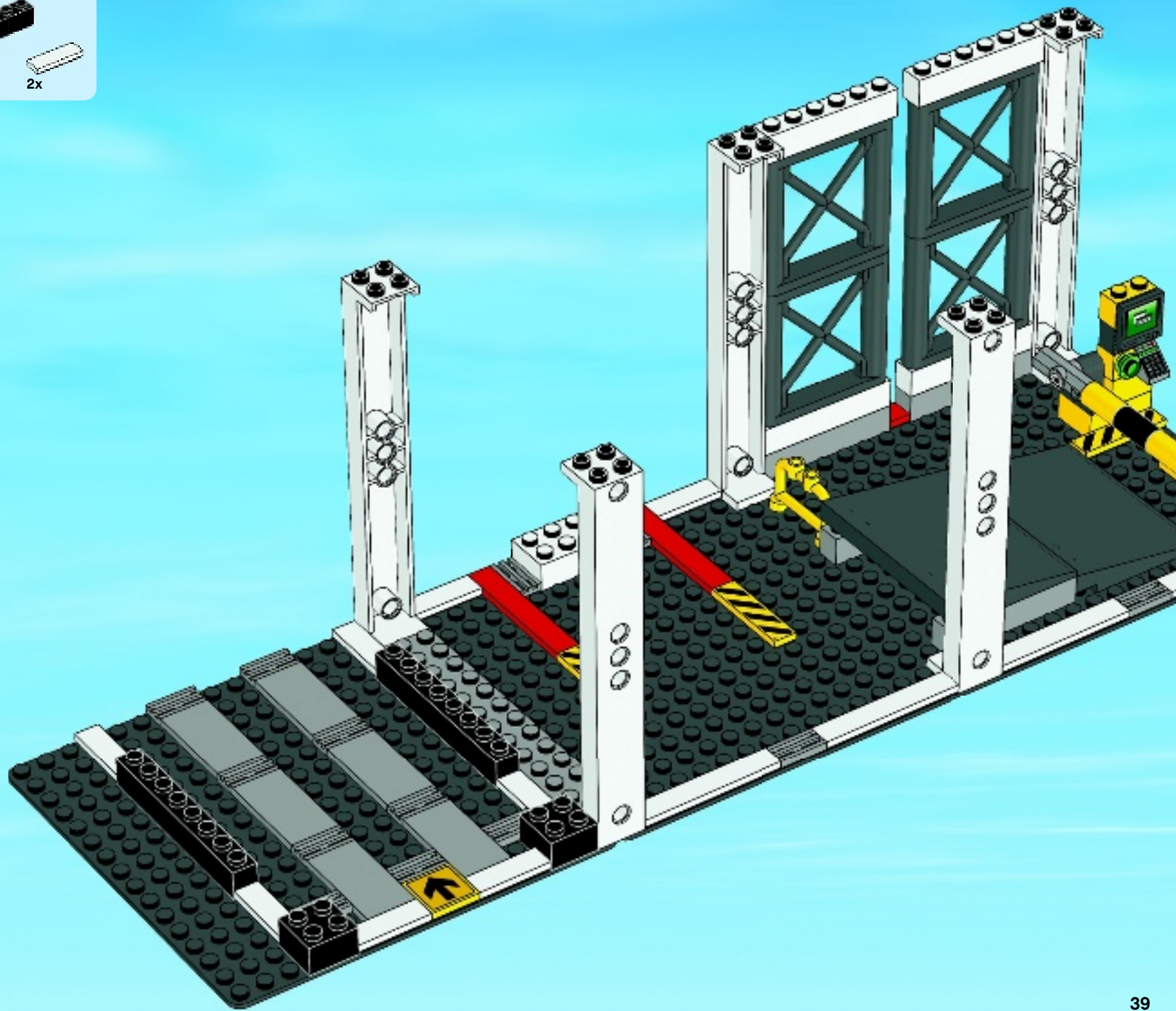



2x

# 26

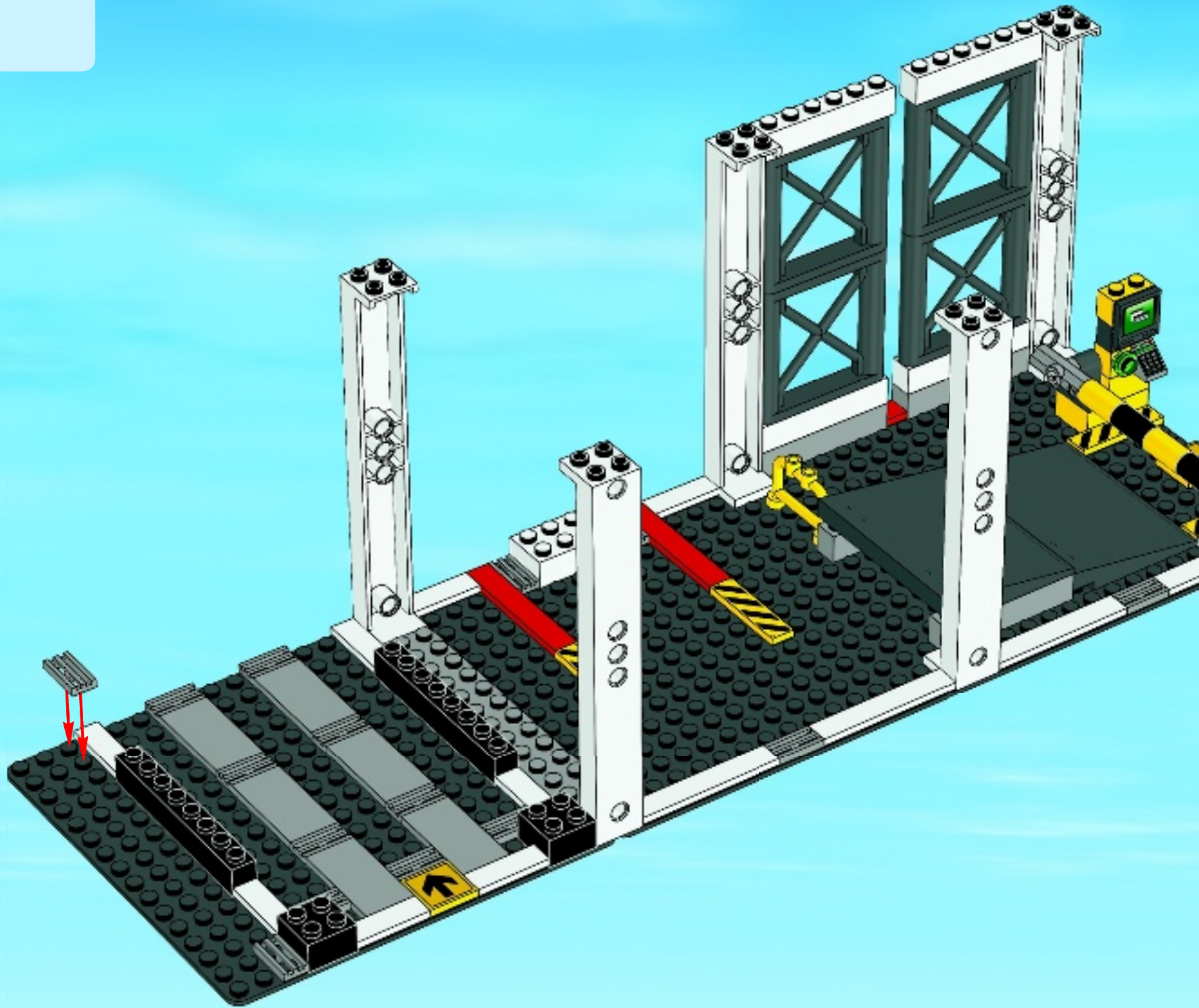





2x

27

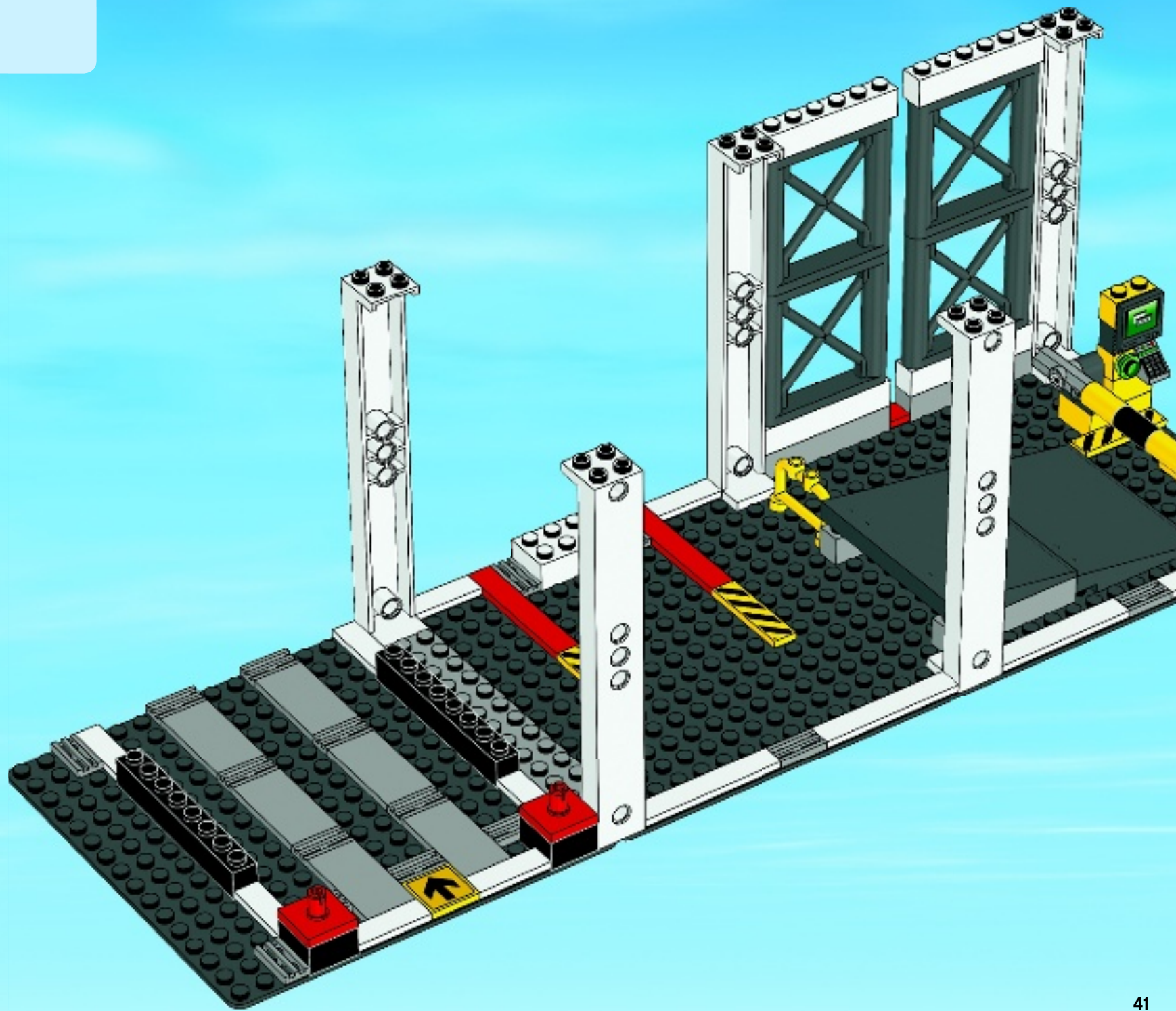

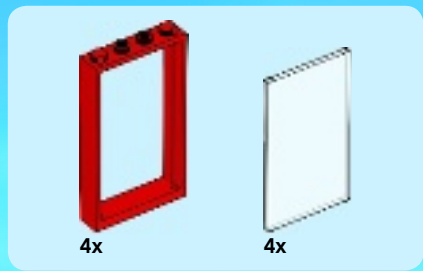

28

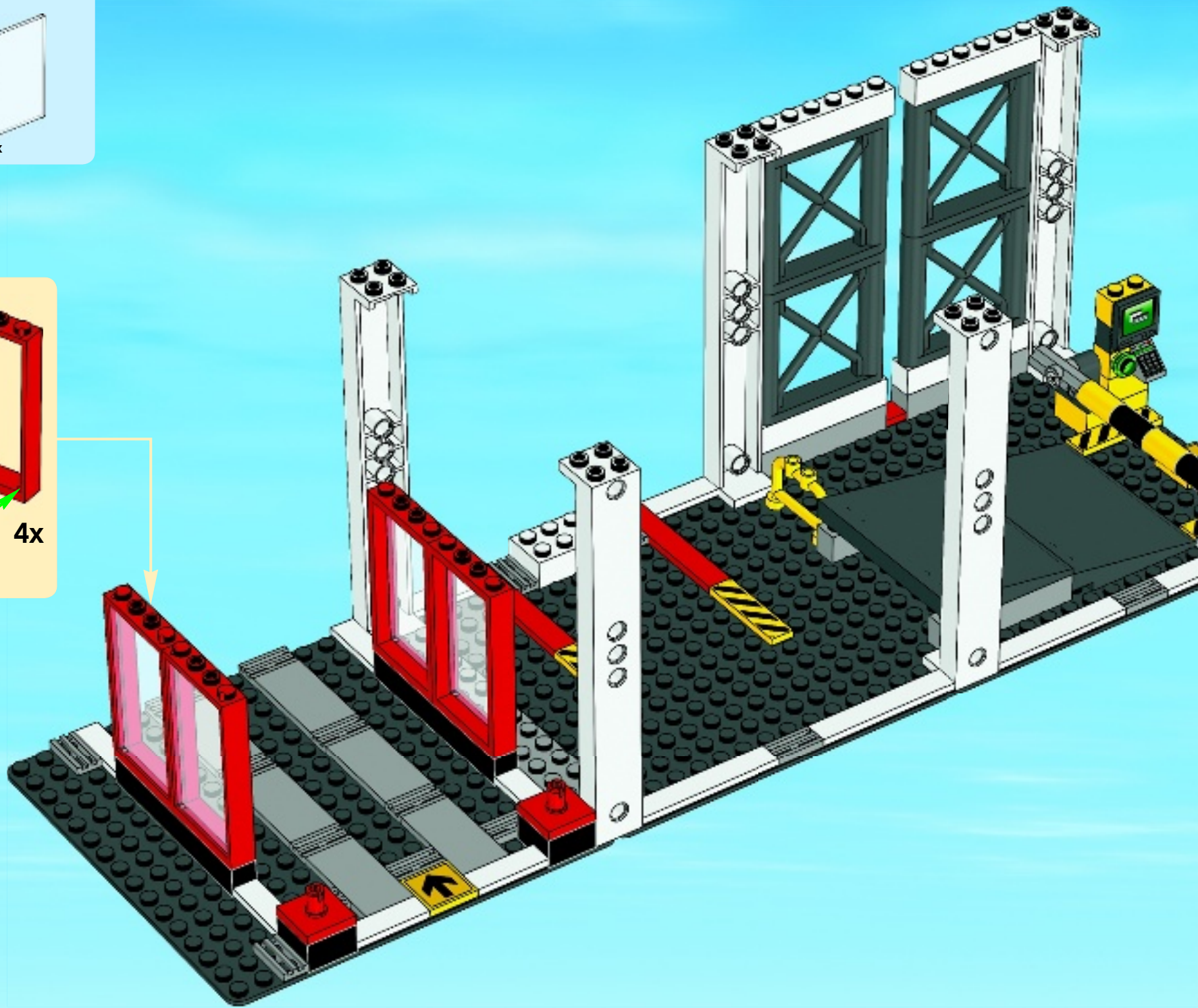
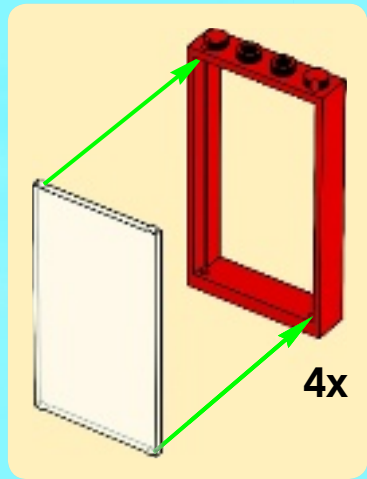





4x

29

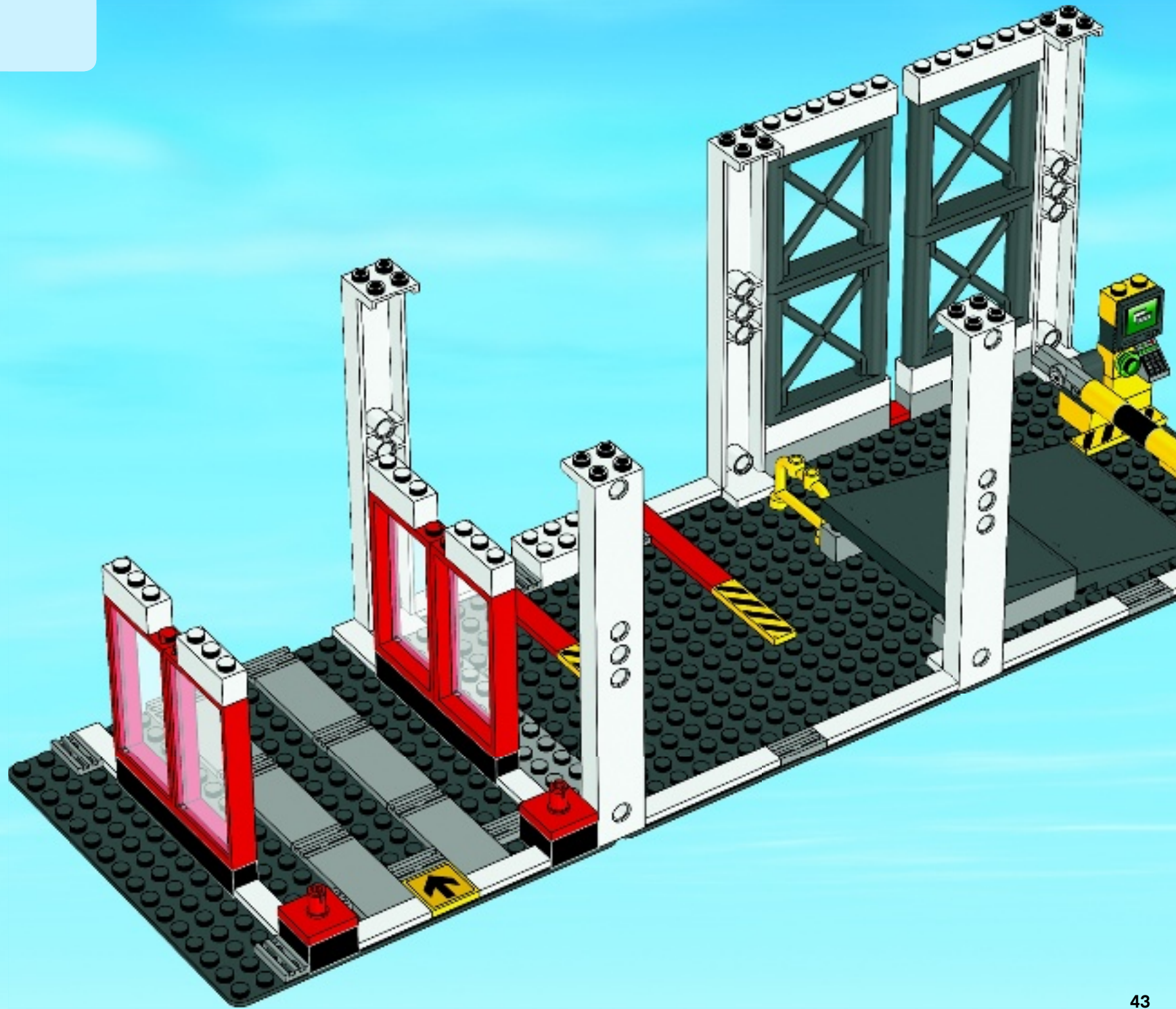

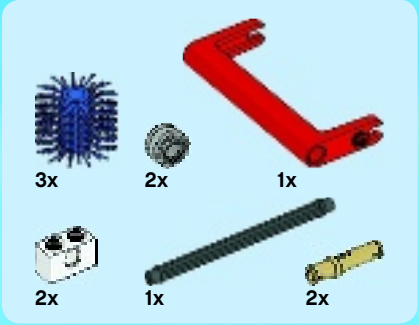

# 30

1

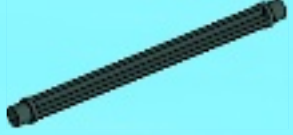

2

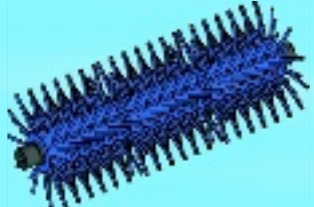

3

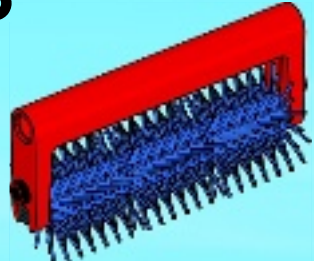



4

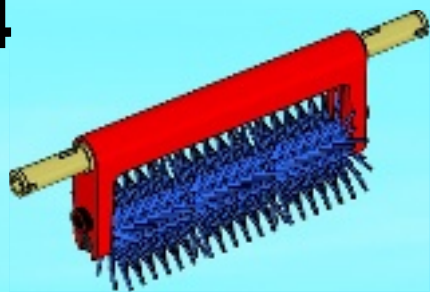

5

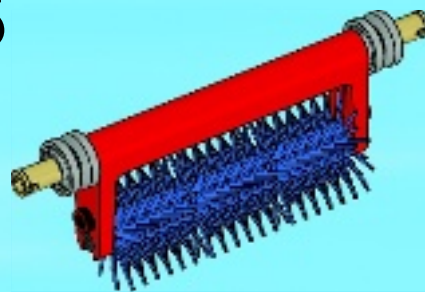

6

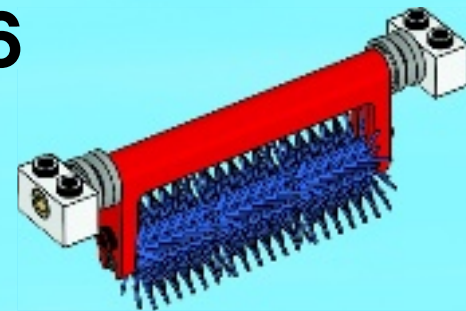

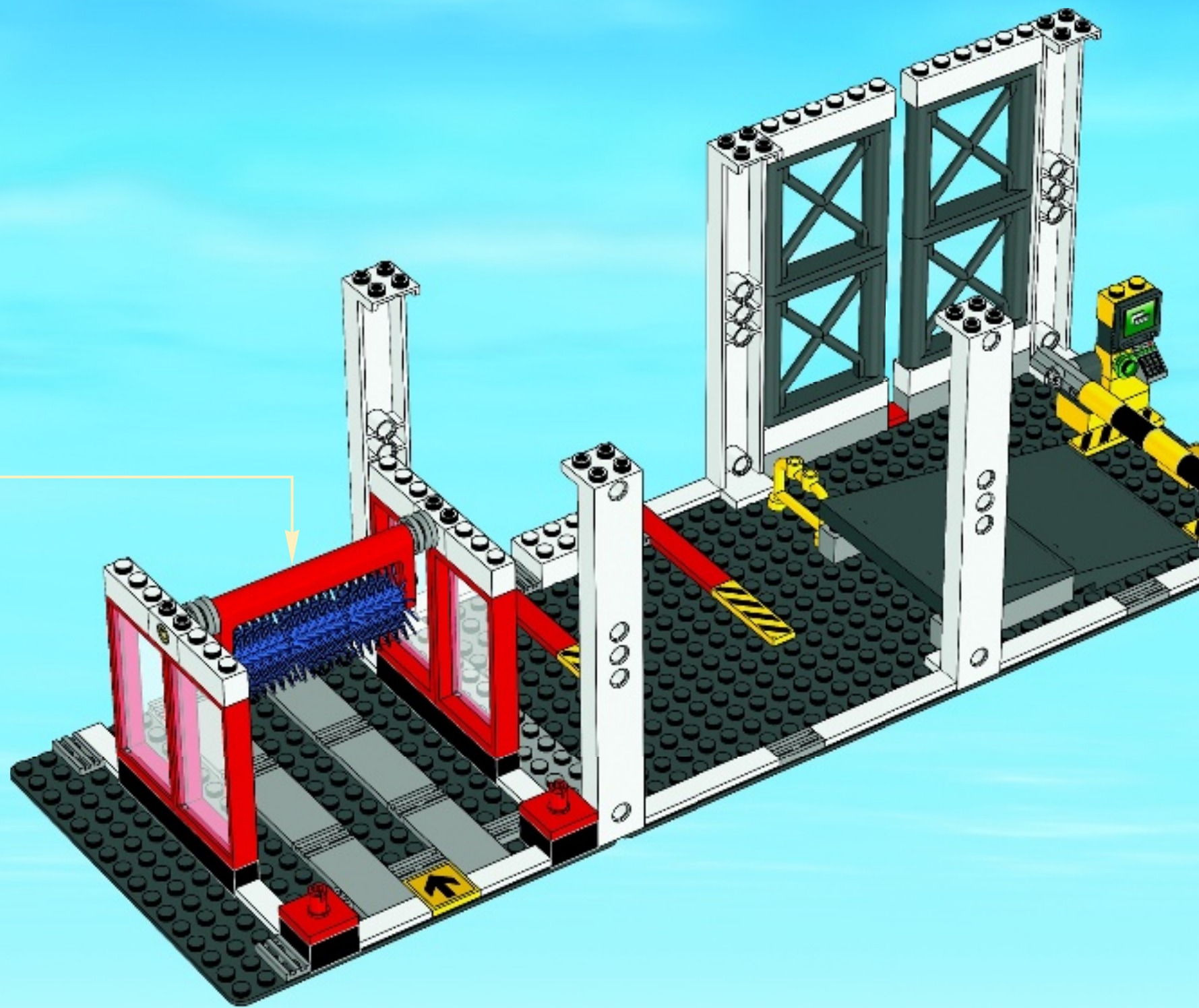

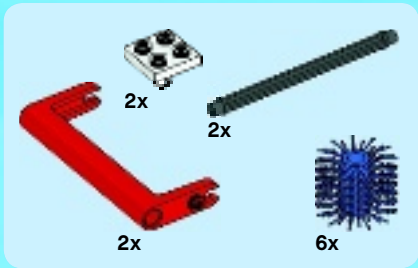

# 31

1



2



3

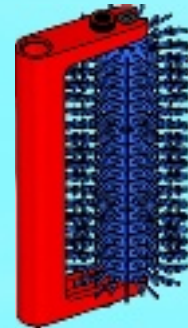



4

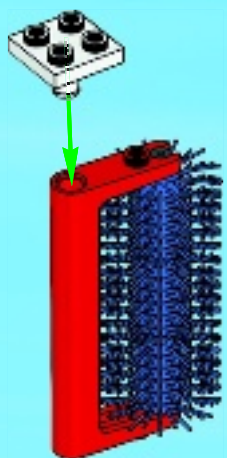

2x

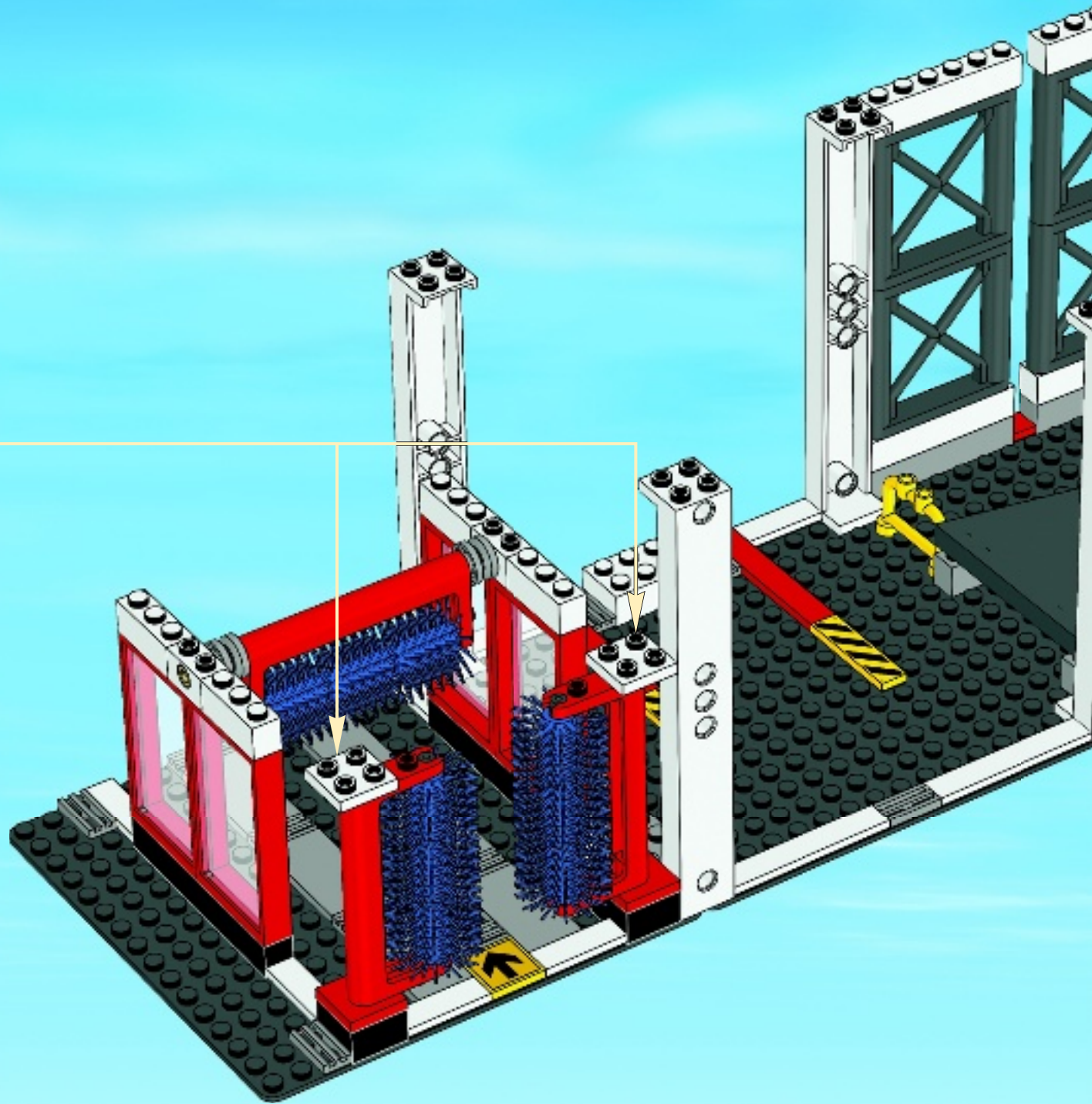





32

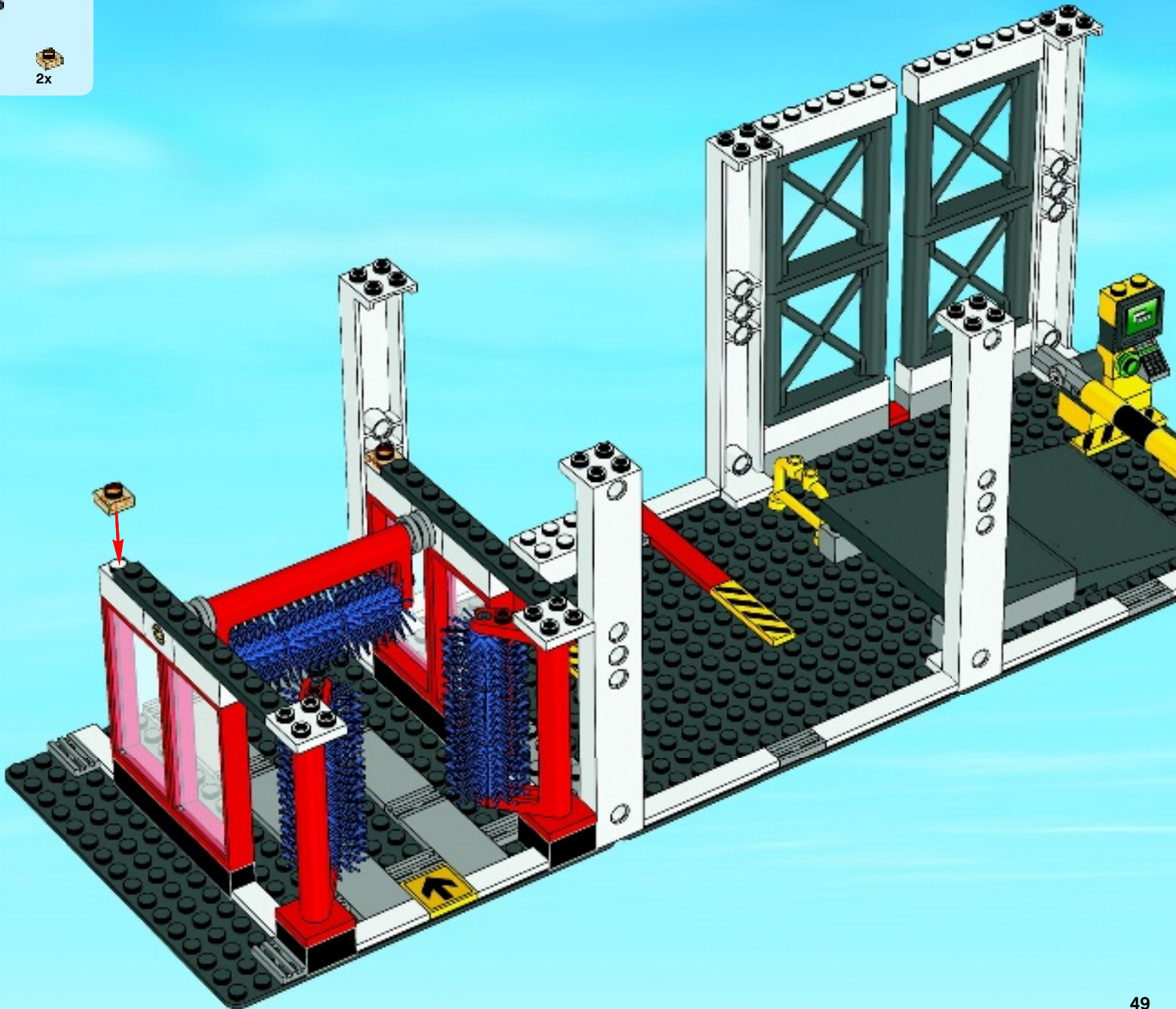



2x

# 33

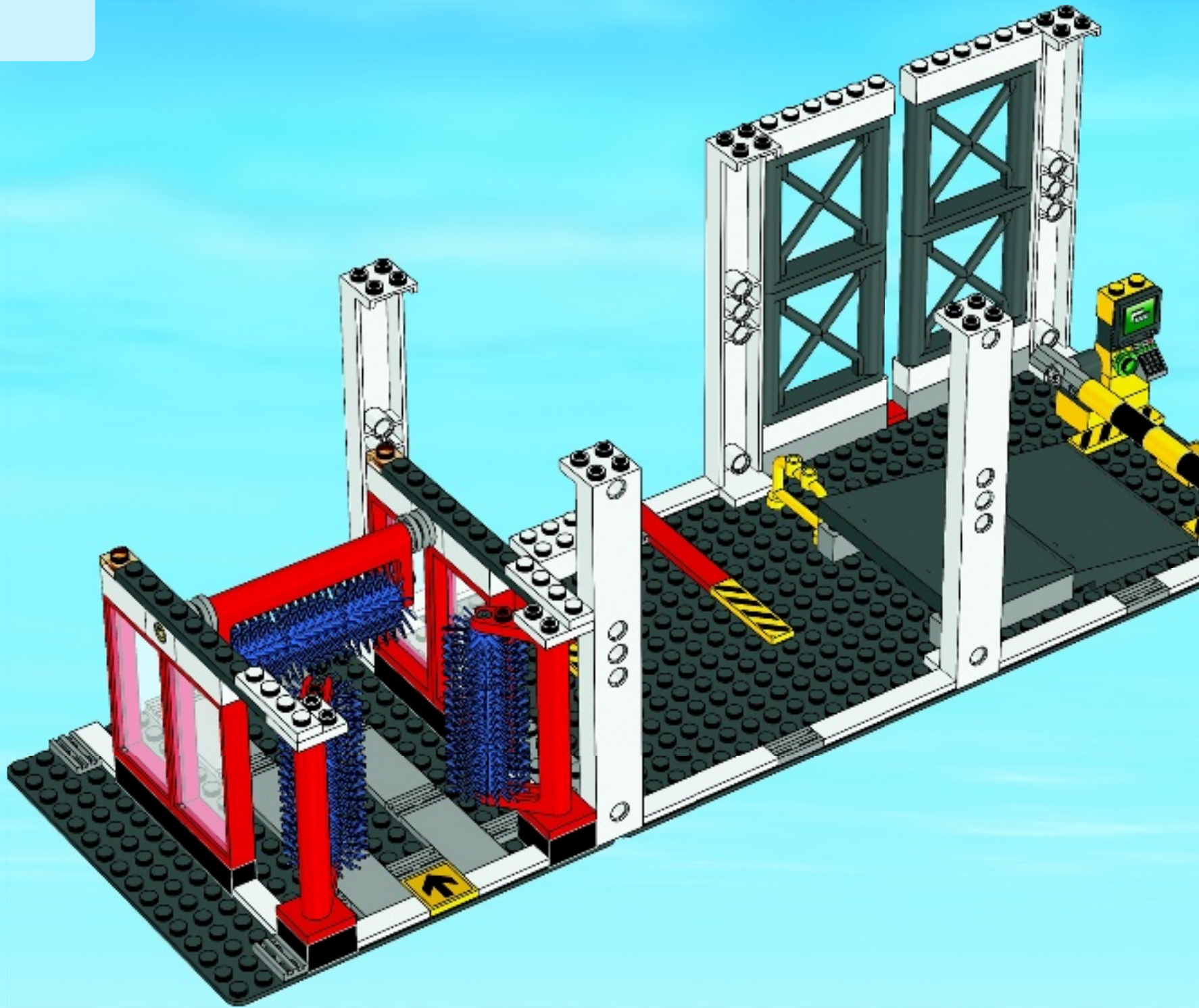



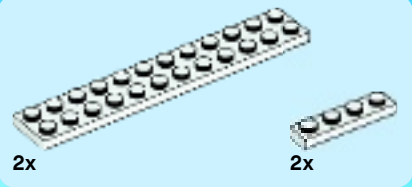

34

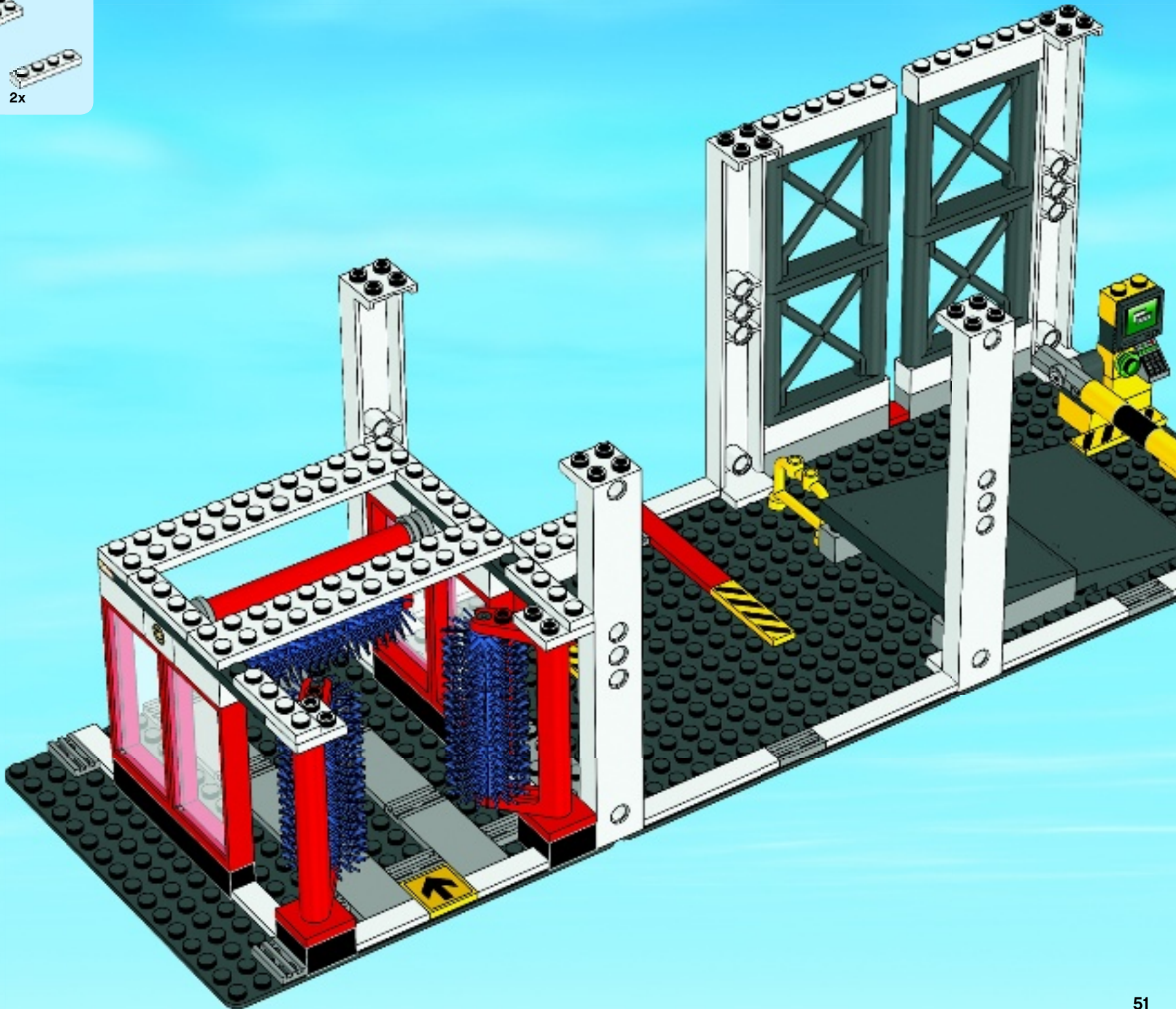



2x

# 35

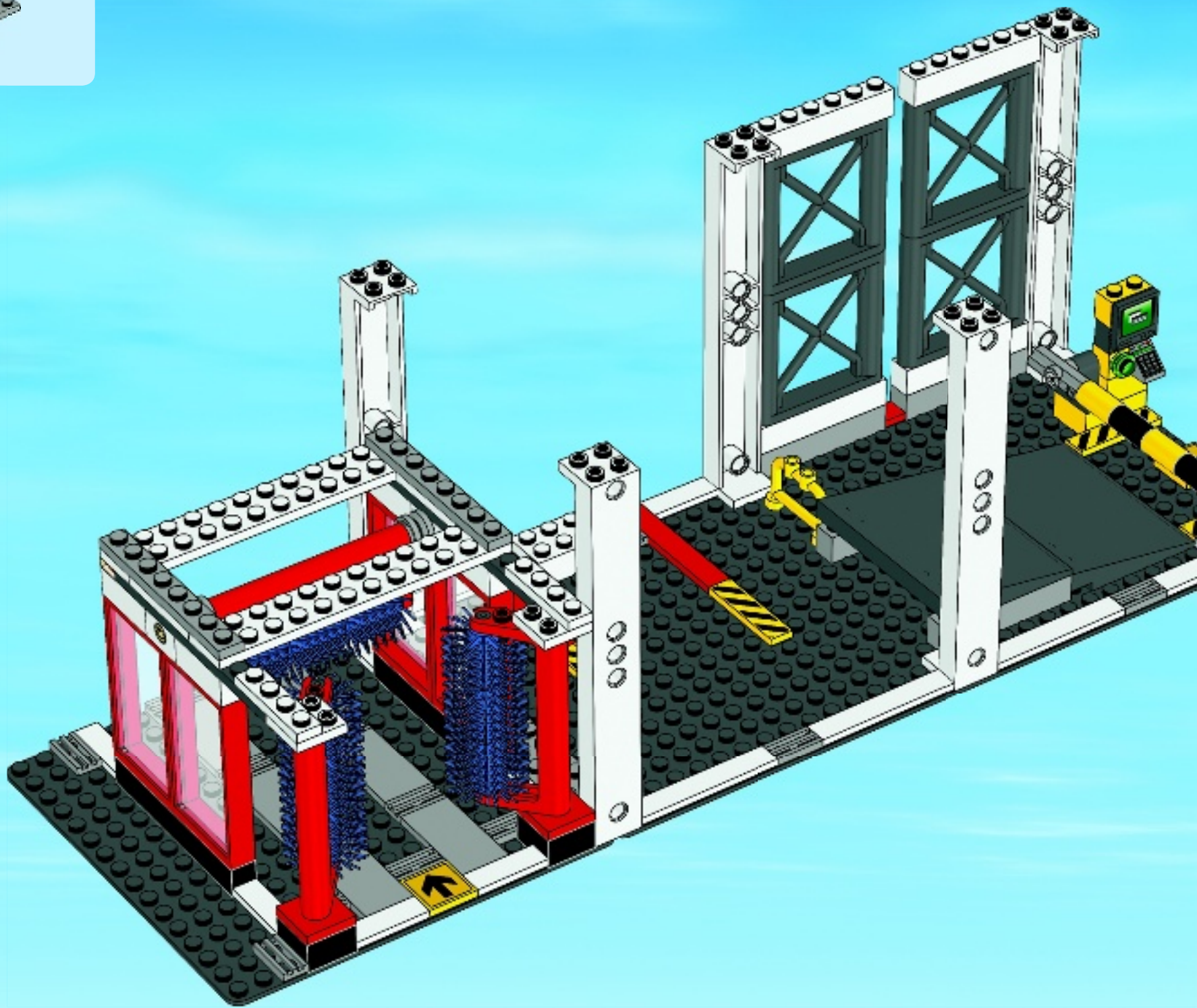





2x

36

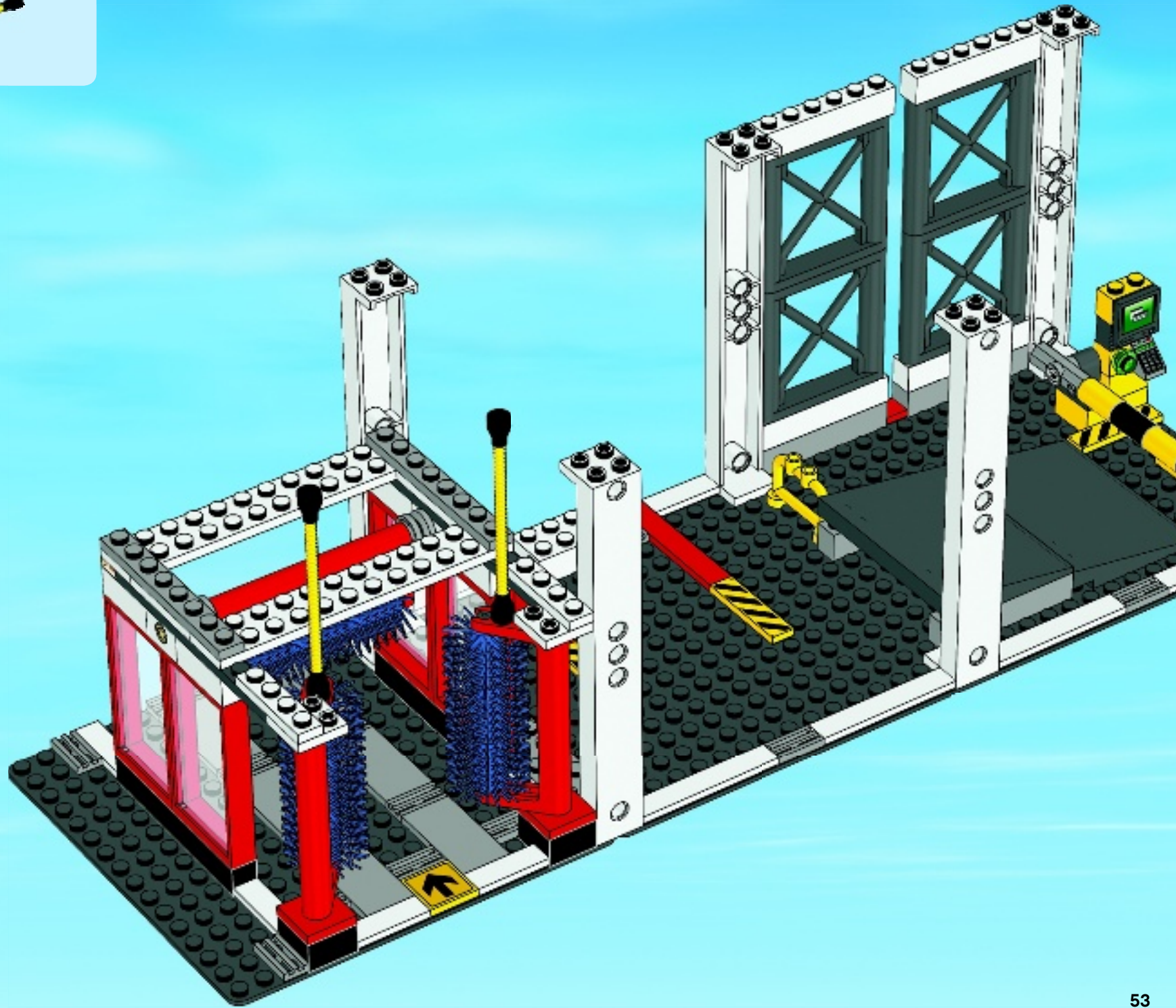

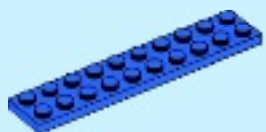

1x

37

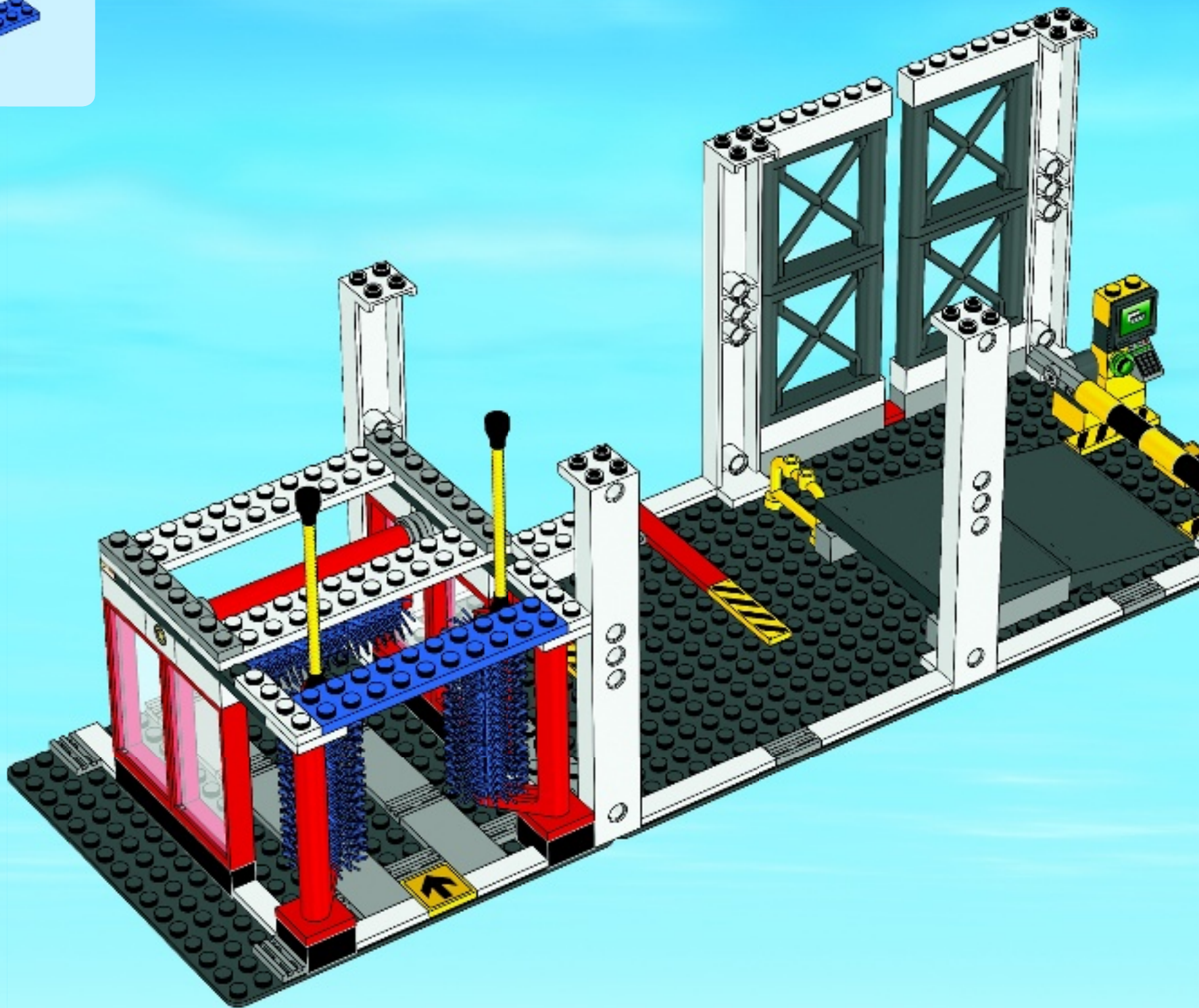



38

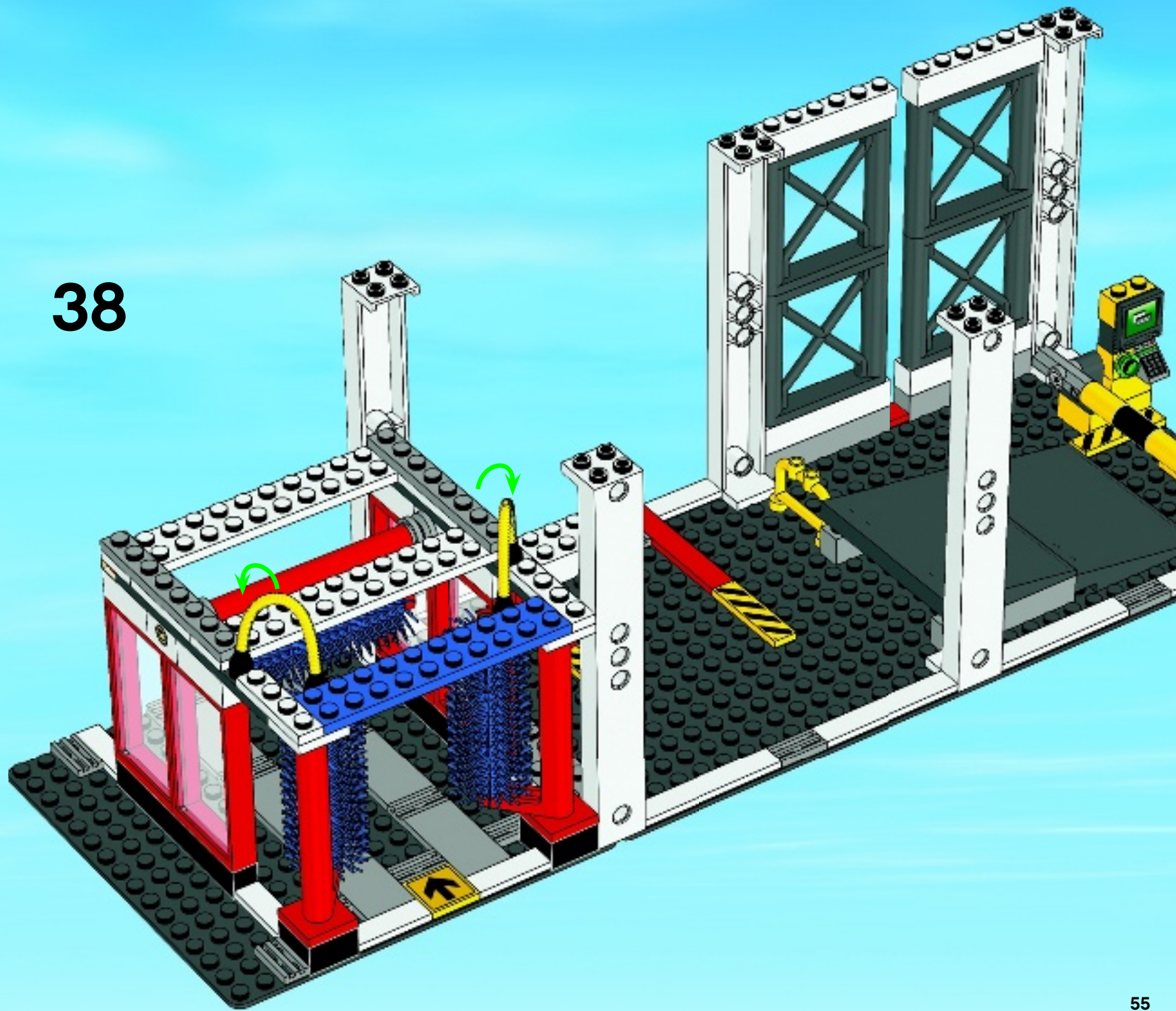



2x

# 39



2x

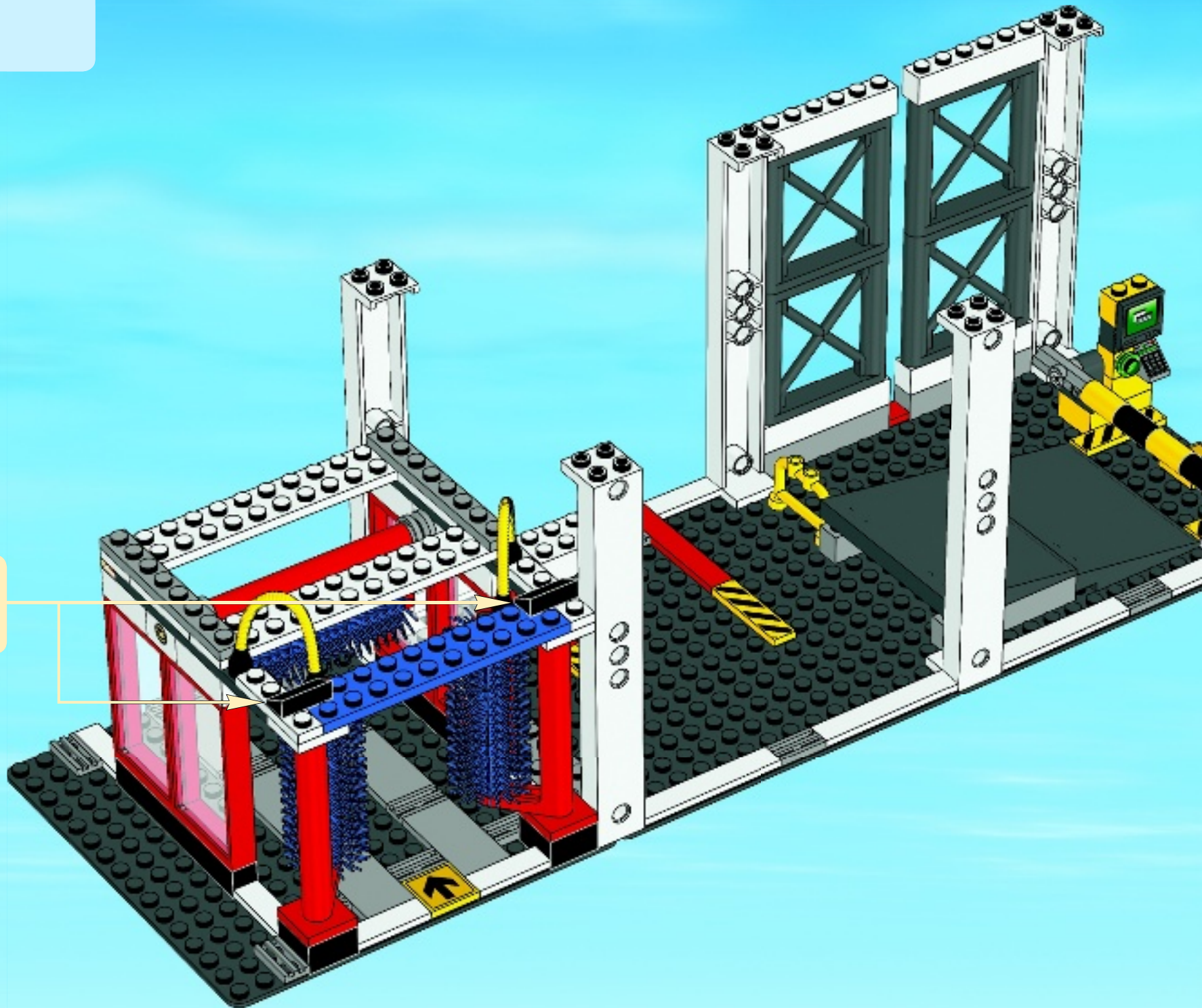





2x

40

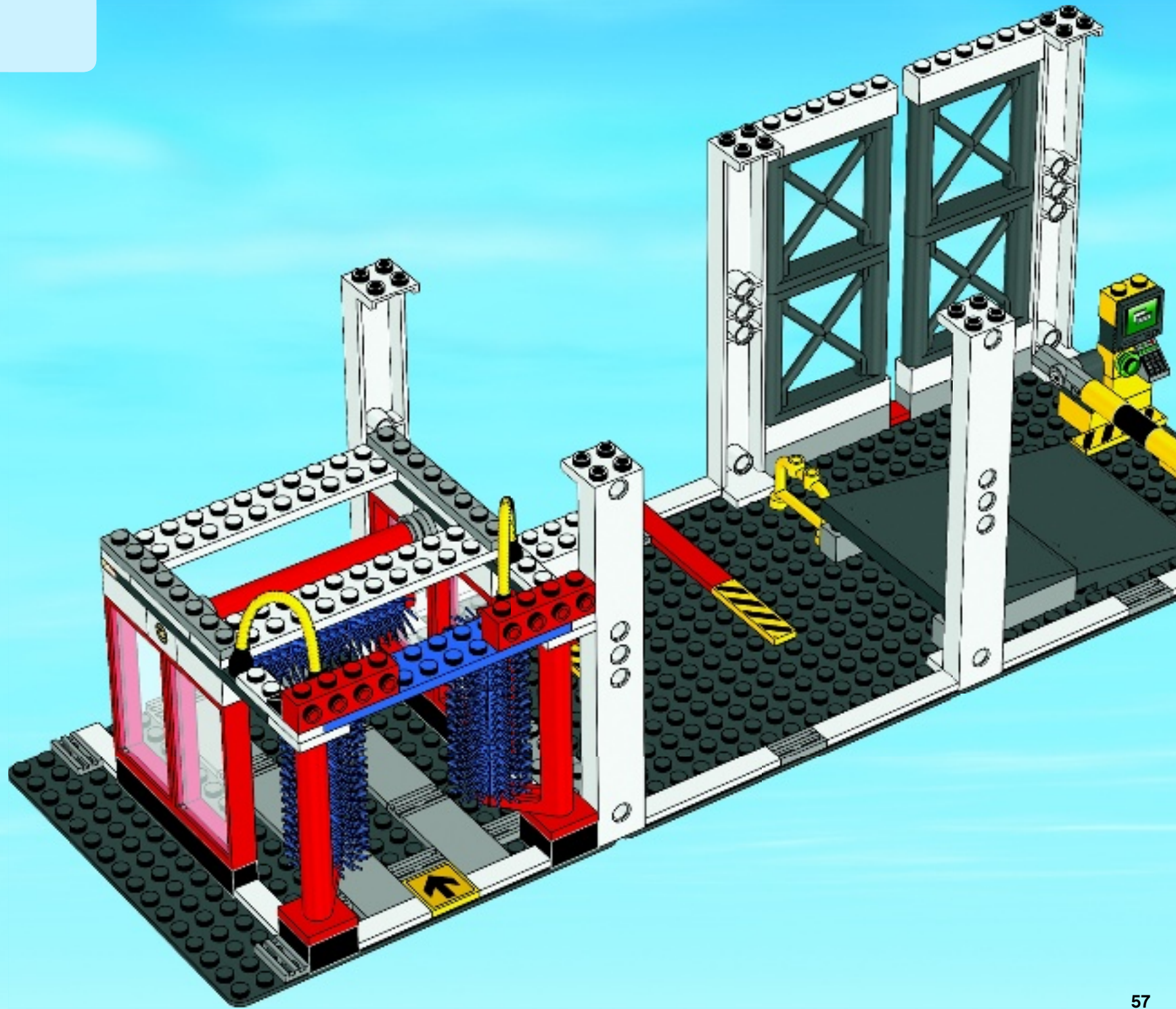

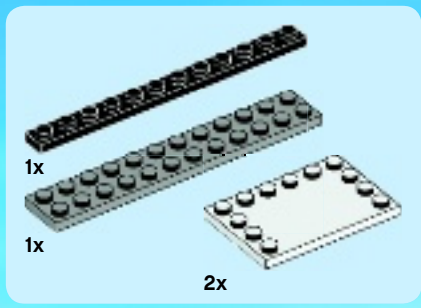

# 41

1

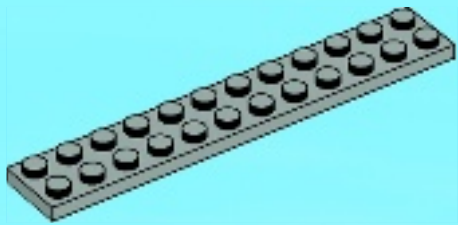

2

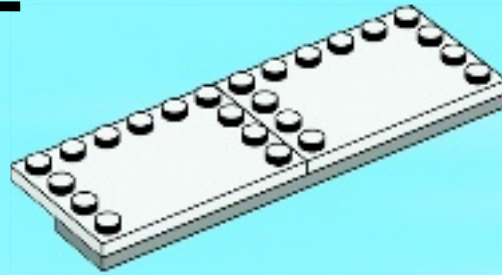

3

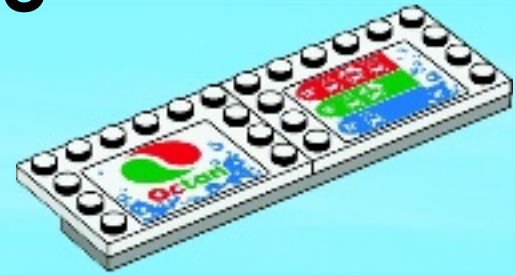



4

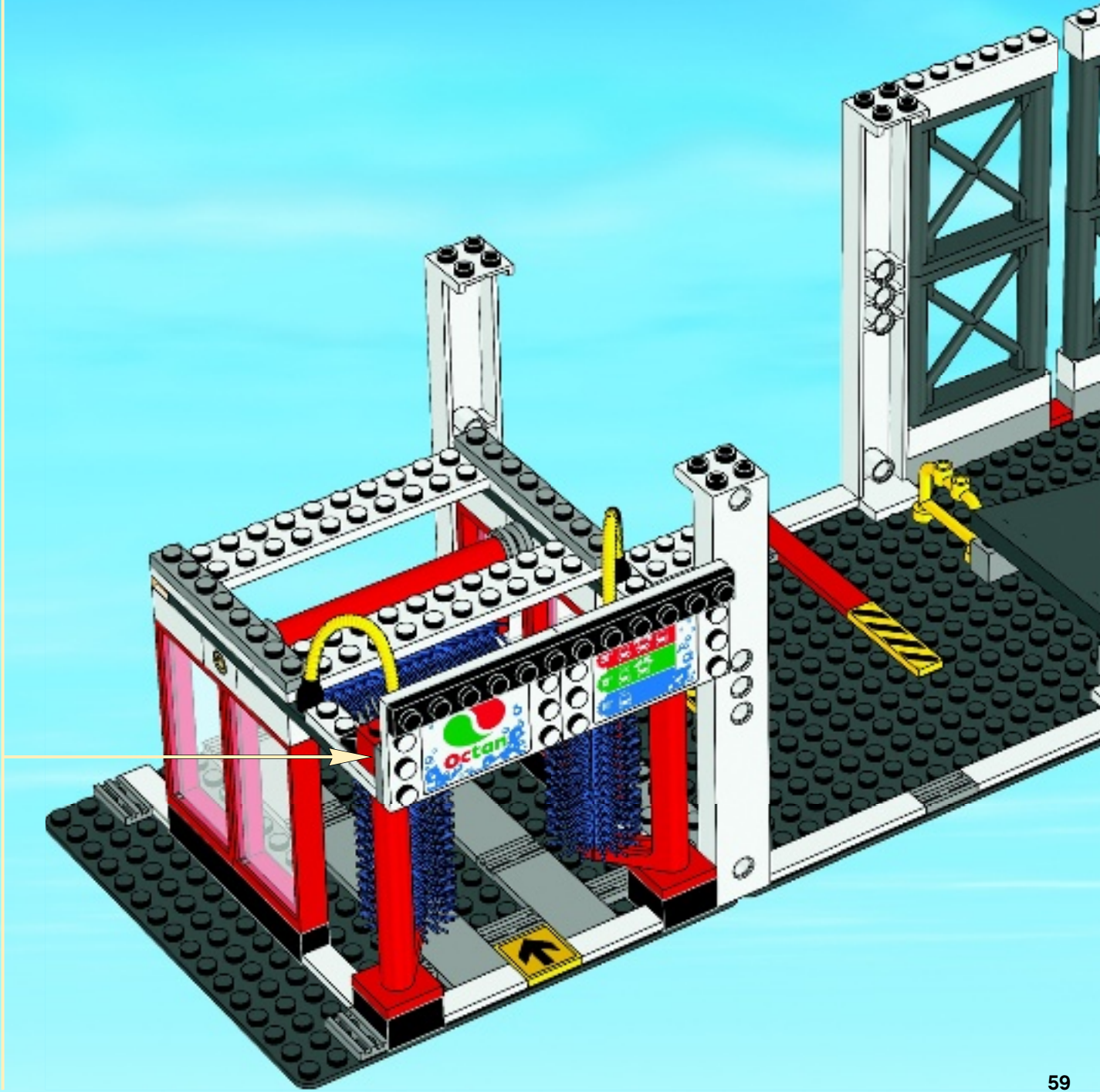
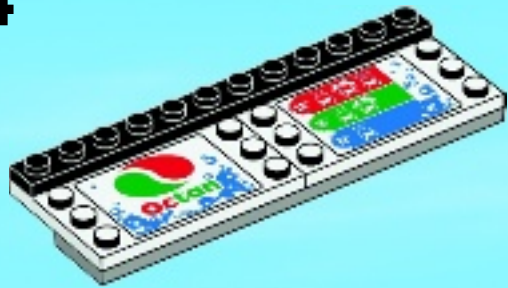

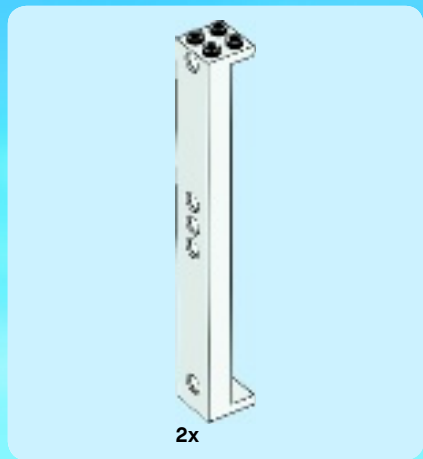

42

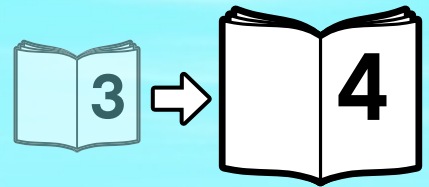
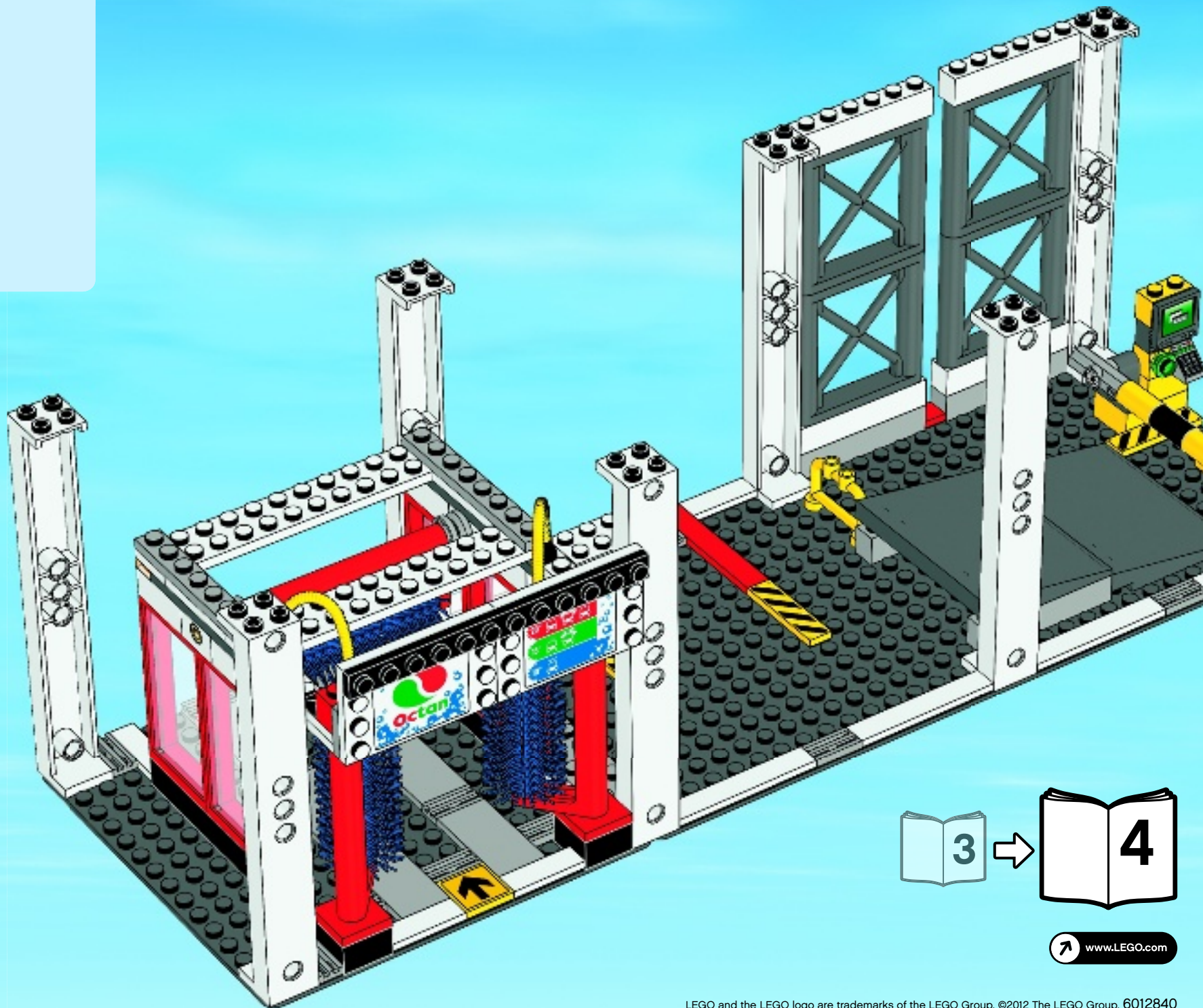



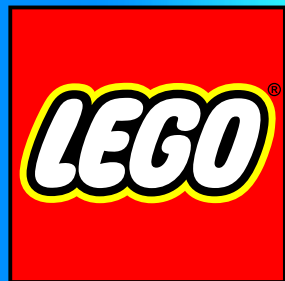

4207

# CITY





+



5

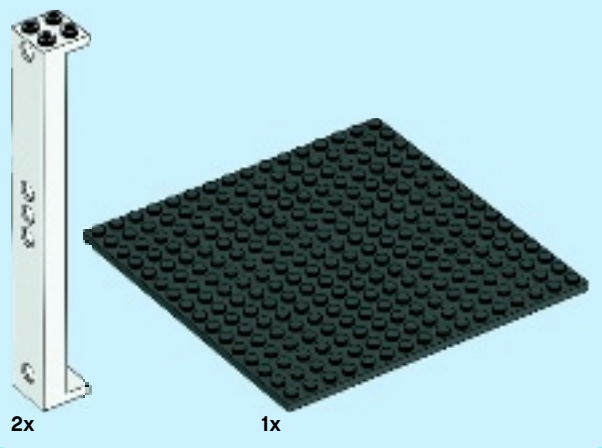
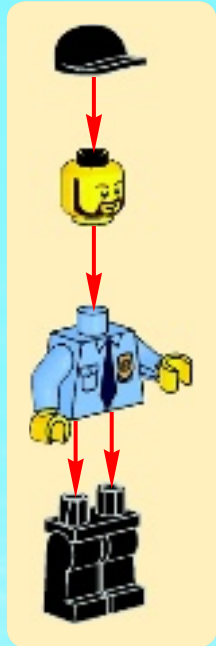

1

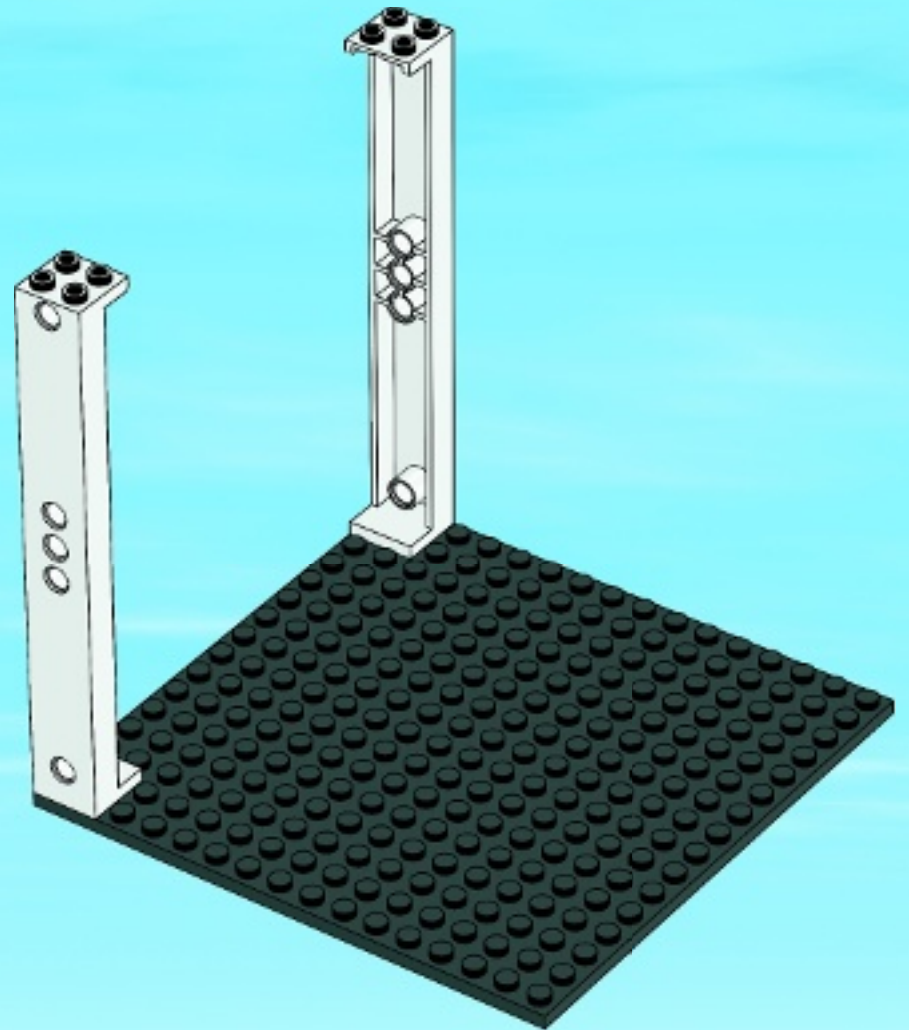



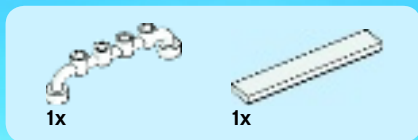

2

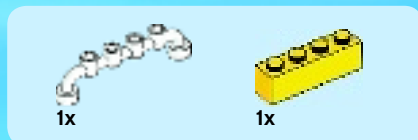
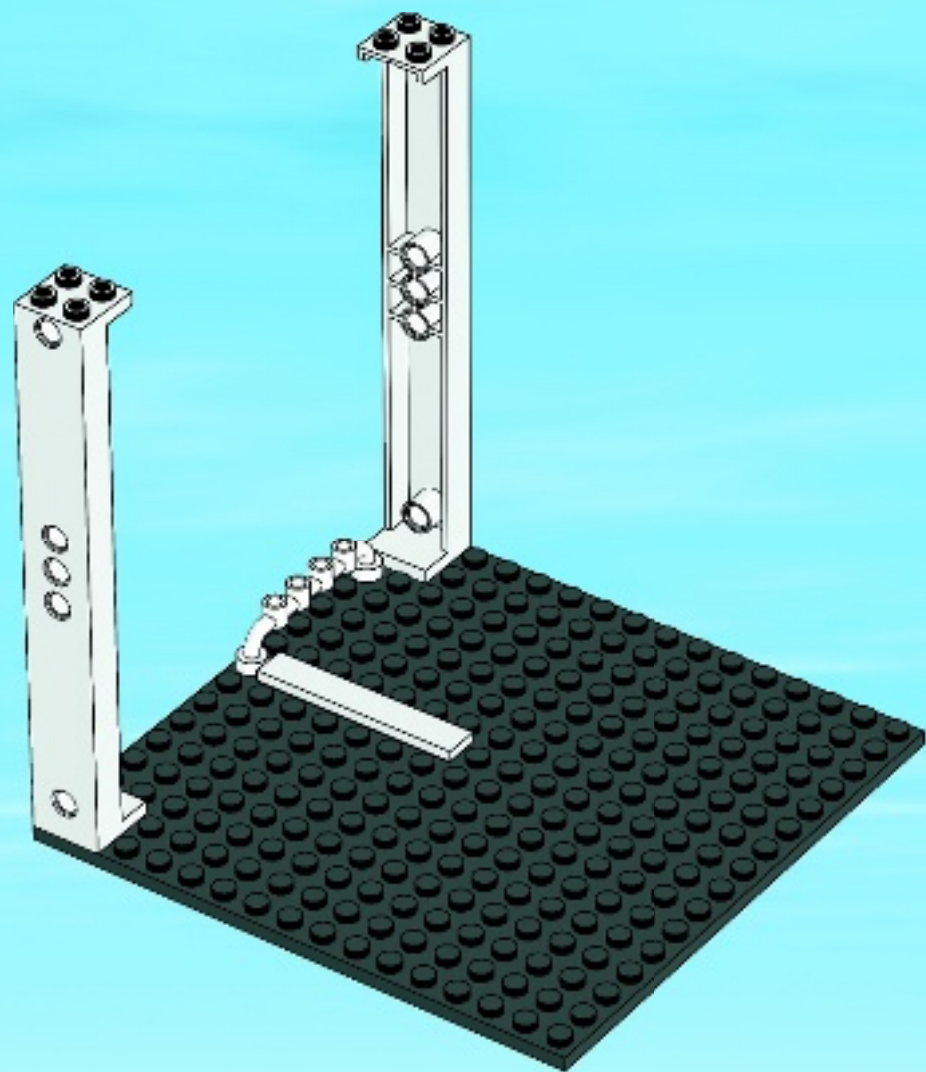

3

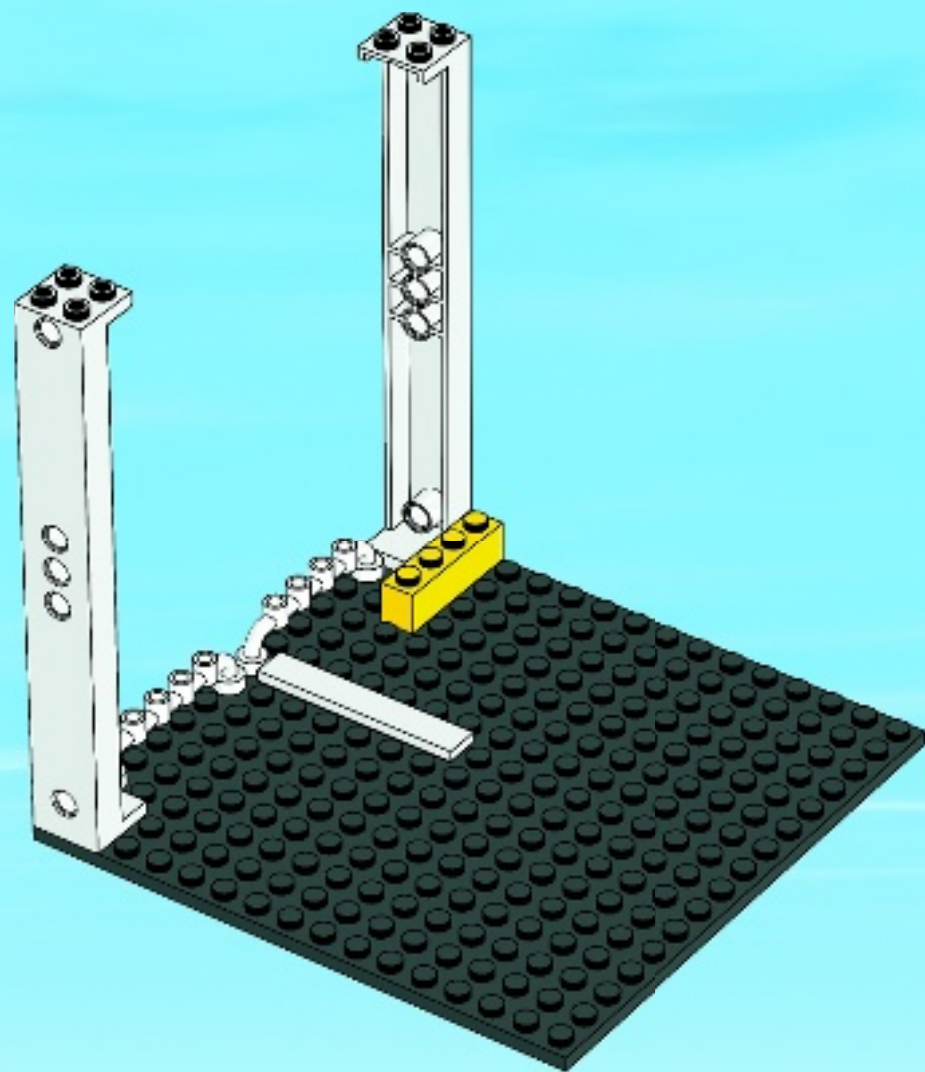

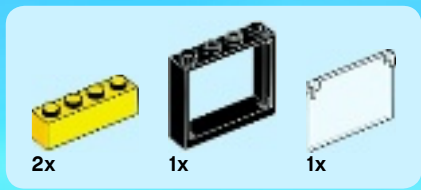

4

1

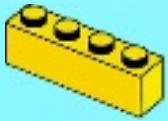

2



3

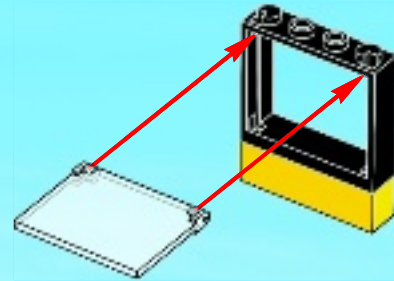



4

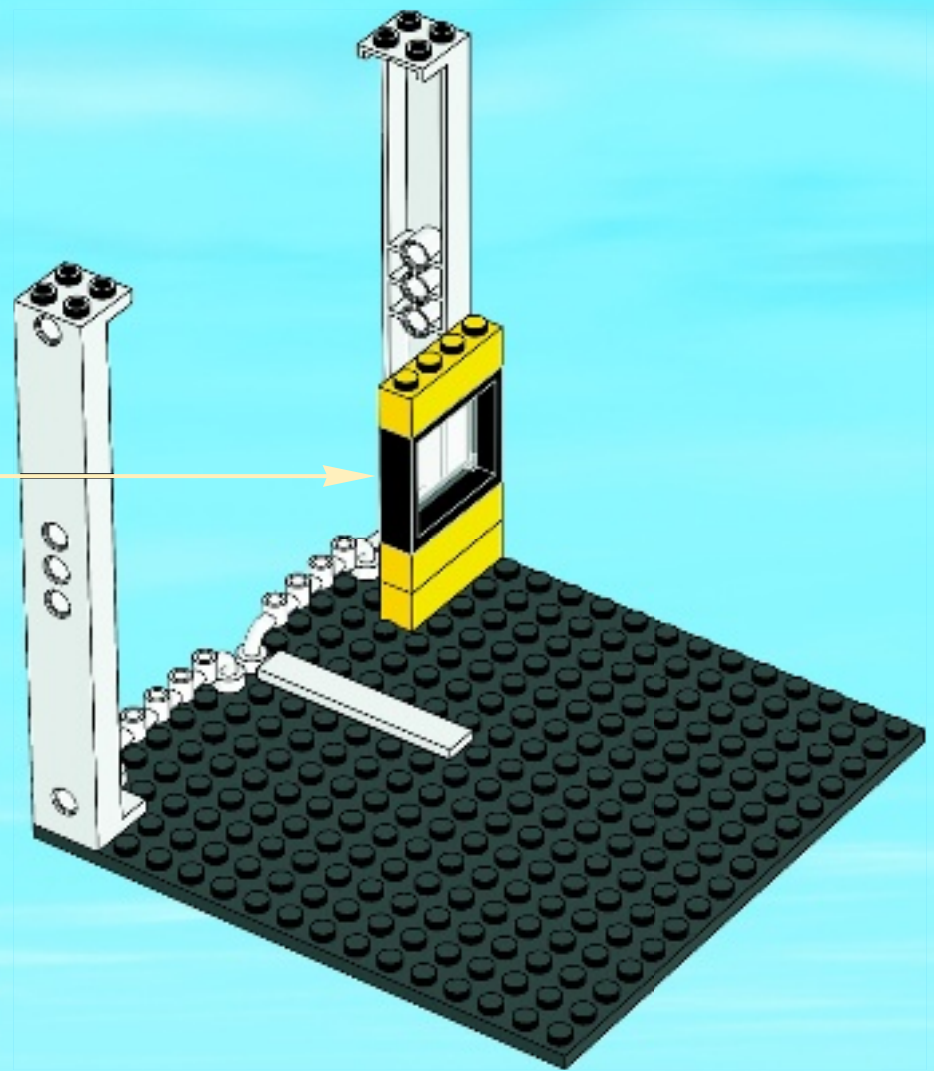

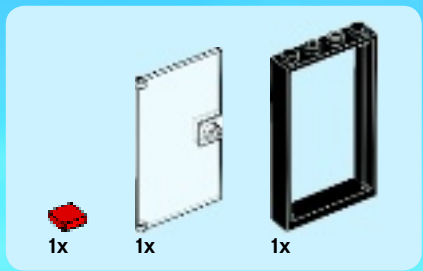

5

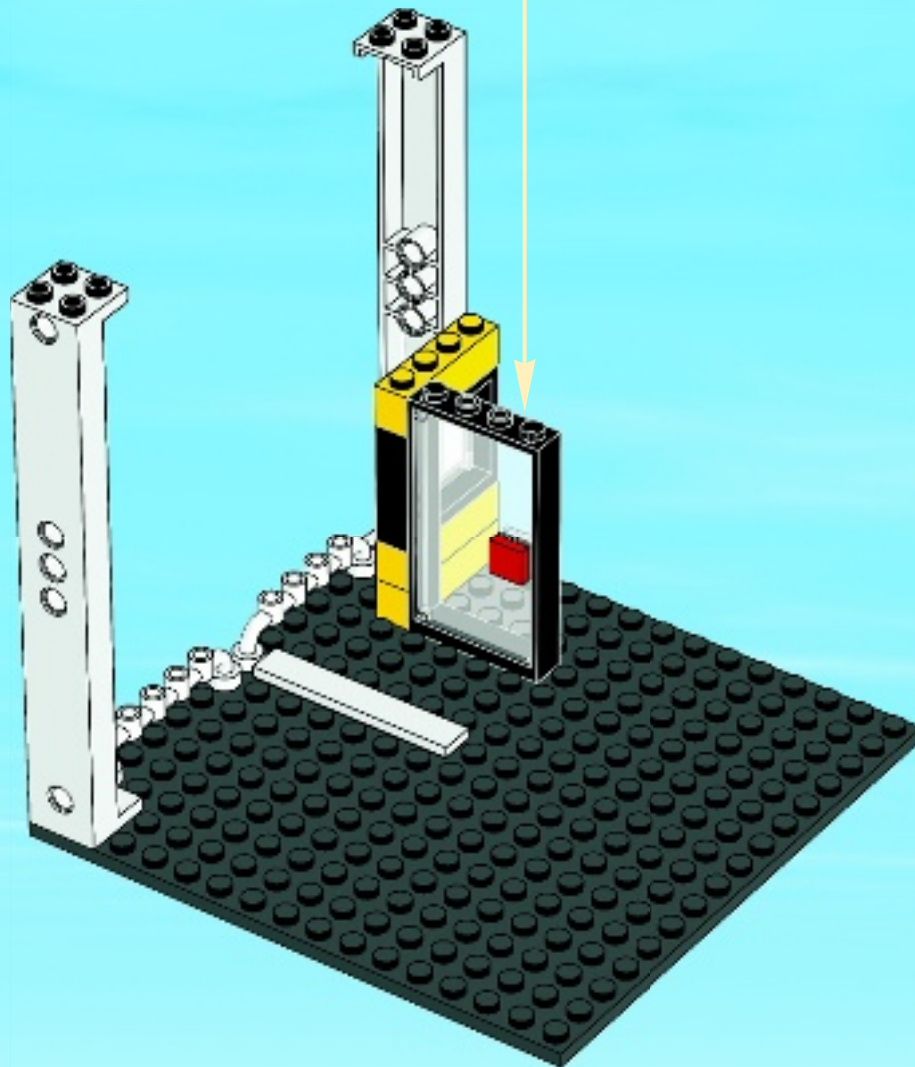
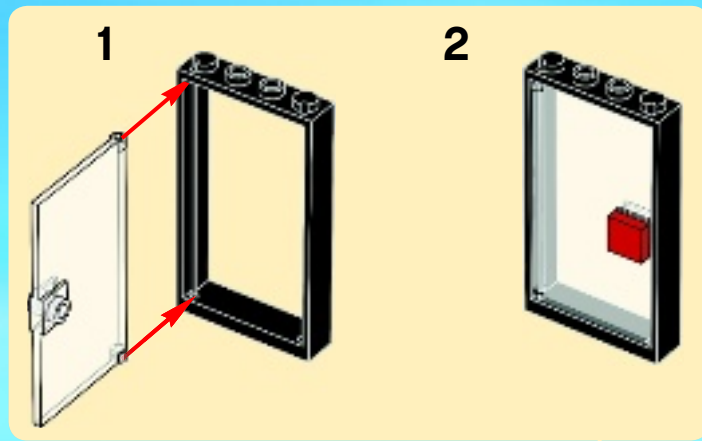



6

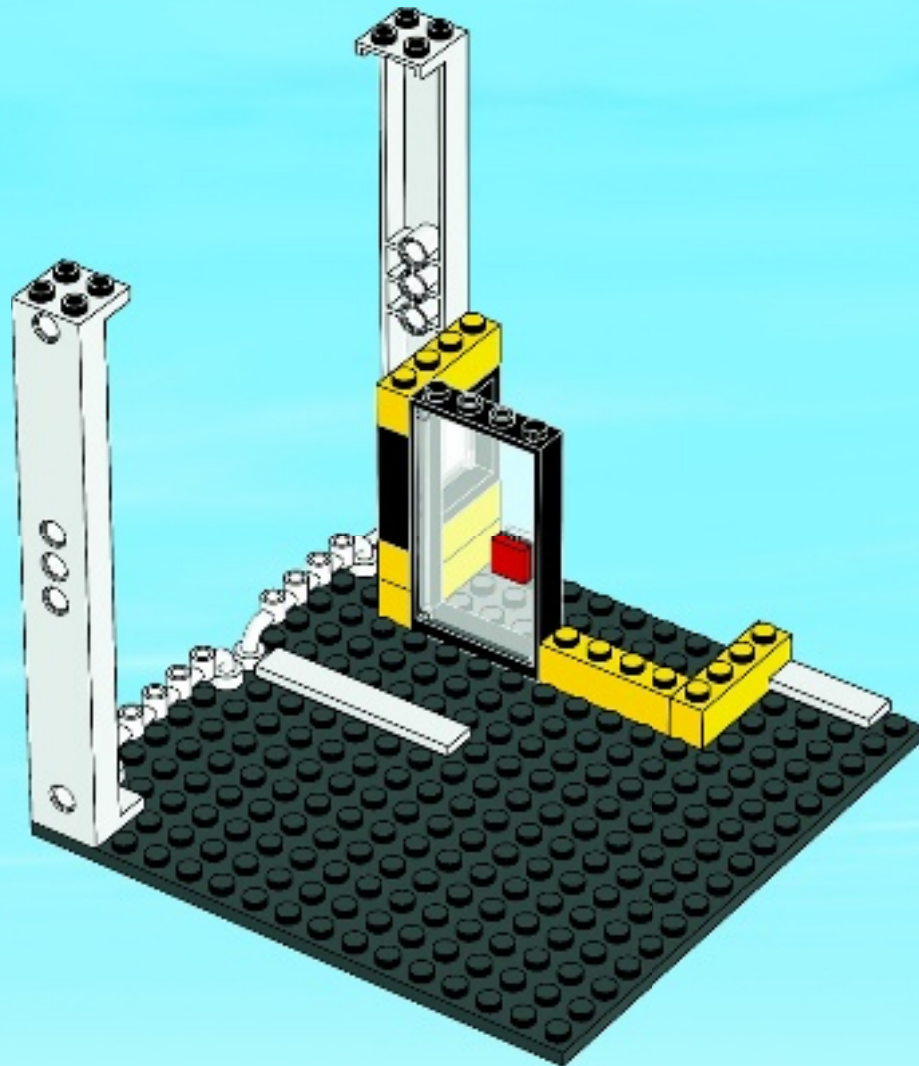

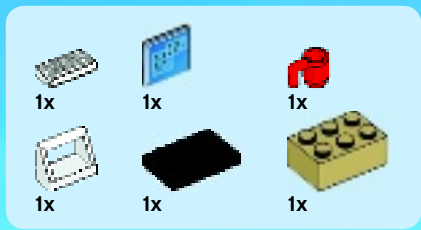

7

1

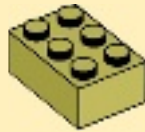

2



3



4

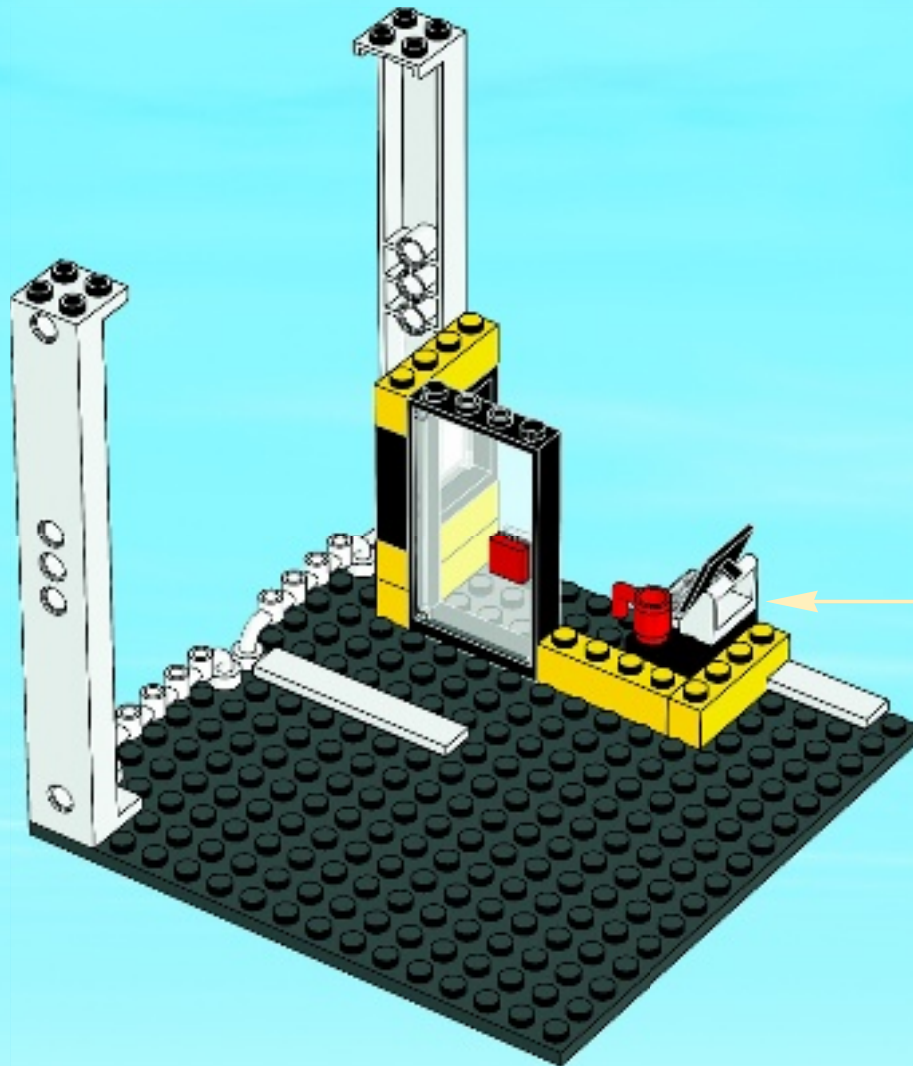





1x

8

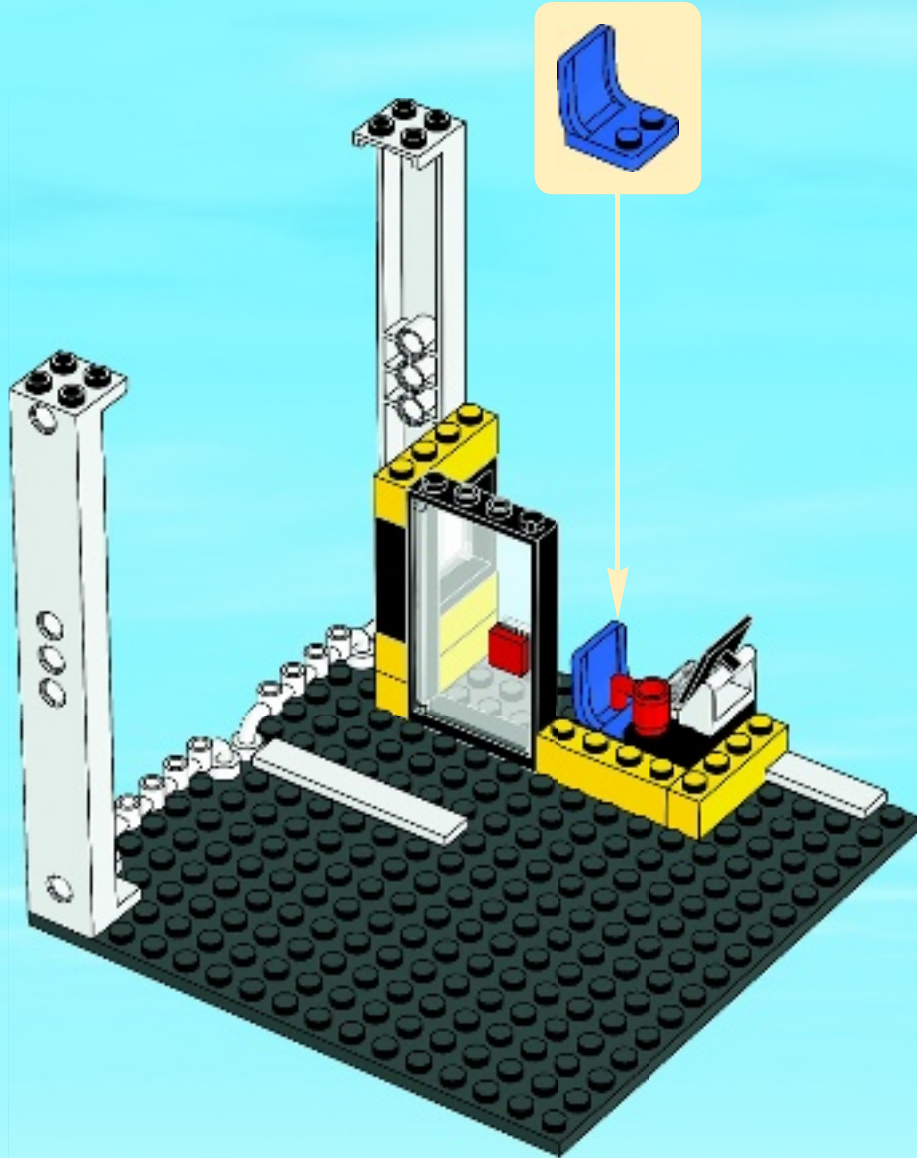

2x



1x



1x

9

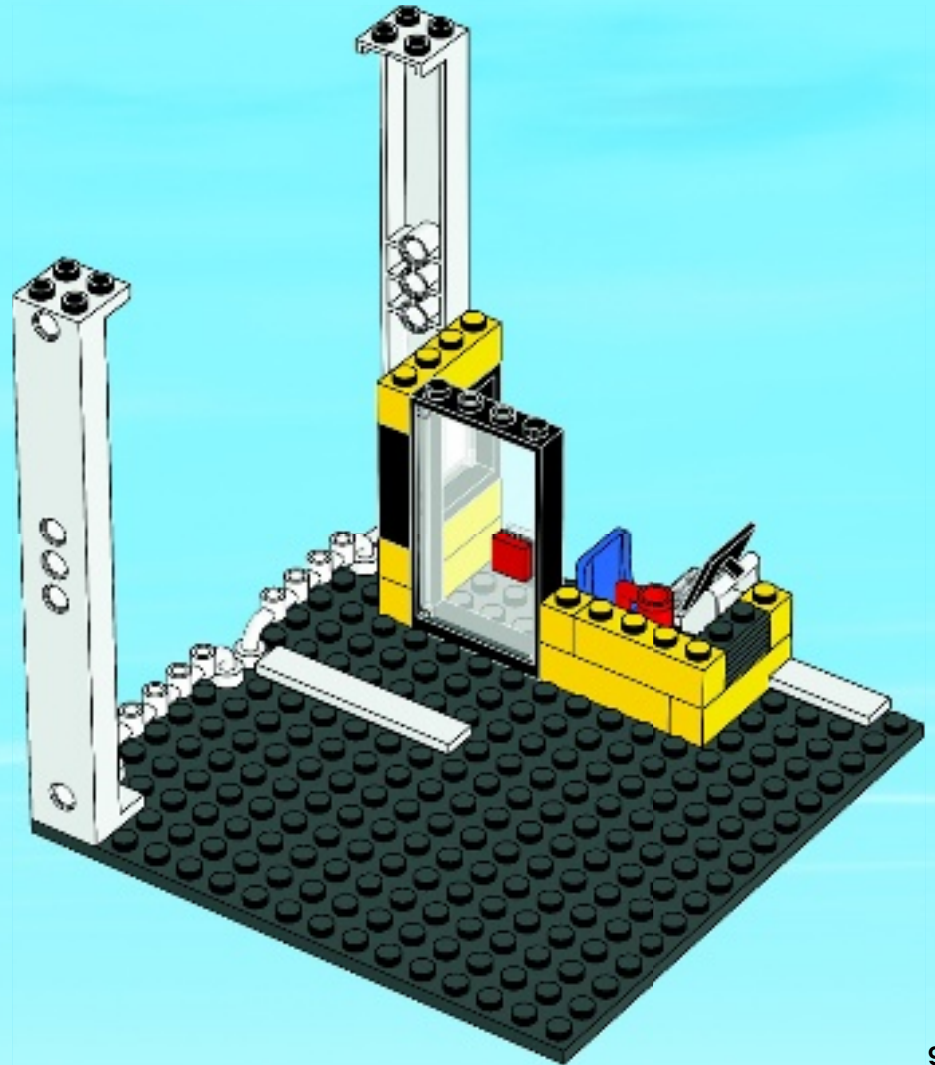

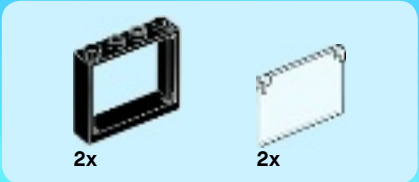

10

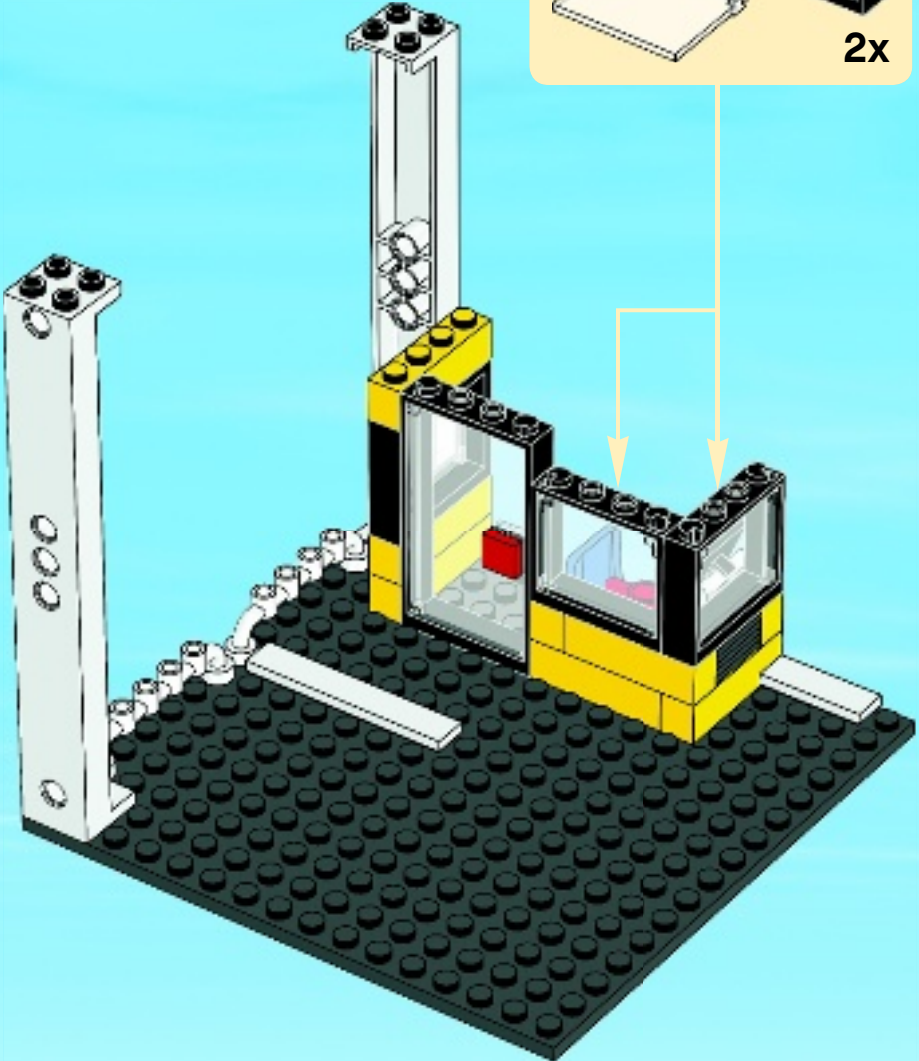
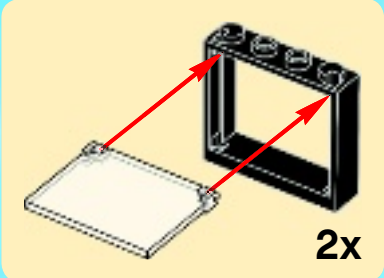



11

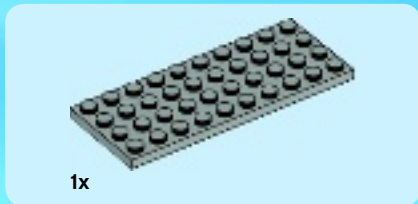
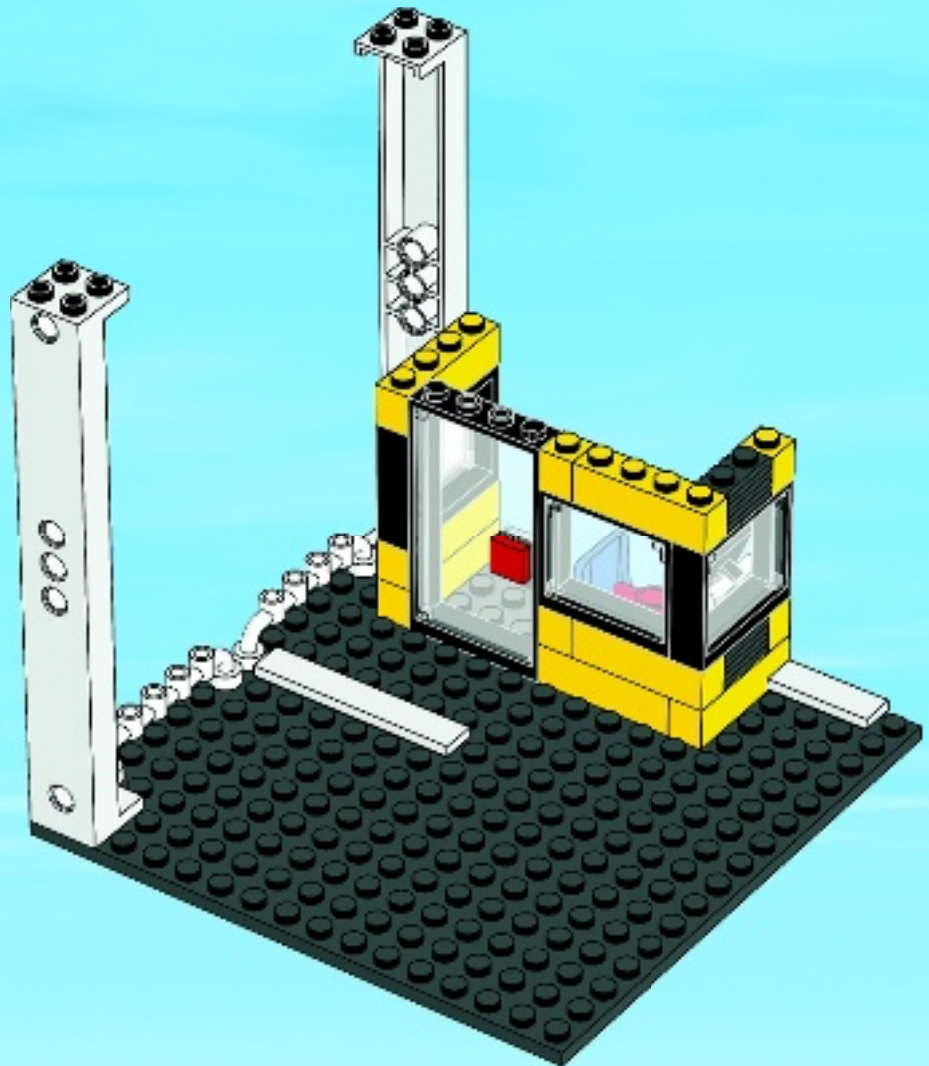

12

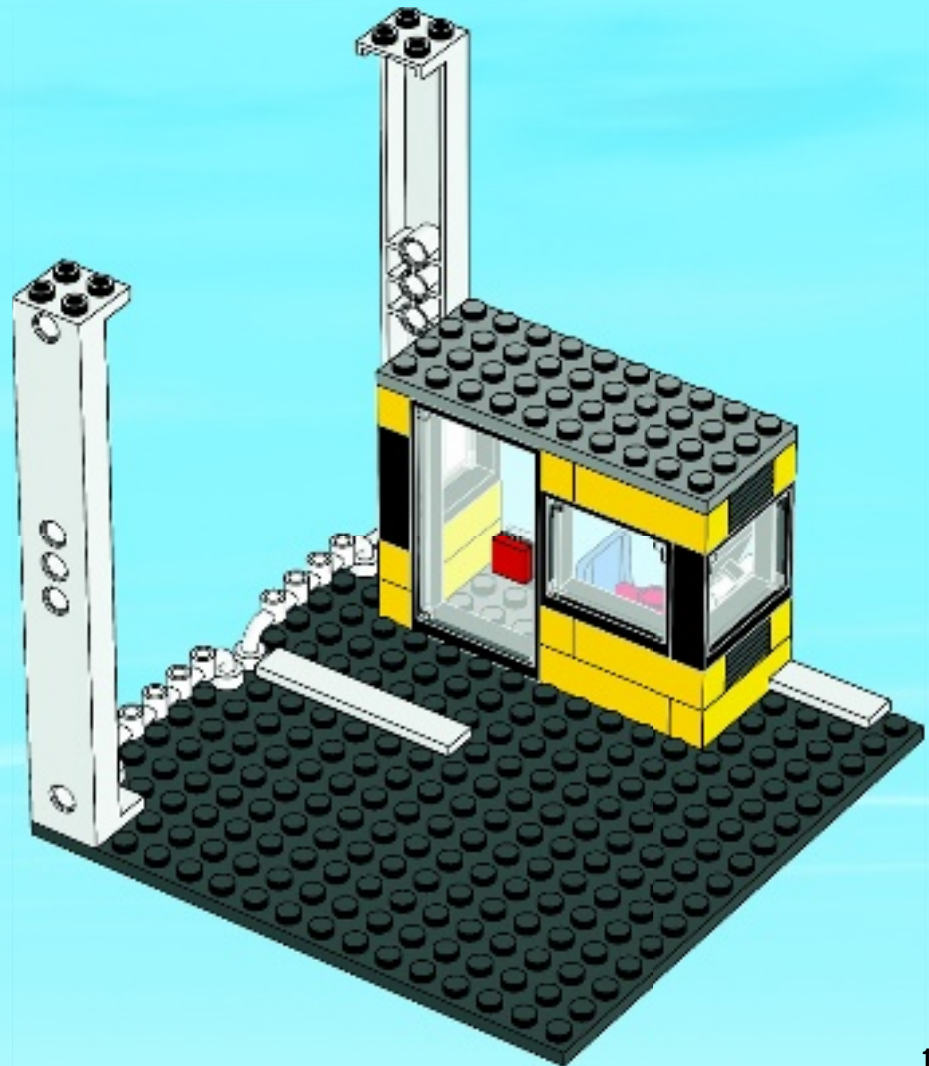





1x



1x



1x

# 13

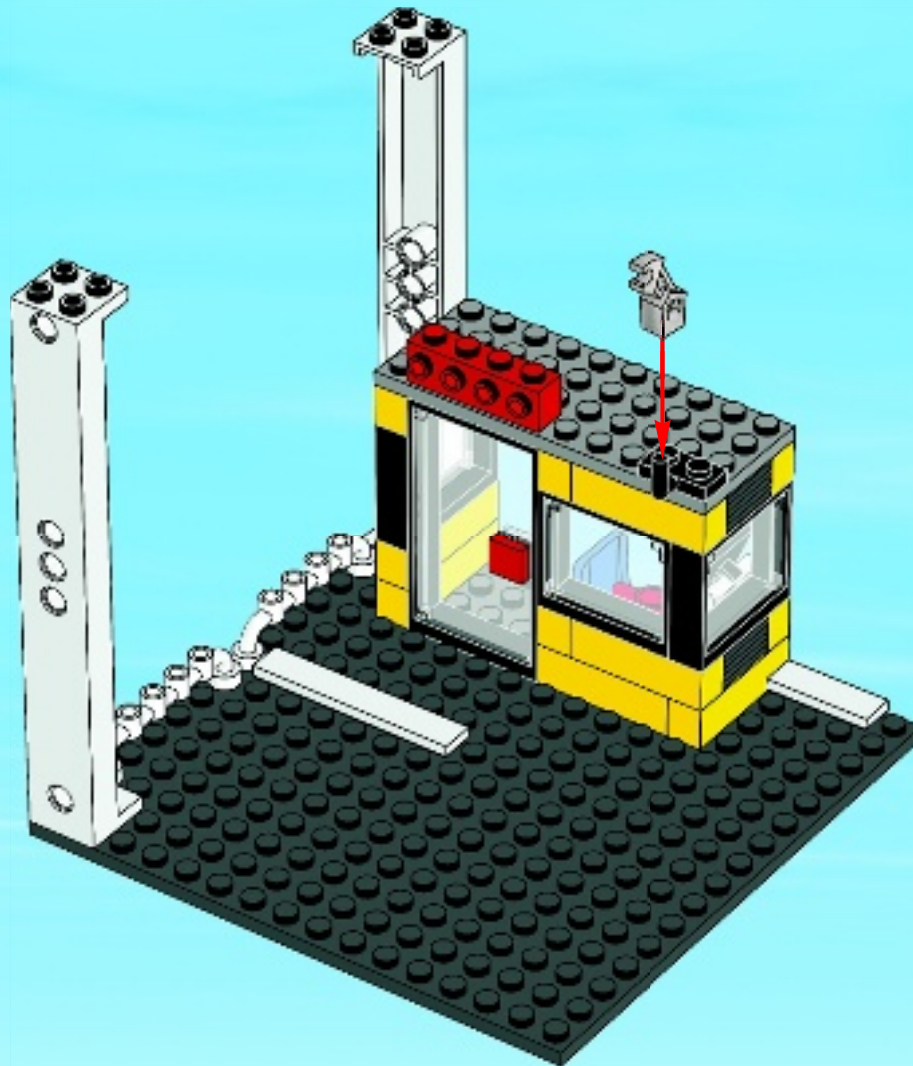



-  1x
-  1x
-  1x

14

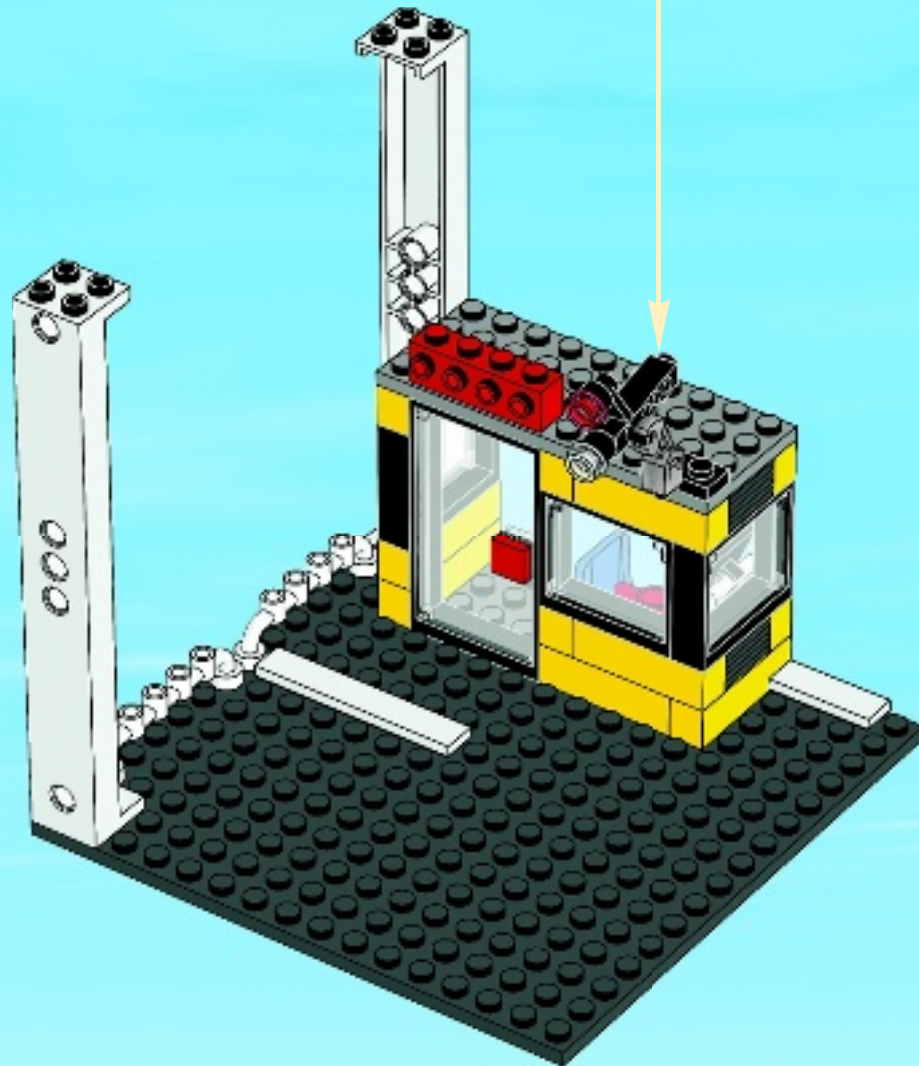
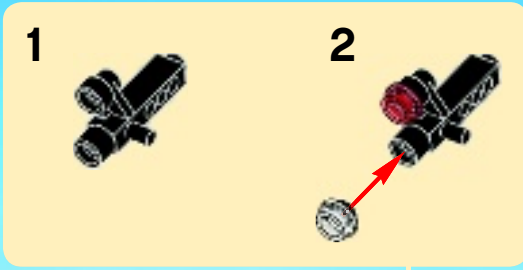



1x

15

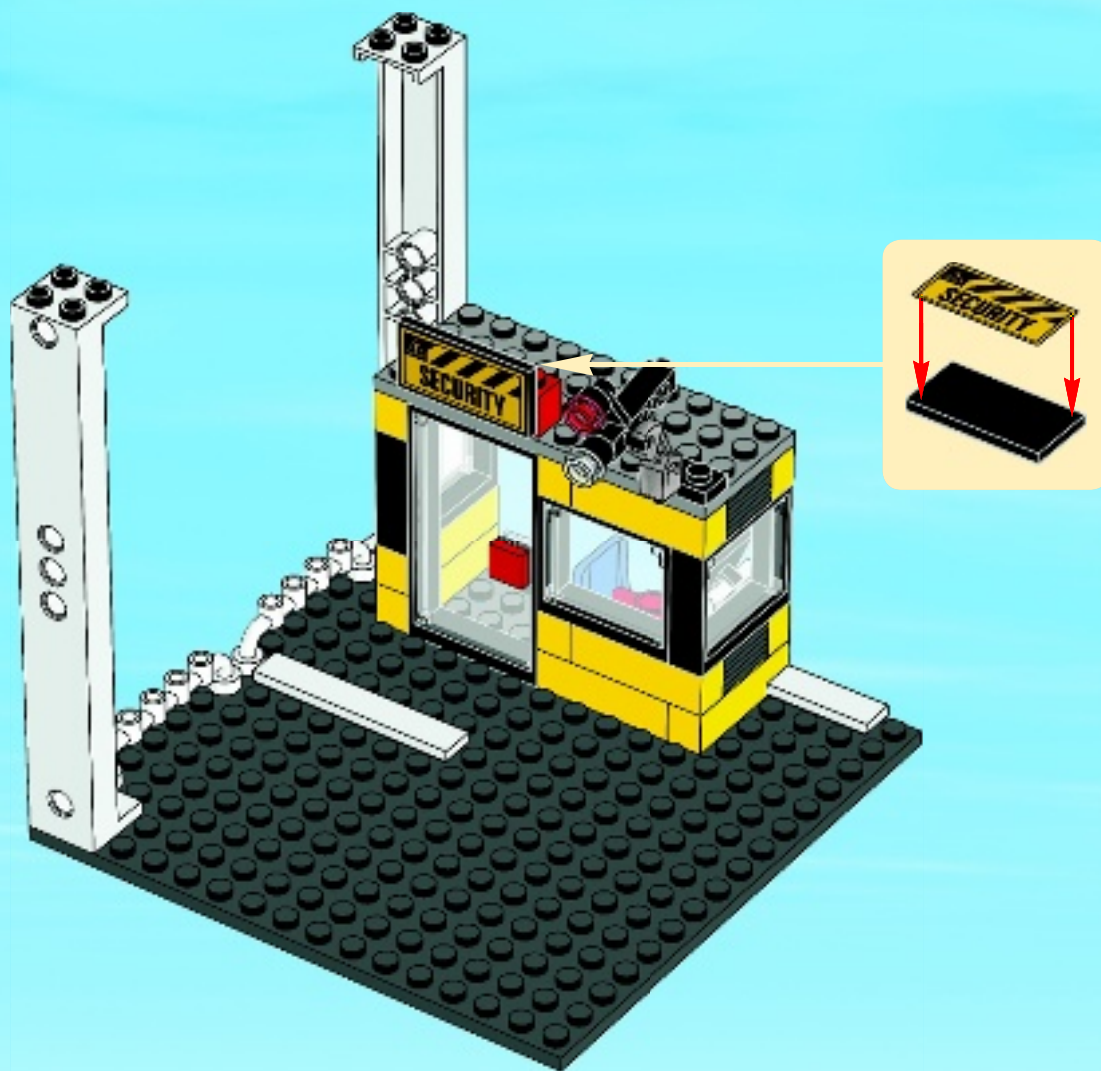

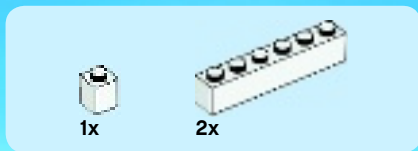

16

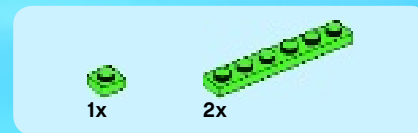
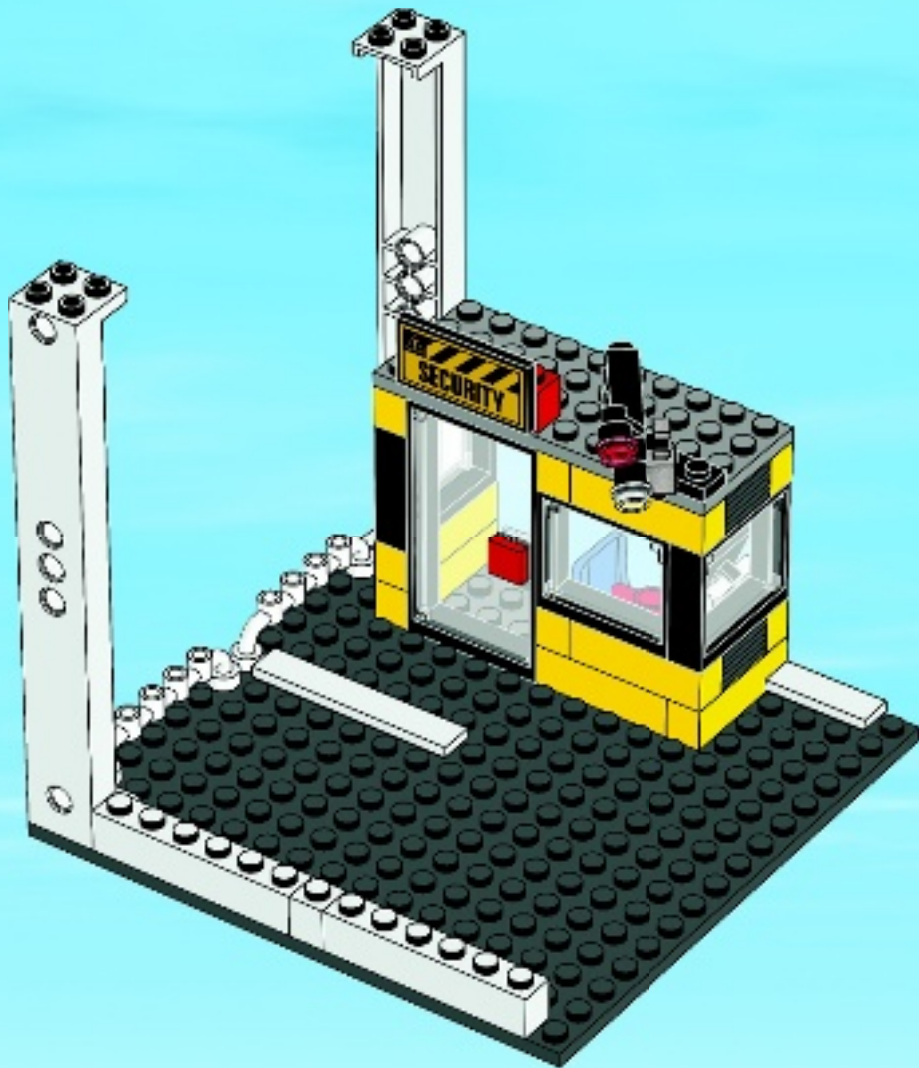

17

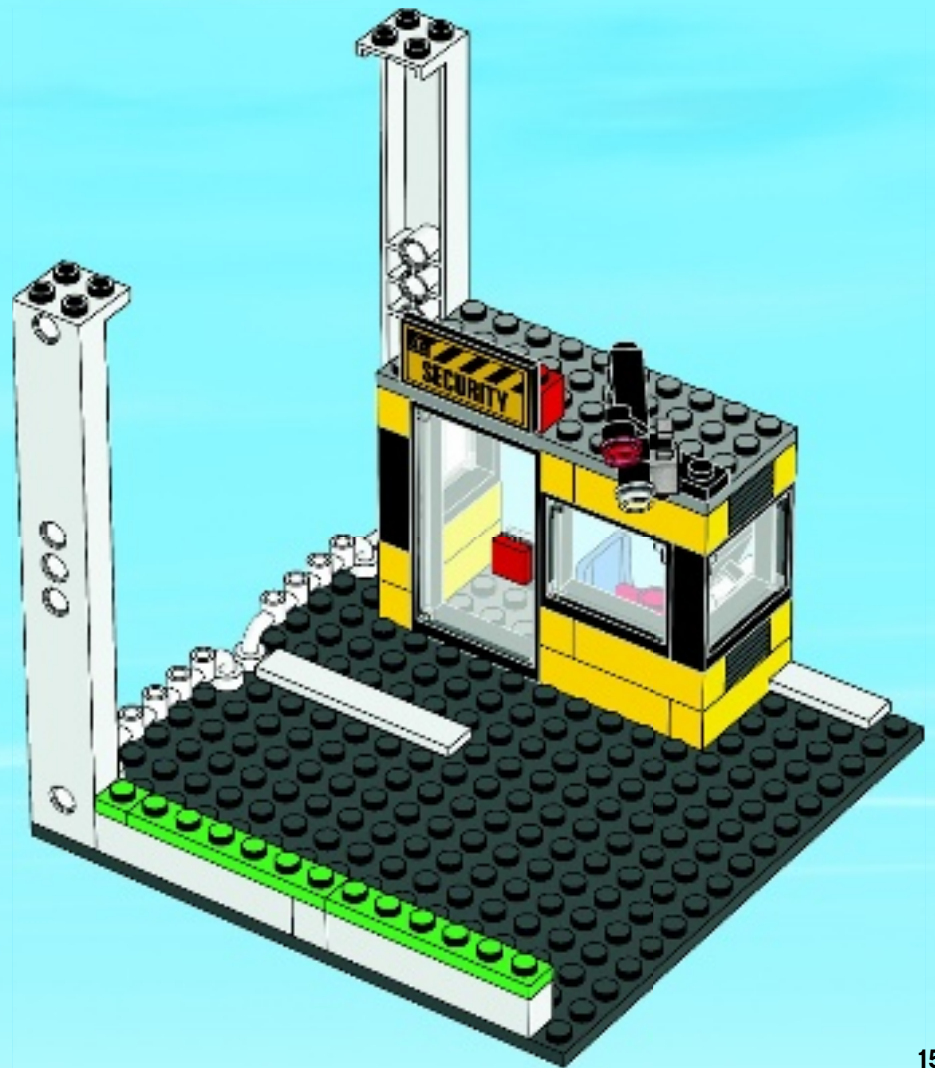



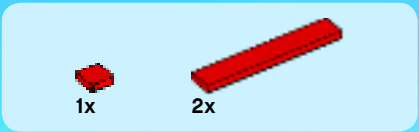

18

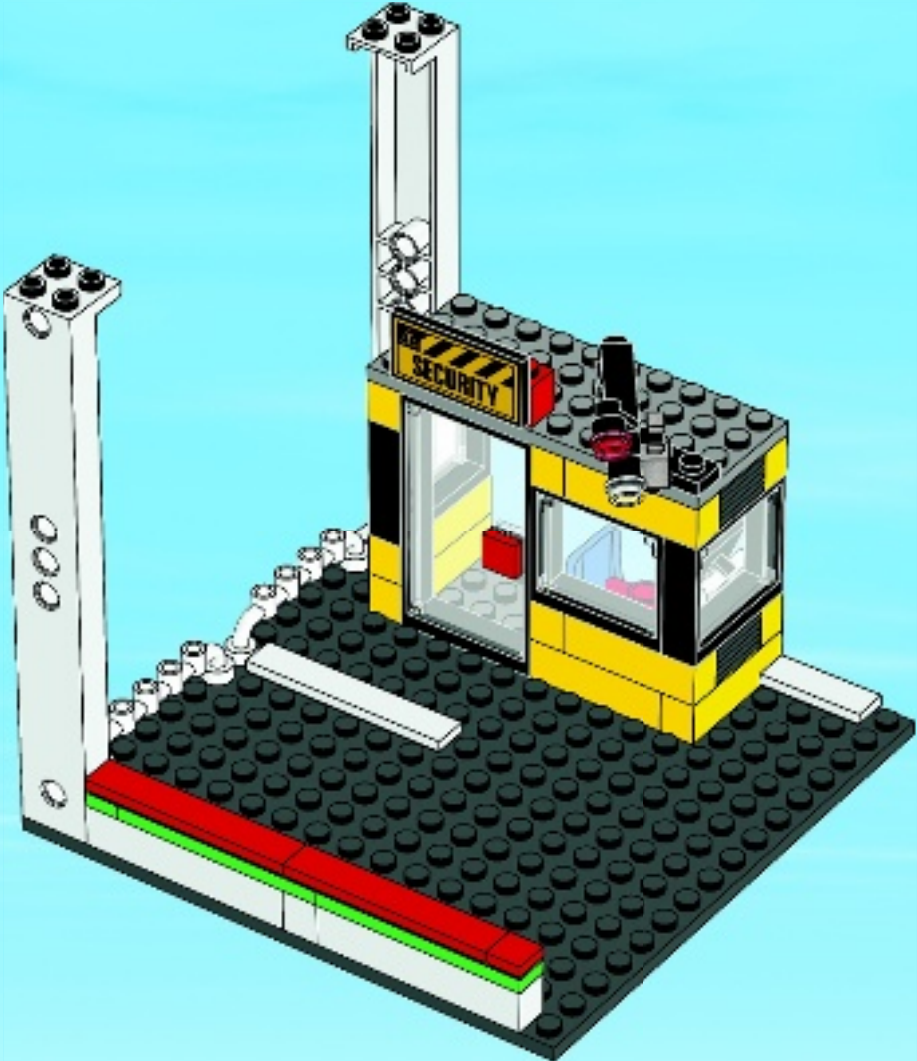



43

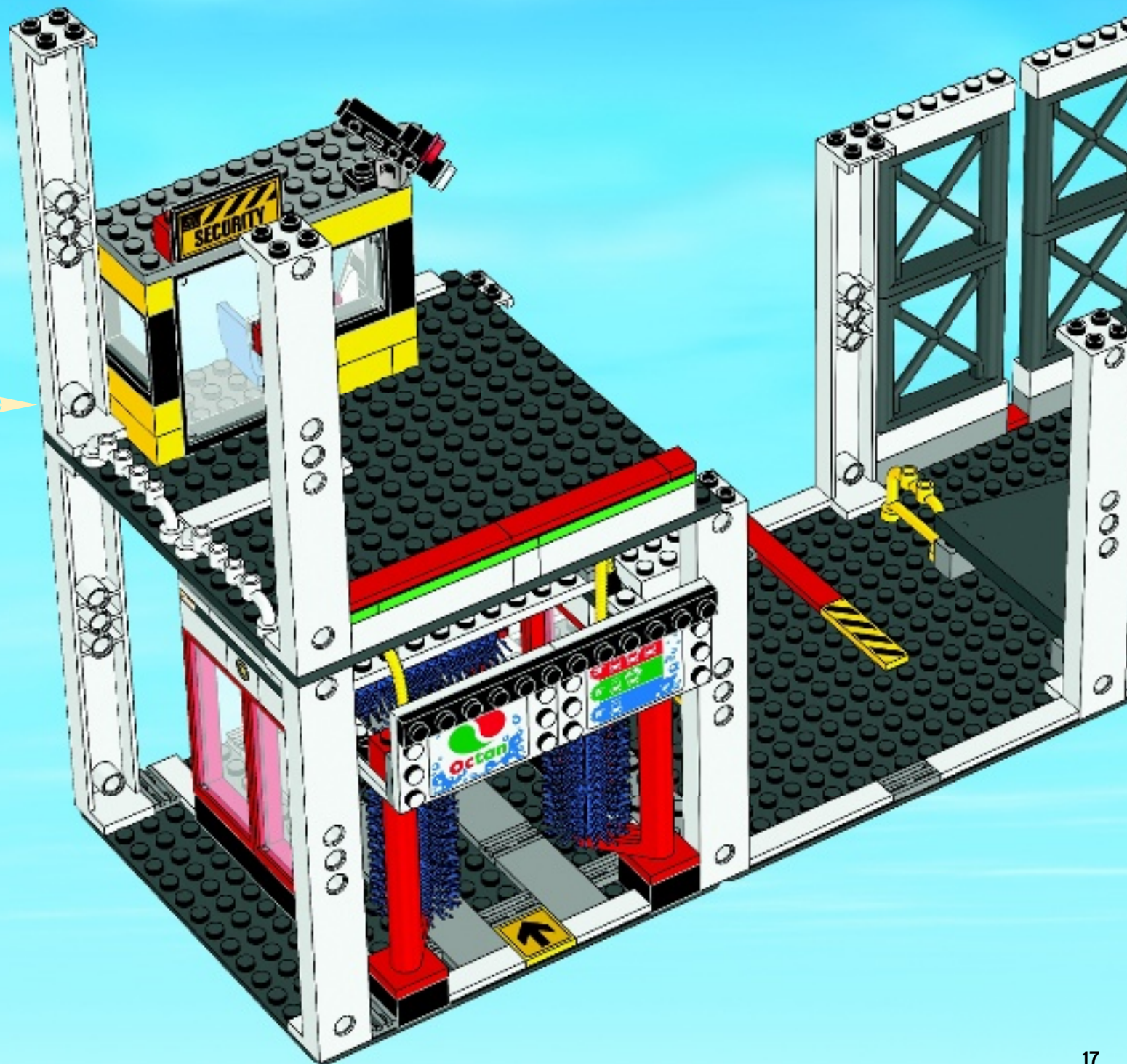





2x

44

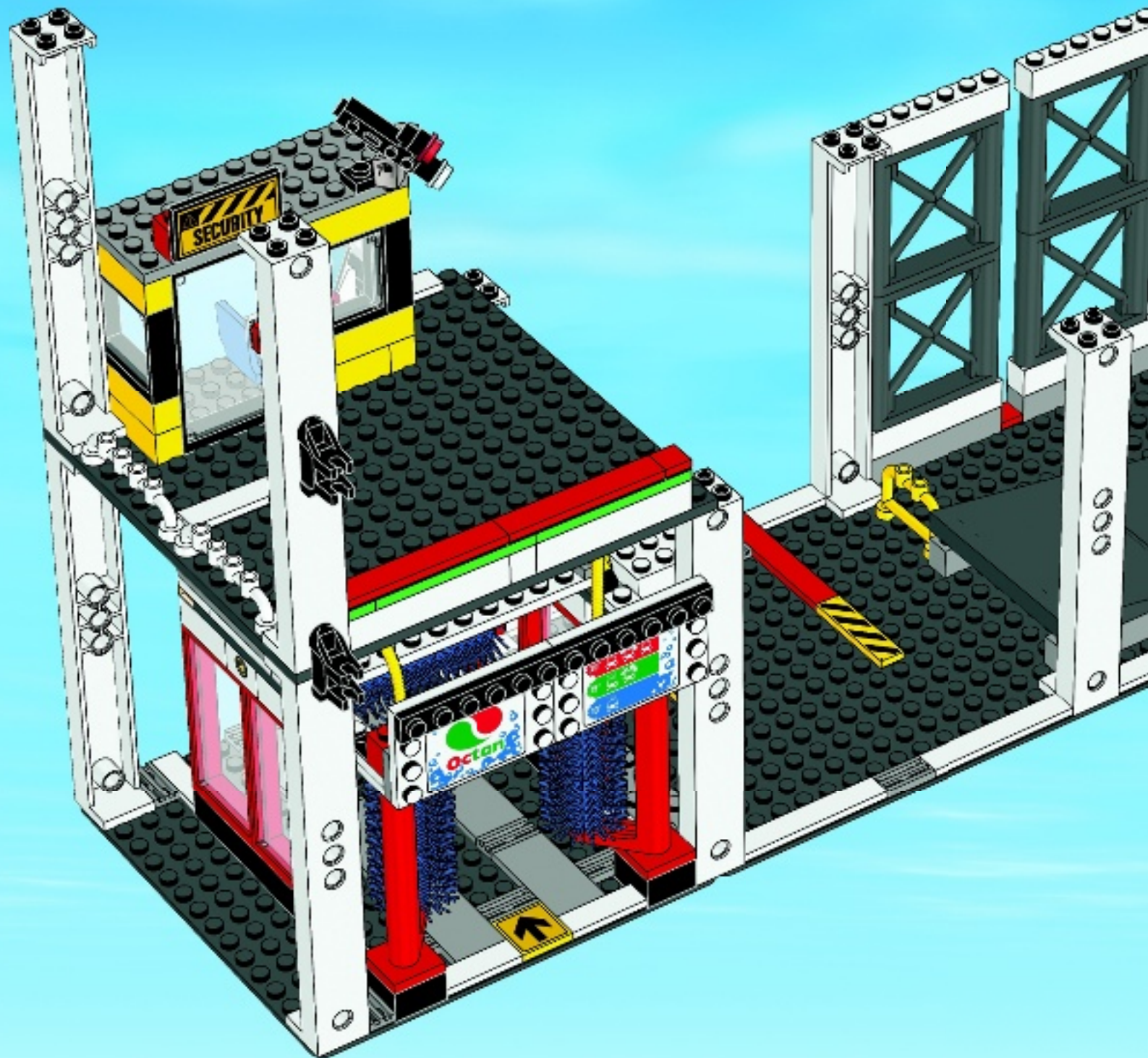

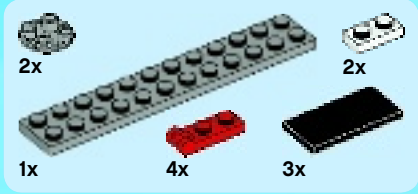

# 45

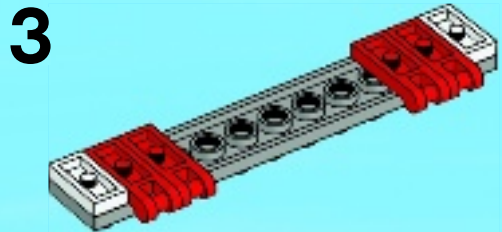
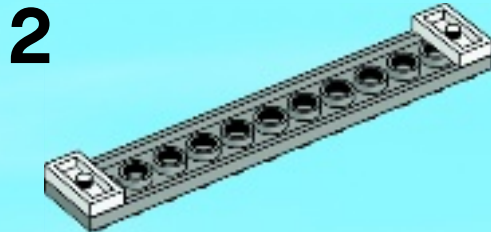
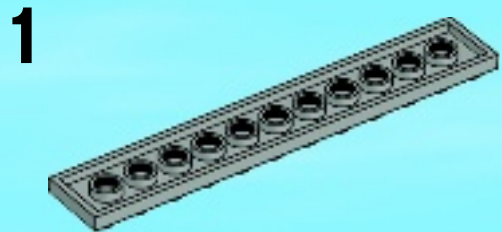

4

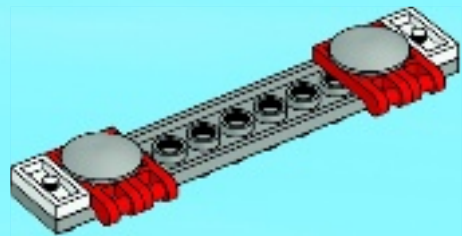

5

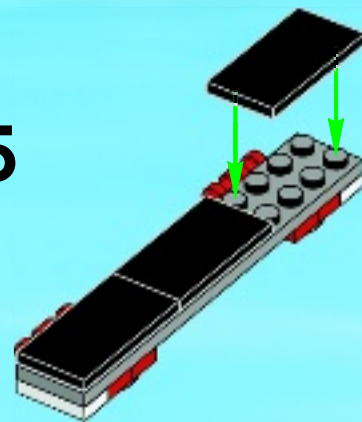

6

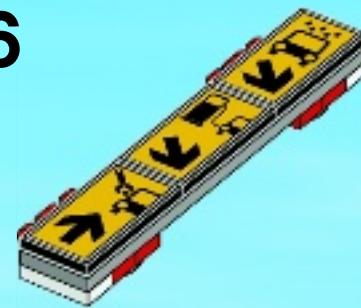



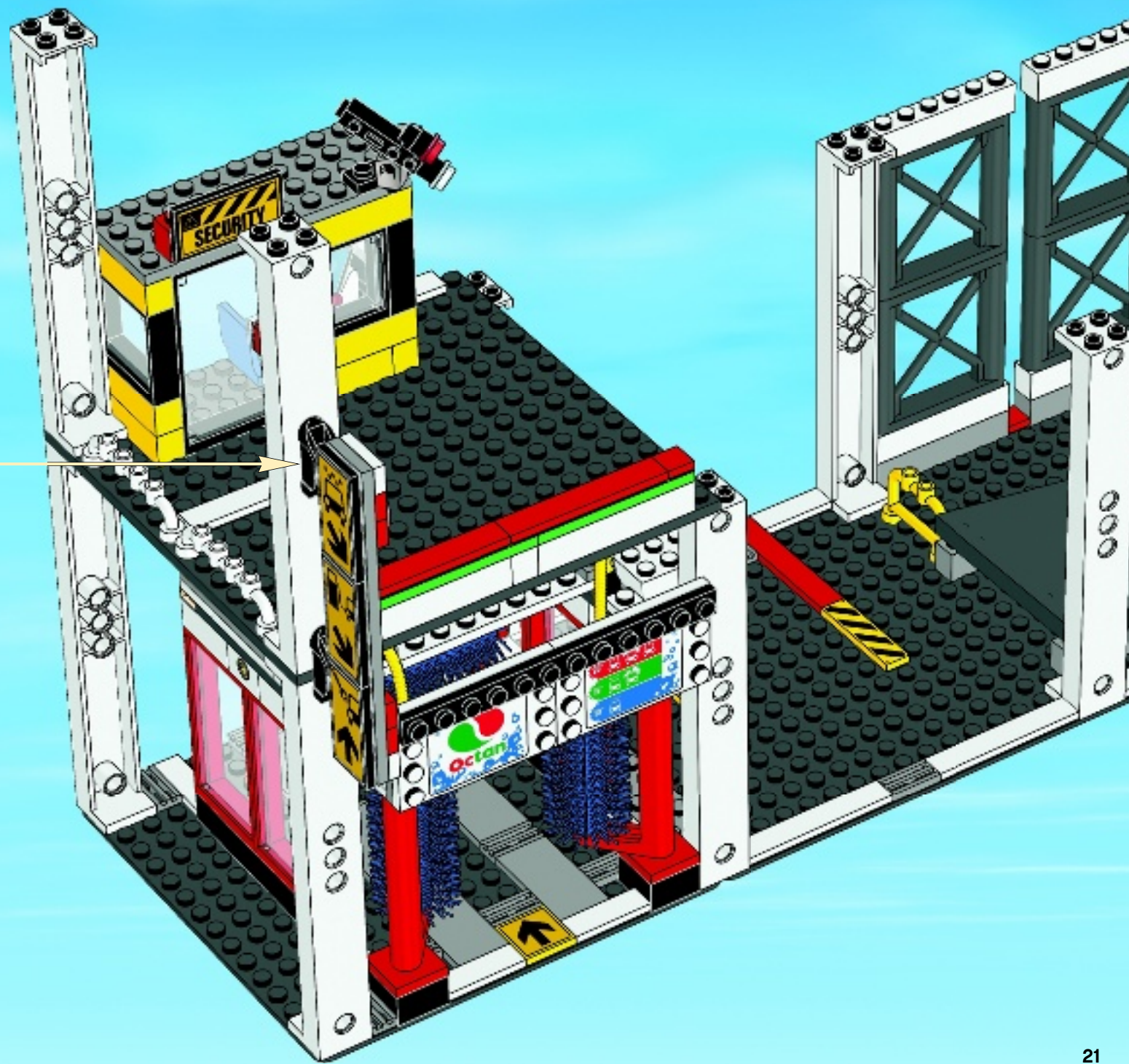

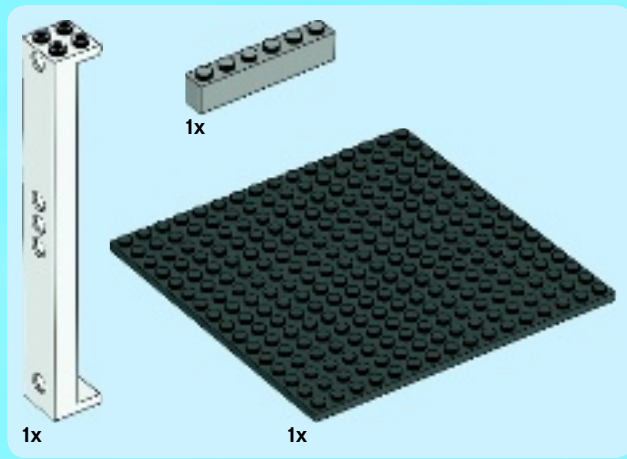
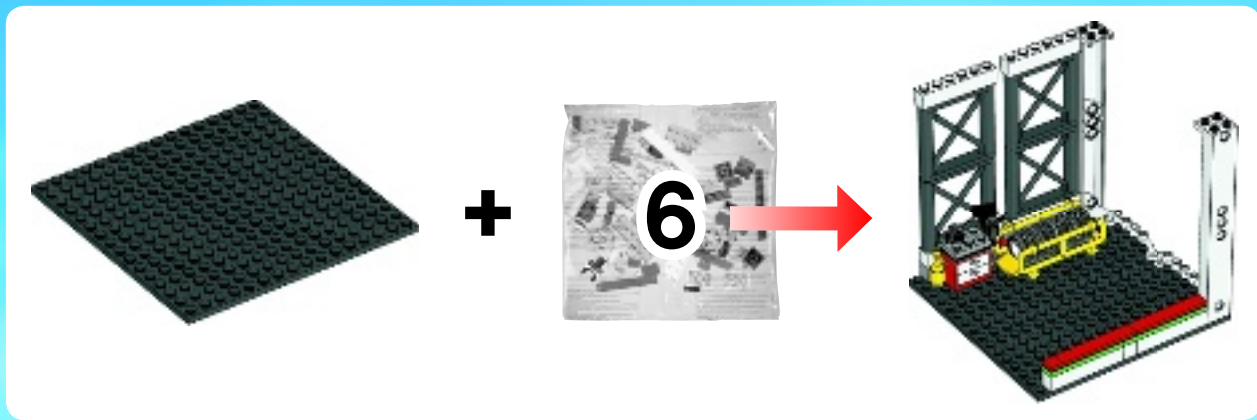

1

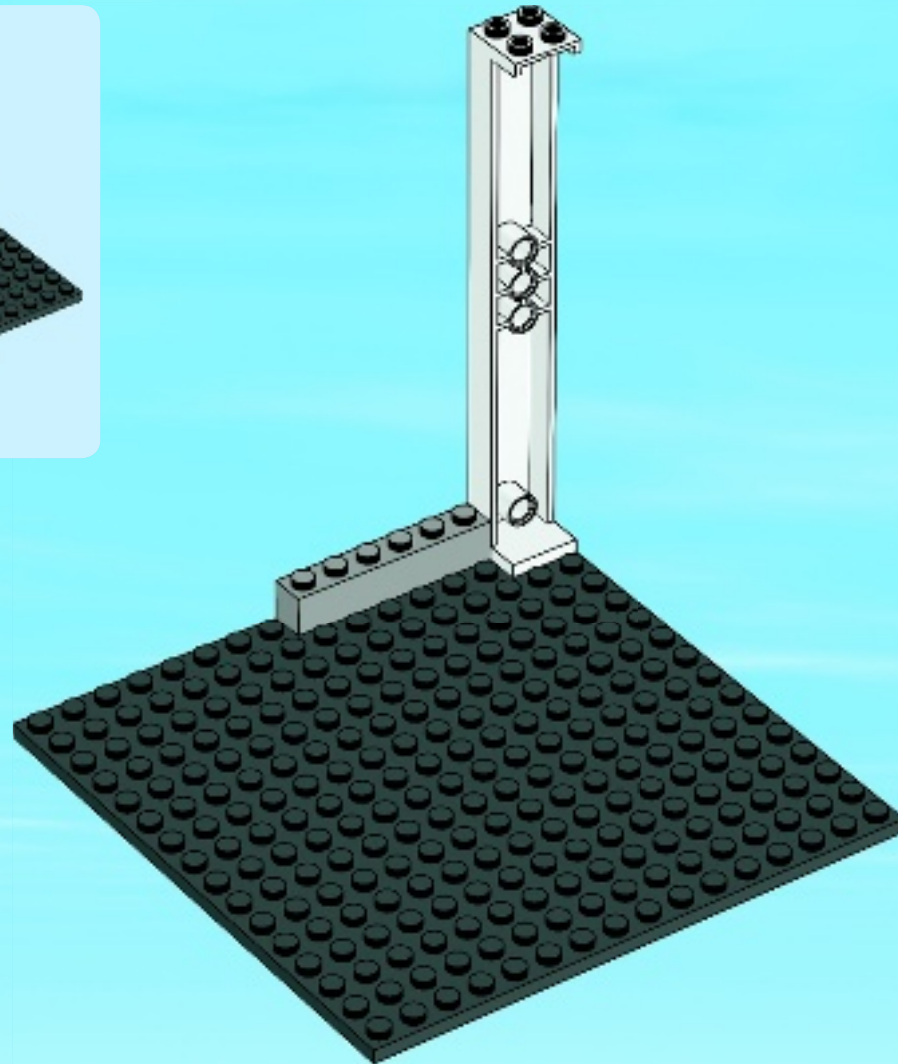



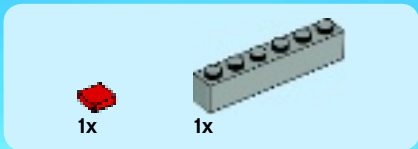

2

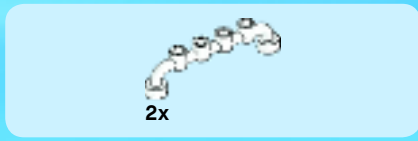
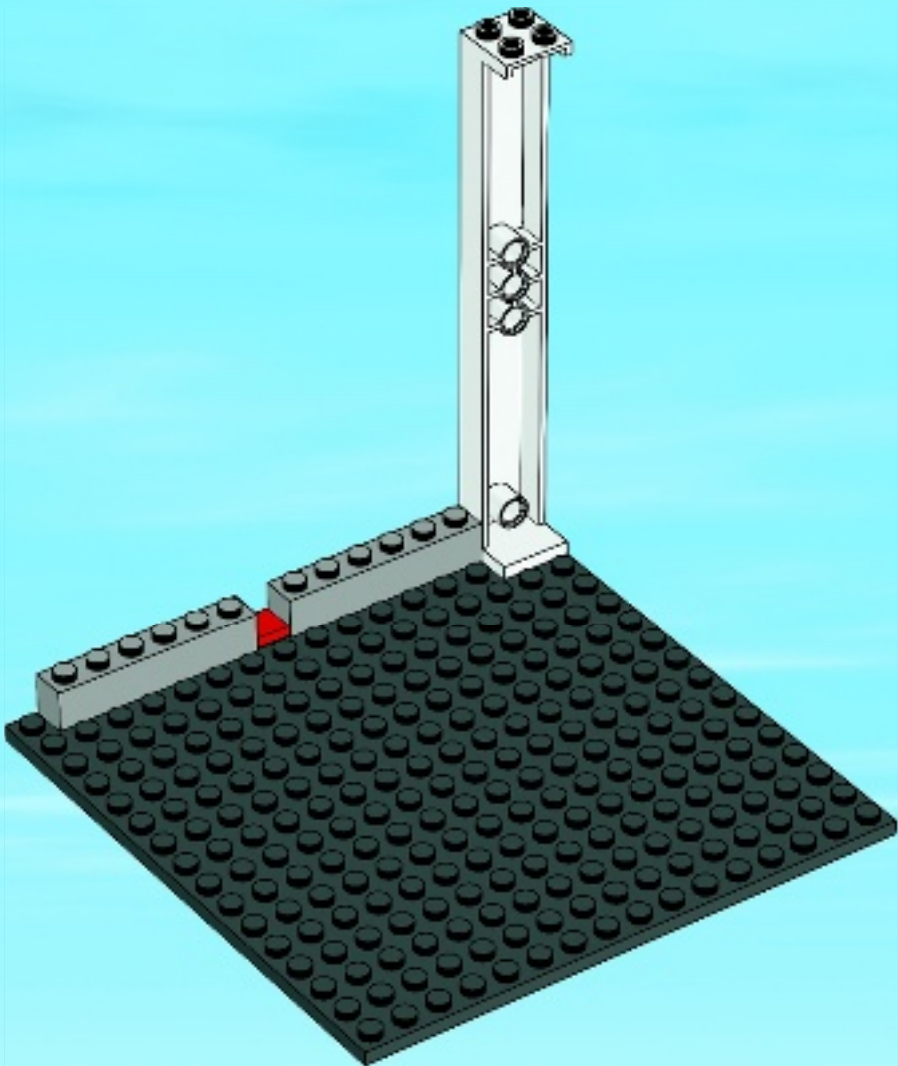

3

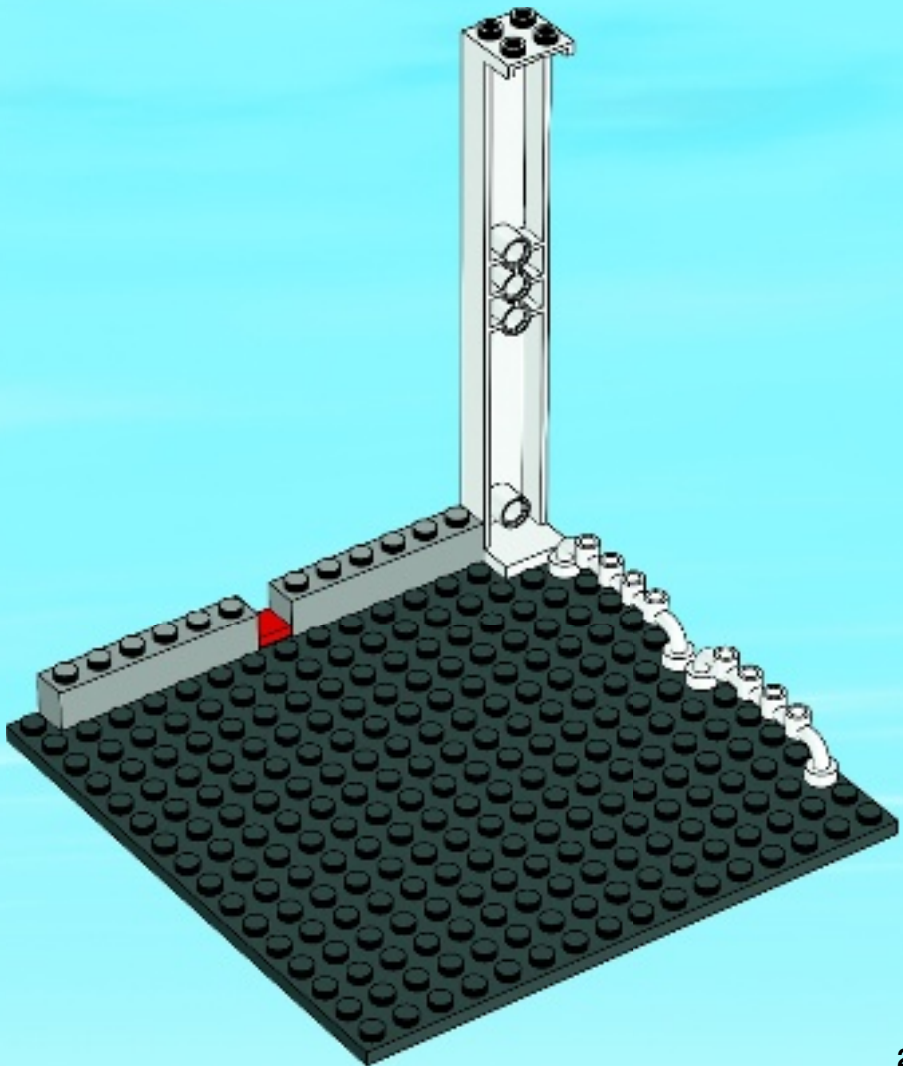

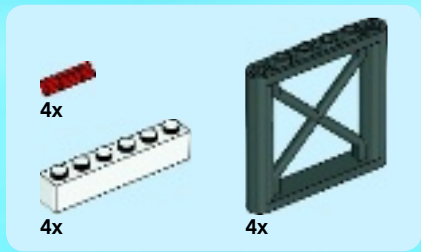

4

1

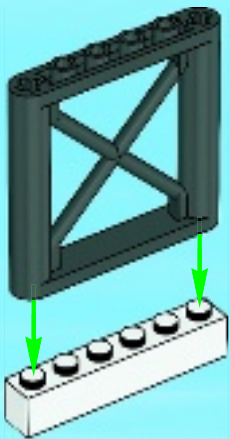

2

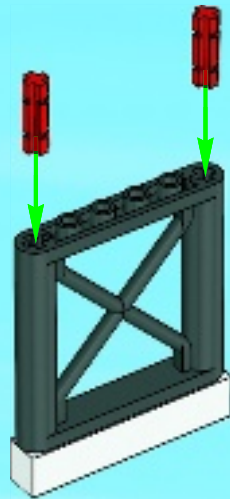

3

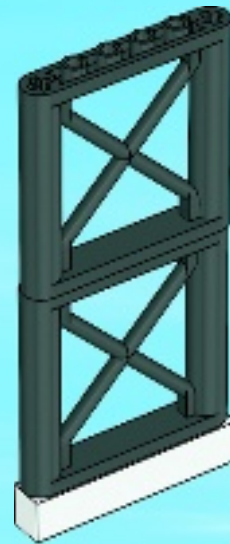



4

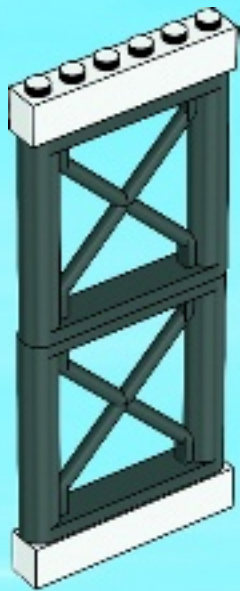

2x

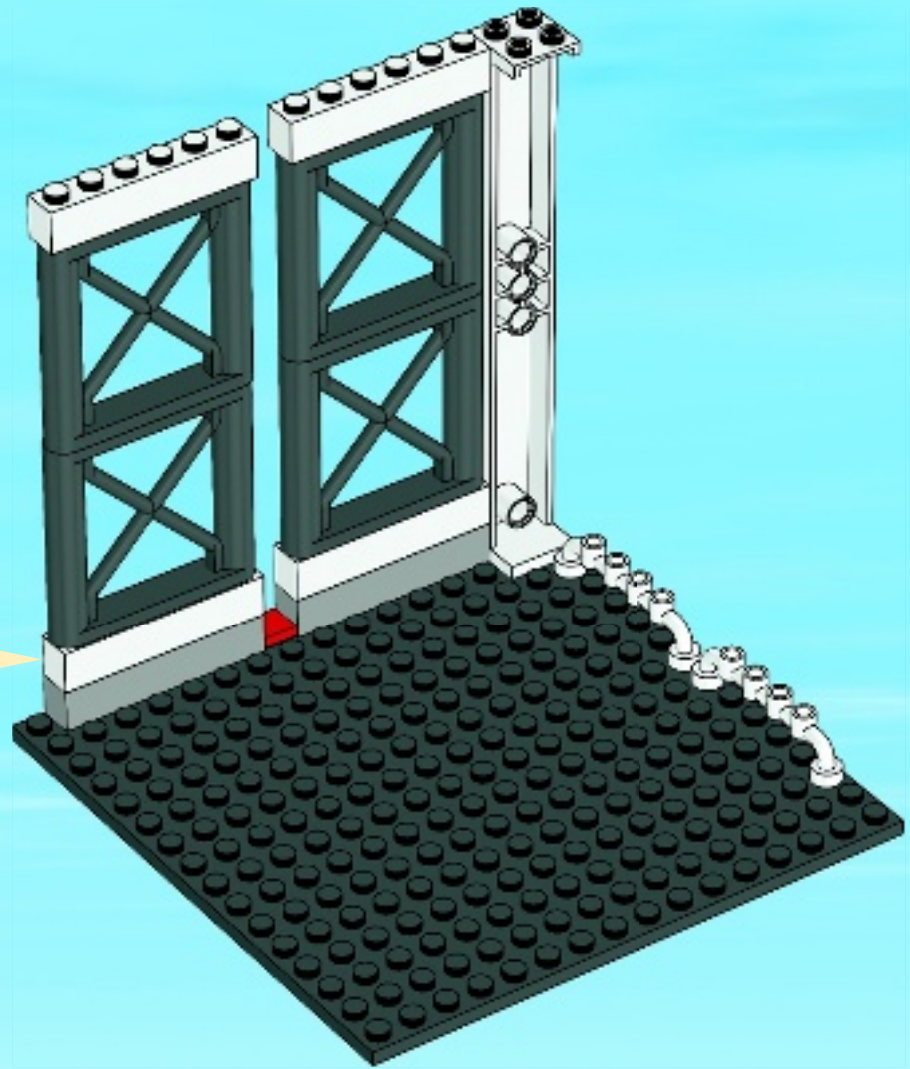



1x



1x



1x

5

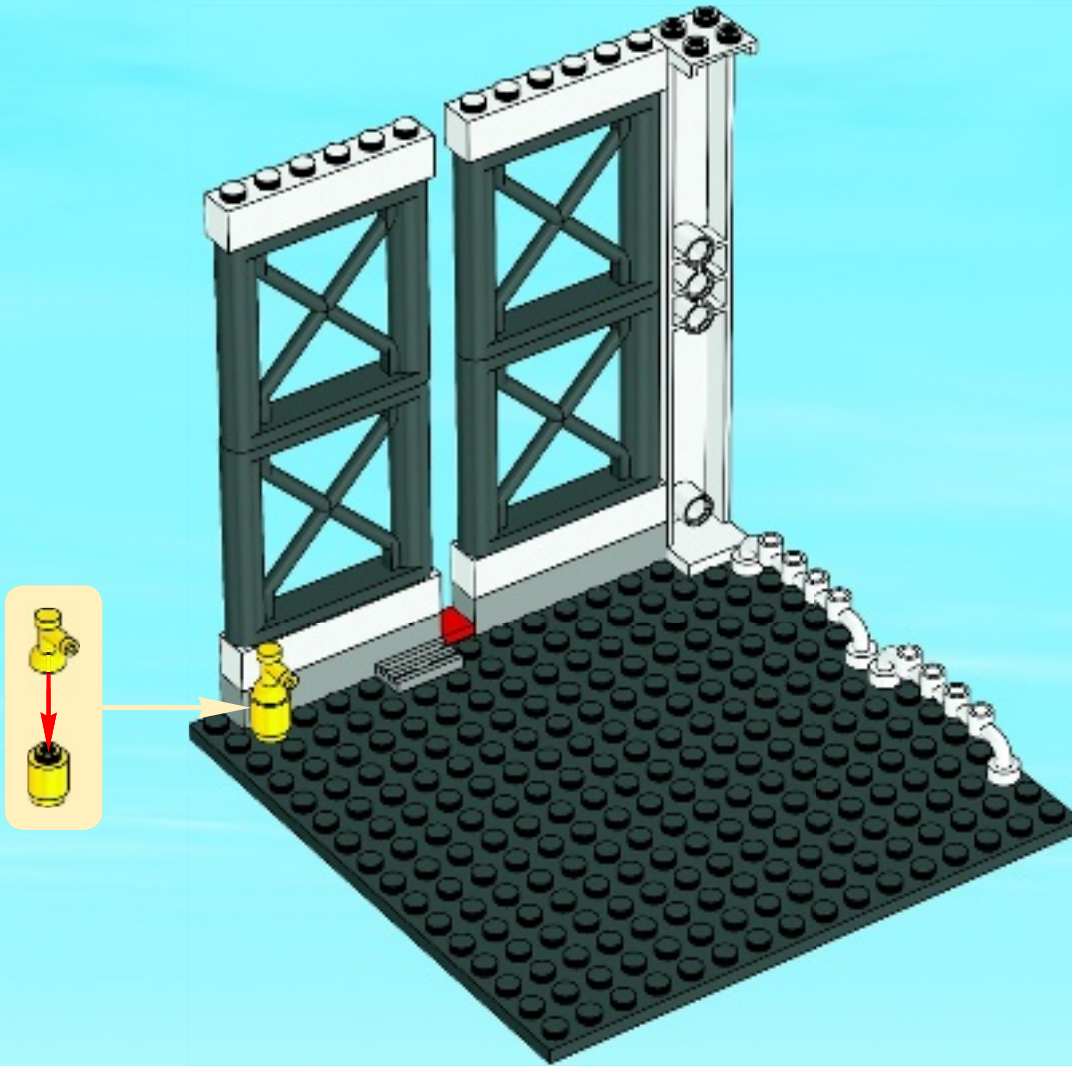

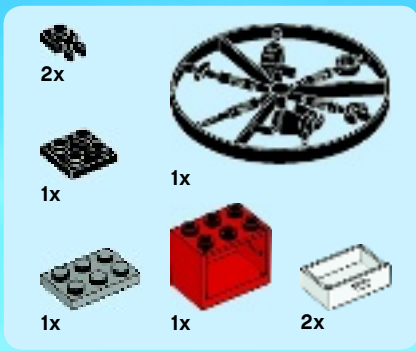

# 6

1



2

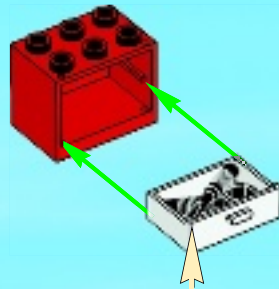

3

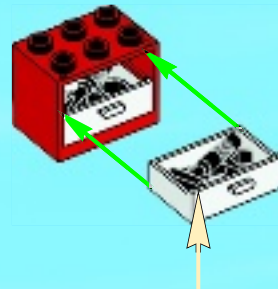

4





5



6

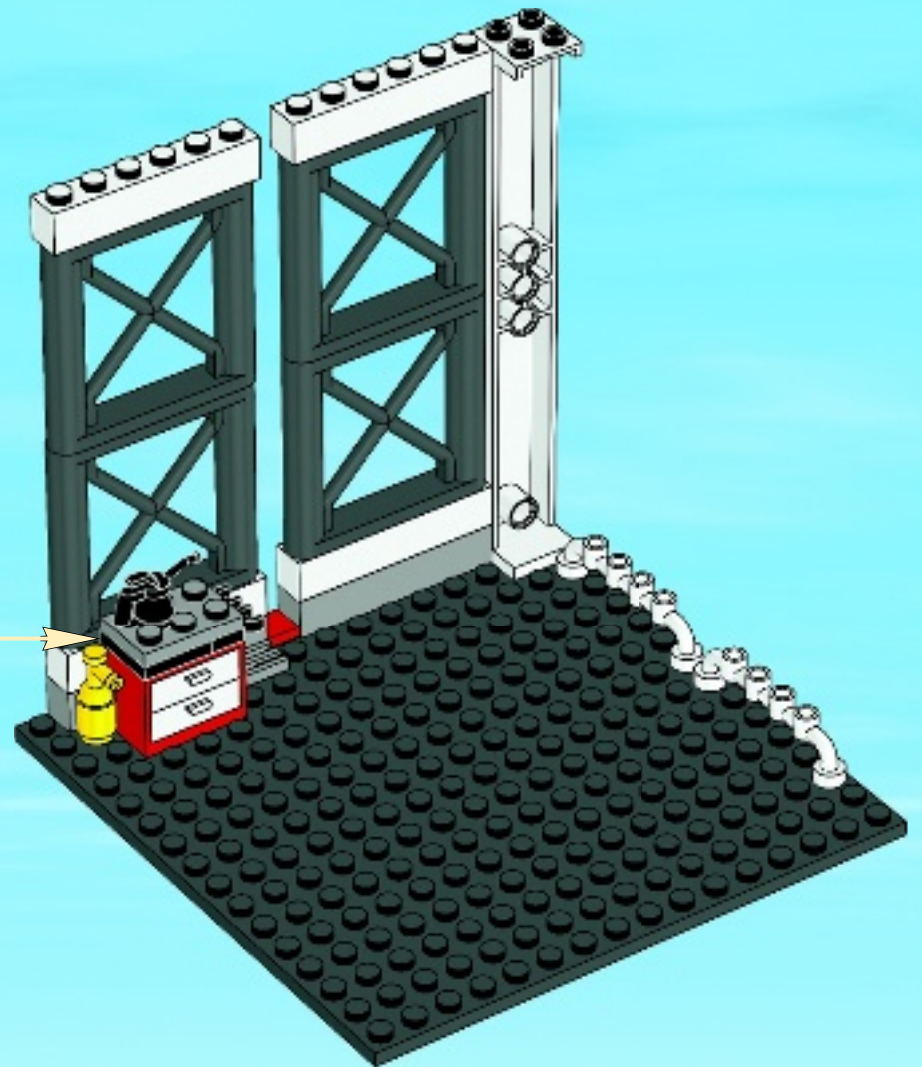



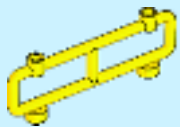

1x

7

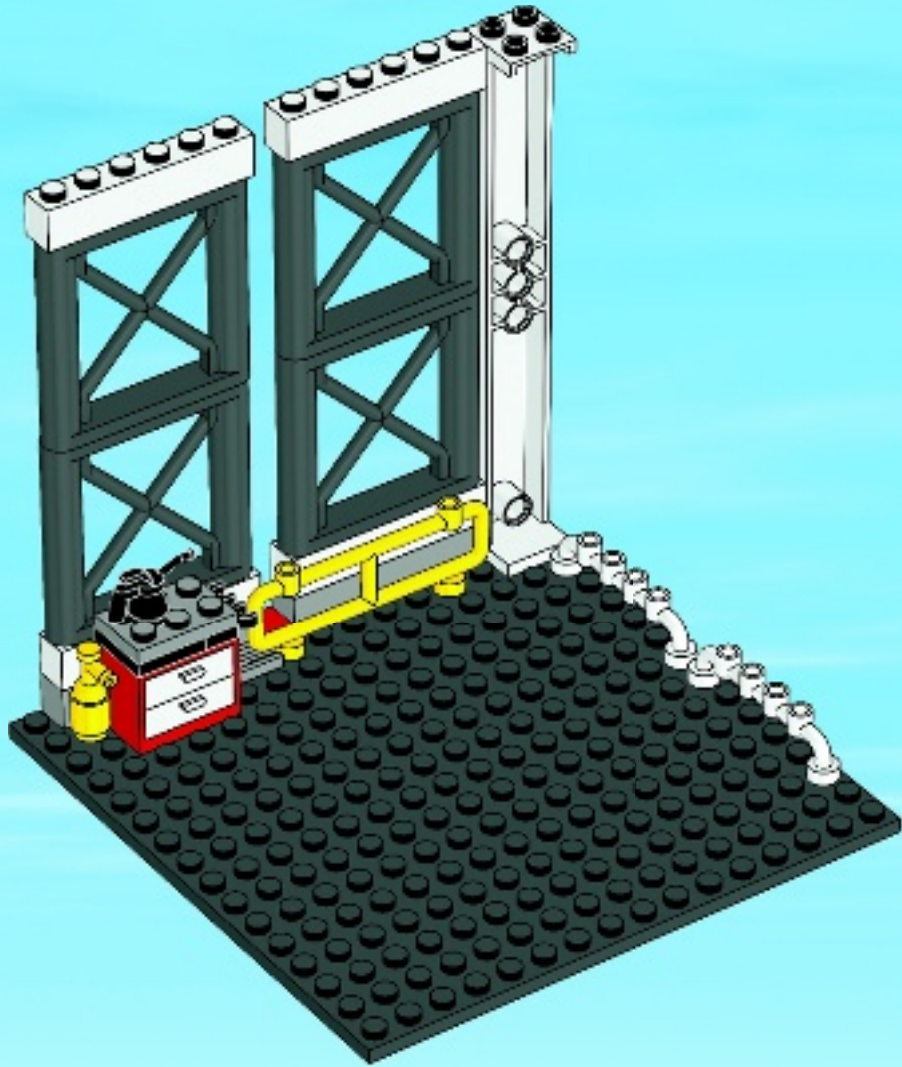

1x



2x

8

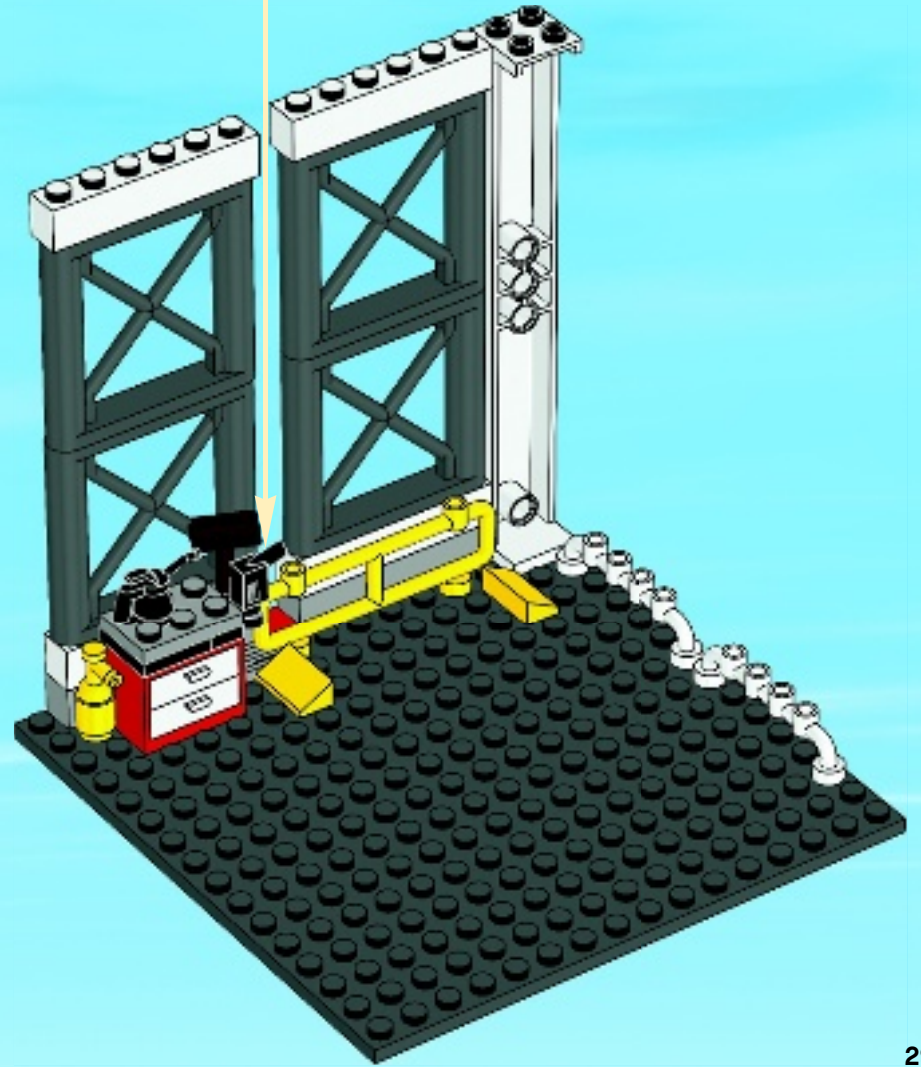

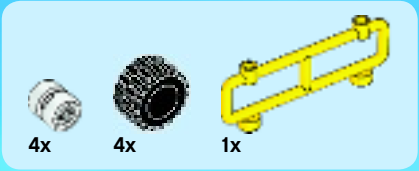

9

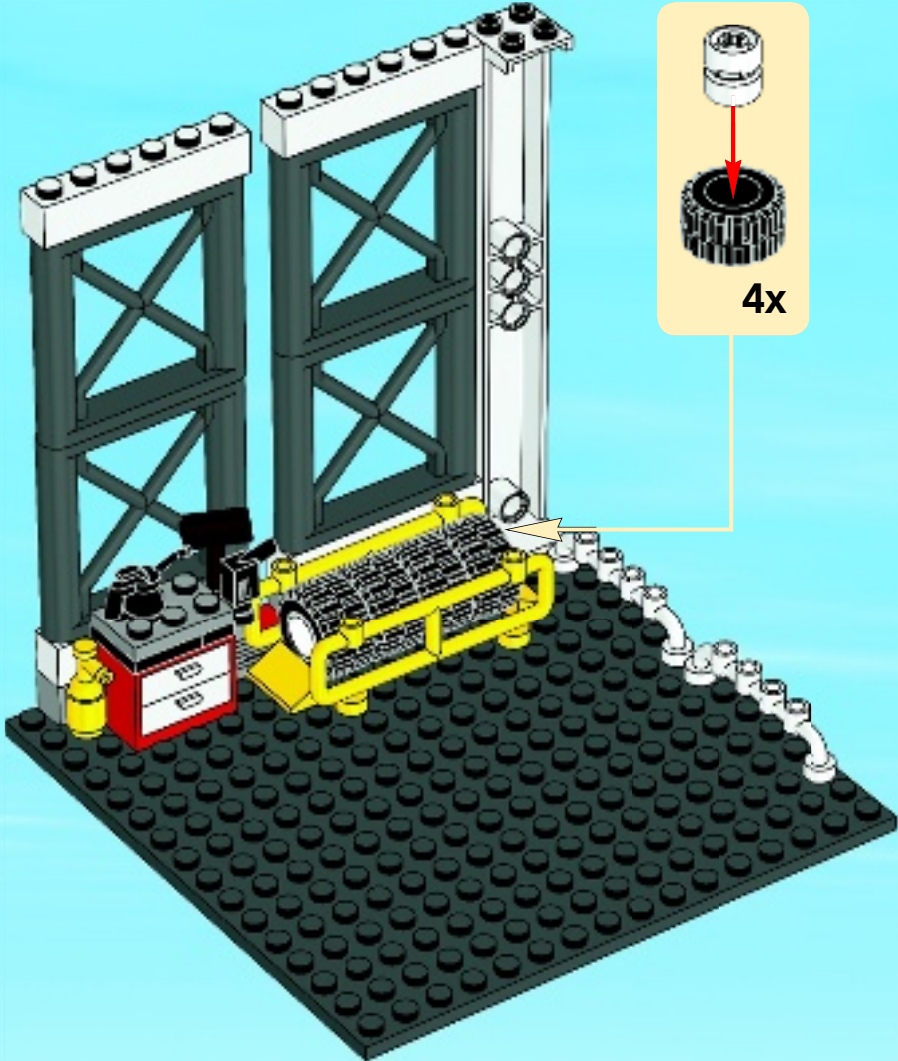



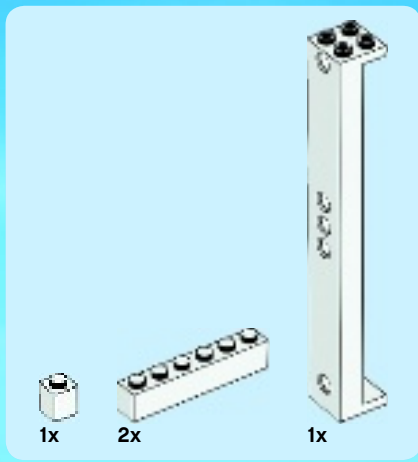

10

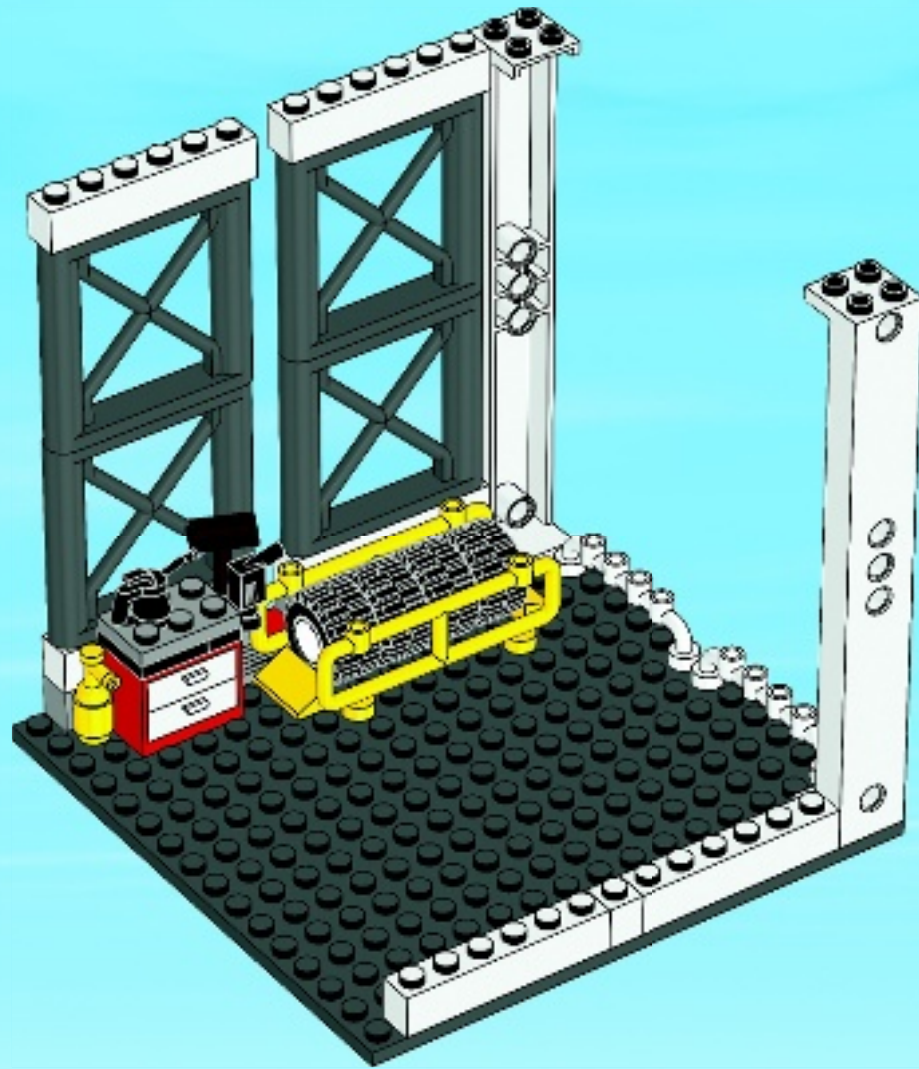

1x

2x

# 11

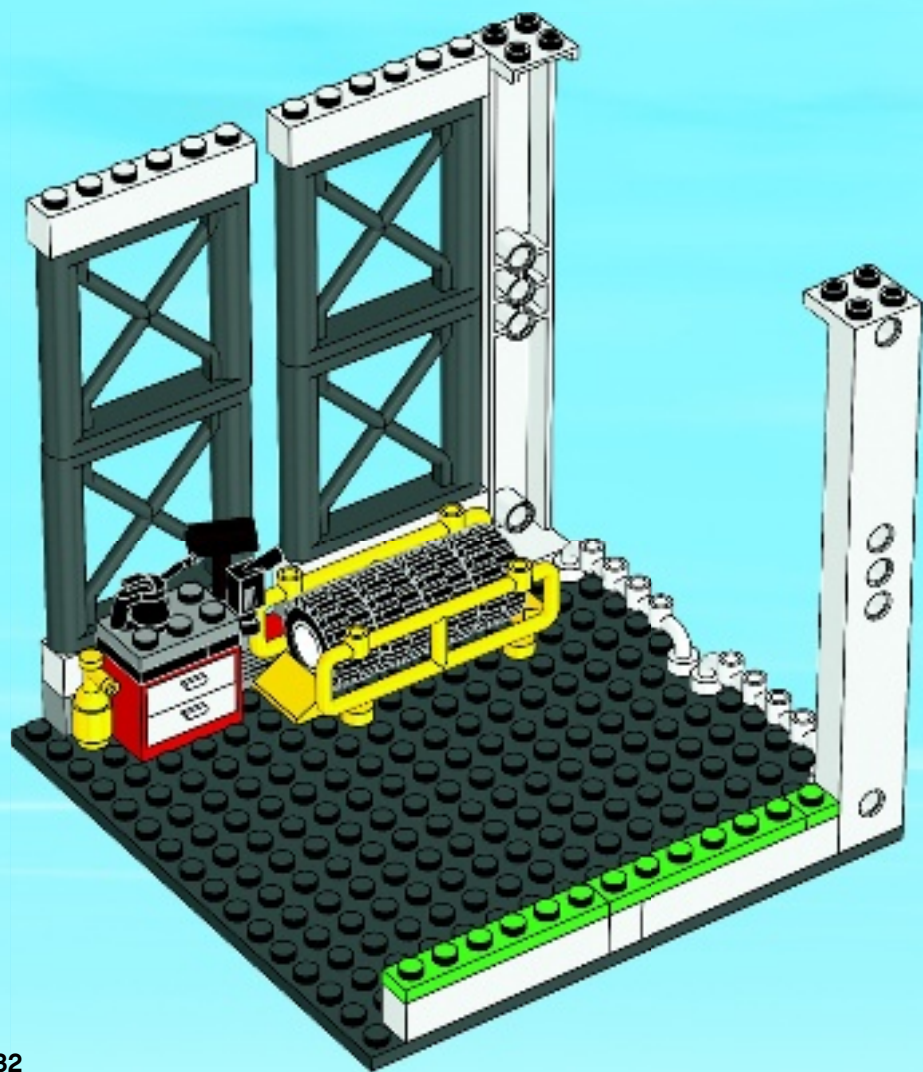

1x

2x

# 12

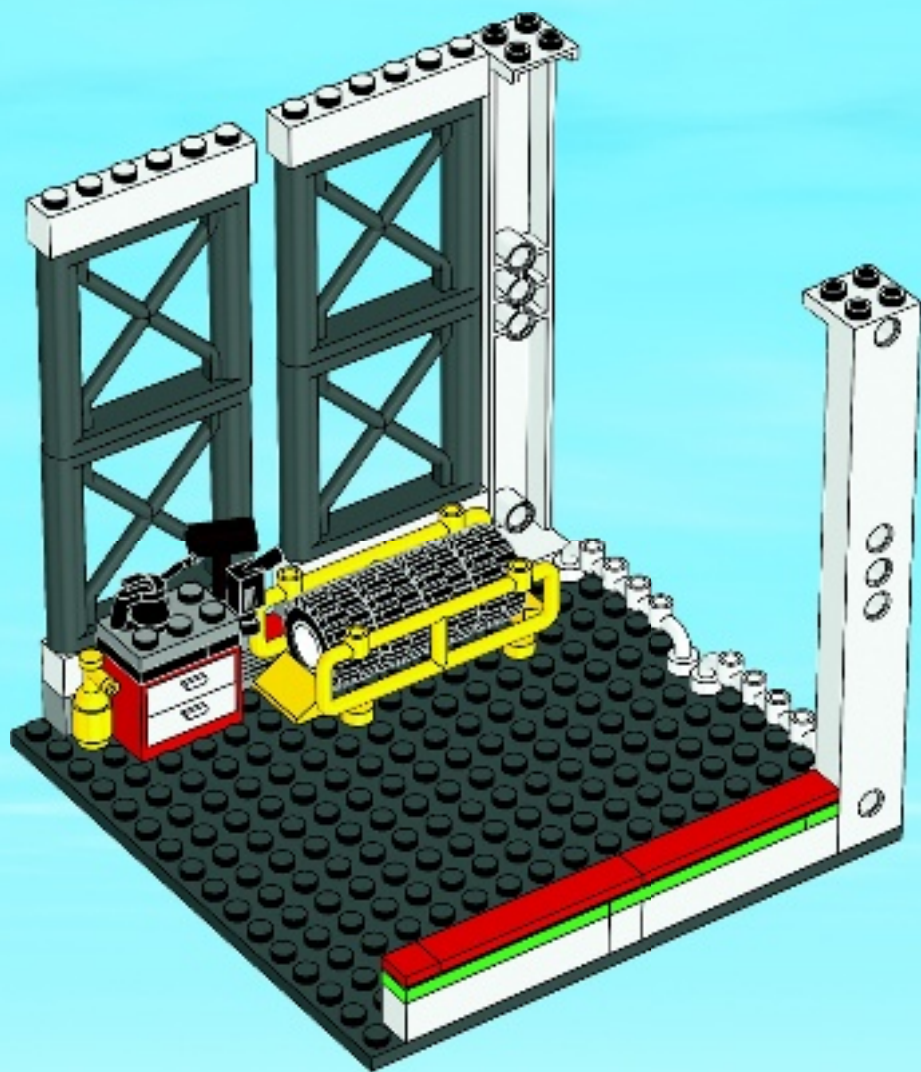



46

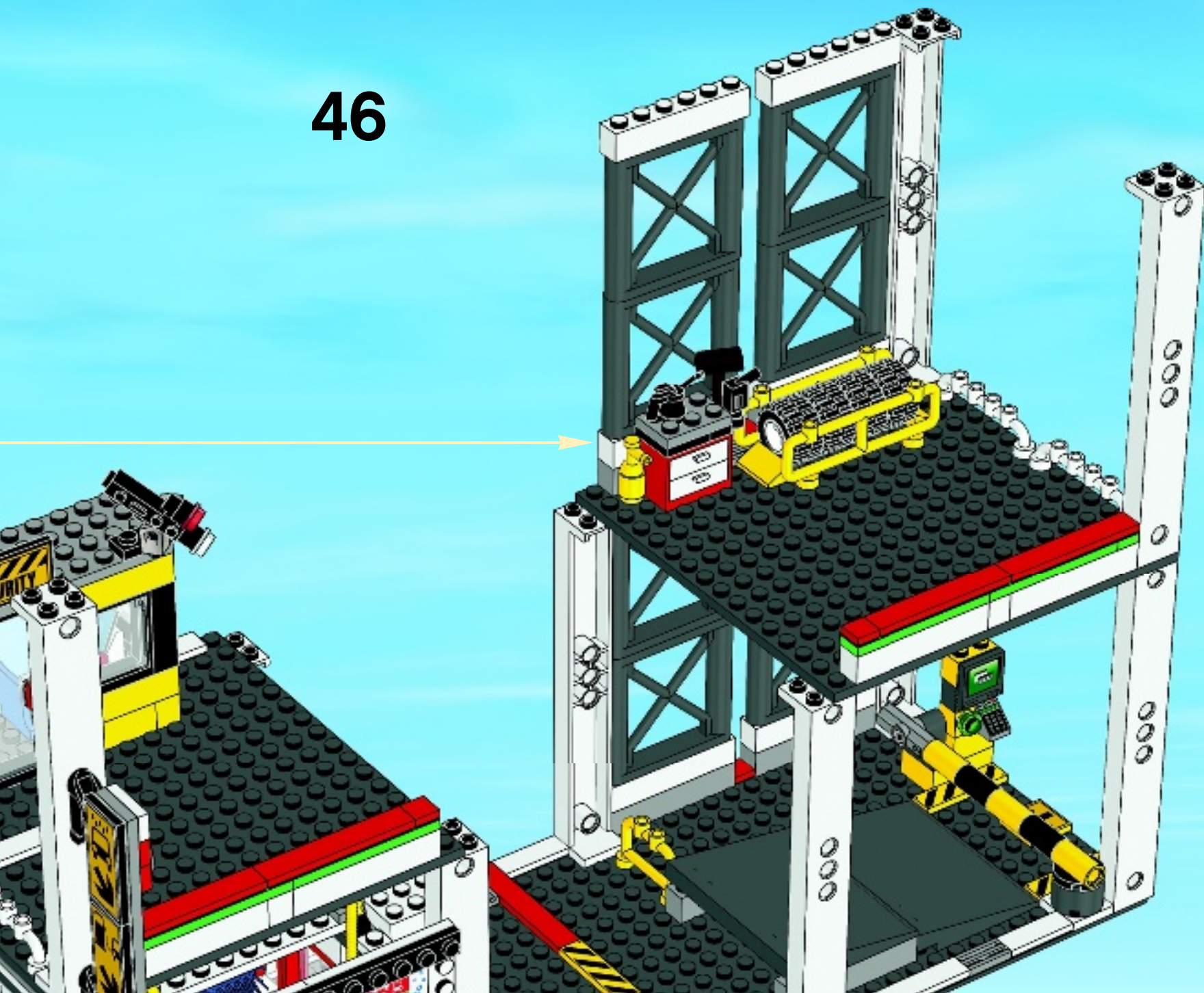

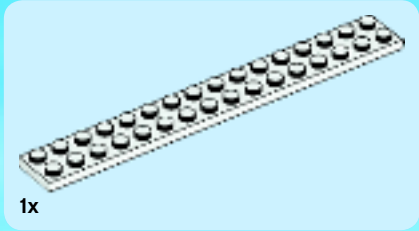
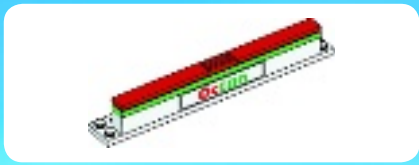

1x

**1**

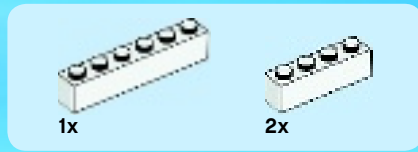
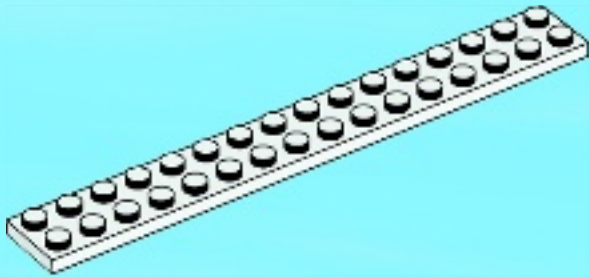

1x

2x

**2**

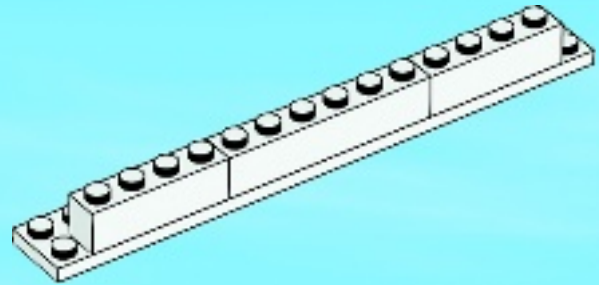

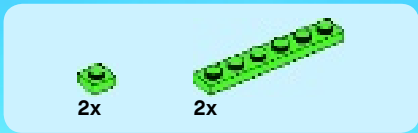

3

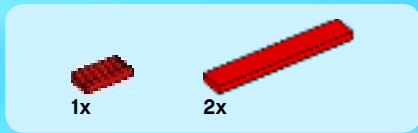
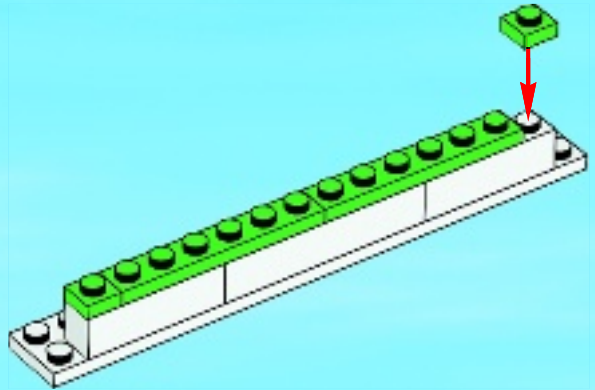

4

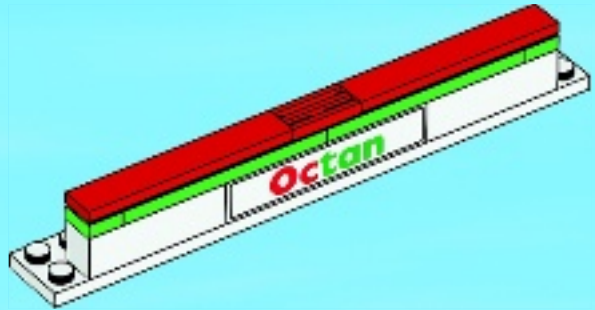



47

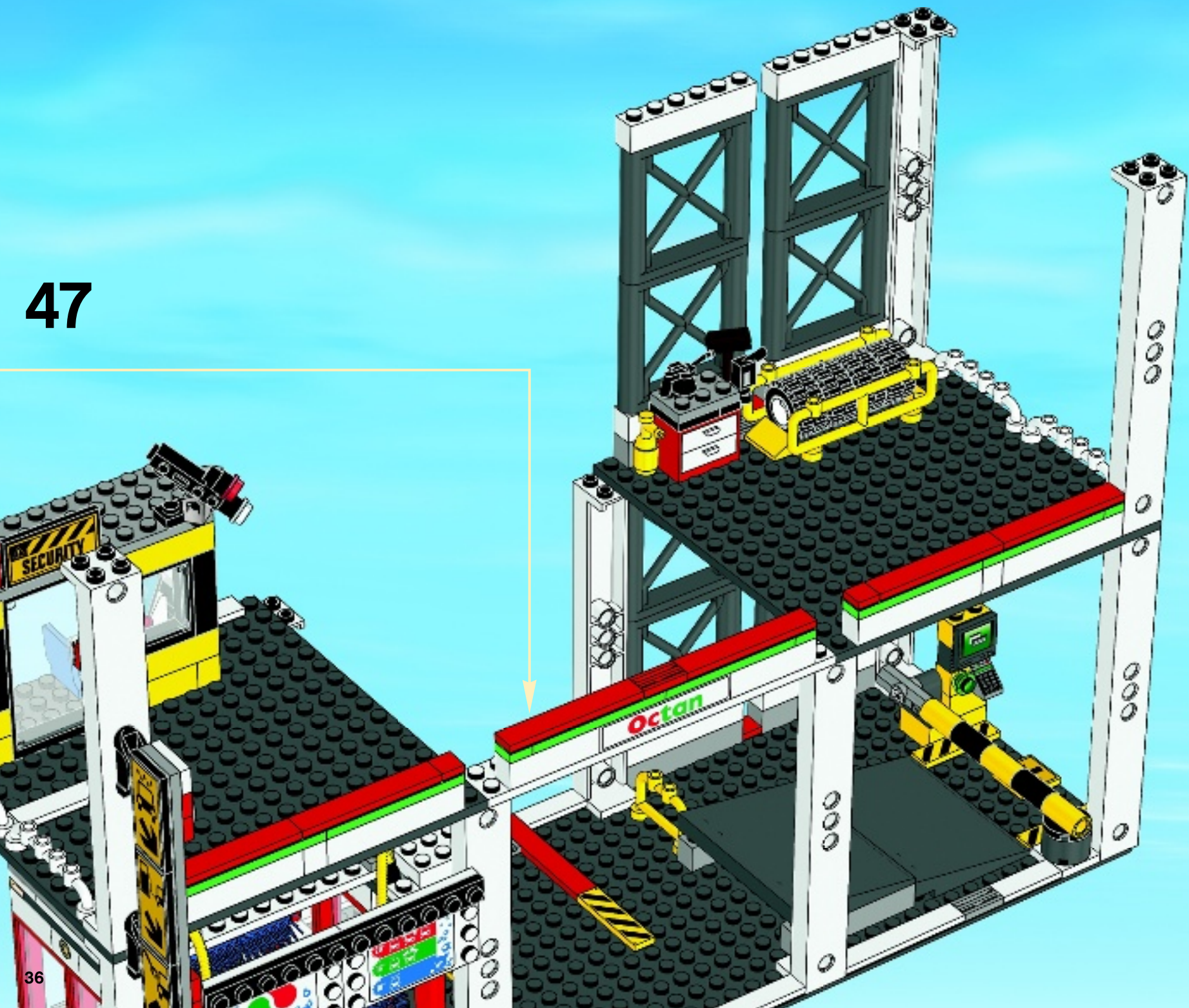





2x

48



2x

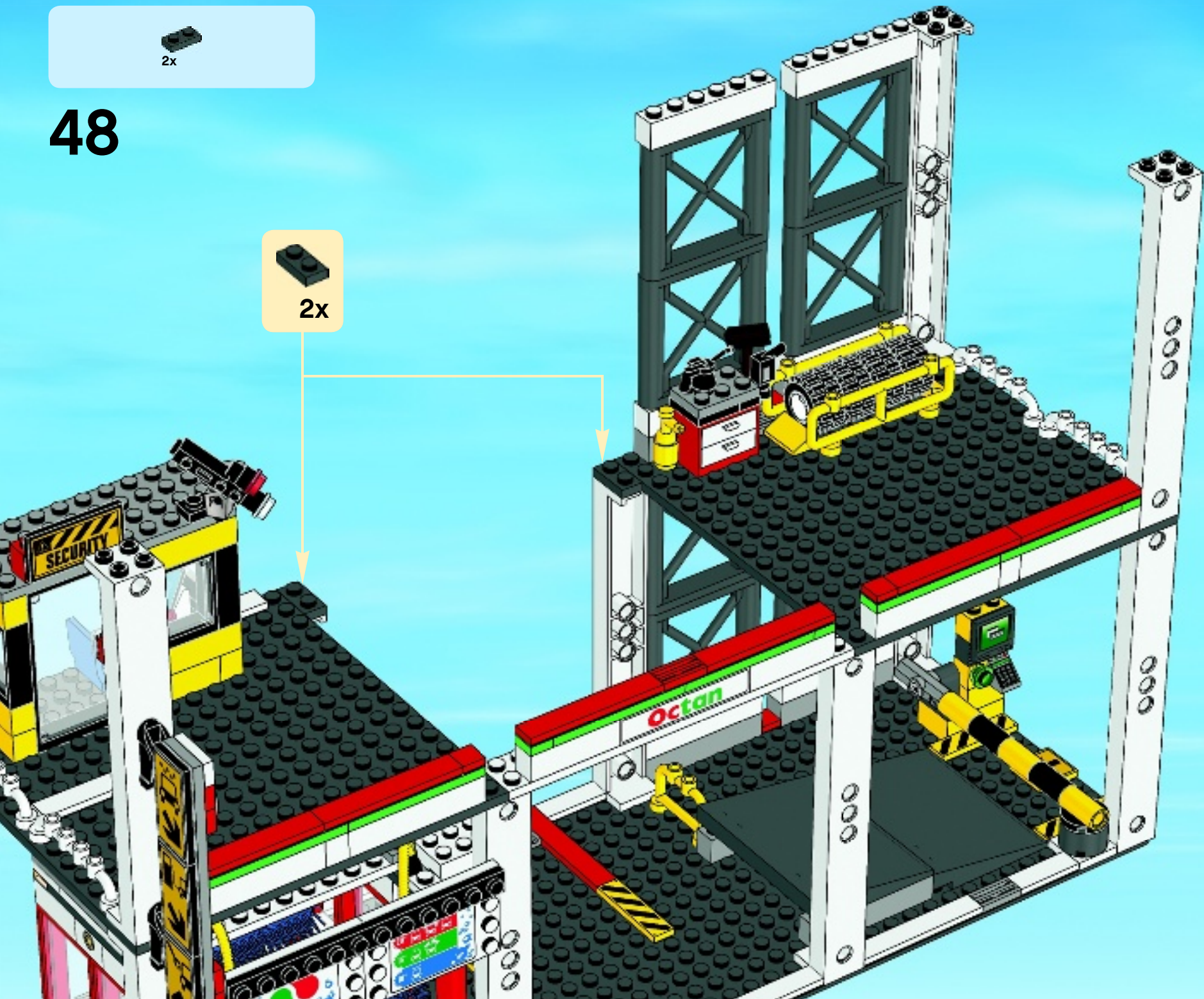



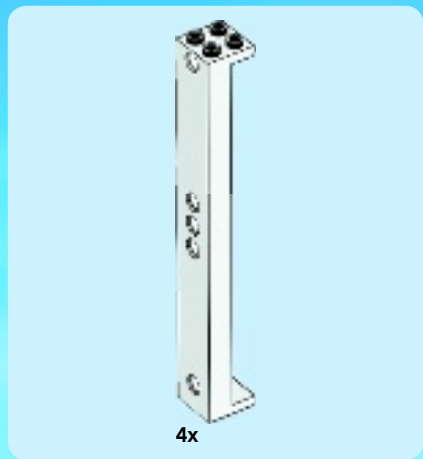

49

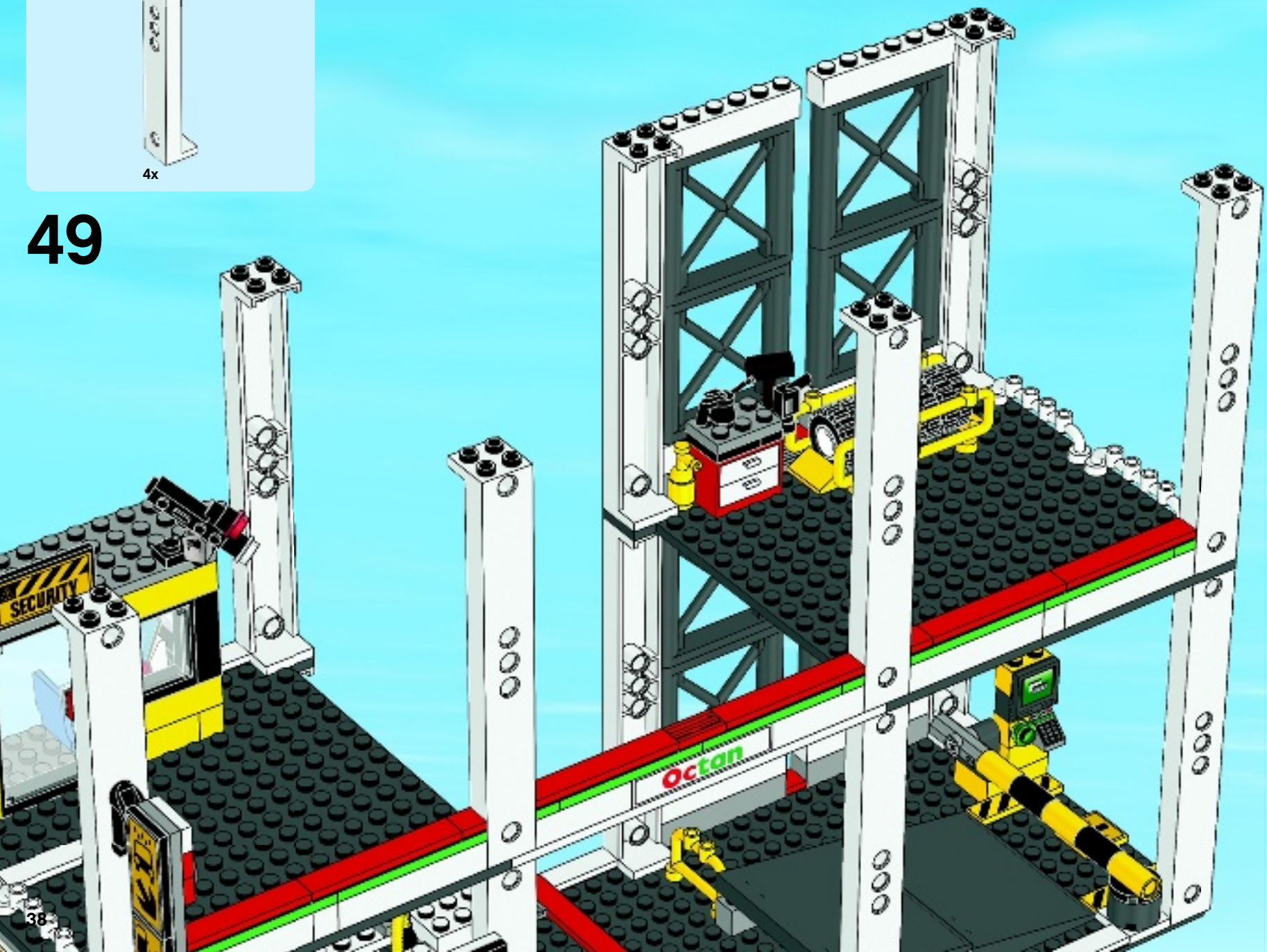





2x

# 50

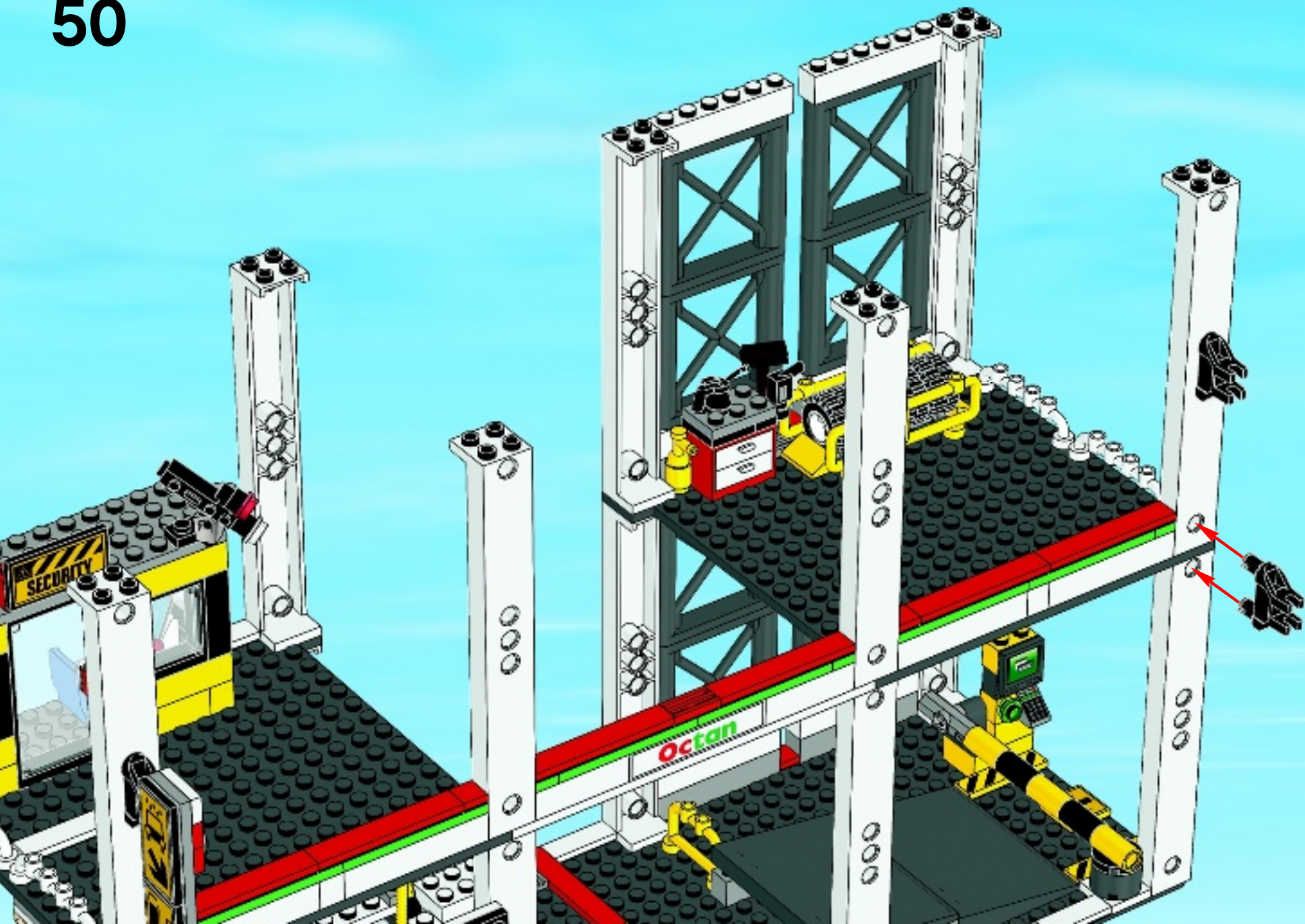



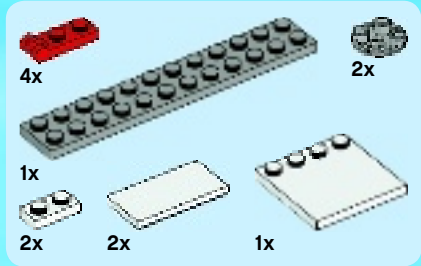

# 51

1

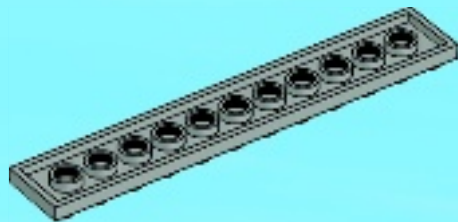

2

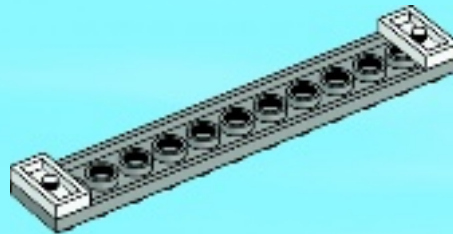

3

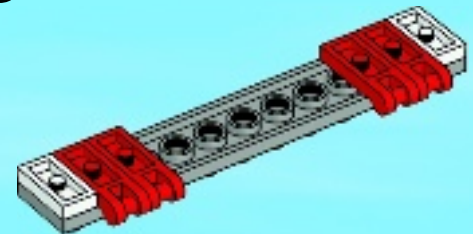

4

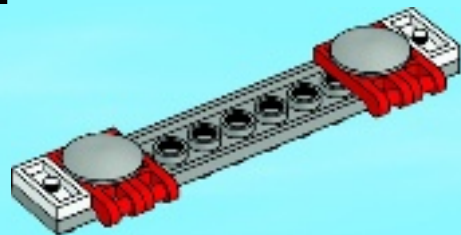

5

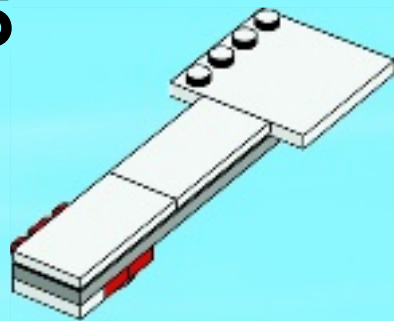

6

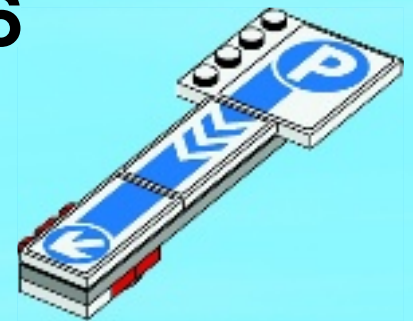

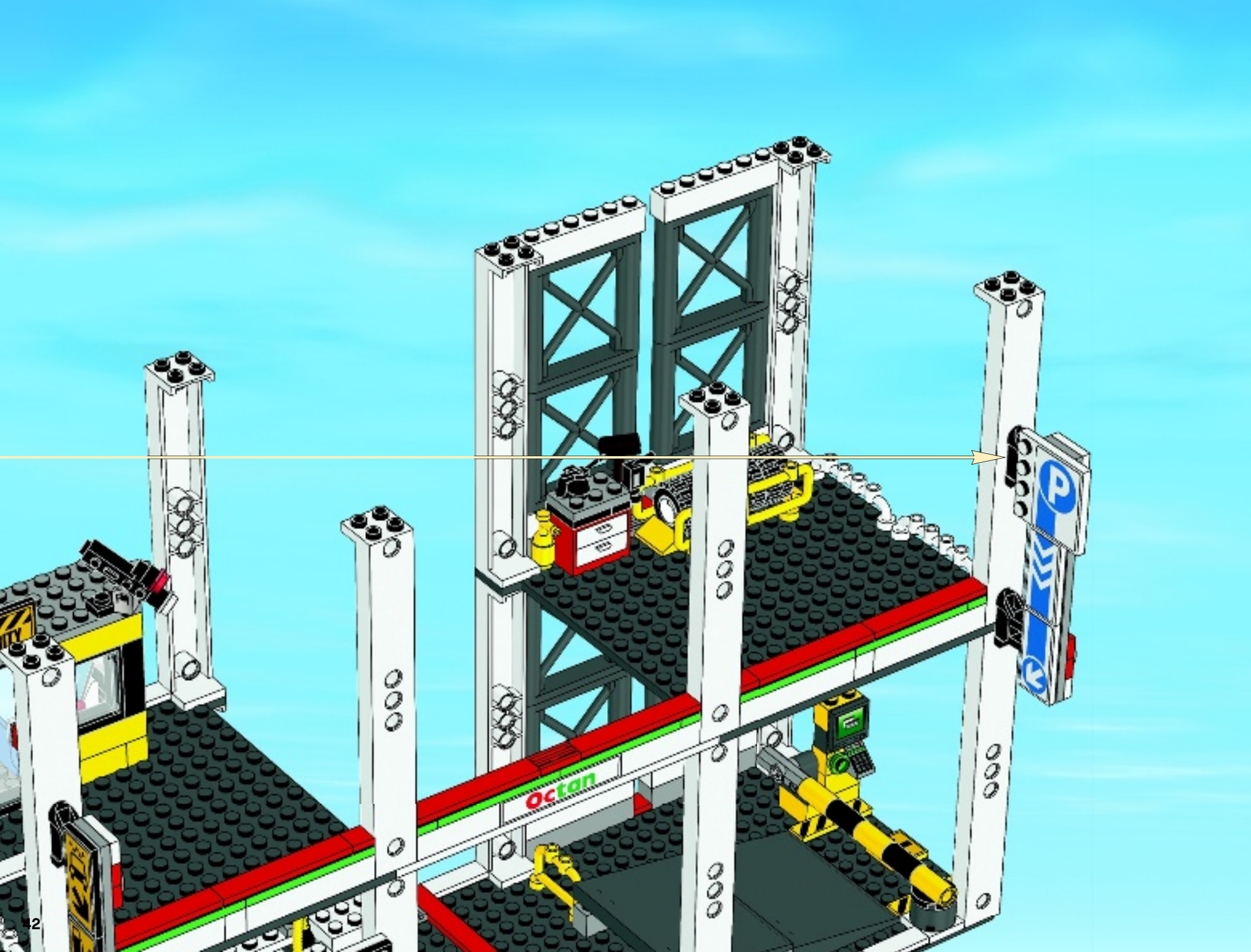



8x

52

8x

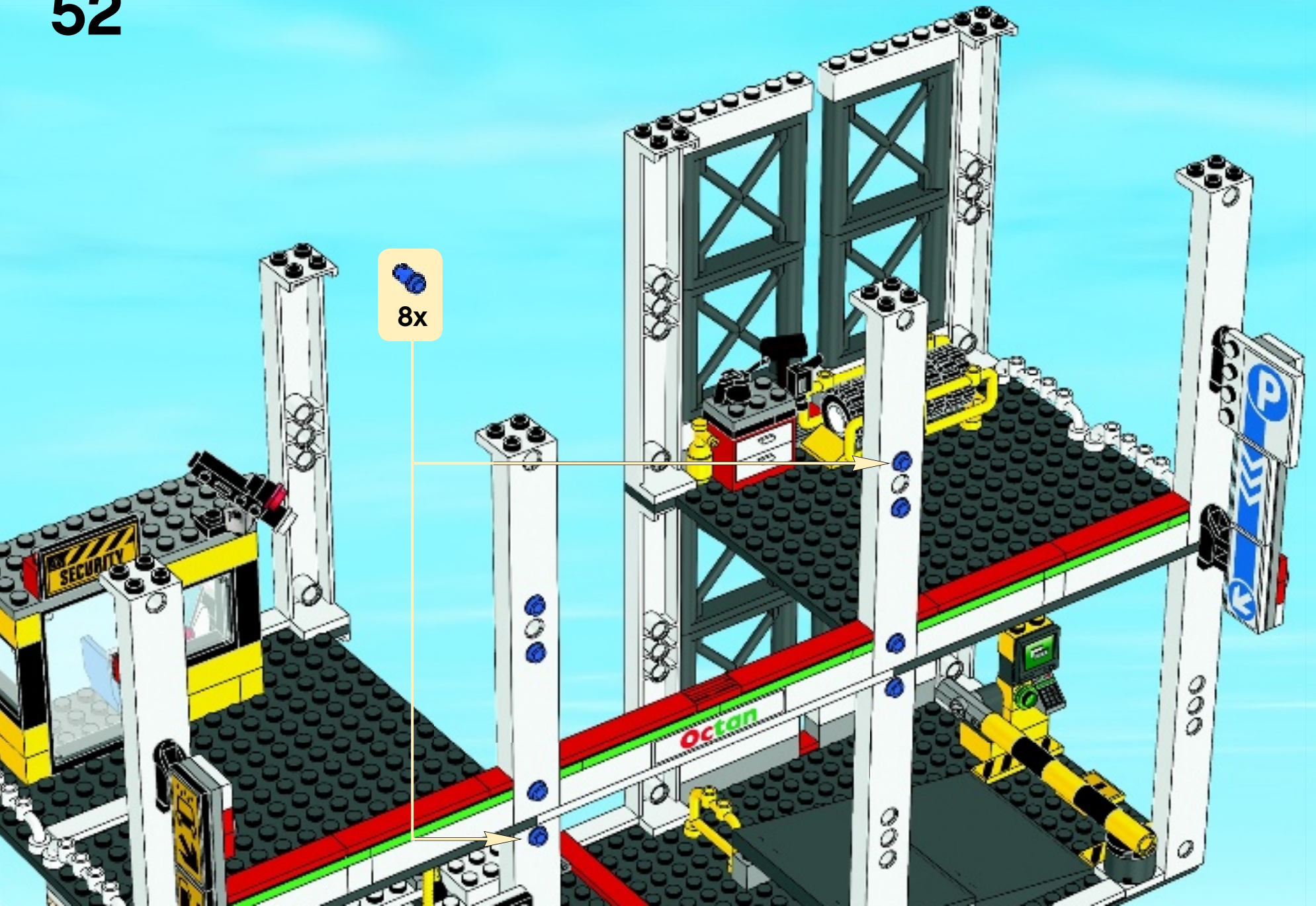





2x

# 53

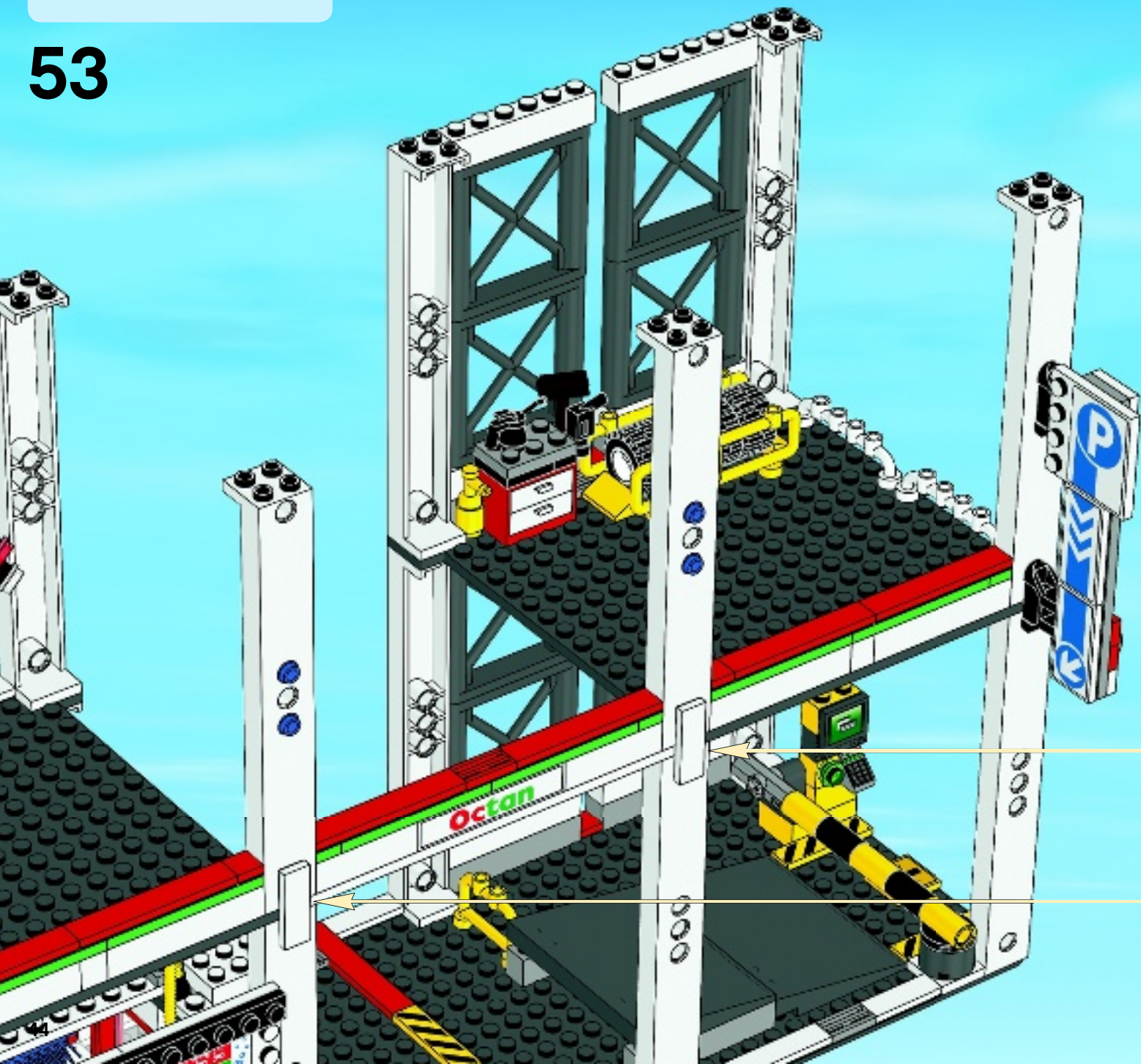

2x





2x



6x

# 54

1

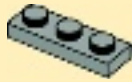

2



2x

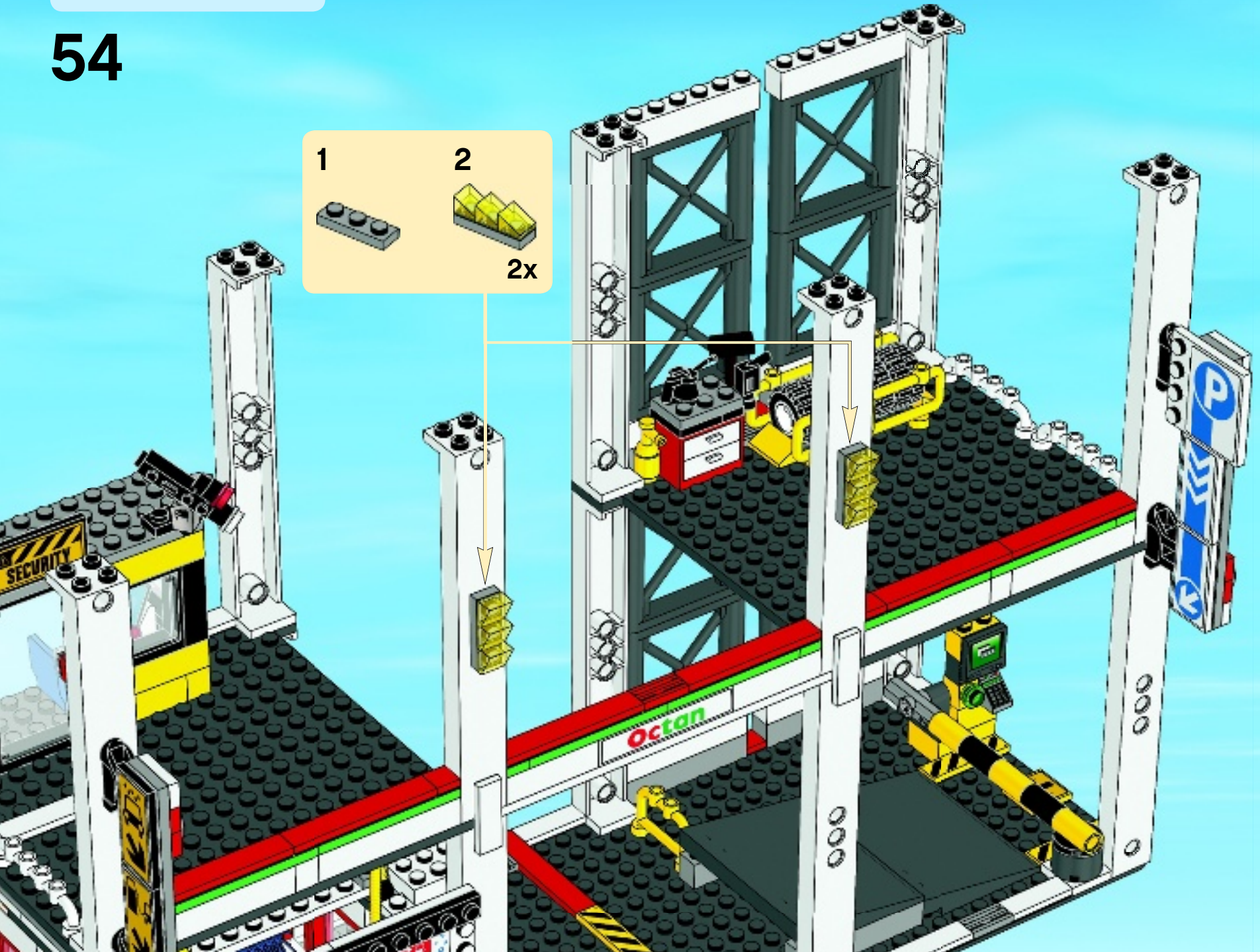



8x

55



8x

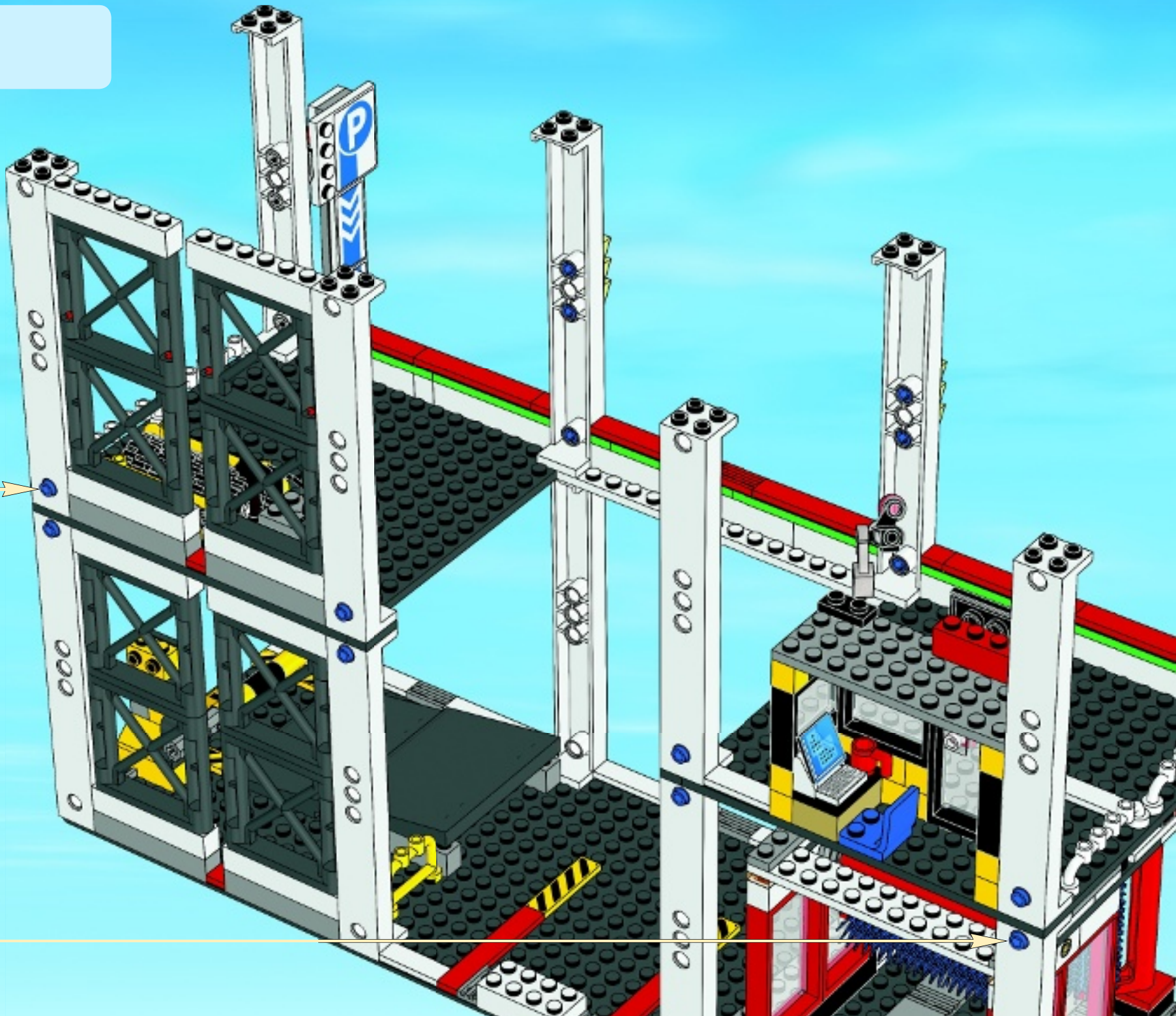





4x

56

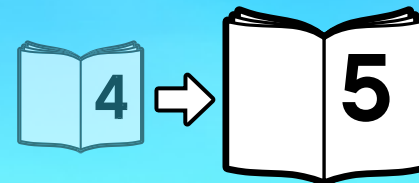

4x

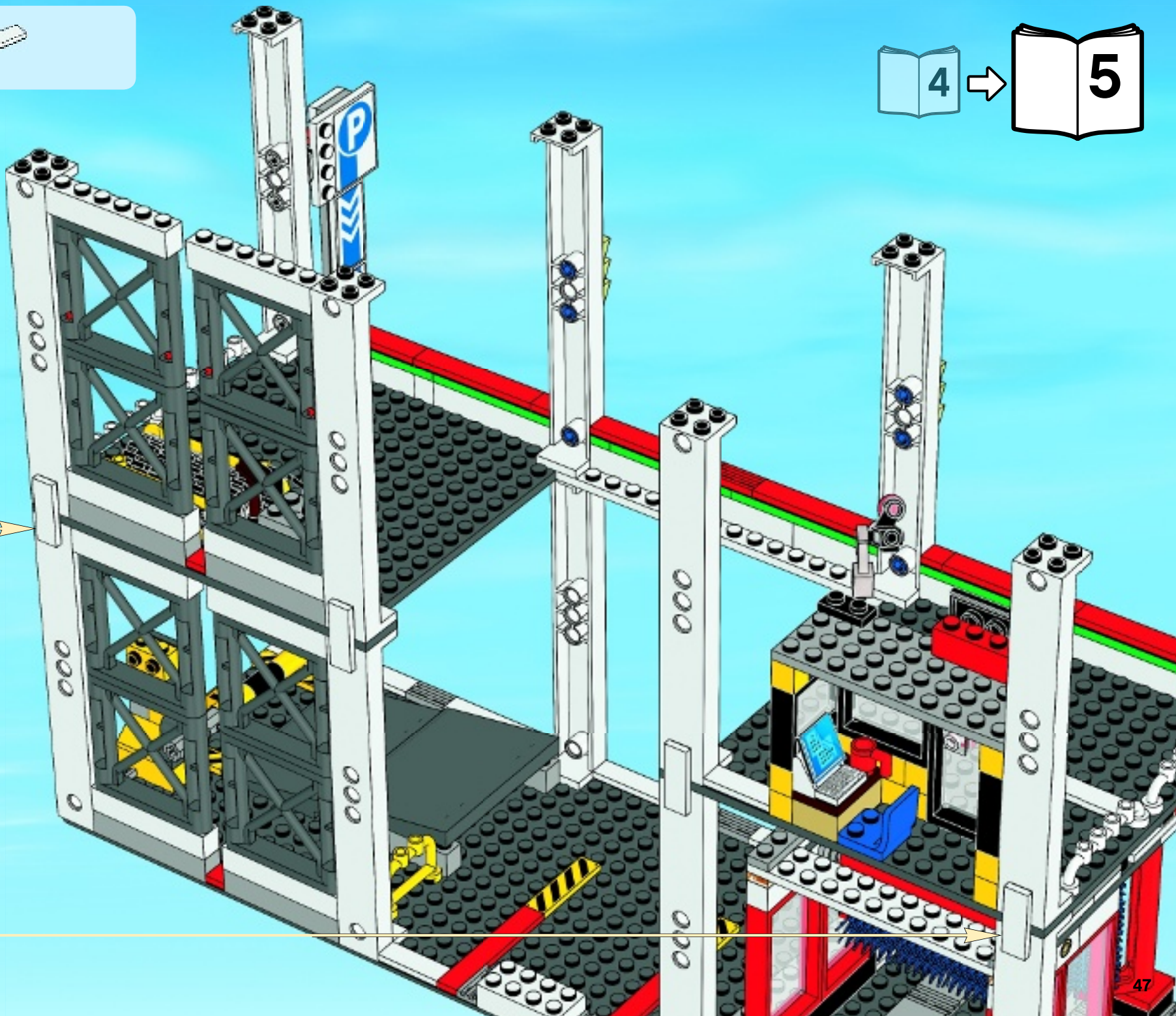









4207

# CITY



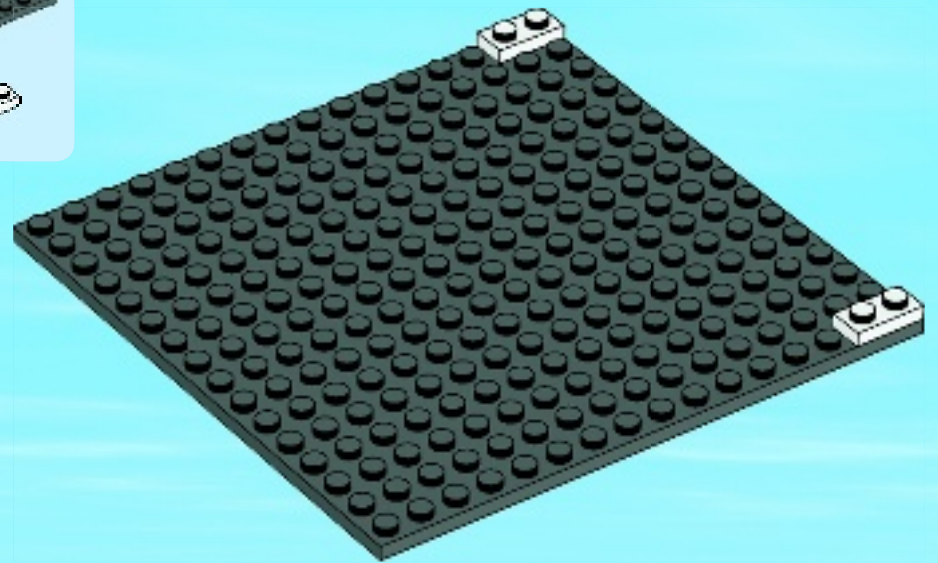
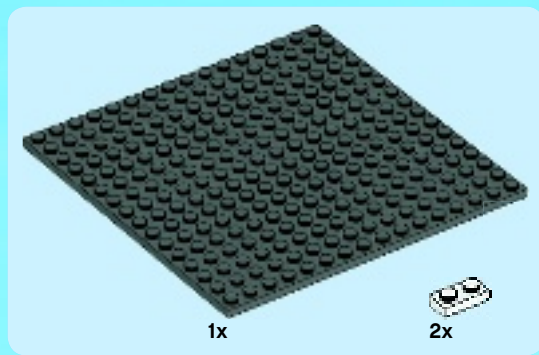
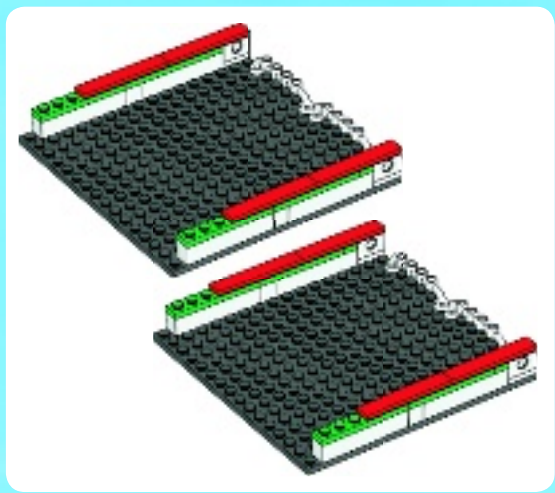
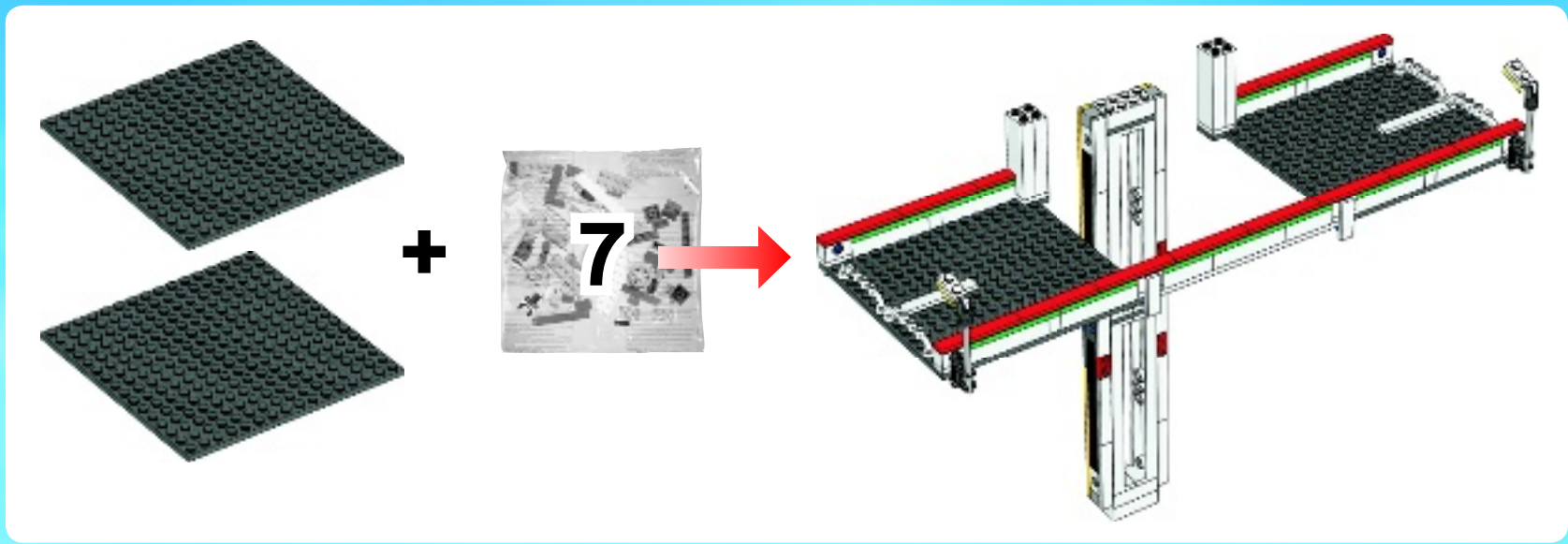





2x



2x

2

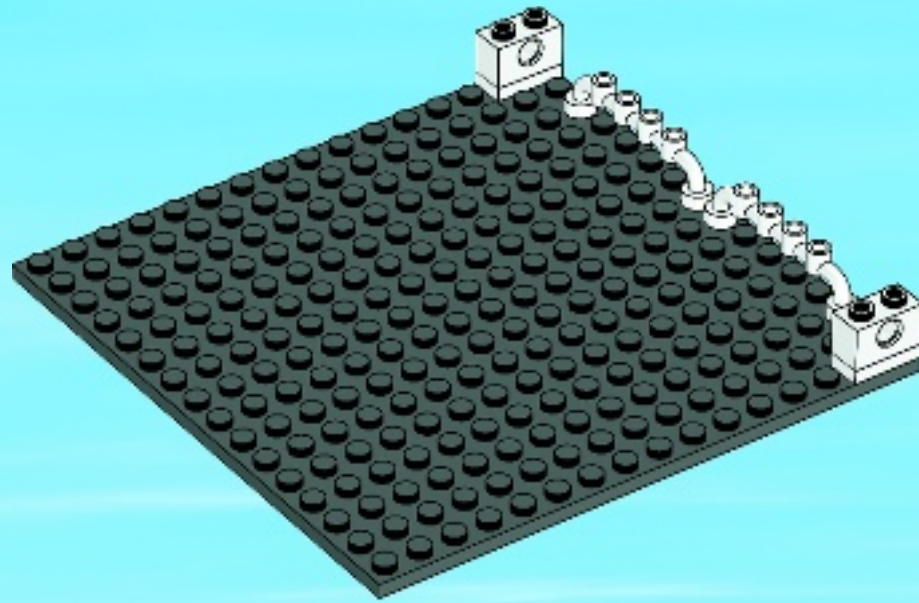



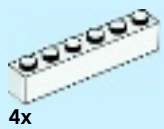

4x



2x

3

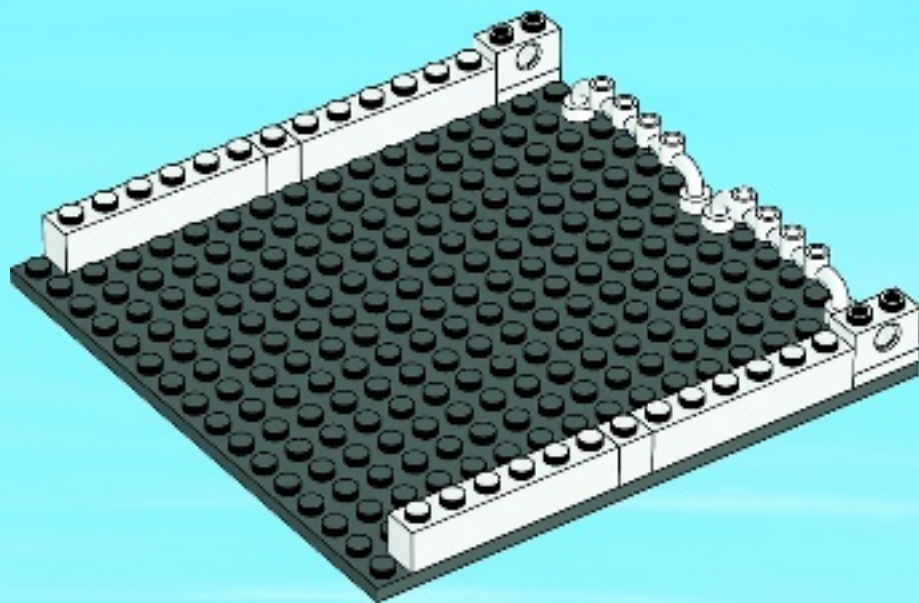

4

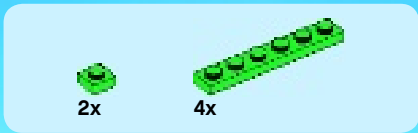

4

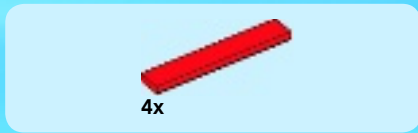
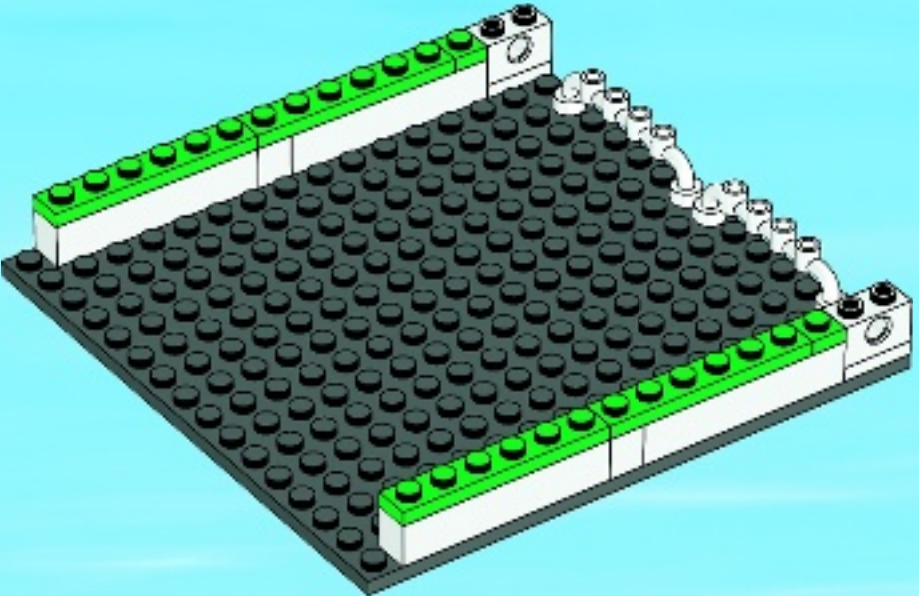

5

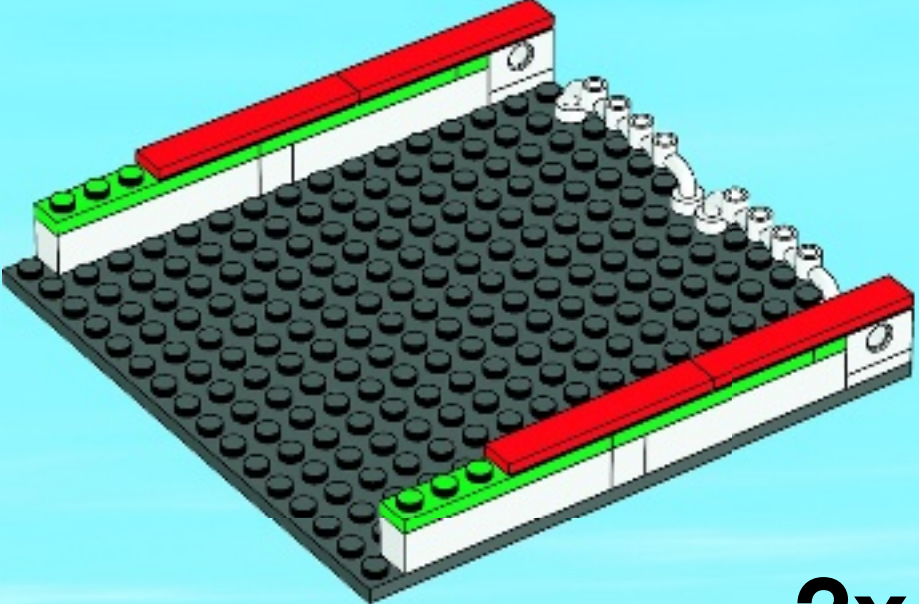

2x





57

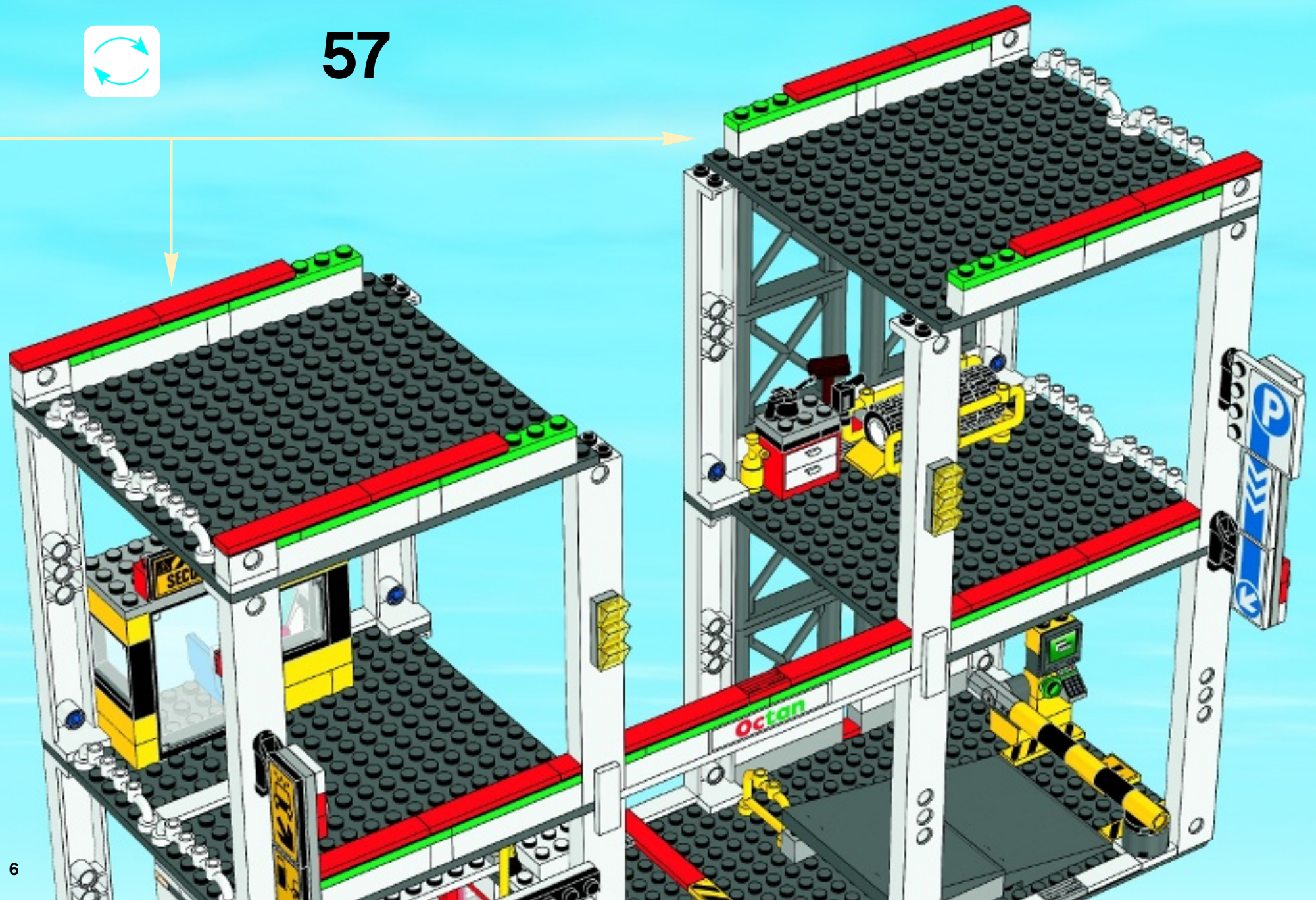





2x

# 58

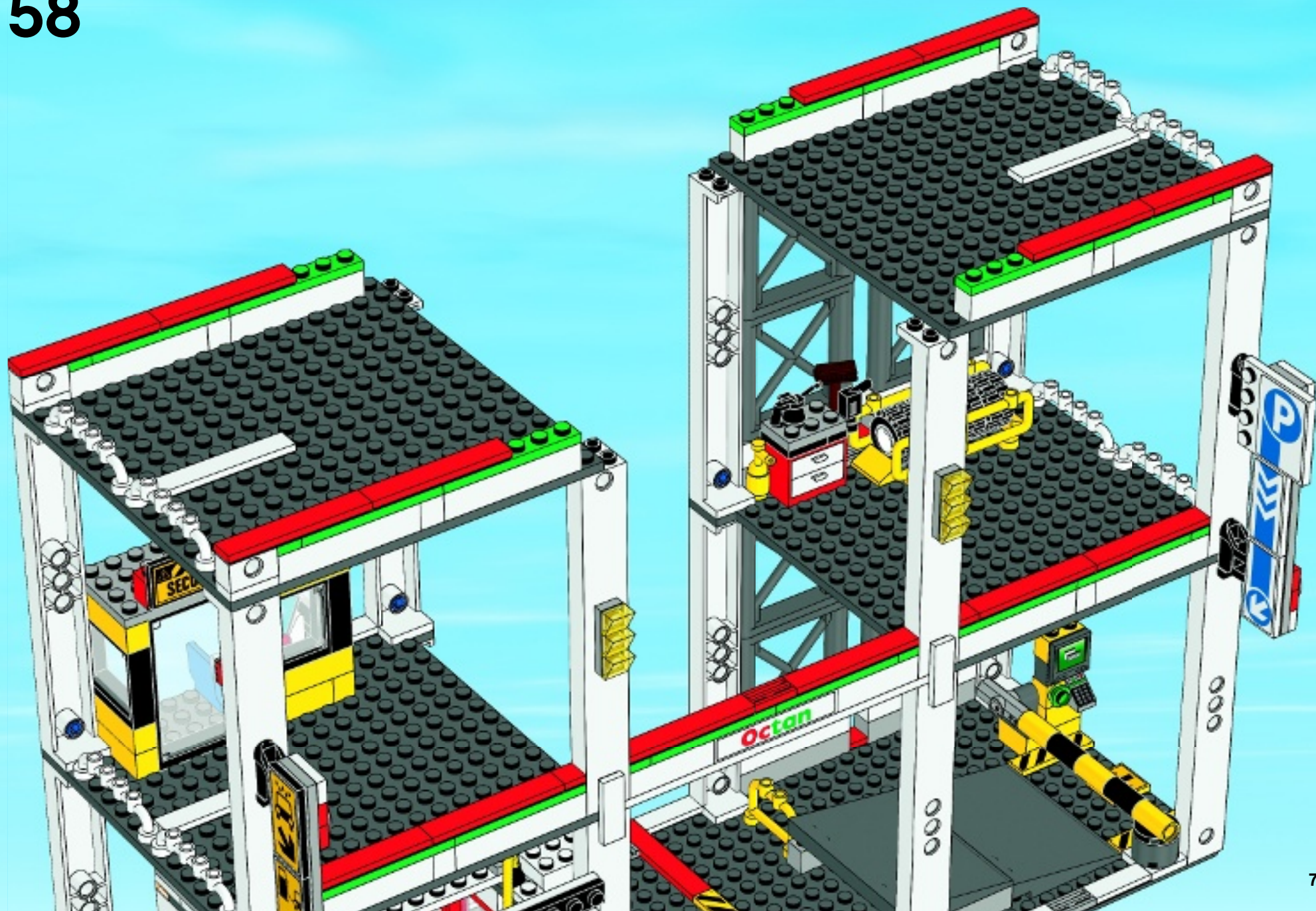





2x

59



2x

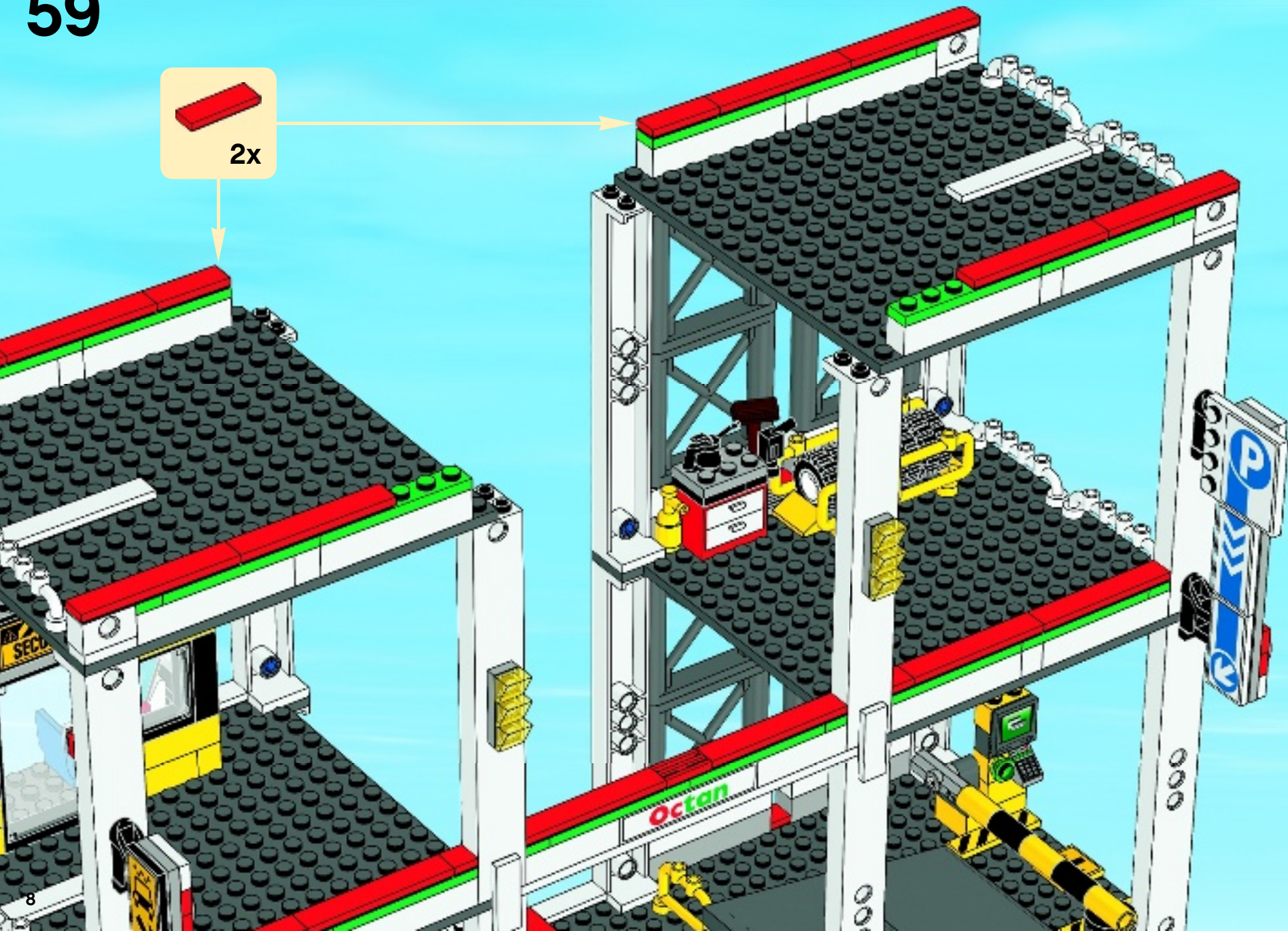





2x

60



2x

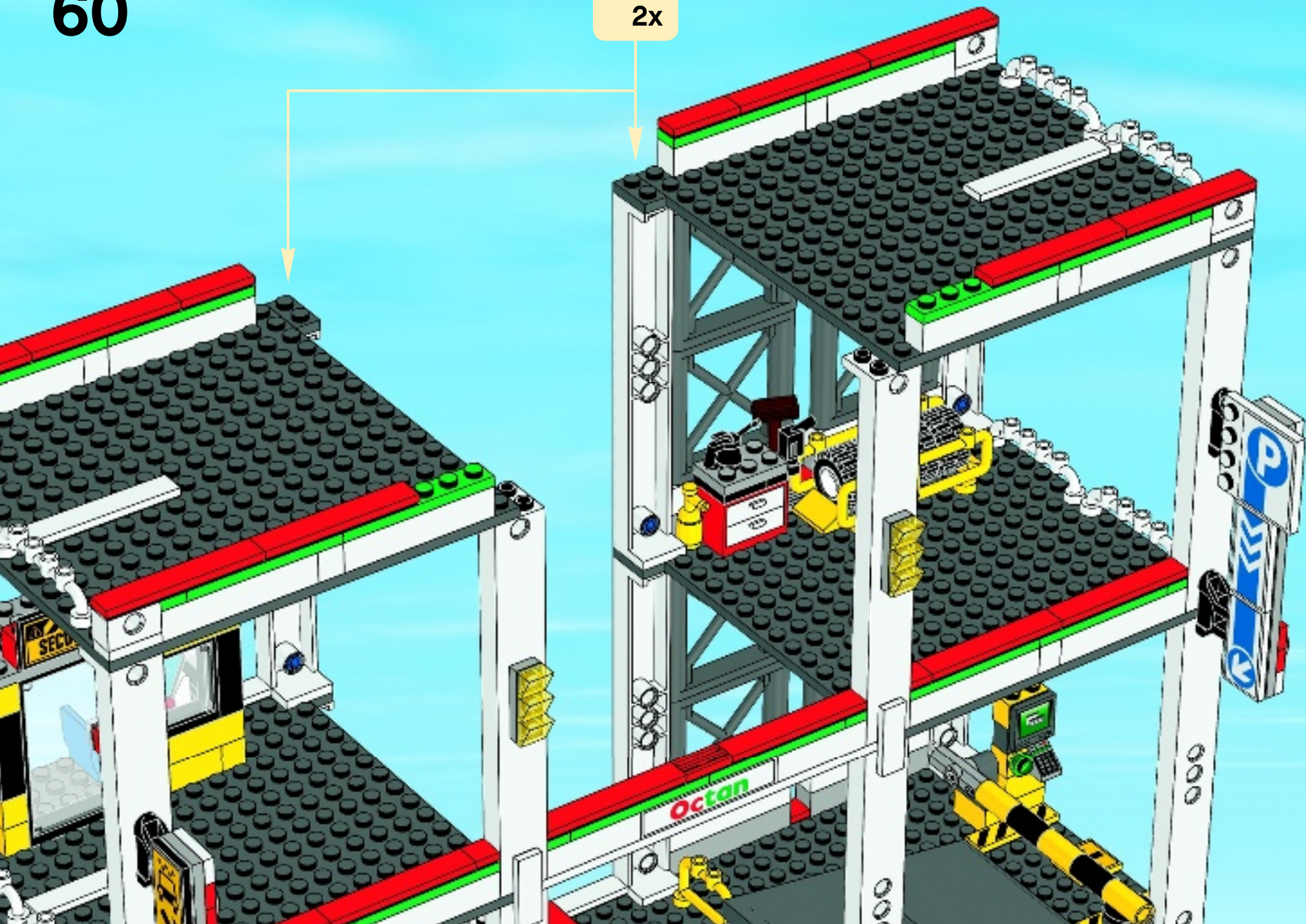





2x

61



2x

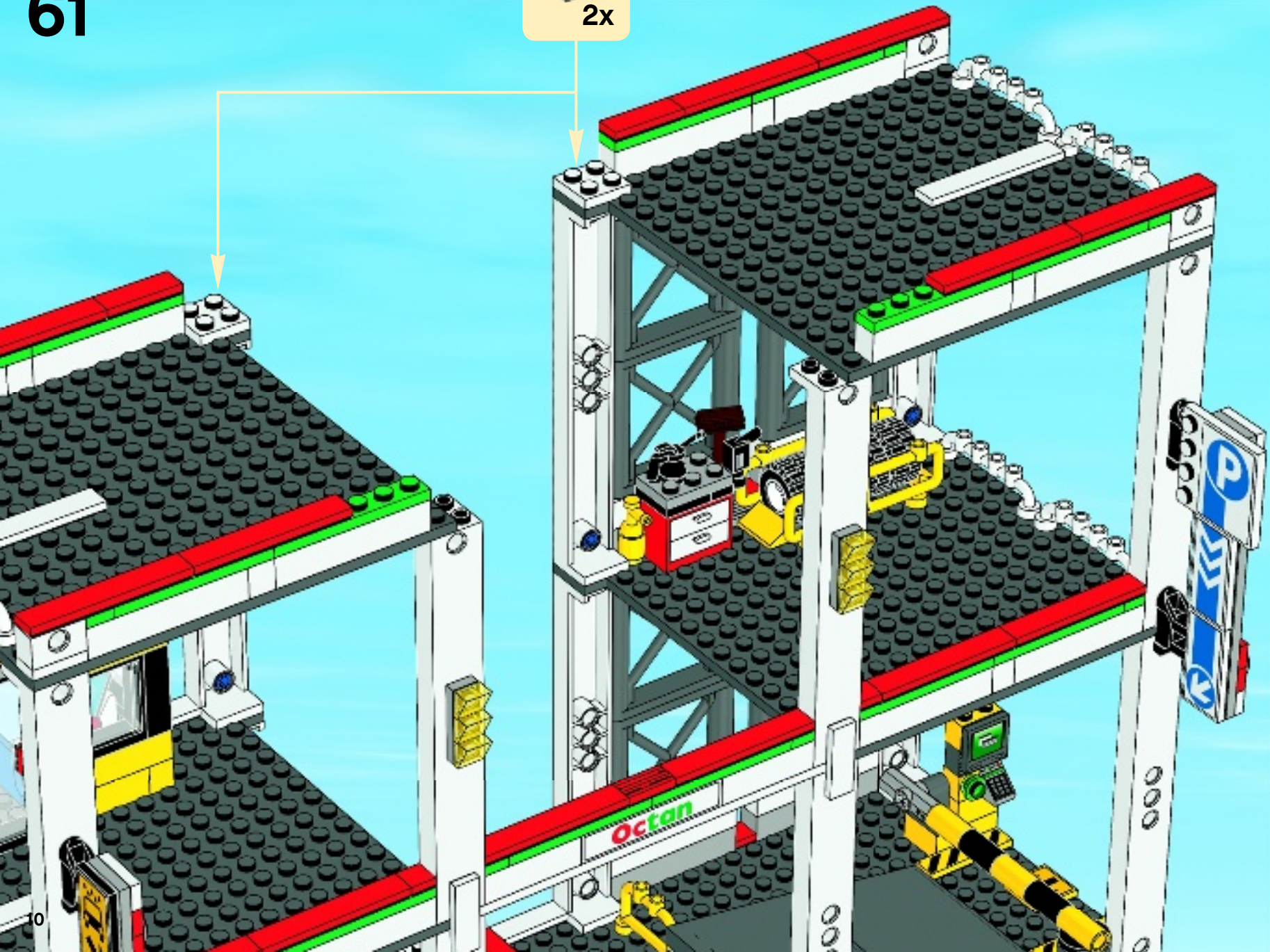





4x

62

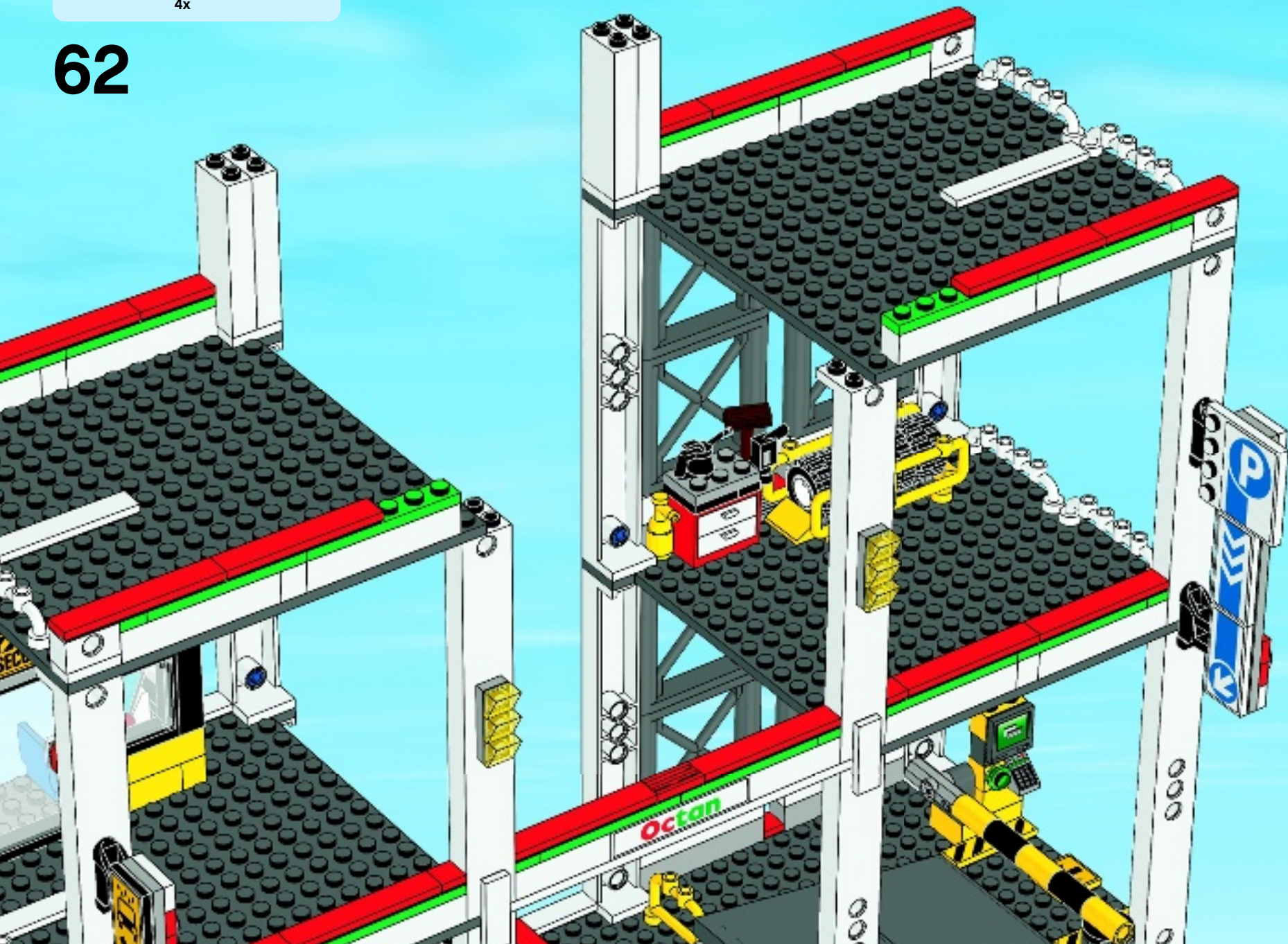

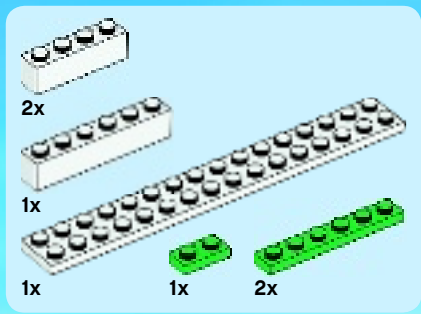

# 63

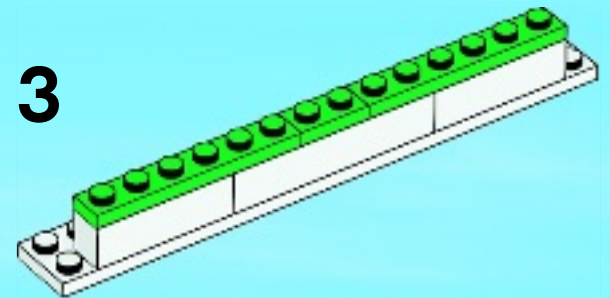
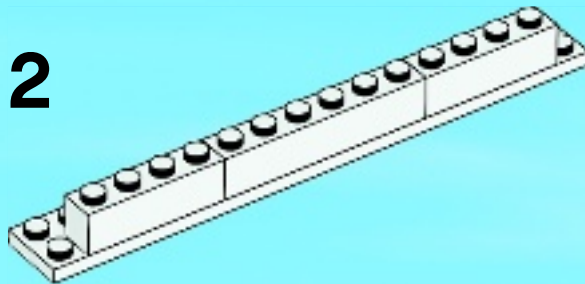
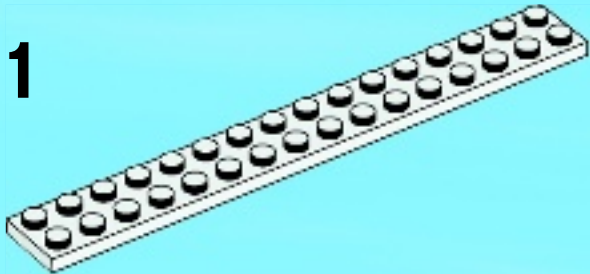









2x



2x

# 64

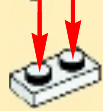
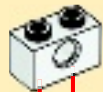

2x

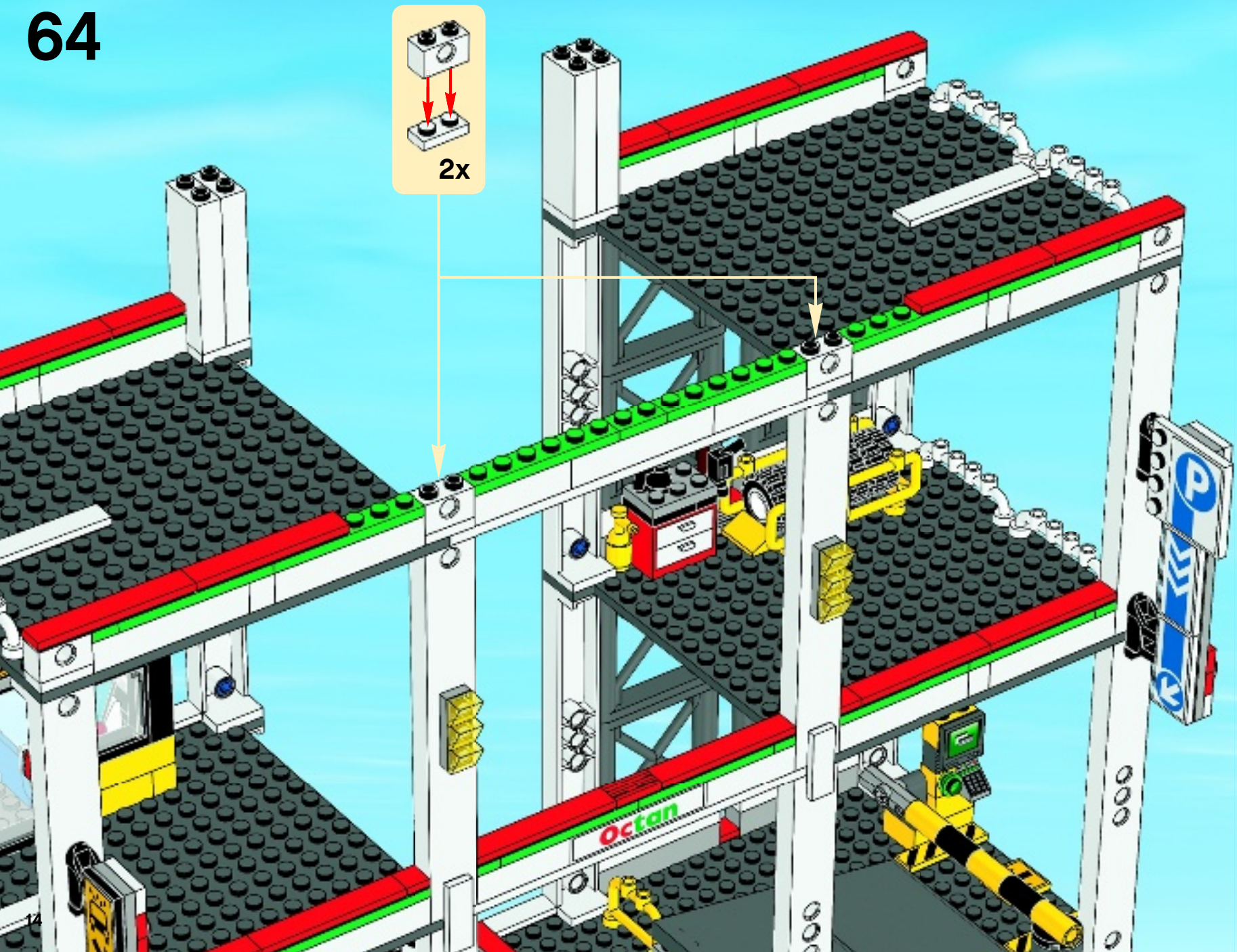



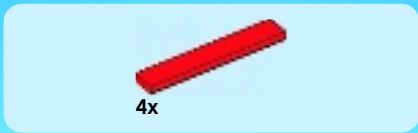

65

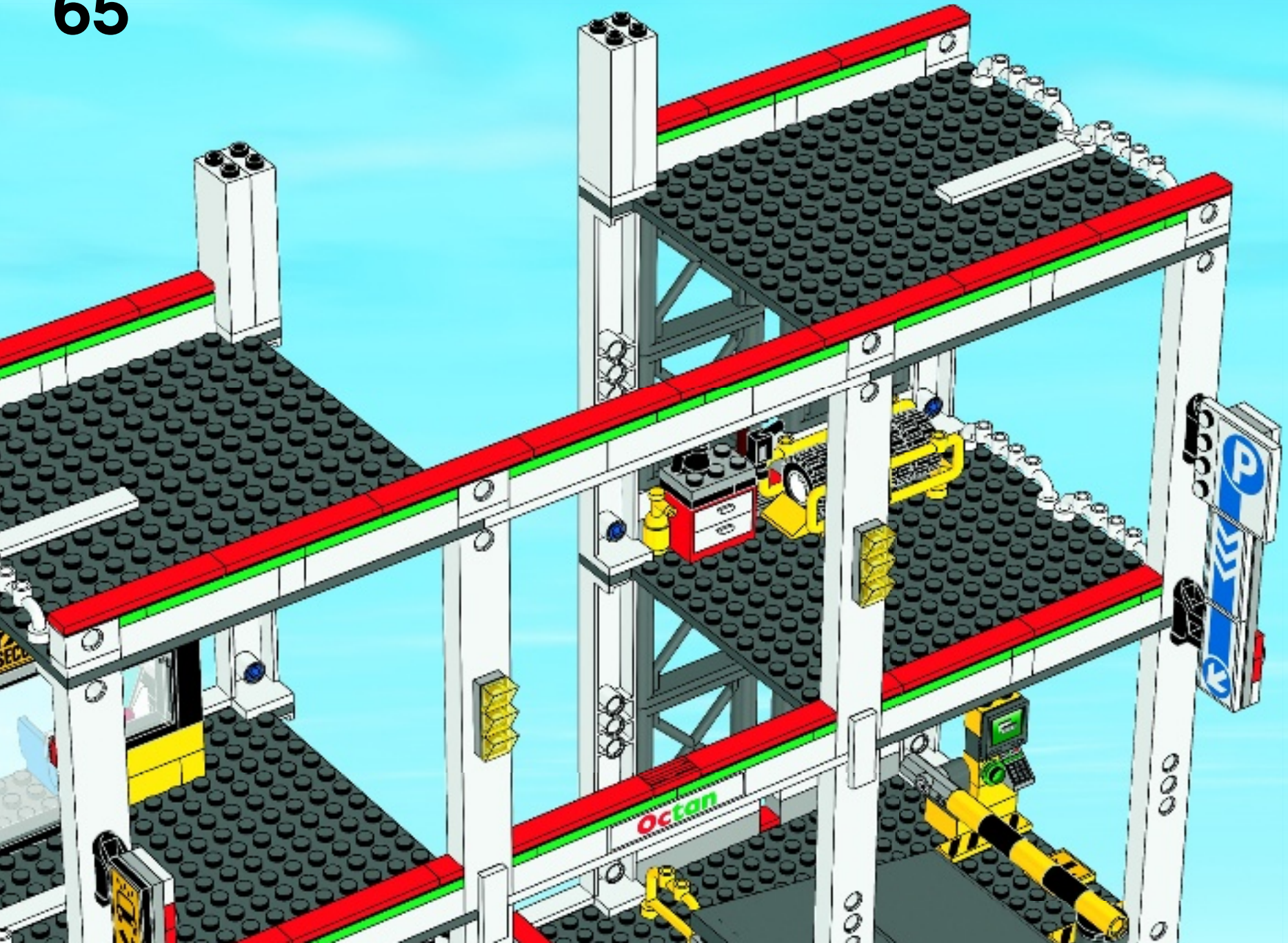





2x

66

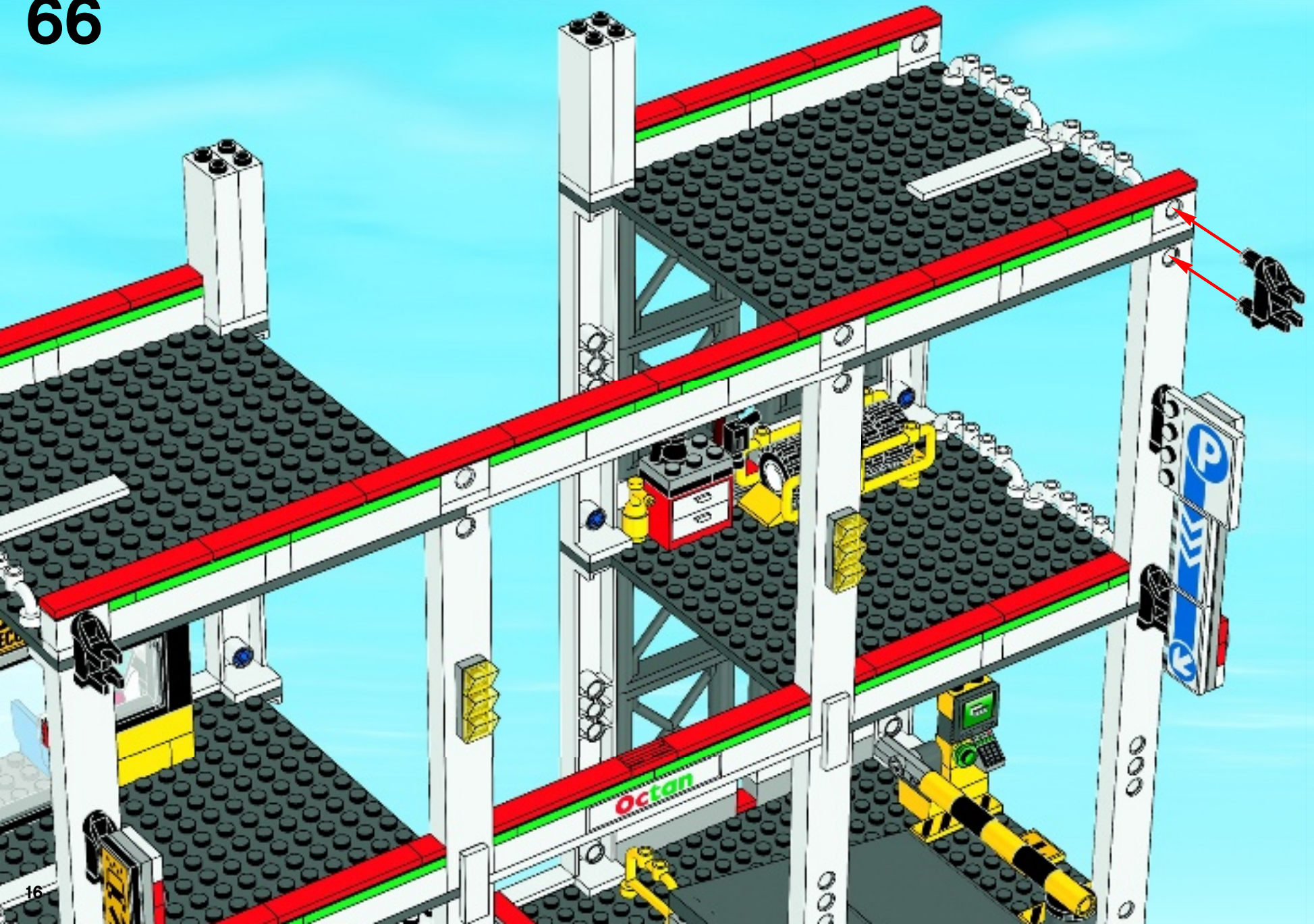

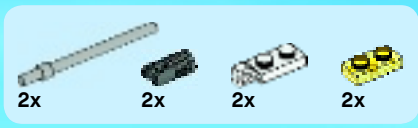

# 67

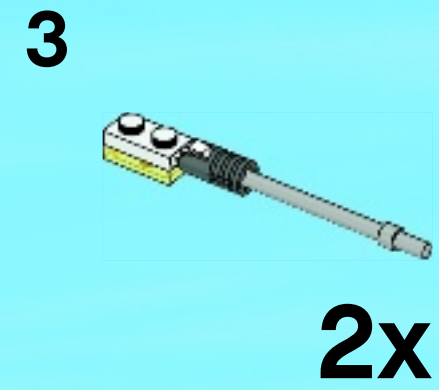
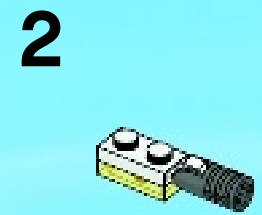
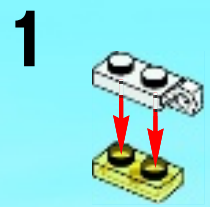



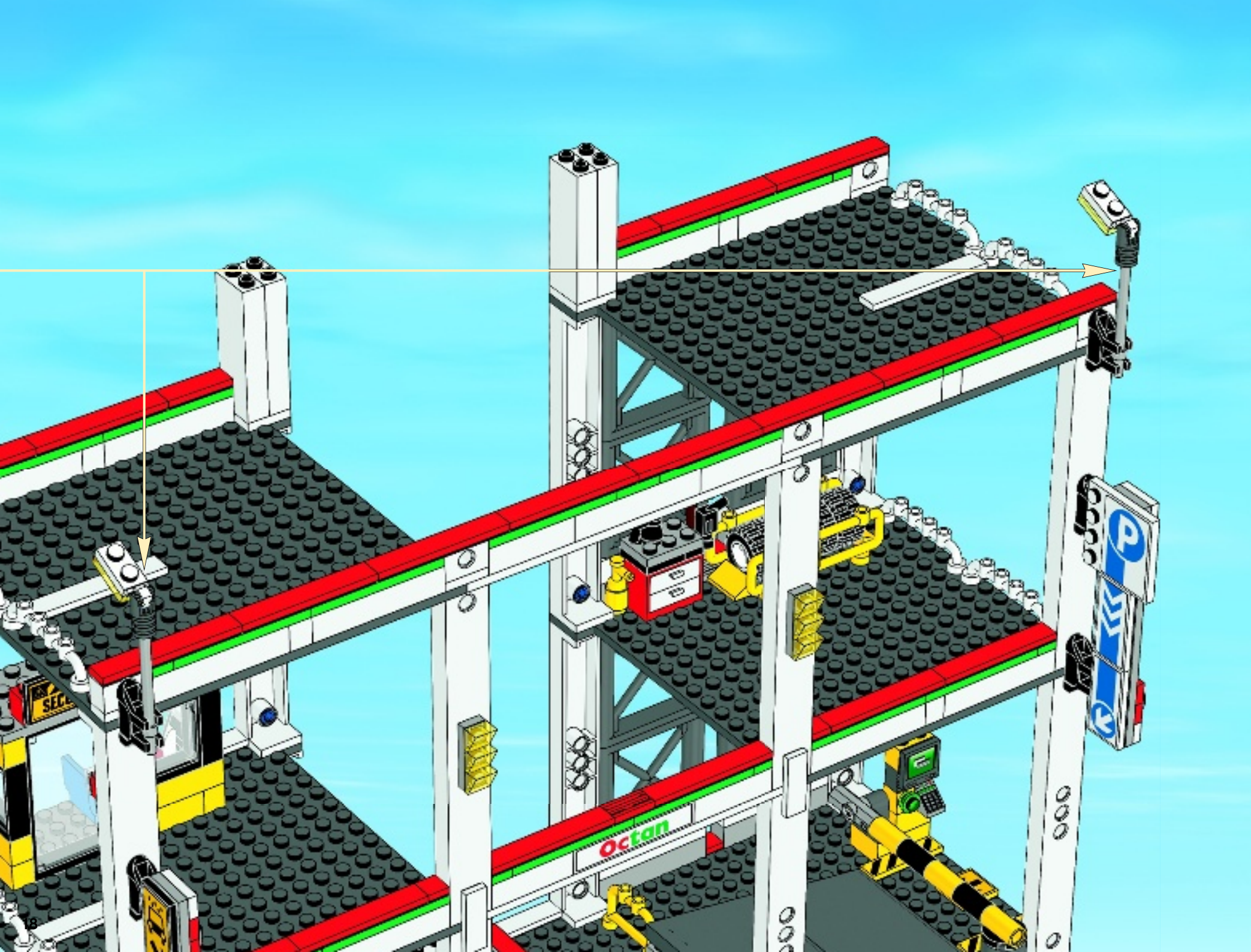



4x

68

4x

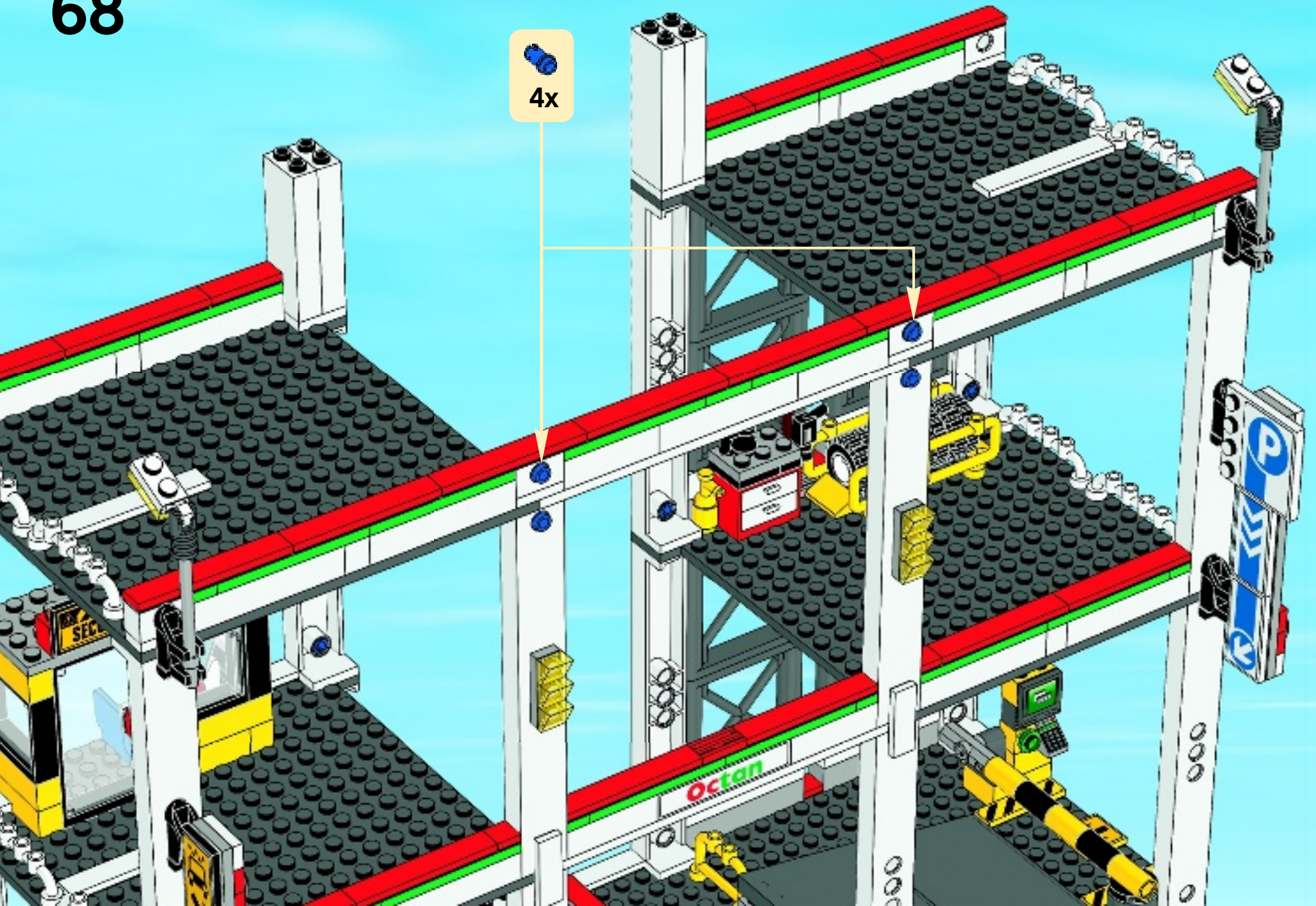





2x

69



2x

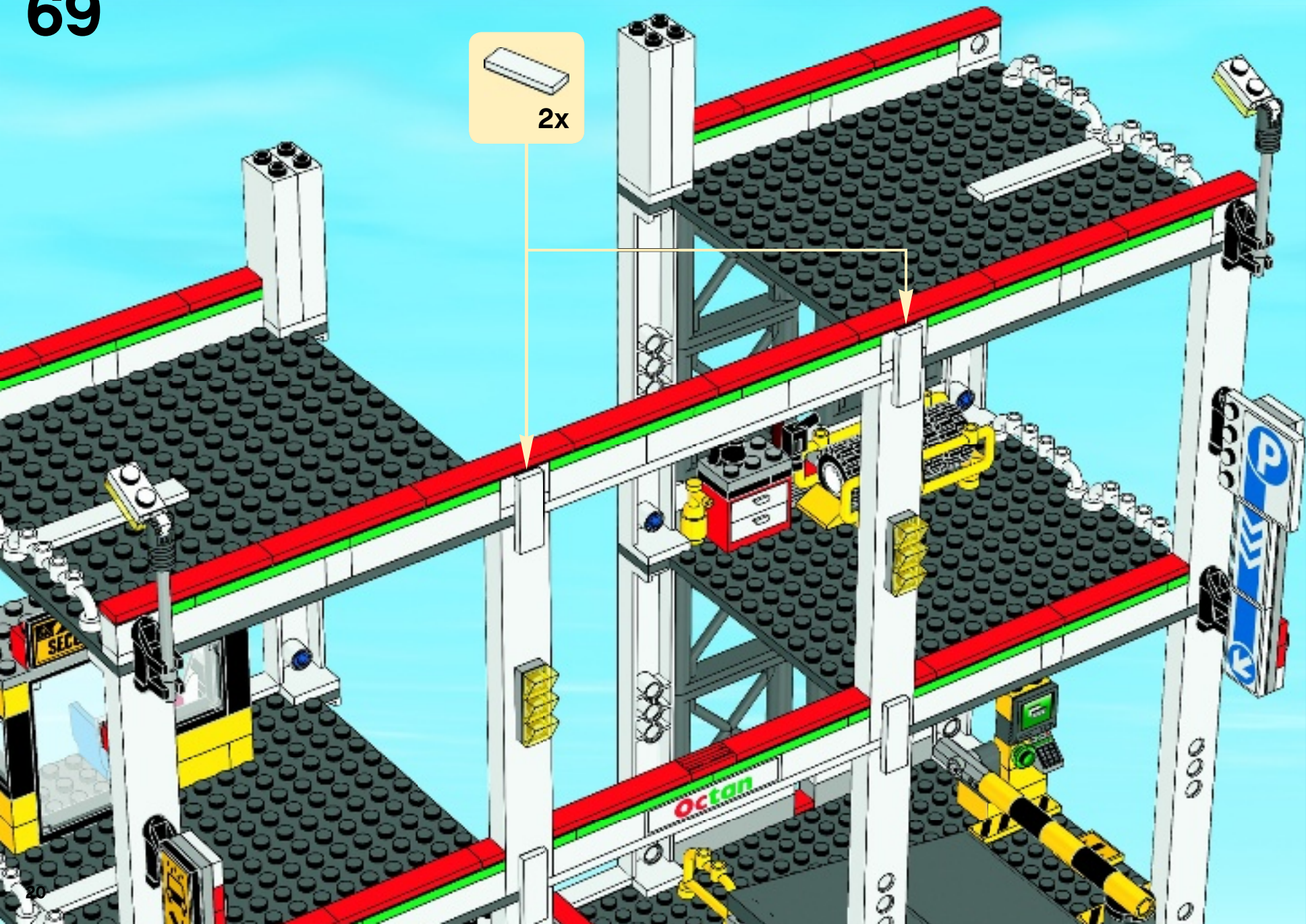



4x

70



4x

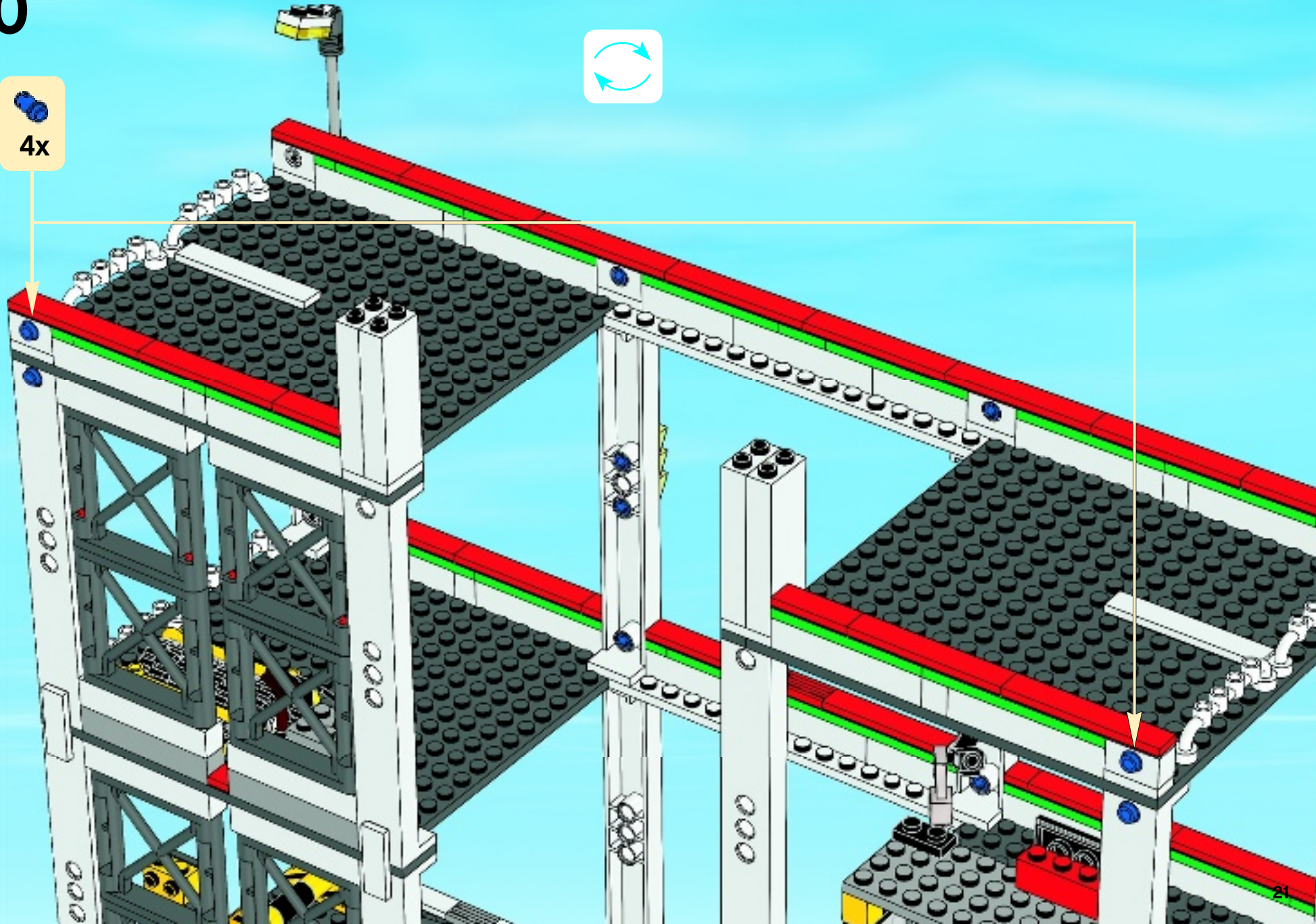





2x

# 71



2x

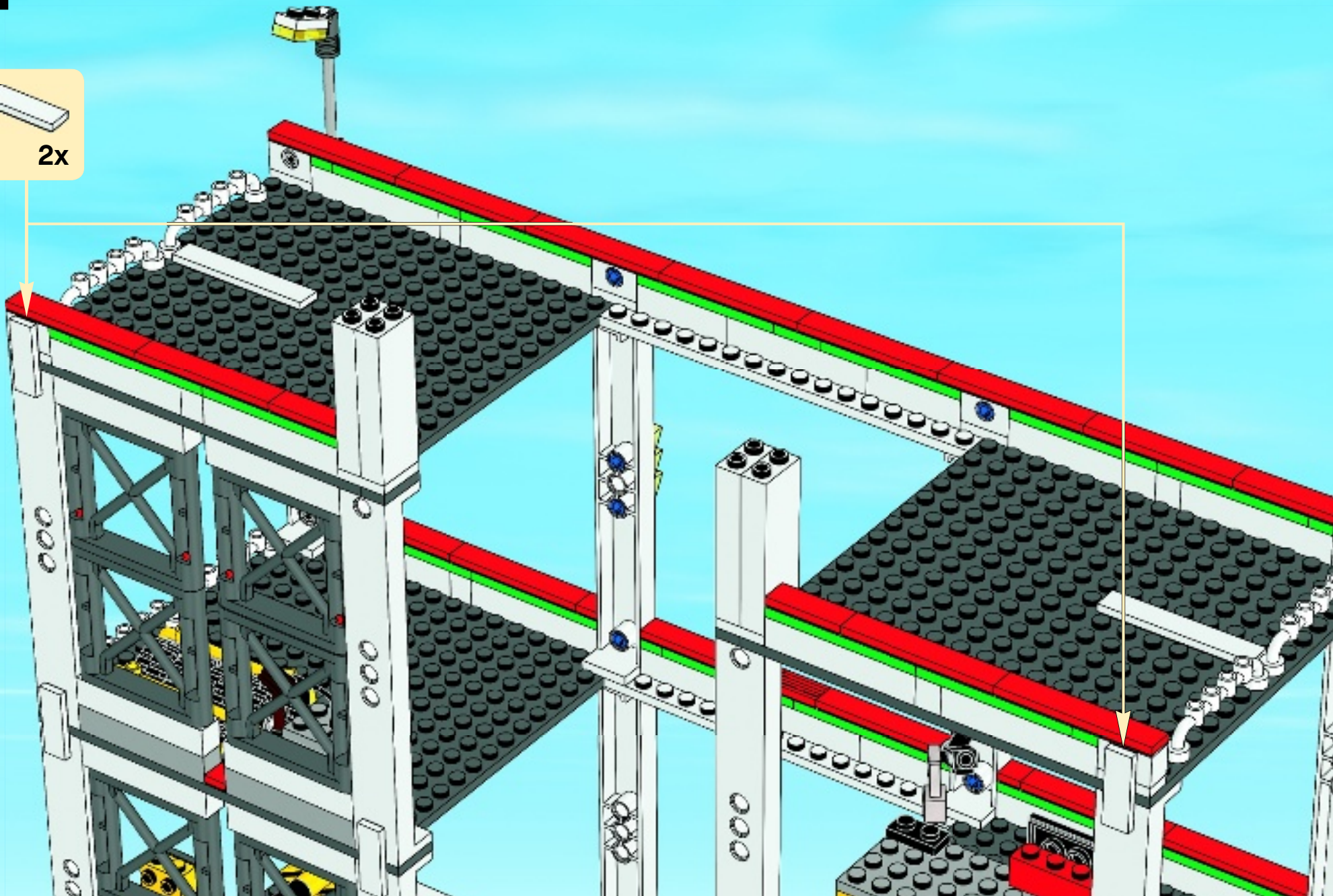

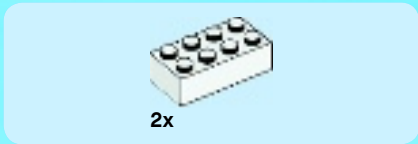
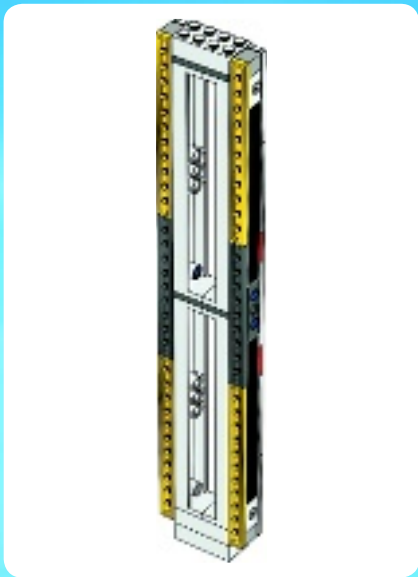

2x

1

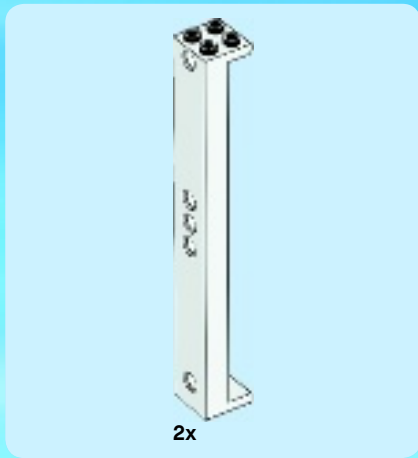
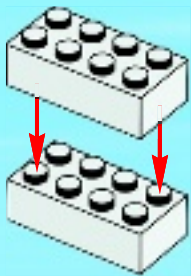

2x

2

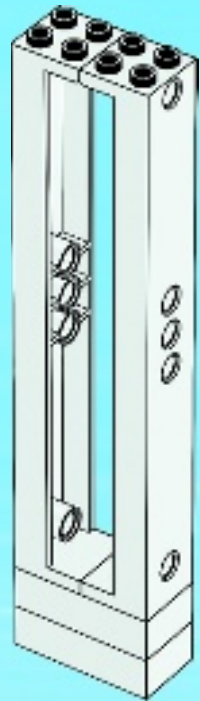



1x

3

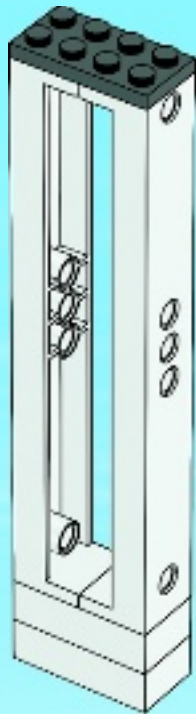

2x

4

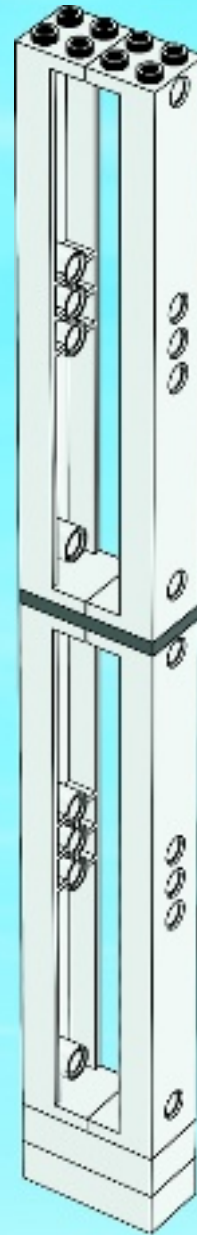



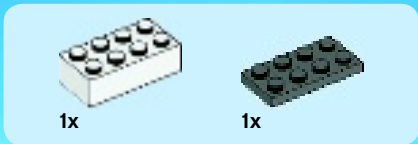

5

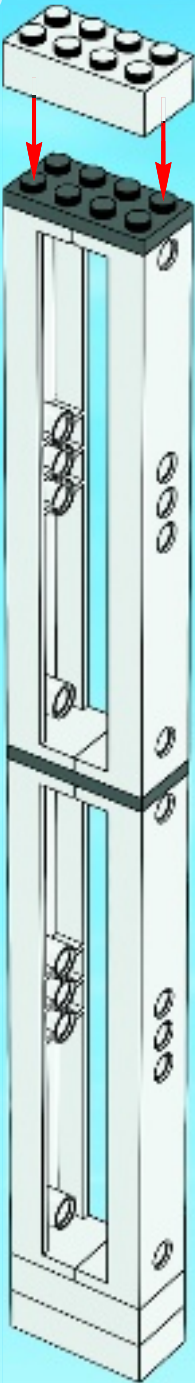

6

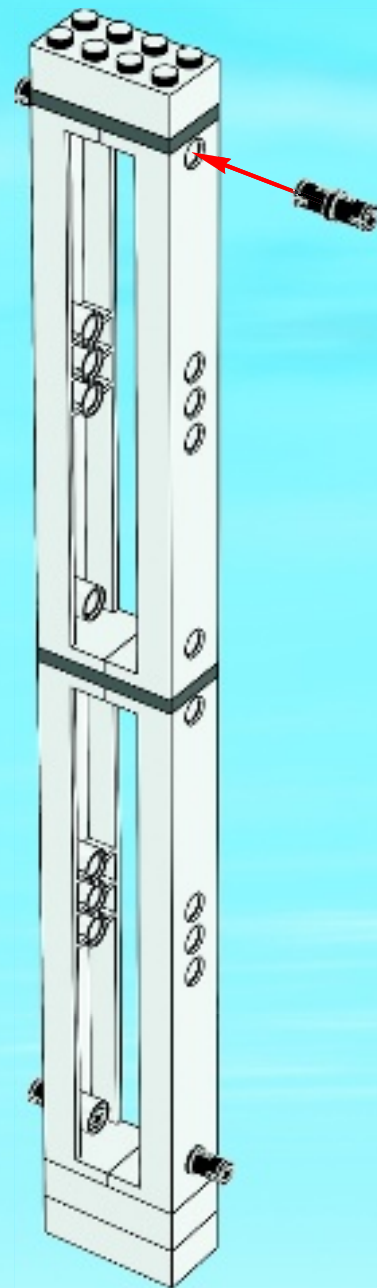



7

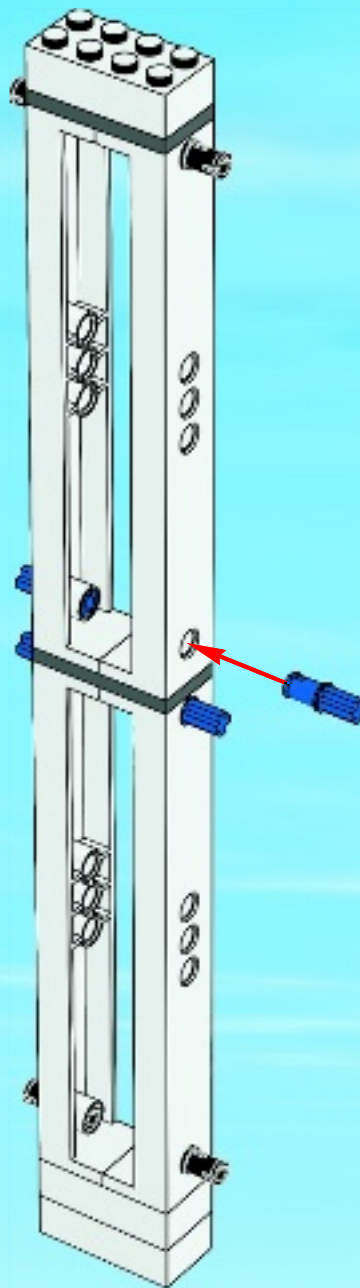

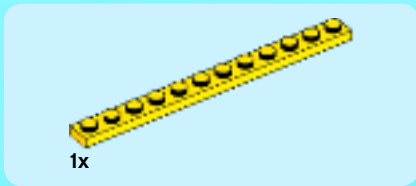
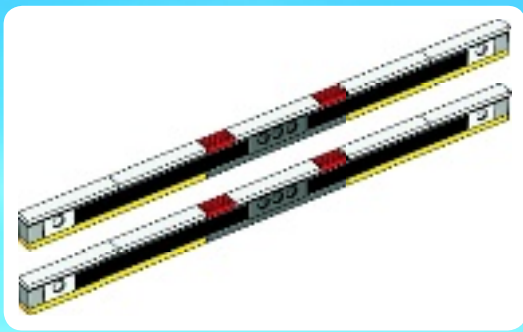

1

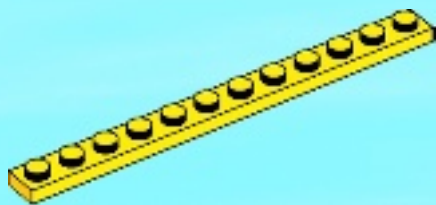

2

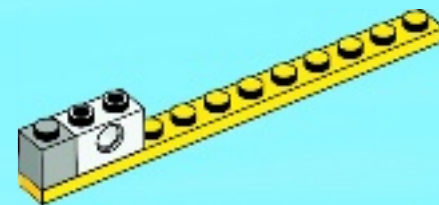



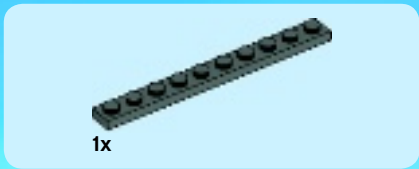

3

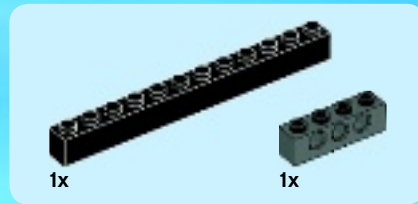

4

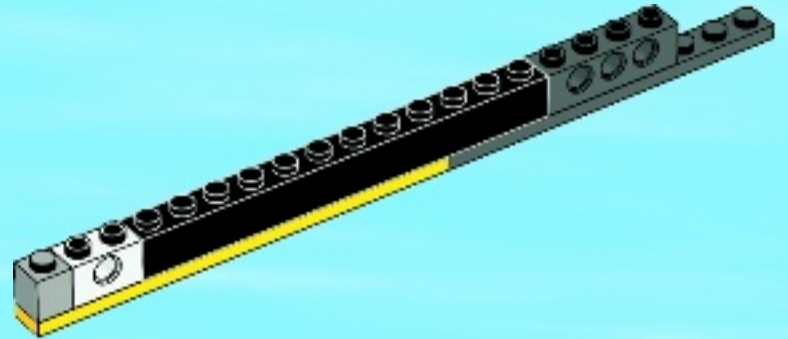
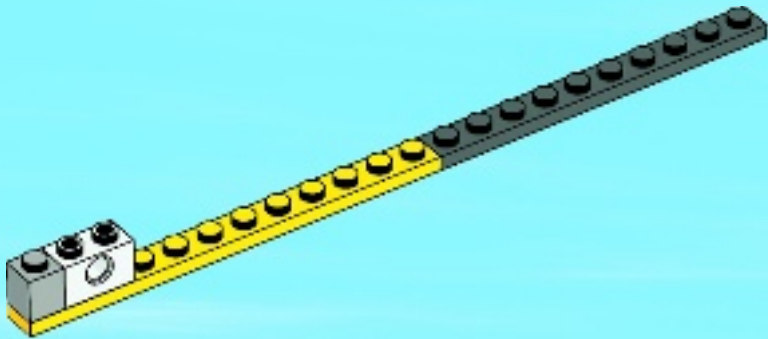

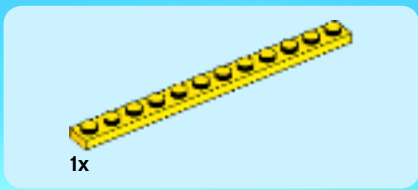

5

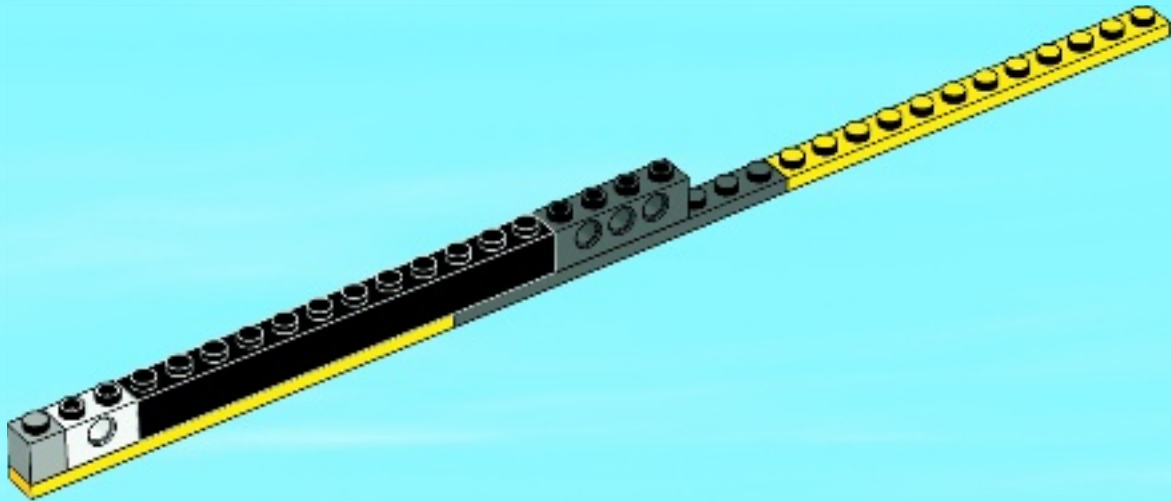

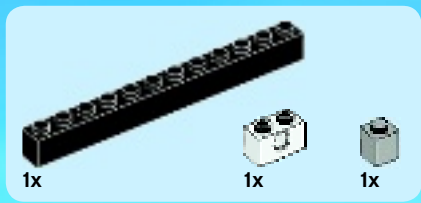

6

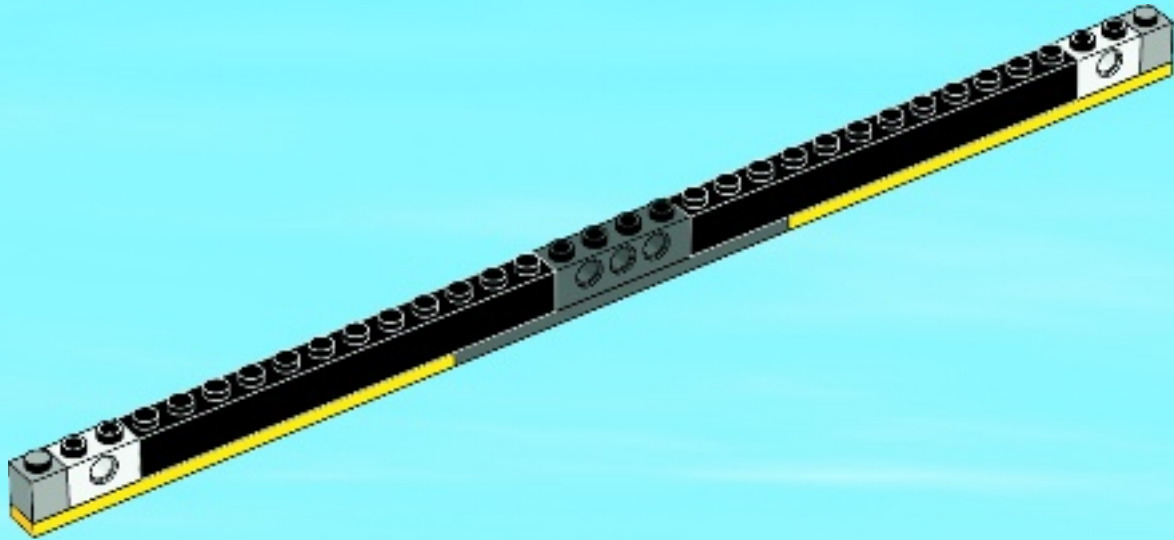



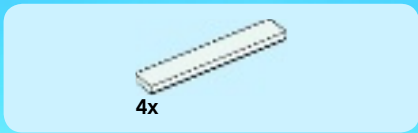

7

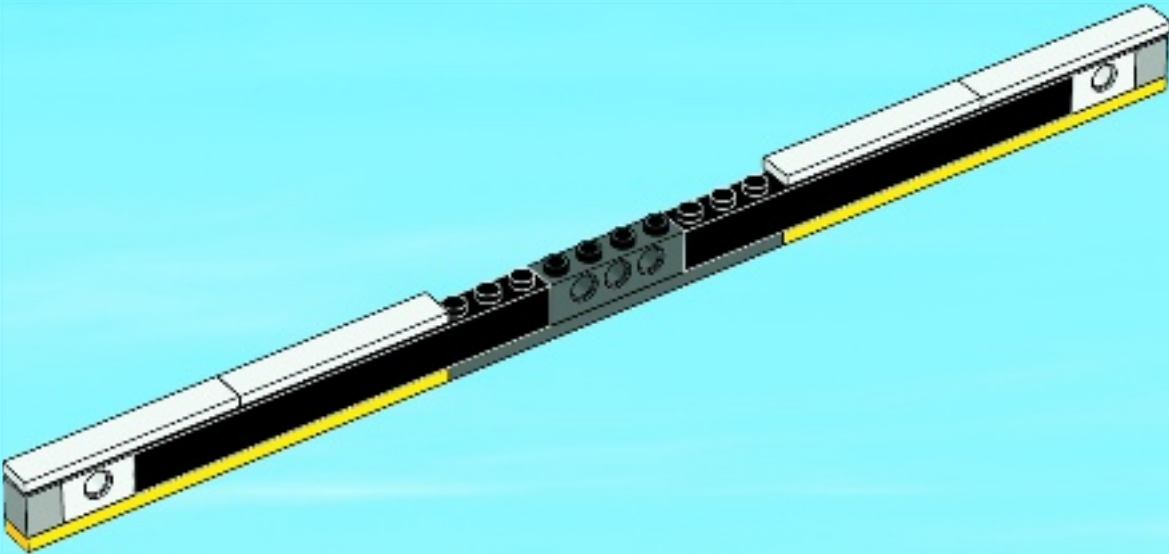

2x

1x

8

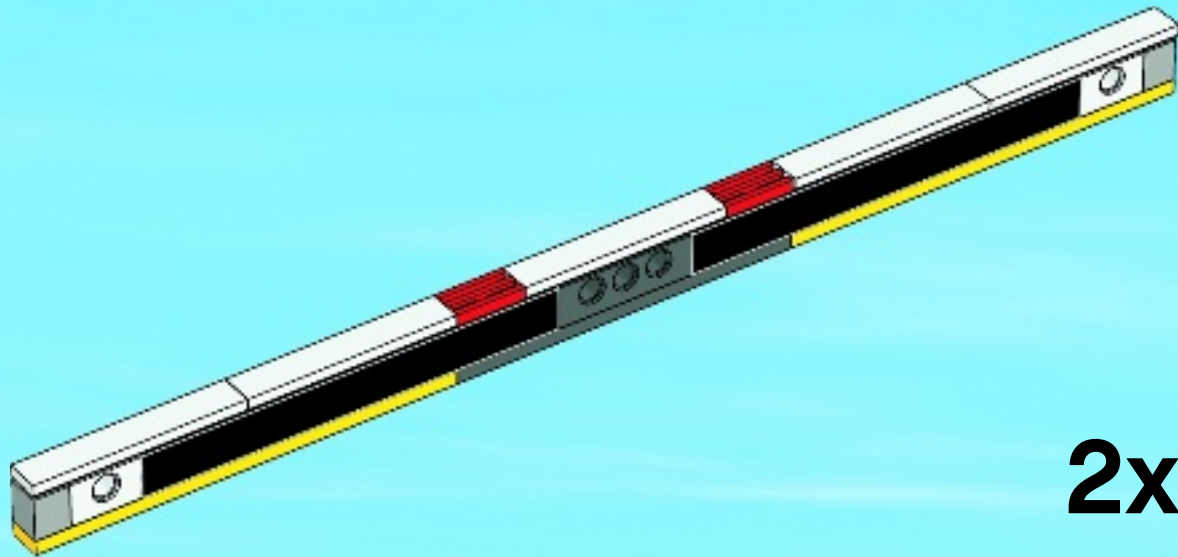

2x

9

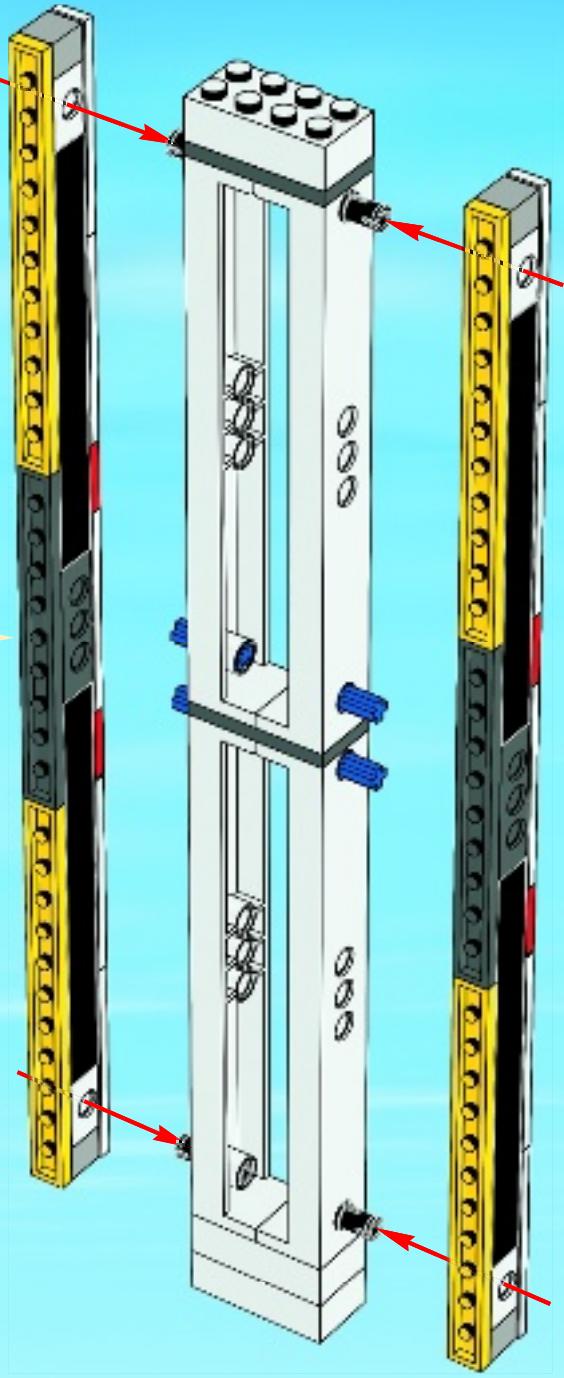



72

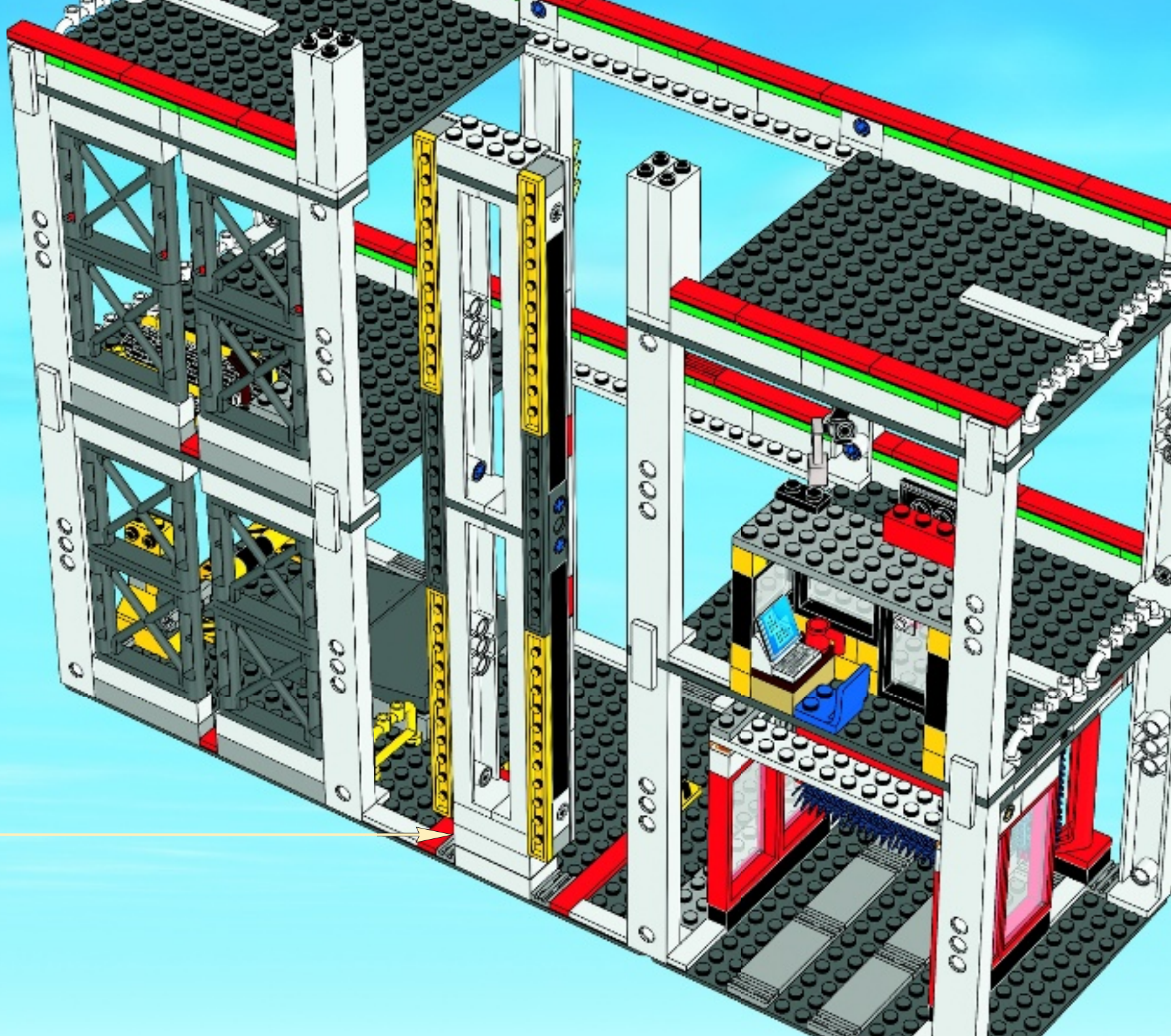



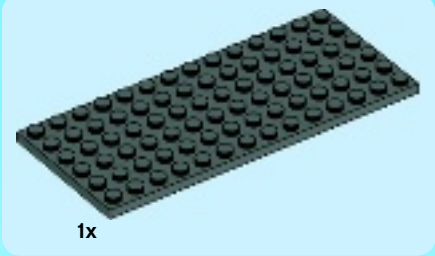
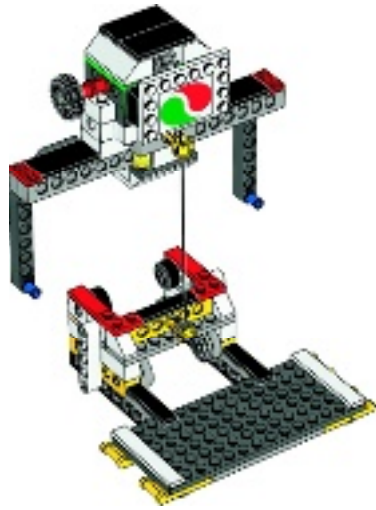

1x

1

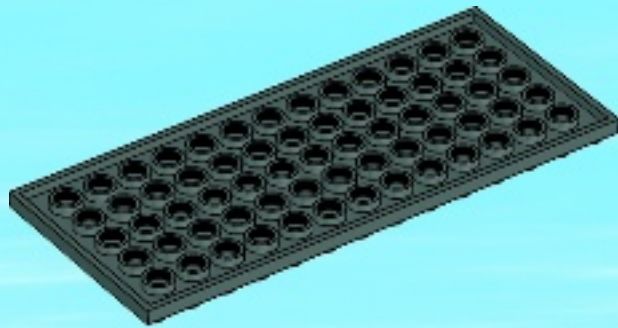

4x

2

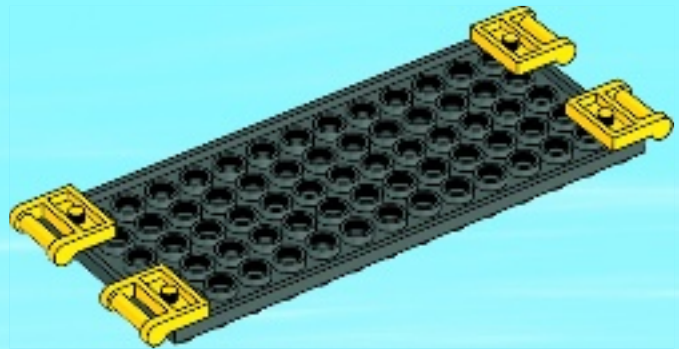

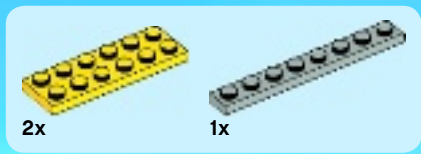

3

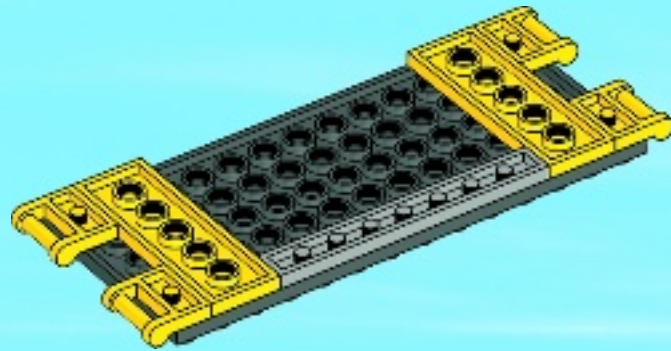





4x

4

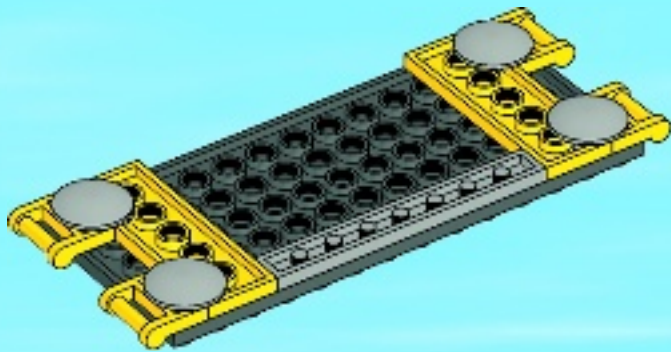

2x

5

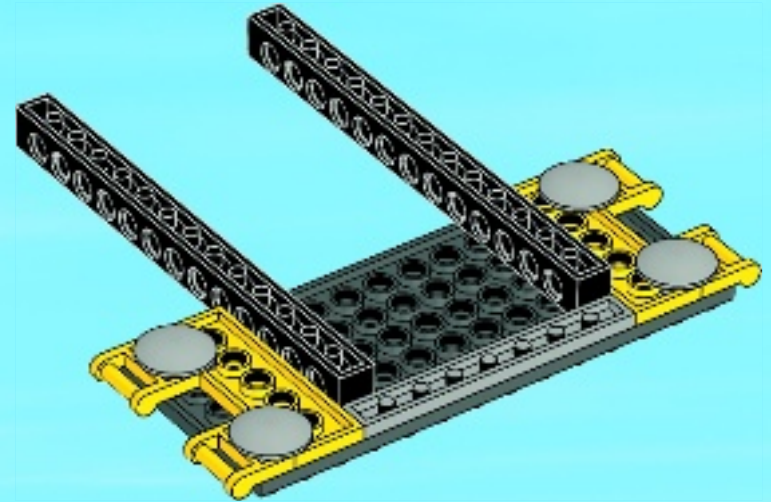



6

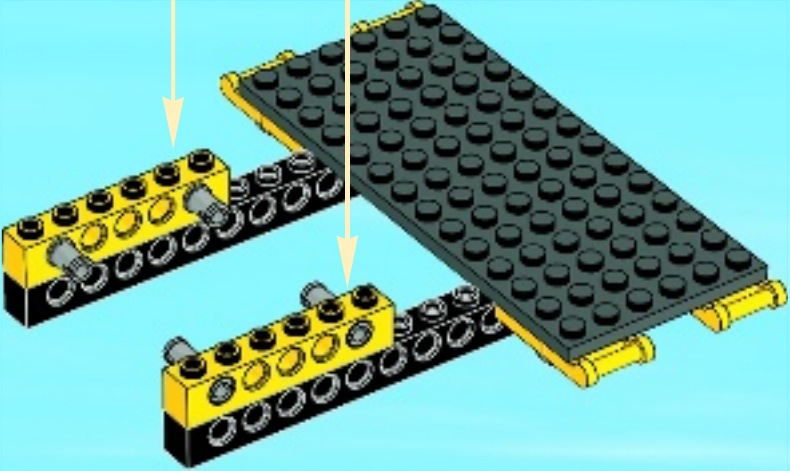
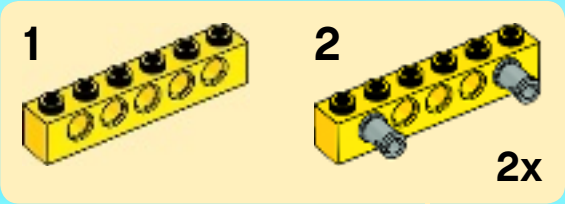



2x



2x

# 7

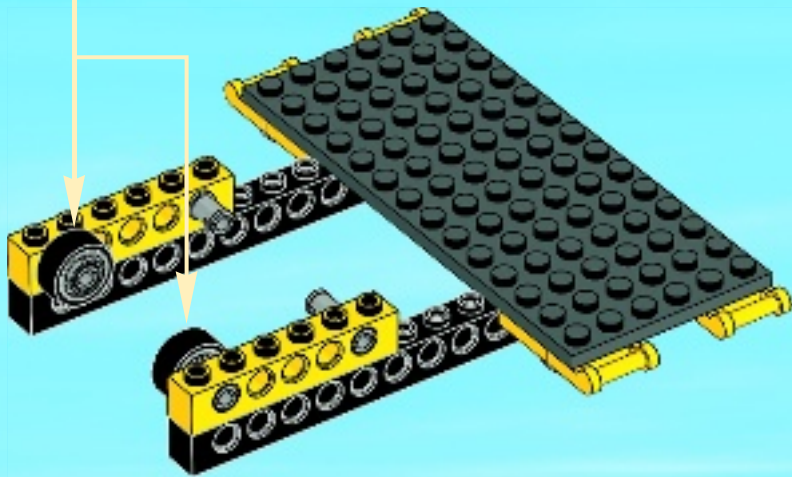
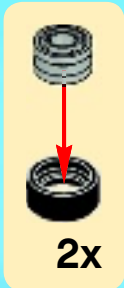

2x

# 8

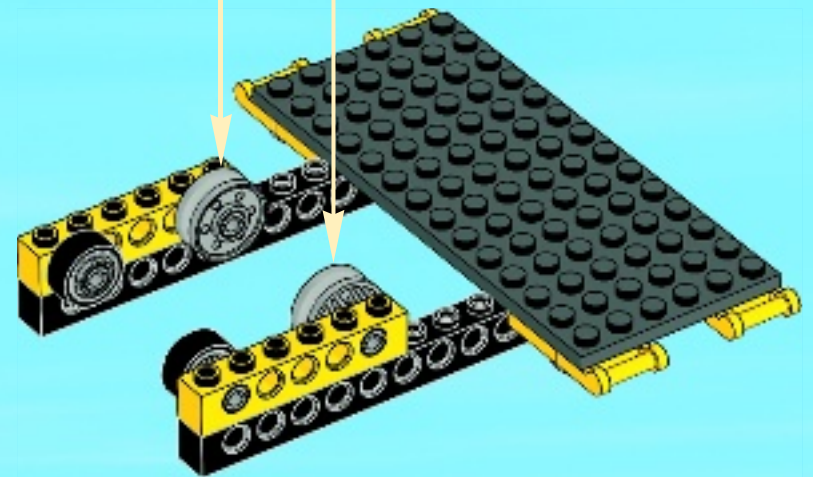
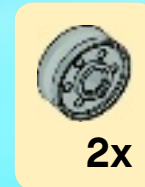





9

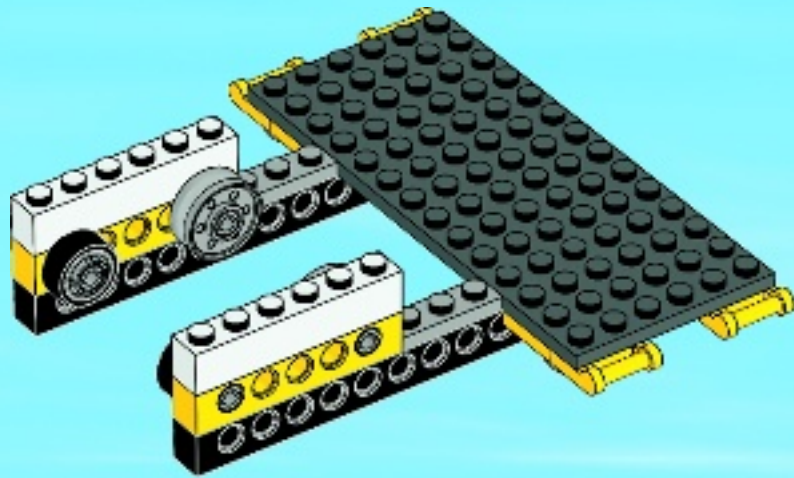

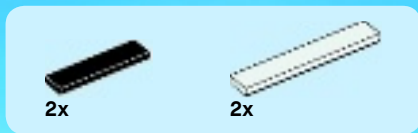

10

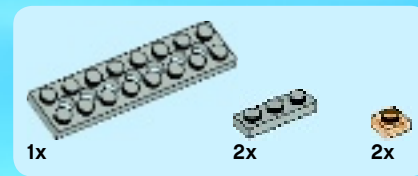
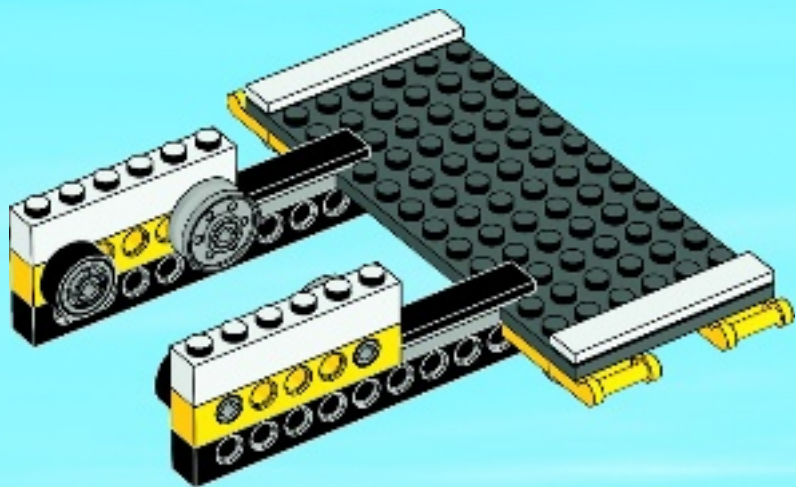

11

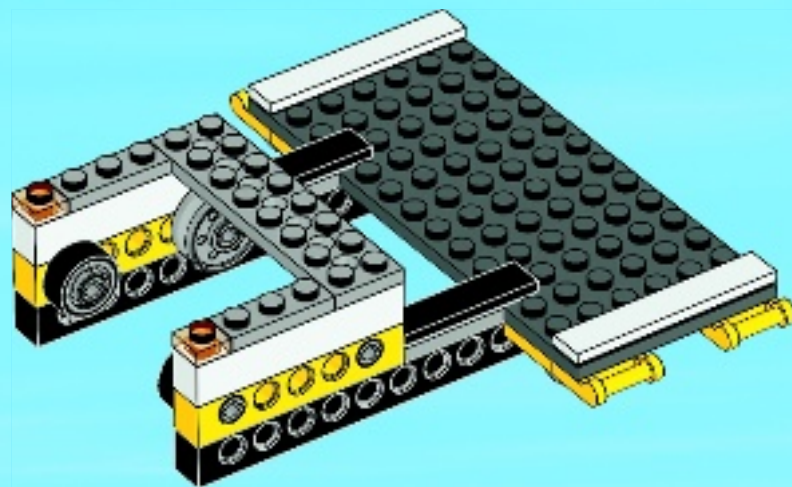



2x



2x

12

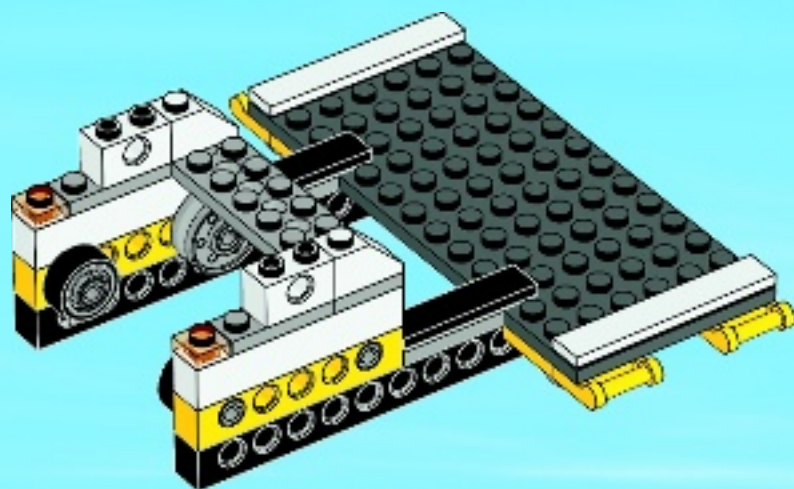





2x



2x

# 13

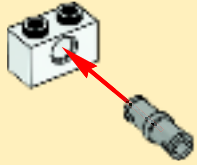

2x

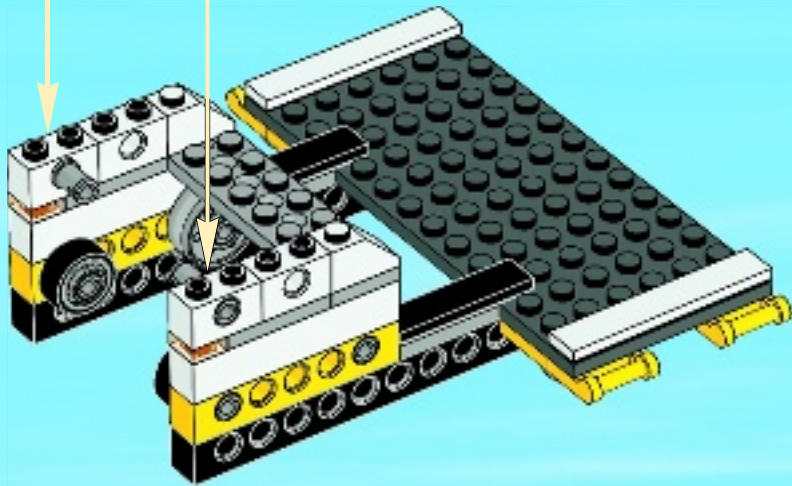

2x



2x

# 14



2x

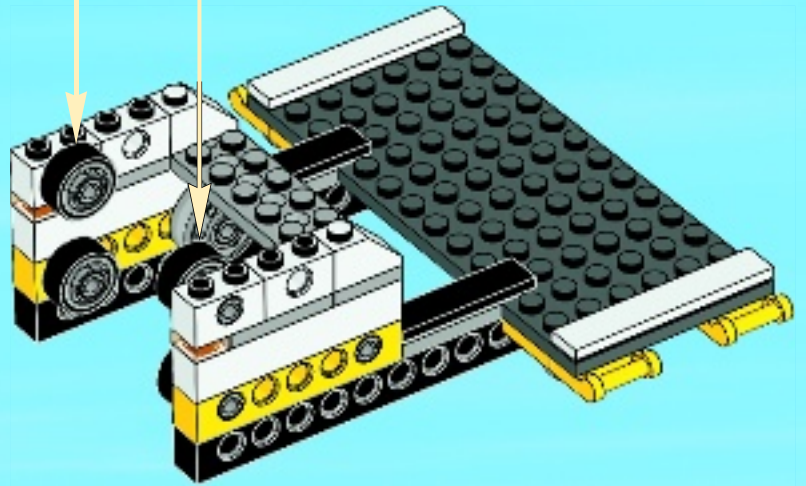



1x

15

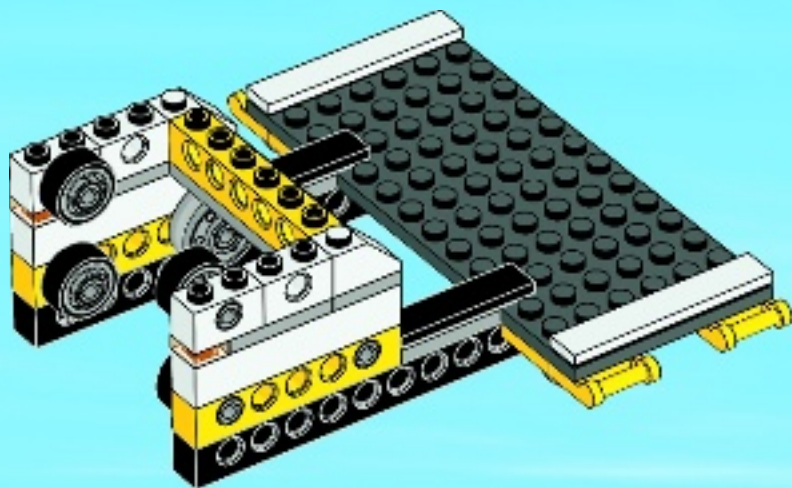



# 16

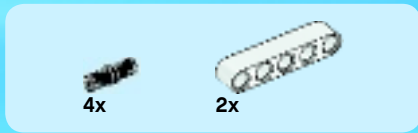
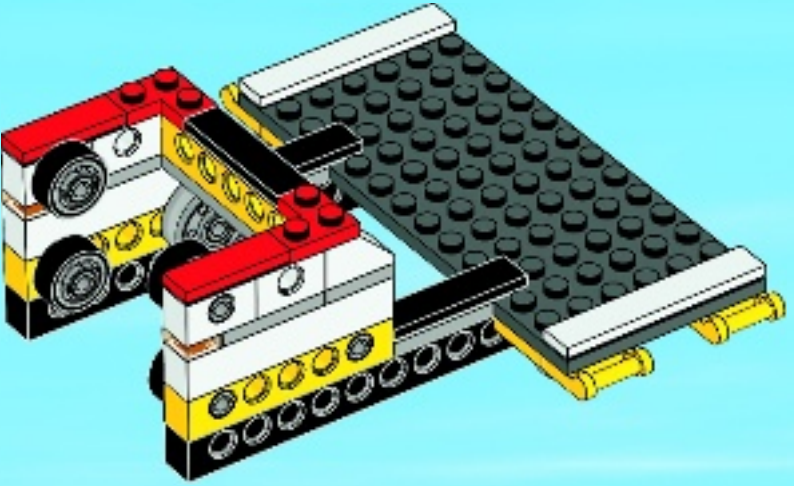

# 17

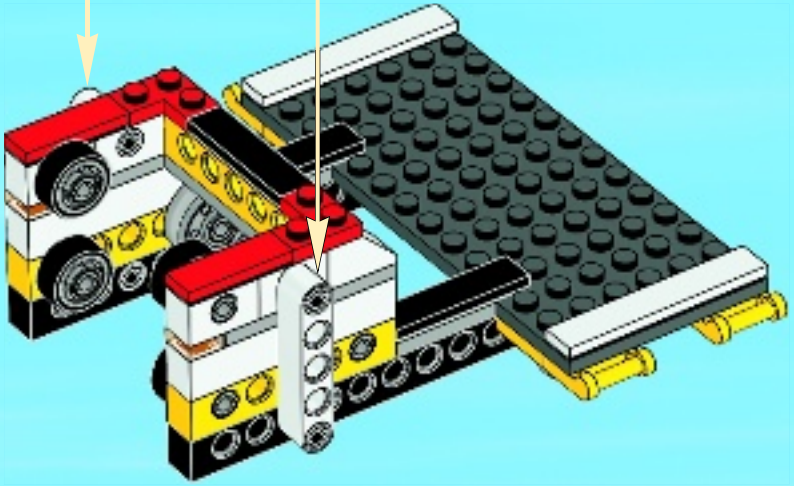
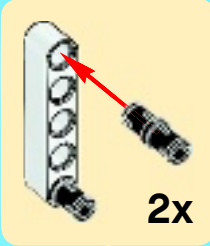



73

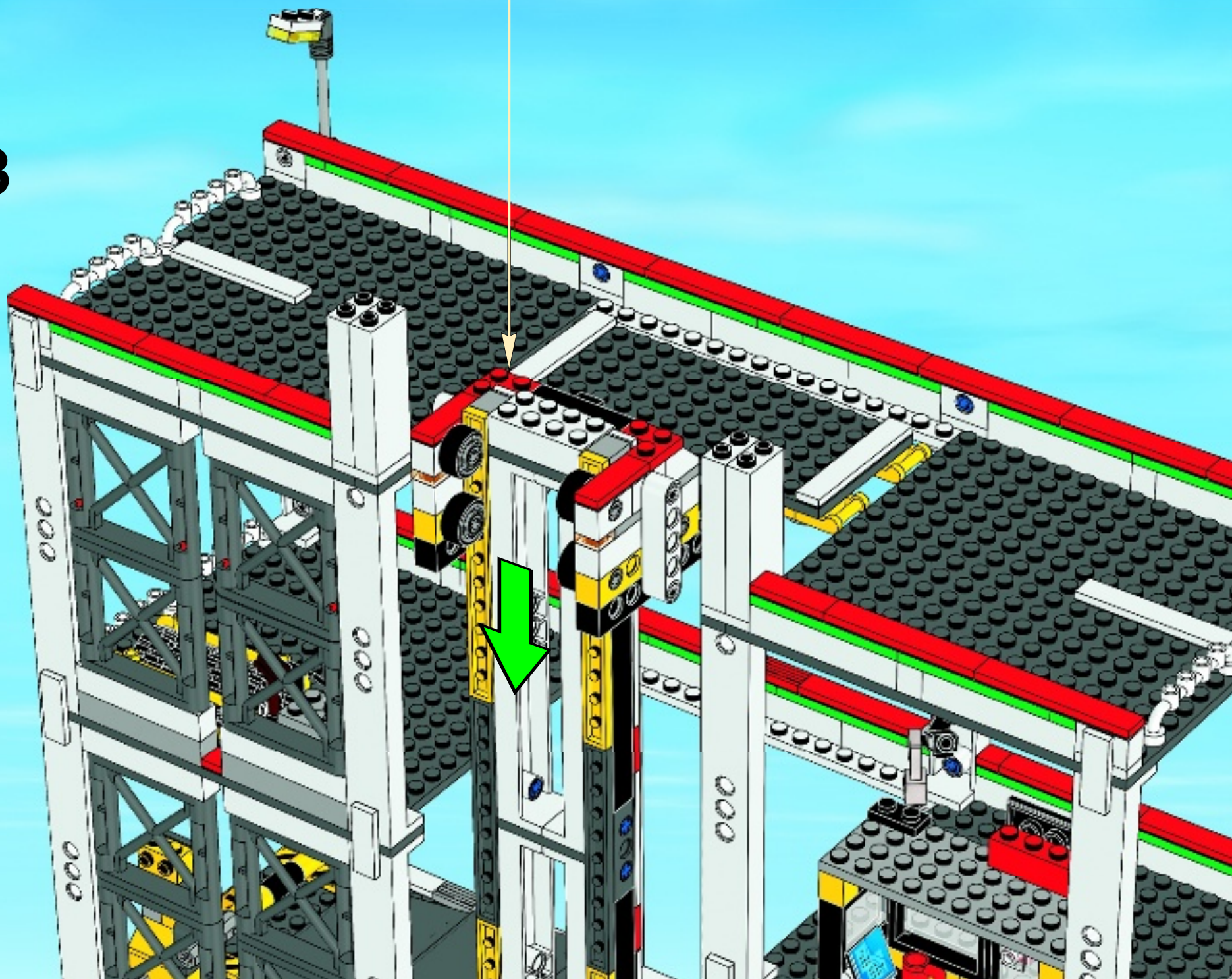

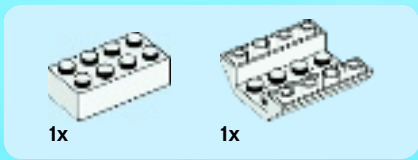
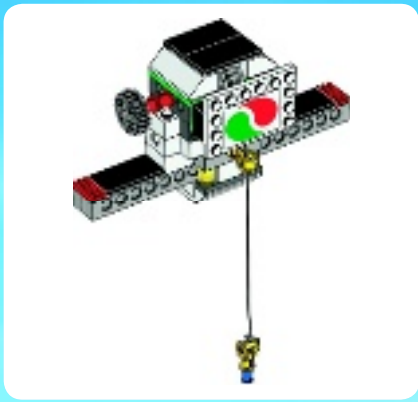

**1**

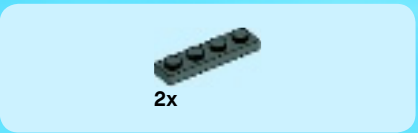
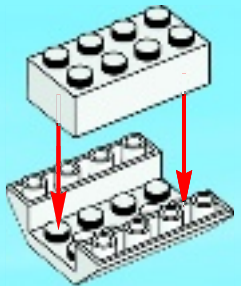

**2**

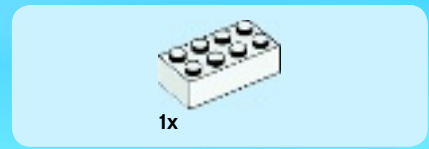

**3**

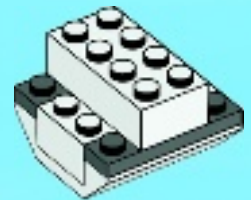



4x

4

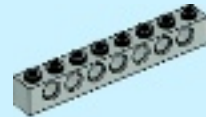
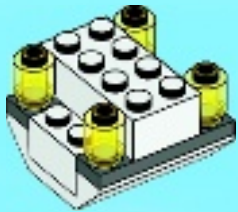

4x

5

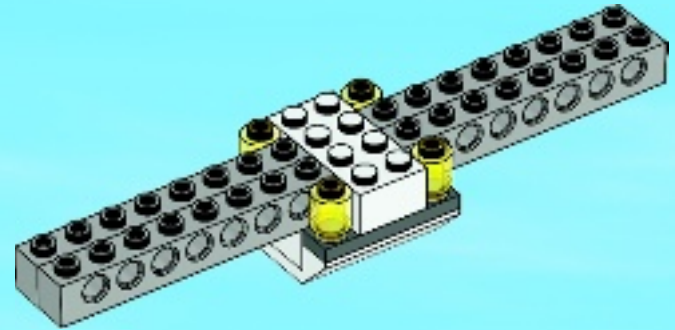



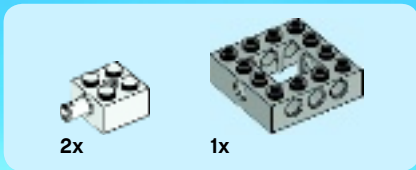

6

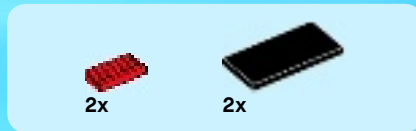
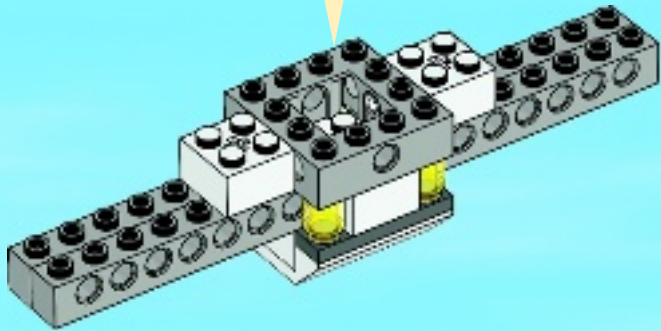
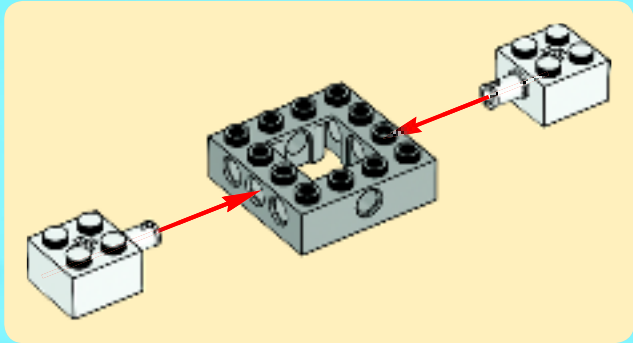

7

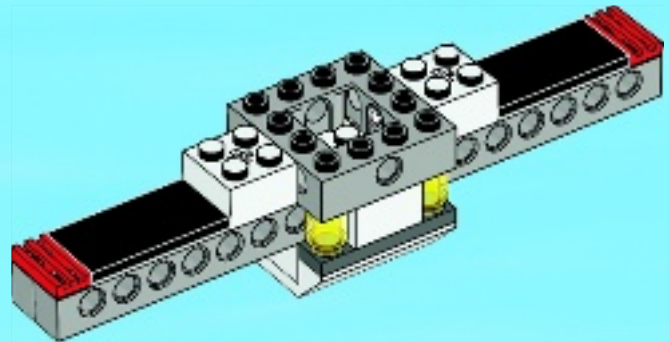



2x

8

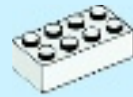
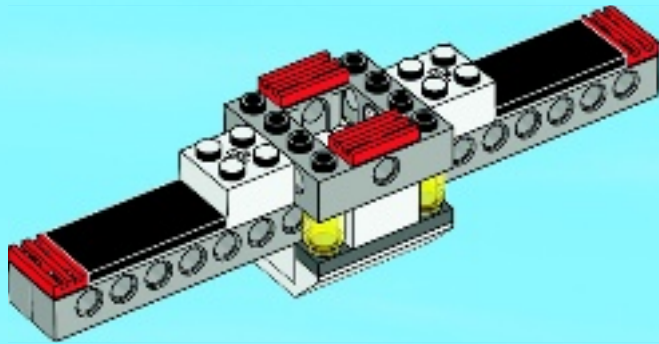

2x



2x

9

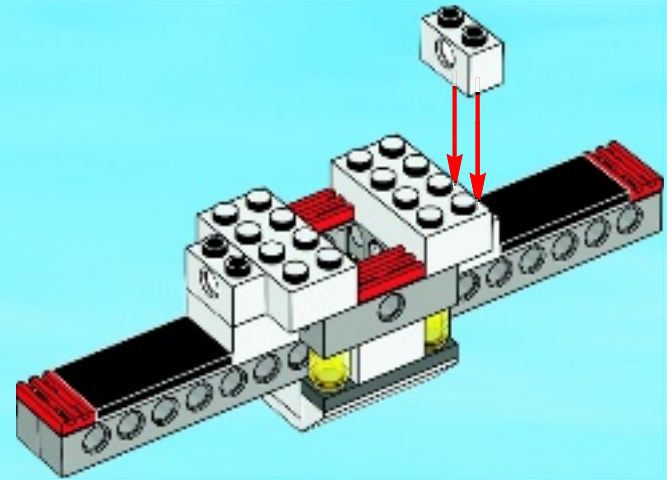





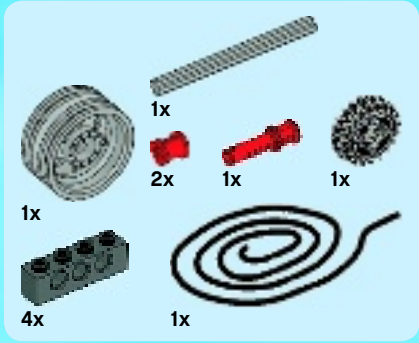

12

1

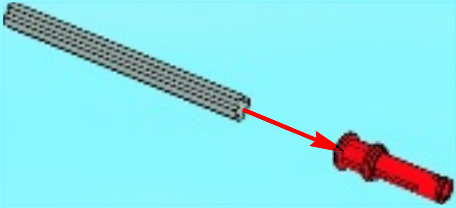

2

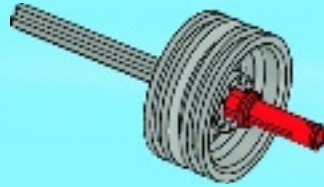

3

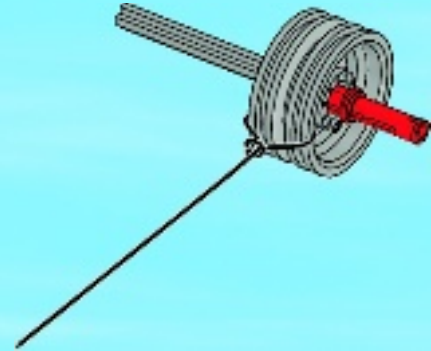

4

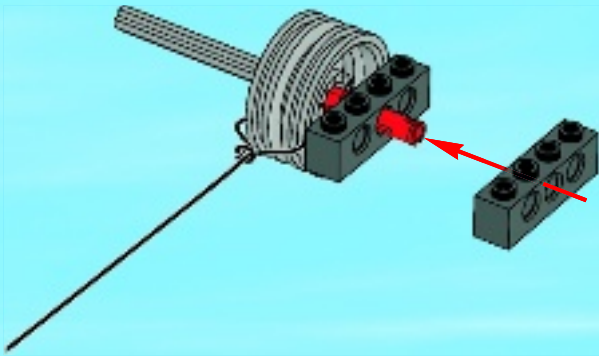

5

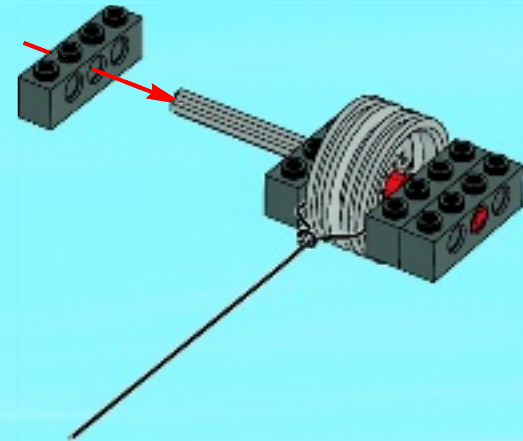

6

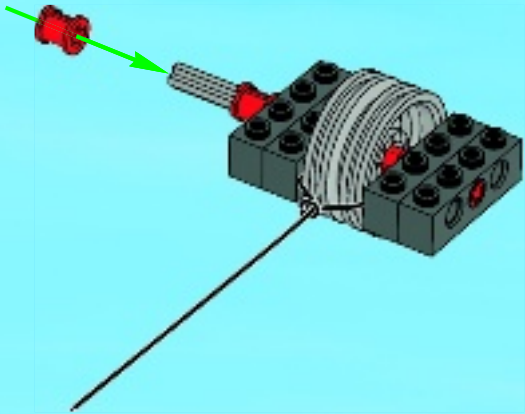

7

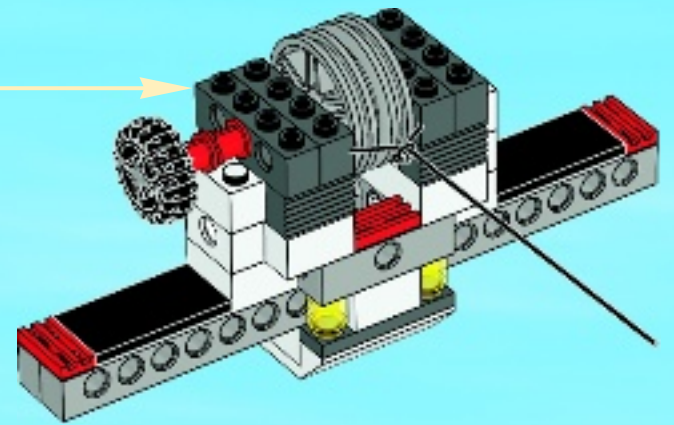
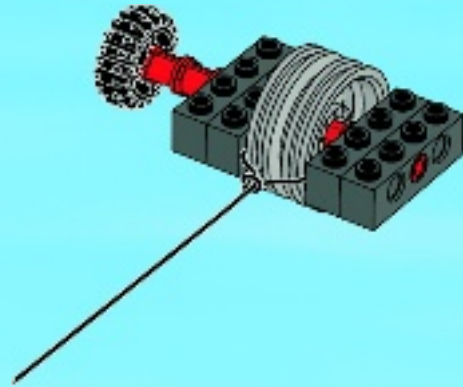





1x



1x

# 13

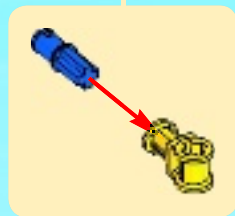
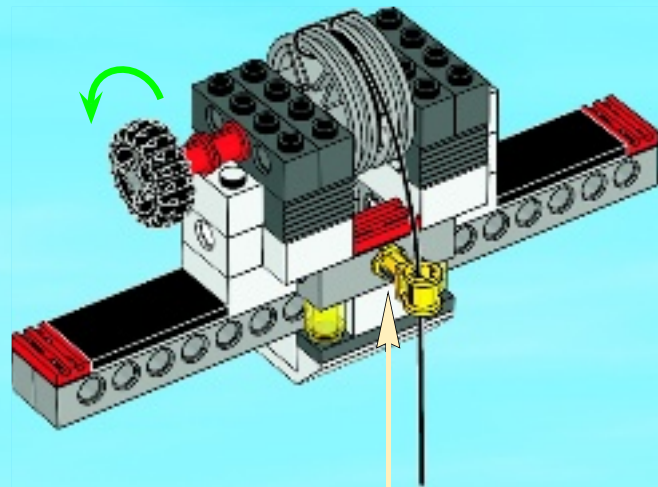

2x



2x

# 14

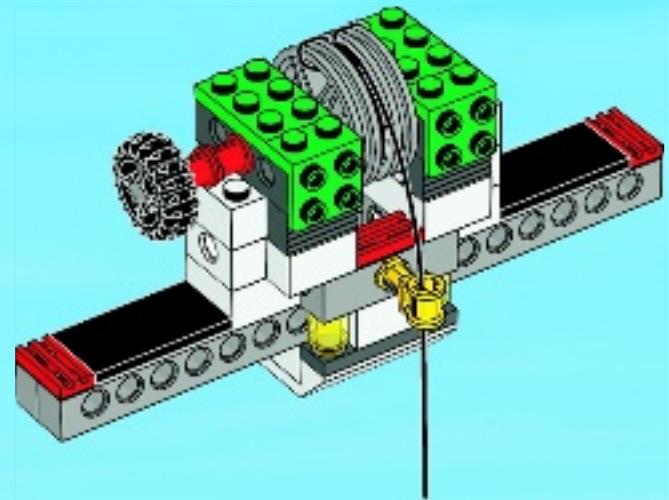





2x



2x

# 16

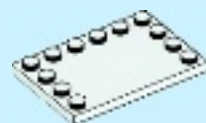
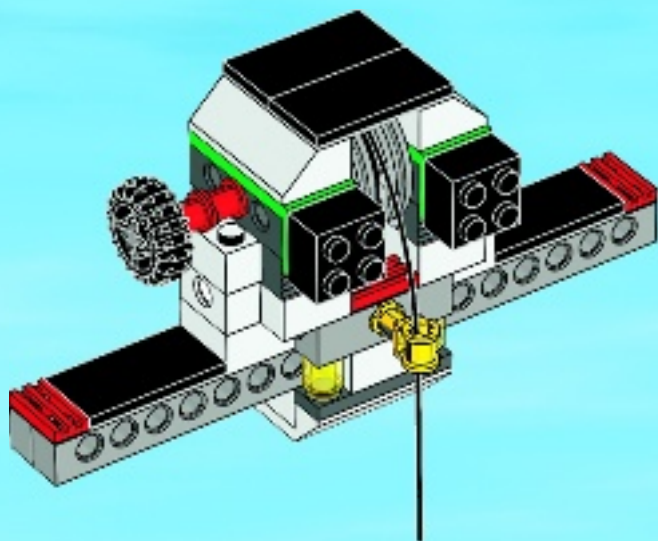

1x

# 17

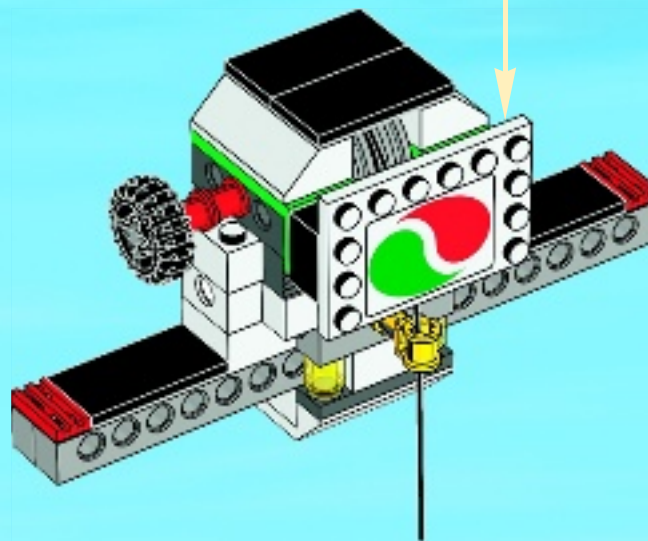
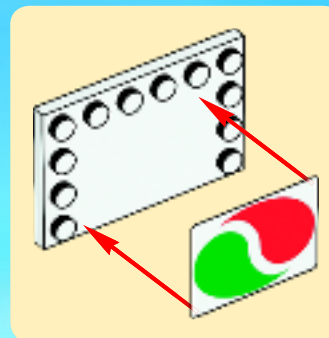





1x



1x

18

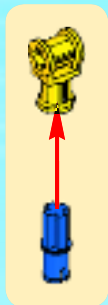
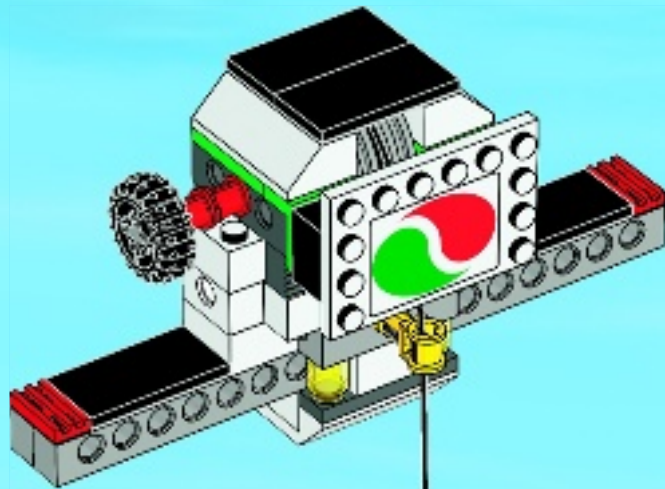

19

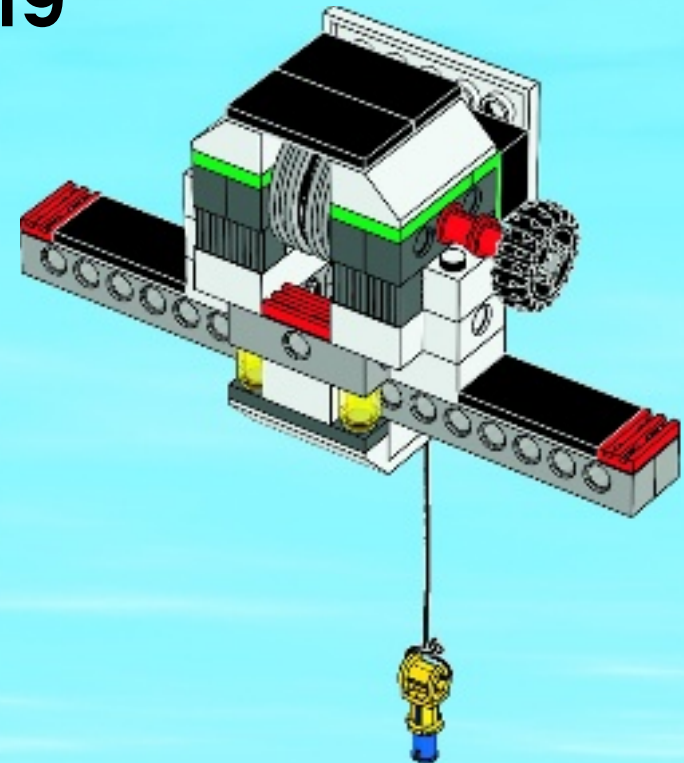

74

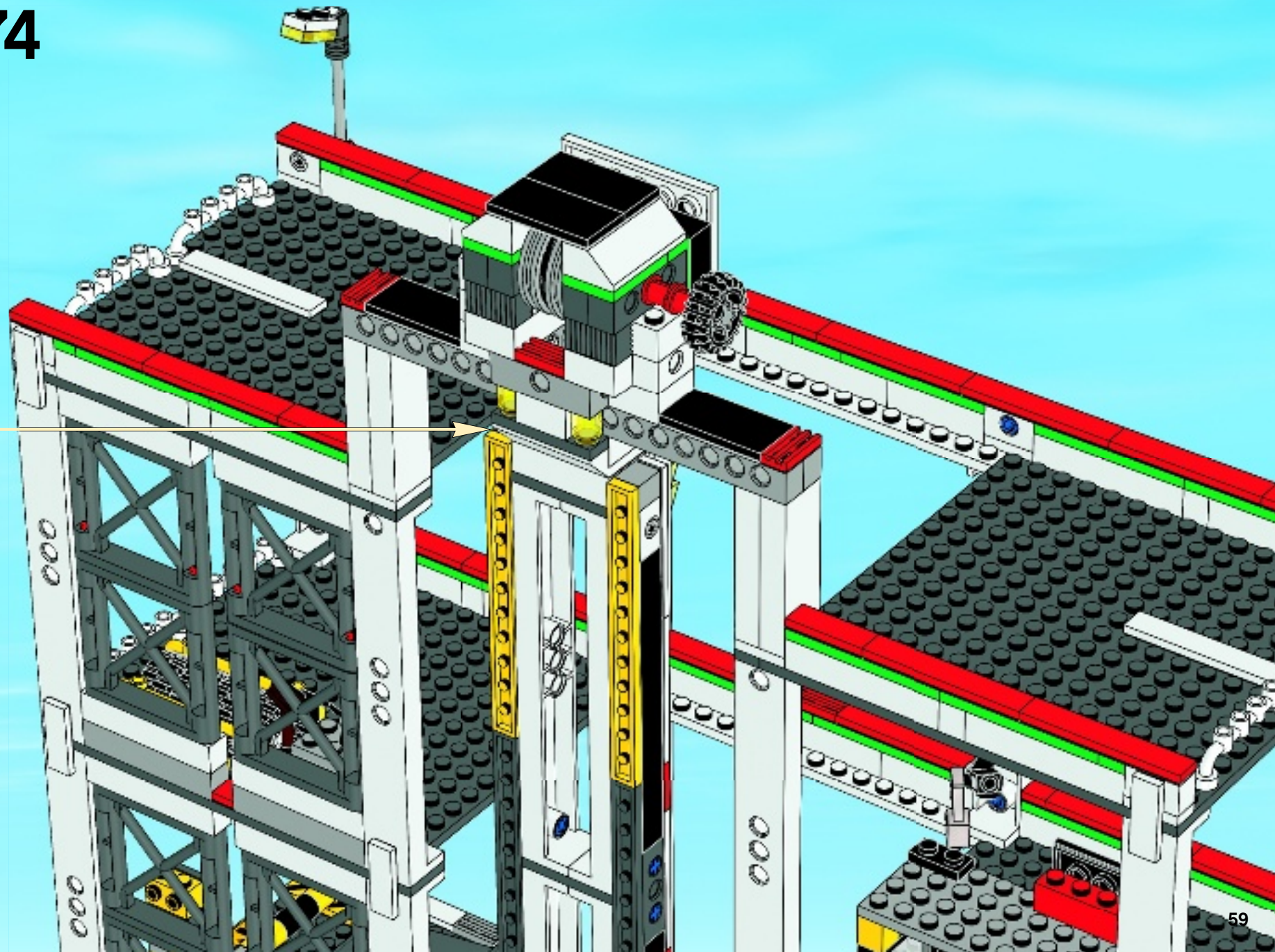



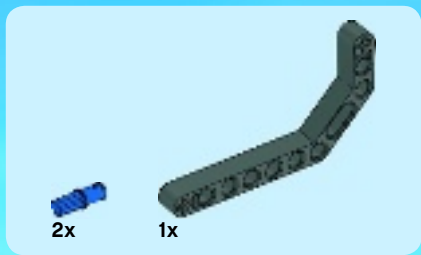

75

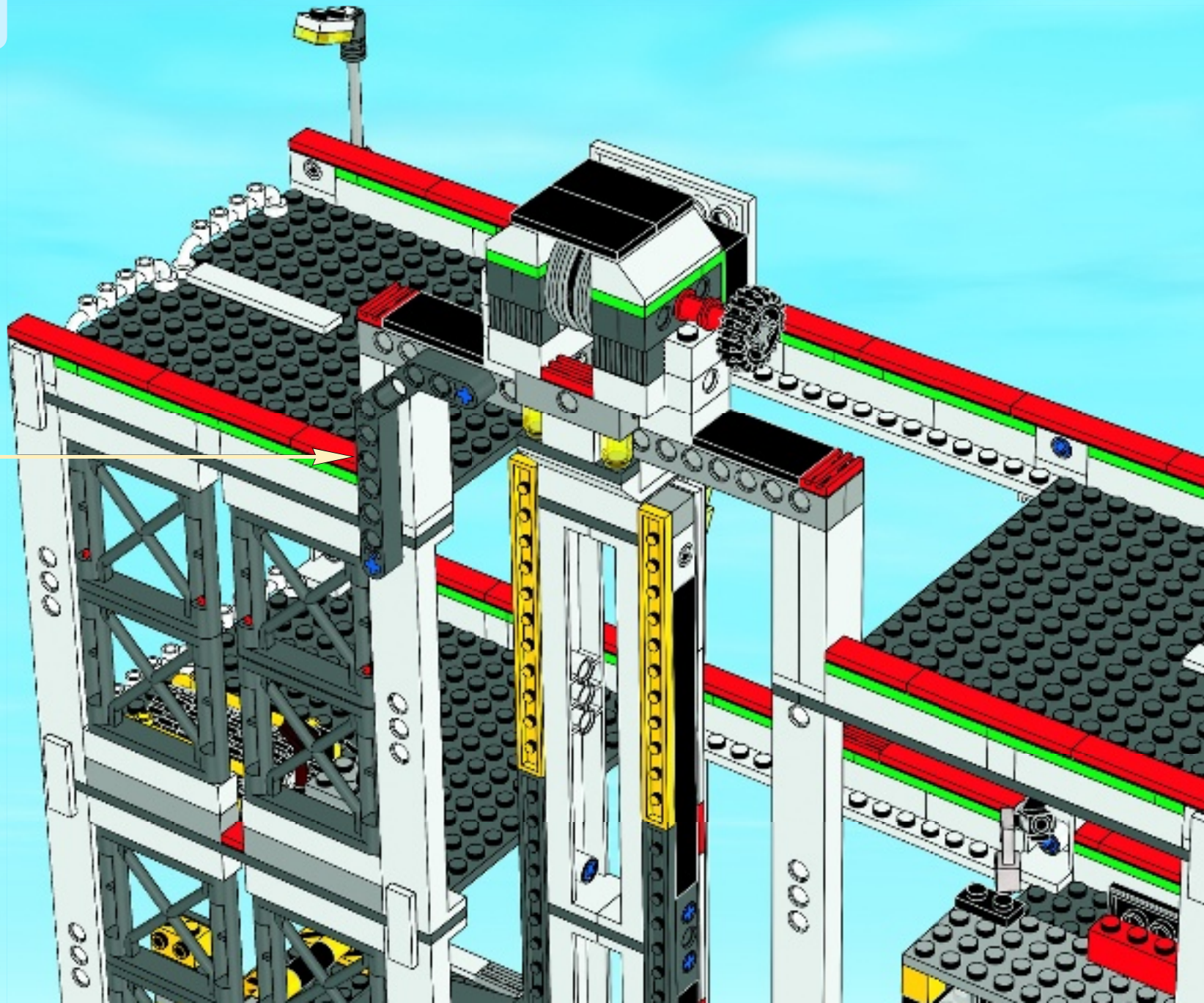
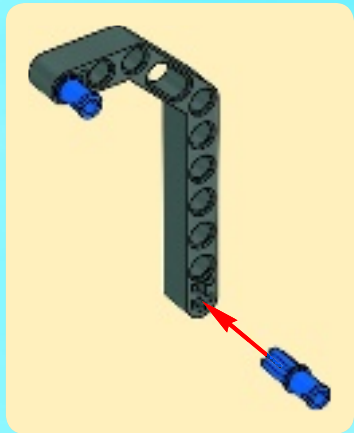



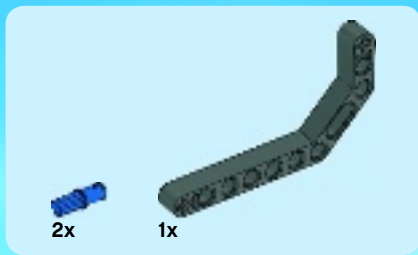

76

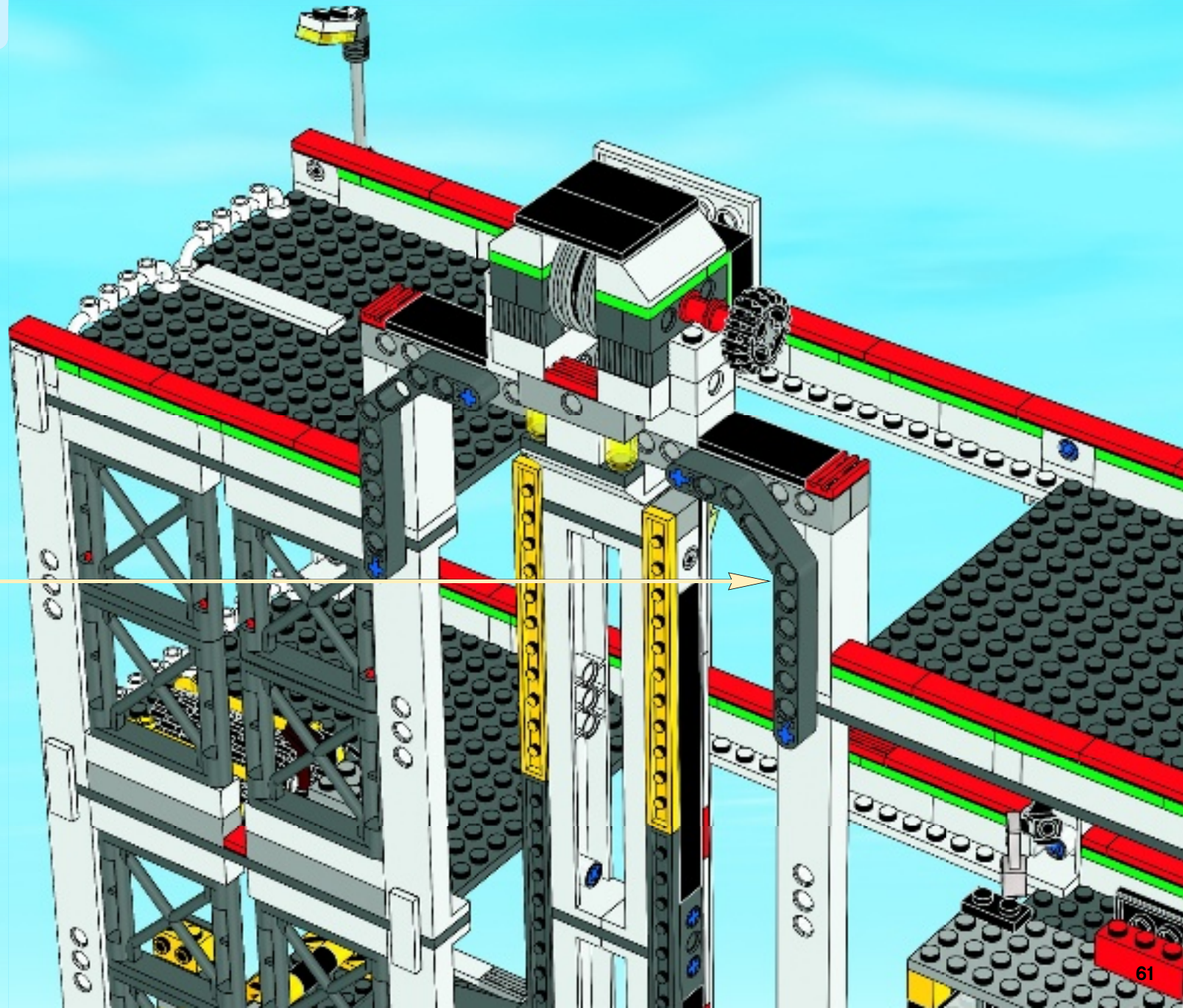







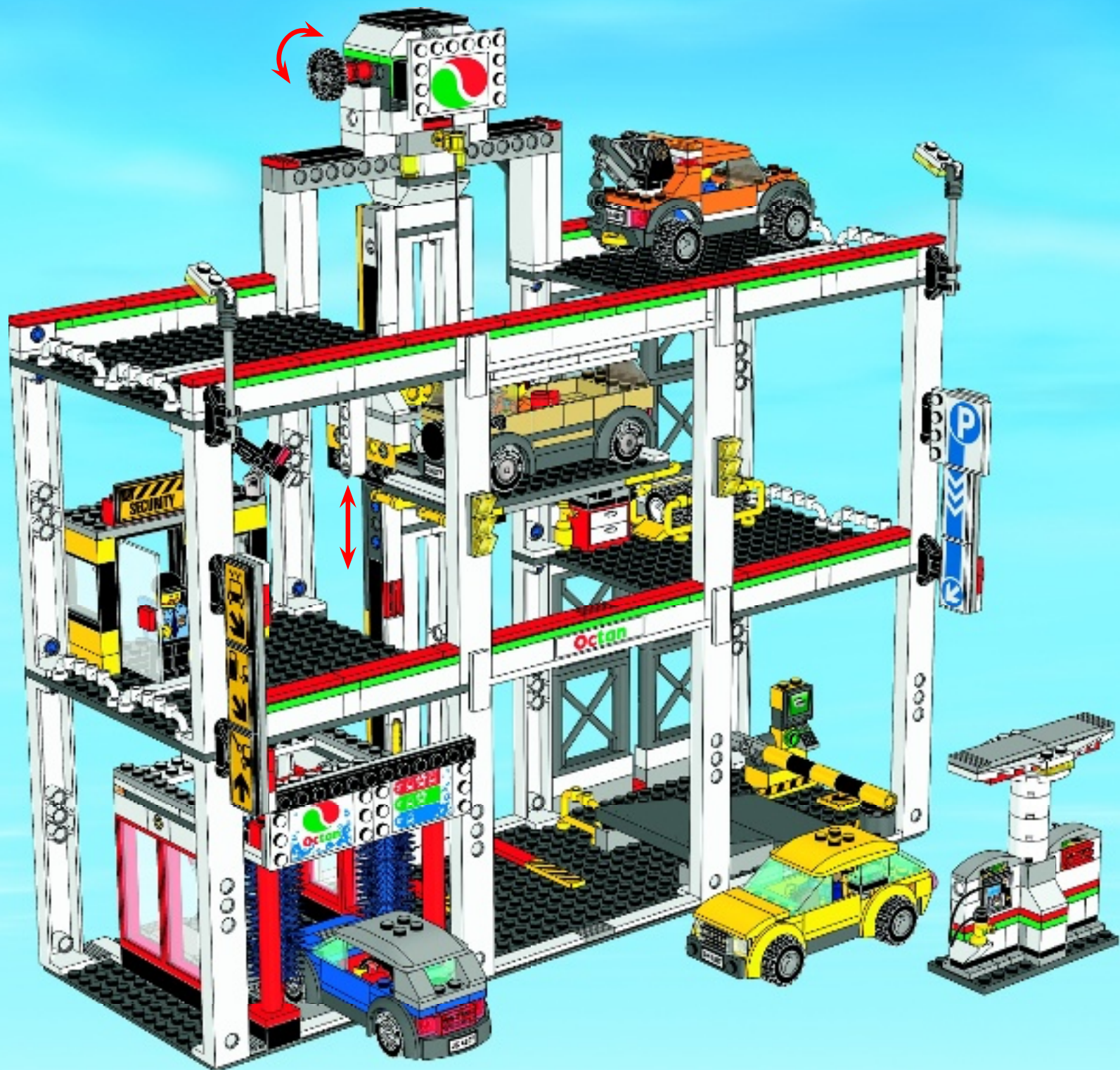



Simulated image



# CITY



[videogames.LEGO.com](http://videogames.LEGO.com)



Exclusively on

Wii U™ NINTENDO 3DS™



[www.pegi.info](http://www.pegi.info)

Provisional Rating

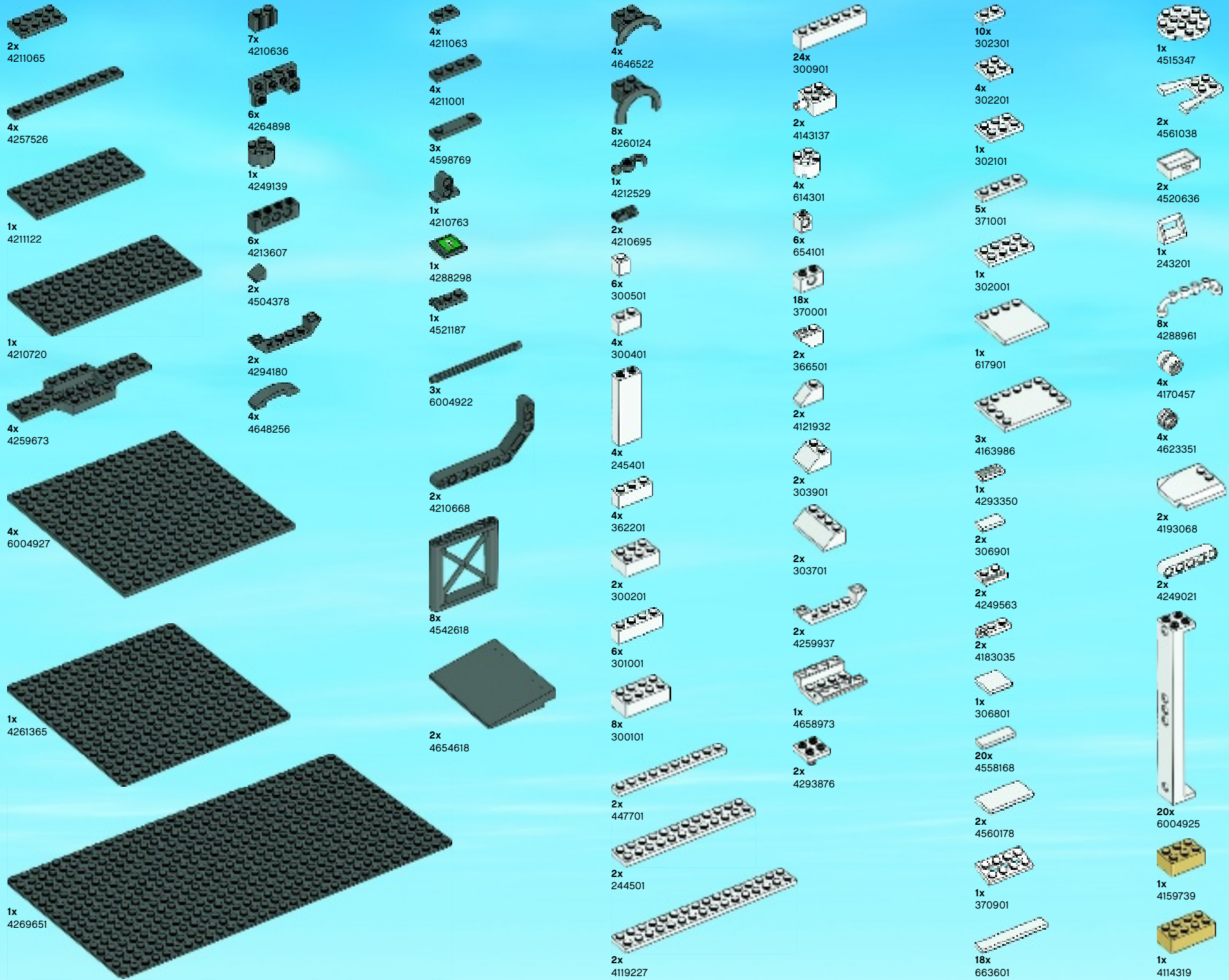



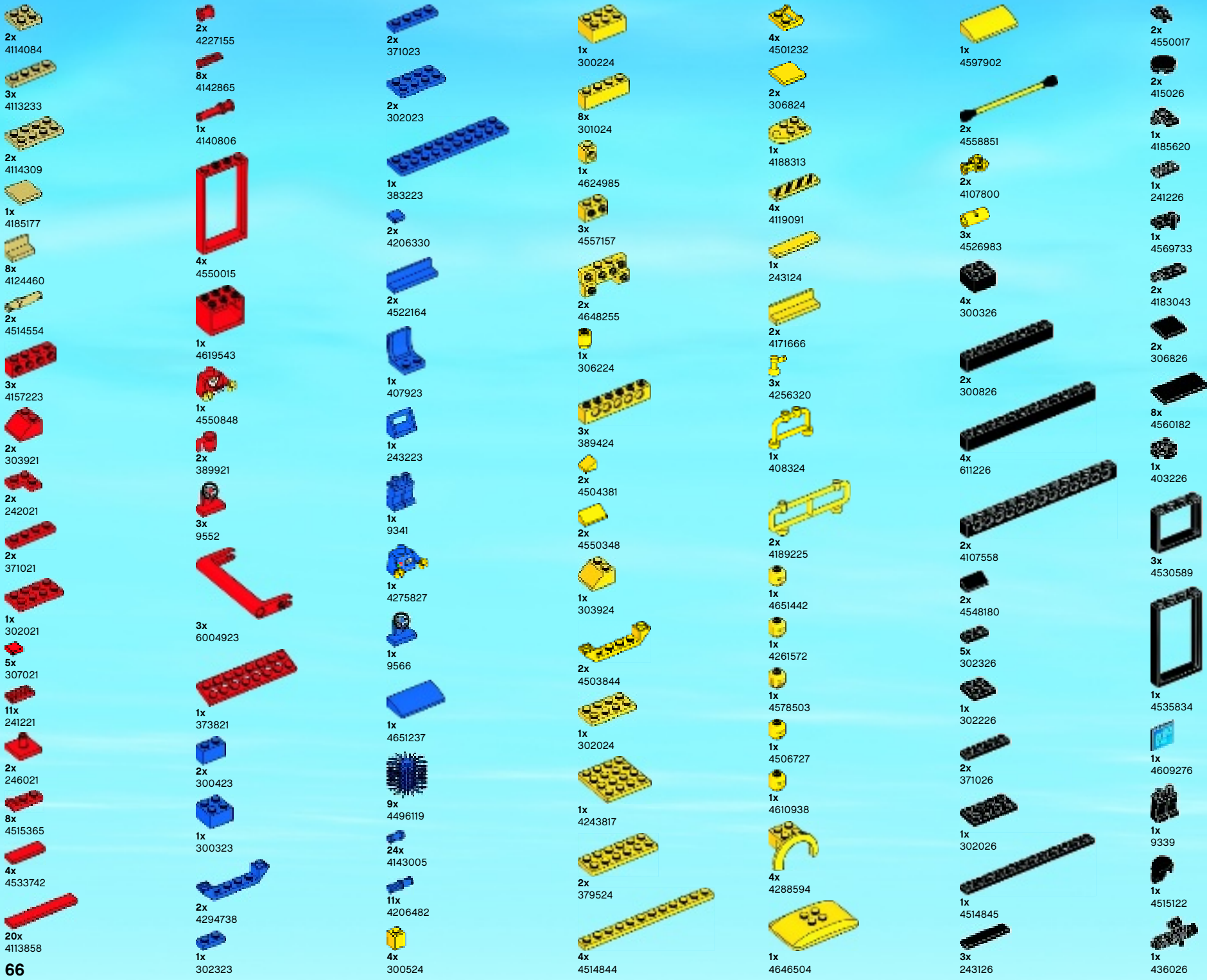

2x 4114084  
 3x 4113233  
 2x 4114309  
 1x 4185177  
 8x 4124460  
 2x 4514554  
 3x 4157223  
 2x 303921  
 2x 242021  
 2x 371021  
 1x 302021  
 5x 307021  
 11x 241221  
 2x 246021  
 8x 4515365  
 4x 4533742  
 20x 4113858

2x 4227155  
 8x 4142865  
 1x 414806  
 4x 4550015  
 1x 4619543  
 1x 4550848  
 2x 389921  
 3x 9552  
 3x 6004923  
 1x 373821  
 2x 300423  
 1x 300323  
 2x 4294738  
 1x 302323

2x 371023  
 2x 302023  
 1x 383223  
 2x 4206330  
 2x 4522164  
 1x 407923  
 1x 243223  
 1x 9341  
 1x 4275827  
 1x 9566  
 1x 4651237  
 9x 4496119  
 24x 4143005  
 11x 4206482  
 4x 300524

1x 300224  
 8x 301024  
 1x 4624985  
 3x 4557157  
 2x 4648255  
 1x 306224  
 3x 389424  
 2x 4504381  
 2x 4550348  
 1x 303924  
 2x 4503844  
 1x 302024  
 1x 4243817  
 2x 379524  
 4x 4514844

4x 4501232  
 2x 306824  
 1x 4188313  
 4x 4119091  
 1x 243124  
 2x 4171666  
 3x 4256320  
 1x 408324  
 2x 4189225  
 1x 4651442  
 1x 4261572  
 1x 4578503  
 1x 4506727  
 1x 4610938  
 4x 4288594  
 1x 4646504

1x 4597902  
 2x 4558851  
 2x 4107800  
 3x 4526983  
 4x 300326  
 2x 300826  
 4x 611226  
 2x 4107558  
 2x 4548180  
 5x 302326  
 1x 302226  
 2x 371026  
 1x 302026  
 1x 4514845  
 3x 243126

2x 4550017  
 2x 415026  
 1x 4185620  
 1x 241226  
 1x 4569733  
 2x 4183043  
 2x 306826  
 8x 4560182  
 1x 403226  
 3x 4530589  
 1x 4535834  
 1x 4609276  
 1x 9339  
 1x 4515122  
 1x 436026





  
**Customer Service**  
 Kundenservice  
 Service Consommateurs  
 Servicio Al Consumidor  
[www.lego.com/service](http://www.lego.com/service) or dial  

 : 00800 5346 5555  
 : 1-800-422-5346





# CITY



7279



7285



7286



7287



7288



7498



www.LEGO.com

LEGO and the LEGO logo are trademarks of the LEGO Group. ©2012 The LEGO Group. 6012844