

DESIGNER HANDBOOK  
KIT 1 - SPACE DESIGNER

LEGO





## DEAR LEGO® MASTER BUILDER ACADEMY MEMBER,

Every LEGO® Master Builder starts his or her journey by building and playing with LEGO bricks around the same age that you are now.

In our company, we take great pride in our LEGO Master Builders. Every day for over 50 years, they have come to work to explore new ways of using LEGO bricks. The core principles and special techniques of LEGO building have been passed on from one generation to another over the years. Our Master Builders employ these skills in everything they create, from police stations to dinosaurs, as well as the giant brick sculptures that you can see in the LEGOLAND® parks. They are an inspiration to us and to builders of all ages all around the world.

As young boys, building with LEGO bricks was for both of us a way to bring our imaginations to life, and we filled many hours dreaming up new creations. Through the LEGO Master Builder Academy program, we will also be proud to share some of the most inspiring creations built by our talented fans, as well as their own special building tips and stories.

Now that you are a member of the LEGO Master Builder Academy, you will learn many techniques and secrets from our LEGO Master Builders, who have come together with the goal of inspiring you to build amazing new creations that you can share with us and your fellow LEGO MBA members.

Together with everyone working in the LEGO Group, we hope you will enjoy this program, and we look forward to seeing what you will build!

### KJELD AND JØRGEN

*Kjeld Kristiansen*

*Jørgen Vig Knudstorp*



"When our wheel came out in 1962, I started building a lot of cars. I imagined having my own LEGO® car factory, which I called LECA. Here I am showing my father Godthfred Kirk Christensen some of the many cars I built."

Kjeld Kirk Kristiansen,  
LEGO Group Owner  
(3rd Generation)

"When I was young, I built a lot of houses. I placed them on top of our ping pong table at home, creating a large town with trains and a harbor filled with ships."

Jørgen Vig Knudstorp,  
LEGO Group CEO



## TABLE OF CONTENTS

Your Journey Begins!	4
The Journey Continues...	6
What's a LEGO® Master Builder?	8
More LEGO® Master Builders!	10
Stretch Your Imagination!	12
LEGO® MBA Minifigure	14
Building Instruction ONE - HELICRAFT	16
Building Instruction TWO - ROCKET	34
Building Instruction THREE - SPACE FIGHTER	52
Space Design Challenge	74
Create Your Own Models	75
What Will You Create?	76
Designing a Concept	78
Building Great Space Models	80
Space Designer Elements	82
Brick Paper	83

# YOUR JOURNEY BEGINS!

WELCOME TO THE LEGO® MASTER BUILDER ACADEMY!

Congratulations! You've just taken your first step on an amazing journey during which you will discover the never-before-revealed skills and building techniques of the real LEGO® Master Builders.

The theme of this first MBA Designer Handbook – *LEGO SPACE DESIGNER* – was specially selected by LEGO fans as one of the top themes that they wanted to master. Now that you have your first kit, let's blast off into the world of Space model design!

You'll start your adventure by following the building steps included in this handbook to make three different Space models developed exclusively for LEGO MBA members. Each set of steps is full of tips, techniques and inside information from the LEGO Master Builders to help you learn to build the Master Builder way.

Once you've built the models and learned the techniques, you'll find inspiration and ideas for making your own original spaceship creations and taking part in the MBA Space Design Challenge!

**4**

Prepare for launch, because your adventure is just starting!



EXPAND YOUR JOURNEY at  
[www.LEGOmba.com!](http://www.LEGOmba.com)

You'll find even more ideas, inspiration and fun at the official  
LEGO Master Builder Academy website!



By using the code below, you will get access to **LEGO MBA KIT 1** tips, bonus features, building challenges and the chance to see what other LEGO MBA members are creating and talking about!

You can also get badges and earn points to move up in rank, and to unlock even more features about designing and building with your LEGO bricks!

**MT8A-5X42**

YOUR MBA KIT 1 CODE



5

# THE JOURNEY CONTINUES...



## KIT 2: MICROBUILD DESIGNER

Get ready to think small with a giant introduction to microscale building! The LEGO Master Builders will show you how to create three detailed microscale models using the same pieces. Learn the principles of size-scaling and building with smaller LEGO elements! Plus, bonus buildable accessories help your MBA Minifigure join in on the microscale fun!

## KIT 3: ROBOT DESIGNER

Enter the world of robots and mecha with the MBA Robot Designer kit! Build three different hi-tech, poseable robots using the same pieces, while you practice the authentic LEGO Master Builder techniques of balance, detailing and finding unusual alternatives uses for your LEGO bricks. Includes unique buildable accessories to outfit your MBA Minifigure as a robot commander!

This LEGO® Space Designer kit is just the start of the LEGO MBA journey! A LEGO Master Builder Academy **SUBSCRIPTION** includes a total of **5** more exclusive LEGO MBA kits and Designer Handbooks, with each new kit and Handbook **ARRIVING EVERY 2 MONTHS**. Each kit will spotlight a different fan-favorite LEGO building theme.

Visit [shop.LEGO.com/LEGOmba](http://shop.LEGO.com/LEGOmba) to find out more about how to subscribe to receive these other exciting LEGO MBA kits!

## LEVEL 1

EACH LEGO MBA LEVEL IS MADE UP OF THREE COLOR-CODED KITS. LEVEL 1 IS THE GREEN LEVEL. YOU ARE A LEVEL 1, KIT 1 MEMBER. HERE'S WHAT YOU WILL RECEIVE IF YOU SUBSCRIBE TO CONTINUE AS A GREEN LEVEL 1 MEMBER!





## LEVEL 2

ONCE YOU ARE A SUBSCRIBER, WITH YOUR FOURTH KIT, YOU'LL GRADUATE TO MBA LEVEL 2 AND START TO BUILD MORE COMPLEX MODELS USING ADVANCED MASTER BUILDER SKILLS AND NEW TECHNIQUES!

### KIT 4: FLIGHT DESIGNER

You've learned the basic Master Builder skills, and now you're ready to move up to the next level of the LEGO Master Builder Academy! Enter the world of flying vehicles with instructions to build three exciting airplane models using the same pieces. Learn advanced skills of shape and stability. Includes an **EXCLUSIVE YELLOW LEVEL 2 MBA MINIFIGURE** and special pilot accessories!



### KIT 5: CREATURE DESIGNER

It's time for a creature feature as you use the LEGO Master Builder techniques of color and styling to learn to make "living" LEGO models by building three wildly different creatures using the same pieces! Includes buildable accessories to help your Level 2 MBA Minifigure fit right in with its ferocious new friends.



### KIT 6: AUTO DESIGNER

You don't have to be the world's fastest brick-clicker to make these three speedy racecars, but by the time you've mastered your first year of authentic LEGO Master Builder skills, you'll be ready to build with the best! Includes bonus accessories to make your MBA Minifigure ready to drive and customize anything on wheels.



# WHAT'S A LEGO® MASTER BUILDER?

## THESE MASTER BUILDERS DESIGN LEGO® SETS!

At the LEGO® Group headquarters in Billund, Denmark, LEGO Master Builders are the amazingly talented designers who create all the new LEGO sets that you see in stores. Their models have to follow specific construction rules to ensure that they're strong enough to hold together while being fun to build and play with. A model designer's creations are built to fit a specific size, age range and LEGO theme.

Thanks to their LEGO training and their years of practice at designing models, the LEGO Master Builders have created an entire library of **SPECIAL TIPS** and **SECRET TRICKS** for building with LEGO bricks. They know the official techniques for making the very best strong, stable and functional models around. And now for the very first time, through the LEGO Master Builder Academy, they're going to help you become a better LEGO builder by sharing their knowledge and experience with **YOU!**







## STEEN SIG ANDERSEN



How does a LEGO Master Builder create a new LEGO model? Here's how Danish model designer Steen Sig Andersen worked to make the three spaceships included in this Handbook!

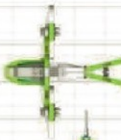

### HELICOPTER MODEL

"The wings with the engines built in, together with the split tail, are my favorite parts of the Helicopter model. The biggest challenge in designing it was to make the landing gear on the bottom big and strong enough to support it, while making sure the ship still looked cool and not too clumsy."



### ROCKET MODEL

"The most difficult part of building the Rocket was getting the tailfins to be stable enough to stand the model upright with its nose pointing up, ready for take-off. They also had to be buildable in a way that would be clear in the building instructions. I really like this model's slim design, and how it looks like such an iconic type of spaceship."



### SPACE FIGHTER MODEL

"Getting the hinged wing function to be stable on this model was a nightmare! I had to redesign and rebuild it several times, and even then, the wings were still a challenge. But in the end, they're my favorite part of the Space Fighter model, because their movement lets you give the spaceship some very different shapes and configurations."

# MORE LEGO® Master Builders!

## THESE MASTER BUILDERS CREATE LEGO® SCULPTURES!

The LEGO® Master Builders at the USA office in Enfield, Connecticut, at the Kladno office in the Czech Republic and at the LEGOLAND® theme parks don't make the usual LEGO sets. Instead, their job is to design and build all of the spectacular, one-of-a-kind LEGO models that you can see at parks, stores and special events all across the world. Their incredible imagination and creativity help them to build everything from tiny and detailed micro-scale scenes to enormous sculptures more than 4 stories tall, assembled from hundreds of thousands of LEGO elements.



## LEGO MASTER BUILDERS COME FROM ALL OVER THE GLOBE.

Some of them started as illustrators and painters. Others were sculptors and woodworkers. A few have even been scientists and clowns! But wherever they came from, the Master Builders all have one big thing in common: they can look at LEGO bricks and see an unlimited universe of building possibilities. And while they work hard at what they do, they also have a lot of fun doing it. After all, not everybody gets to spend the whole day building with LEGO bricks!

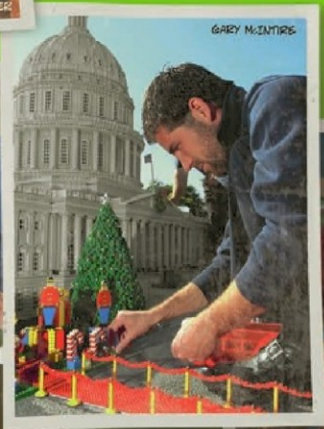

# Stretch Your Imagination!





## WITH LEGO® MBA BUILDING TECHNIQUES!

Like traditional LEGO® instruction books, every LEGO MBA Designer Handbook contains step-by-step instructions showing you how to build models using the parts included with your kit. What makes these instructions different is that they include notes from the Master Builders who designed the models, explaining **WHY** they used certain pieces and **HOW** each book's special techniques are being used. By reading the designer notes as you build the models, you'll be getting an exclusive insight into the minds of the Master Builders that will help you become a better builder!

For this first Space-themed kit, the LEGO Master Builders looked at the designs of both real and imagined spaceships, then picked out the specific LEGO pieces that they thought would work best for outer-space building. Building the three spaceship models included in this Handbook will give you valuable practice and skills to create your own original Space models using the same techniques and pieces – or the rest of your LEGO brick collection!



## USING THIS LEGO SPACE DESIGNER HANDBOOK, YOU'LL LEARN:

- 
 The important technique of **LOCKING** pieces together for stability and the creative art of using **SIDEWAYS BUILDING** to add shapes and details to your creations.
- 
 How to add basic moving functions onto your spaceship.
- 
 When to build sections of your model separately.
- 
 How to make sure your Minifigure pilot can fit inside your spaceship, and more!

Each of the three Space models in this Handbook uses these skills in different ways, so you'll be able to practice them again and again to see how they work. You can build the models in any order you want, and learn something new each time!



NOT STABLE!

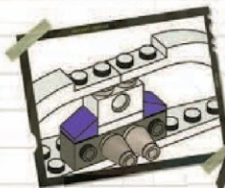

ADDING THIS PIECE MAKES  
YOUR WING STABLE!

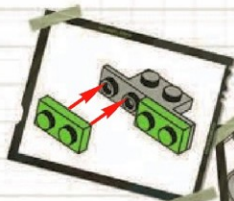
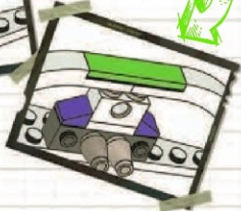

BUILDING ONTO THE  
SIDE OF YOUR MODEL...

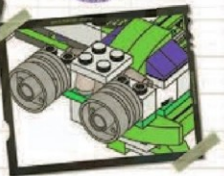

...LETS YOU ADD MORE  
SHAPES AND DETAILS!

# Presenting your First Master Builder Techniques

There are two tried and tested LEGO Master Builder techniques featured in the MBA Space Designer Handbook building steps. Look for a special stamp each time one is used!

## TECHNIQUE #1: LOCKING

Placing one LEGO piece across two others seems simple, but it's one of the most important building techniques that you can know. By **LOCKING** two or more bricks together with one that lies across them on top or underneath, you create an assembly that can hold more weight and stay connected better. The more you lock the LEGO pieces in your model together, the stronger and sturdier it will be!

## TECHNIQUE #2: SIDEWAYS BUILDING

Now we move from one of the most basic LEGO building techniques to one of the most unusual ones. Most of the LEGO bricks in your collection have studs on top and tubes or holes on the bottom so that they can be stacked on top of each other. Some less common pieces, though, have studs or holes that point in different directions. You can see the ones from your Space Designer kit illustrated below!

Thanks to these special LEGO elements, your creations don't have to just be built straight up and down. Try adding bricks that stick out to the sides, then build out from them to add even more details and shapes to your models. This extremely useful technique is what the LEGO Master Builders call **SIDEWAYS BUILDING!**

## The Stars of Sideways Building!



When you see this star symbol in the Helicraft building steps, you'll know that you're using a piece that's great for **SIDEWAYS BUILDING**. (For the other two spaceships, it's up to you to recognize them!)



# LEGO® MBA MINIFIGURE

MEET THE MASTER BUILDER ACADEMY MINIFIGURE!

This colorful character is your companion and guide during your journey to discover the techniques of the LEGO Master Builders and take your LEGO creations to the next level!

For this Space Design Handbook, your Level 1 MBA Minifigure includes unique buildable accessories to equip him for outer space adventures. Each new MBA kit and Handbook comes with additional themed accessories, plus a brand-new Level 2 Minifigure when you advance to the fourth kit.

You can use your MBA Minifigure to drive or pilot the vehicles that you create, but he can come in handy during the building process, too. You can use him to test the size of a cockpit or attach him to your model by his hands and the holes on his legs to check its stability. As you become a better LEGO builder, you'll be able to think of even more ways to include your Minifigure in your building!

Ready to build your Minifigure and his first set of accessories? **Then Let's Get Started!**



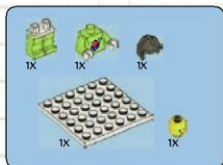

1

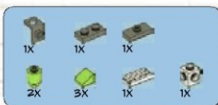
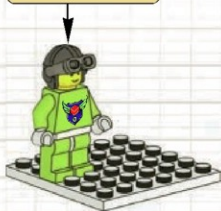
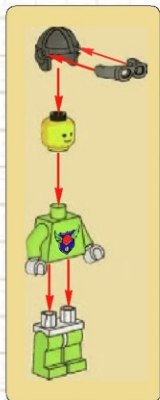

2

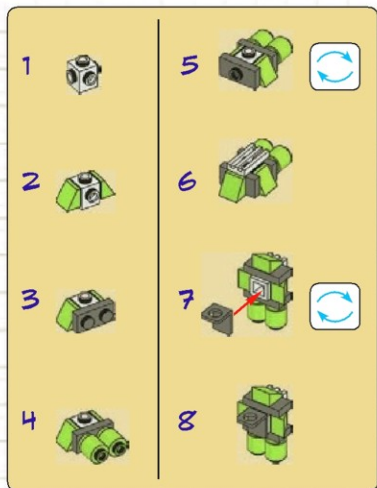



# HELICRAFT

Built to blast through outer space or the sky over a battlefield planet, the tough and rugged Helicraft is an example of a popular modern design style: sci-fi vehicles inspired by today's realistic technology. With its pod-shaped armored cockpit and extended split-fin tail, it could be a near-future version of a modern helicopter, but with antigravity engines and photon cannons added to give it a LEGO Space twist.

After you've learned the sideways building and locking techniques by finishing the Helicraft, use those skills to update other real vehicles into the spaceships of tomorrow!



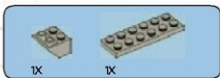

1

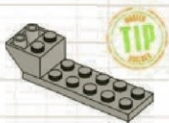

2

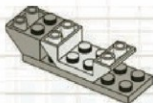

3

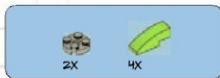

4

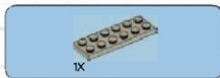
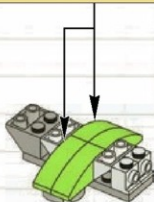
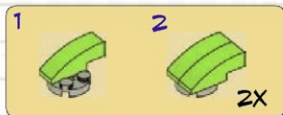

5

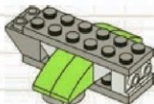

**STEP 1 TIP**

Start your spaceship with a good, solid internal core. It may not look like much yet, but it will help support everything that you build onto your model later!

**STEP 3 TIP**

This LEGO element is called an ERLING BRICK. It's a real "Star" because the extra stud on the side makes it great for **SIDWAYS BUILDING!**





6

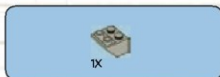
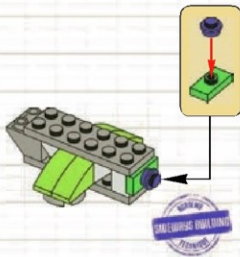

7

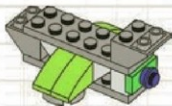

8

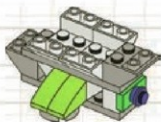

9

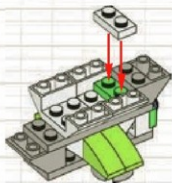

HERE'S THE MASTER BUILDER  
TECHNIQUE OF *SIDWAYS BUILDING!*

By making use of elements with studs or holes on their sides instead of just their tops and bottoms, you can enhance your models by building in a whole new direction!

STEP 6

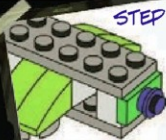

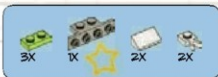

10

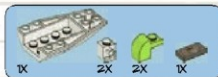
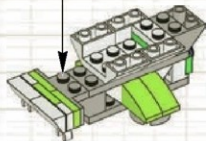
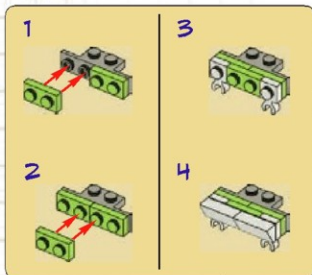

11

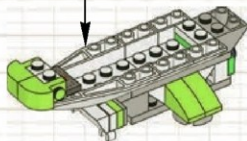
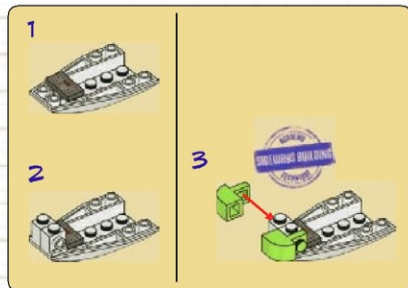

HERE'S ANOTHER USEFUL PIECE THAT YOU CAN USE FOR *SIDWAYS BUILDING!*

You're assembling this section of the spaceship separately and then attaching it to the main model. This helps to keep it stable during construction.

STEP 10.1

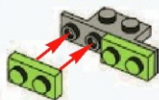



12

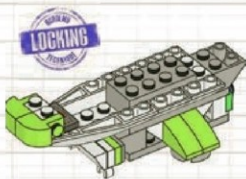

13

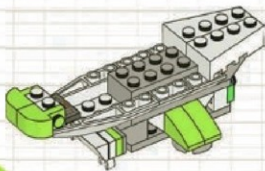

14

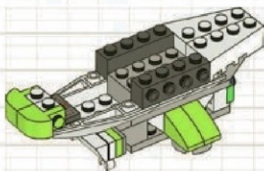

15

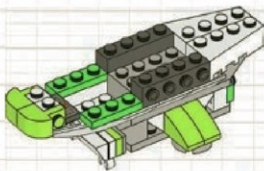

20

HERE'S THE MASTER BUILDER  
TECHNIQUE OF *LOCKING!*

You can lock two (or more) pieces together by placing an additional piece across them. This basic but important technique adds strength and stability to your model.

STEP 12



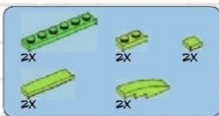

16

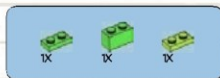
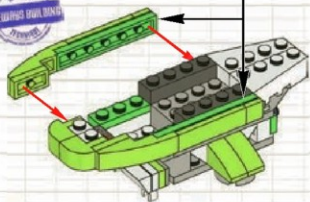
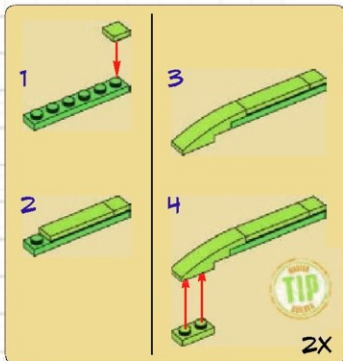

17

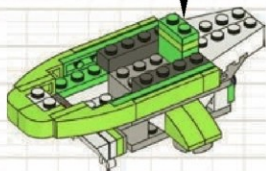
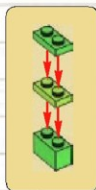

18

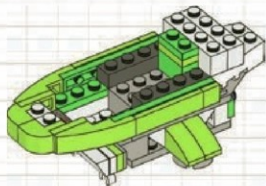

**STEP 14 TIP**

This is another great piece for **SIDEWAYS BUILDING!**

**STEP 16.4 TIP: SYMMETRICAL BUILDING**

You will build this sub-section exactly the same way twice before attaching it to your model. This lets you have the same decorative shape on both sides!



21



19

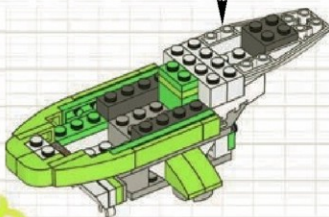
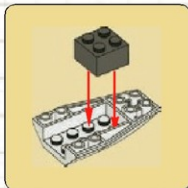

20

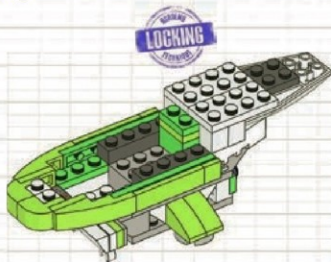

21

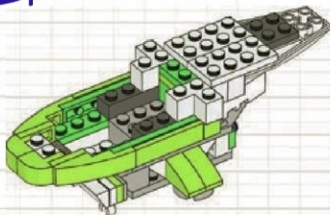

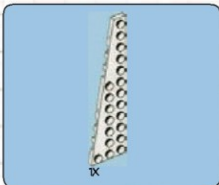

22.1



22.2



**STEP 22.1 TIP**

Just like in the small section in **STEP 10**, you'll get better stability during construction if you build large decorative parts of your spaceship separately before attaching them to the main model.

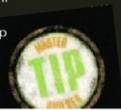

22.3

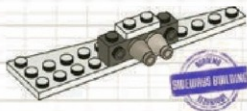

22.4

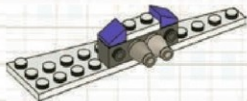

22.5

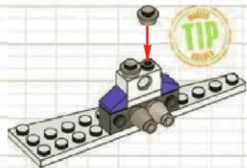

**STEP 22.5 TIP**

It's not just sideways-facing studs that let you use the **SIDEWAYS BUILDING** technique. The hole in the side of this brick can be used to attach a LEGO stud or, as you'll see in a few steps, a LEGO Technic pin!





22.6

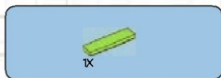
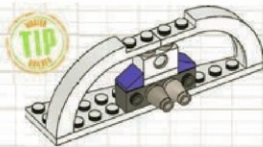

22.7

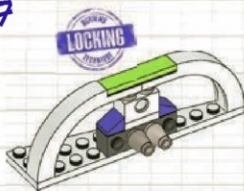

## STEP 22.6 TIP

These arch pieces are good for sweeping decorative shapes. Because they don't have many attachment points, though, it's important to lock them with the next step's green tile piece.

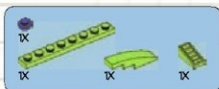

22.8

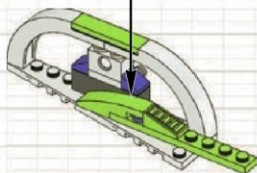
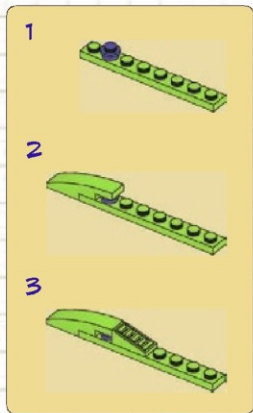



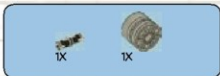

22.9

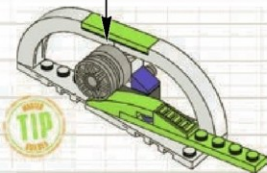
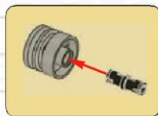

22

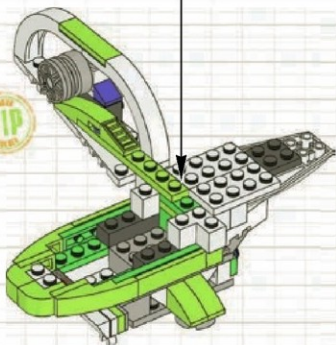

### BONUS TIP:

BECAUSE THE WING YOU'VE JUST ATTACHED IS NOT LOCKED DOWN YET, IT CAN EASILY DETACH FROM THE MODEL AT THIS POINT. TO KEEP IT IN PLACE, YOU CAN SUPPORT IT BY RESTING THE WING ON SOMETHING, OR EVEN KEEP IT SEPARATE UNTIL YOU'RE READY TO LOCK BOTH WINGS IN STEP 24.

### STEP 22.9 TIP

Want to make your spaceship look like it could really blast through outer space? Elements like this wheel core make great sci-fi rocket engines!



### STEP 22 TIP

Now you can see why you built this section of the model separately. If you tried to add it to the spaceship one brick at a time, it would have been hard to get it to hold together!



25

TIP

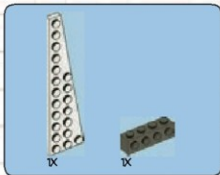
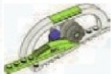

23.1

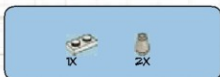
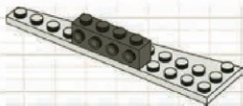

23.2



**STEP 23.1 TIP:**  
SYMMETRICAL BUILDING PART 2

Here you're building a mirror image of the last spaceship section. Building mirrored parts lets you add interesting shapes to your model that match on both sides!



23.3

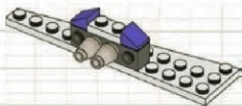

23.4

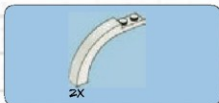
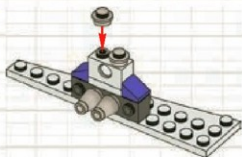

23.5

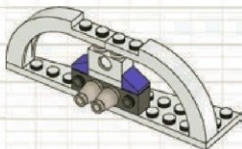

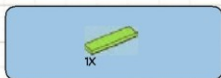

23.6

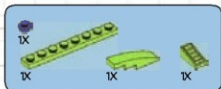
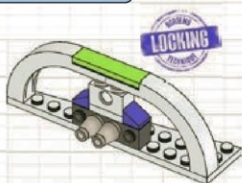

23.7

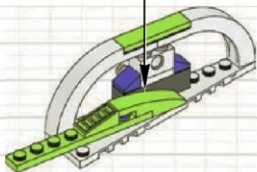
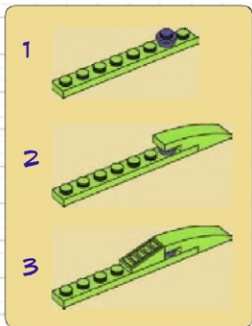

23.8

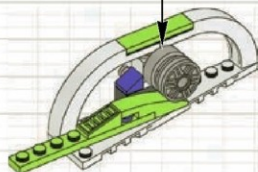
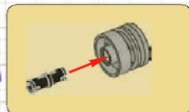

23

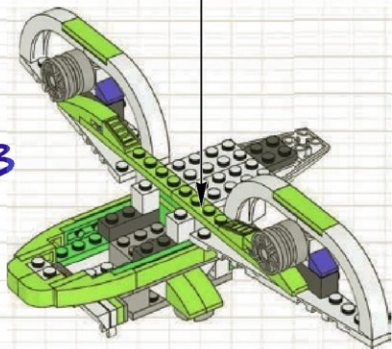



24

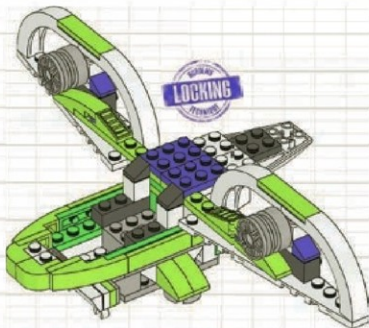

25

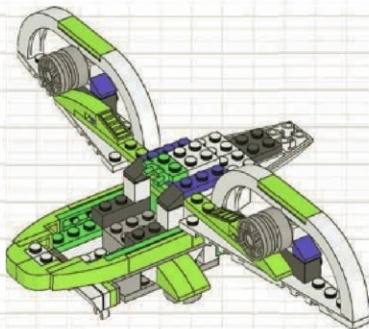

28

**TECHNIQUE: LOCKING!**

These two purple plates will help support the weight of your spaceship's wings.

In **STEP 26**, you'll add additional pieces across both plates to double-lock them for even more stability.



STEP 24



2X

26

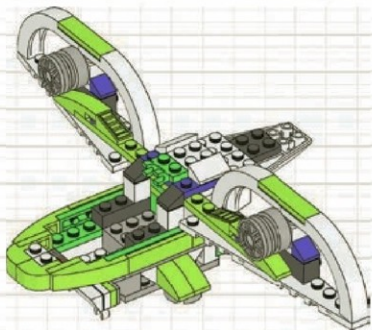

1X



2X

27

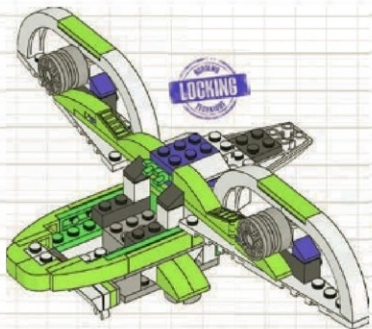

LOCKING

STEP 27

#### STEP 25 TIP

This green plate piece with two clips will be used to attach your spaceship's cockpit canopy!



#### TECHNIQUE: LOCKING!

By locking the clip plate in place with this purple plate, you're making sure that it won't pop off when you open and close the canopy later on. You're also using the green bow element to lock the wings in place even more securely. Even though they started out only weakly attached, thanks to all of the locking you've done, they're now extremely stable!

29



2X

2X

28.1



1X

28.2

**STEP 28.2 TIP**

Hinge elements aren't only used for movement! This one will hold these green pieces at the right angle to create the shape of your spaceship's tail fin.



2X

28.3



2X

28.4

**STEP 28.4 TIP**

This extra pair of hinge elements will let you attach the angled-shape tail fin to the straight-shape back of your spaceship.



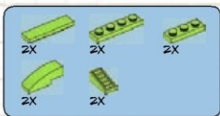

28.5

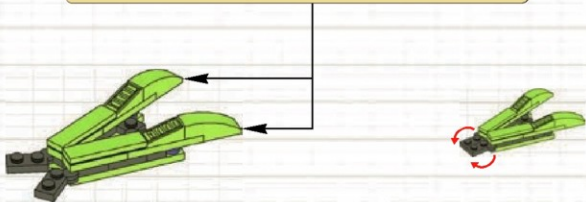
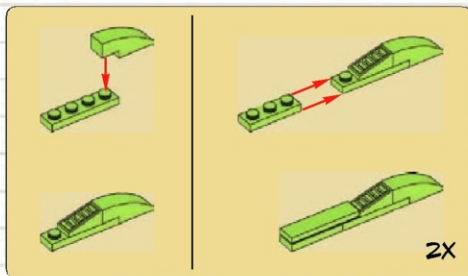

28

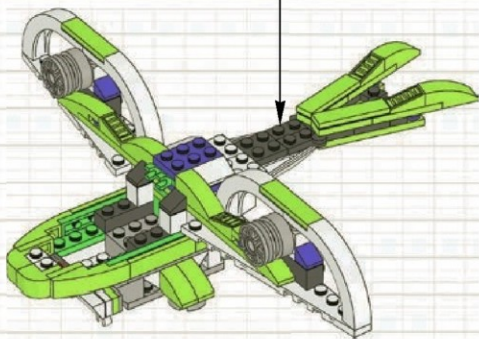

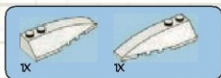

29

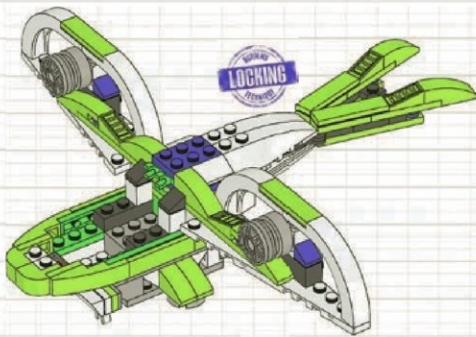

30

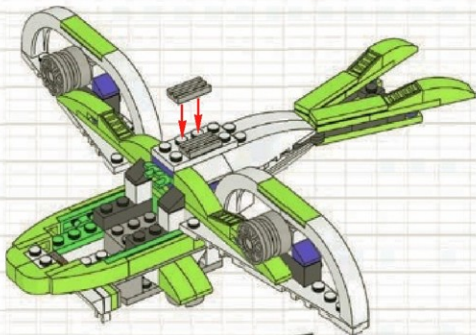
**TECHNIQUE: LOCKING!**

These shape elements serve a dual purpose: they lock your tail fin in place, and also add an aerodynamic curve to your spaceship.

STEP 29







1X

31

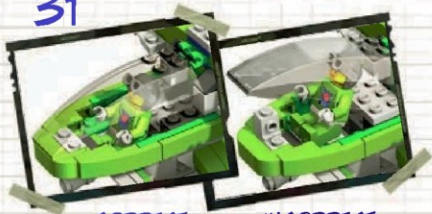

**CORRECT**

**INCORRECT**

WHEN YOU DESIGN YOUR OWN SPACESHIPS, DON'T FORGET TO TEST-FIT THE COCKPIT WITH YOUR MIB MINIFIGURE!

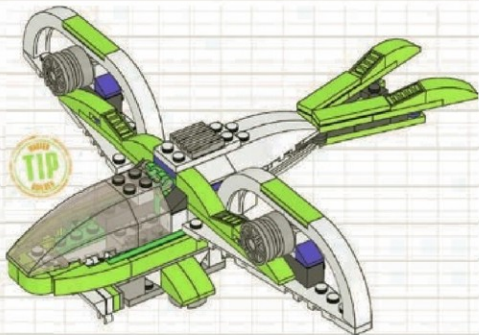

2X

2X



32

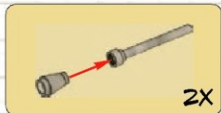

2X

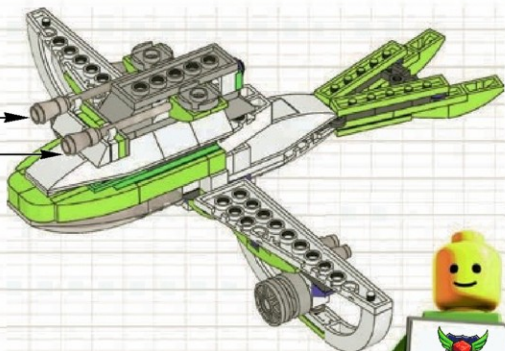

### STEP 31 TIP: MOVING PARTS

Here's where you attach the canopy piece to the clips to create a full spaceship cockpit. Thanks to **LOCKING** the clip plate down, you'll be able to open and close the canopy without it coming loose. You've created a model function!



### STEP 32 TIP: DETAILING

Now that your model is fully-built and stable thanks to plenty of **LOCKING**, you can go back and add extra details and decorations. Remember those mysterious white clip pieces that you used way back in **STEP 10**? They're the perfect attachment points for a pair of shiny new photonic blasters!



33



# ROCKET

At the dawn of the space age, this is what the future looked like: shining, needle-shaped rockets that launched straight up into the sky, ready for colorful and extraordinary adventures on strange alien worlds out among the stars. It was an era of excitement, hope and imagination, a science fiction golden age that is represented by the design of the ultra-retro Rocket spaceship.

Sideways building and locking techniques will help you create a model that is not only stable, but so streamlined that almost no LEGO® studs are visible on its surface! Get ready to blast off in 3...2...1...



1

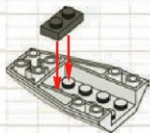

2

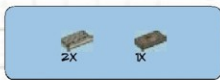
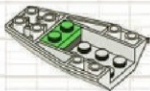

3



4

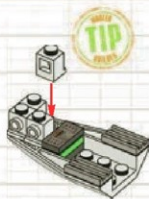

#### STEP 3 TIP

LEGO elements with printed graphics can make great computer readouts and control panels for the inside of a spaceship's cockpit. Other pieces like these gray grills can add surface "tech" details to your model.

#### STEP 4 TIP

The studs on the sides of these 'Erling bricks' will let you use the first Master Builder technique for this model in the next step!



2X

5

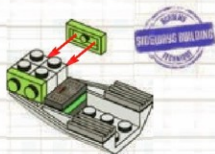

6

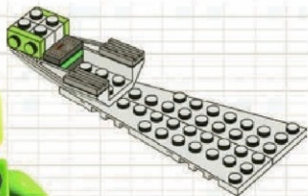

3X

7

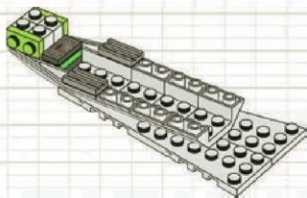

1X

1X

8

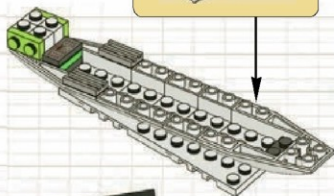
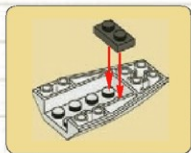

**MASTER BUILDER TECHNIQUE:  
SIDEWAYS BUILDING!**

By making use of elements with studs or holes on their sides instead of just their tops and bottoms, you can give yourself even more creative options for designing your LEGO models.

STEP 5

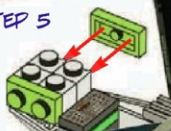



9



10

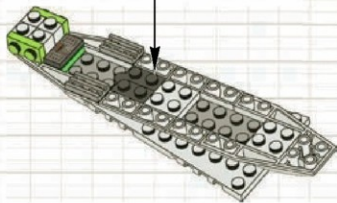

### BONUS TIP:

YOU WOULD NORMALLY USE A HINGE ELEMENT LIKE THIS ONE TO ADD MOVING FUNCTIONS OR ANGLED SECTIONS TO A MODEL, BUT IF YOU NEED A PIECE OF A CERTAIN SIZE AND SHAPE, IT CAN FOLD UP AND DOUBLE AS A REGULAR 2X2 PLATE!

### MASTER BUILDER TECHNIQUE: **LOCKING!**

By placing one large piece across two other pieces, you're using the key Master Builder technique of **LOCKING!** This basic but important technique adds lots of extra strength and stability to your model.



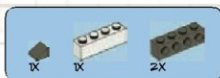

11

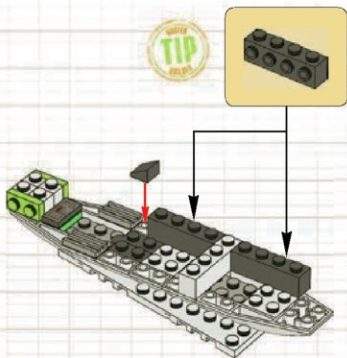

12

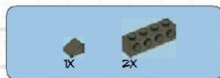
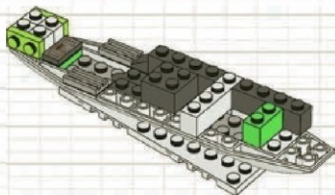

13

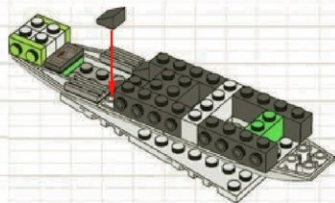

## STEP 11 TIP

Here's another great studs-on-the-side element that you can use for **SIDEWAYS BUILDING!**





14.1



14.2

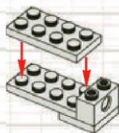

**STEP 14.1 TIP: BUILDING IN SECTIONS**

When adding a multi-piece structure to your model, like this rocket's main engine, it can be useful to first build it separately and then add it to the main model when all of the pieces are assembled.



14.3

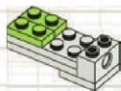

14.4



**STEP 14.1 TIP**

The hole in the side of this 1x2 brick makes it great for **SIDEWAYS BUILDING**, since it can hold either a LEGO stud or a Technic pin.

**STEP 14.4 TIP**

Here's yet another handy piece for **SIDEWAYS BUILDING!**





14.5



4X

14.6

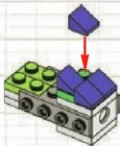

1X

14.7

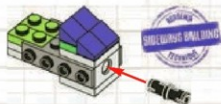

1X

1X

14.8

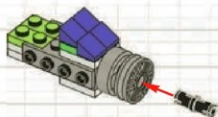
**STEP 14.9 TIP**

By adding a second Technic pin and wheel core, you create an extra-long spaceship thruster to make it look like your rocket can blast really far and fast!







1X

14.9

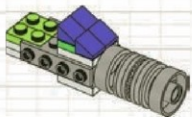

2X



2X

15

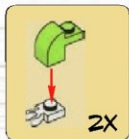

2X

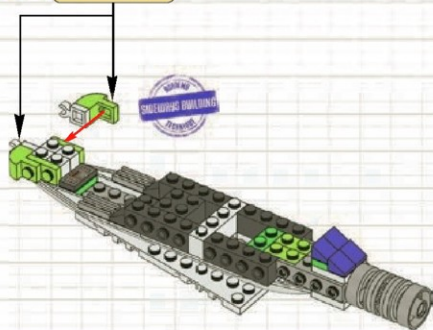
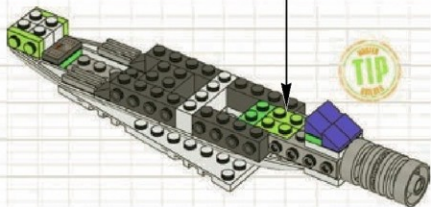

14

**STEP 14 TIP**

Now that you've built the entire rocket engine section separately, it should be stable enough to attach it to the main body of your model.

**STEP 15 TIP: PLANNING AHEAD**

When designing your LEGO model, it always helps to think ahead. The clips that you're adding in this step will come in handy later in the building process!



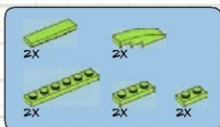

16

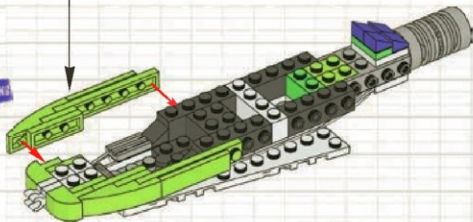
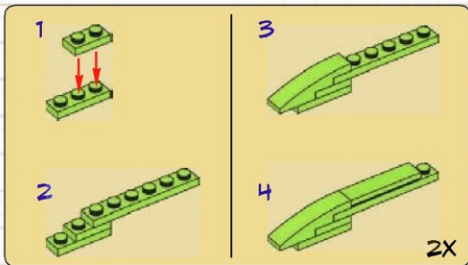

#### STEP 16 TIP: STREAMLINED SHAPES & COLOR

You will build this sub-section exactly the same way twice before attaching it to the model using **SIDEWAYS BUILDING**. This creates a smooth, streamlined shape highlighted by a stripe of bright color.



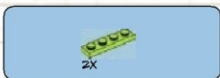

17

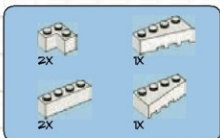
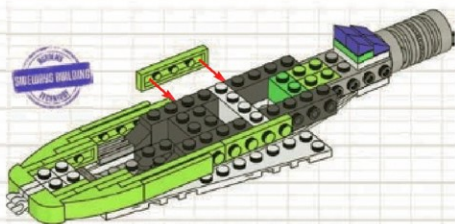

18

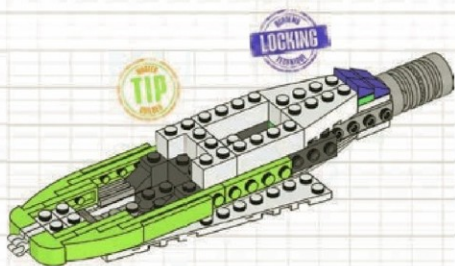

**STEP 18 TIP: ADDING SUPPORT**

The L-shaped bricks used in this step will provide support for the plate "roof" that you'll be adding in the next one.



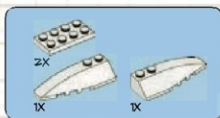

19

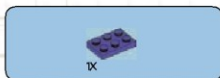
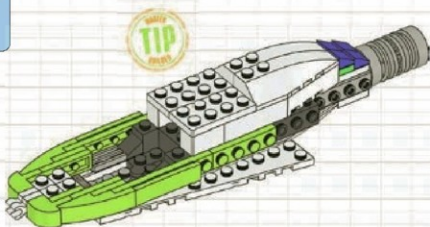

20

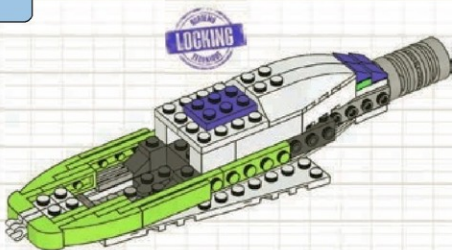
**STEP 19 TIP**

Without the central supports created in the previous step, these two 2x4 plates wouldn't be able to handle the weight of additional bricks built on top of them.

**STEP 21 TIP**

This green plate piece with two clips will be used to attach your spaceship's cockpit canopy!



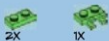

21

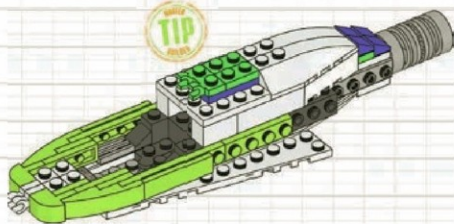

22

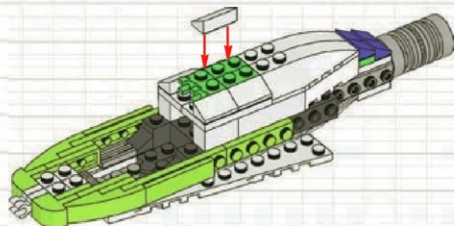

23

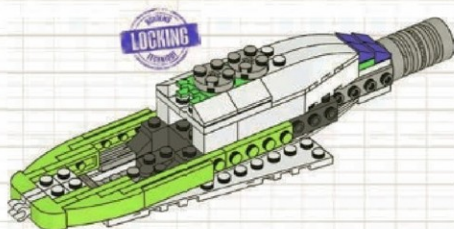

**MASTER BUILDER TECHNIQUE: LOCKING!**

By locking the clip plate in place, you're making sure that it won't pop off when you open and close the canopy... plus, these two round plates add a bit of hi-tech decoration to your rocket. Are they cosmic-powered batteries? Anti-asteroid shield generators? It's up to you!

STEP 23

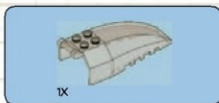

24

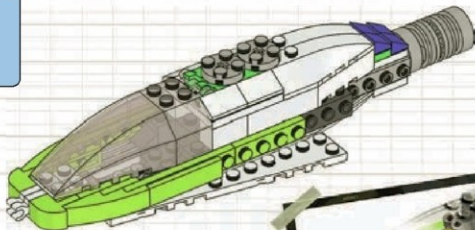
**BONUS TIP:**

WHEN MAKING YOUR OWN SPACESHIP MODELS, DON'T FORGET TO TEST-FIT THE COCKPIT WITH YOUR MBA MINIFIGURE!

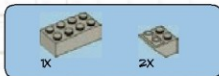

25

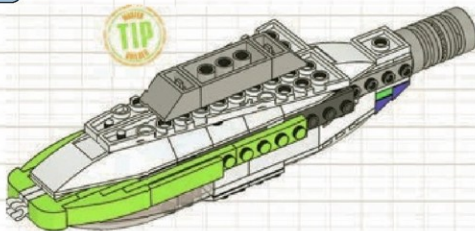
**STEP 24 TIP: MOVING PARTS**

Thanks to **LOCKING** the clip plate down securely, you'll be able to open and close the cockpit without it coming loose. You've created a model movement function!

**STEP 25 TIP**

Now that the main body of the rocket is locked together and sturdy, you don't need to build it on a flat surface any longer. You can flip it over and add the bottom details!





26

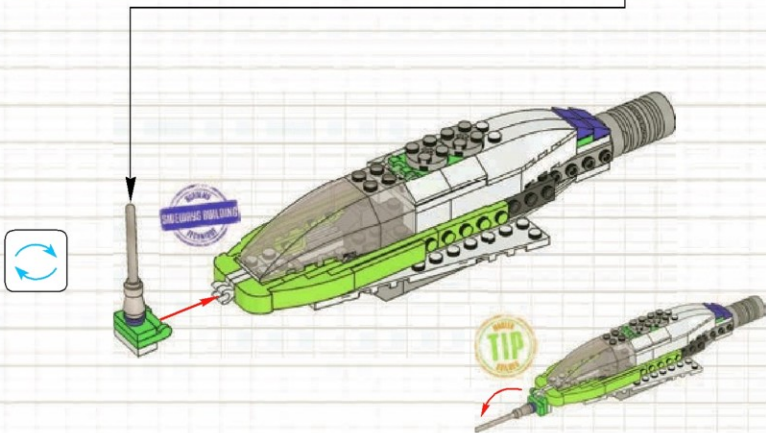
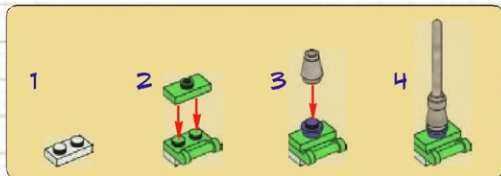

**STEP 26 TIP**

If you plan things out, you can use hinges and other moving parts in unexpected ways. By attaching the rocket's needle-nose and swinging it down, you've found yet another way to build sideways!



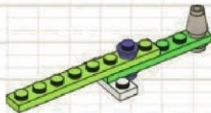
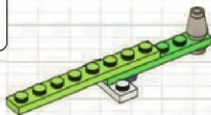
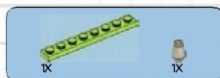
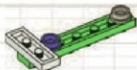
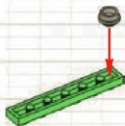

#### STEP 27.1 TIP

The elegant and retro-futuristic fins of the rocket can't be easily built onto the model one brick at a time. Once again, you're going to build these sections separately and then attach them once they're locked-together and stable.





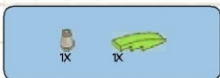

27.5



27.6

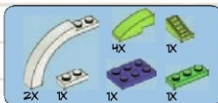
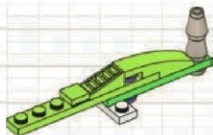

27.7

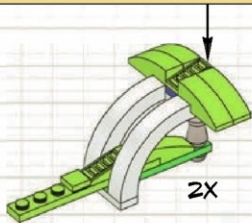
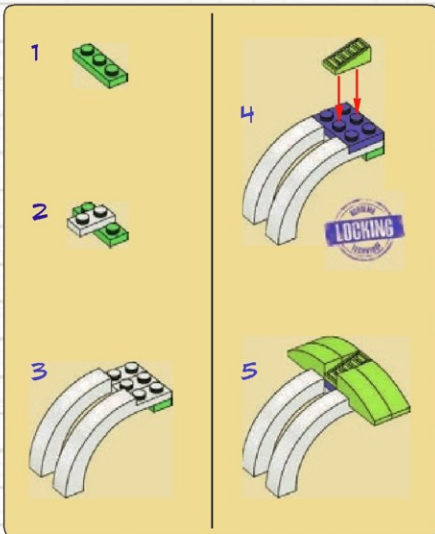

27

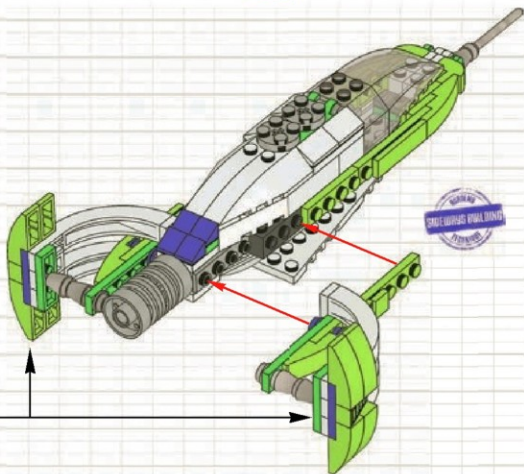

**MASTER BUILDER TECHNIQUE:**  
**SIDEWAYS BUILDING!**

Now that the fin sections are totally reinforced by multiple uses of the locking technique, you can connect them to the rocket using sideways building. They're so stable that you'll be able to stand your rocket on its end, ready for launching!

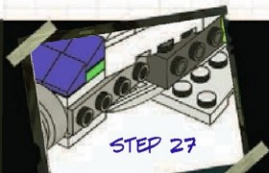

2X

28

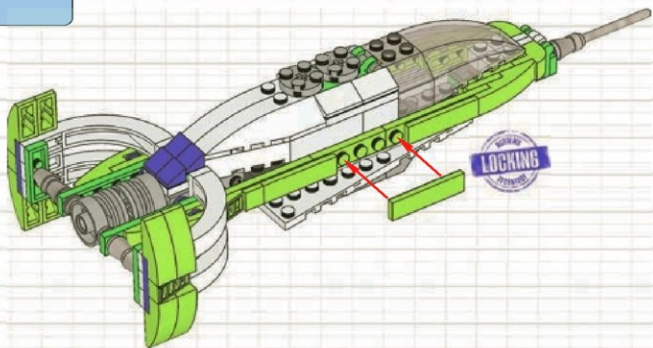

2X

29

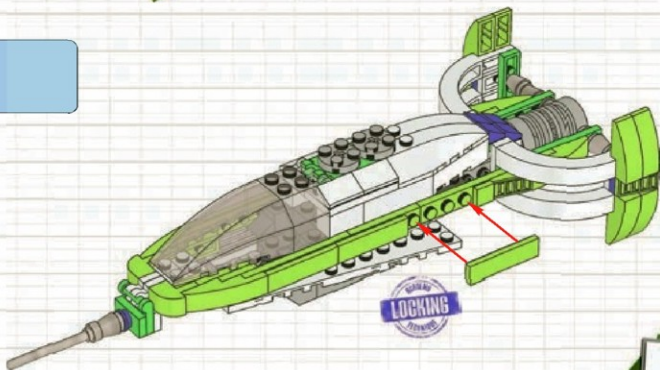



# SPACE FIGHTER

The sleek and super-futuristic Space Fighter was designed for maximum speed and maneuverability on missions in distant galaxies. Unlike the realistic Helicraft, this exotic spaceship is pure science fiction, with sweeping curves and angled wings that could be the product of some alien civilization or a new human technology invented many centuries from now.

Creative use of hinges and the Master Builder technique of sideways building will really come in handy here as you build this model's aerodynamic shape, then use the principle of locking to give it stability!

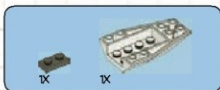

1

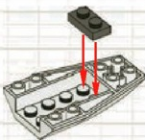

2

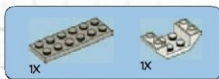
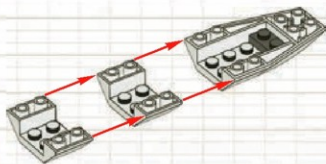

3

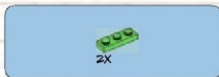
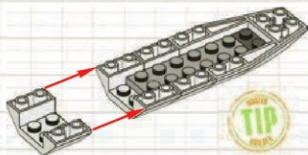

4

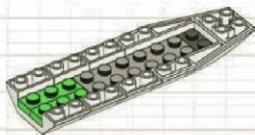

#### STEP 3 TIP

It might seem like it makes sense to build your entire model from the bottom up, but some details like supports and landing gear aren't easy to build on a flat surface. That's why you're starting with the main spaceship body and adding the bottom details later on!





5

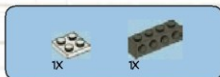
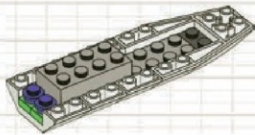

6

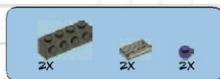
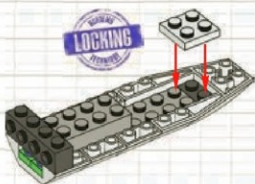

7

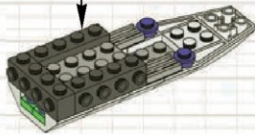
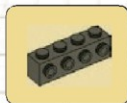

8



TIME TO USE THE MASTER BUILDER  
TECHNIQUE OF **LOCKING!**

This basic but important technique adds strength and stability to your model so that it won't fall apart later.

STEP 6

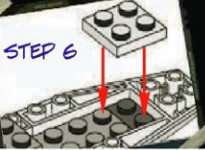

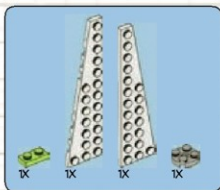

9

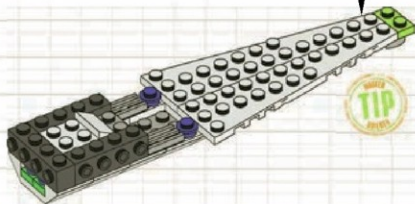
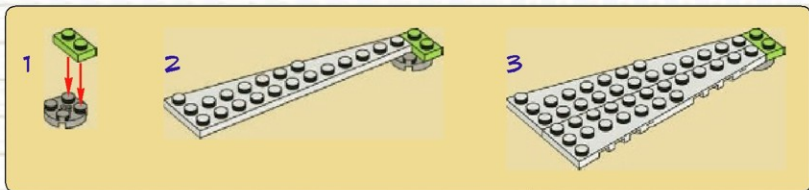

#### STEP 7 TIP

The studs on the side of this LEGO piece will come in handy when you start using the Master Builder technique of **SEWWAYS BUILDING** later on!

#### STEP 9 TIP: BUILDING IN SECTIONS

Large, thin pieces can be tricky to build directly onto the main body of a model. You'll often have better construction stability if you build a multi-piece section like this spaceship's front end separately and then attach it when it's done.





2x

10

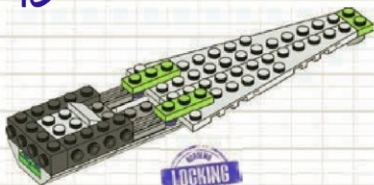

1x



1x

11

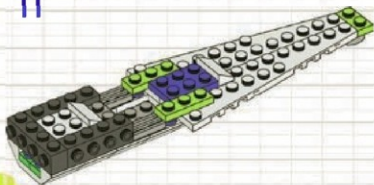

1x



2x

12

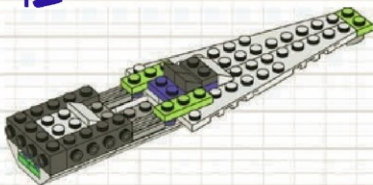

1x



2x

13

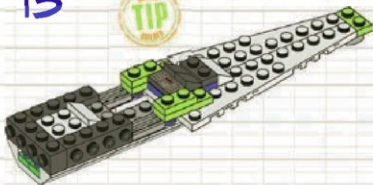
**STEP 13 TIP**

Some LEGO elements have printed graphics on them. Ones like these make great computer readouts and control panels for the inside of a spaceship's cockpit!

**STEP 14 TIP: SYMMETRICAL BUILDING**

You will build this sub-section exactly the same way twice before attaching it to your model. This lets you have the same decorative shape on both sides!





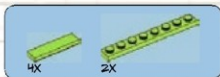

14

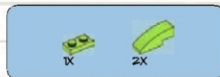

15

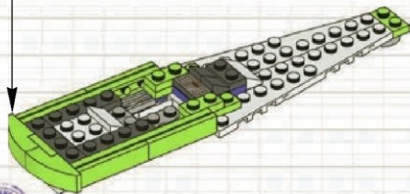
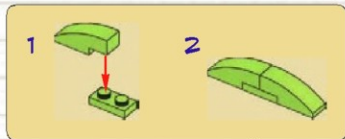
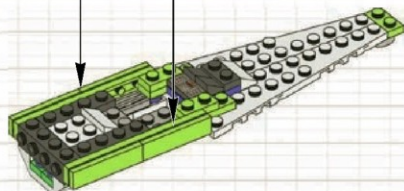
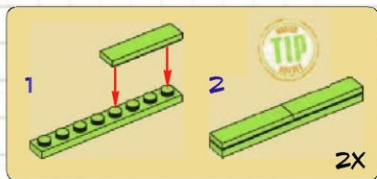

HERE'S THE IMPORTANT MASTER BUILDER  
TECHNIQUE OF *SIDWAYS BUILDING!*

By making use of elements with studs or holes on their sides instead of just their tops and bottoms, you can add details and shapes to keep your model from looking too blocky.

STEP 14





16

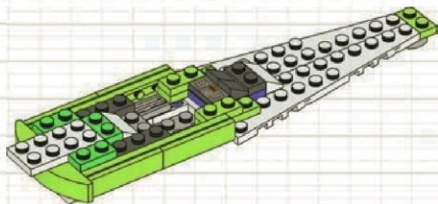

17

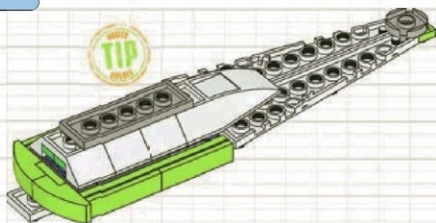
**STEP 17 TIP**

Now that you have a sturdy and stable main body for your spaceship, you can flip it over and add details to the underside.



1X

2X

18

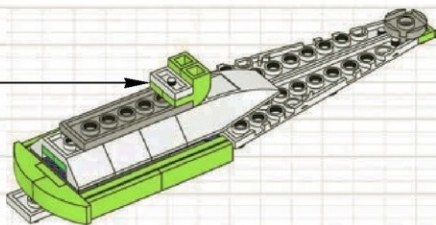
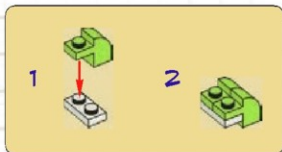

1X

2X

19

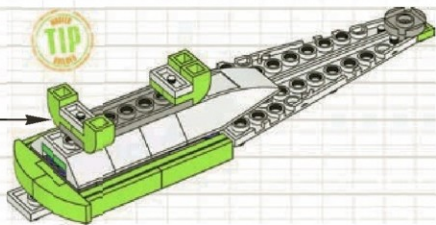
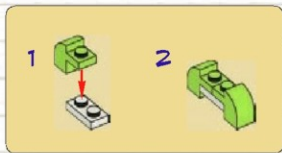

#### STEP 19 TIP: LANDING GEAR

Now you've built your spaceship's landing supports! When building landing gear or supports, keep in mind where your spaceship is heaviest, and make sure that they're positioned so that it won't tip over when it's done. You also want to make sure that the supports are at the same level so that your spaceship can rest evenly on a flat surface.





20.1



20.2

**STEP 20.2 TIP: USING HINGES**

Hinge pieces have two major uses. They can let you add moving functions to a model, or they can be used to attach parts at angles that wouldn't otherwise be possible with standard brick building.



20.3

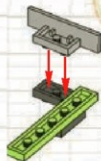

20.4

**STEP 20.3 TIP**

This is another great piece for **SIDWAYS BUILDING!**





20.5

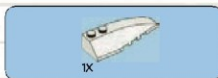

20.6

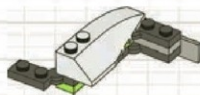

20

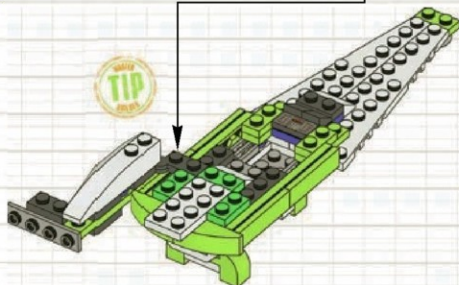

**STEP 20.4 TIP**

By adding a second hinge piece underneath, you've stabilized the first one to create a sturdy and functional moving part.

**STEP 20 TIP**

Because the section you've just attached is not locked down yet, it can easily detach from the model at this point. Handle with care until you're ready to lock it in **STEP 23!**





21.1



21.2



21.3



21.4





21.5

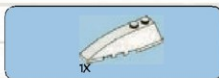
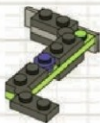

21.6

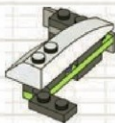

21

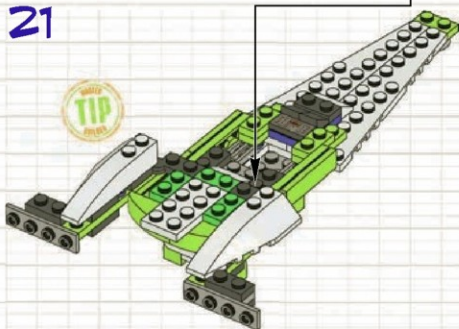

**STEP 21 TIP: MIRRORED BUILDING**

Here you've built a mirror image of the previous spaceship section. Learning to build a mirrored version of a model section will let you add interesting shapes and decorations while making your creation match on both sides!





2X



1X

22

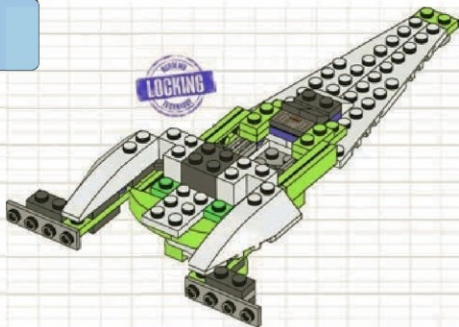

1X



1X



2X

23

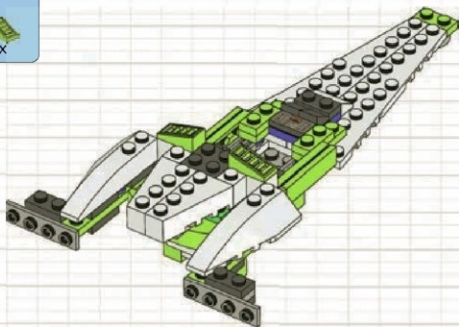

MASTER BUILDER TECHNIQUE: **LOCKING!**

Now that both sides are completed, locking them down together will stabilize the moving parts and make your model good and sturdy.

STEP 22







24

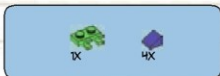
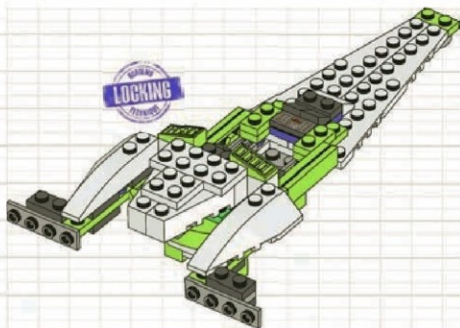

25

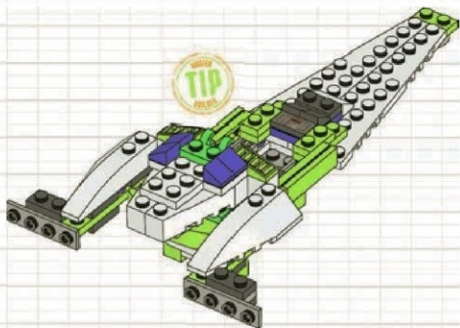

**TECHNIQUE: LOCKING!**

A double lock makes your model extra secure!

**STEP 24**



**STEP 25 TIP**

This green plate piece with two clips will be used to attach your spaceship's cockpit canopy!



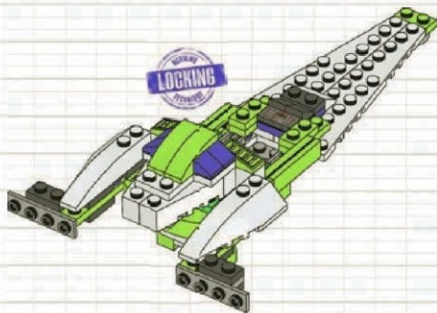

26

**TECHNIQUE: LOCKING!**

By locking the clip plate in place, you're making sure that it won't pop off when you open and close the canopy later on.

STEP 26



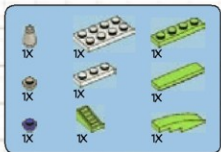

27.1



27.2

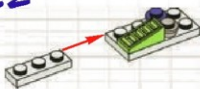

27.3



27.4

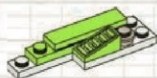

27.5

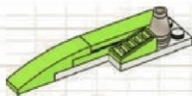

27

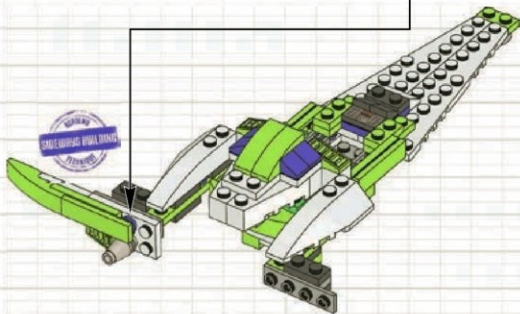

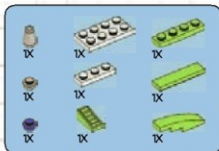

28.1



28.2

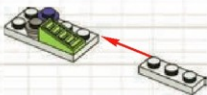

28.3



28.4



28.5

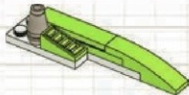

28

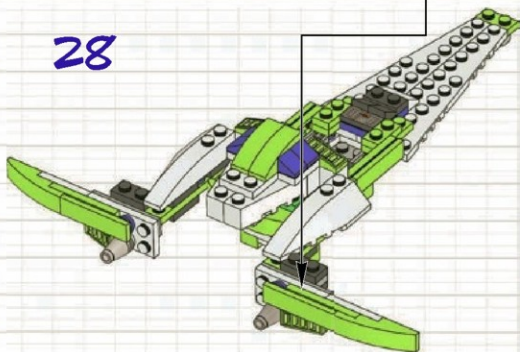

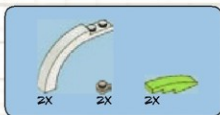

29

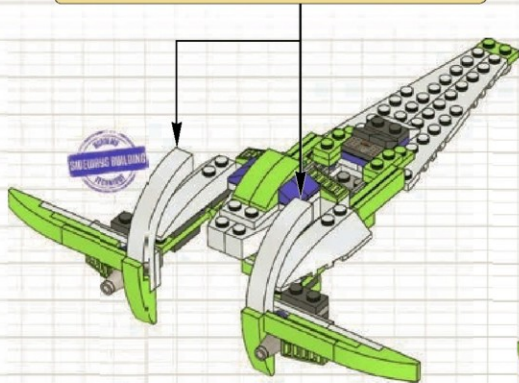
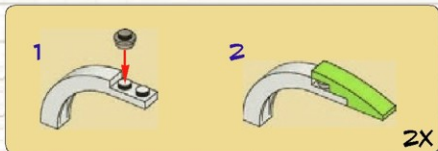

#### MOVING FUNCTION:

THANKS TO THE USE OF HINGE  
PIECES AND LOTS OF LOCKING  
FOR STABILITY, YOU'VE ADDED  
A BASIC MOVEMENT FUNCTION  
TO YOUR MODEL!

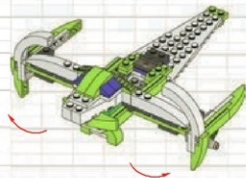

#### STEP 29 TIP

Decorative curves like these arch pieces help create a futuristic, sleek, sci-fi look for a spaceship. Other types and combinations of pieces can help your own spaceship models look bulky and industrial, retro-classic, or modern and realistic!



2X

2X

30

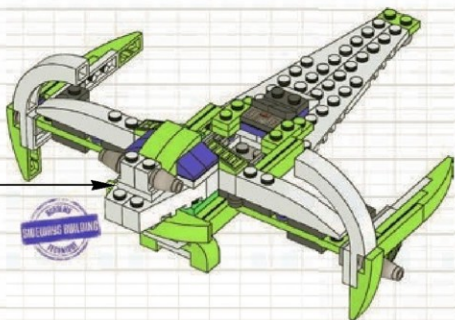
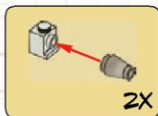
**STEP 31.3 TIP**

It's not just sideways-facing studs that let you use the **SIDEWAYS BUILDING** technique. The hole in the side of this brick can be used to attach a LEGO stud or a Technic pin!





# 31

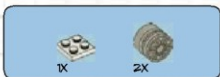
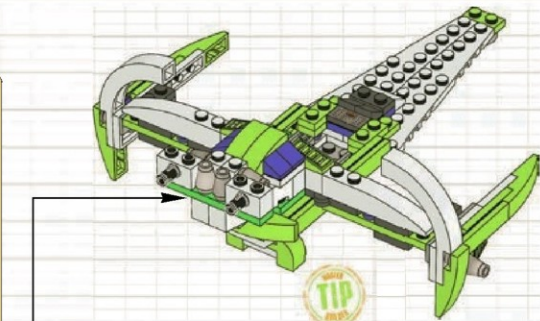
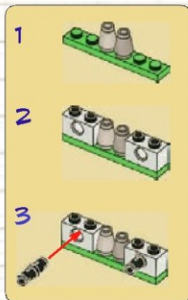

# 32

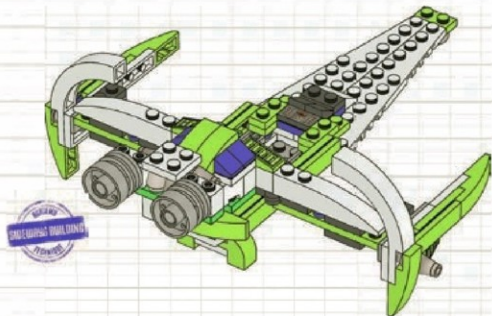

### STEP 31 TIP

Why did you build this section separately and then attach it? Because of the placement of the spaceship's support legs, pushing each piece down on the back of the ship one at a time might have tipped the whole model over!

### STEP 32 TIP

Want to make your spaceship look like it could really blast through outer space? Elements like this wheel core make great rocket engines!



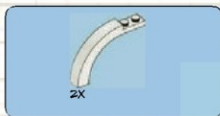

33

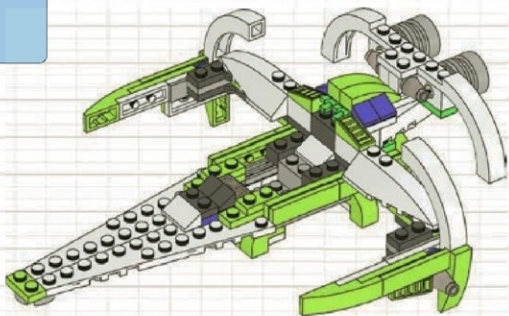

34

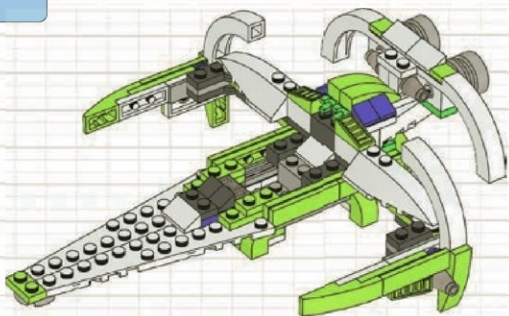



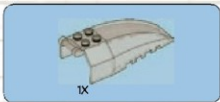

35

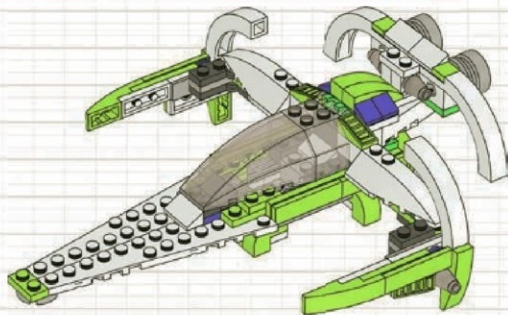

### STEP 35:

HERE'S WHERE YOU ATTACH THE CANOPY PIECE TO THE CLIPS TO CREATE A FULL SPACESHIP COCKPIT.

THANKS TO **LOCKING** THE CLIP PLATE WHERE YOU ATTACH IT, YOU'LL BE ABLE TO OPEN AND CLOSE THE CANOPY WITHOUT IT COMING LOOSE. YOU'VE CREATED ANOTHER MODEL MOVEMENT FUNCTION!



### BONUS TIP:

WHEN MAKING YOUR OWN SPACESHIP MODELS, DON'T FORGET TO TEST-FIT THE COCKPIT WITH YOUR MBA MINIFIGURE!

35.A

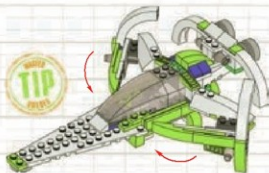

### STEP 35.A TIP

Now you can use the hinge function that you built earlier to swing the spaceship's wings into place. You can use similar building methods to create vehicles with adjustable wings for flying in different situations and environments!



# SPACE DESIGN CHALLENGE!

## TIME TO START DESIGNING!

You've built the three models in the Space Designer Handbook. You've practiced the official building techniques of the LEGO® Master Builders. Now it's time to take what you've discovered and use it to start making your own original LEGO creations!

On the following pages, you'll find tips and inspiration for creating brand-new Space models. Once you've designed and built a few, you can take the next step in your LEGO MBA journey by taking on the Space Design Challenge!

To take the Challenge, first create your personal membership at [www.LEGOmba.com](http://www.LEGOmba.com) (see page 5 for directions for registering and logging in). Upload photos of your LEGO creations and you'll start to earn badges that will let you unlock new content on the website. You'll also be able to view and rate models built by your fellow MBA members – and the models with the highest ratings from members and the LEGO Master Builder Academy team will be featured on the MBA home page!

ENTER HERE!

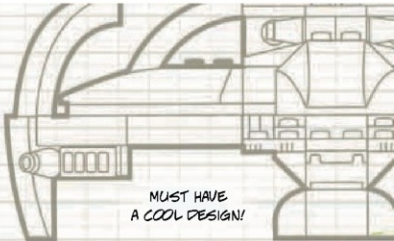

Upload a photo of your creation to [www.LEGOmba.com](http://www.LEGOmba.com), or send a photo of your model to:

**LEGO Master Builder Academy**  
P.O. Box 1308  
Enfield, CT 06083-1308

Photos will not be returned, so please keep a copy for yourself. For mailed entries, please include your name, nickname, address and the name of your model.

# CREATE YOUR OWN MODELS

Sometimes you don't want to follow instructions. You want to make up your own creations. After all, that's the fun of LEGO building! Even though this kit gives you instructions for three Space-themed models, you might have a totally different idea for what you'd like your spaceship to look like and do. Take the skills in this book and start building whatever you can imagine!

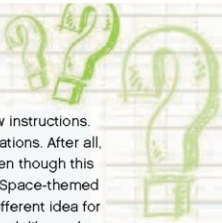

HERE ARE SOME SPACE-THEMED QUESTIONS TO CONSIDER WHILE YOU PLAN OUT YOUR VERY OWN CUSTOM CREATION:

1. HOW WILL YOUR SPACESHIP FLY? DOES IT NEED WINGS OR ENGINES?



4. IS IT A GOOD GUY VEHICLE, AND HOW CAN YOU SHOW THAT WITH YOUR DESIGN?



2. DOES IT NEED TO LAND? HOW WILL IT SUPPORT ITSELF ON THE GROUND?



5. DOES IT NEED FUEL? WHERE DOES ITS POWER COME FROM?



3. DOES IT CARRY PASSENGERS OR CARGO?



6. HOW CAN THE CREW ESCAPE IN AN EMERGENCY?



# WHAT WILL YOU CREATE?

What makes your imagination take off? Does the shape of a lamp remind you of a spaceship's engine? Does a pen cap make you think of a rocket's nose? Find or take pictures of things that inspire you, and they can help you design your own creations!

*FROM THE REAL TO THE WILD, FROM THE CLASSIC TO THE FUTURISTIC, SPACE-TRAVELING VEHICLES COME IN ALL KINDS OF SIZES, SHAPES AND COLORS.*

Take a look at this collection of real and imagined spaceships and see what you're inspired to create by combining your LEGO® bricks with your new building techniques!

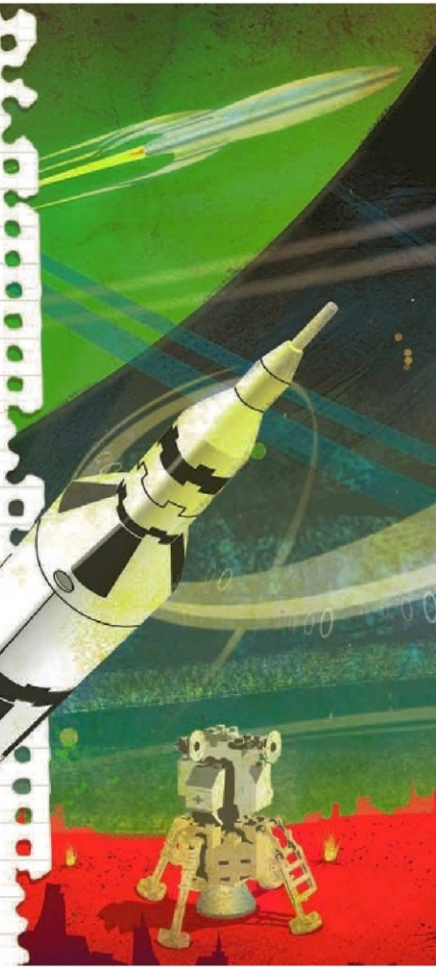
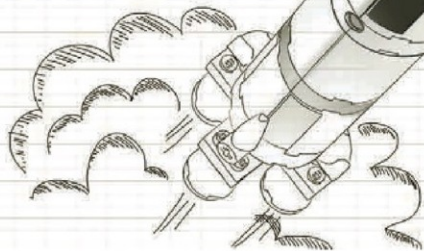



# DESIGNING A CONCEPT!

Every LEGO® model begins as an idea, including the **THREE SPACESHIP MODELS** in this Handbook. But how does an idea take shape? Master Builders think about what kind of functions a model will have, how to make it stable, and how it should look. You can create your own LEGO model concept by thinking like a Master Builder! Planning out your model before building it will help you build anything you can imagine!

HERE ARE SOME TOOLS TO HELP YOU  
SKETCH OUT YOUR MODEL IDEAS!



## SKETCHING PENCILS

Pencils are essential! #2 pencils or a mechanical pencil work best!



## SQUARES & TRIANGLES

To draw squares, use a ruler to measure and mark four sides. Make sure they are all equal! Fold any square in half to make two perfect triangles!



## CIRCLES

Make circle stencils by tracing objects like cups or coins onto thick paper, then cut those shapes out to save and trace anytime.



## COLORS

Once you have your outline drawn, start adding color with colored pencils or markers!

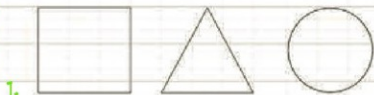

1.

Start by sketching simple shapes like rectangles, triangles and circles. The best way to make sure your model concept is in "LEGO brick scale" is to draw it on official LEGO® graph paper (SEE PAGE 83).

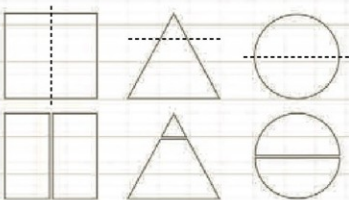

2.

Now you can modify the simple shapes to match the pieces of your model. A square cut in half becomes two rectangles, a triangle with the top off is now a trapezoid, and a circle cut in half makes two half-circles.

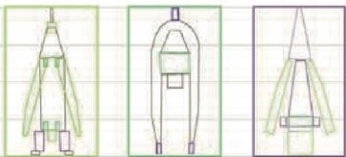

3.

Next, combine those shapes in different ways to create a basic outline of your model. Here are some examples of spaceships that can be made by mixing simple shapes together.

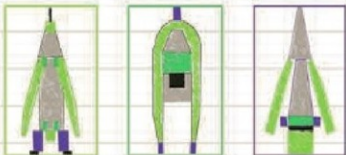

4.

Create a color scheme! Once you know what colors you'd like to use for each section of your model, you'll be able to pick out the right shapes, sizes and combinations of pieces from your LEGO brick collection before you build.

# HOW TO SKETCH A CONCEPT FOR THE ROCKET MODEL IN THIS HANDBOOK!

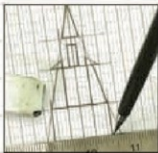

## DRAWING SHAPES

To draw simple shapes, you can use the templates on the left or create your own stencils by tracing the outline of things around your house onto thick paper.



## DETAILING YOUR SKETCH

Add lots of shapes and details to your sketch with your templates and stencils. Then draw your whole design onto LEGO brick paper.



## TIPS FOR USING COLOR

A neutral color like white or grey is a good choice for the main body of a spaceship. Bold colors, like the bright green pieces in your Space Designer kit, can create a streamlined look when used on all of the large parts. Accent colors like dark green, purple and silver add color-contrasting details to both sides.



## COMPARE BRICK SHAPES

Now build your detailed design! Just match your shapes and colors to pieces in your LEGO brick collection to create your concept.



## COMPLETE MODEL

Designing is fun and easy when you break the process into simple steps like the ones above. Creating your own concepts – from sketching an idea to building it – will get even easier and more fun every time you practice!

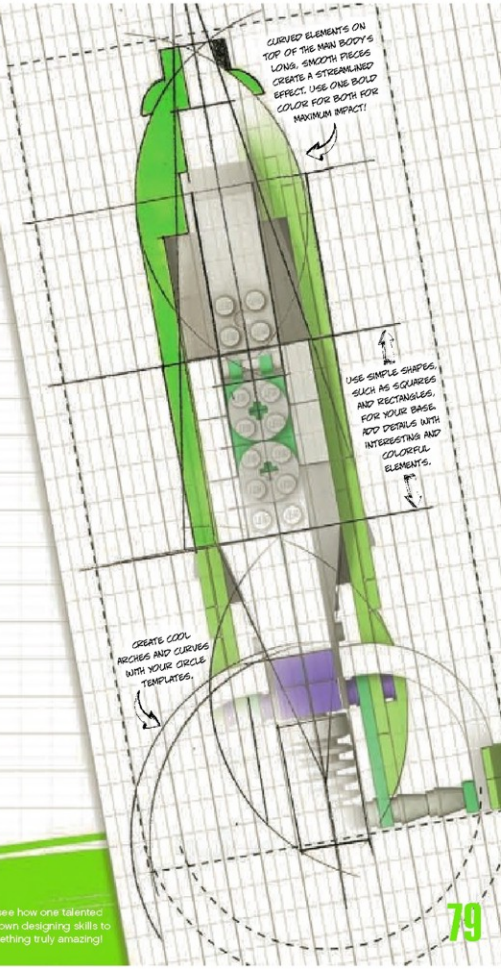

**NEED SOME INSPIRATION?**

Turn the page to see how one talented LEGO fan put his own designing skills to use and built something truly amazing!

A LEGO® Fan Creation!

# BUILDING GIANT SPACE MODELS

WITH ENOUGH BRICKS AND IMAGINATION,  
YOU CAN BUILD ANYTHING!

LEGO® fan builder Daniel Rubin is an attorney who works in Washington, DC. He got his first LEGO Space set when he was four years old, and except for a break during high school and college, he's been building ever since. Here's how he built his amazing and humongous Eb/Cafl spaceship!

"I primarily build space ships, and I like mixing smooth armored shells with complex greebles.\* I also love to play with color and to try different combinations of the colors available in the LEGO palette.\*\* I like working with tan, so many of my models are space ships with tan armor shapes over dark gray spindles and functional-looking bits."

-Dan Rubin



\*GREEBLES ARE SMALL ELEMENTS THAT MAKE A SPACESHIP'S SURFACE LOOK DETAILED AND MULTI-LAYERED!

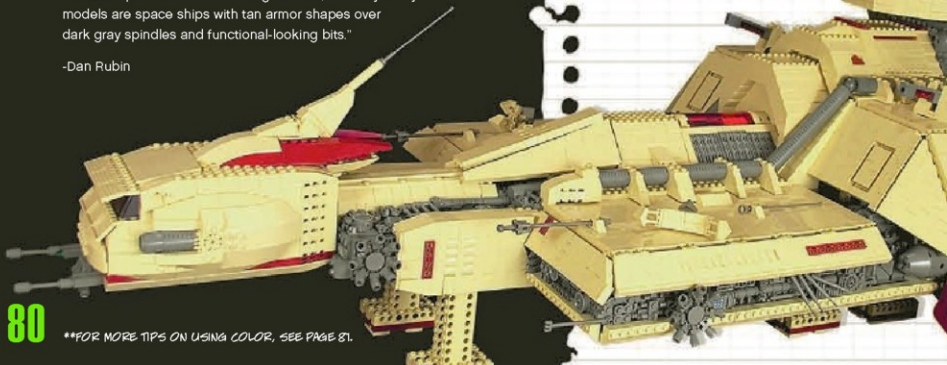



01.



02.



03.



04.



05.



## CONSTRUCTING THE EB'CAF!

"While I was working on this ship, I decided that I didn't want it to be a human ship, but alien. I then spent a lot of time trying to think of a name that sounded alien and mysterious. Eventually, I came up with the name EbCaf!, which came from the RGB number for the LEGO tan color (E8CFA1), which is the primary color of this ship."

01.

"When building on a large scale, it's especially important to plan ahead. I find that a skeleton built from LEGO Technic pieces is a good idea. This meant that I needed to have an idea of what I wanted the basic shape of the ship to be in the end, and where the heaviest parts would be. I knew that I wanted to have big engines sticking out on each side. That's why I put extra feet towards the back, in order to hold the weight of the engines and keep it from tipping backwards."

02.

"Because the basic design I wanted for this ship was symmetrical, I started by concentrating on only one side. This way, I was able to figure out any problems that arose once, and then copy them to the other side."

03.

"It's a lot more fun to build a space ship that can be played with than a decorative model. I built the doors on the back so that astronauts or vehicles could be loaded in and out of the bay. You can also see a turret that can be rotated and elevated. As I progressed further in building this ship, I decided that this turret design was too long and too flat to fit with the aesthetic of the rest of the ship."

04.

"By placing the different panels of the ship's 'skin' on hinges, I was able to achieve various different angles. I did not use click hinges, only the kind that can be adjusted to any angle. That way, I could adjust the angles of the panels to form corners that fit with the angles offered by LEGO slope bricks."

05.

"Here, the ship is nearly complete...or so I thought. Look at the cabin at the front: it's too small. This illustrates how important it is to step back periodically when working on a large project. It is too easy to get wrapped up in the details you're working on, without looking at whole picture."

## SPACE DESIGNER ELEMENTS!

OFFICIAL BRICK SEPARATOR  
FOR TAKING APART MODELS,  
JUST LIKE THE LEGO MASTER  
BUILDERS USE!

2x  
2357011x  
41601243x  
3023012x  
44217156x  
45379281x  
42113851x  
6007283x  
3030012x  
42619934x  
3022016x  
45293514x  
45379272x  
42114361x  
41077364x  
4070012x  
42619932x  
3623014x  
40490392x  
49372512x  
42114524x  
31023282x  
3700011x  
41440124x  
3020012x  
42840476x  
41640372x  
42113502x  
41077581x  
4118714x  
45474891x  
93364x  
45675092x  
42102702x  
42827402x  
3666281x  
41603252x  
46132561x  
3003263x  
4225426x  
41640212x  
42114752x  
3794281x  
41603431x  
2412014x  
41604496x  
45665222x  
41677432x  
42991192x  
3794281x  
41603432x  
45043822x  
41629822x  
42124542x  
45291602x  
42110122x  
42124713x  
41739431x  
42089872x  
3023263x  
45043722x  
42102121x  
42110931x  
45561594x  
45071662x  
42090056x  
740114x  
45403951x  
46320501x  
42111891x  
45219311x  
41608011x  
42090051x  
45226534x  
42124481x  
46320691x  
42104691x  
4588530

**OFFICIAL LEGO® BRICK PAPER**

Each line in this Brick Paper is the height of a LEGO® plate, and 3 plates stacked are the height of a LEGO brick. Make photocopies of this page (instead of drawing on it) so you can create lots of different model sketches. You can also print out LEGO Brick Paper at [www.LEGOmba.com](http://www.LEGOmba.com)

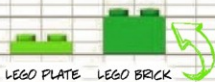



**LEGO**mba.com