



3366





1

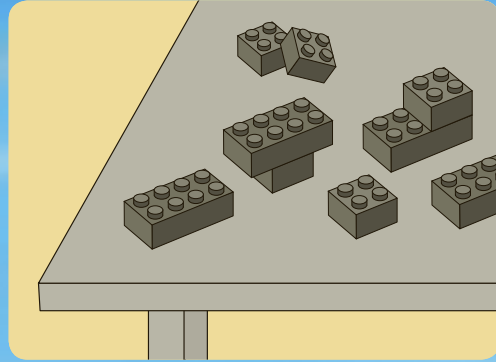
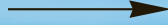

2



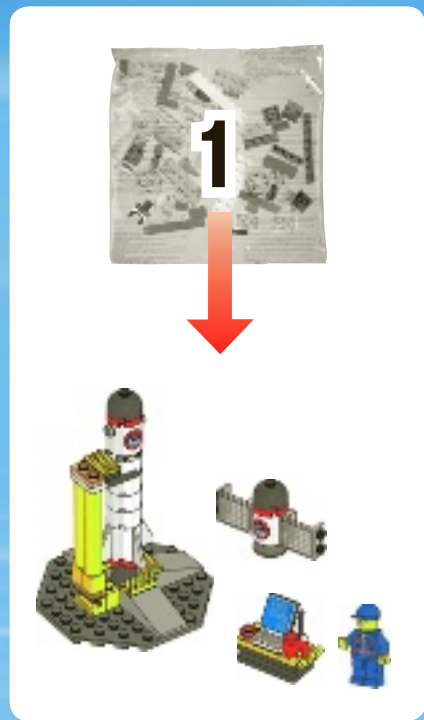



1

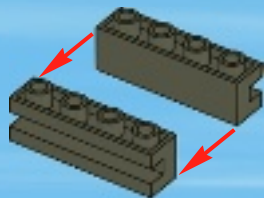

2

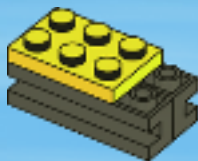

3



4



5

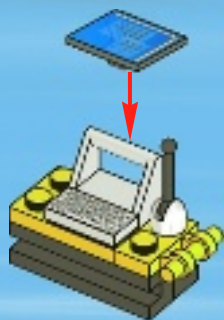

6





1

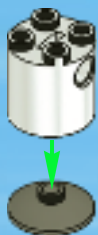

2



3





4

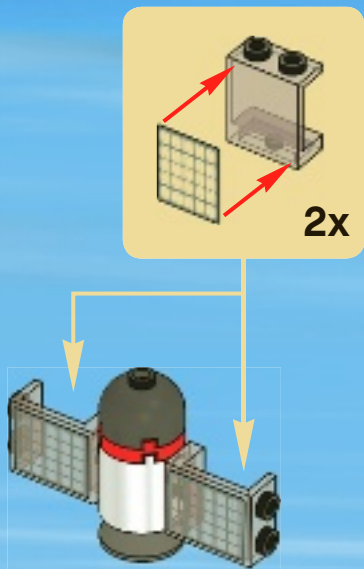

5

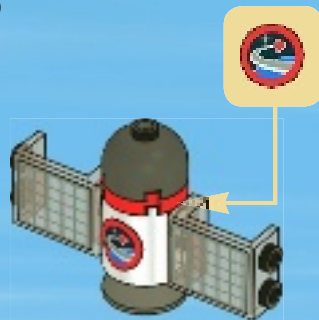





1



2



3



4



5

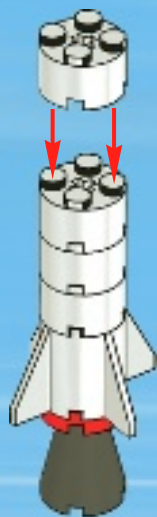

6



7

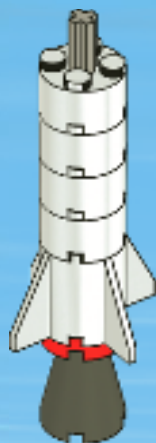

1



2



3



4



8





1



2

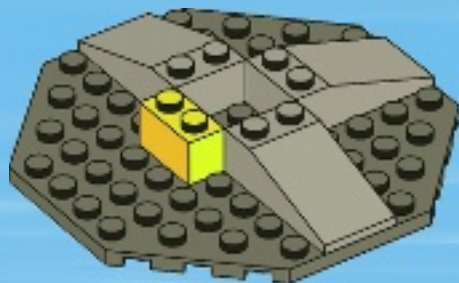

3

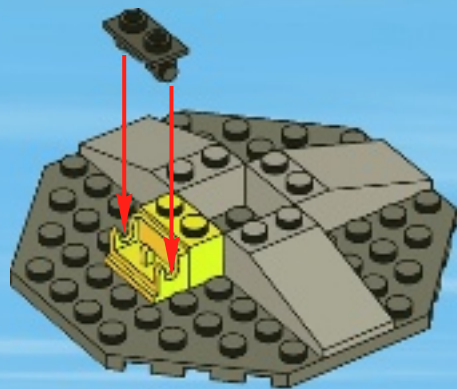

4

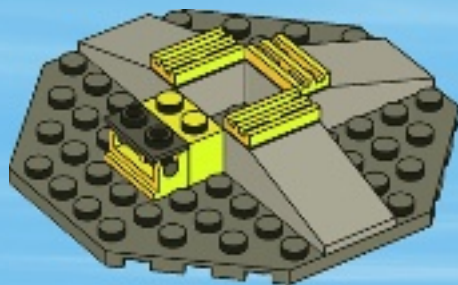

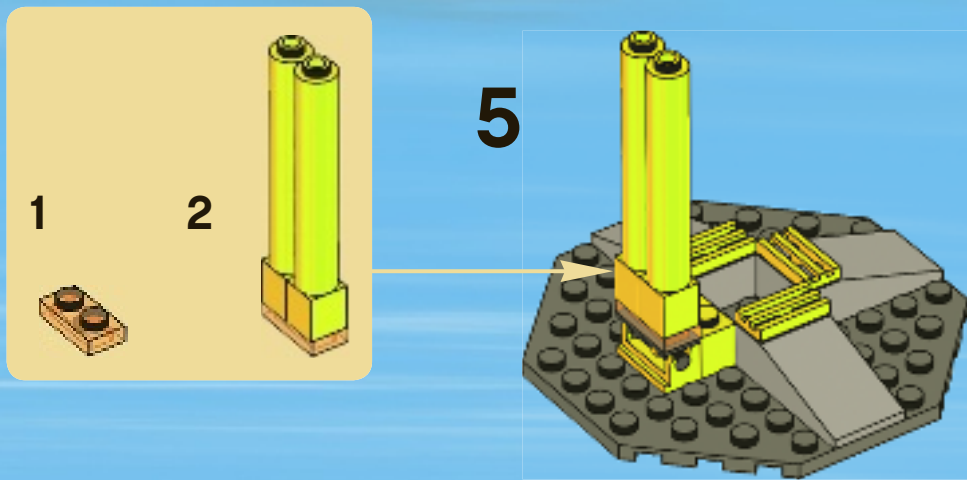

1



2



3



6

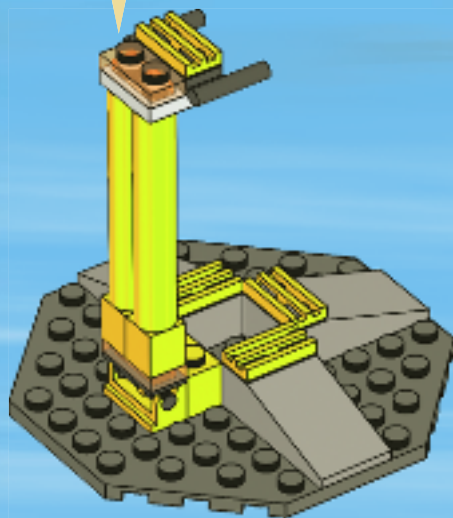



7

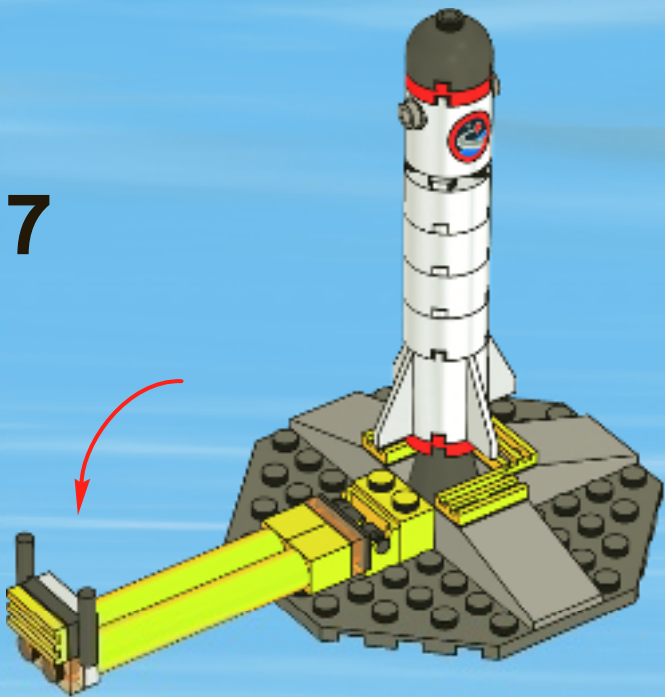

16

8

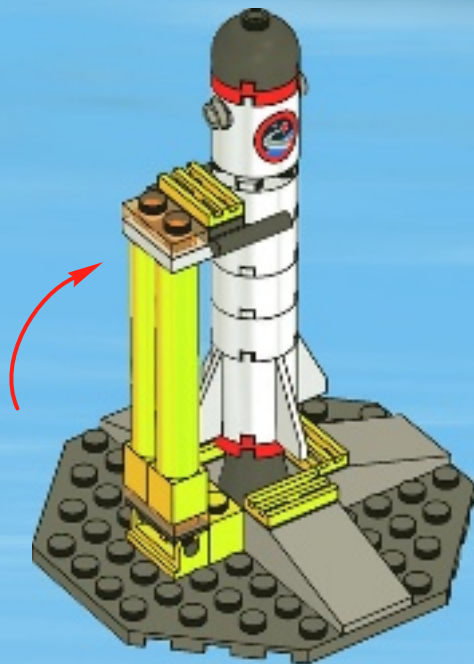

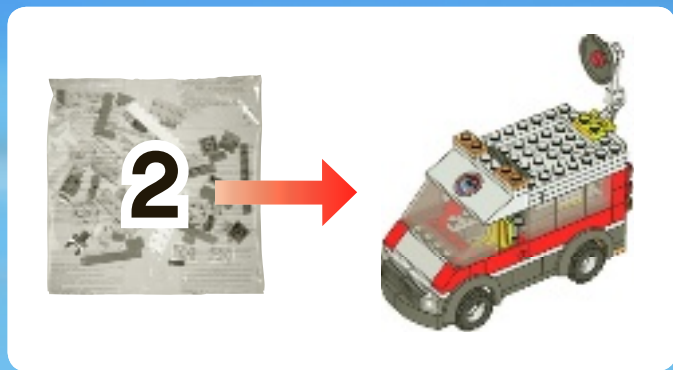

1

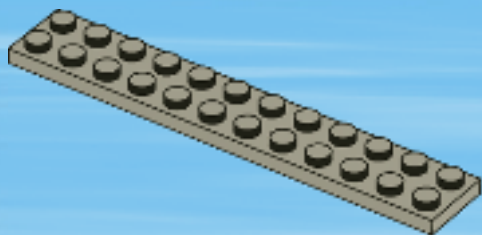

2

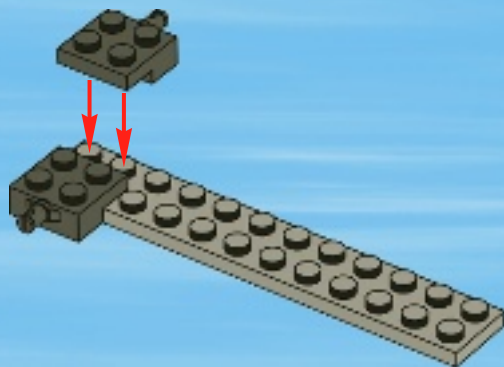

3



4

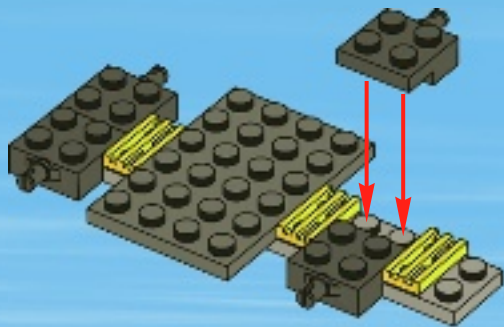

1

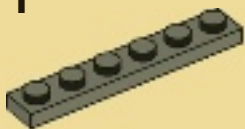

2

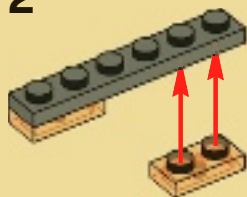

5

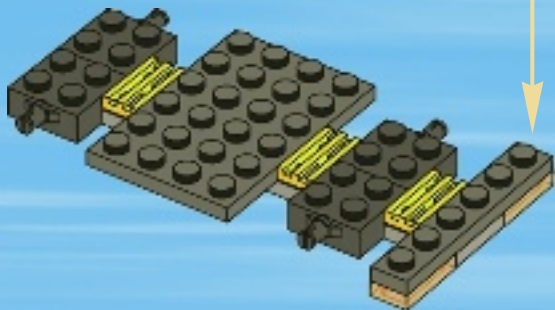

6

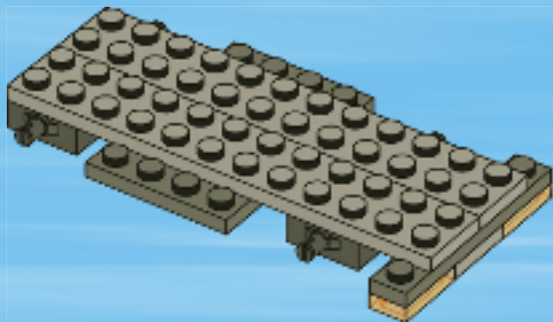

7

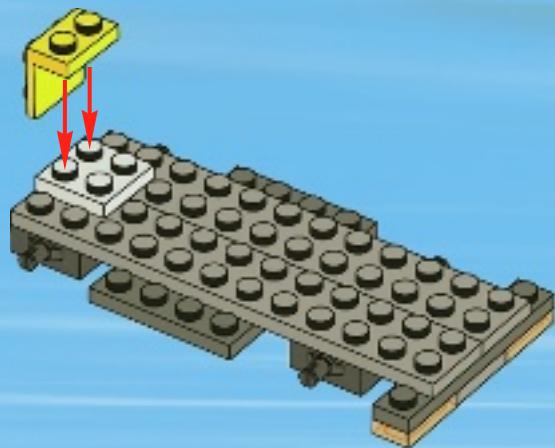

8

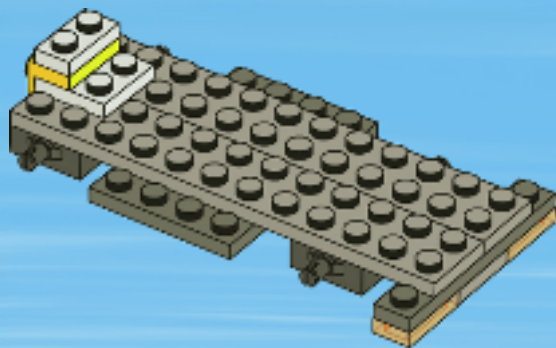

9

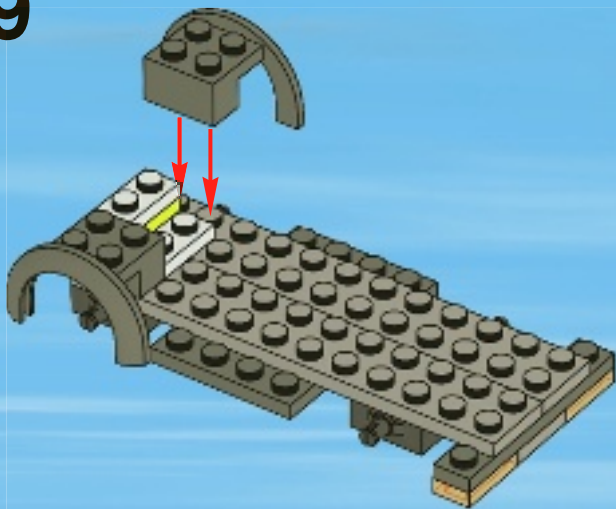

10

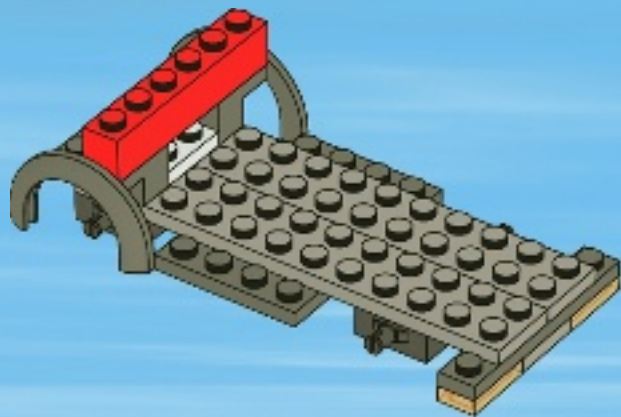

1

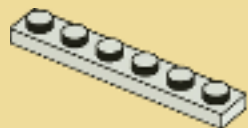

2

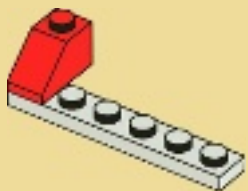

3

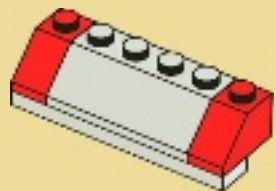

11

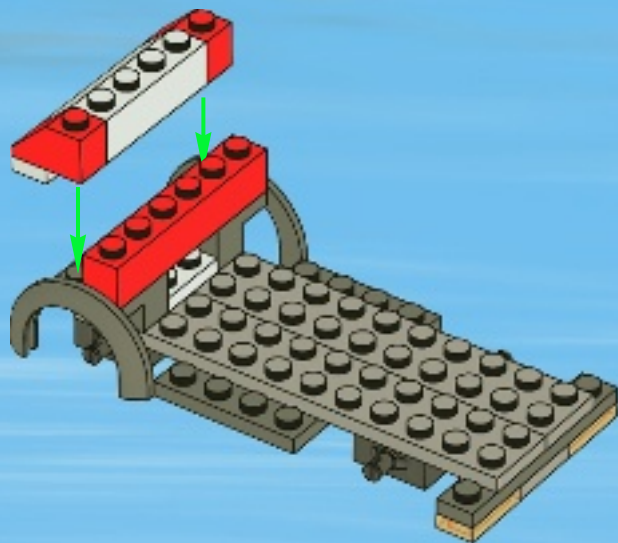



12

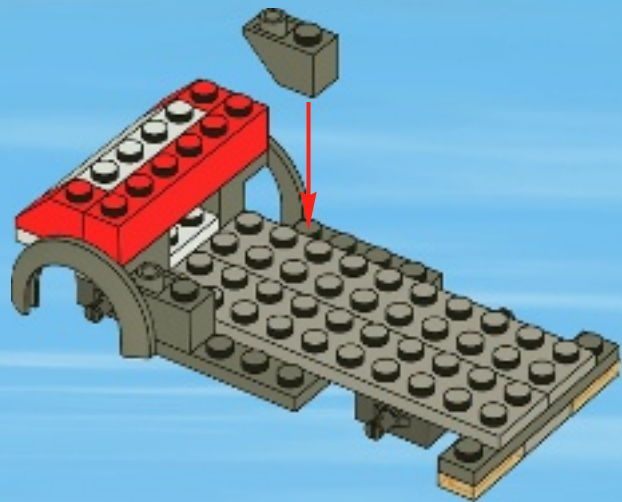

13

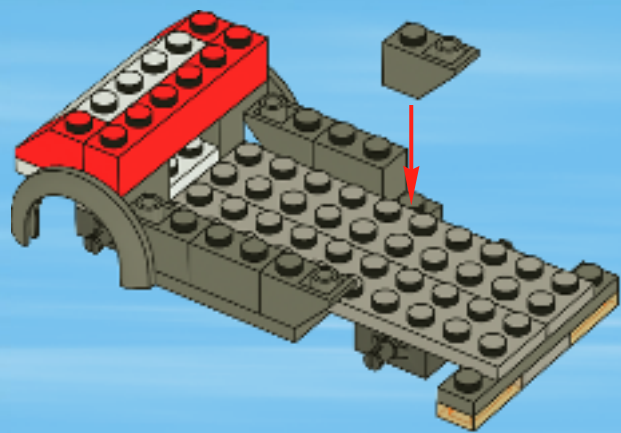

14

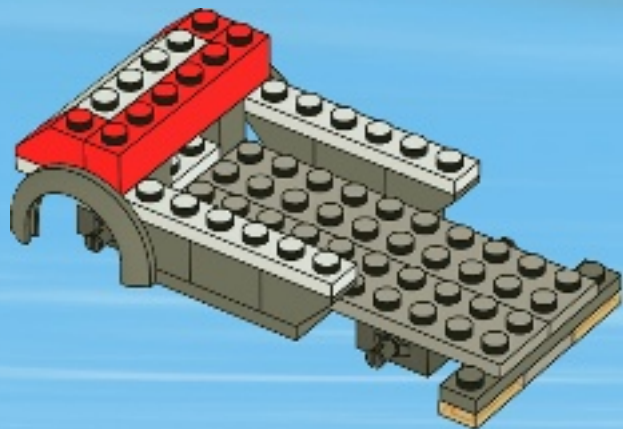

15

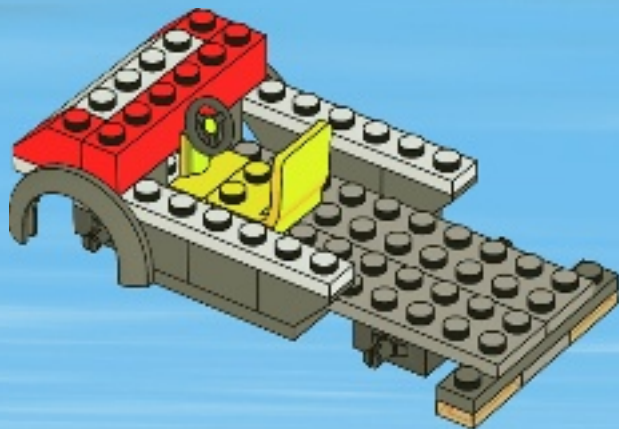

16

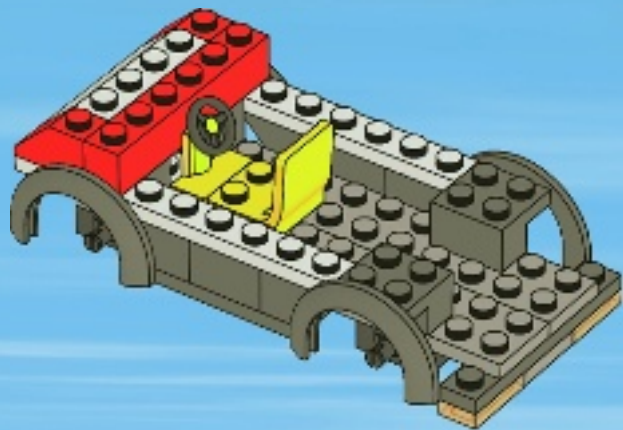

17

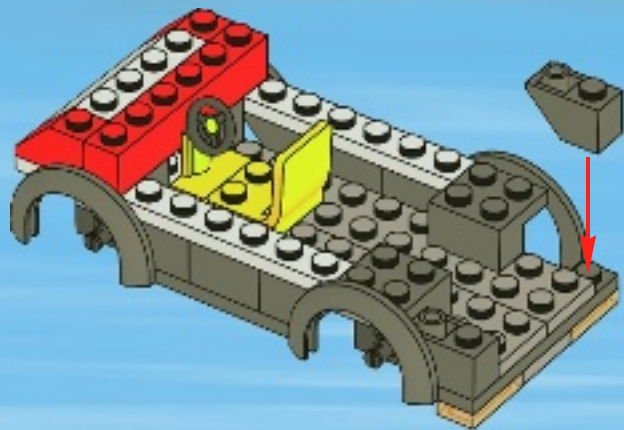

18

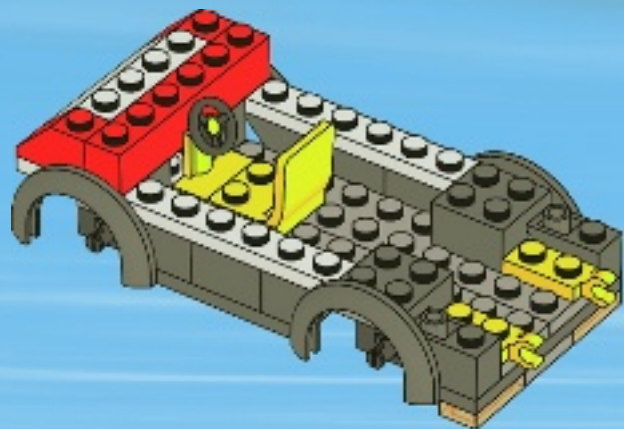

19

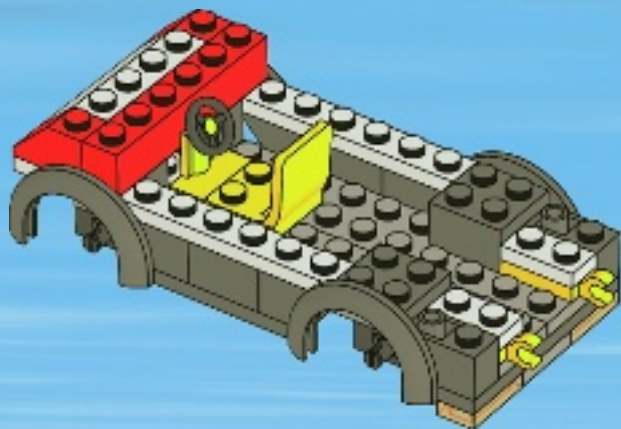

20

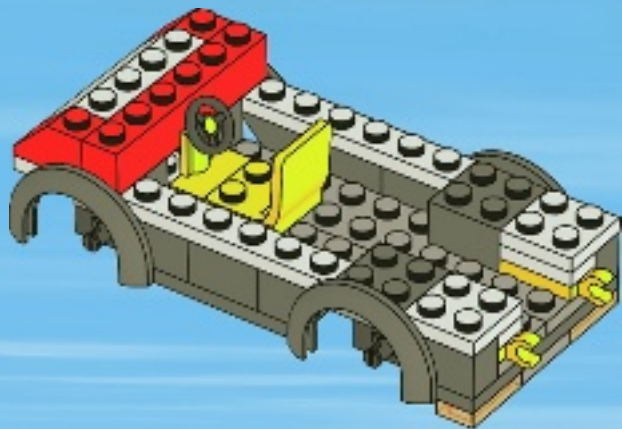

21

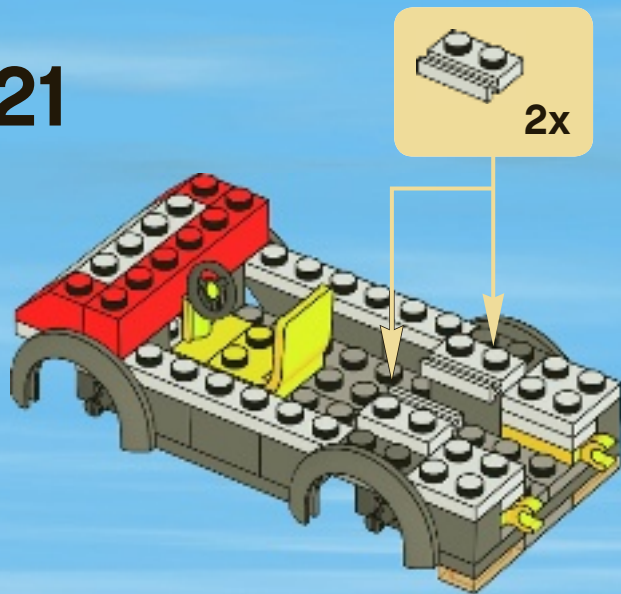



1

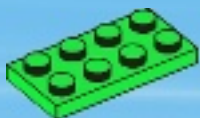

2

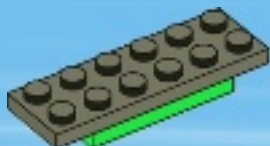

3



4

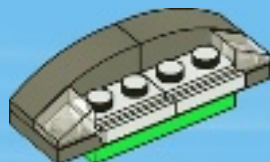



5

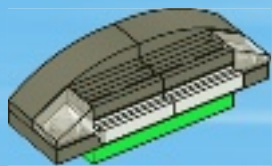

22

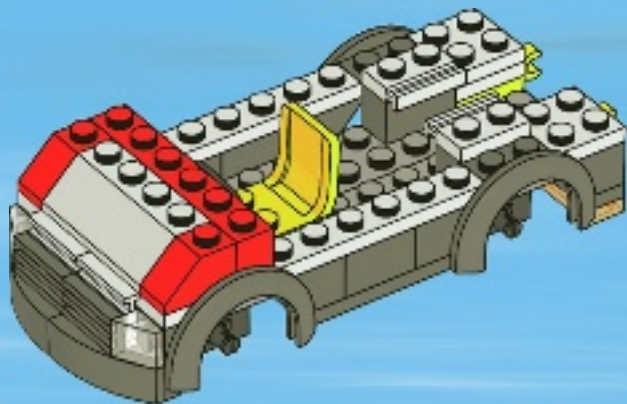



23

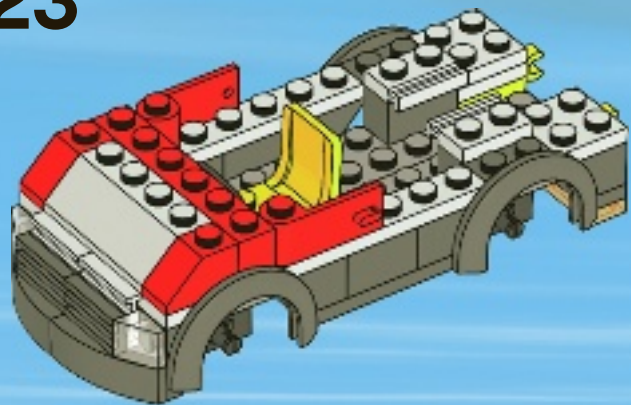

24

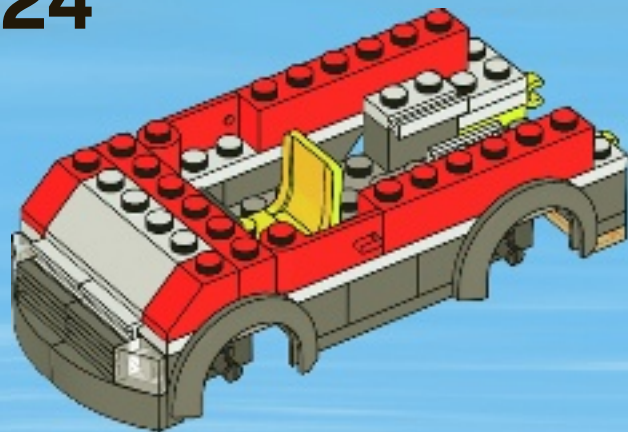

25

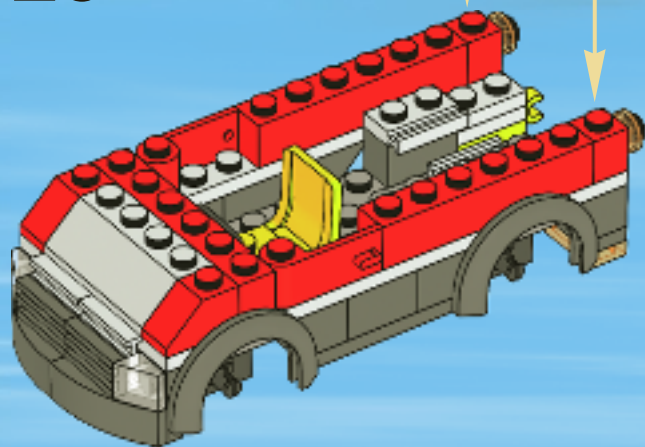

26

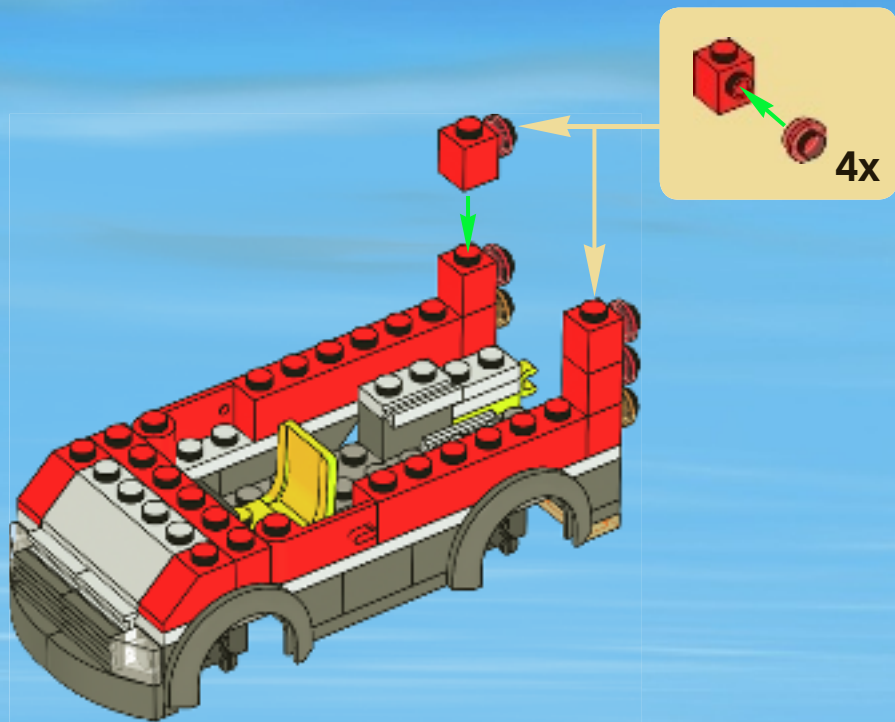

27

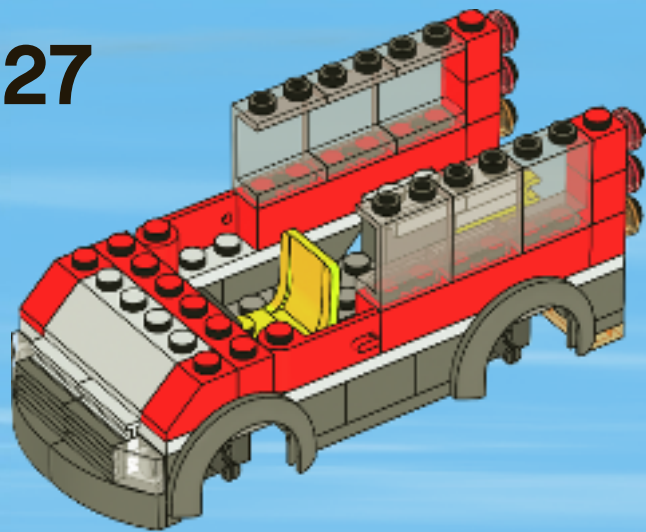

28

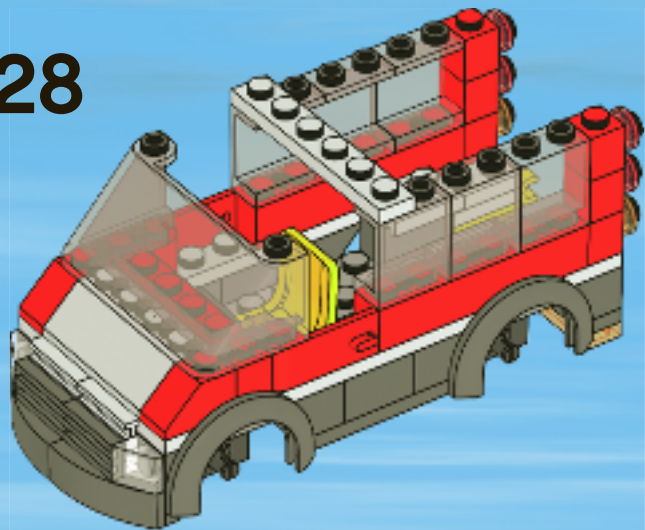

29

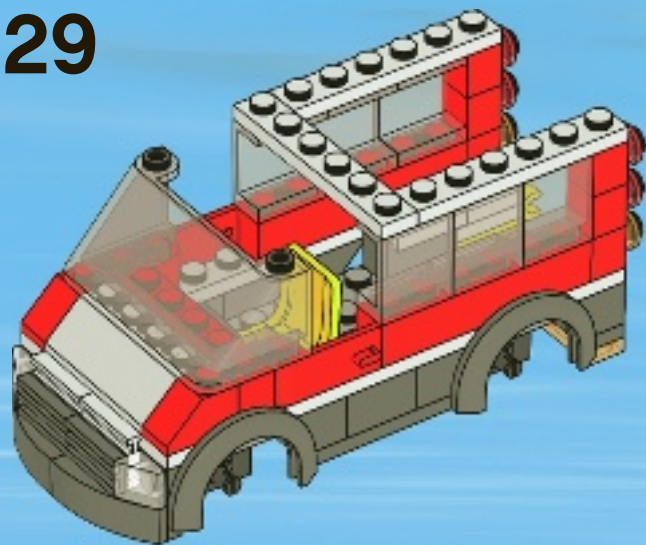

30

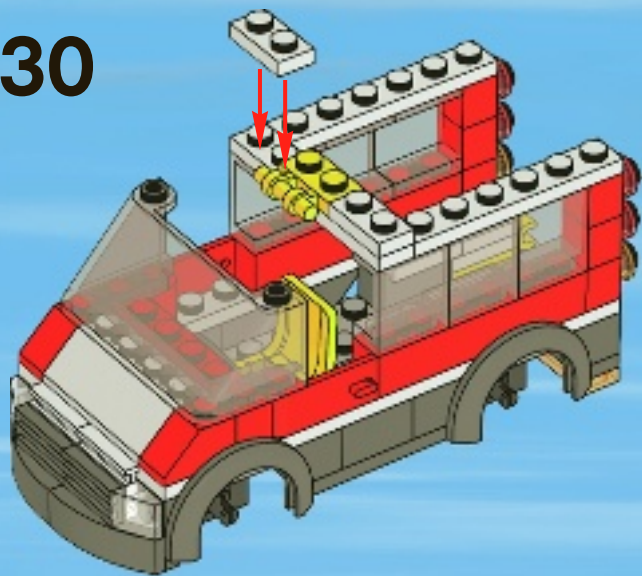

31

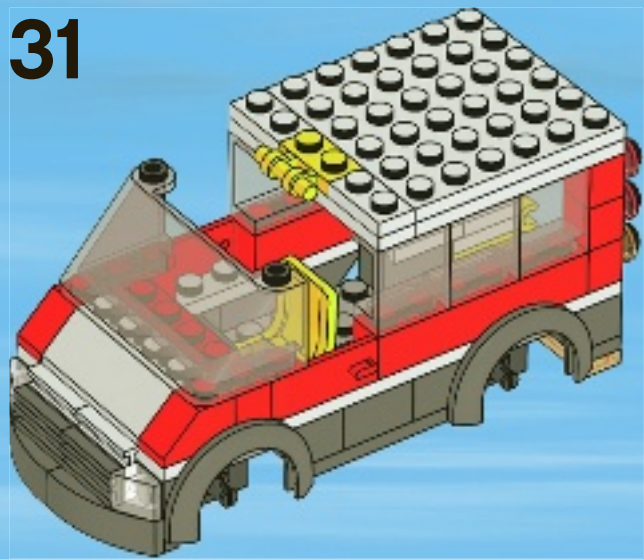



32

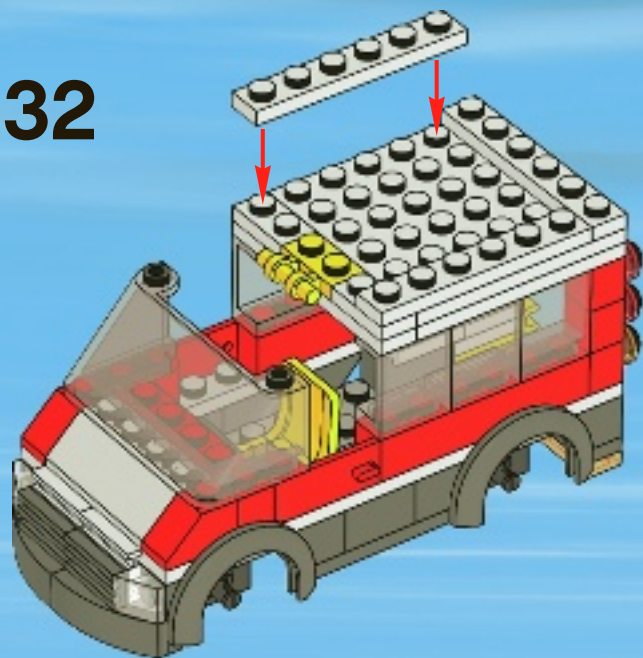

33





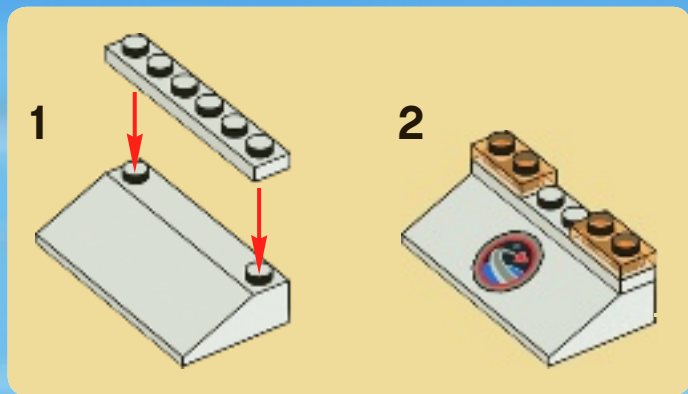

34

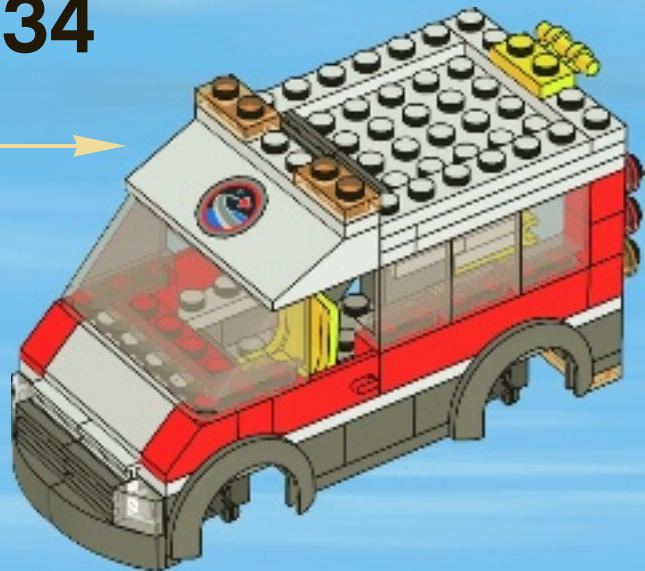

1

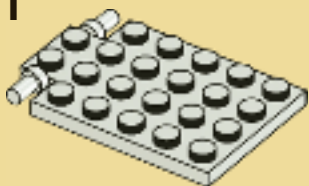

2



3



35

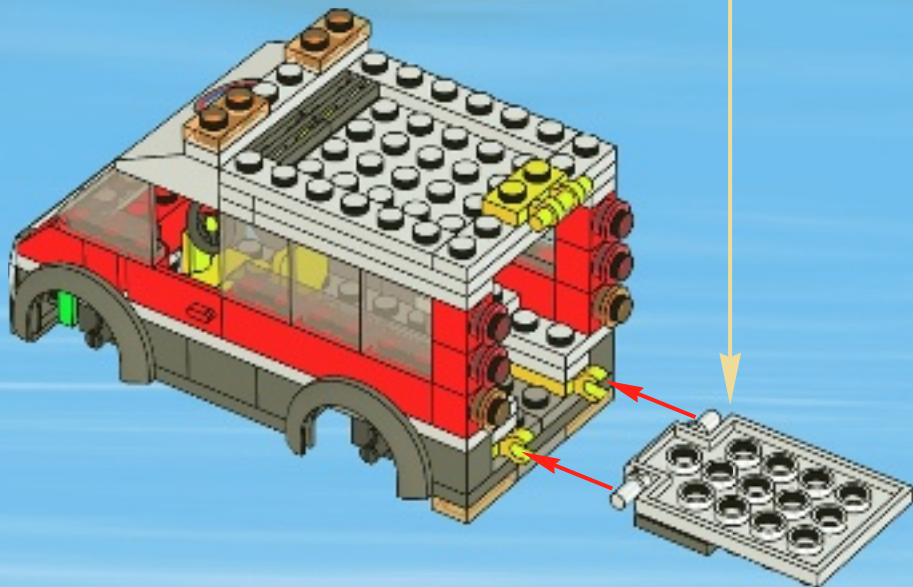

1

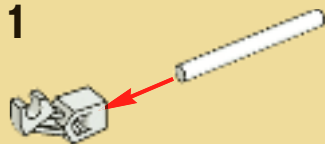

2

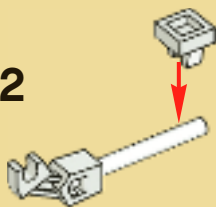

3

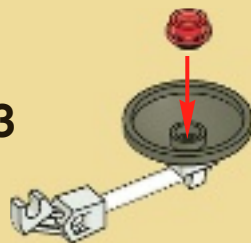

36

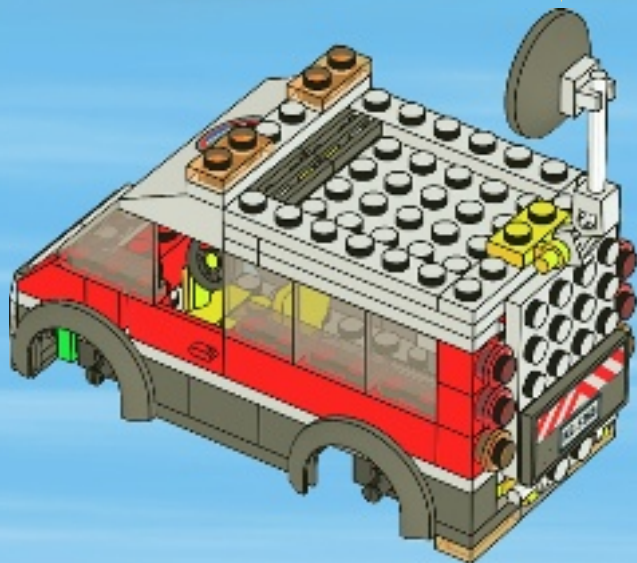

37



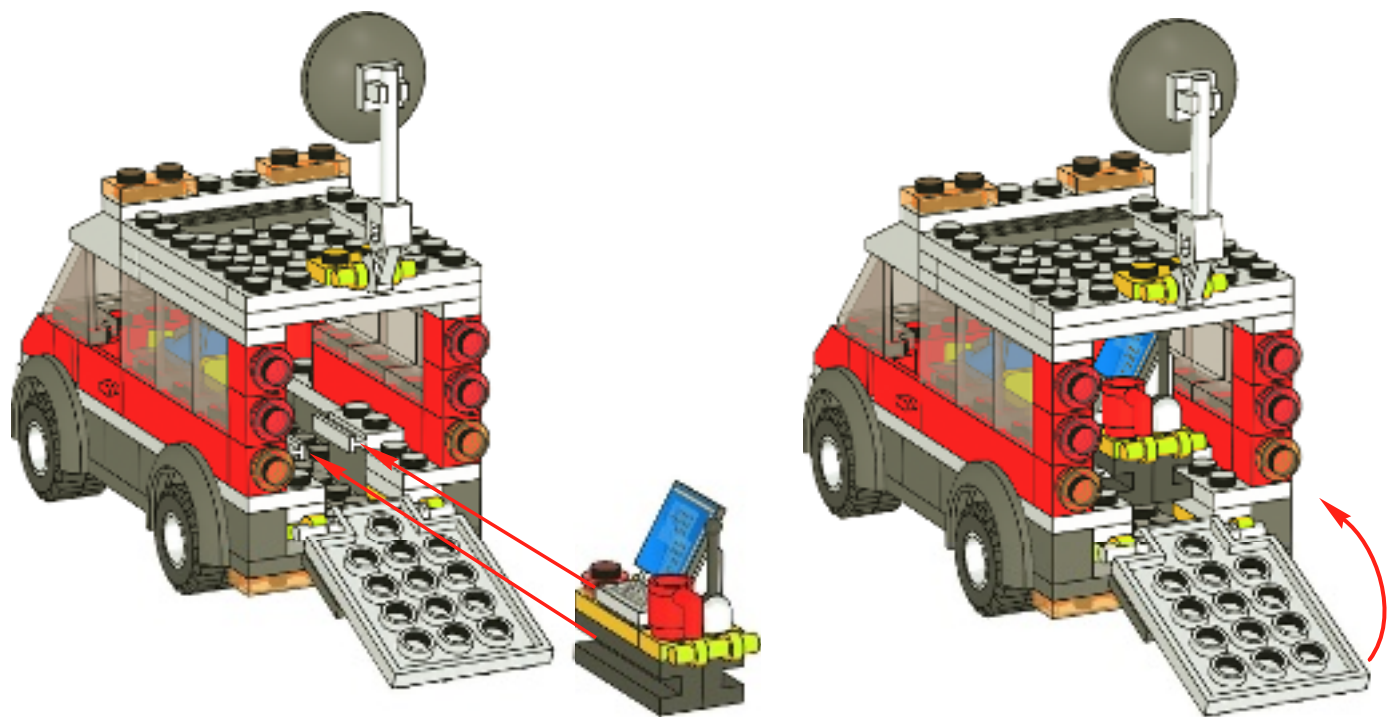



The LEGO logo is displayed in its characteristic white font with a black outline, set against a red rectangular background.The word "CITY" is written in a large, light blue, sans-serif font, positioned to the right of the LEGO logo.

**438 days was the longest duration for a single human space mission.**

Die längste Weltraummission einer einzelnen Person dauerte 438 Tage.

La mission spatiale humaine la plus longue en un seul vol a été de 438 jours.

La misión espacial más larga en la que han intervenido seres humanos duró 438 días.

438 dias foi a estadia mais longa de uma missão espacial de um só ser humano.

Az egy küldetés során az űrben megszakítás nélkül eltöltött leghosszabb idő 438 nap.

**NASA Astronaut**



**The Hubble Space Telescope is almost the size of a school bus and can fit inside a Space Shuttle payload bay.**

Das Hubble-Weltraumteleskop ist fast so groß wie ein Schulbus, aber es passt in den Laderaum eines Space Shuttles.

Le Télescope Spatial Hubble est presque de la taille d'un bus scolaire et peut être placé dans la soute d'une navette spatiale.

El Telescopio Espacial Hubble tiene casi el tamaño de un autobús escolar y cabe dentro de la bodega de carga de una lanzadera espacial.

O Telescópio Espacial Hubble tem quase o tamanho de um autocarro escolar e cabe dentro do porão de carga de uma vaivém espacial.

A Hubble űrtávcsó majdnem akkora, mint egy iskolabusz, és elfér az űrsikló rakterében.



**NASA Space Shuttle**



The LEGO CITY logo is located in the top left corner. It features the word "LEGO" in its signature yellow font with a black outline, set against a red square background. To the right of this, the word "CITY" is written in a large, white, sans-serif font with a slight shadow effect.The word "CITY" is part of the LEGO CITY branding, positioned to the right of the red LEGO logo square.A LEGO astronaut minifigure is shown in the bottom left corner, facing away from the viewer. It has a white body, a gold helmet, and a white backpack. The minifigure is positioned as if looking out at the planet Mars in the background.

**The size of the ISS  
(International Space Station) is 108 by 74 meters - longer than an  
American Football Field (including end-zones).**

Die internationale Raumstation ISS (International Space Station) ist 108 mal 74 Meter lang und ist somit größer als ein Fußballfeld.

La taille de l'ISS (Station Spatiale Internationale) est de 108 par 74 mètres. Elle est plus longue qu'un terrain de football américain.

La EEI (Estación Espacial Internacional) mide 108 x 74 metros; su longitud supera a la de un campo de fútbol americano (incluyendo los extremos).

O tamanho da ISS (Estação Espacial Internacional) é de 108 por 74 metros, é maior do que um campo de futebol americano (incluindo zonas limítrofes).

A Nemzetközi Űrállomás (ISS) 108 m hosszú és 74 m széles; ez nagyobb, mint egy amerikai futballpálya (az end-zone-akkal együtt).



**The ISS (International Space Station) passes over 90% of the world's population.**

Die internationale Raumstation ISS (International Space Station) fliegt über die Köpfe von 90 % der Erdbevölkerung.

L'ISS (station spatiale internationale) survole plus de 90 % de la population mondiale.

La EEI (Estación Espacial Internacional) sobrevuela al 90% de la población mundial.

A ISS (Estação Espacial Internacional) passa sobre cerca de 90% da população mundial.

A Nemzetközi Űrállomás (ISS) a világ lakosságának 90 %-a fölött elhalad.

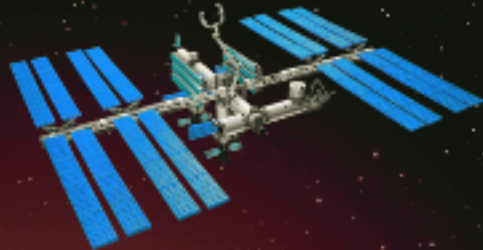

**ISS • International Space Station**



The LEGO logo is displayed in its characteristic white font with a black outline, set against a red rectangular background.The word "CITY" is written in a large, stylized, metallic blue font with a slight 3D effect.

**The Hubble Space Telescope  
orbits 353 miles above the surface of the Earth.**

Das Hubble-Weltraumteleskop kreist in etwa 569 km Höhe über der Erdoberfläche.

Le Télescope Spatial Hubble orbite à environ 569 km de la surface de la Terre.

El Telescopio Espacial Hubble orbita a 569 kilómetros sobre la superficie de la tierra.

O Telescópio Espacial Hubble orbita 569 km (353 milhas) acima da superfície da Terra.

A Hubble távcső 569 km (353 mérföld) magasan kering a Föld fölött.

**NASA Hubble Space Telescope**



**If you could see as well as the Wide Field and Planetary Camera on the Hubble Space Telescope, you would be able to read the fine print on a newspaper one mile away.**

Wenn du so gut sehen könntest wie die „Wide Field and Planetary Camera“ auf dem Hubble-Weltraumteleskop, könntest du aus über einem Kilometer Entfernung das Kleingedruckte in einer Zeitung lesen.

Si vous pouviez voir aussi bien que le champ large et la caméra planétaire du Télescope Spatial Hubble, vous seriez capable de lire les petits caractères d'un journal à une distance de 1,6 km.

Si tu agudeza visual fuese equivalente a la de la cámara planetaria y de gran angular con la que cuenta el Telescopio Espacial Hubble, serías capaz de leer la letra pequeña de un periódico a un kilómetro y medio de distancia.

Se conseguíssemos ver tão bem quanto a câmara planetária e grande angular do Telescópio Espacial Hubble, conseguiríamos ler as letras mais pequenas de um jornal a um quilómetro e meio de distância.

Ha olyan jól látnál, mint a Hubble űrtávcső széles látószögű bolygófényképező kamerája (WFPC), akkor egy mérföldről elolvashatnád az újságban az apró betűs szöveget.



The LEGO CITY logo is positioned in the top left corner. It features the word "LEGO" in its signature white font with a black outline on a red rectangular background, followed by the word "CITY" in a blue, stylized font with a white outline.The word "CITY" is part of the LEGO CITY logo, rendered in a blue, stylized font with a white outline, set against a dark space background with a planet and stars.

**If someone next to you  
shouted in the vacuum of space you wouldn't  
be able to hear them.**

Wenn jemand im luftleeren Weltall neben dir schreien würde, könntest du die Person nicht hören.

Si une personne située à côté de vous dans le vide spatial criait, vous ne pourriez pas l'entendre.

Si alguien gritara junto a ti en el vacío del espacio, no podrías oírle.

Se no espaço alguém, junto a ti, gritasse no vácuo do espaço não o conseguirias ouvir.

Ha valaki elküldtaná magát melletted az üres világűrben, akkor nem hallhatnád meg.

In collaboration with NASA, In Zusammenarbeit mit der NASA,  
En collaboration avec la NASA, En colaboración con la NASA,  
Em colaboração com a NASA, A NASA közreműködésével.

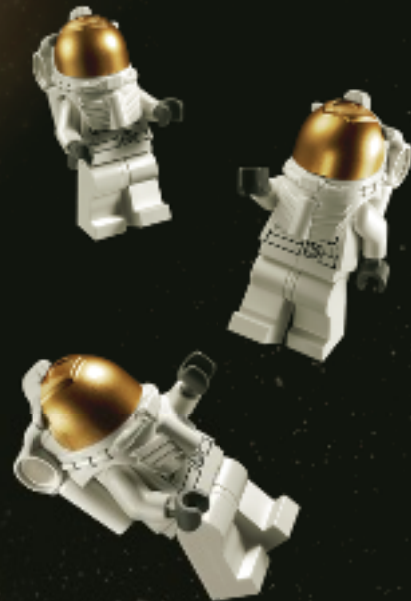





# CITY



3365



3366



3367



3368



# CITY



50

7279



7285



7286



7287



7288



7498



**LEGO**

**CITY**



7942



7239



7207



7208





# CITY



3177



3178



3179



3180



3181



3182



# CREATOR

5766







www.LEGOclub.com



LEGO Club Email



LEGO Club Magazine

**LEGO club**

**FREE! GRATIS! GRATUIT!**

**SIGN UP ONLINE!**

**www.LEGOclub.com**



**00800 5346 5555\***



**1-866-534-6258 • 1-877-518-5346**

US & Canada only

One-time enrollment

- \* Freephone. Mobile charges may apply.
- \* Numéro sans frais. Des frais peuvent s'appliquer avec les téléphones cellulaires.
- \* Gebührenfrei, Kosten für Anrufe aus Mobilfunknetzen können abweichen.
- \* Gratis telefoonnummer vanaf vaste lijn.
- \* Det er et gratis nummer, når du ringer fra fasttelefon.
- \* Det är gratis, när du ringer från en fast telefon.
- \* Numéro sans frais. Des frais peuvent s'appliquer avec les téléphones portables.

- |               |               |               |               |               |               |               |               |               |               |
|---------------|---------------|---------------|---------------|---------------|---------------|---------------|---------------|---------------|---------------|
| 1x<br>4129836 | 1x<br>255501  | 1x<br>394226  | 2x<br>4216660 | 3x<br>4140587 | 1x<br>9553    | 1x<br>389921  | 4x<br>4210631 | 2x<br>4246896 | 6x<br>3005741 |
| 1x<br>4602950 | 4x<br>4249563 | 4x<br>448826  | 1x<br>4609276 | 2x<br>4535740 | 1x<br>4570663 | 6x<br>4558886 | 1x<br>4211010 | 1x<br>4211056 | 8x<br>4189803 |
| 1x<br>243201  | 1x<br>4293350 | 1x<br>383926  | 1x<br>393826  | 1x<br>407924  | 1x<br>4567909 | 2x<br>4121934 | 1x<br>4210865 | 1x<br>4211002 | 6x<br>4280341 |
| 1x<br>303701  | 5x<br>302301  | 1x<br>383926  | 1x<br>393826  | 1x<br>393724  | 1x<br>4548877 | 3x<br>403221  | 2x<br>4211088 | 1x<br>4211002 | 2x<br>4222960 |
| 1x<br>4569841 | 4x<br>302201  | 4x<br>4514560 | 4x<br>4514560 | 1x<br>300424  | 1x<br>9341    | 1x<br>4537986 | 6x<br>4211096 | 1x<br>4211115 |               |
| 1x<br>4569841 | 1x<br>4296948 | 2x<br>265326  | 2x<br>265326  | 2x<br>4180814 | 3x<br>4509915 | 1x<br>4288209 | 4x<br>4260124 | 1x<br>4583688 |               |
| 10x<br>366601 | 4x<br>4170457 | 1x<br>302028  | 1x<br>302028  | 2x<br>302124  | 1x<br>4538098 | 3x<br>300921  | 1x<br>4560184 |               |               |
| 1x<br>4144012 | 1x<br>73737   | 2x<br>4244362 | 2x<br>4244362 | 1x<br>302124  | 1x<br>4211639 | 4x<br>4211483 |               |               |               |
| 1x<br>4599044 | 4x<br>614301  | 1x<br>4599456 | 1x<br>4599456 | 7x<br>241224  | 3x<br>4211360 |               |               |               |               |
|               | 2x<br>4194010 |               |               | 1x<br>4277925 |               |               |               |               |               |



**Customer Service**  
**Kundenservice**  
**Service Consommateurs**  
**Servicio Al Consumidor**

[www.lego.com/service](http://www.lego.com/service) or dial

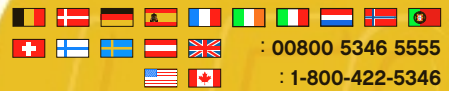

: 00800 5346 5555  
 : 1-800-422-5346



www.LEGO.com

# WIN!

Go to [www.LEGOsurvey.com/product](http://www.LEGOsurvey.com/product) to fill out a survey for a chance to win a cool LEGO® Product.

No purchase necessary.

Open to all residents where not prohibited.



## [www.LEGOsurvey.com/product](http://www.LEGOsurvey.com/product)

### GEWINNE!

Nimm an der Umfrage auf [www.LEGOsurvey.com/product](http://www.LEGOsurvey.com/product) teil und hab die Chance ein cooles LEGO® Produkt zu gewinnen!

Die Teilnahme am Gewinnspiel führt zu keinerlei Kaufverpflichtungen. Teilnahme in allen nicht ausgeschlossenen Ländern möglich.

### WIN!

Ga naar [www.LEGOsurvey.com/product](http://www.LEGOsurvey.com/product), vul een enquêteformulier in en maak kans op een cool LEGO® product.

Geen aankoopverplichting. Iedereen mag deelnemen, uitgezonderd ingezetenden van landen waar een enquêteverbod geldt.

### GAGNE!

Visite [www.LEGOsurvey.com/product](http://www.LEGOsurvey.com/product) pour répondre à un questionnaire et avoir une chance de gagner un produit LEGO® très cool!

Aucune obligation d'achat. Ouvert à tous les résidents des pays autorisés.

### 当てよう!

[www.LEGOsurvey.com/product](http://www.LEGOsurvey.com/product) にアクセスして、アンケートにご記入ください。当選者にはレゴ®製品を差し上げます。

お買い上げの必要はありません。禁止されていない限り、すべての皆様にご利用いただけます。

4625138

LEGO and the LEGO logo are trademarks of the LEGO Group. ©2011 The LEGO Group.