

The LEGO logo is displayed in its characteristic white font with a black outline, set against a red square background.

# Kingdoms

A heraldic crest featuring a red shield with a white diagonal stripe, a golden lion rampant on the red side, and two crossed golden swords behind the shield.

7189



**WARNING:** CHOKING HAZARD.  
Toy contains small parts and a small ball.  
Not for children under 3 years.



**AVERTISSEMENT : RISQUE D'ÉTOUFFEMENT.**

Le jouet contient des petites pièces ainsi qu'une petite boule.  
Il ne convient pas aux enfants de moins de 3 ans.



**ADVERTENCIA: PELIGRO DE ASFIXIA.**

Juguete que contiene partes pequeñas y una pelota pequeña.  
No recomendado para niños menores de 3 años.



1

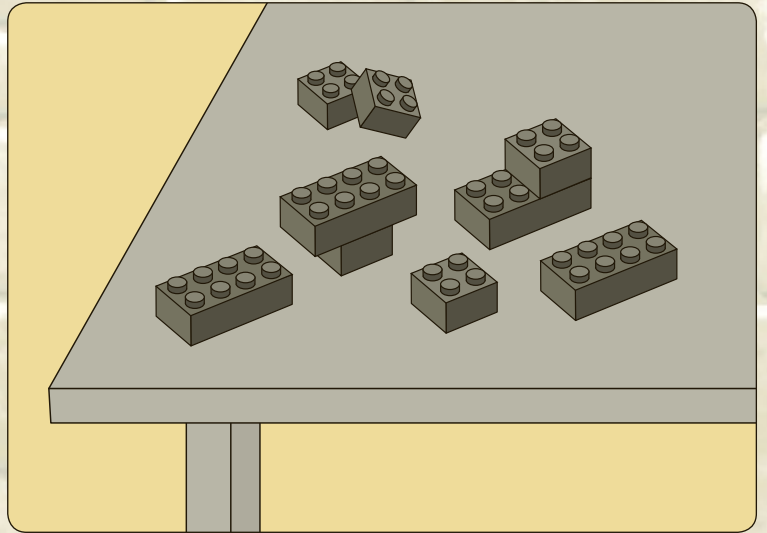
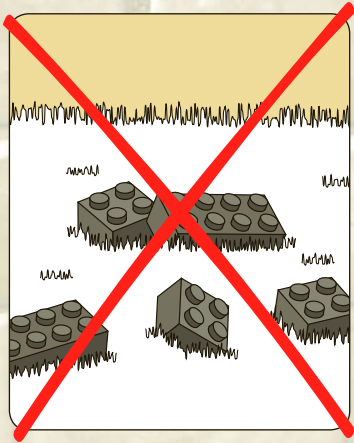

2



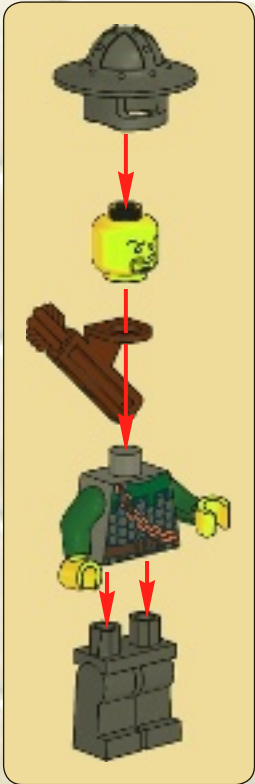



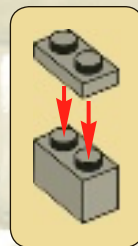

1

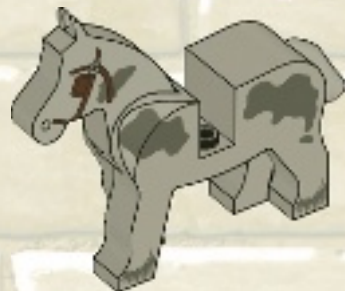

2



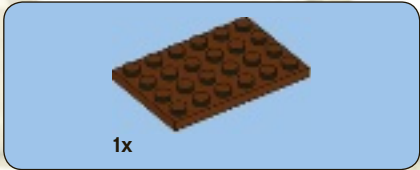

1

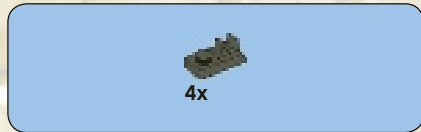

2

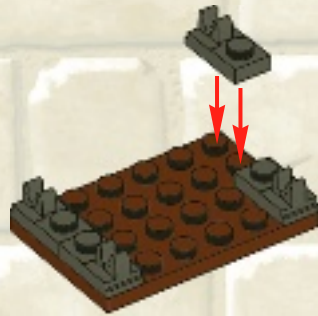





3



4

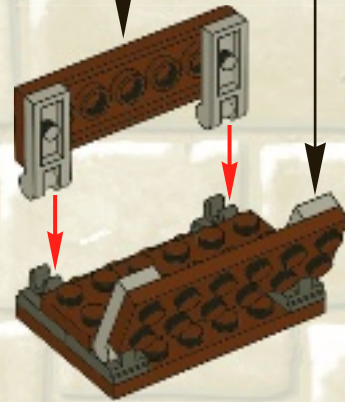
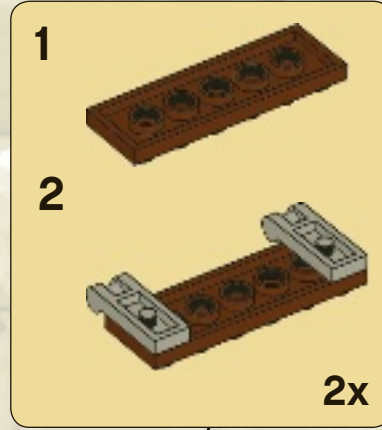

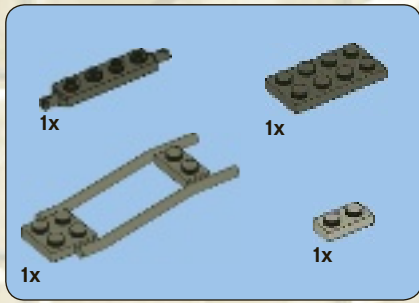

5

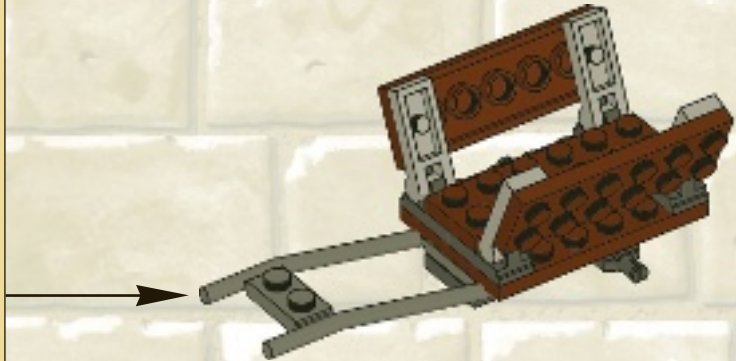
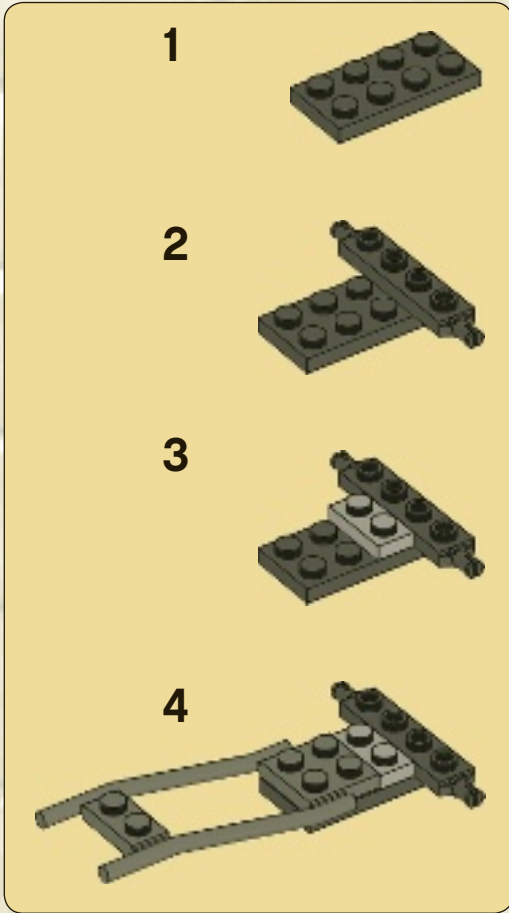





6

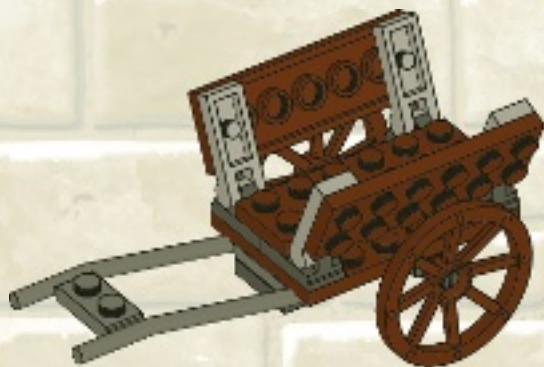

7

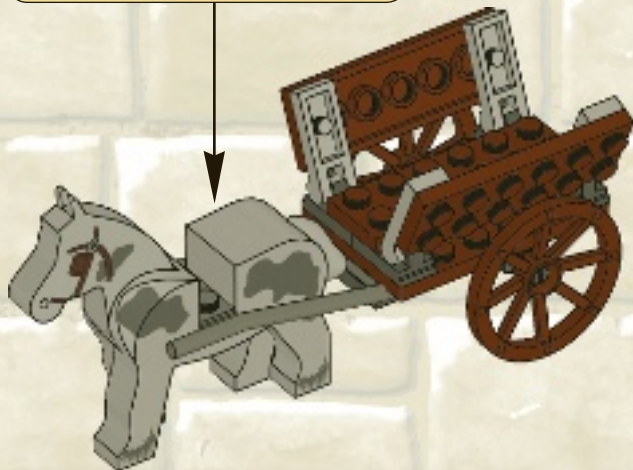
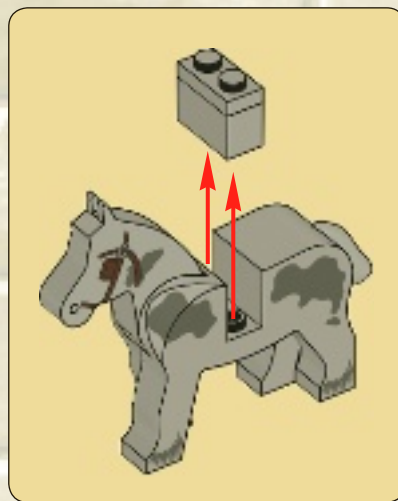

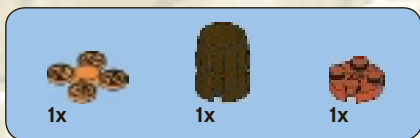

8

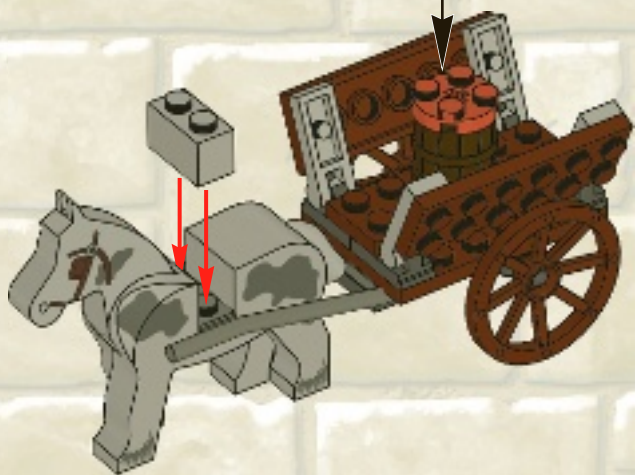
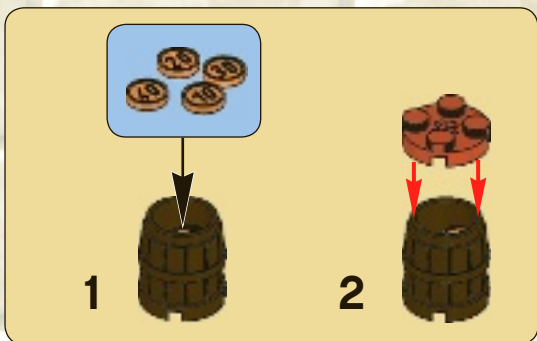

9

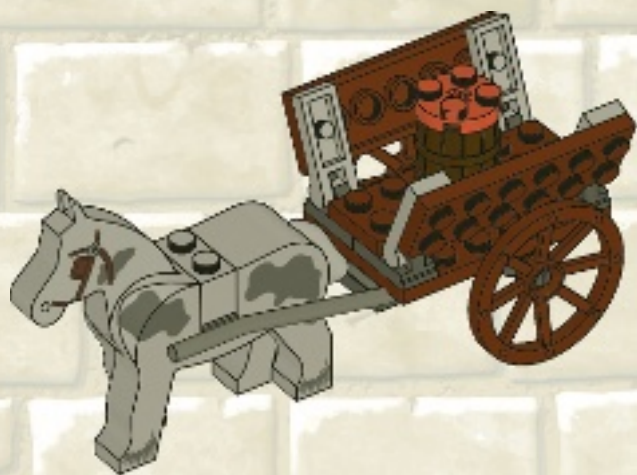



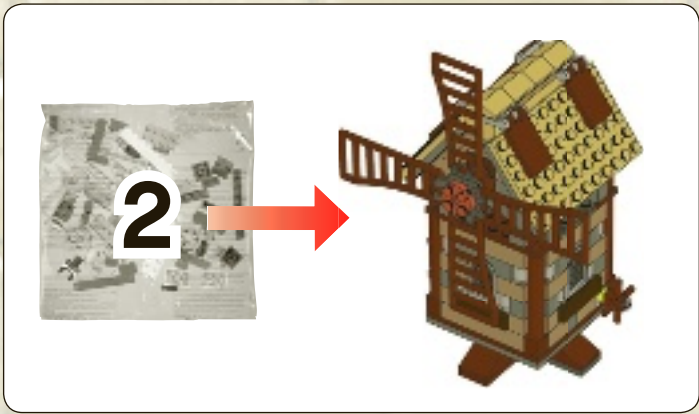

1

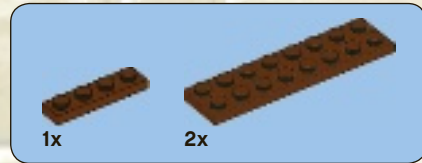

2





1x

3

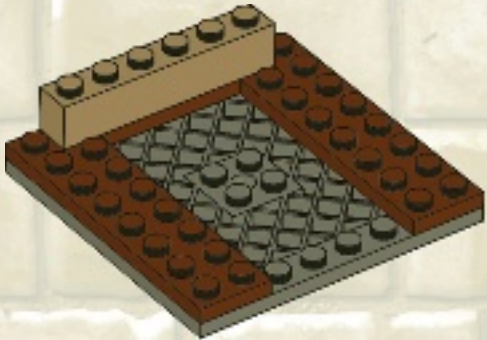

1x



2x

4

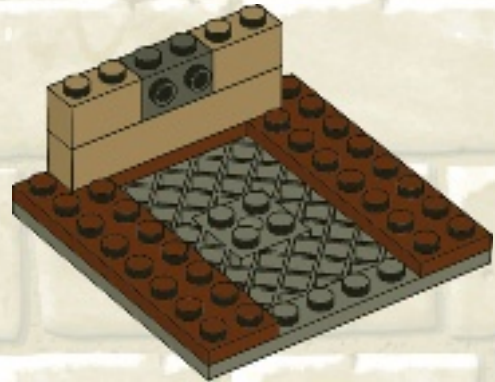





2x



2x

5



1x



1x

6

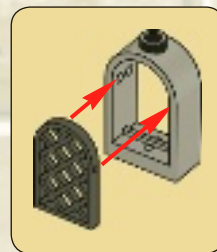



2x

7

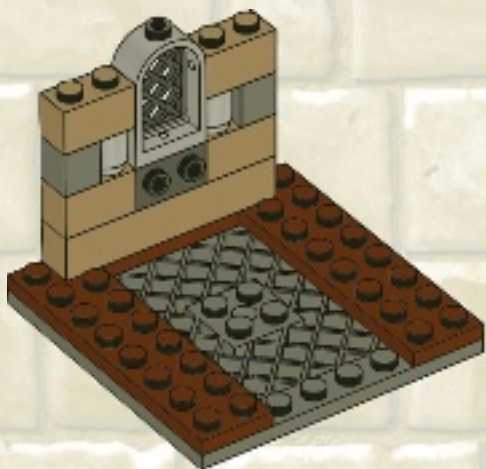

1x



2x

8





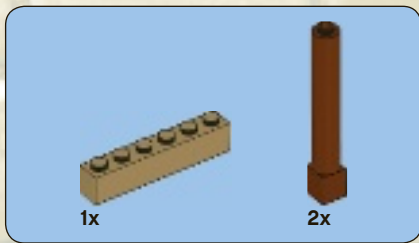

9

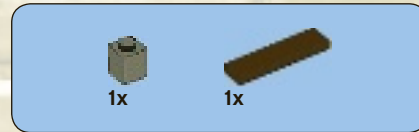

10

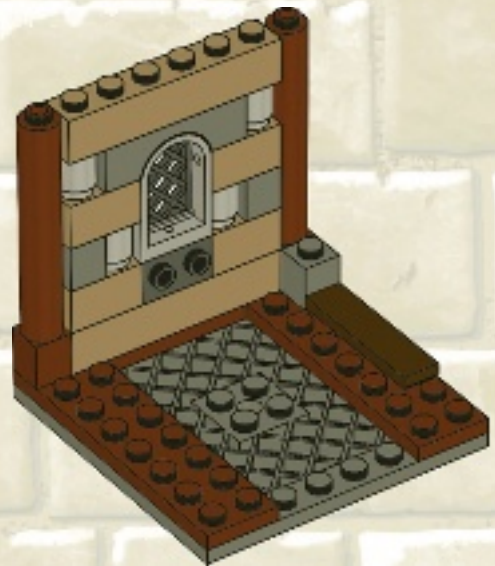



1x



2x

# 11

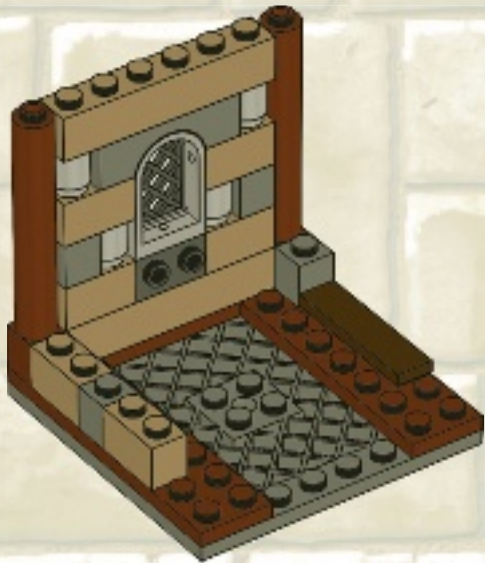

1x



1x



1x



2x

# 12

1



2



3





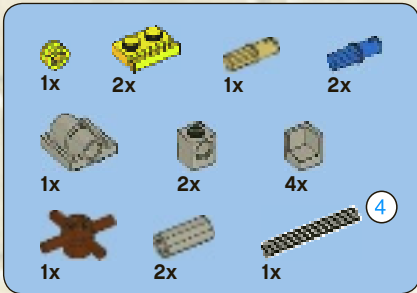
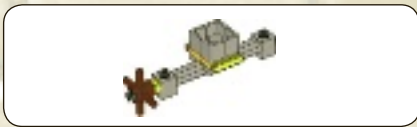

13

1

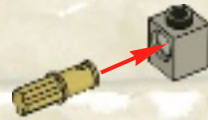

2

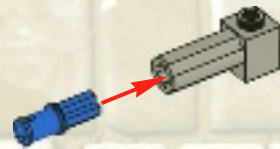

3

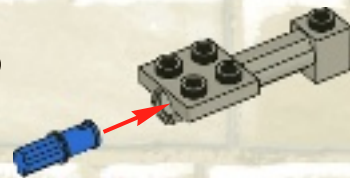

4

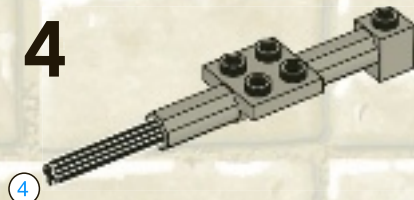

5

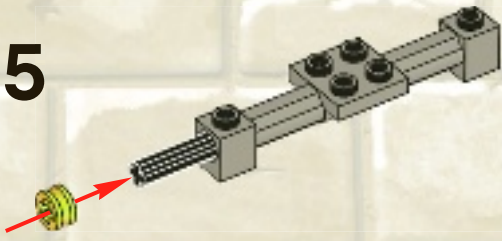

6

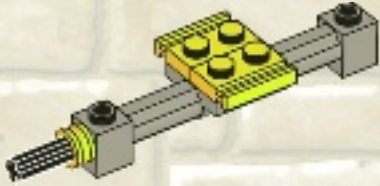

7

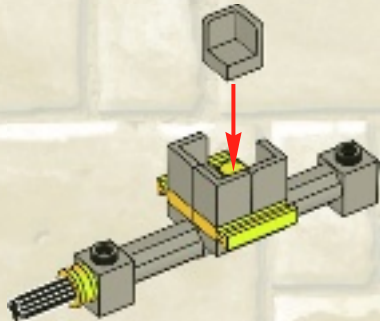

8

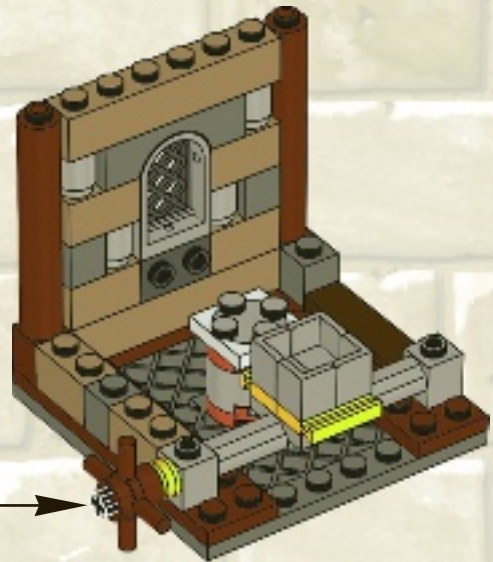
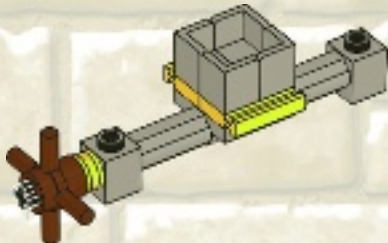



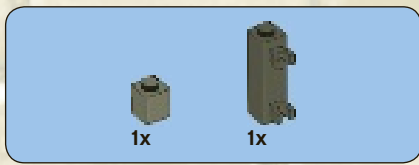

14

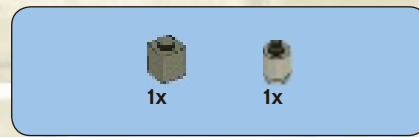
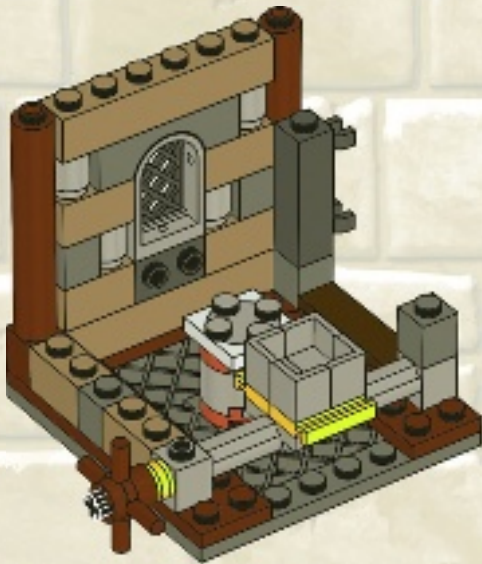

15

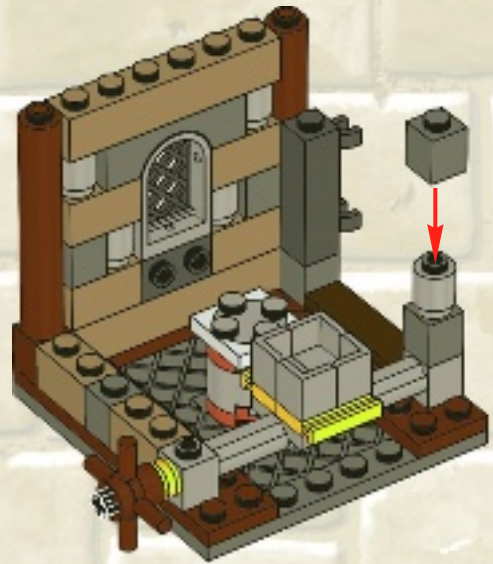

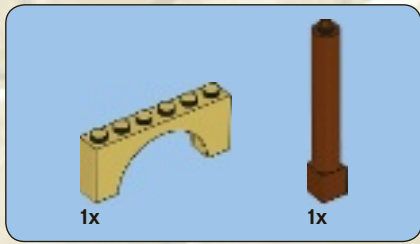

16

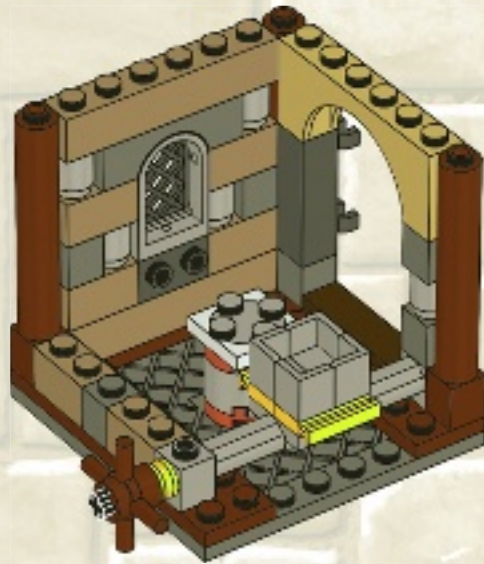

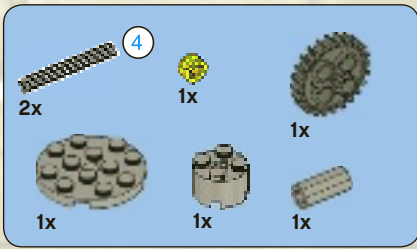

17

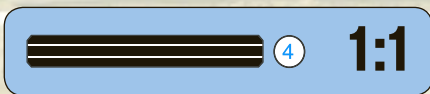
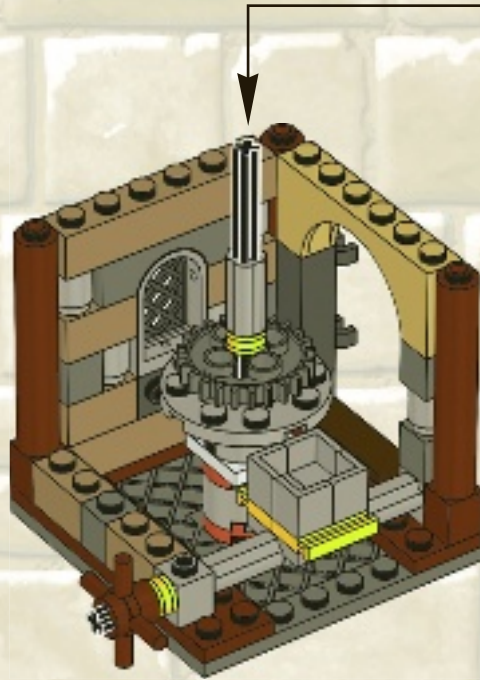
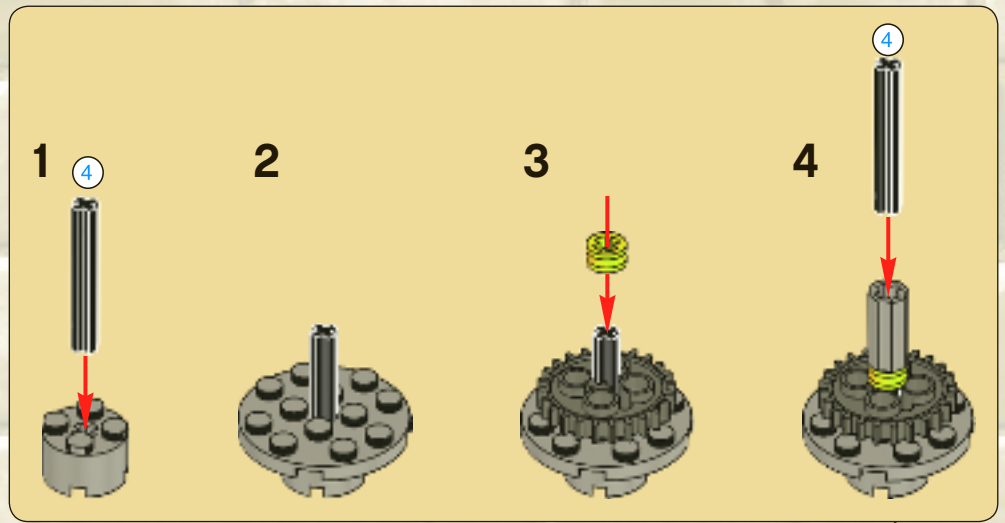





1x



2x

# 18

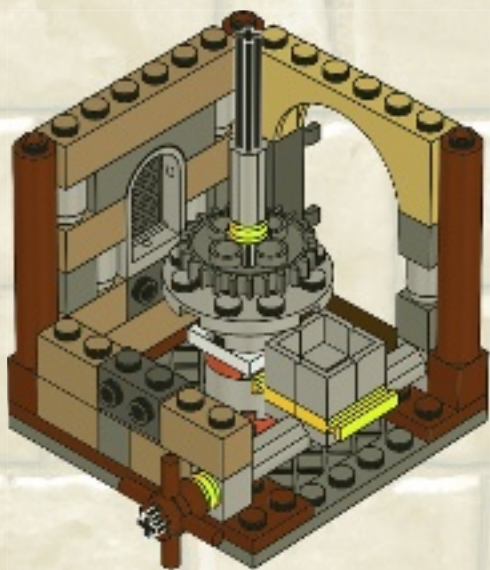

2x



2x

# 19

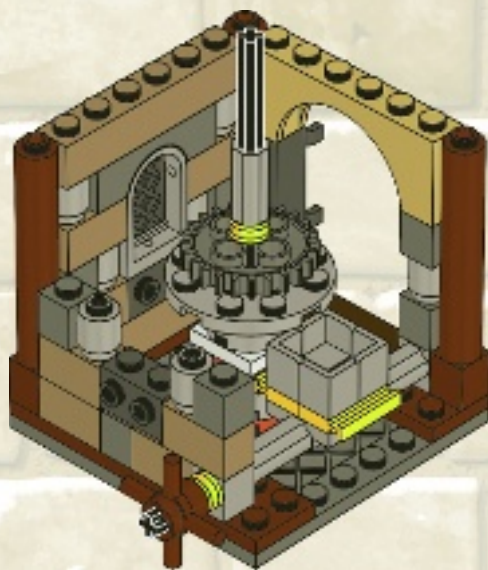



1x



1x

# 20

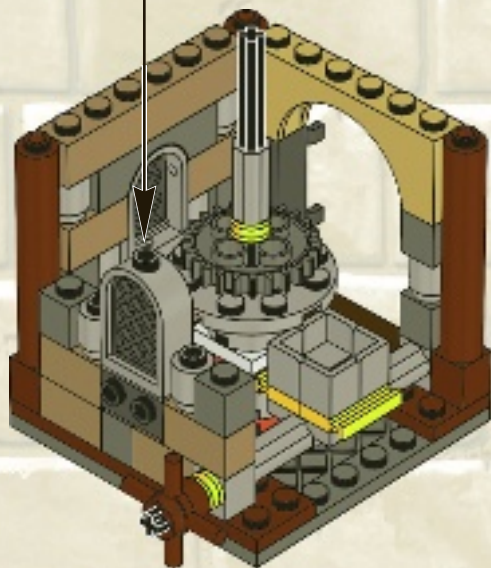
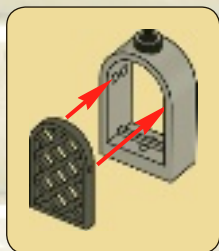

2x

# 21

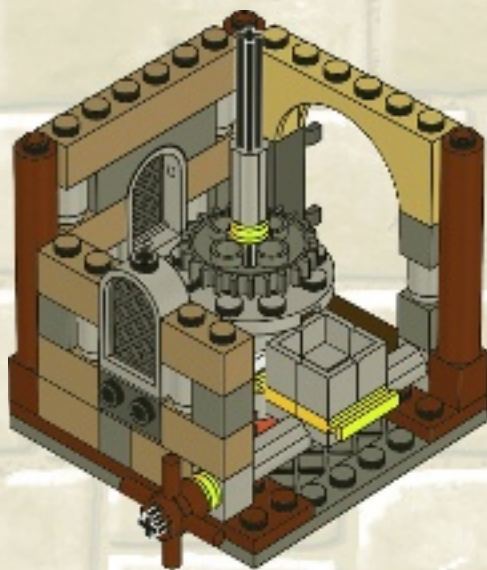





22

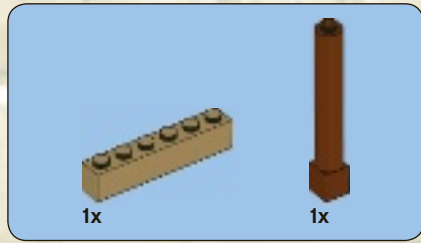
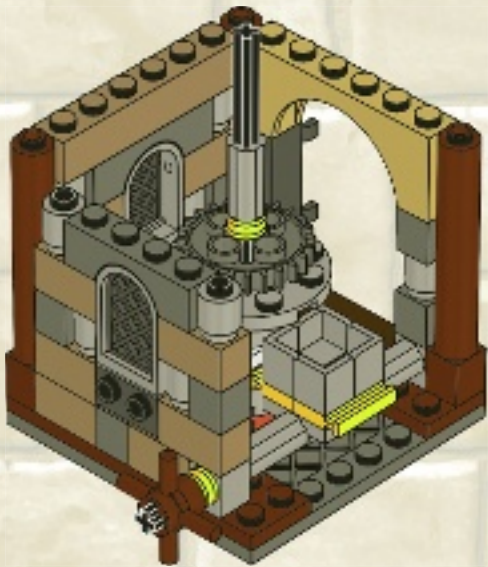

23

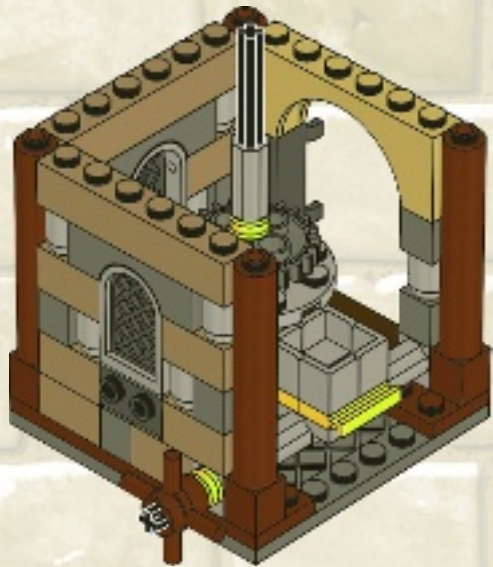



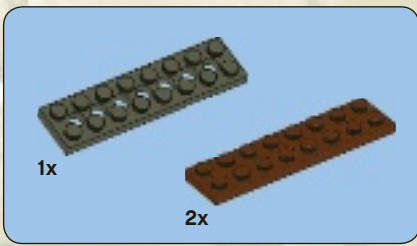

24

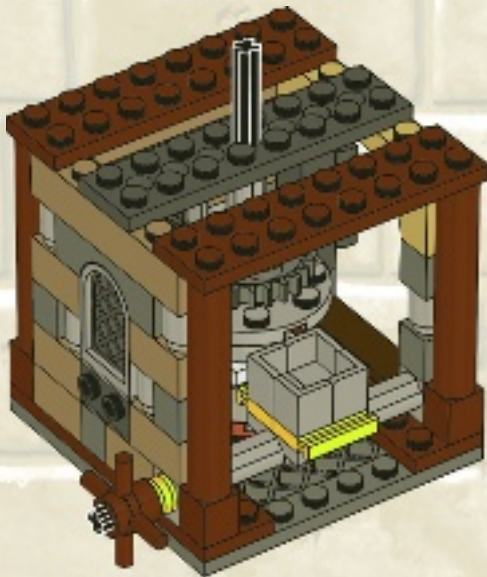

25

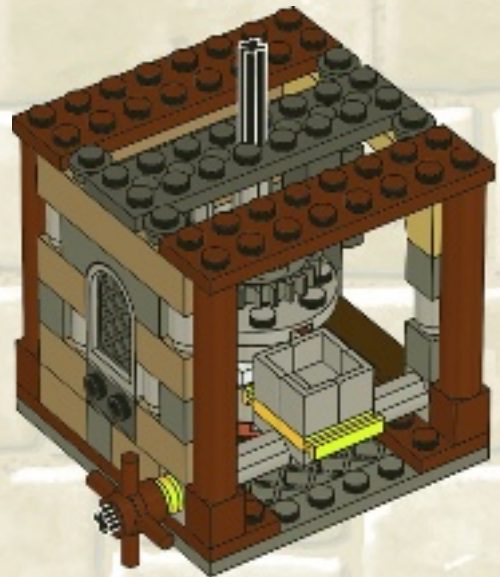



1x



1x

# 26

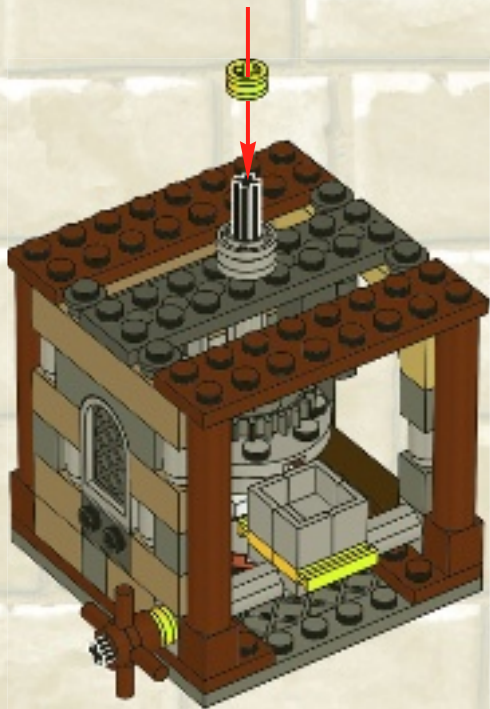

4x

# 27

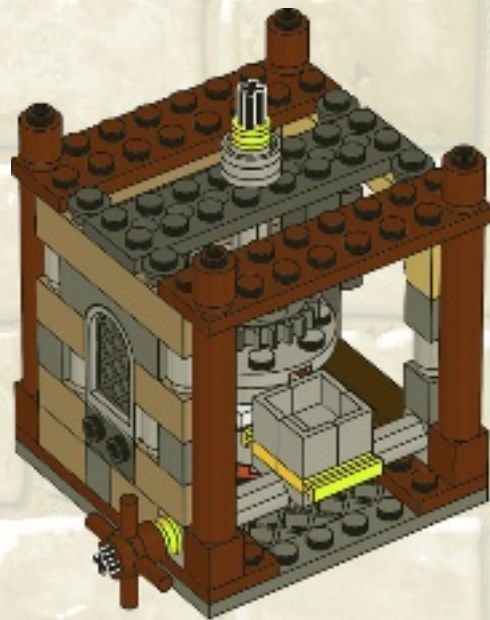





6x

28

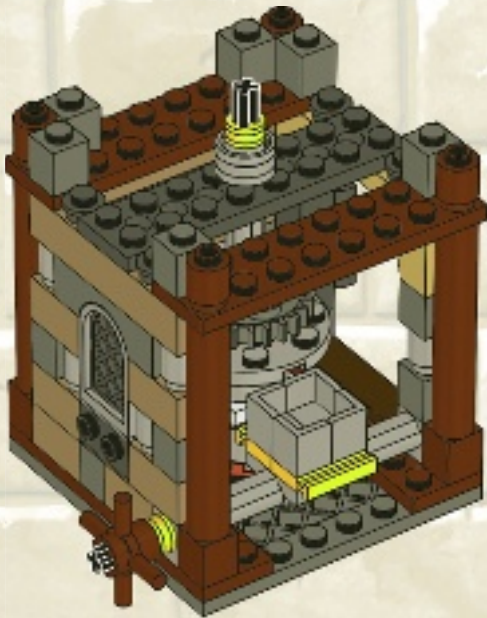

1x

29

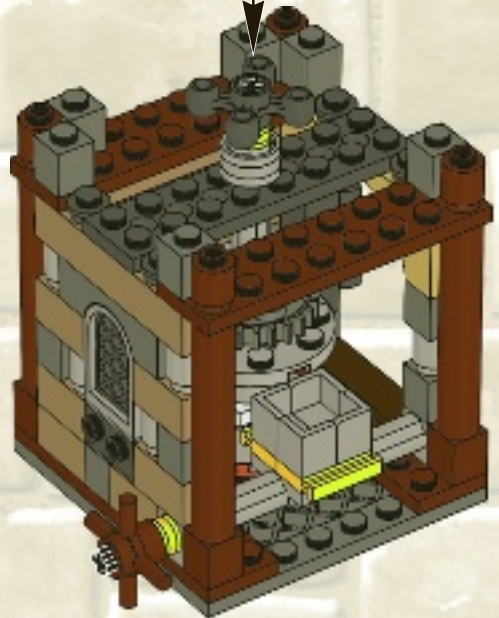





4x

# 30

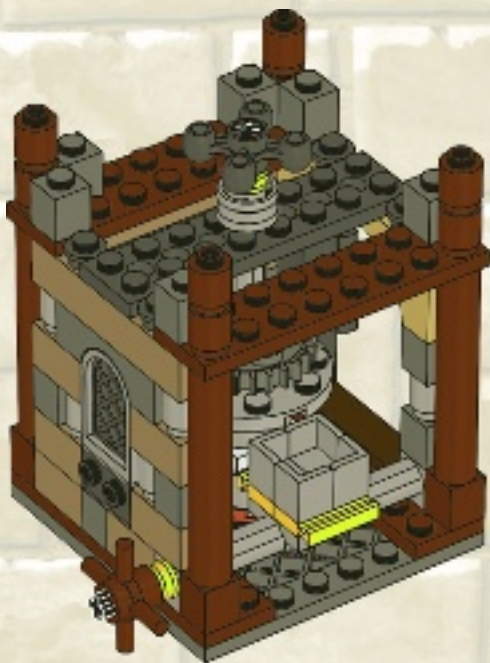

3x

# 31

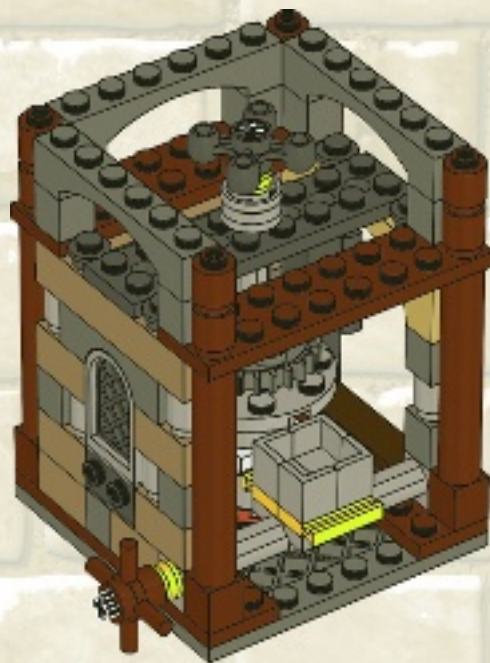

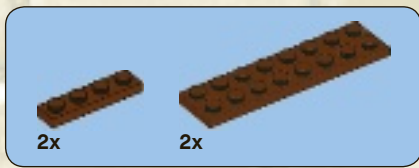

32

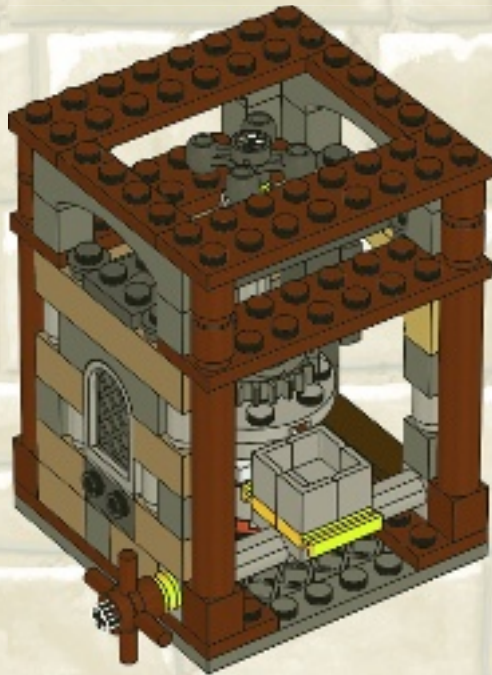



1

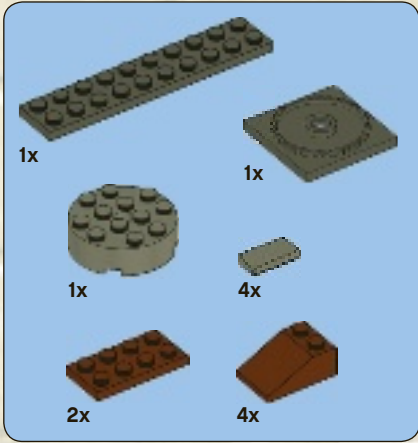

2

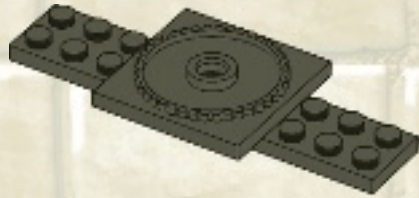

33

3

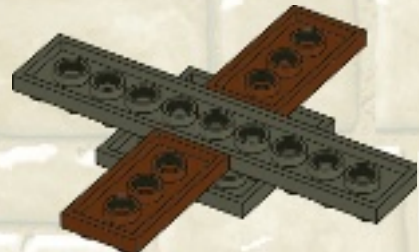



4

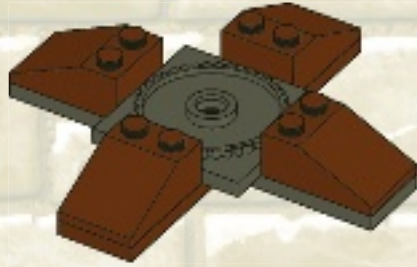
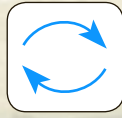

5



6



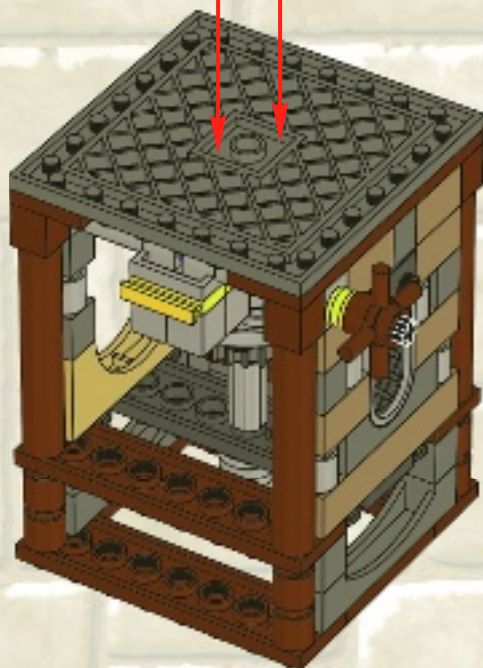
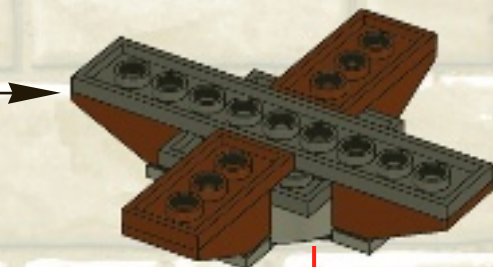

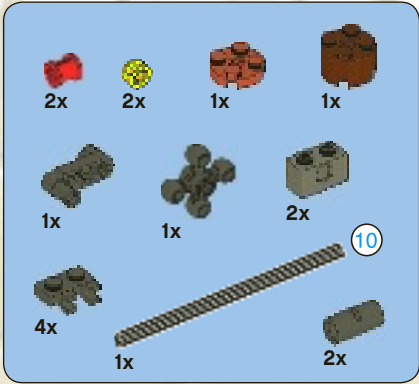

34

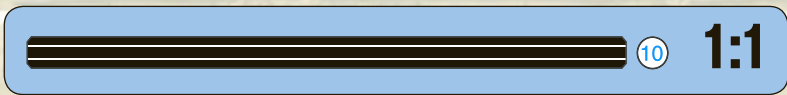
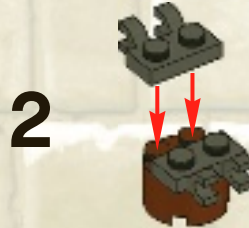



5



6

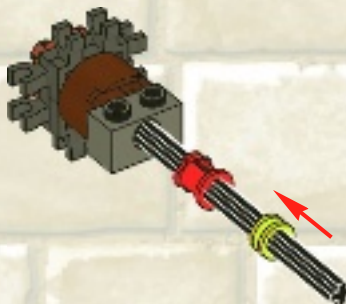

7

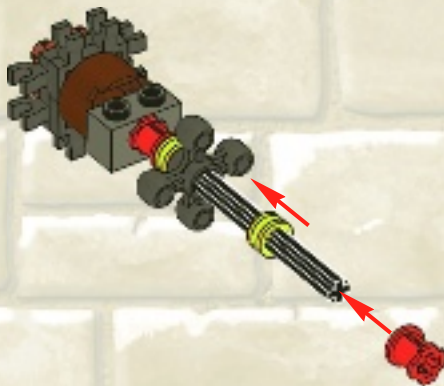

8

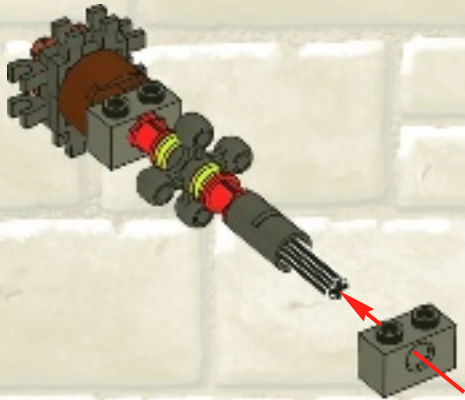

9

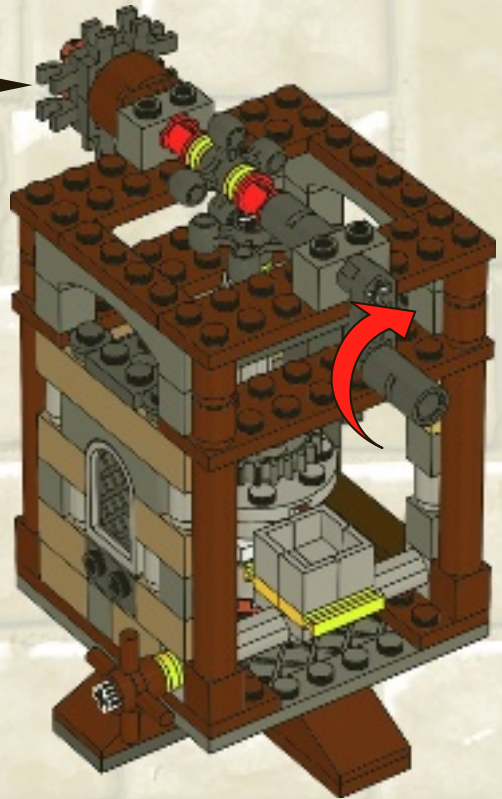
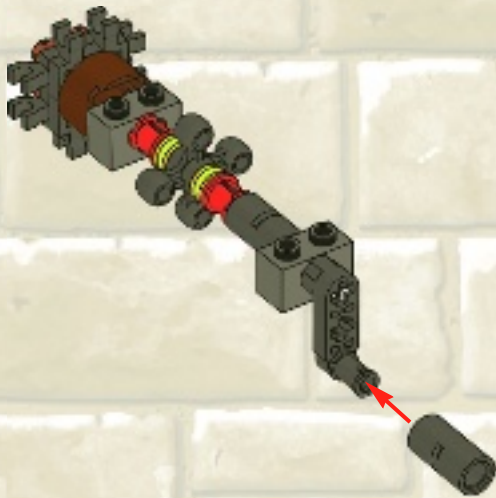





4x



4x

# 35

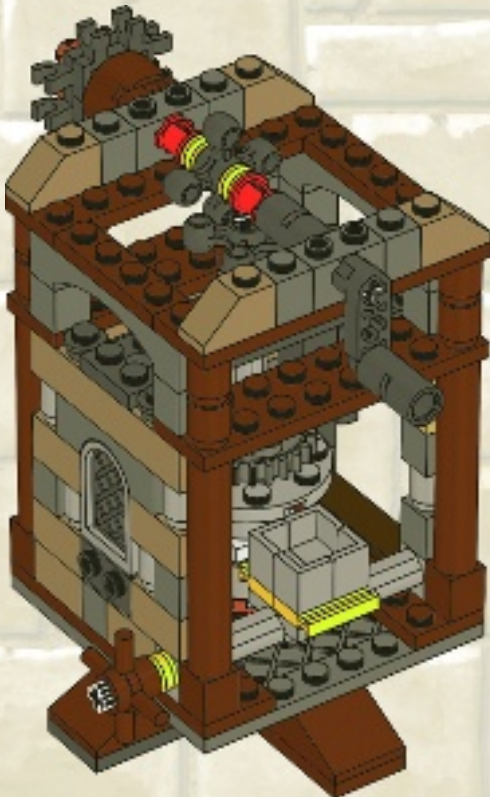

2x



4x

# 36

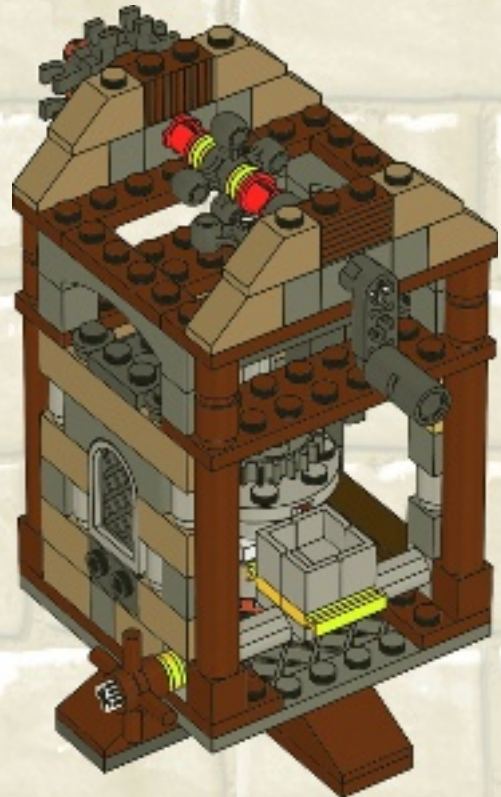





4x

37

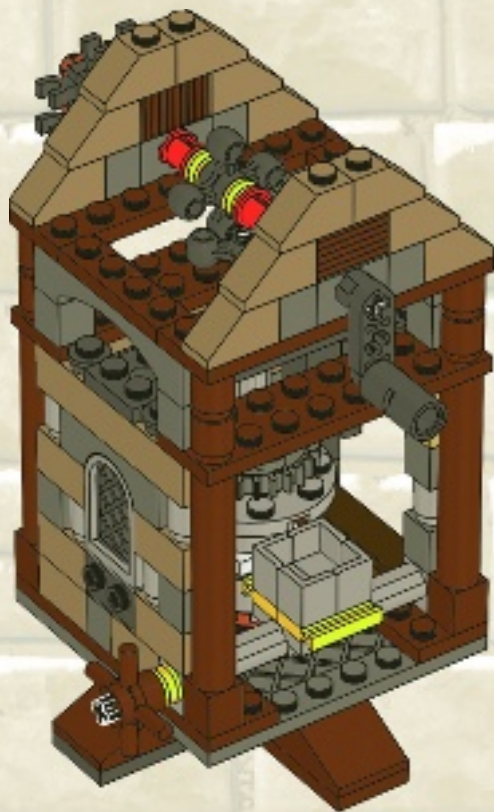

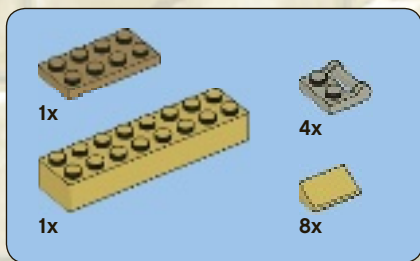

**38**

**1**

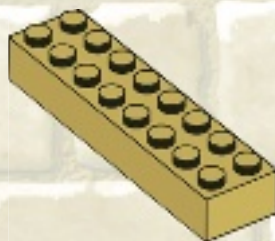

**2**

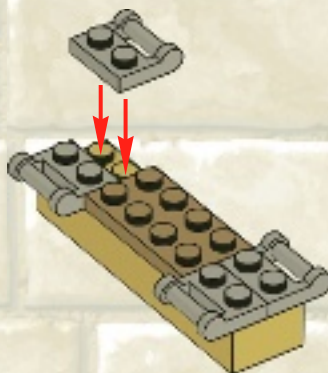

**3**

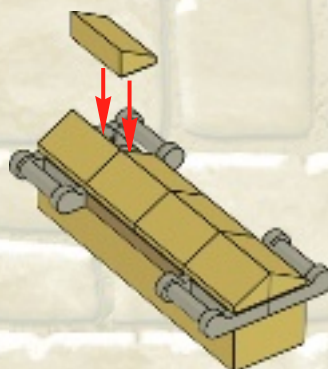

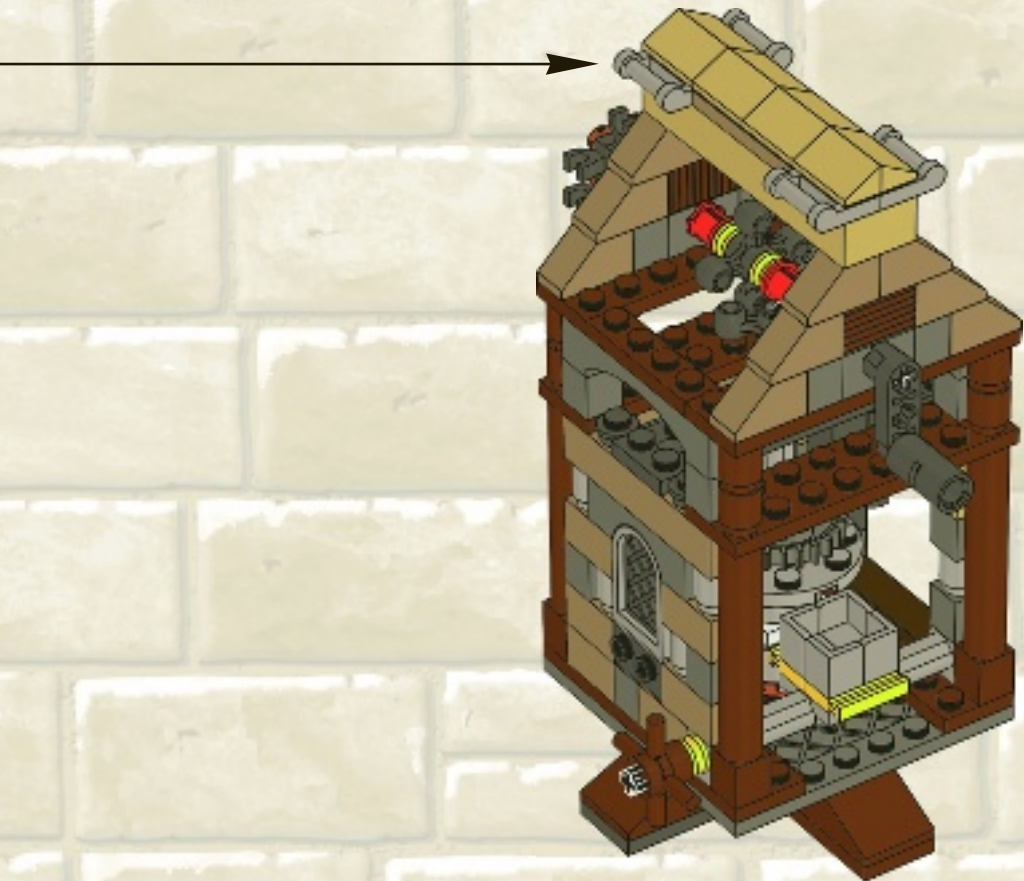



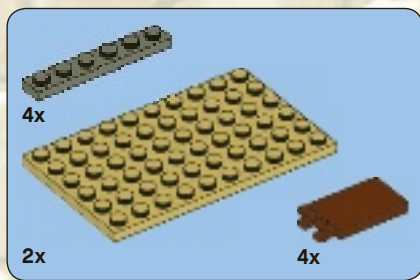

39

1



2

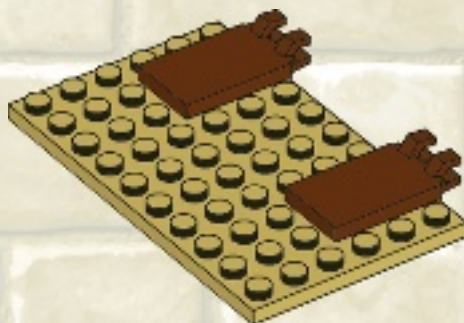

3

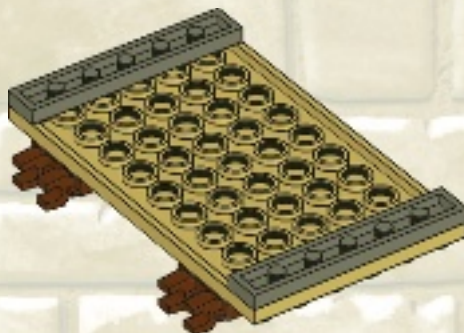

2x

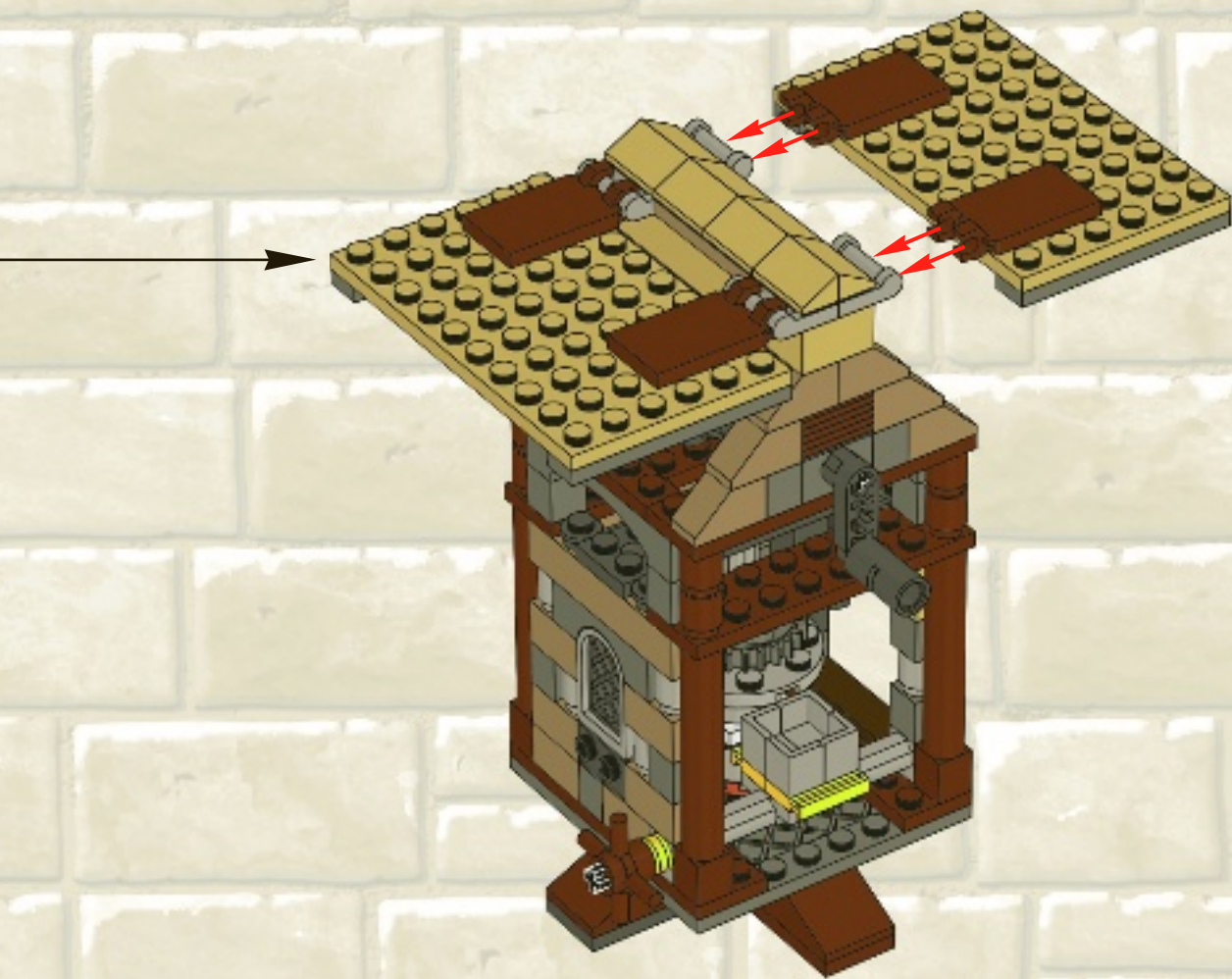



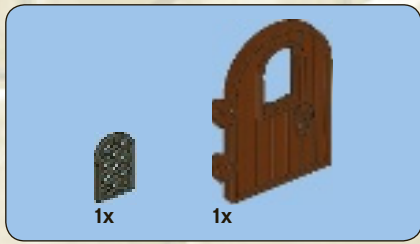

40

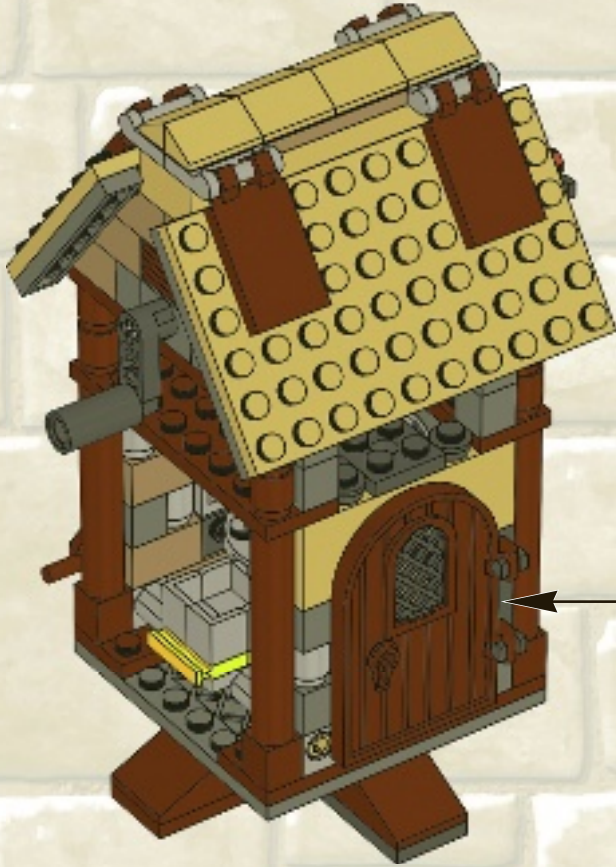



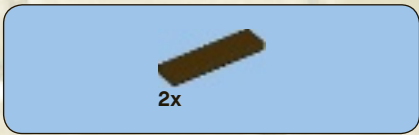

41

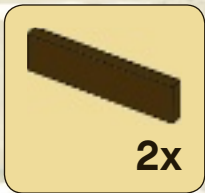



4x

42

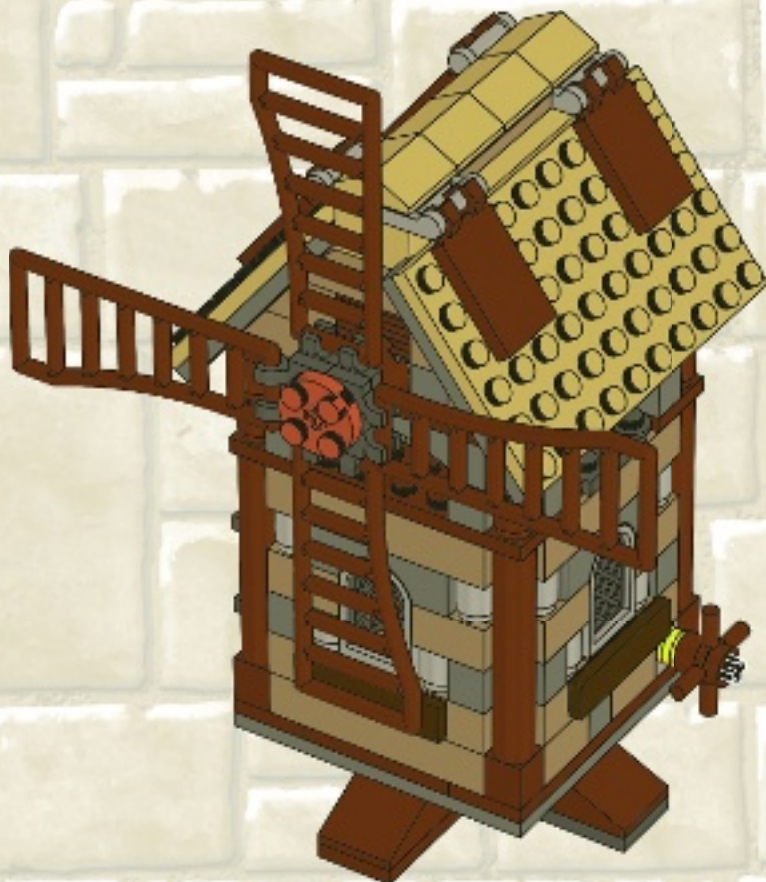



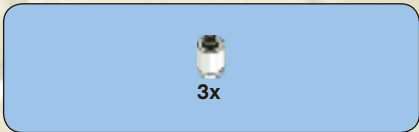

43

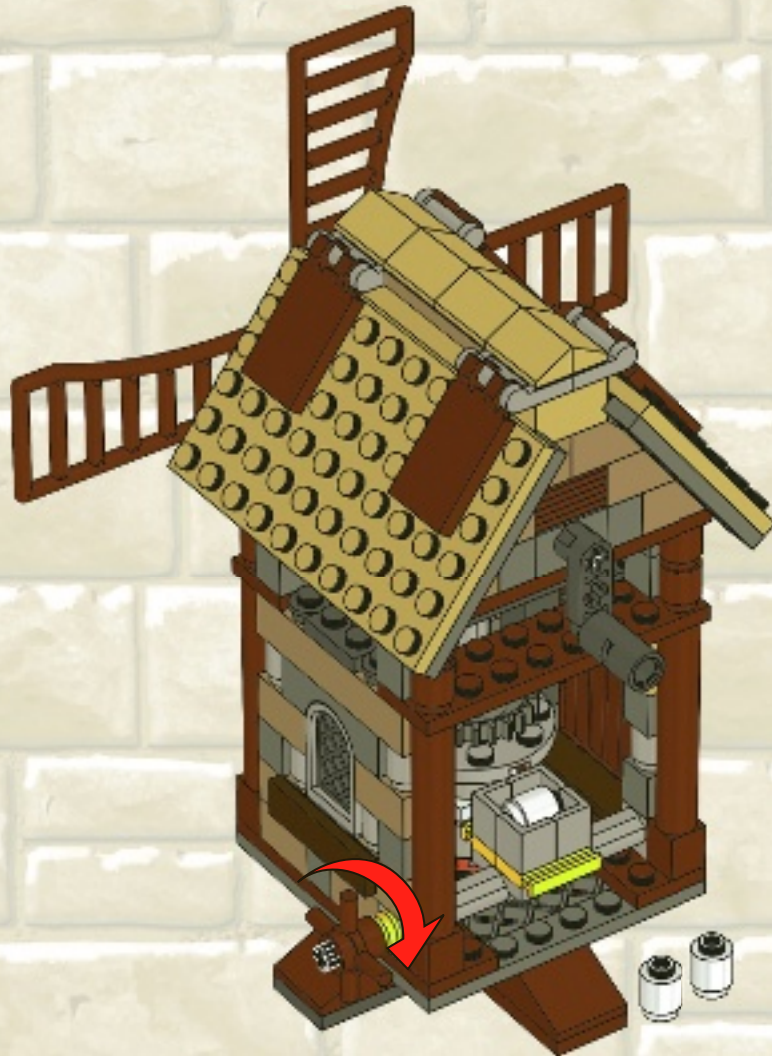





# Kingdoms



7187

6918



7188









# WIN!

Go to [www.LEGOsurvey.com/product](http://www.LEGOsurvey.com/product) to fill out a survey for a chance to win a cool LEGO® Product.

No purchase necessary.

Open to all residents where not prohibited.



## [www.LEGOsurvey.com/product](http://www.LEGOsurvey.com/product)

### GEWINNE! WIN!

Nimm an der Umfrage auf [www.LEGOsurvey.com/product](http://www.LEGOsurvey.com/product) teil und hab die Chance ein cooles LEGO® Produkt zu gewinnen!

Die Teilnahme am Gewinnspiel führt zu keinerlei Kaufverpflichtungen. Teilnahme in allen nicht ausgeschlossenen Ländern möglich.

Ga naar [www.LEGOsurvey.com/product](http://www.LEGOsurvey.com/product), vul een enquêteformulier in en maak kans op een cool LEGO® product.

Geen aankoopverplichting. Iedereen mag deelnemen, uitgezonderd ingezetenden van landen waar een enquêteverbod geldt.

### GAGNE! 当てよう!

Visite [www.LEGOsurvey.com/product](http://www.LEGOsurvey.com/product) pour répondre à un questionnaire et avoir une chance de gagner un produit LEGO® très cool!

Aucune obligation d'achat. Ouvert à tous les résidents des pays autorisés.

[www.LEGOsurvey.com/product](http://www.LEGOsurvey.com/product) にアクセスして、アンケートにご記入ください。当選者にはレゴ®製品を差し上げます。

お買い上げの必要はありません。

禁止されていない限り、すべての管轄にご利用いただけます。





# Kingdoms



7189



**WARNING:** CHOKING HAZARD.  
Toy contains small parts and a small ball.  
Not for children under 3 years.





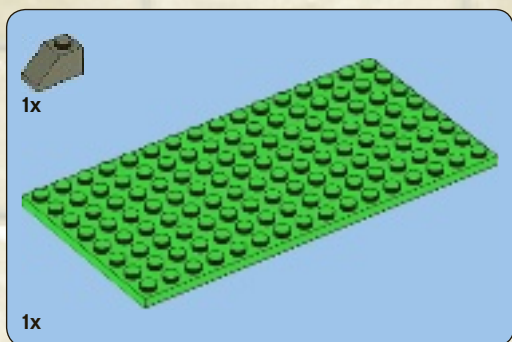
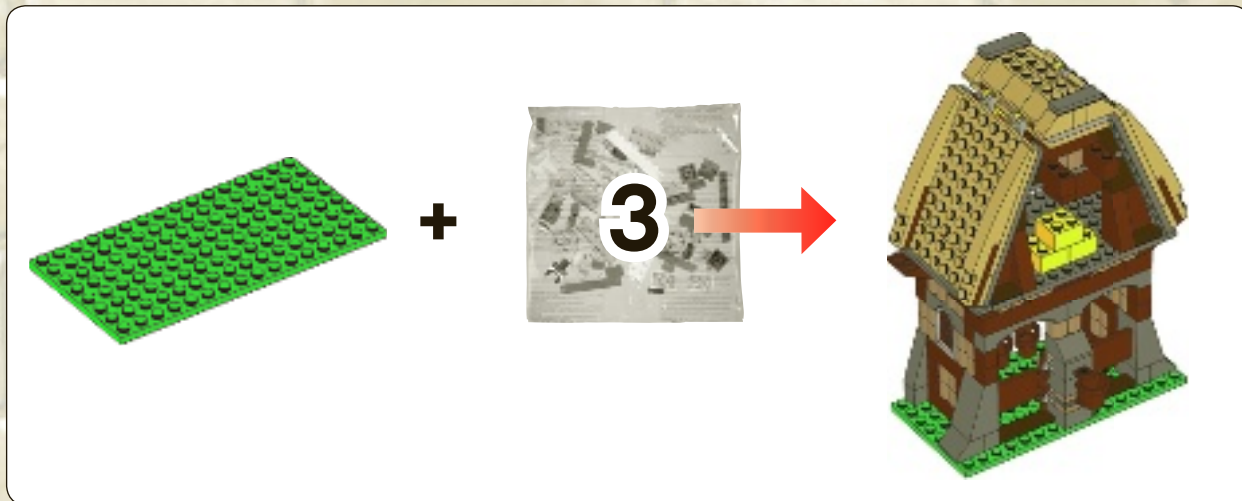

1

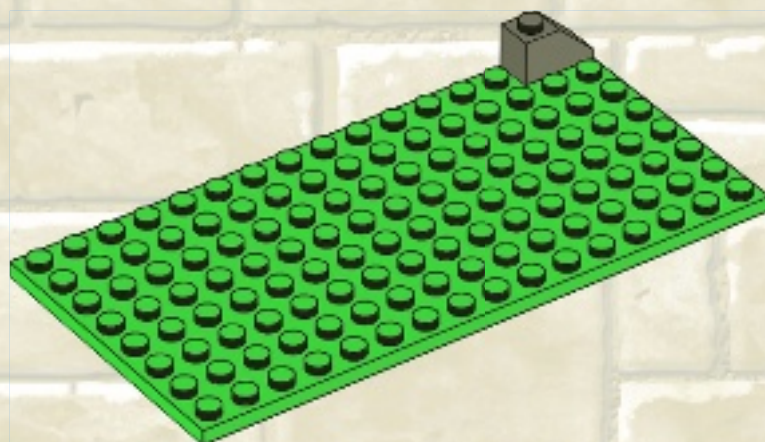

⚠ **AVERTISSEMENT** : RISQUE D'ÉTOUFFEMENT.  
Le jouet contient des petites pièces ainsi qu'une petite boule.  
Il ne convient pas aux enfants de moins de 3 ans.

⚠ **ADVERTENCIA**: PELIGRO DE ASFIXIA.  
Juguete que contiene partes pequeñas y una pelota pequeña.  
No recomendado para niños menores de 3 años.





1x



1x

2

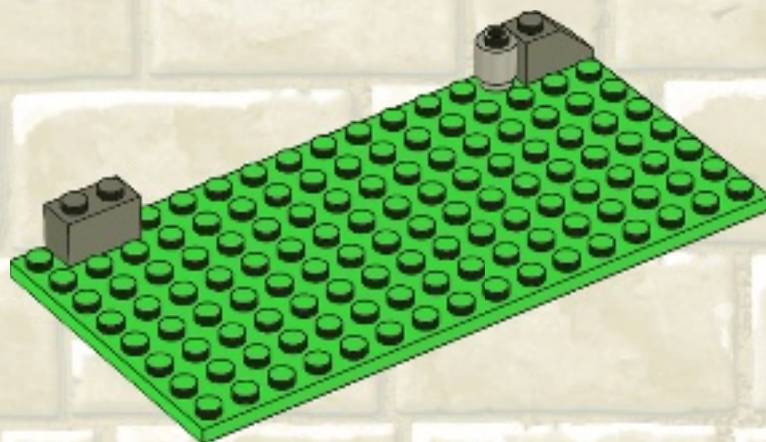

2x

3

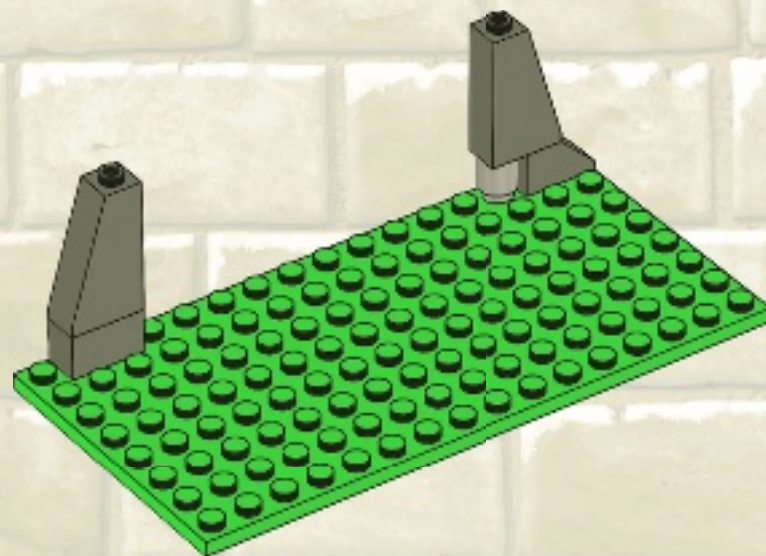

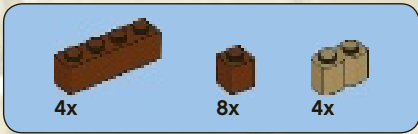

# 4

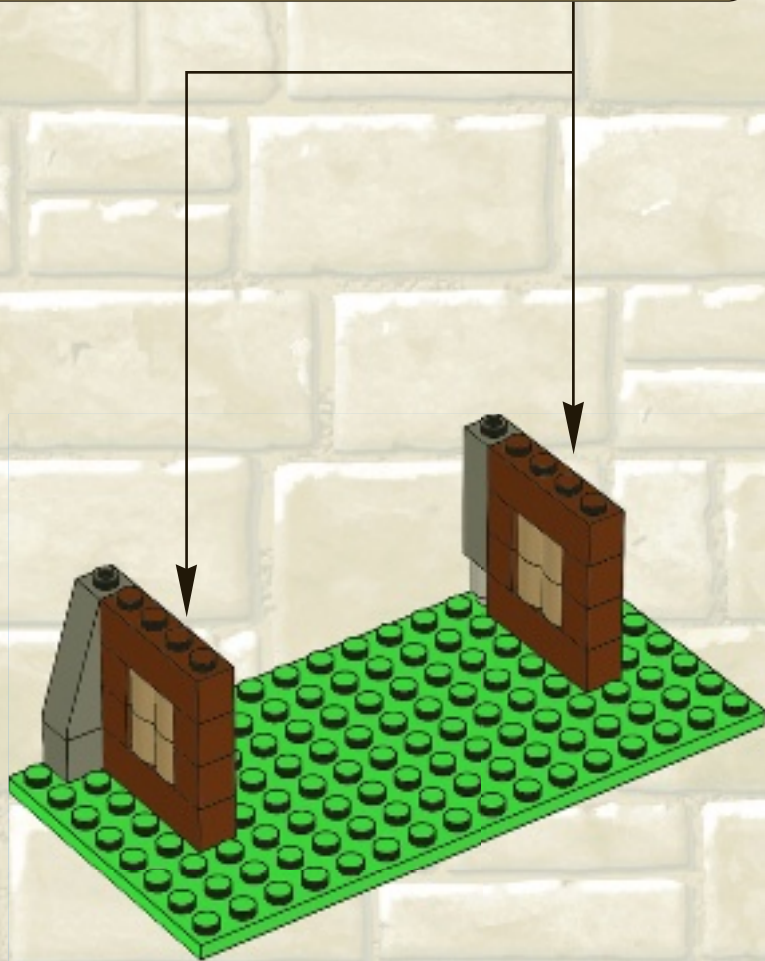
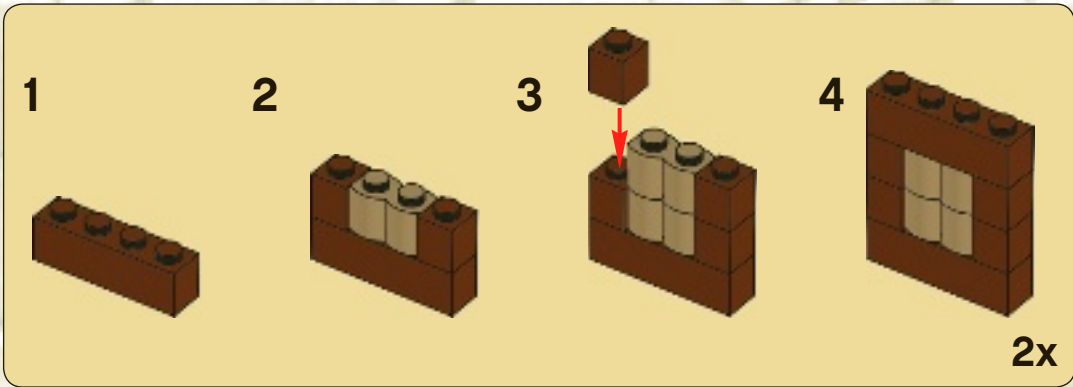



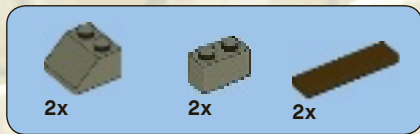

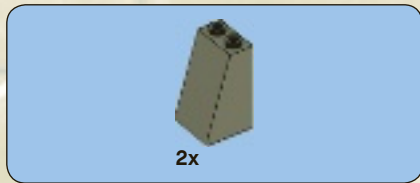
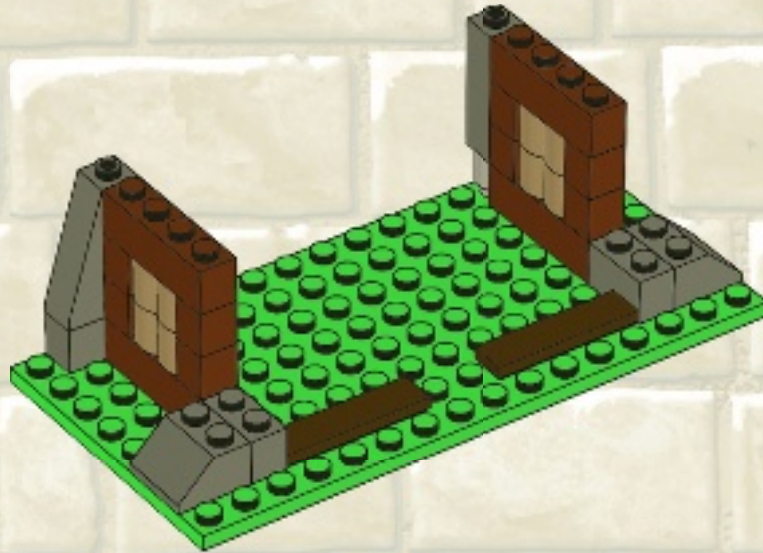

5

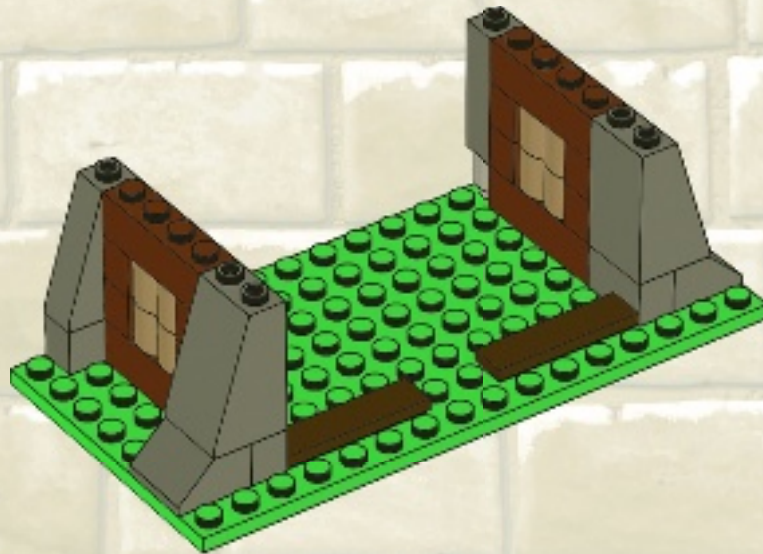

6



2x  2x 

7

 2x

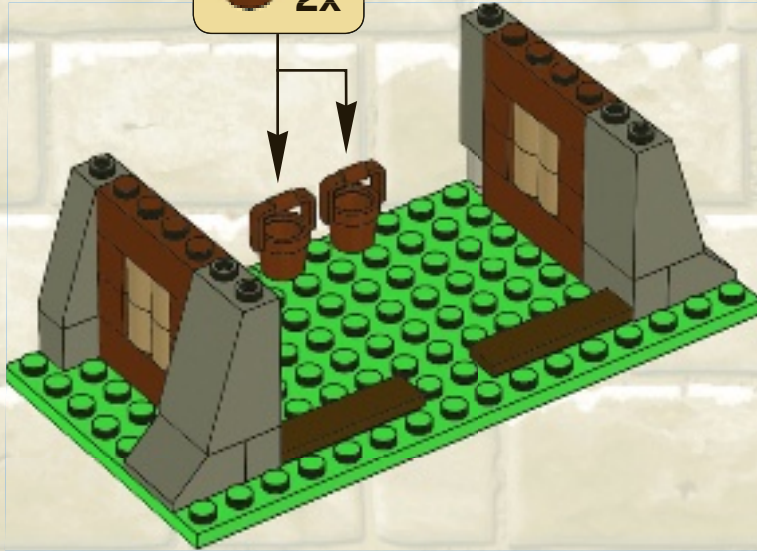

2x  4x 

8

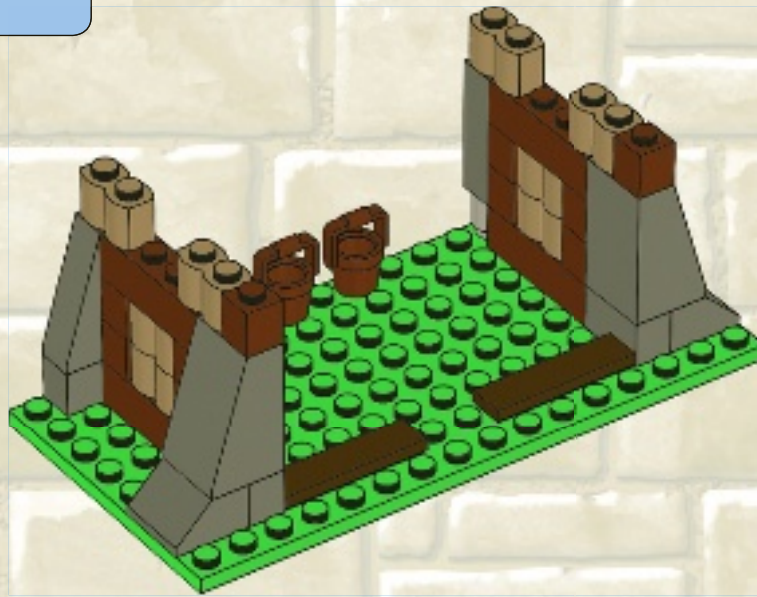



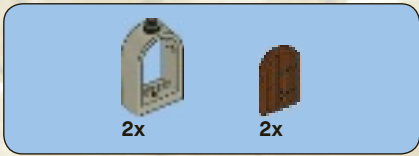

9

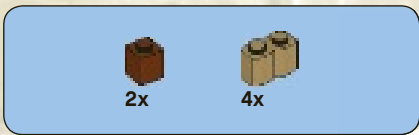
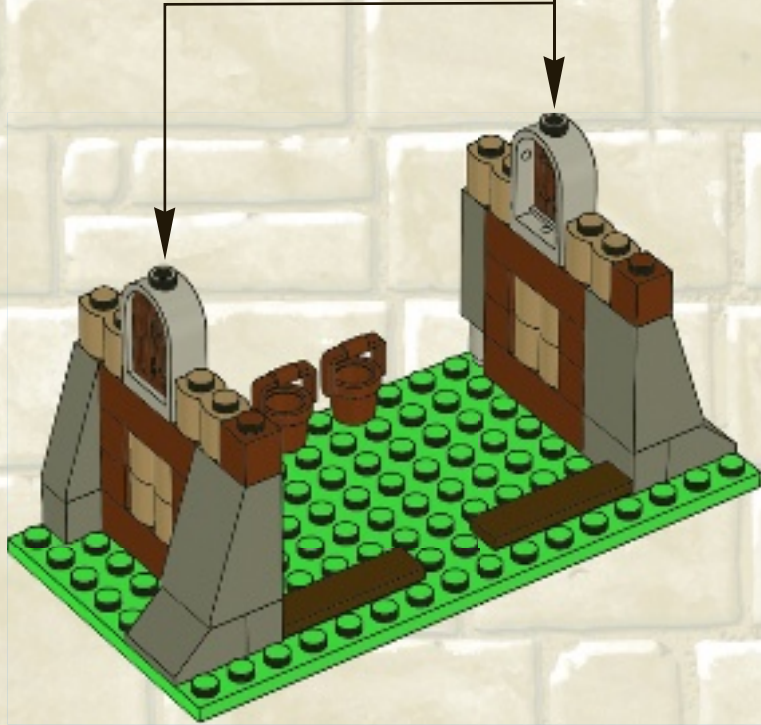
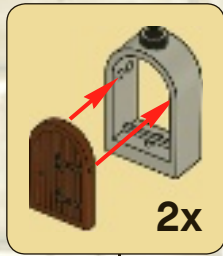

10

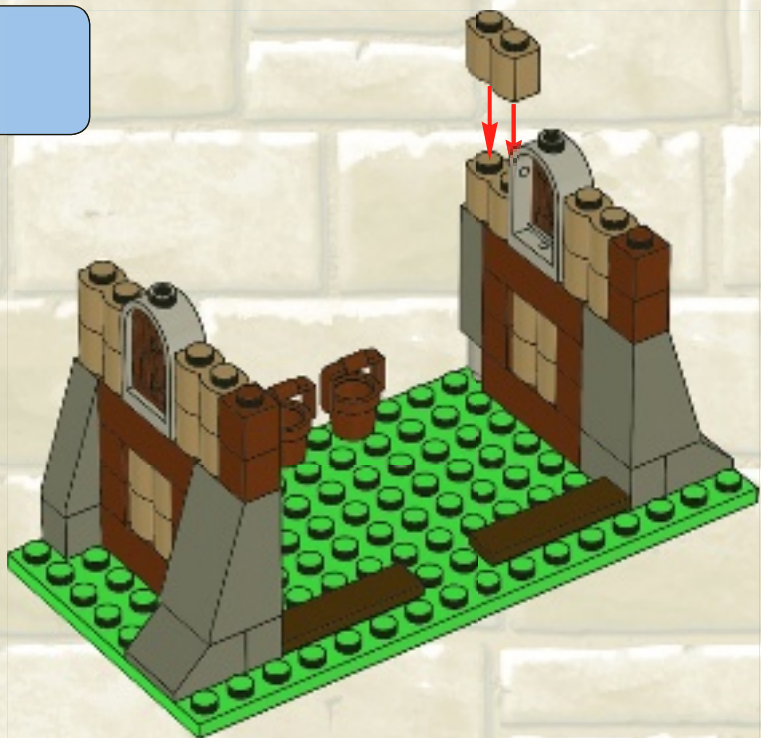



2x

11

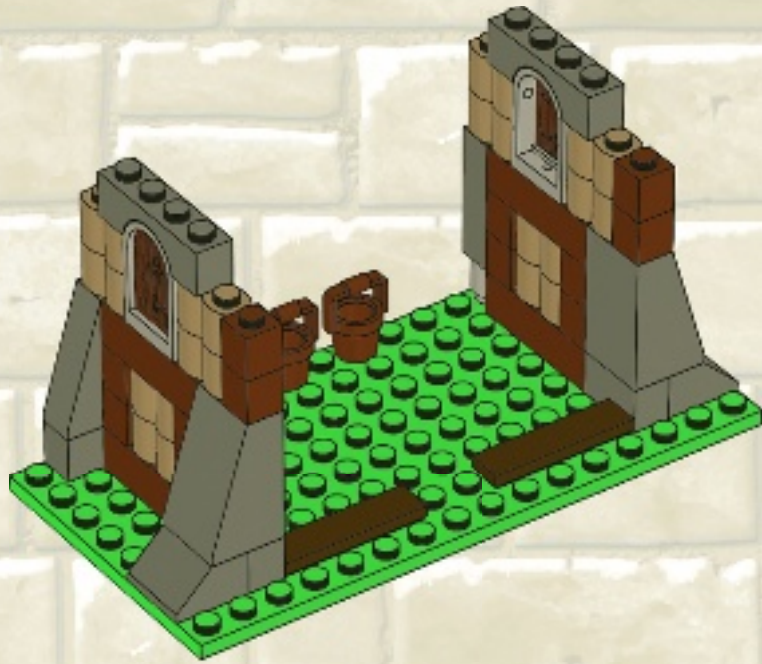

2x

12

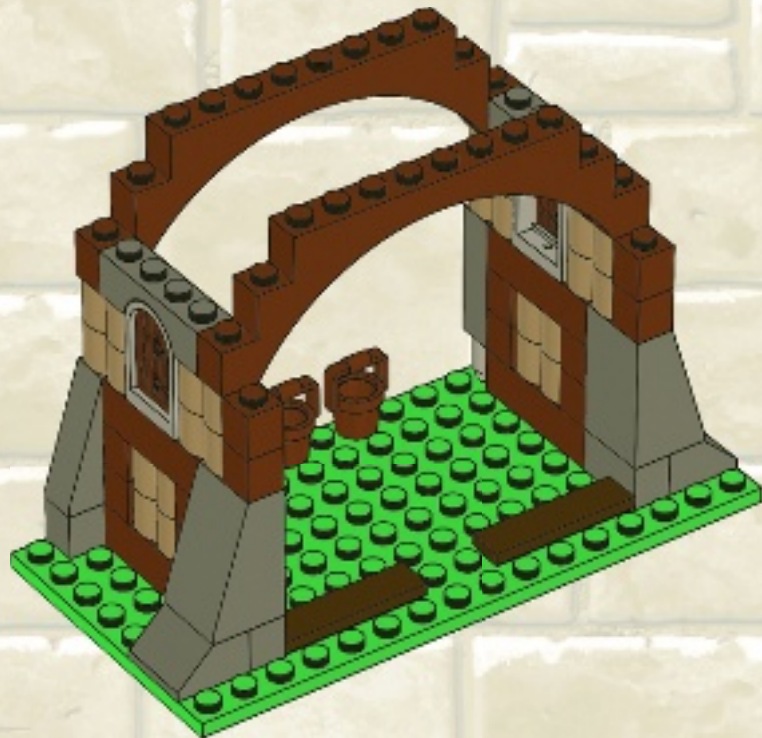



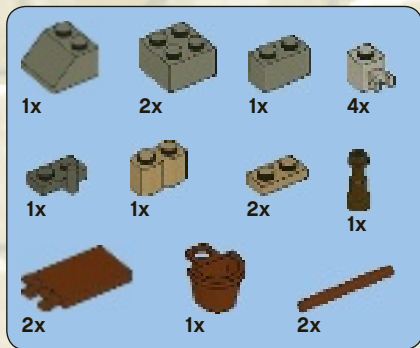

# 13

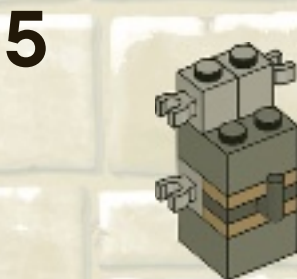

6

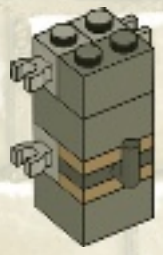

7

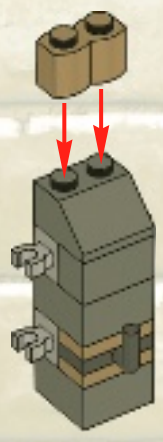

8

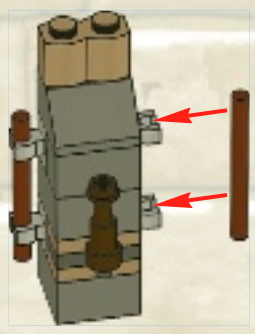

9

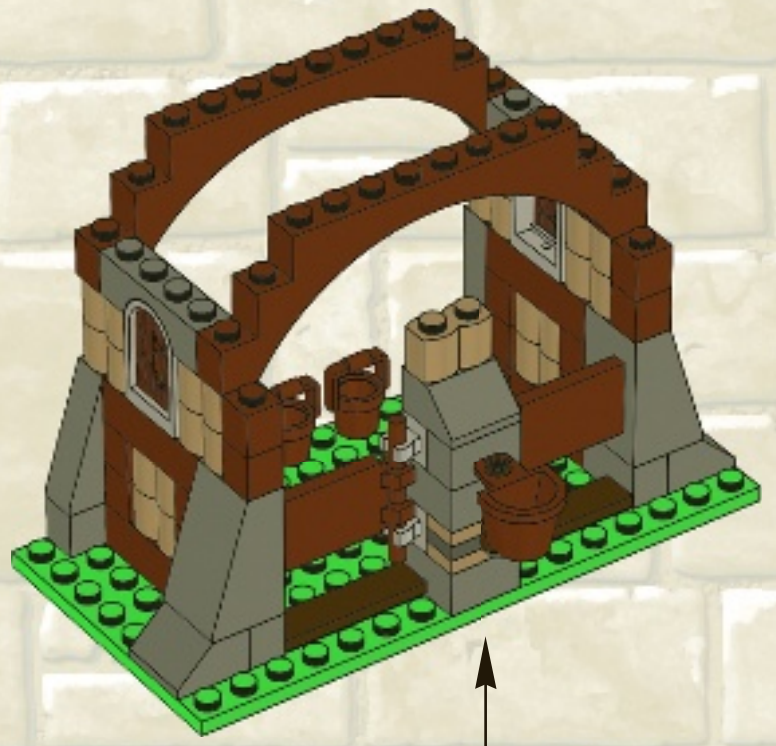
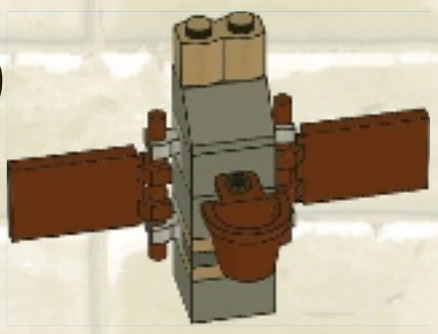





2x

# 14

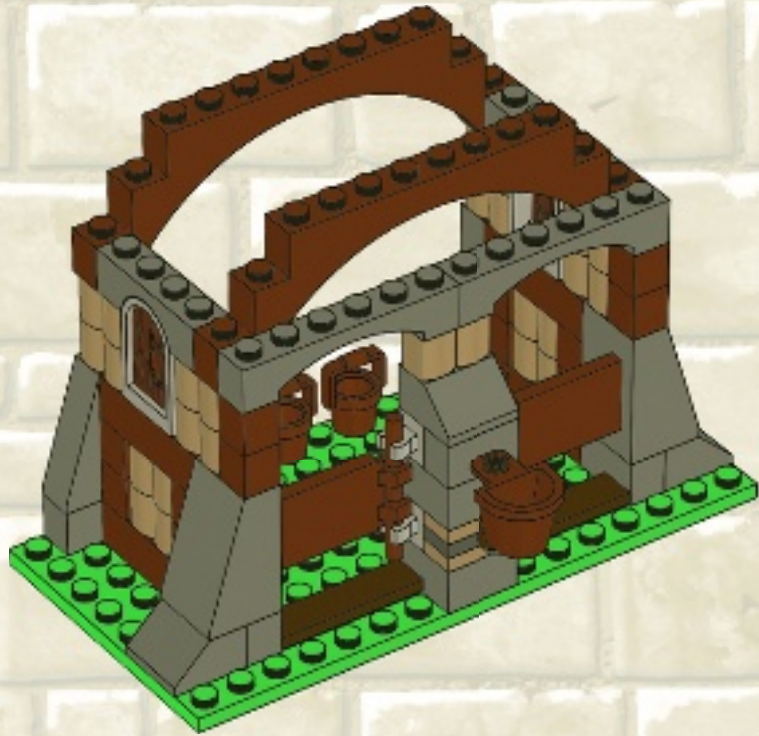

2x

# 15

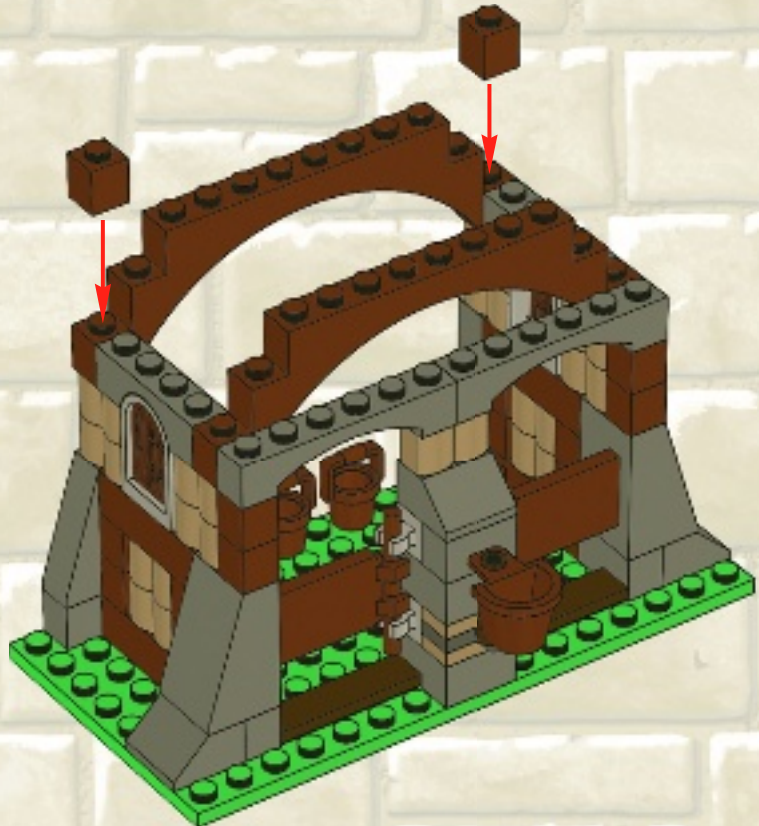



4x

16



2x



1x

17







4x

# 18



2x



1x

# 19





20

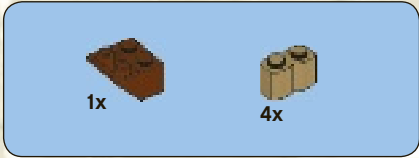
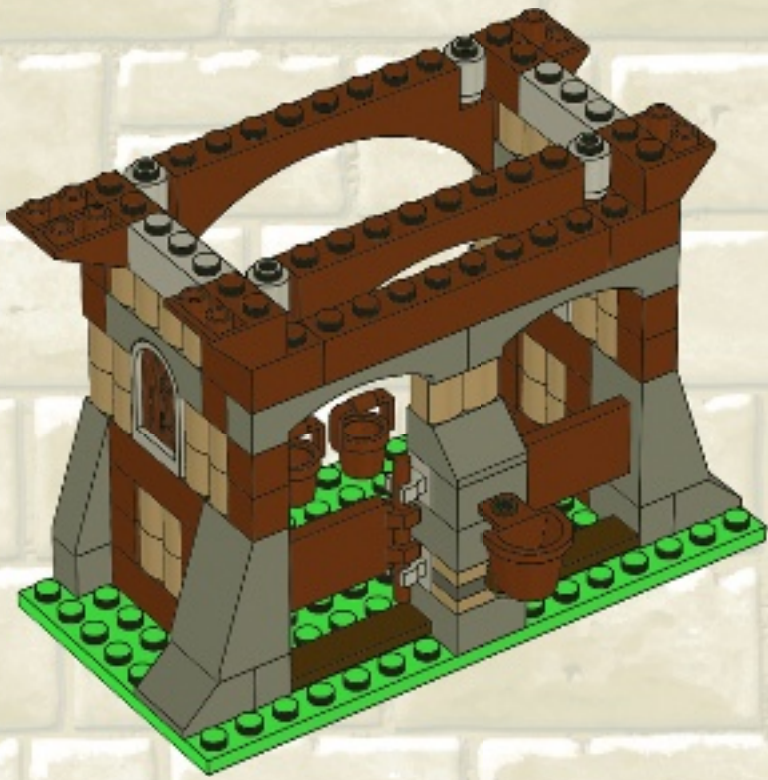

21

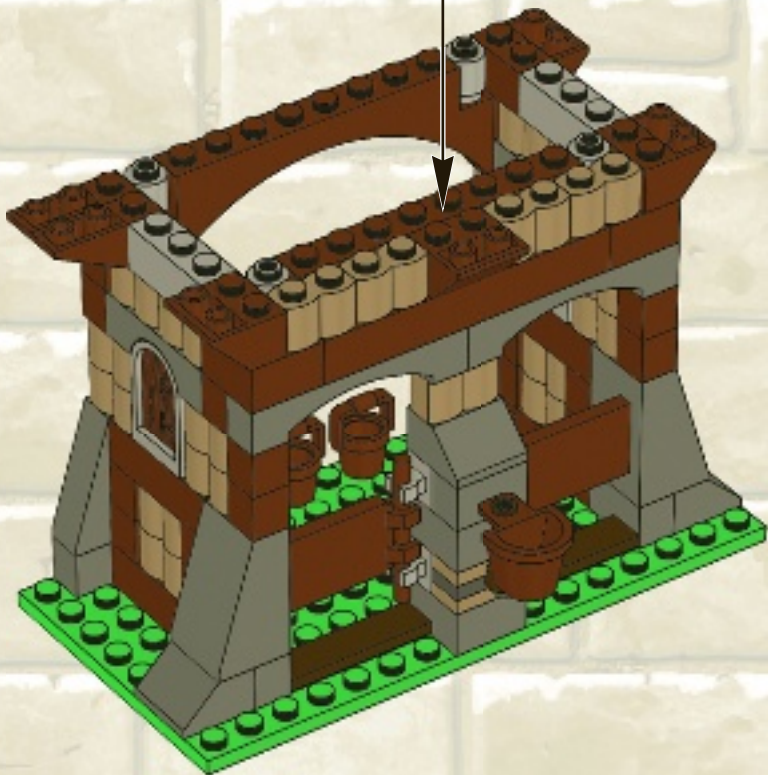



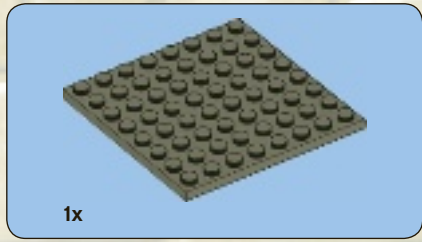

22

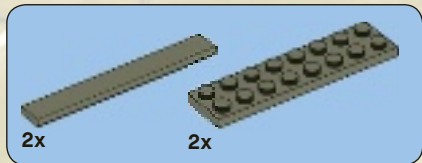

23







3x



4x

# 24



4x

# 25







26



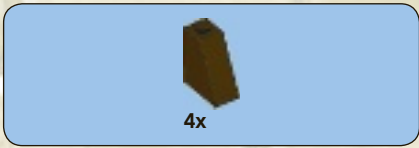

27





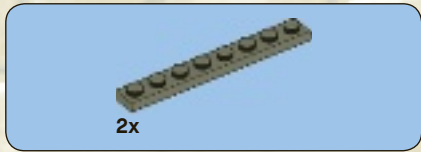

28



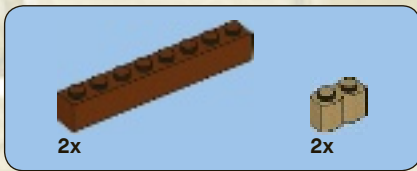

29







4x

# 30





2x

# 31







2x

# 32



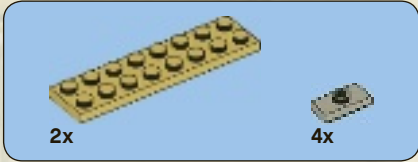

1

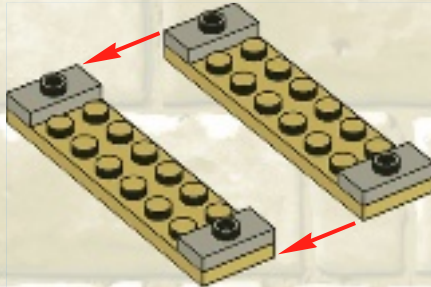

2

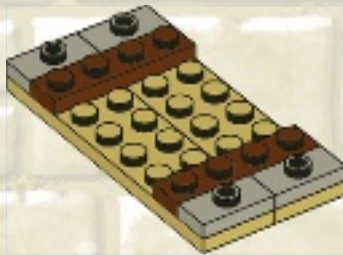

3

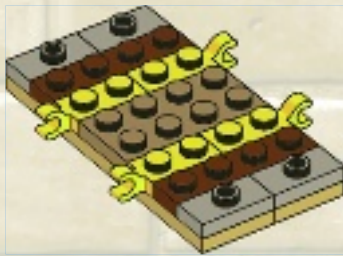





6x

4

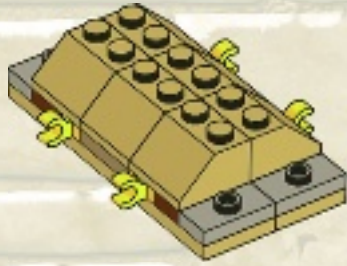

2x



4x



2x

5

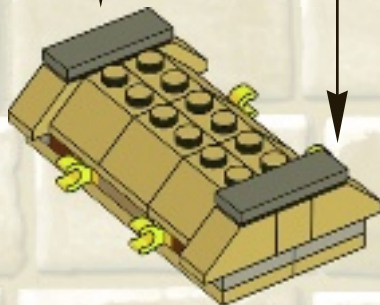
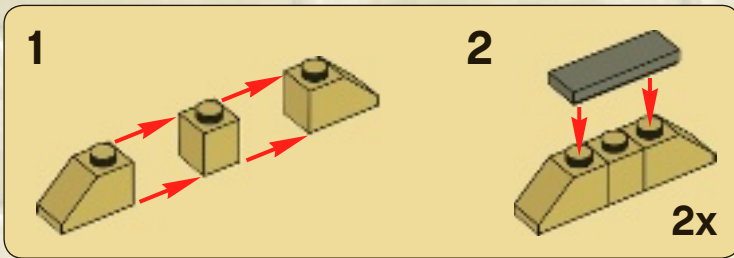

33





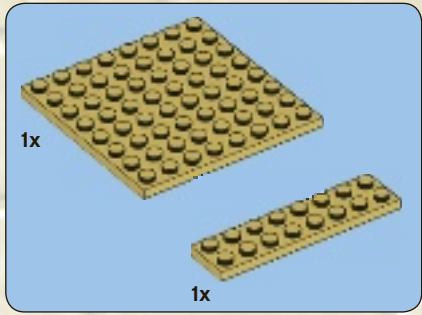
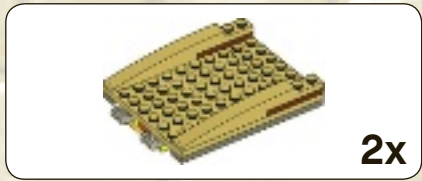

1

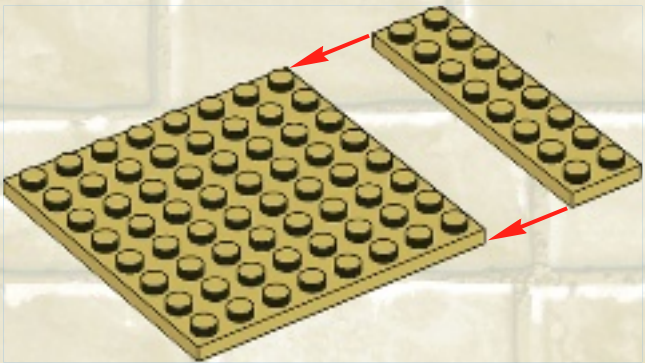

2

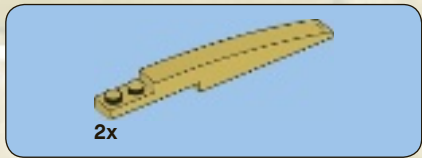

3

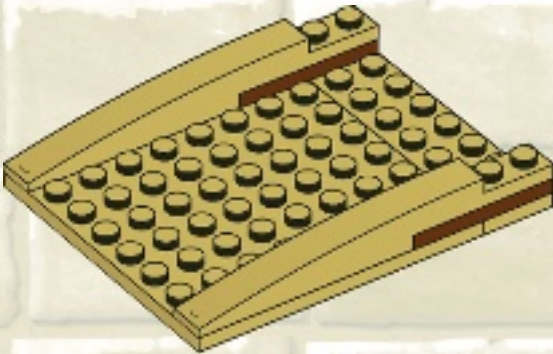

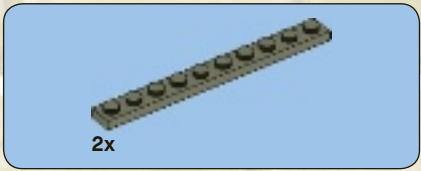

4

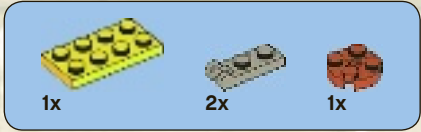
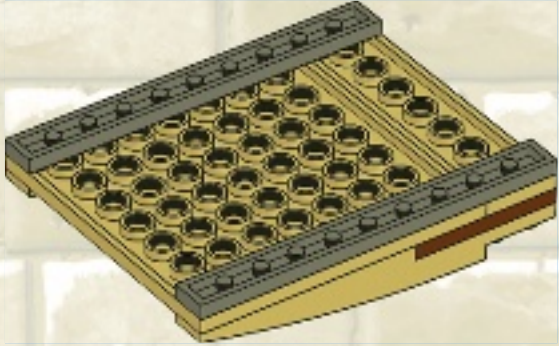

5

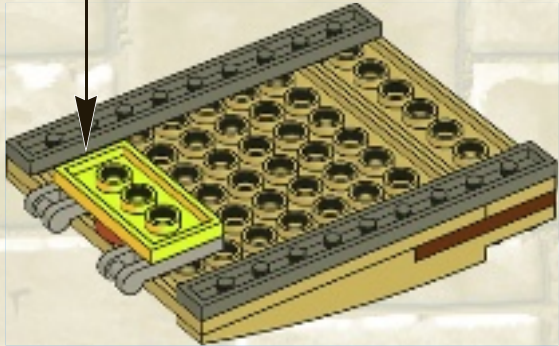
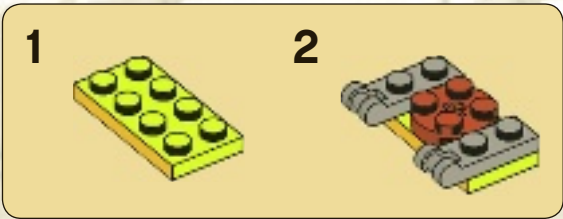



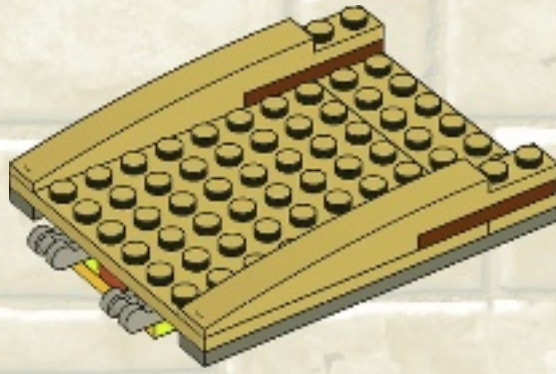
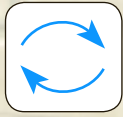

2x

34

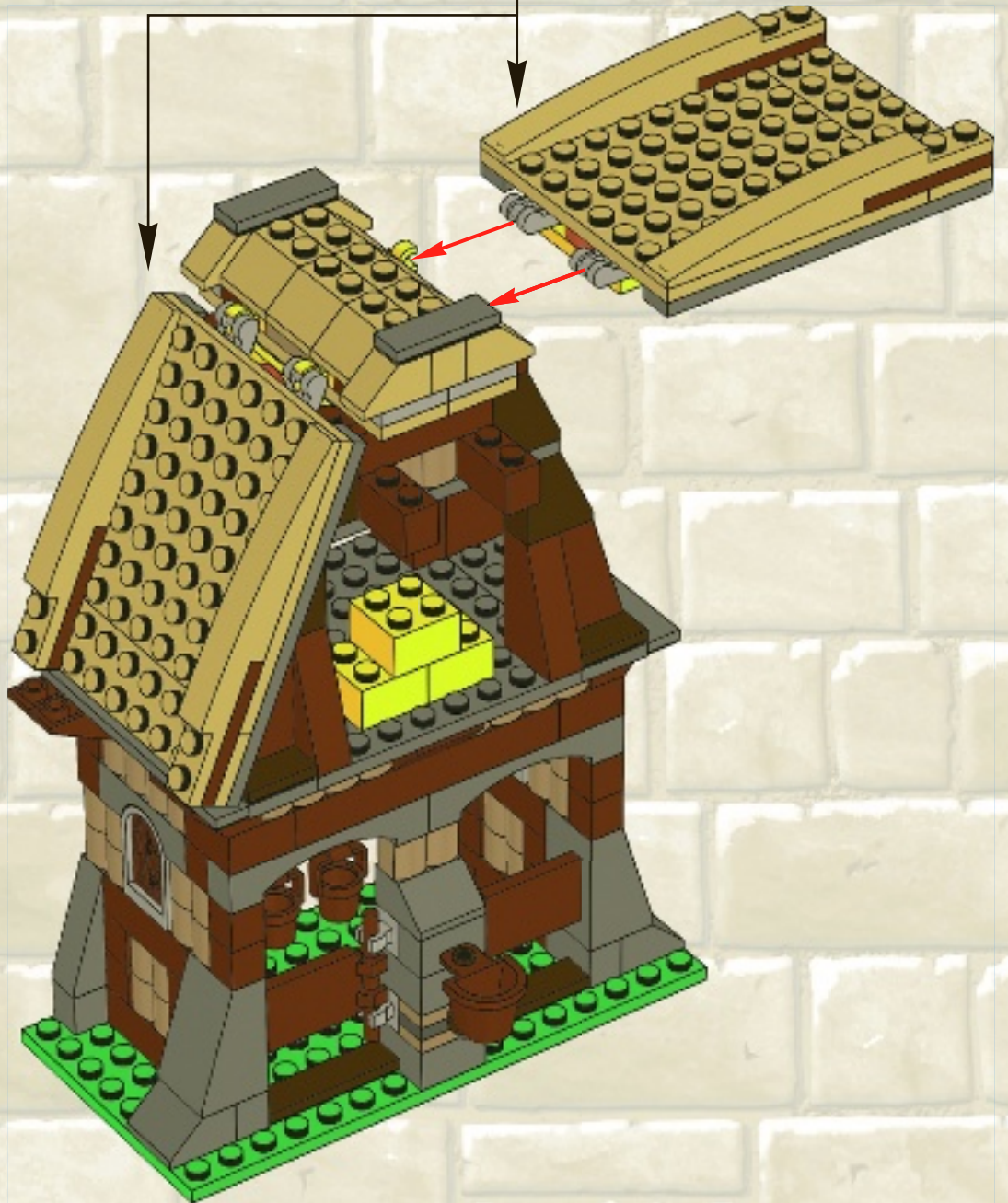

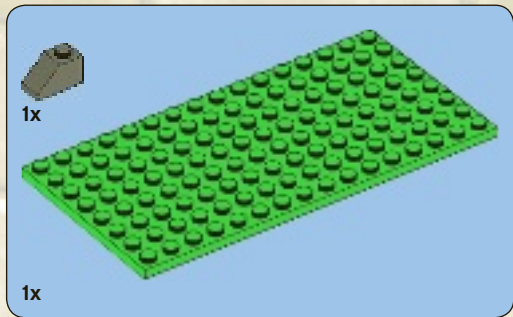
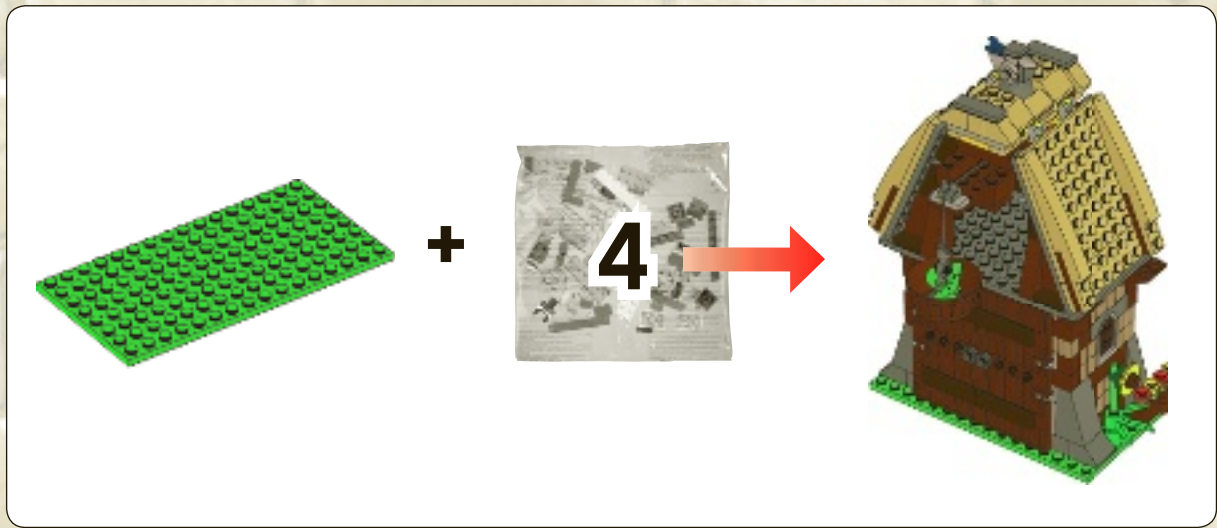

1

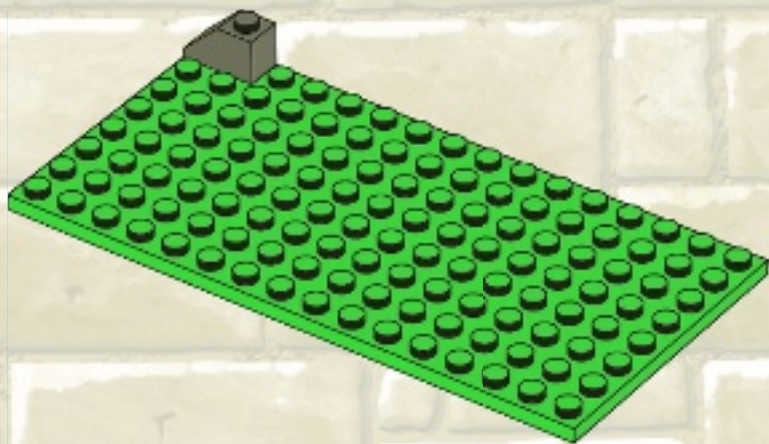





1x



1x

2

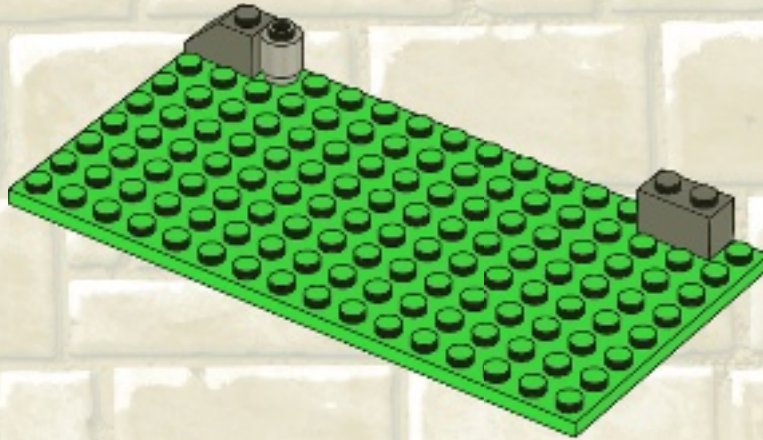

2x

3

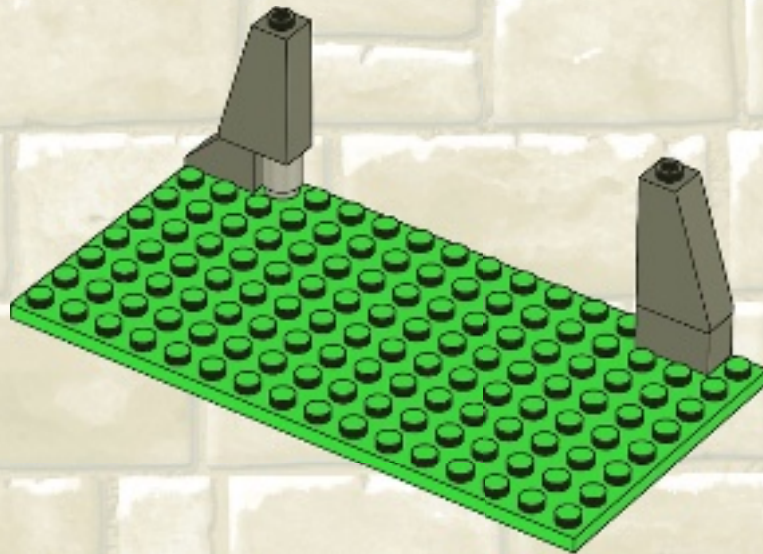

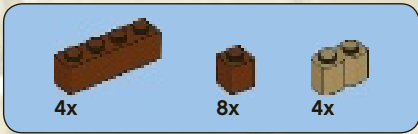

# 4

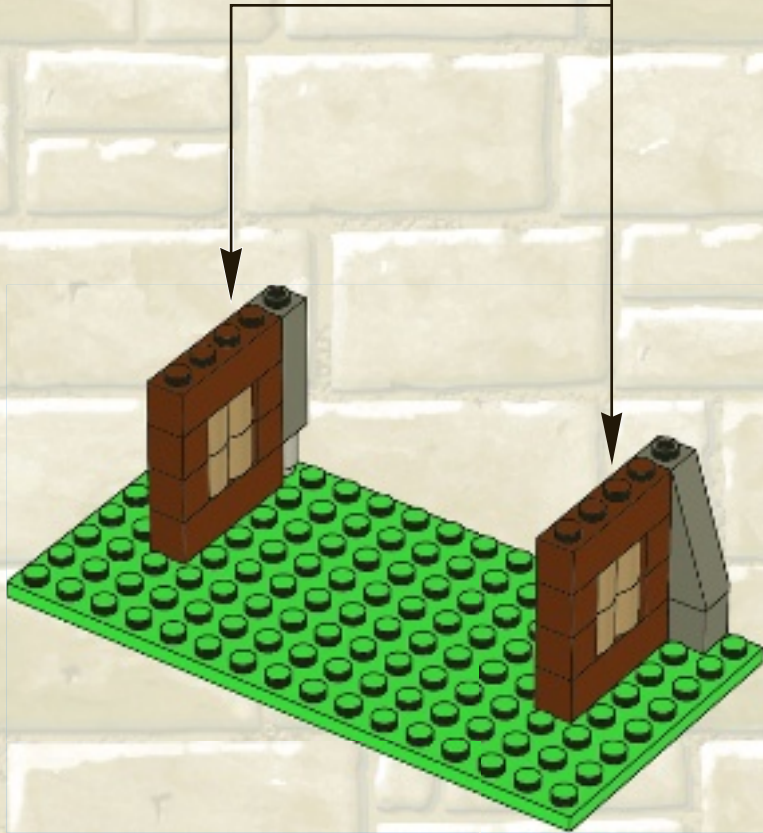
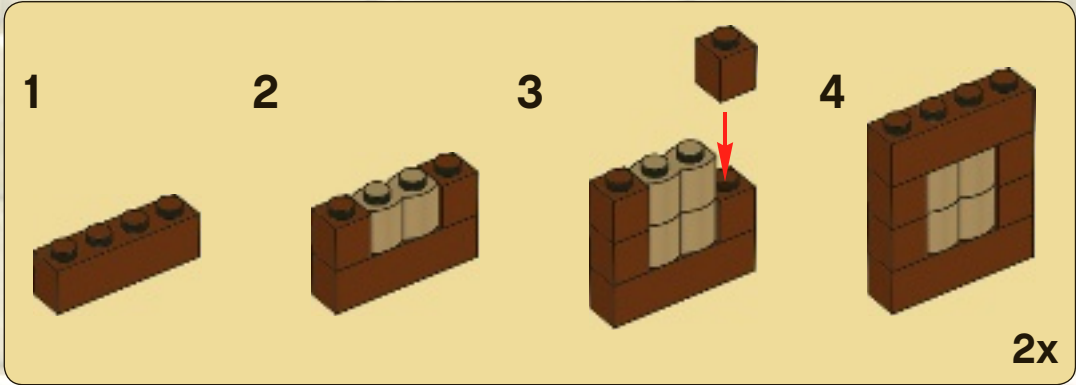





5

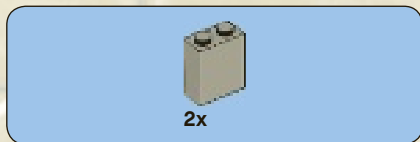
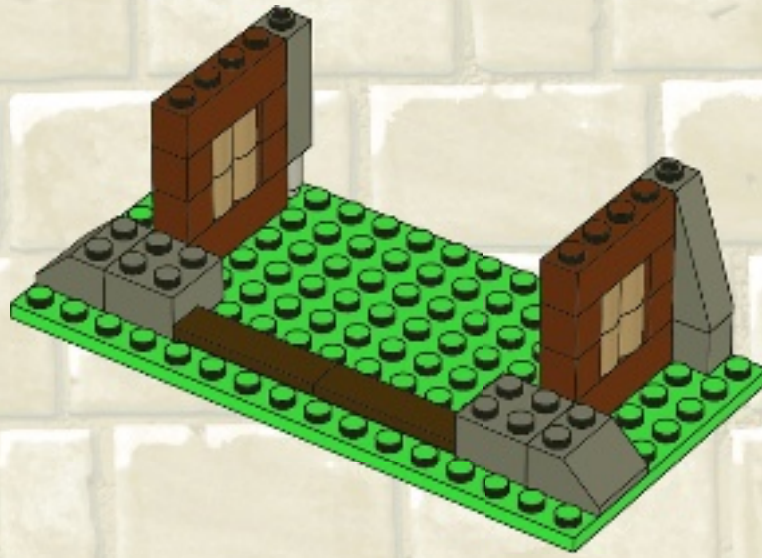

6

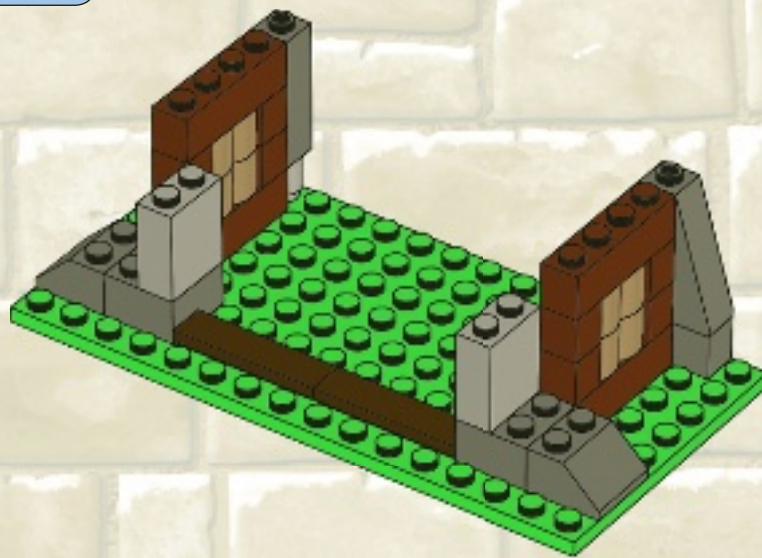



2x



2x

7

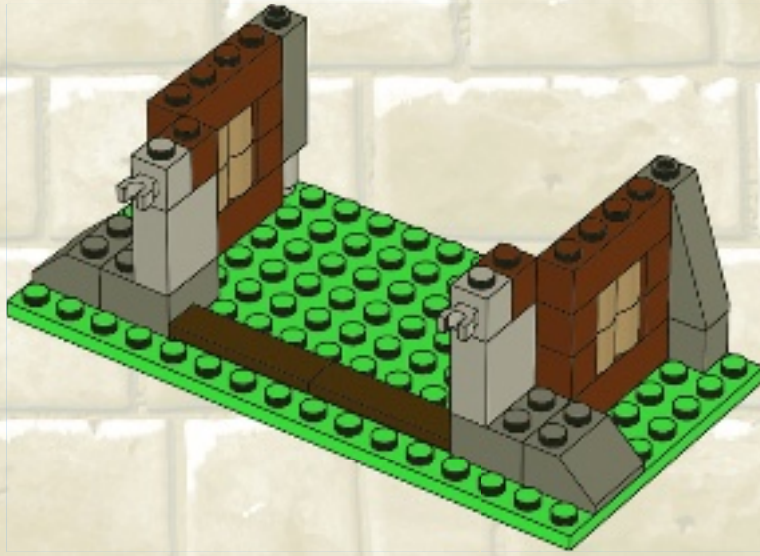

2x

8

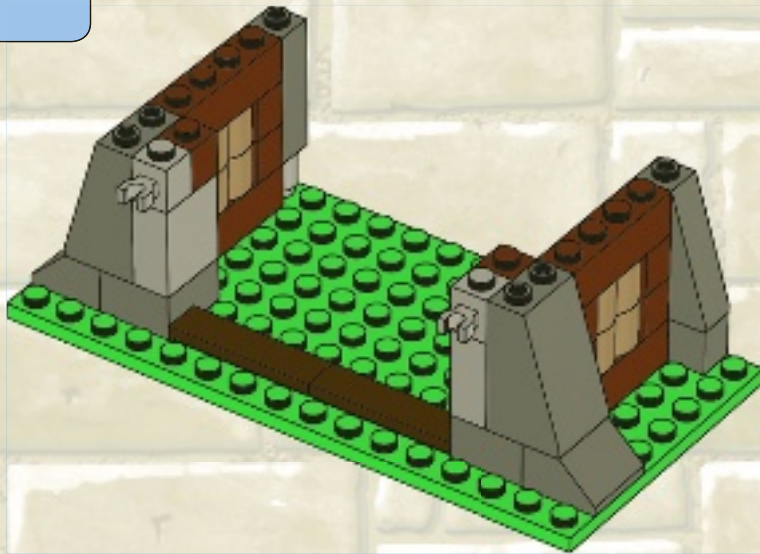





4x

9

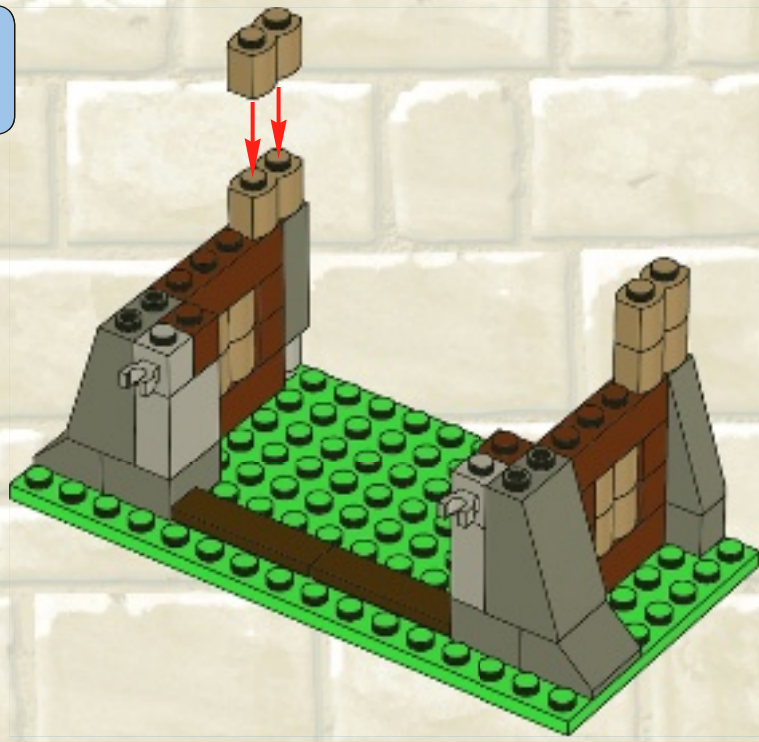

2x



2x

10

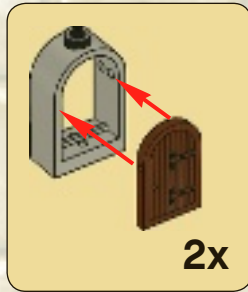

2x

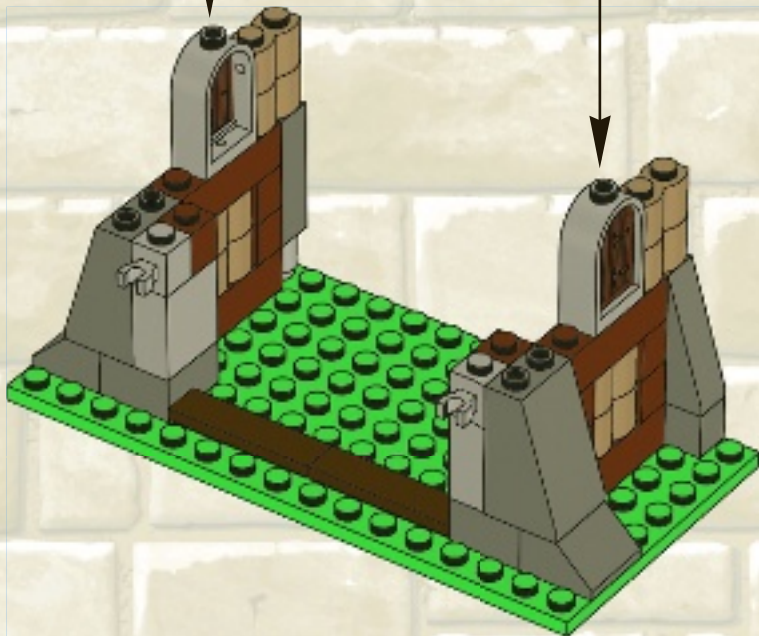



2x

11

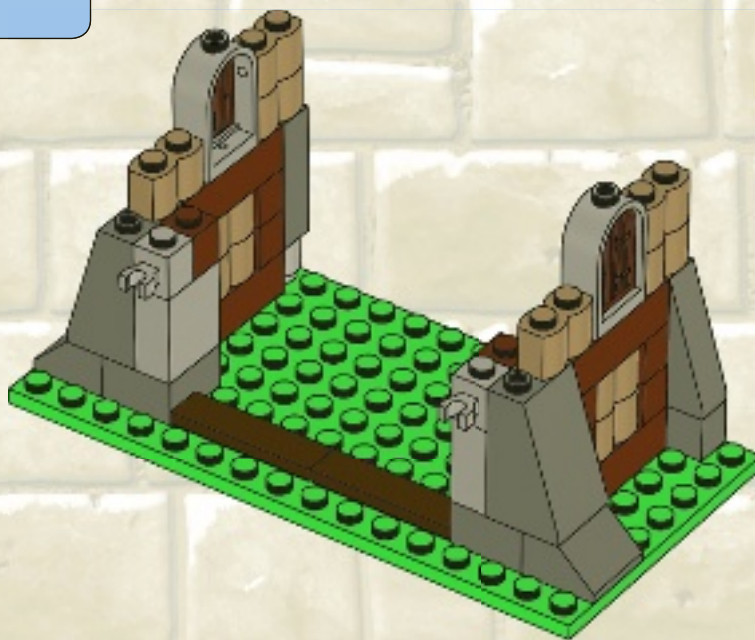

2x

12

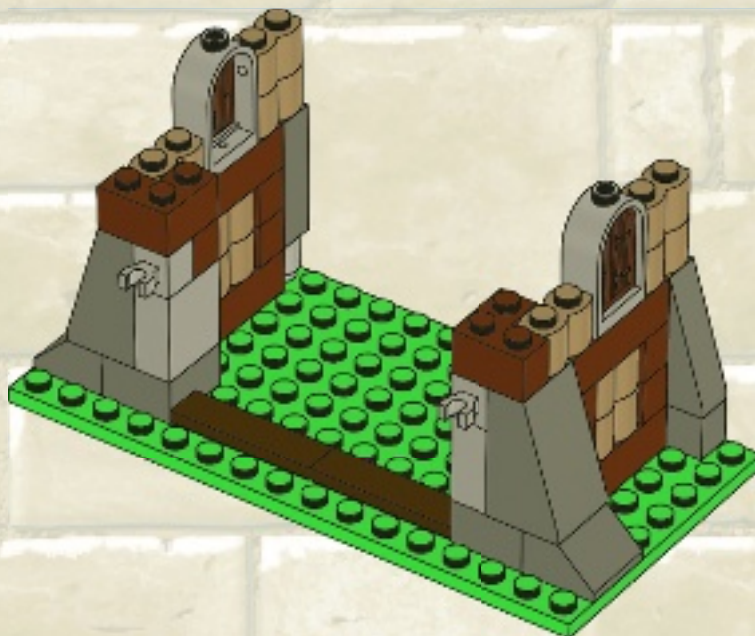





2x



2x

# 13

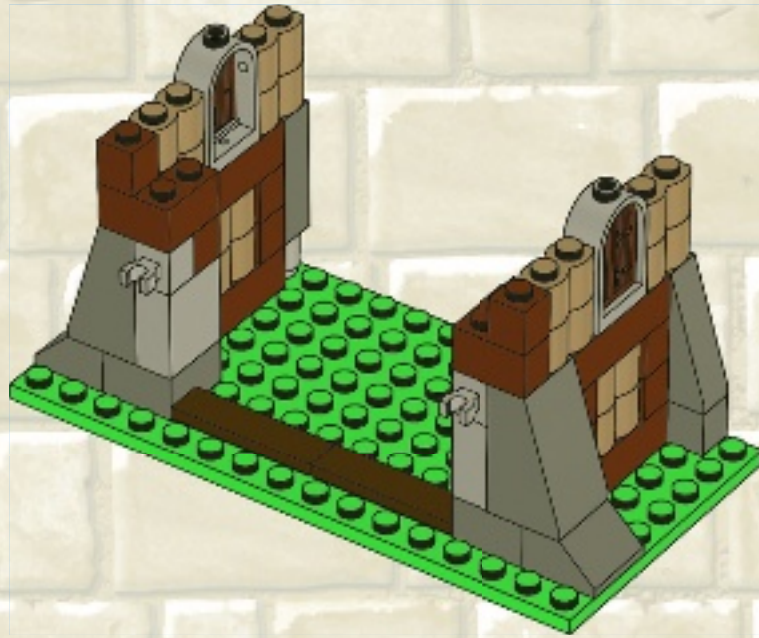

2x

# 14

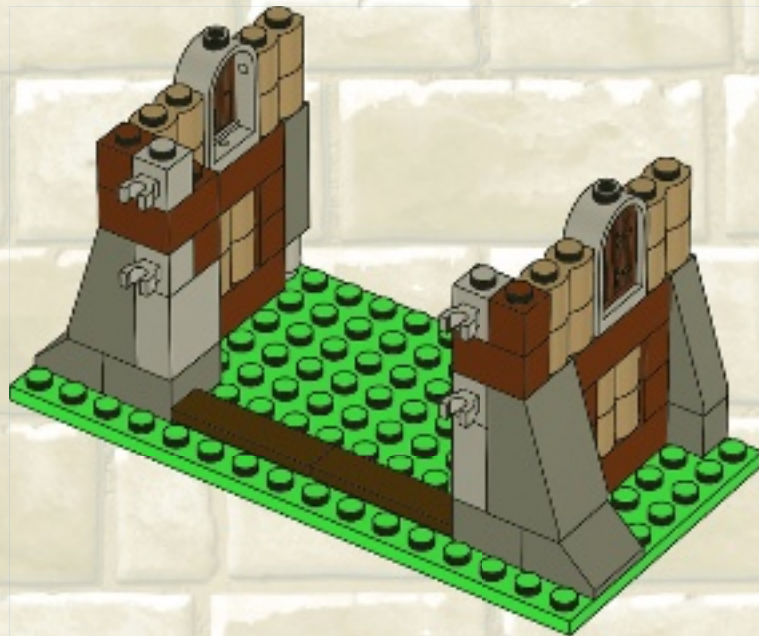



2x

15

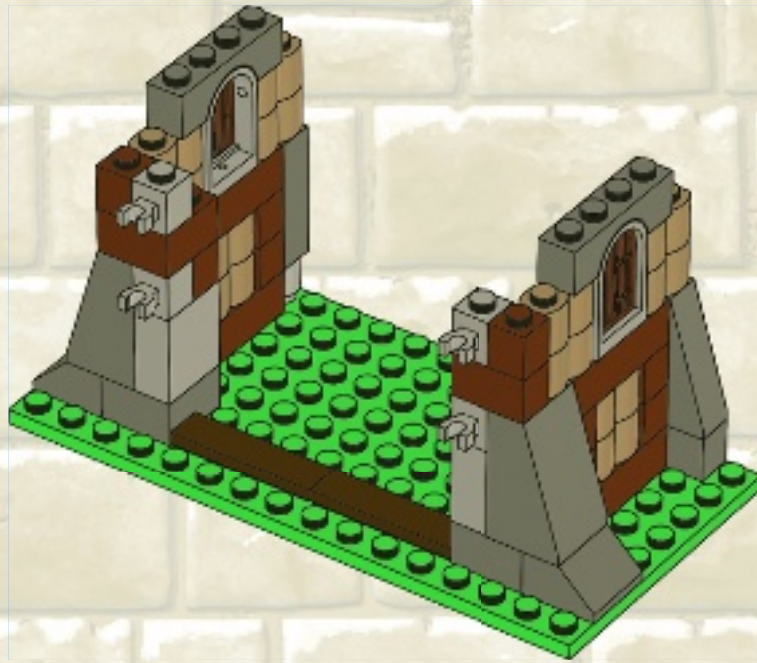

2x

16

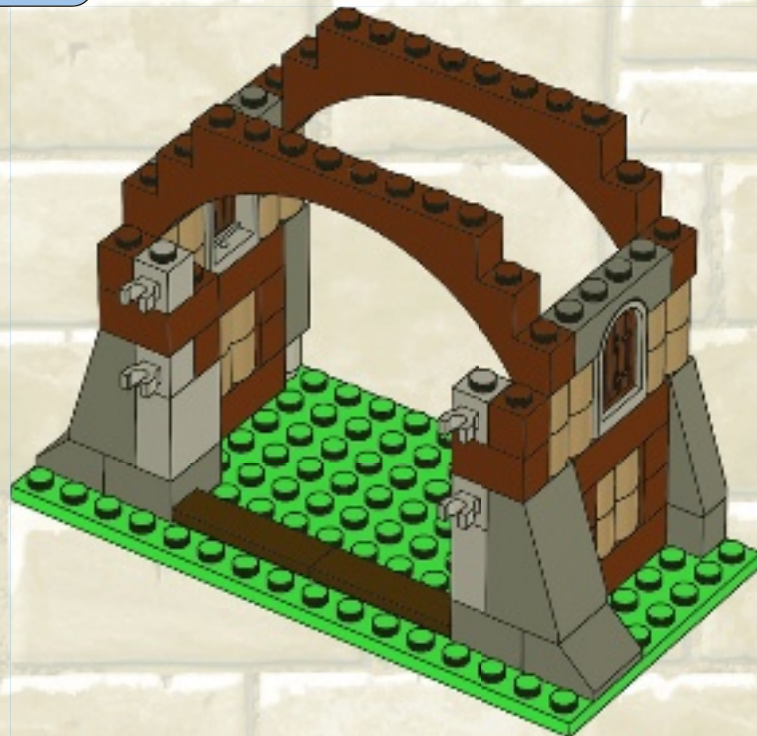





2x

17

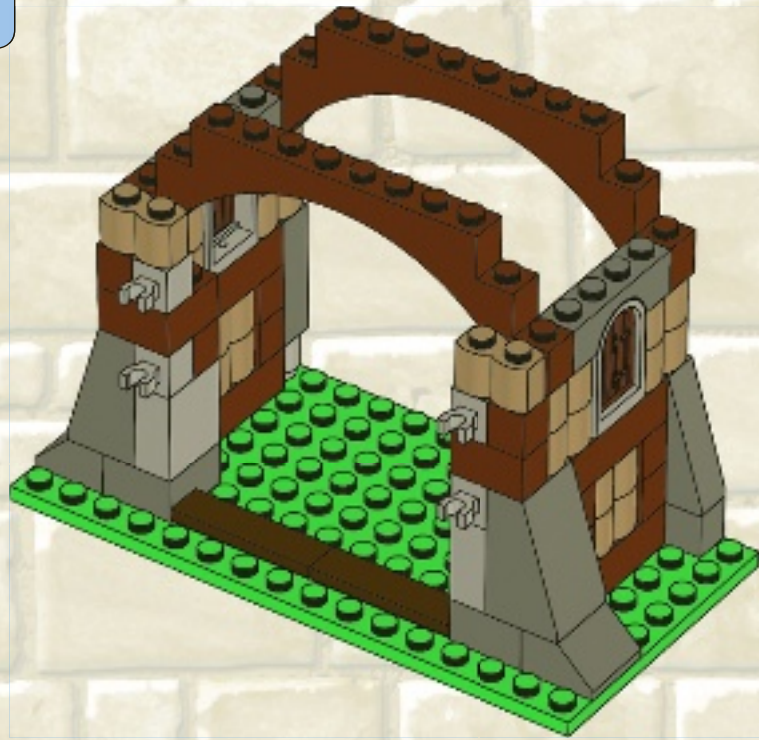

2x

18

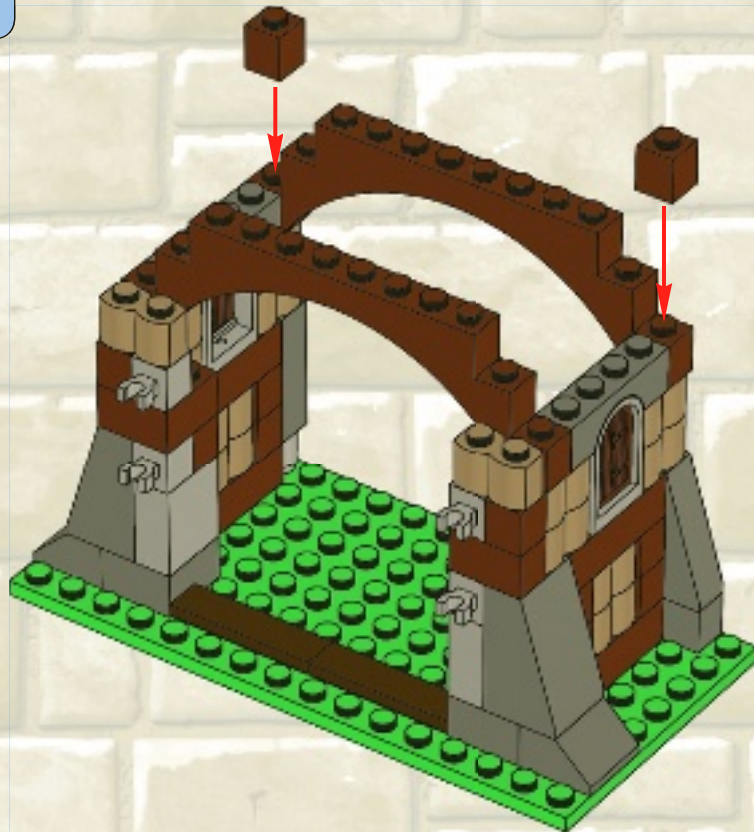



4x

19

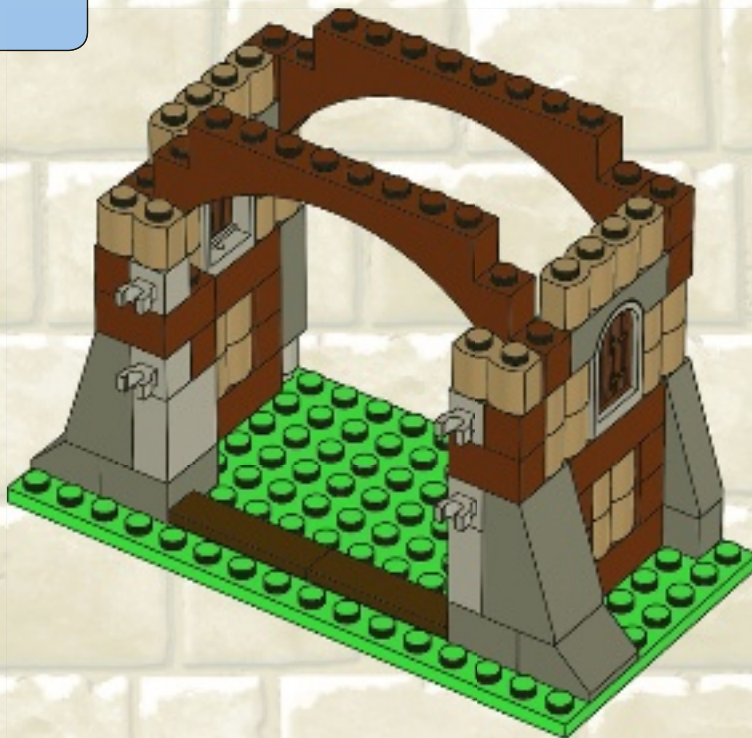

2x

20

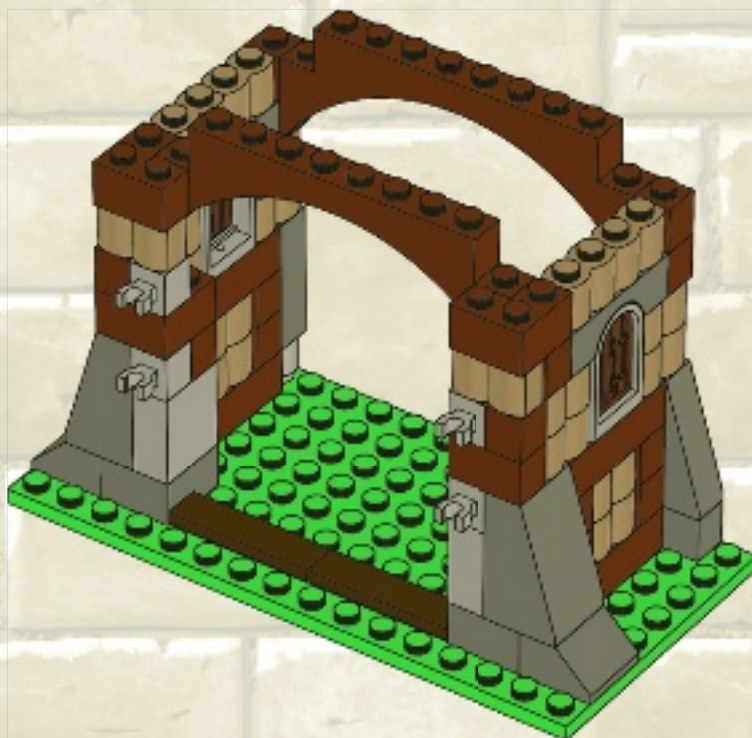





4x

21

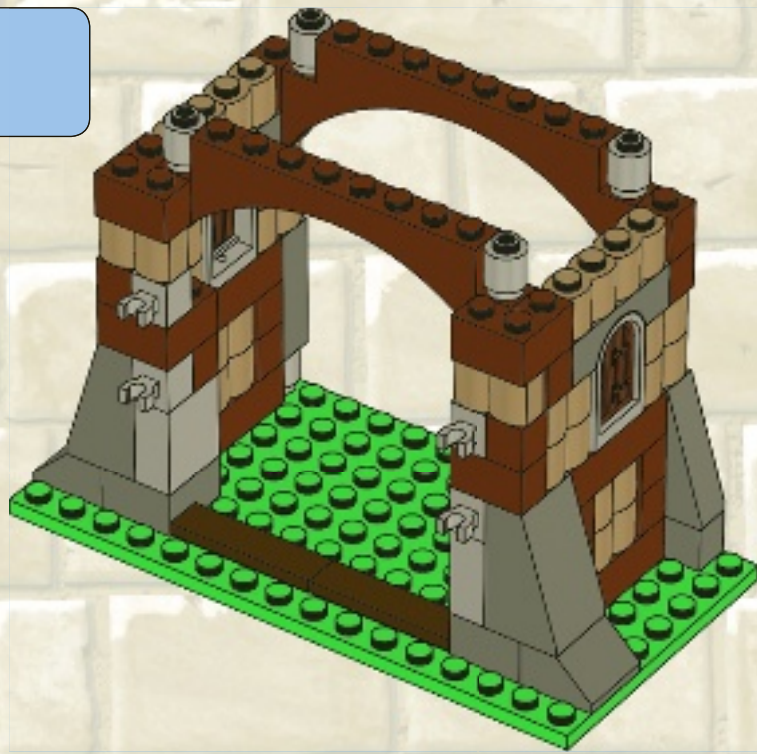

2x



1x

22

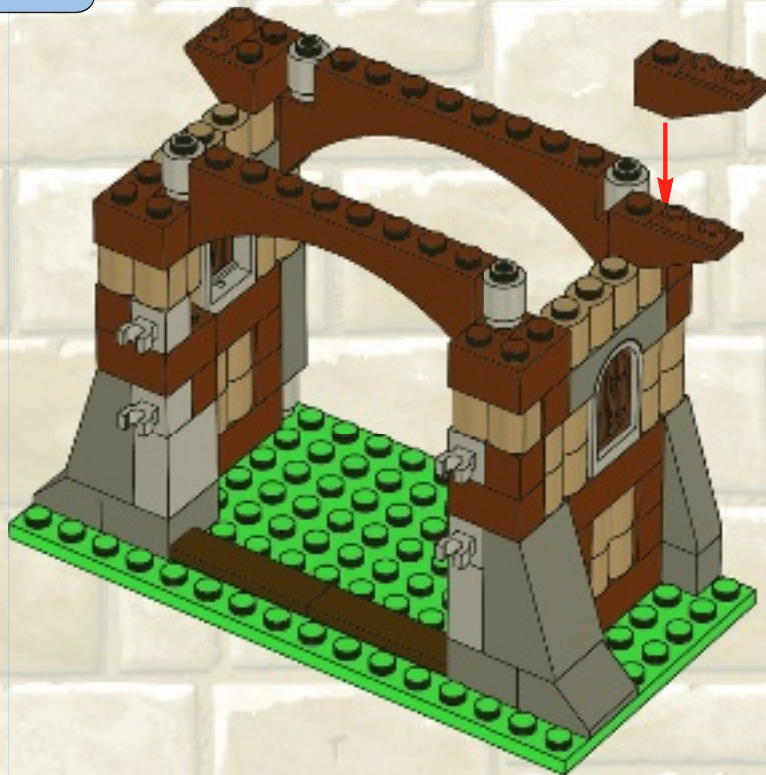

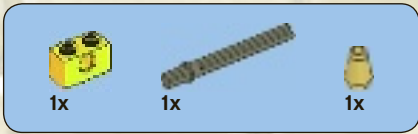

# 23

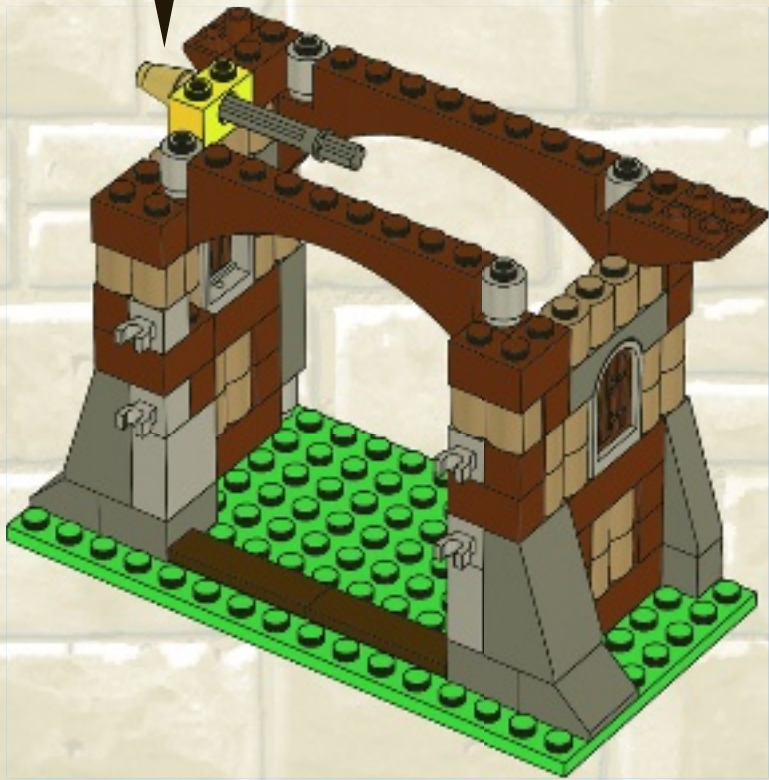
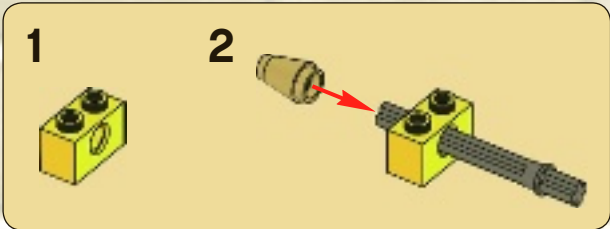



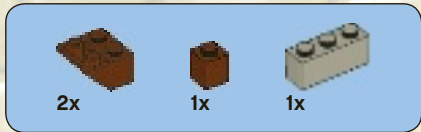

24

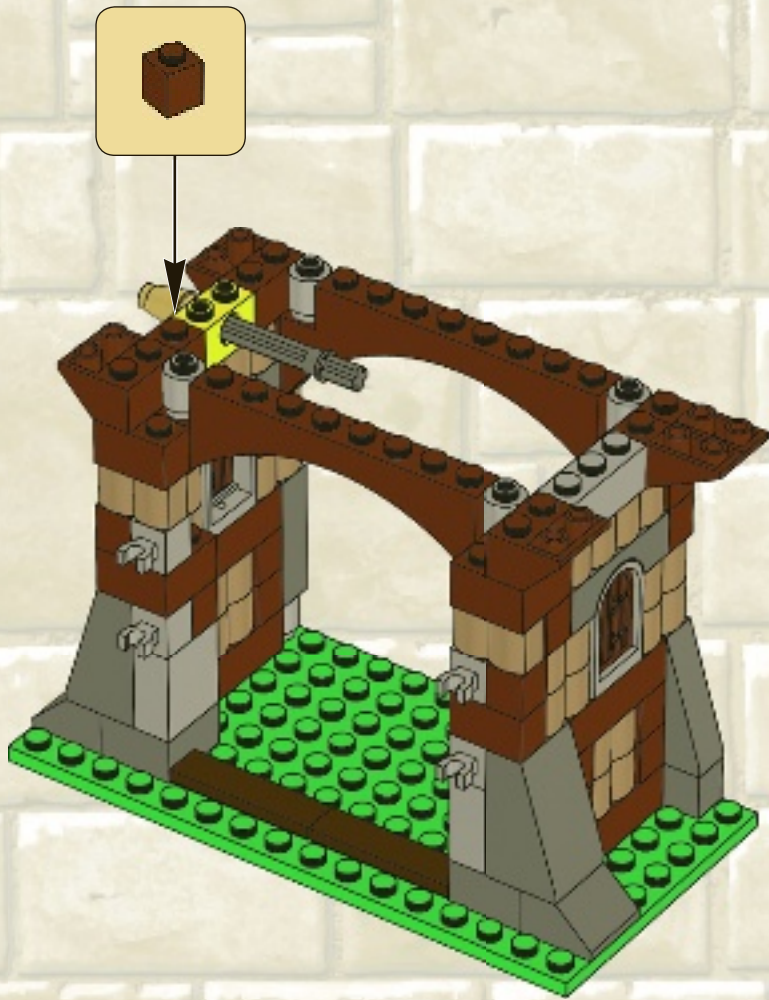

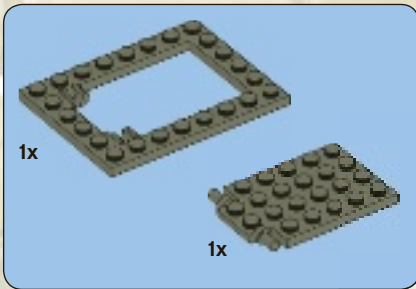

25

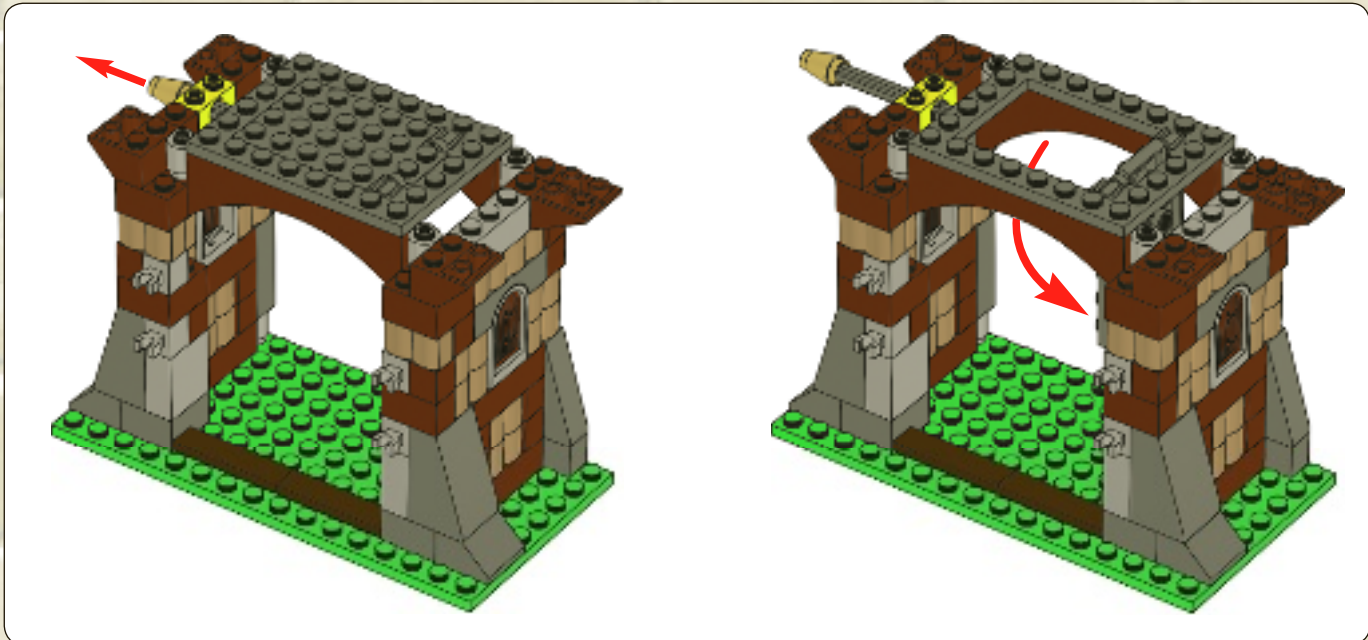
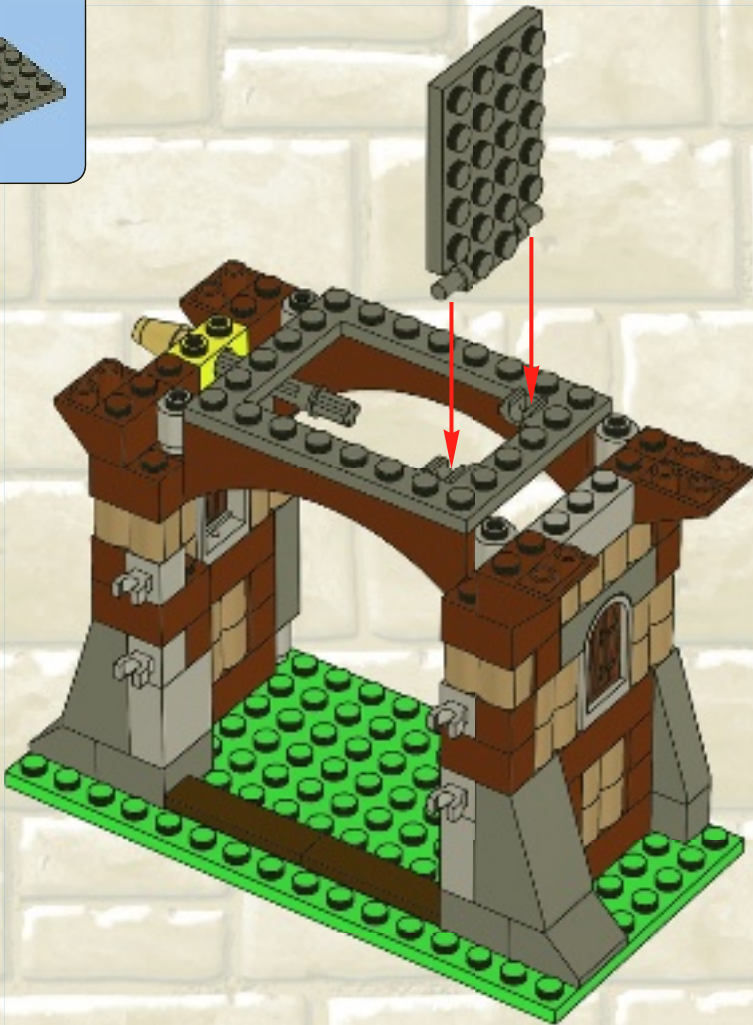



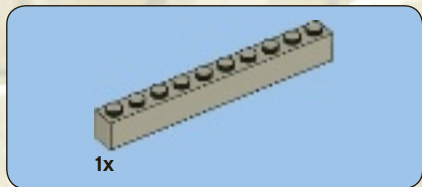

26

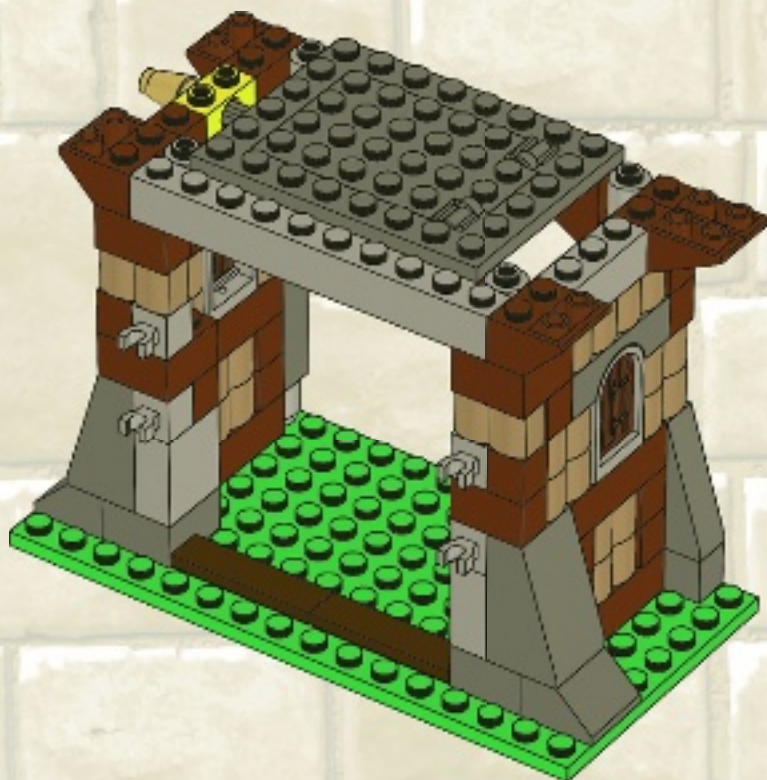

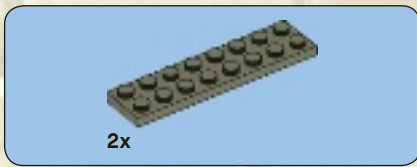

27

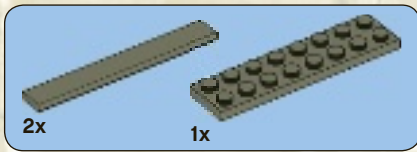
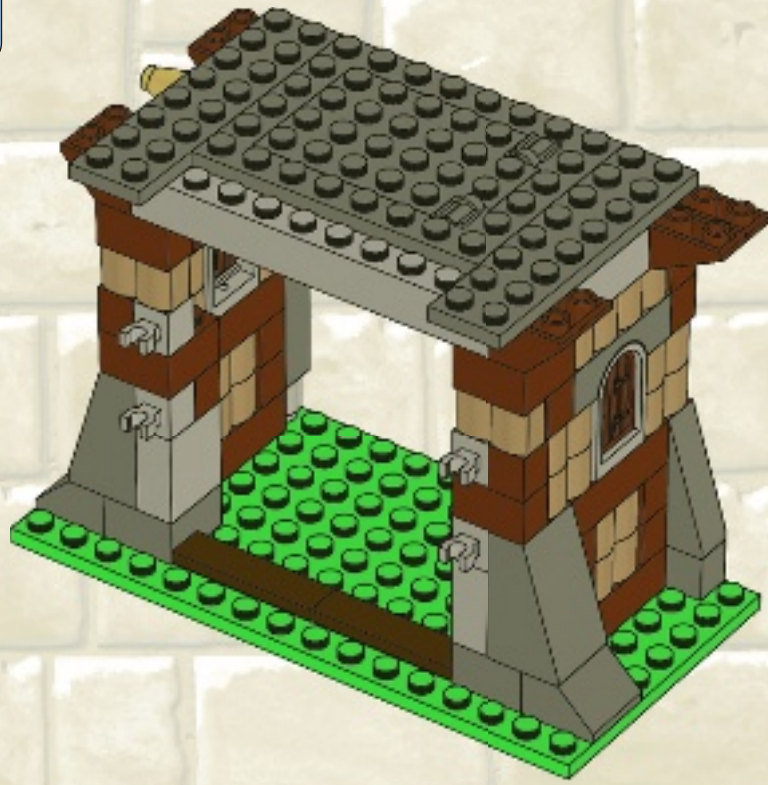

28





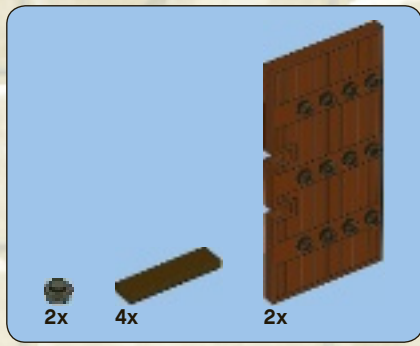

# 29

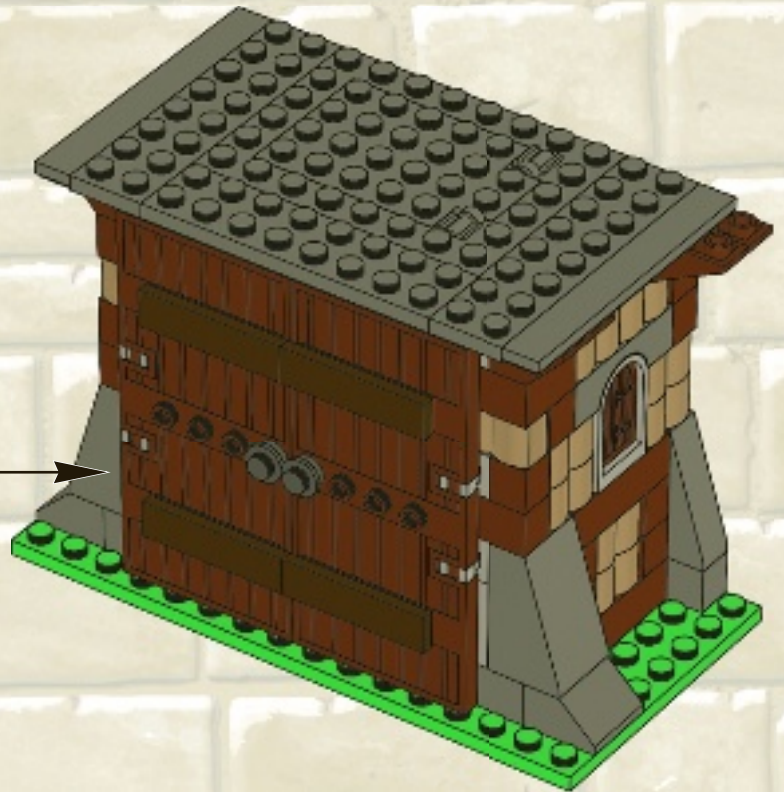
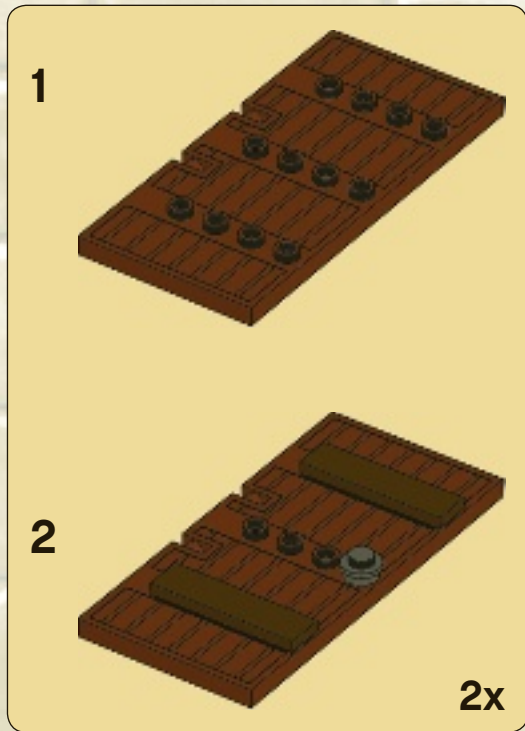



4x

30



4x

31





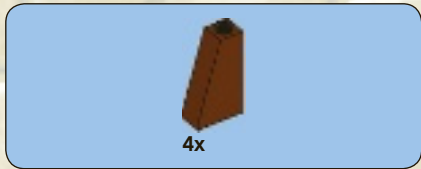

32



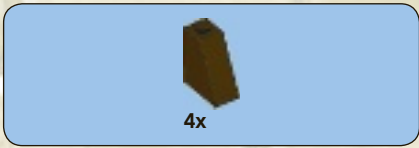

33





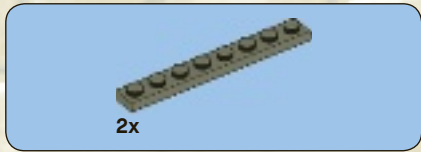

34



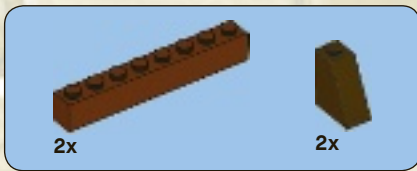

35







2x

# 36



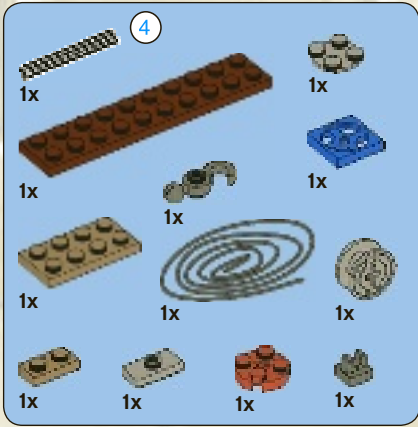
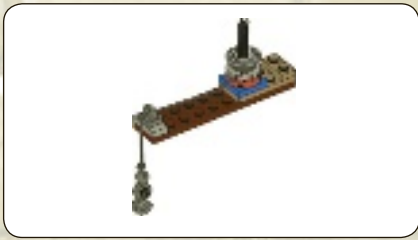

# 37

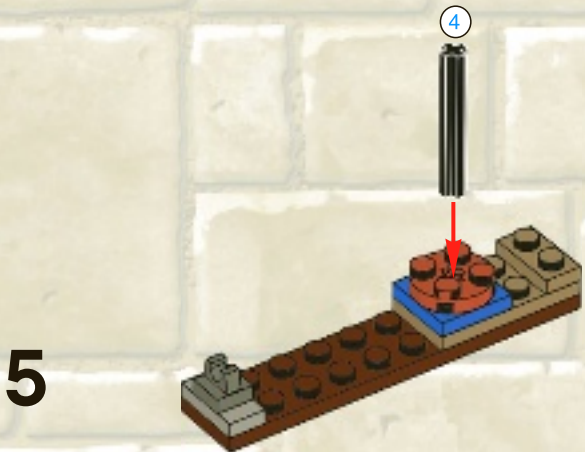
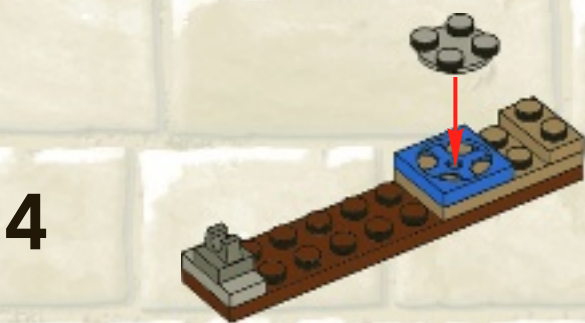



1



2



3



6

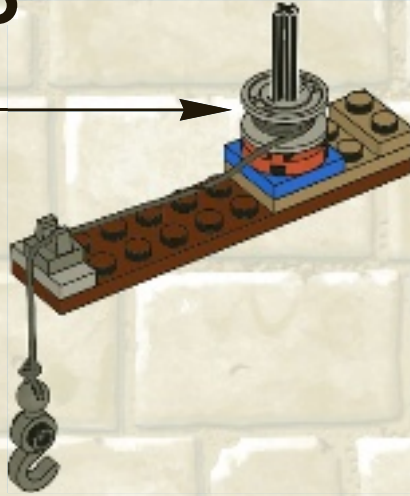



38







2x

# 39

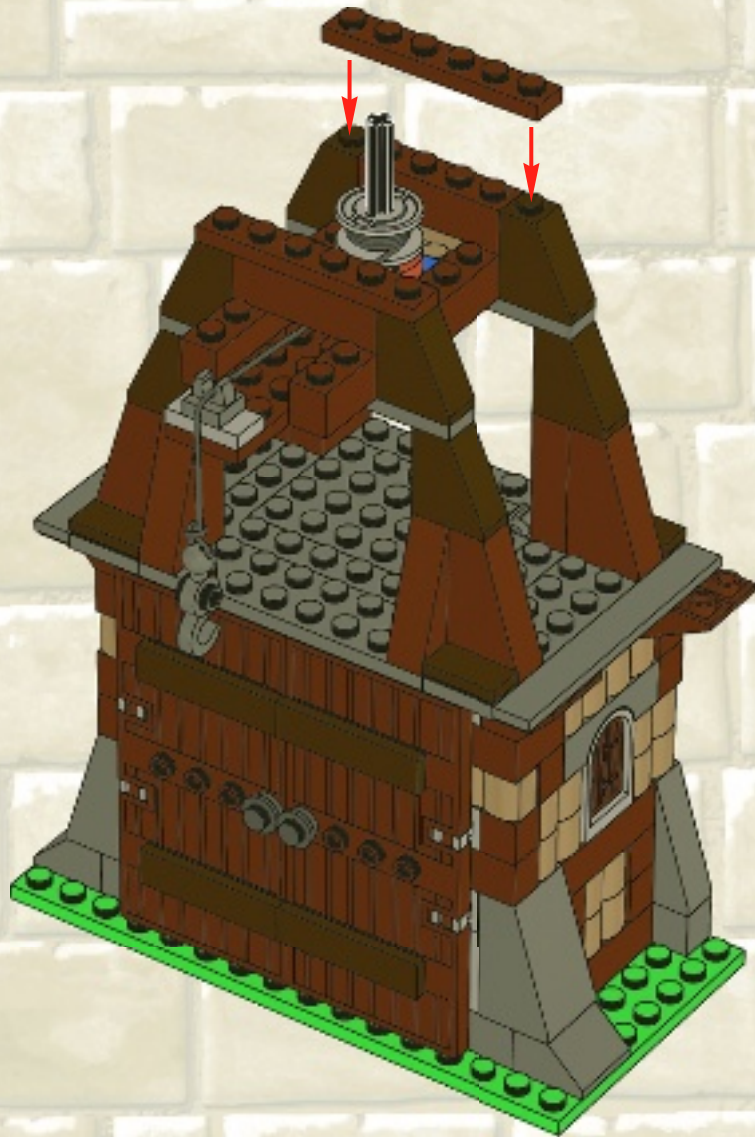

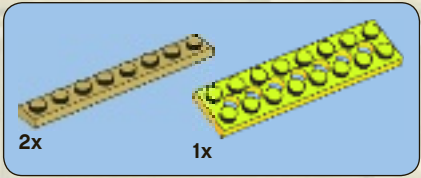

1

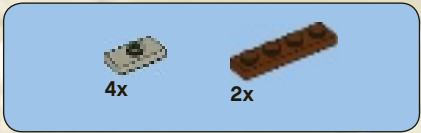
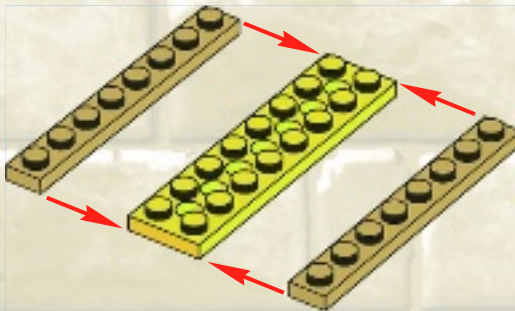

2

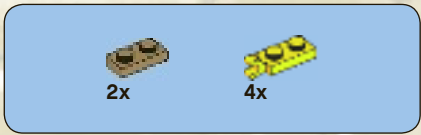
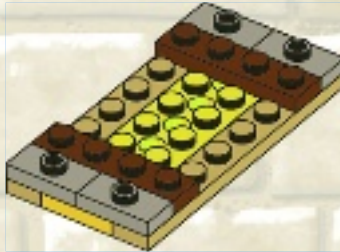

3

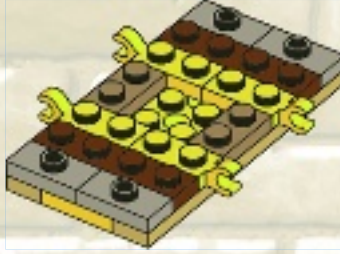





40

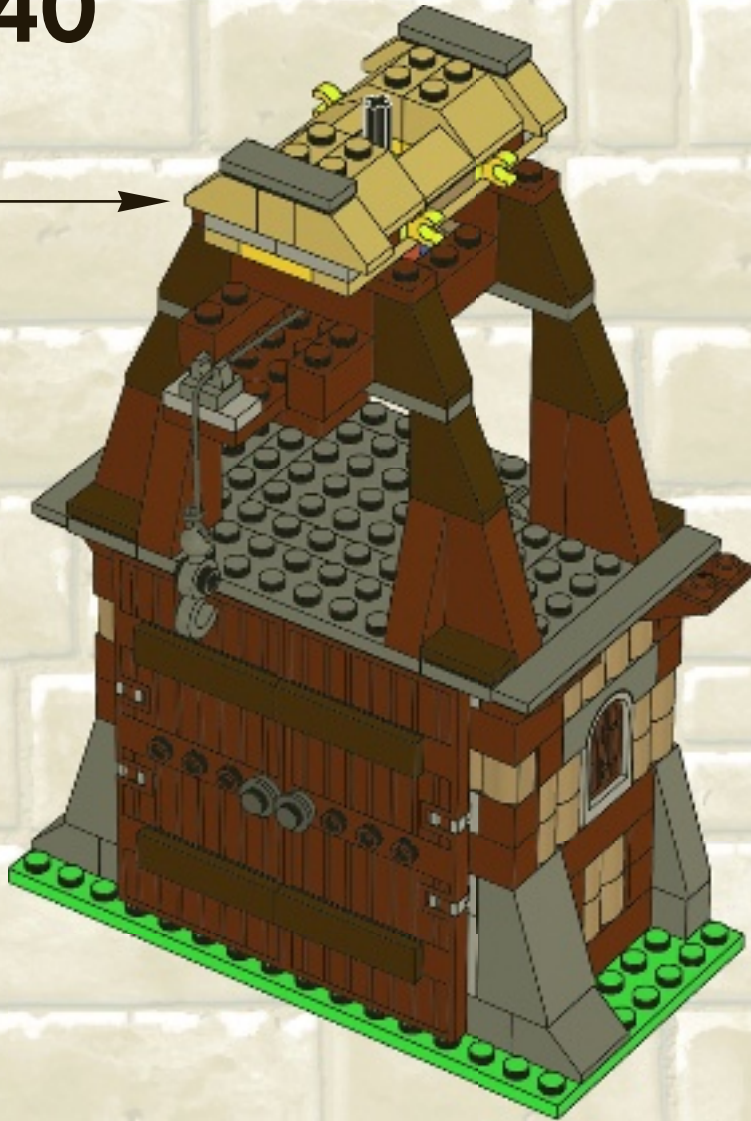



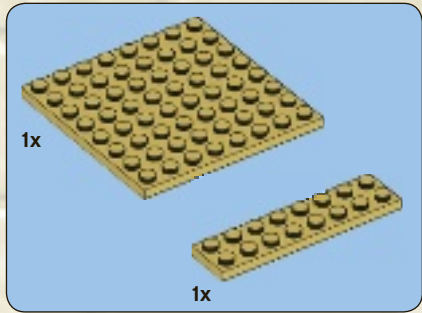

1

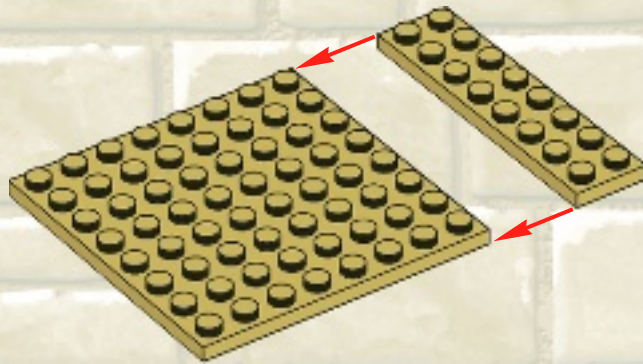

2

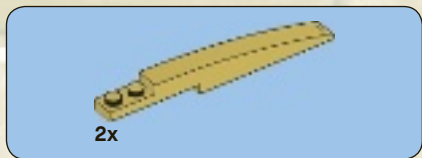
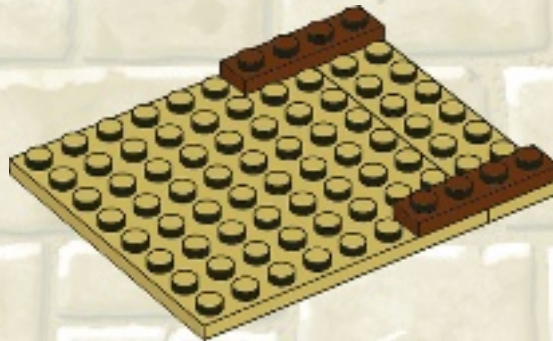

3

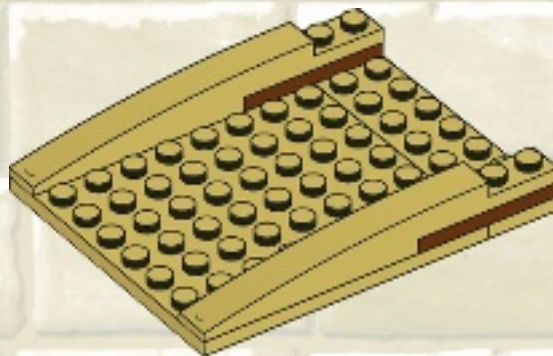

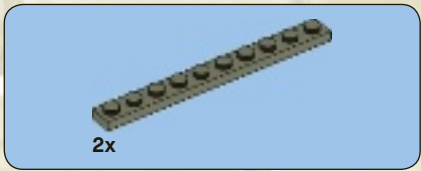

4

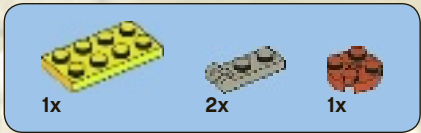
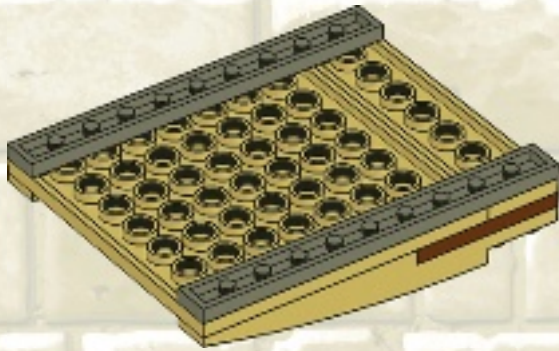

5

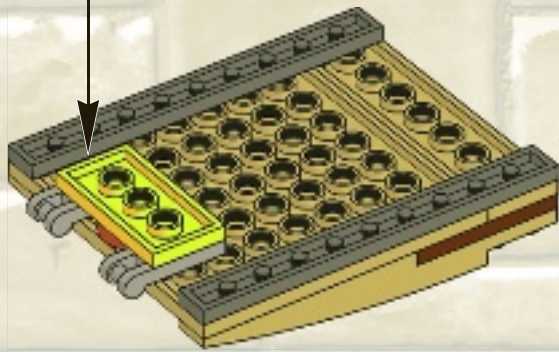



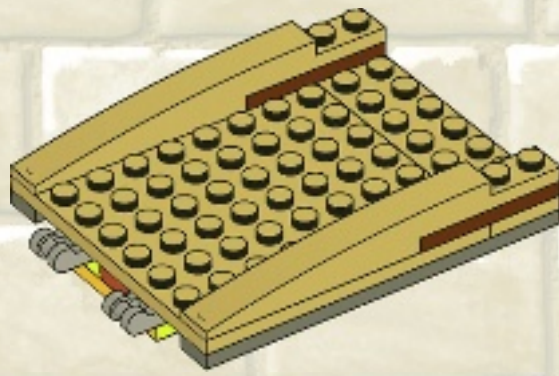
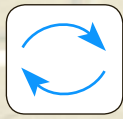

**2x**

**41**

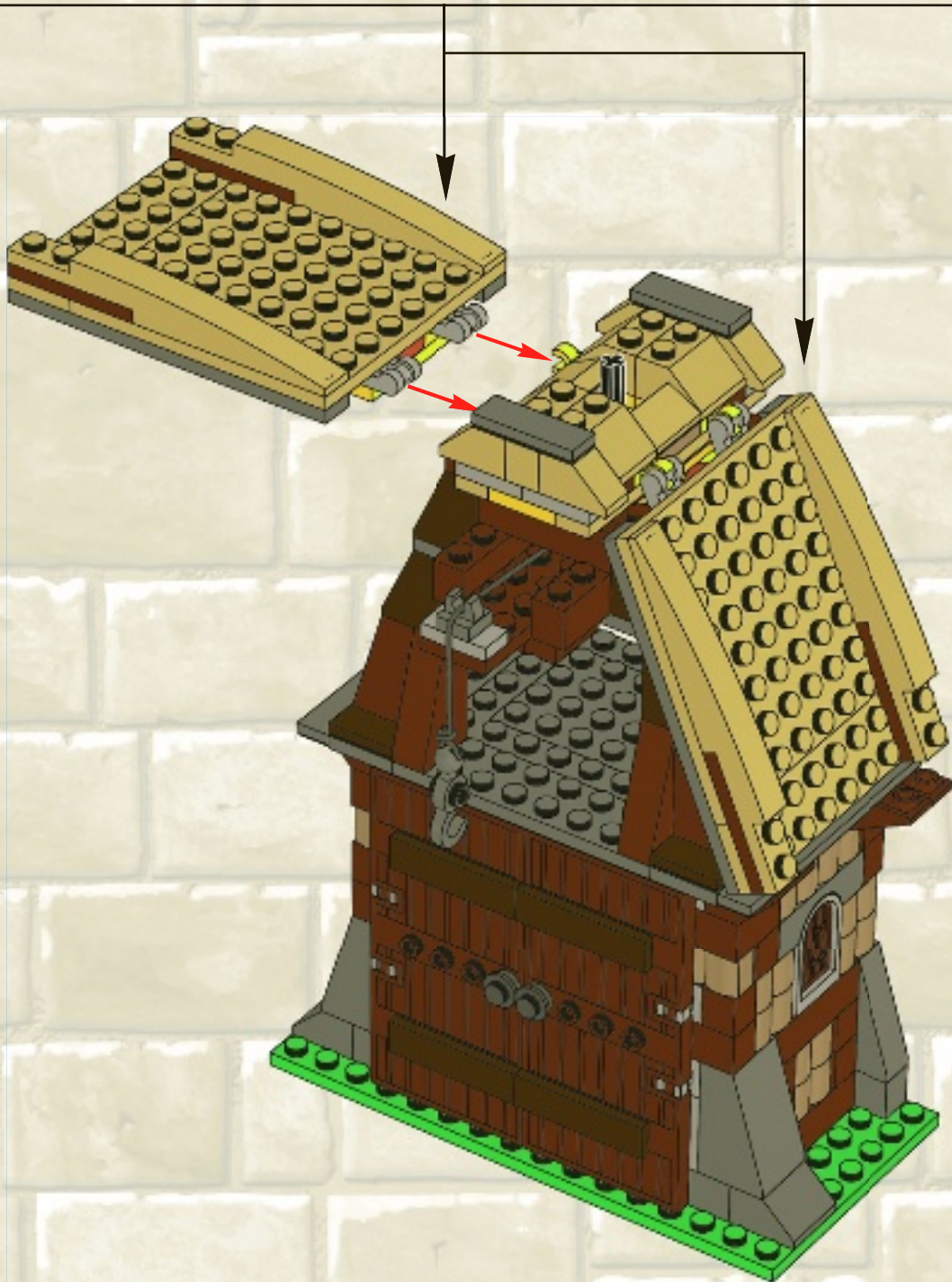





# 42

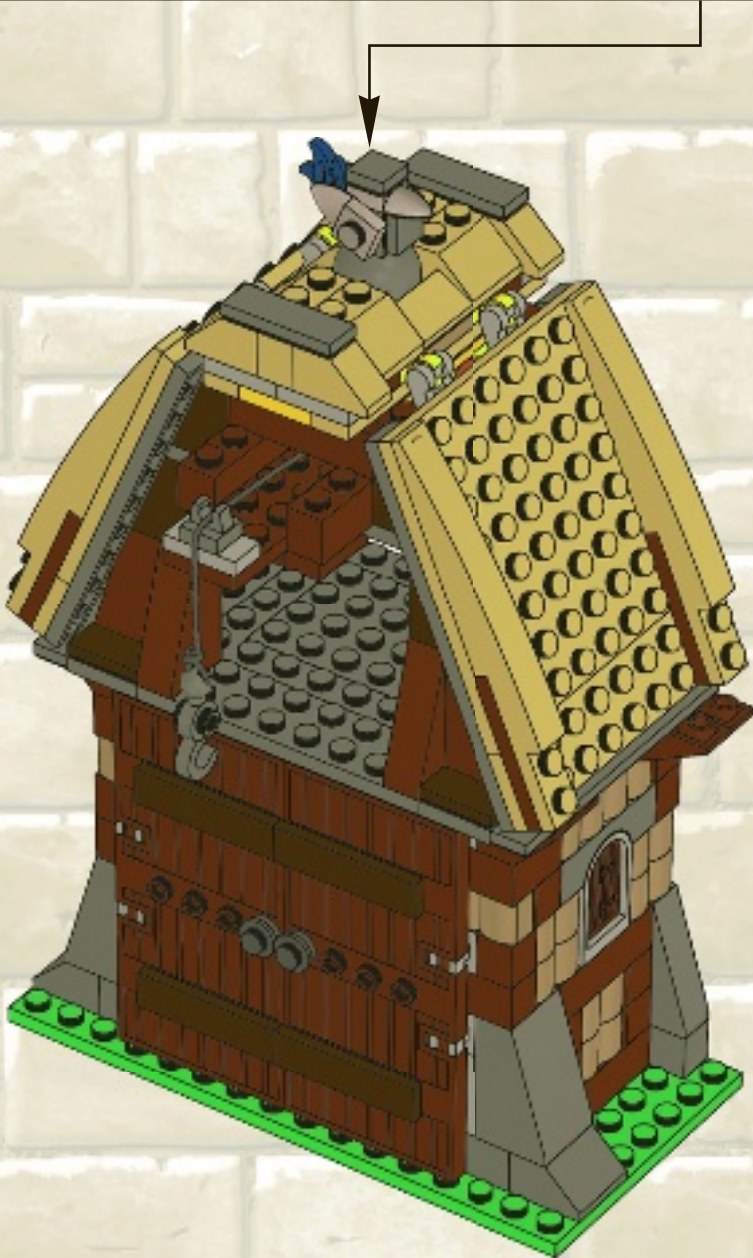
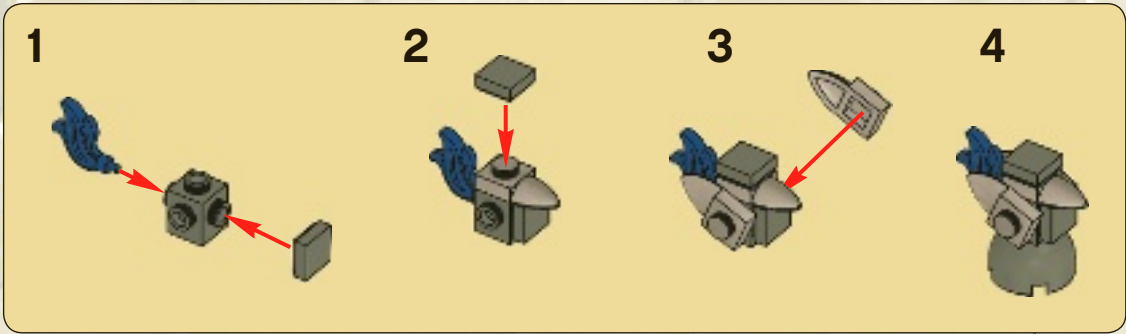





# 43

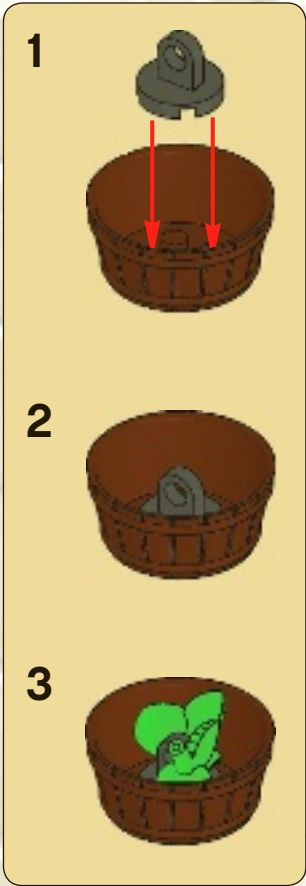



# 44

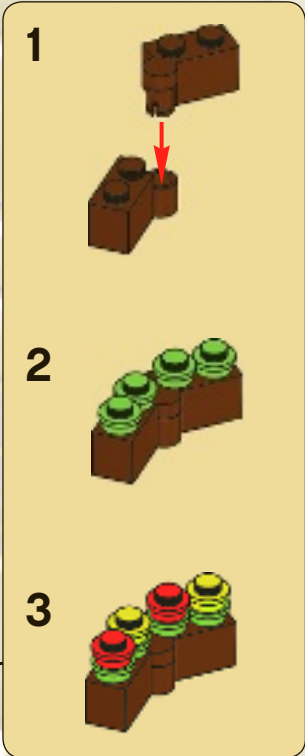



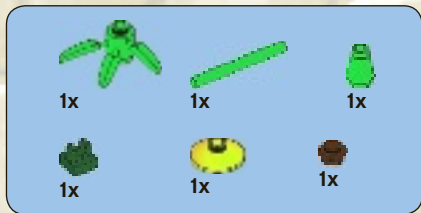

# 45

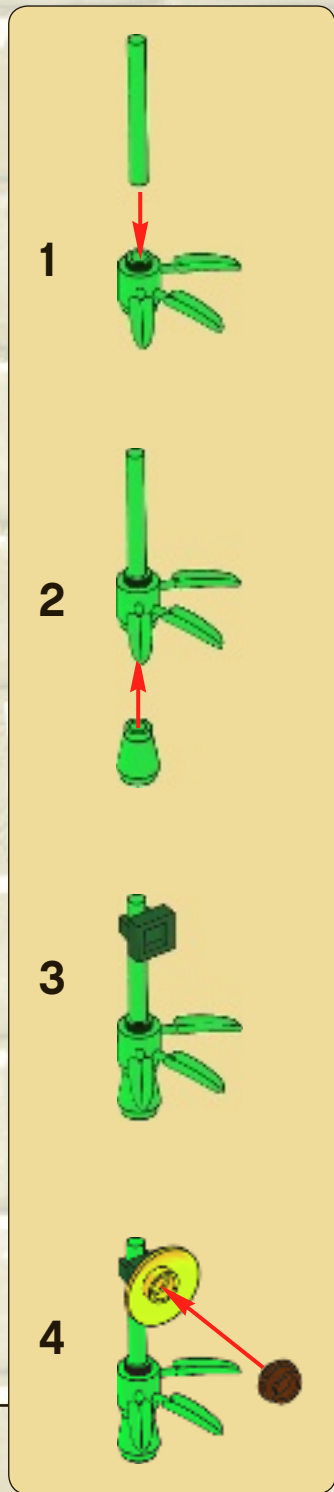



46







1x

47

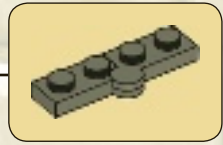



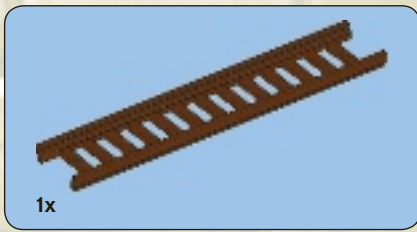

48





49







# UNIVERSE

MASSIVELY MULTIPLAYER  
ONLINE GAME

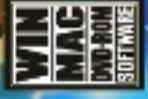

MEHRSPIELER ONLINE SPIEL  
VIDEOJUEGO MULTIJUGADOR MASIVO EN LÍNEA  
JEU EN LIGNE MASSIVEMENT MULTJOUEUR  
JOGO MULTIJOGADOR ONLINE EM MASSA  
NAGYON SOK SZEREPLŐS ONLINE JATEK

[www.LEGOuniverse.com](http://www.LEGOuniverse.com)

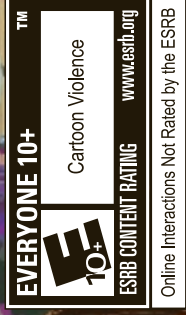





1x  
4623498

1x  
4623981

1x  
4186017

4x  
4113915

1x  
4529237

8x  
4121972

10x  
4624086

10x  
4114322

1x  
4141533

1x  
4114073

8x  
4624087

2x  
4114324

6x  
4113988

4x  
4624223

2x  
4624185

1x  
4624216

2x  
4526982

9x  
4616027

1x  
4585175

1x  
4623437

1x  
4623972

5x  
4528604

3x  
4267874

1x  
4624362

1x  
4624282

10x  
4521914

3x  
4247151

41x  
4520257

12x  
4530678

1x  
4529239

1x  
4566177

1x  
4114348

2x  
4107050

2x  
4610353

2x  
4586334

1x  
4211758

3x  
4512360

8x  
4533772

19x  
4211412

2x  
4211526

2x  
4211535

2x  
4211398

9x  
4211451

4x  
4244627

1x  
4211376

12x  
4515369

6x  
4523353

4x  
4215513

2x  
4540203

1x  
4521532

1x  
4211388

1x  
4548676

4x  
4183133

3x  
306201

2x  
4623959

1x  
368001

1x  
4515351

2x  
4211564

3x  
4211428

1x  
4211521

1x  
4623489

16x  
4624089

8x  
4566688

11x  
4536989

1x  
4536677

1x  
4538950

1x  
4540850

3x  
4625146

1x  
4548676

4x  
4183133

3x  
306201

2x  
4623959

1x  
368001

1x  
70501

2x  
614121

2x  
4227155

1x  
368023

2x  
4206482

3x  
300324

1x  
370024

2x  
4141630

8x  
4535740

2x  
614124

1x  
4169960

1x  
4539511

1x  
4528206

1x  
4623413

1x  
4623416

1x  
4623930

5x  
4239601

4x  
302024

1x  
4624216

2x  
4248204

1x  
4563681

2x  
4253815

1x  
302026

1x  
4563044

4x  
4598528

1x  
4569733

4x  
4556158

1x  
292626

6x  
614126

1x  
237626

3x  
3004626

3x  
9339

1x  
4517986

1x  
373826

1x  
383226

1x  
4584350

4x  
370526

1x  
373726

4x  
370526

1x  
373726

1x  
4584350

4x  
370526

1x  
373726

1x  
4584350

4x  
370526

1x  
373726

1x  
4584350

4x  
370526

1x  
373726

1x  
4584350

4x  
370526

1x  
373726

1x  
4584350

4x  
370526

1x  
373726

1x  
4584350

4x  
370526

1x  
373726

1x  
4584350

4x  
370526

1x  
373726

1x  
4584350

4x  
370526

1x  
373726

1x  
4584350

4x  
370526

1x  
373726

1x  
4584350

4x  
370526

1x  
373726

1x  
4584350

4x  
370526

1x  
373726

1x  
4584350

4x  
370526

1x  
373726

1x  
4584350

4x  
370526

1x  
373726

1x  
4584350

4x  
370526

1x  
373726

1x  
4584350

4x  
370526

1x  
373726

1x  
4584350

4x  
370526

1x  
373726

1x  
4584350

4x  
370526

1x  
373726

1x  
4584350

4x  
370526

1x  
373726

1x  
4584350

4x  
370526

1x  
373726

1x  
4584350

4x  
370526

1x  
373726

1x  
4584350

4x  
370526

1x  
373726

1x  
4584350

4x  
370526

1x  
373726

1x  
4584350

4x  
370526

1x  
373726

1x  
4584350

4x  
370526

1x  
373726

1x  
4584350

4x  
370526

1x  
373726

1x  
4584350

4x  
370526

1x  
373726

1x  
4584350

4x  
370526

1x  
373726

1x  
4584350

4x  
370526

1x  
373726

1x  
4584350

4x  
370526

1x  
373726

1x  
4584350

4x  
370526

1x  
373726

1x  
4584350

4x  
370526

1x  
373726

1x  
4584350

4x  
370526

1x  
373726

1x  
4584350

4x  
370526

1x  
373726

1x  
4584350

4x  
370526

1x  
373726

1x  
4584350

4x  
370526

1x  
373726

1x  
4584350

4x  
370526

1x  
373726

1x  
4584350

4x  
370526

1x  
373726

1x  
4584350

4x  
370526

1x  
373726

1x  
4584350

4x  
370526

1x  
373726

1x  
4584350

4x  
370526

1x  
373726

1x  
4584350

4x  
370526

1x  
373726

1x  
4584350

4x  
370526

1x  
373726

1x  
4584350

4x  
370526

1x  
373726

1x  
4584350

4x  
370526

1x  
373726

1x  
4584350

4x  
370526

1x  
373726

1x  
4584350

4x  
370526

1x  
373726

1x  
4584350

4x  
370526

1x  
373726

1x  
4584350

4x  
370526

1x  
373726

1x  
4584350

4x  
370526

1x  
373726

1x  
4584350

4x  
370526

1x  
373726

1x  
4584350

4x  
370526

1x  
373726

1x  
4584350

4x  
370526

1x  
373726

1x  
4584350

4x  
370526

1x  
373726

1x  
4584350

4x  
370526

1x  
373726

1x  
4584350

4x  
370526

1x  
373726

1x  
4212529

18x  
4211098

5x  
4211088

4x  
4211060

1x  
4210700

1x  
4161674

1x  
4211069

2x  
4211111

2x  
4211135

4x  
4221745

4x  
4210696

5x  
4211054

6x  
4210999

5x  
4620760

2x  
4210848

4x  
4211052

4x  
4568734

4x  
4211056

1x  
4558959

1x  
4271344

1x  
4508553

1x  
4514558

4x  
4210998

4x  
4211008

5x  
4210997

8x  
4257526

1x  
4595710

1x  
4268684

1x  
4595708

1x  
4299022

1x  
421802

1x  
4586499

2x  
4617233

1x  
4617237

1x  
4617248

1x  
4617242

1x  
4617221

2x  
4623941

16x  
4270470

7x  
4211221

4x  
4211195

4x  
4216625

12x  
4211225

5x  
4263776

15x  
4211190

2x  
4211186

4x  
4221590

3x  
4211247

1x  
4271874

6x  
4211211

1x  
4211214

4x  
4584719

2x  
4262974

4x  
4624030

1x  
4211268

1x  
4270443

1x  
4221886

2x  
4624905

2x  
4626197

2x  
4626196

1x  
4495724

1x  
4211160

2x  
4211279

1x  
4252456

1x  
4541875

1x  
4561915

2x  
4561911

1x  
4216581

8x  
4211183

4x  
4520612

1x  
4211166

29x  
4211242

6x  
4211200

2x  
4223303

1x  
4215448

1x  
4215449

6x  
4544525

4x  
4624507

1x  
4612418

2x  
4586500

1x  
4623976

Customer Service  
Kundenservice  
Service Consommateurs  
Servicio Al Consumidor

www.lego.com/service or dial

🇧🇪 🇩🇪 🇫🇷 🇮🇹 🇯🇵 🇰🇷 🇸🇪 🇸🇰 🇺🇰 🇺🇸  
: 00800 5346 5555  
: 1-800-422-5346





www.LEGOclub.com

FREE! GRATIS! GRATUIT!



LEGO® Club Magazine



LEGO® Club Email



www.LEGO.com

LEGO and the LEGO logo are trademarks of the / sont des marques de commerce de / son marcas registradas de LEGO Group. ©2011 The LEGO Group. 4648381

SIGN UP ONLINE!

www.LEGOclub.com

VISIT THE WORLD'S BIGGEST LEGO® SHOP! www.LEGOshop.com

GO TO www.LEGOclub.com

00800 5346 5555



1-866-534-6258 • 1-877-518-5346

US & Canada only

Canada seulement



\* Freephone. Mobile charges may apply. \* Numéro sans frais. Des frais peuvent s'appliquer avec les téléphones cellulaires. \* Gebührenfrei. Kosten für Anrufe aus Mobilfunknetzen können abweichen. \* Gratis telefoonnummer vanaf vaste lijn. \* Det er et gratis nummer, når du ringer fra fasttelefon. \* Det är gratis, när du ringer från en fast telefon. \* Numéro sans frais. Des frais peuvent s'appliquer avec les téléphones portables.