

316

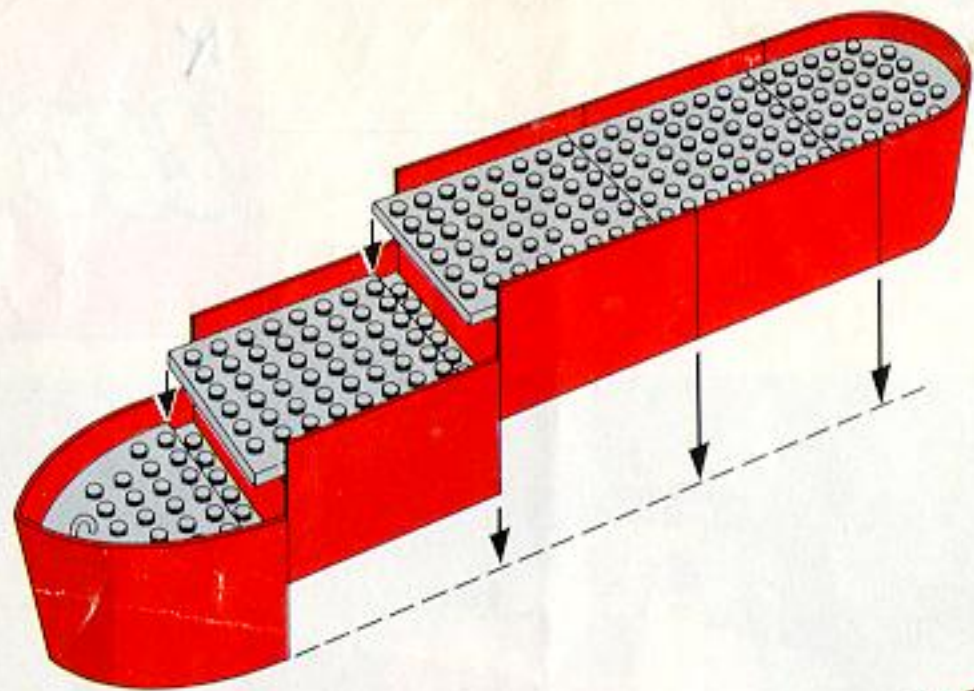

120011



1

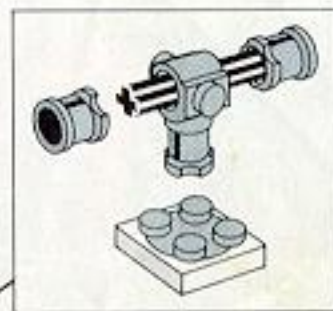
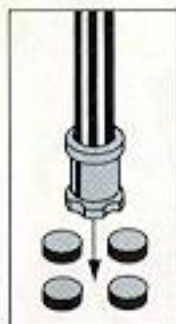
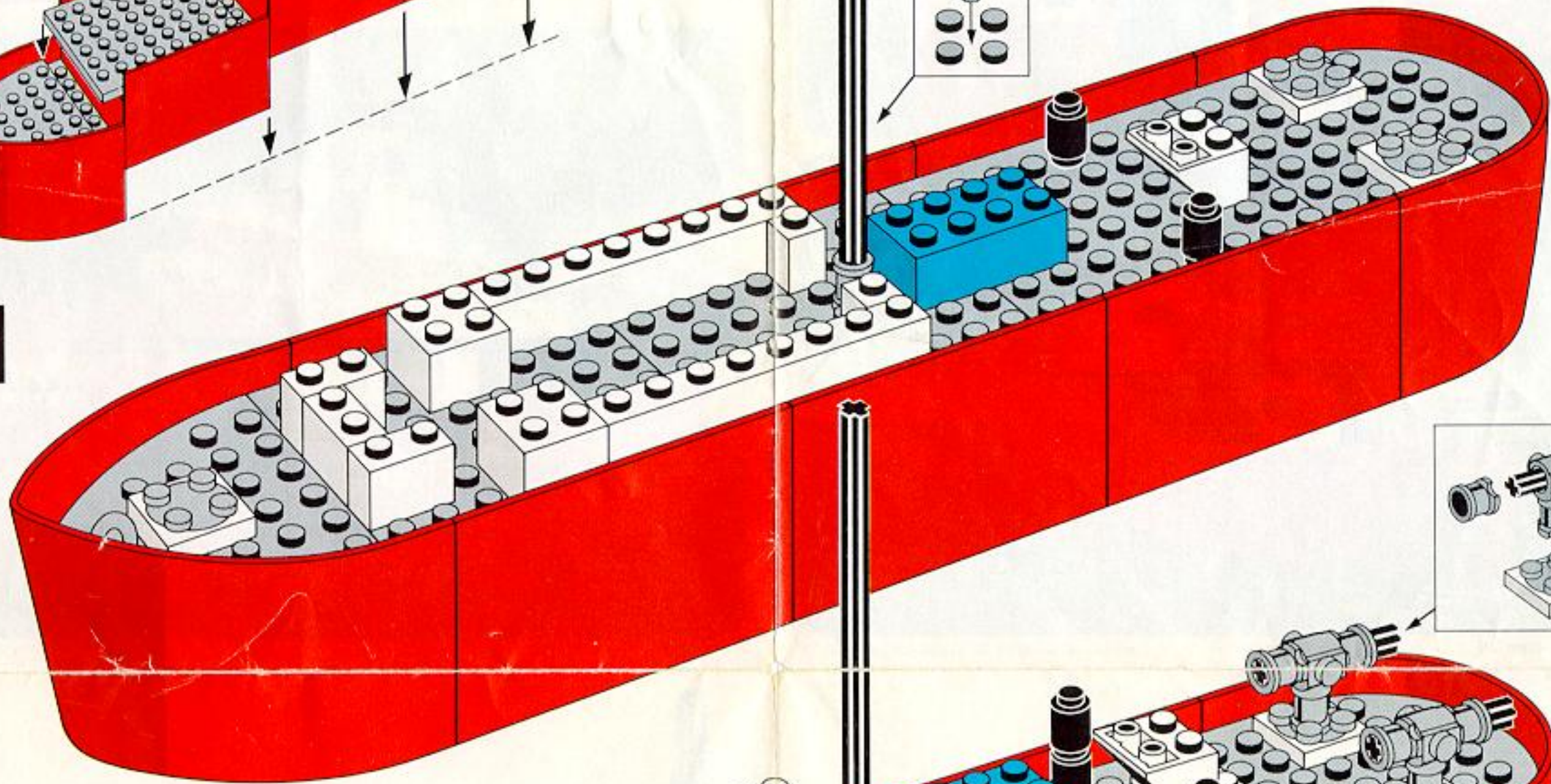

2

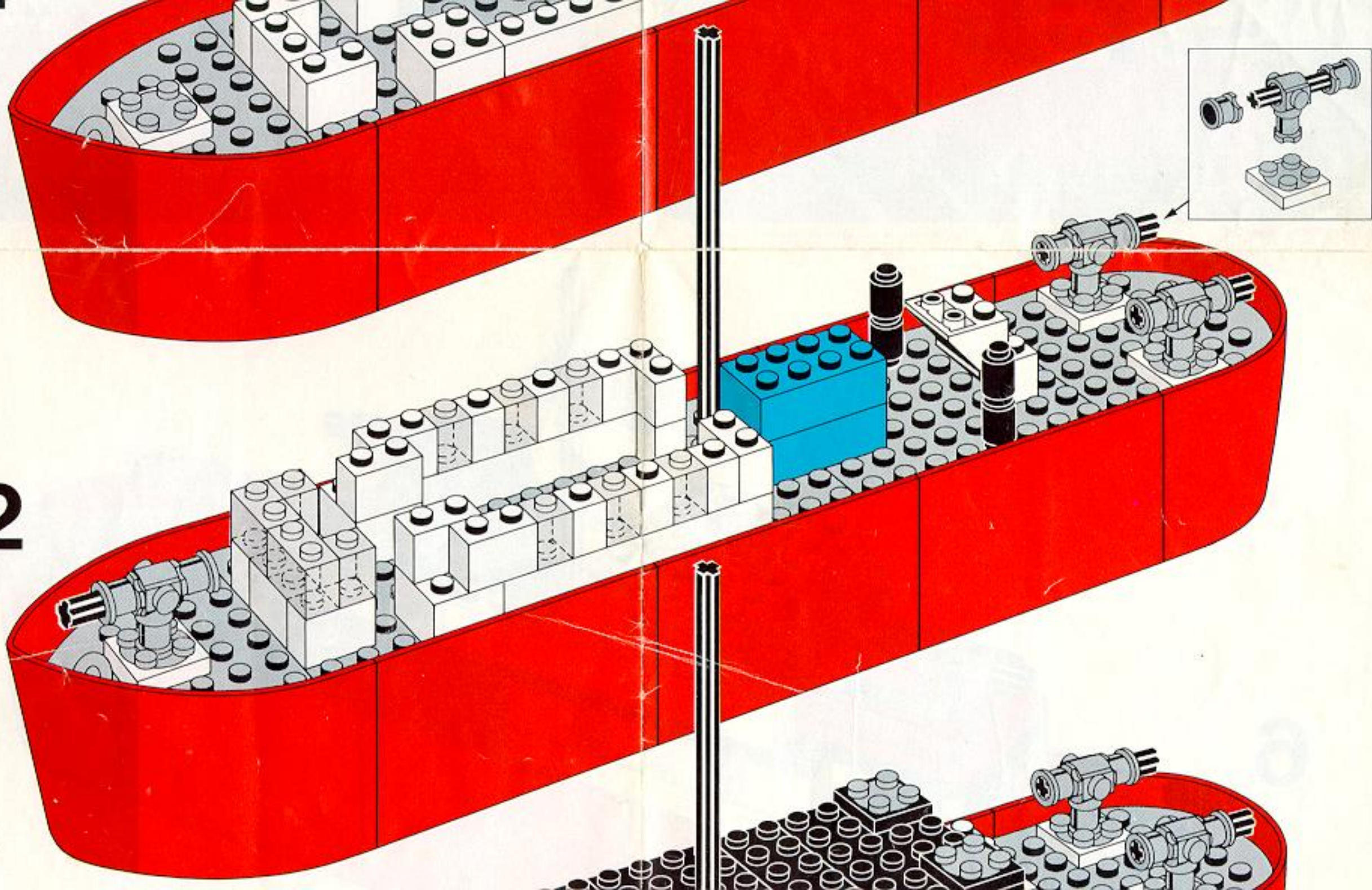

1

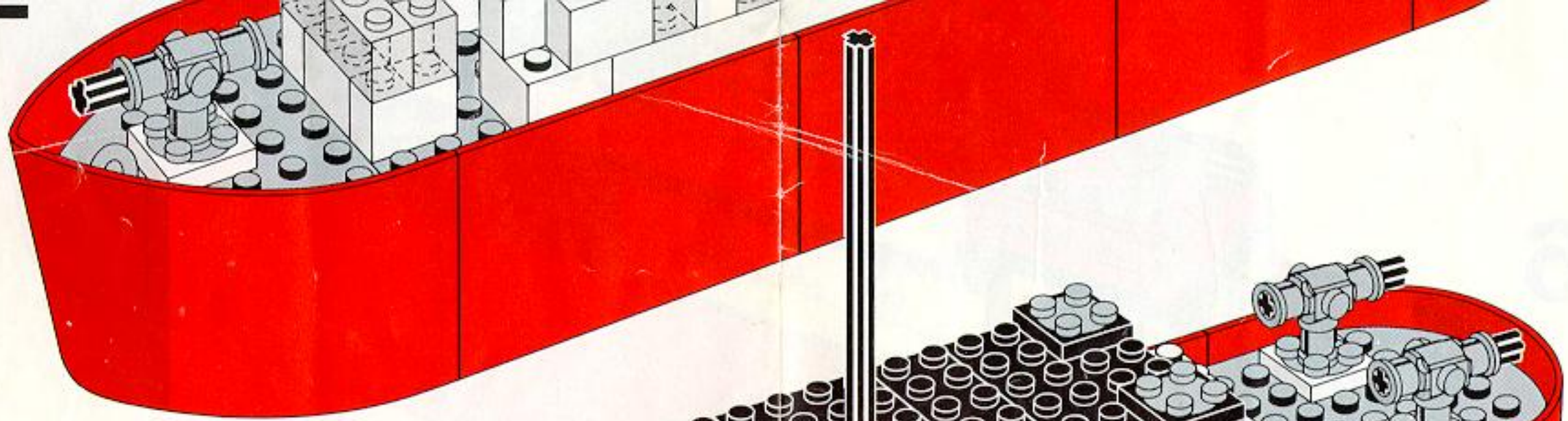

3

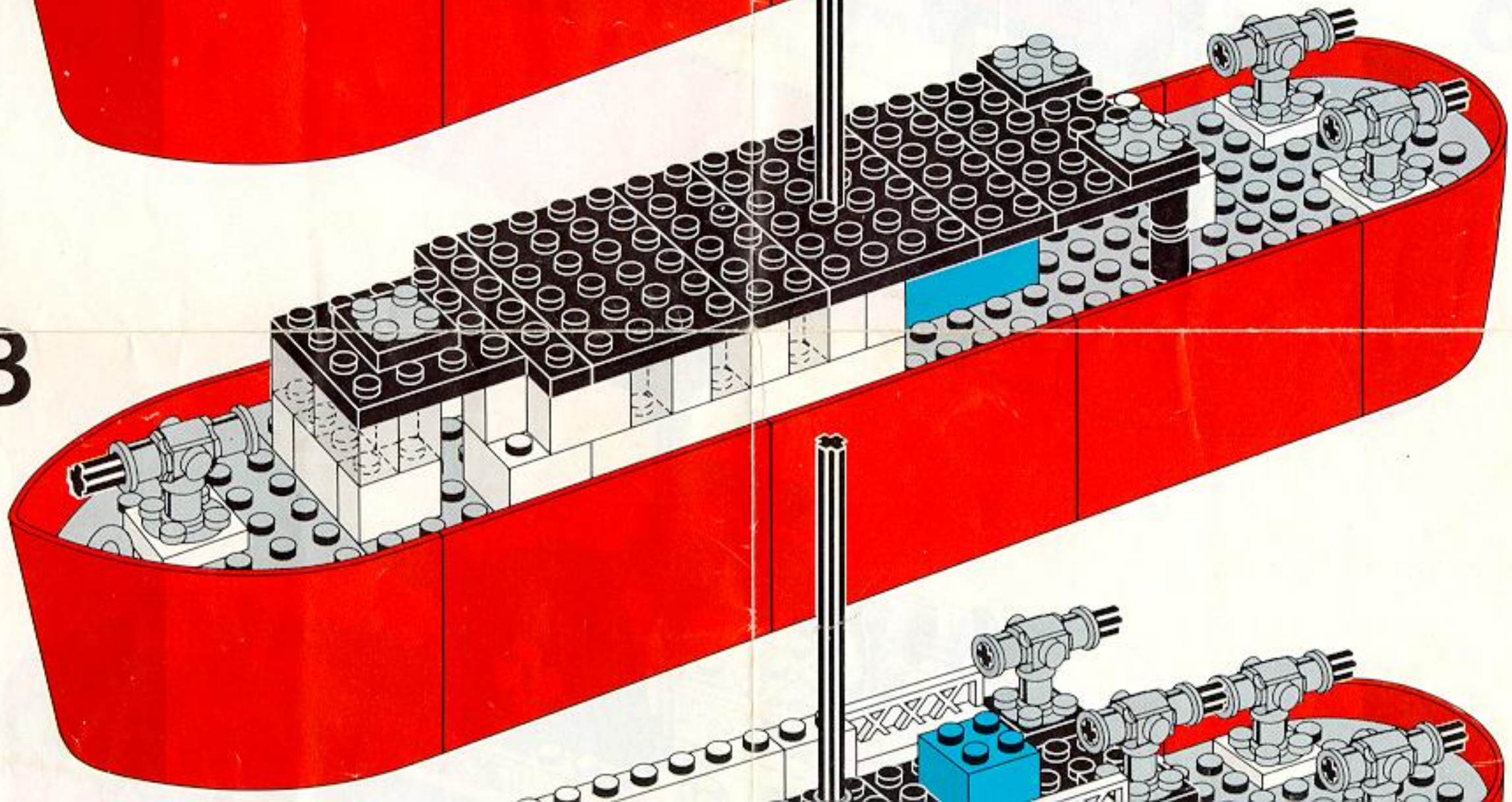

4

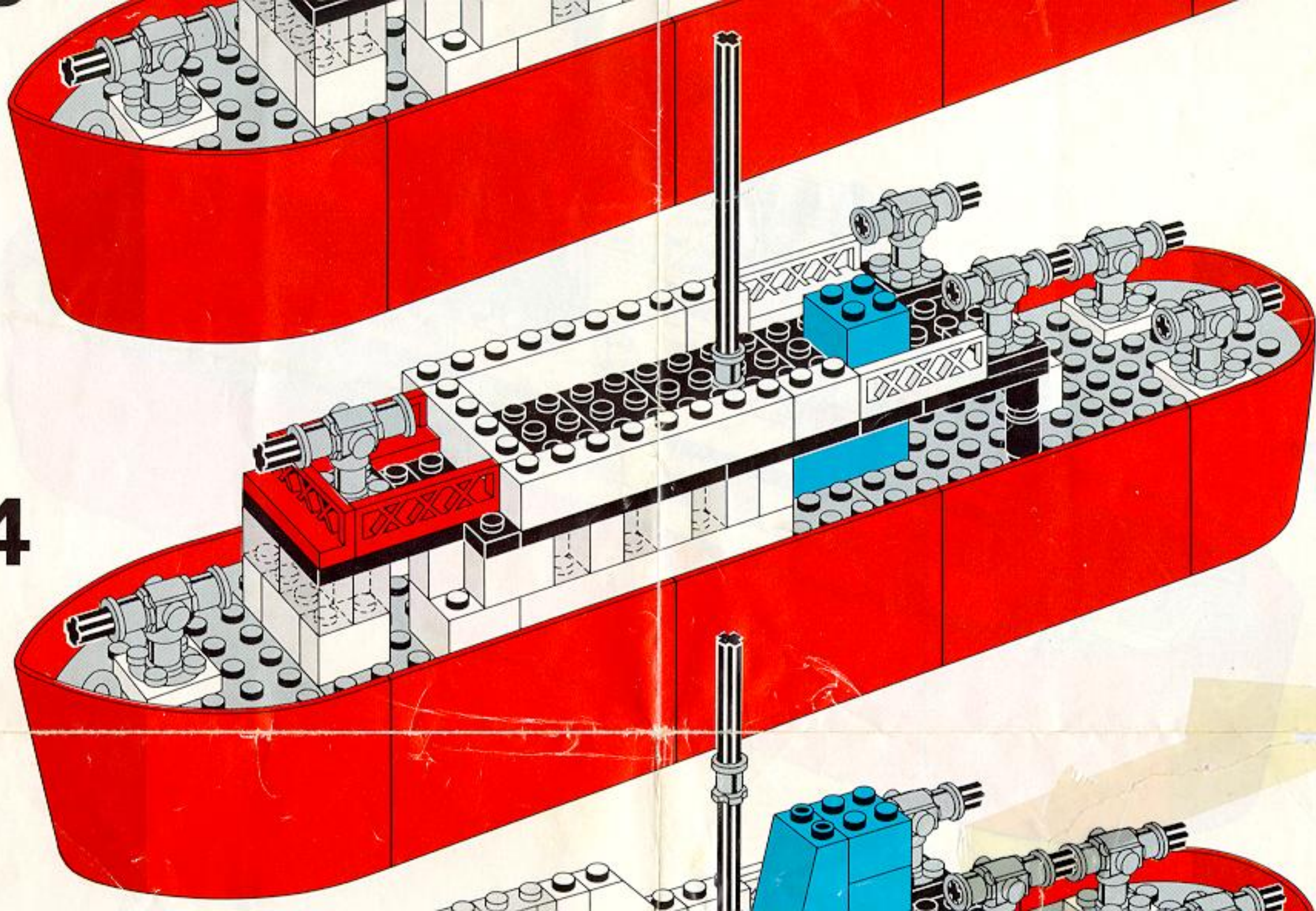

5

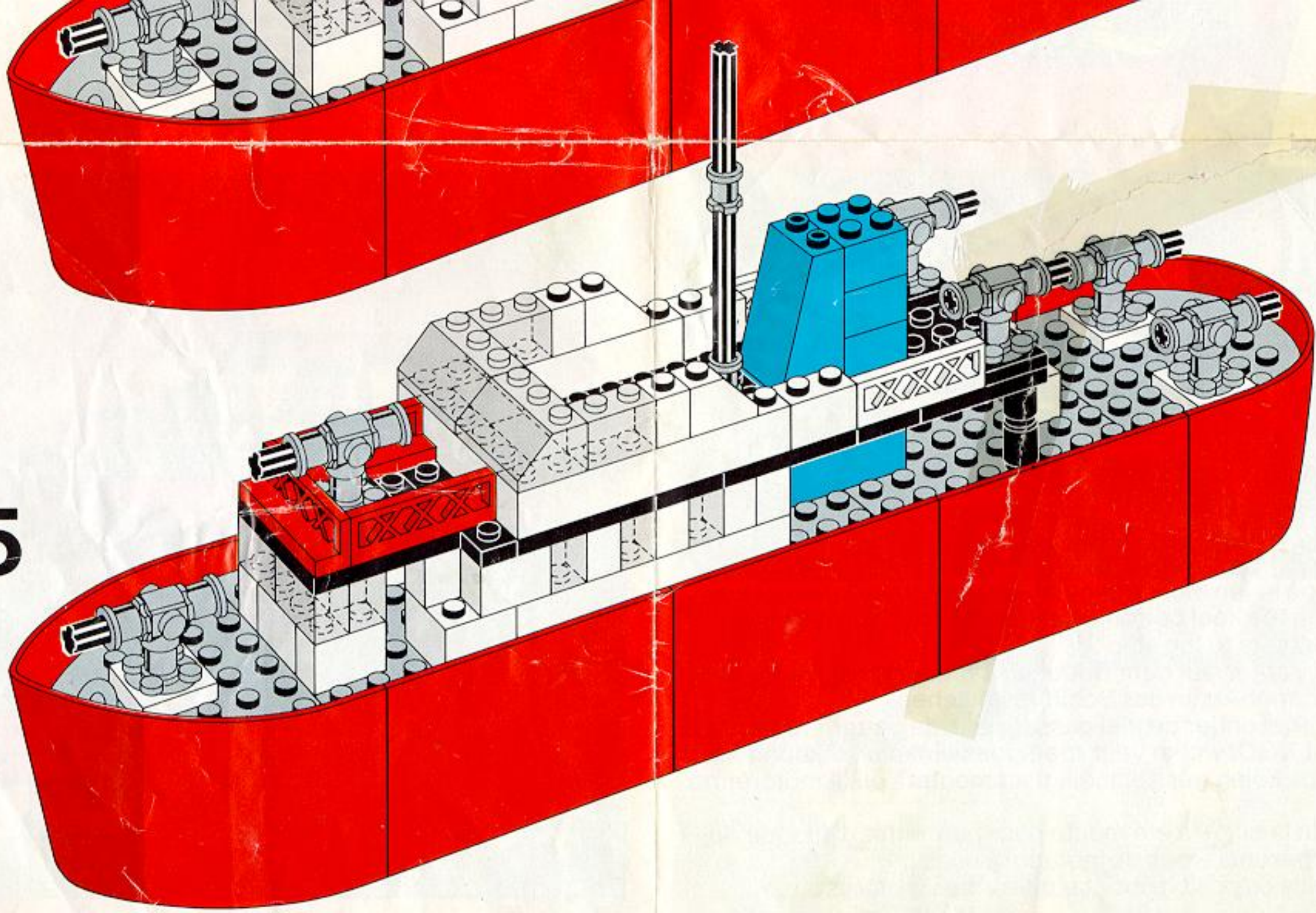

6

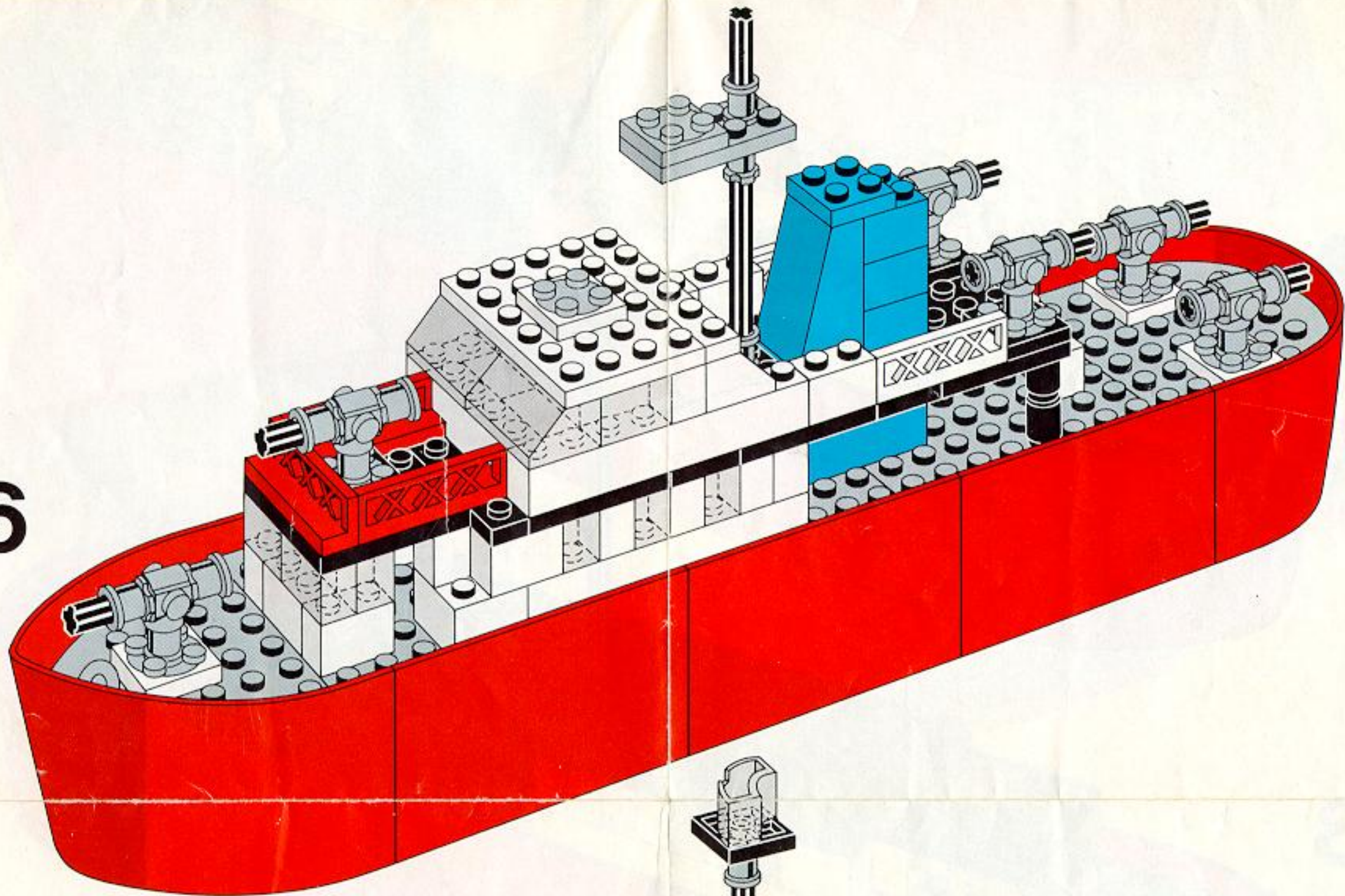

7

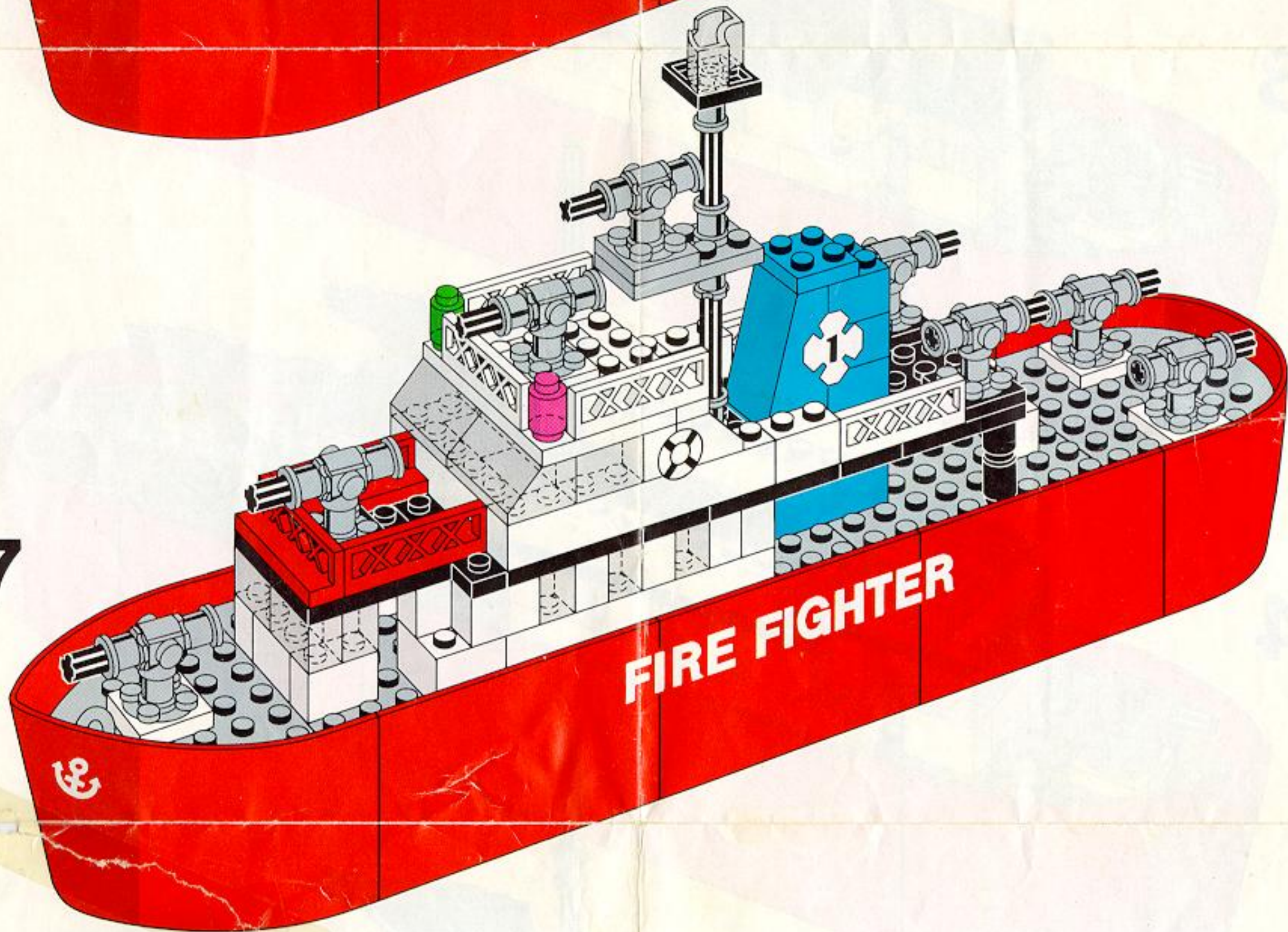

Max 40°C, 104°F



Max 40°C, 104°F



"Tappen på kølen muliggør montering af forskellige motorer".
"The lip on the keel bottom enables you to attach different kinds of motors to the ship".

"Mit dem Zapfen auf dem Boden des Kiels kannst Du Motoren verschiedener Art an das Schiff festmachen".

"Op de ribbel onder de kiel passen vaak de batterij-motortjes (niet van LEGO) welke veel speelgoedwinkels verkopen".

"Tappen på kölen gör det möjligt att montera olika motorer på båten".

"Le bas de la quille a été moulé pour permettre d'adapter au bateau différents types de moteurs à piles".

"En la quilla es posible montar diferentes motores".

