

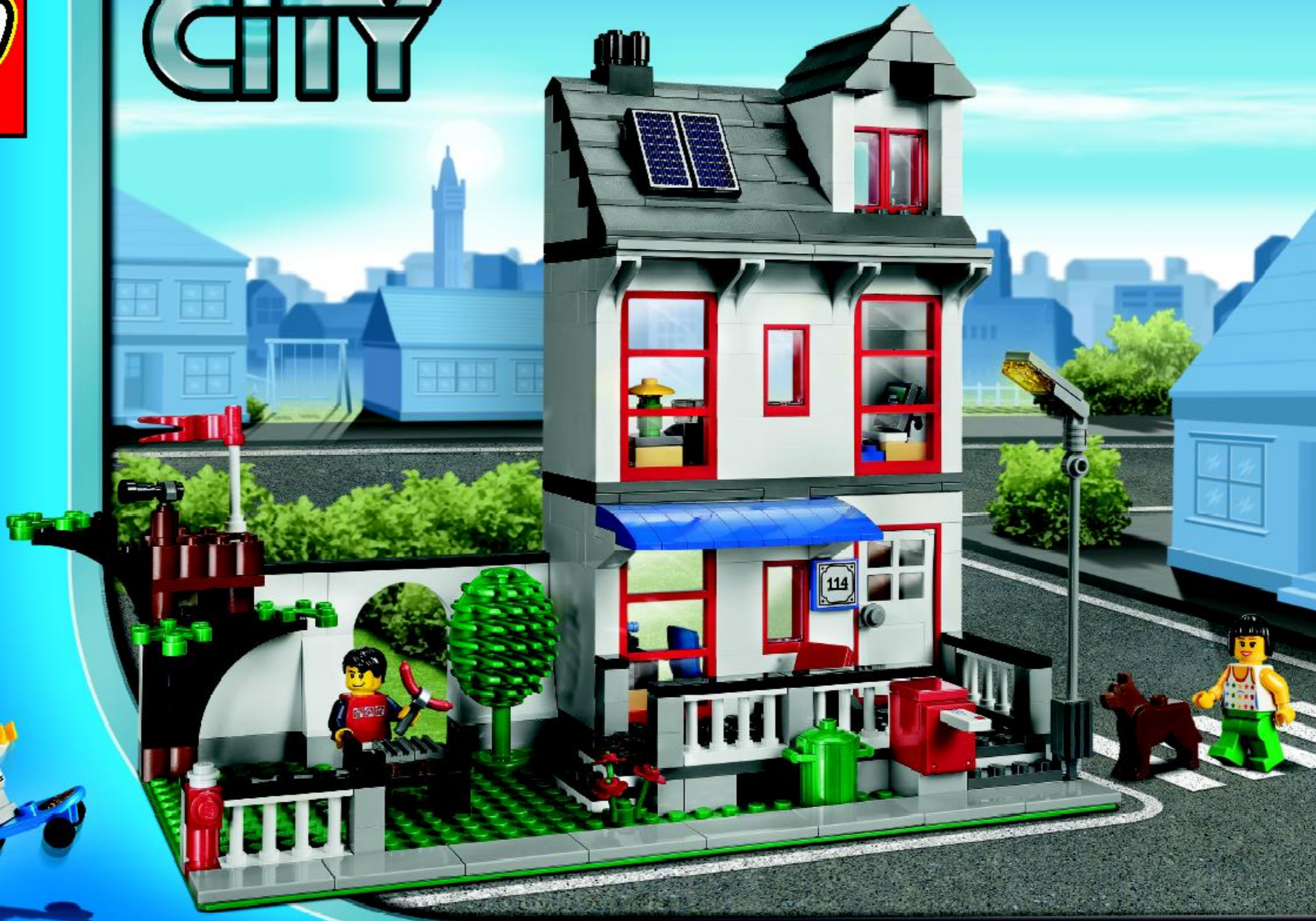

8403

CITY

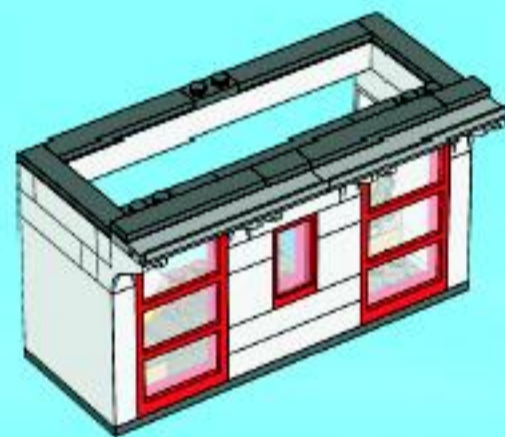

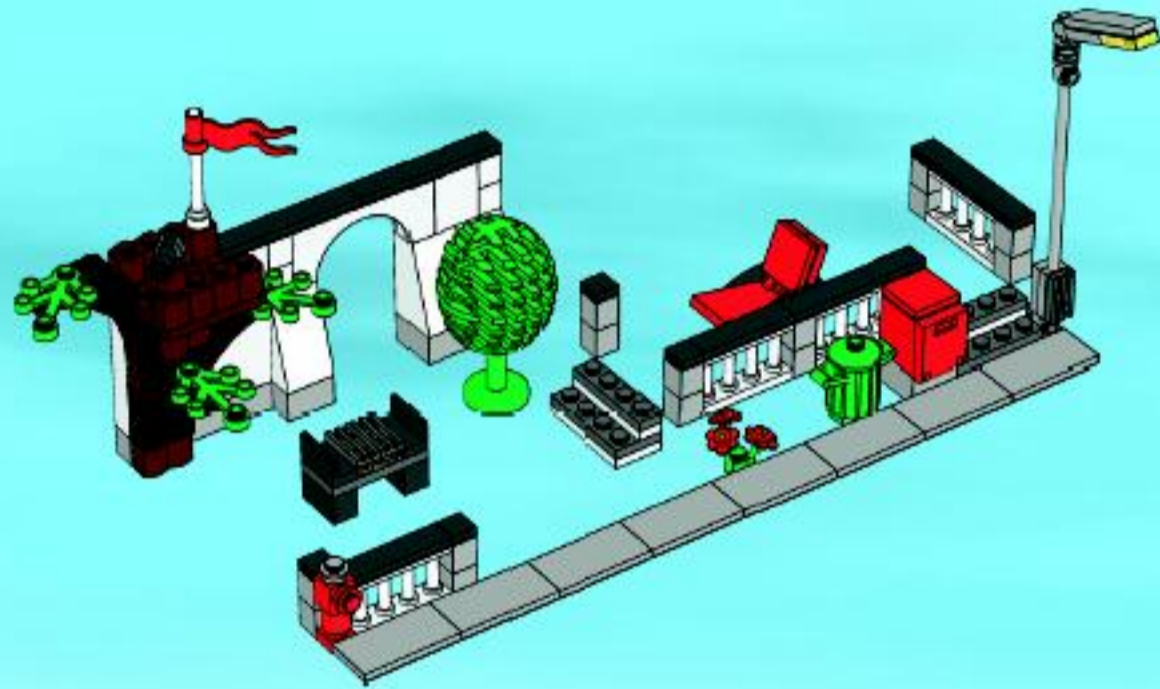

1

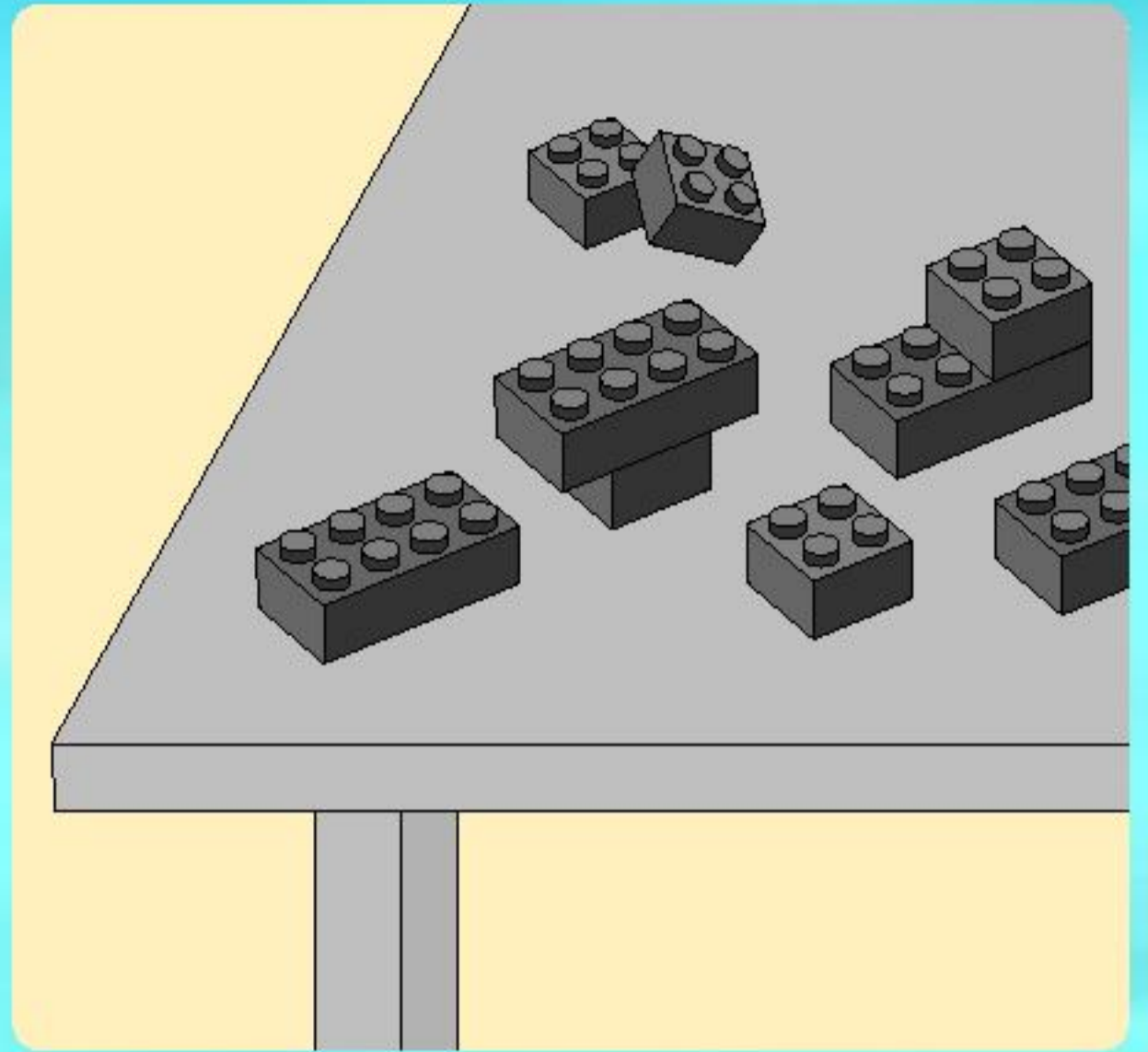
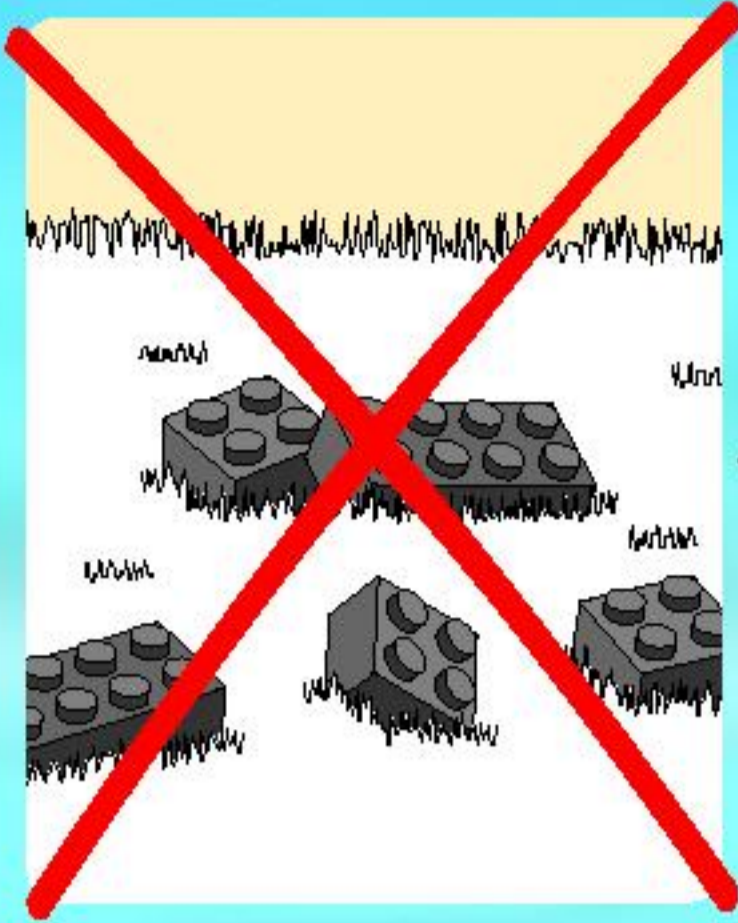

2



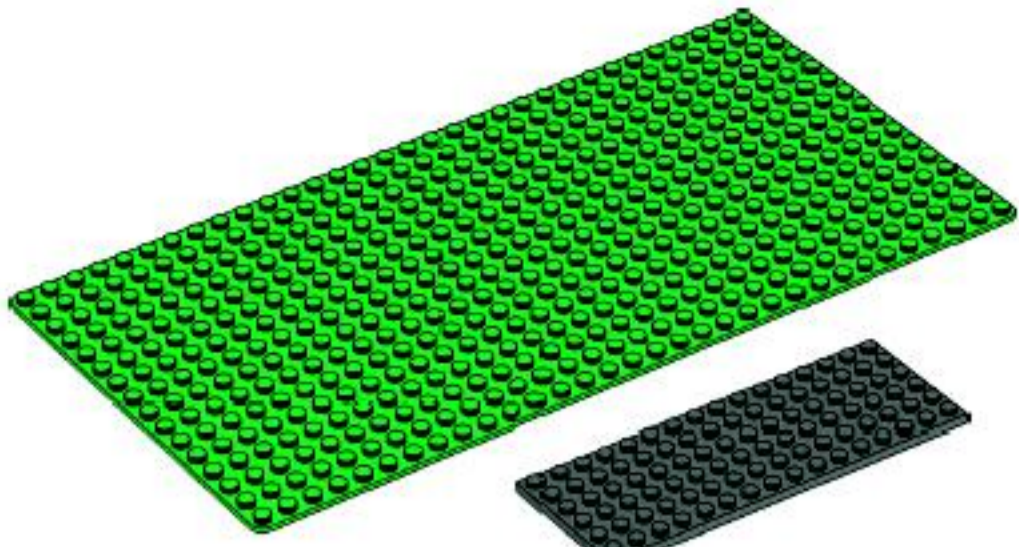

+

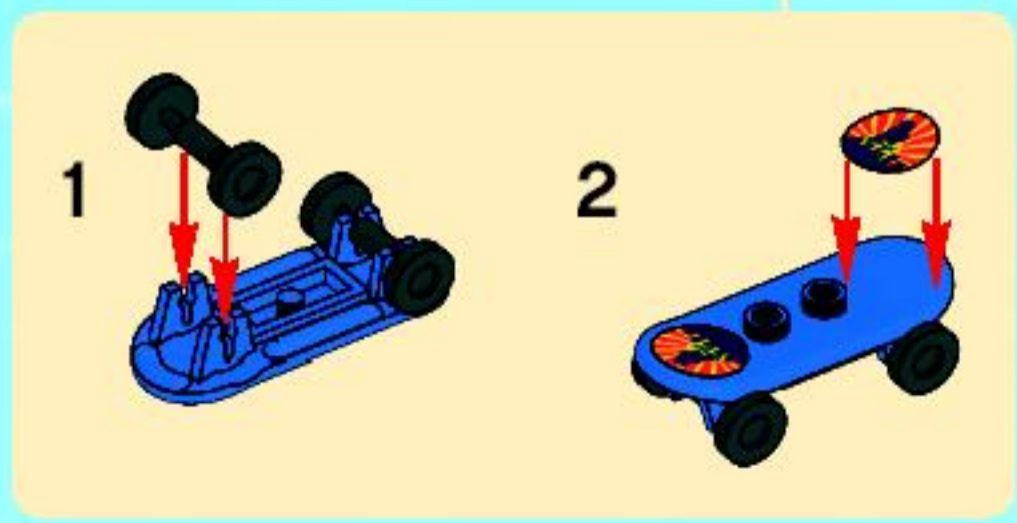
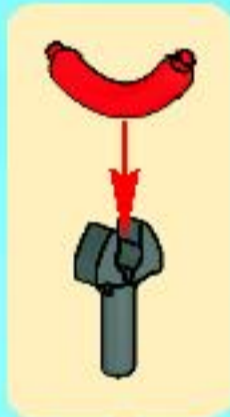
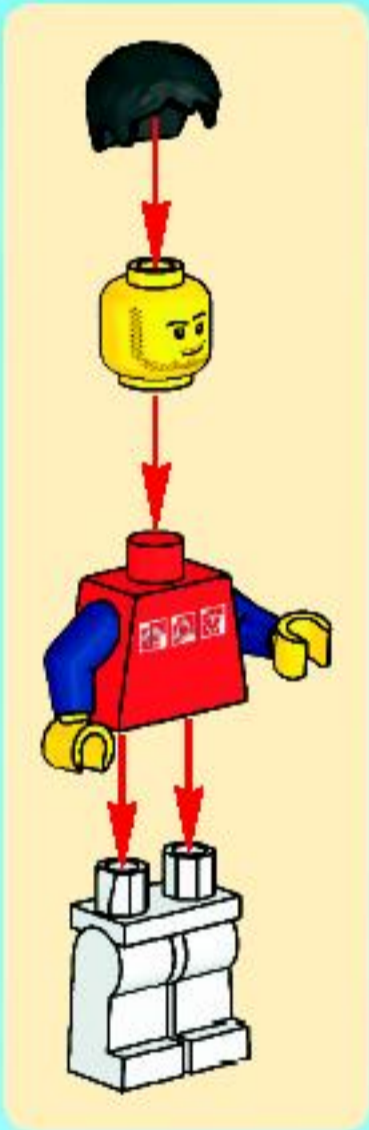
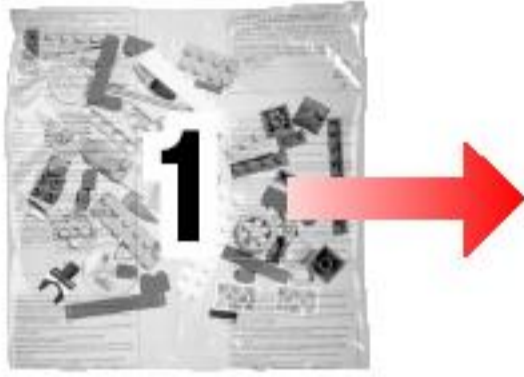

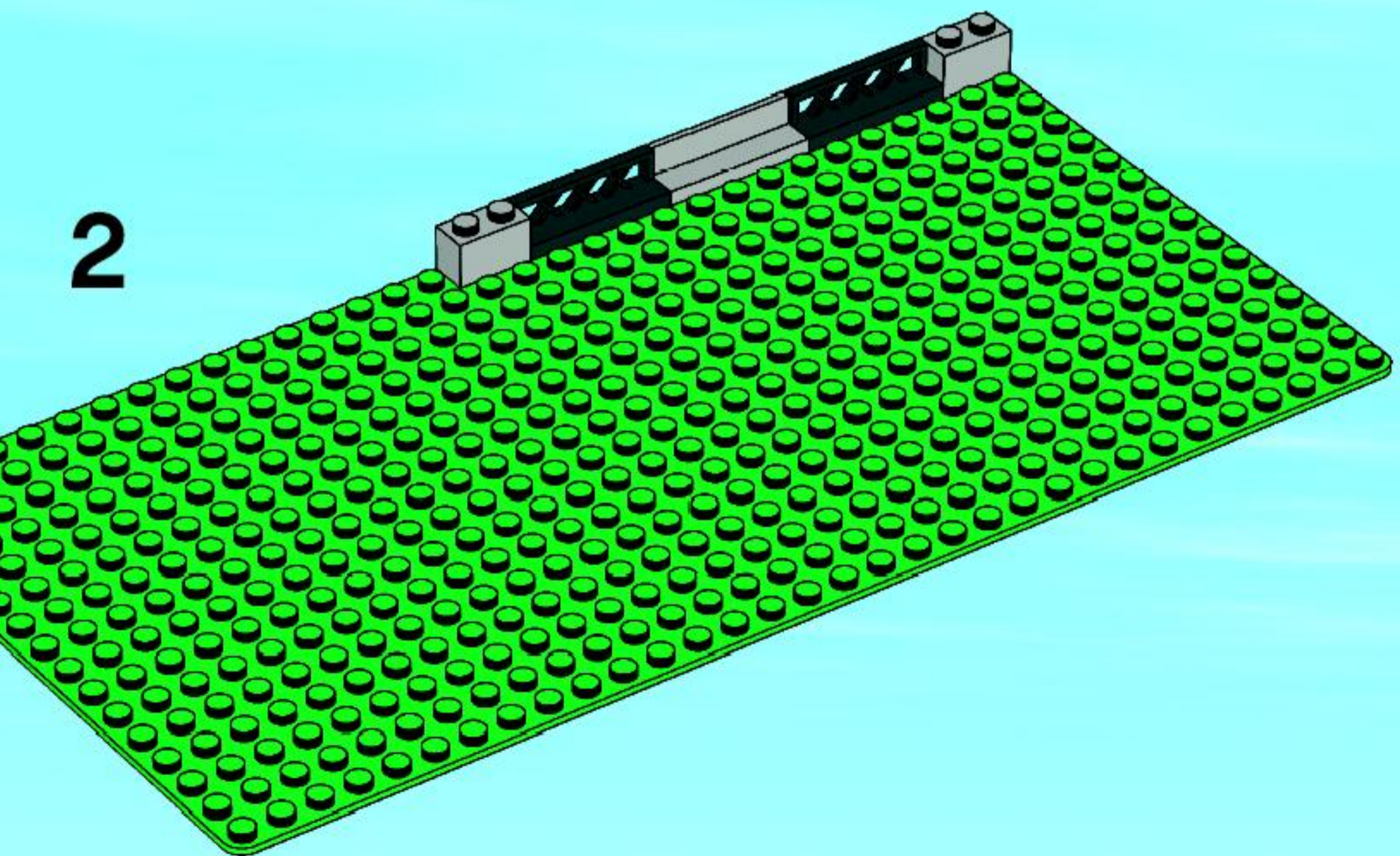
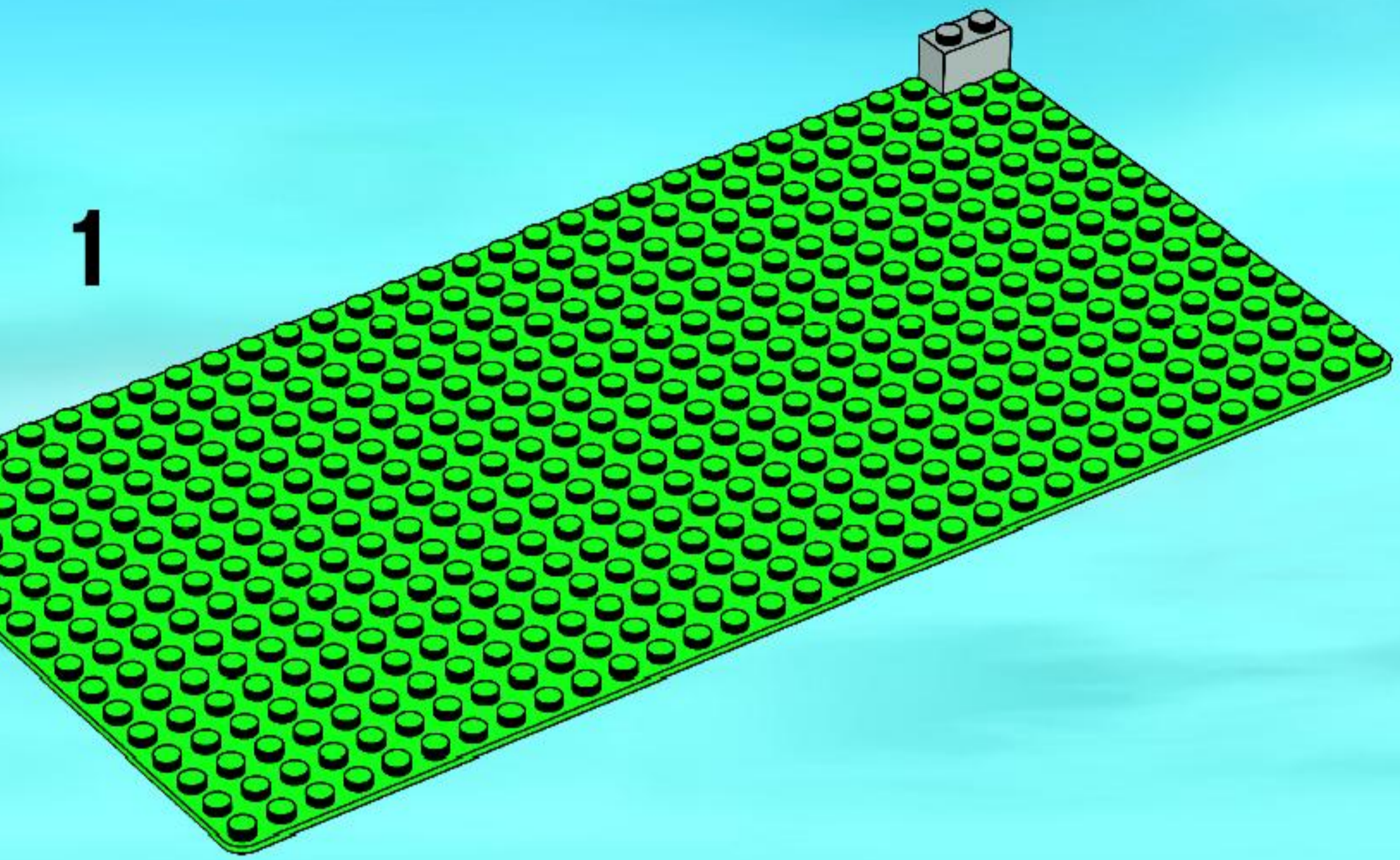

3

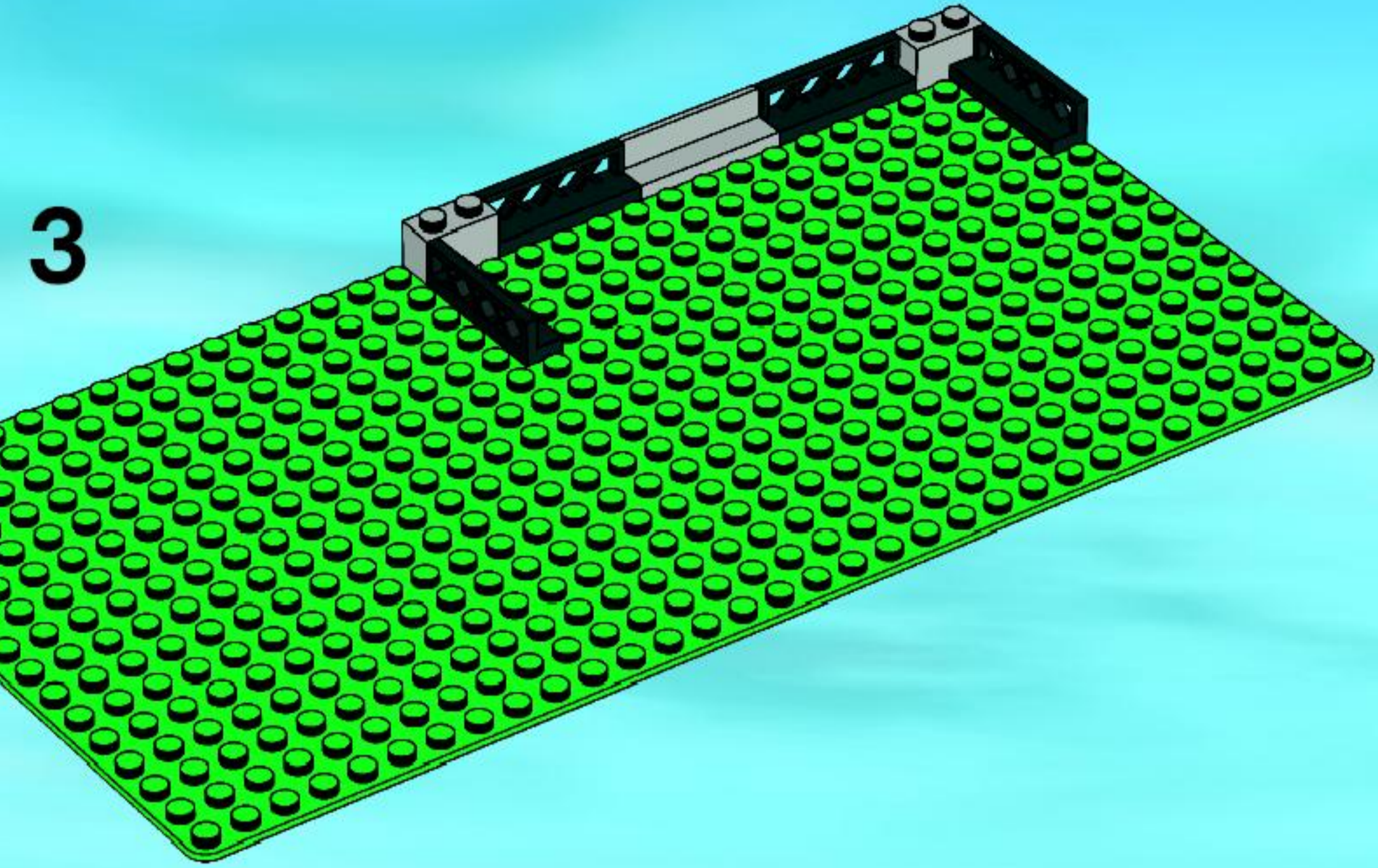

4

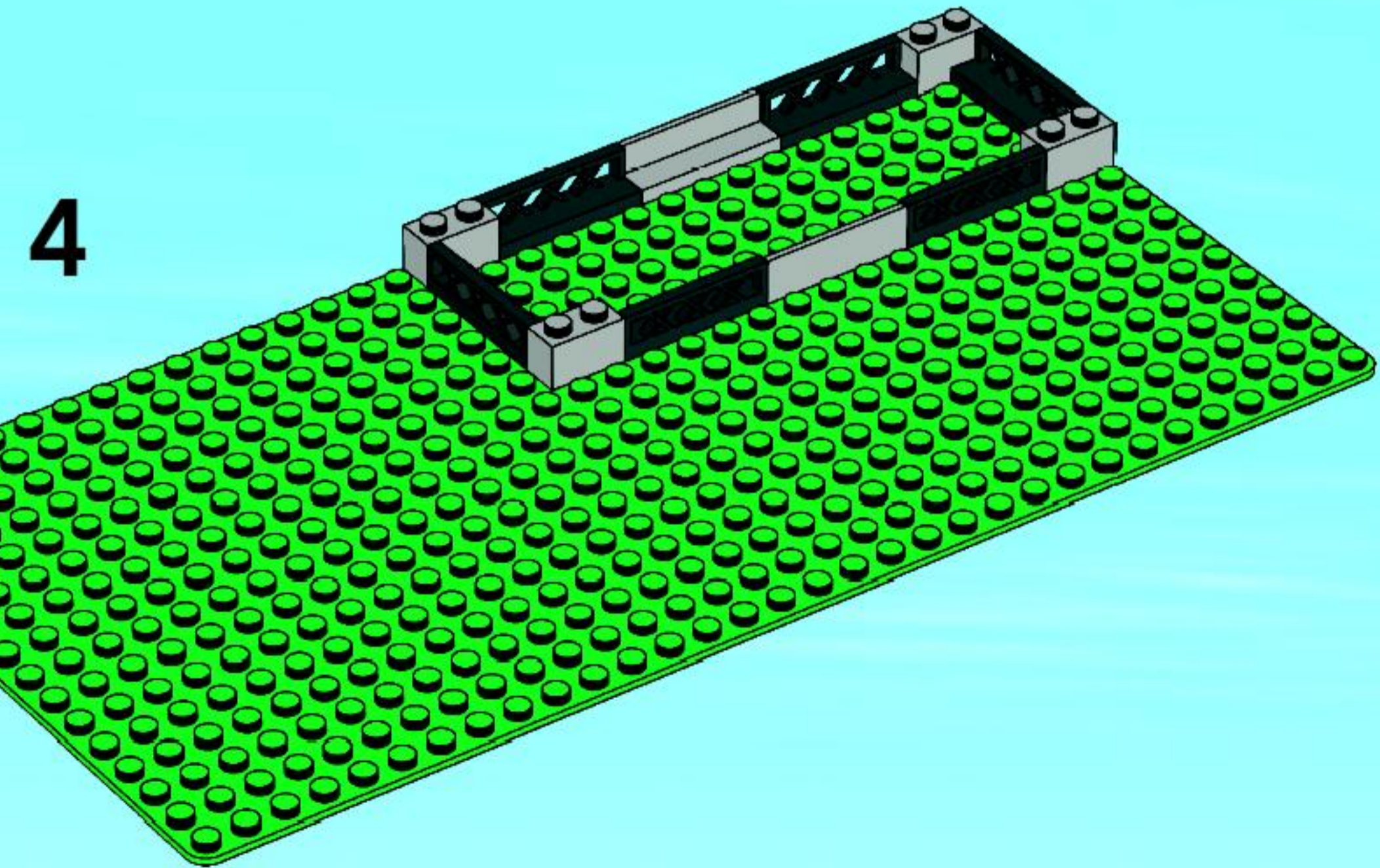

5

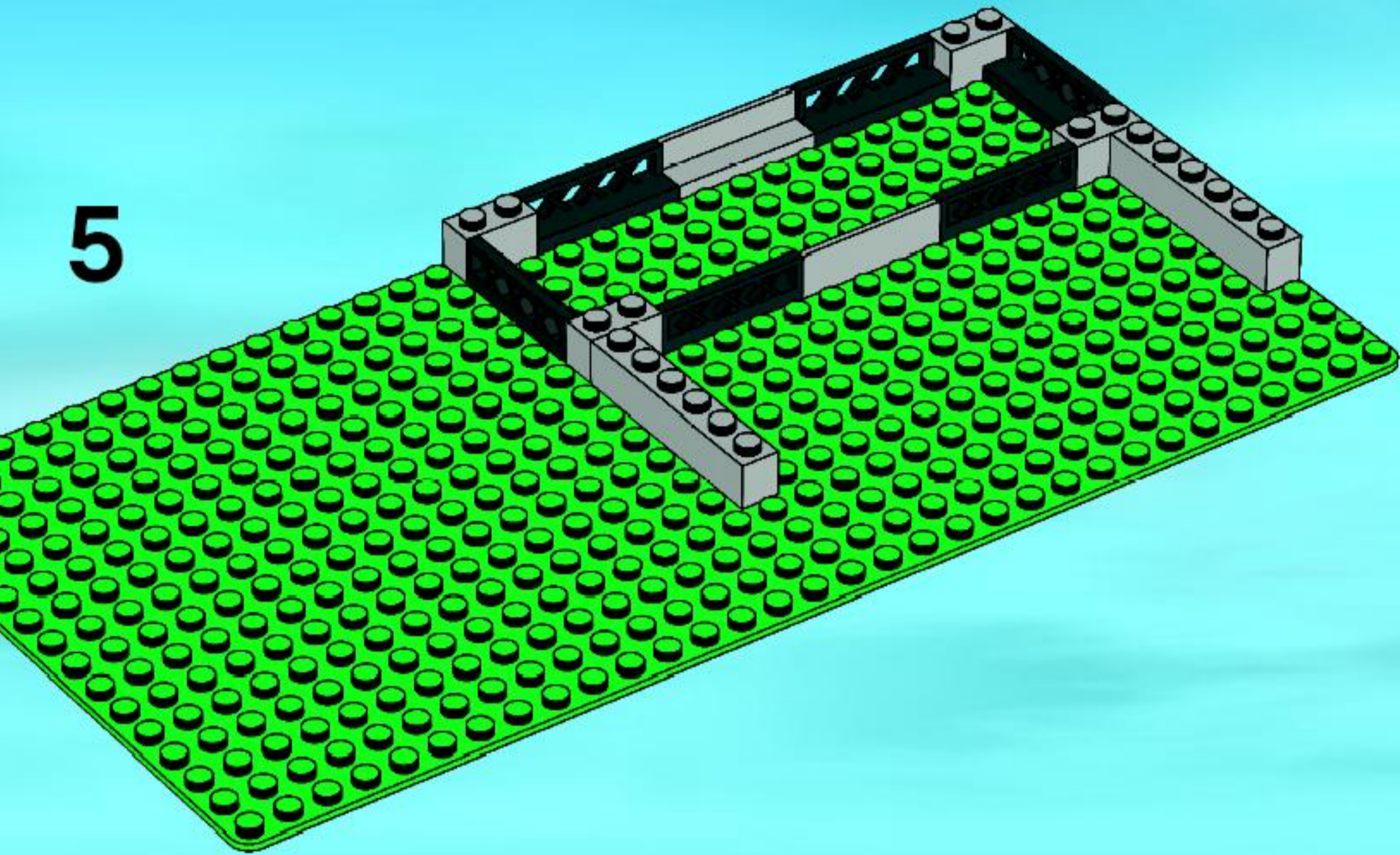

6

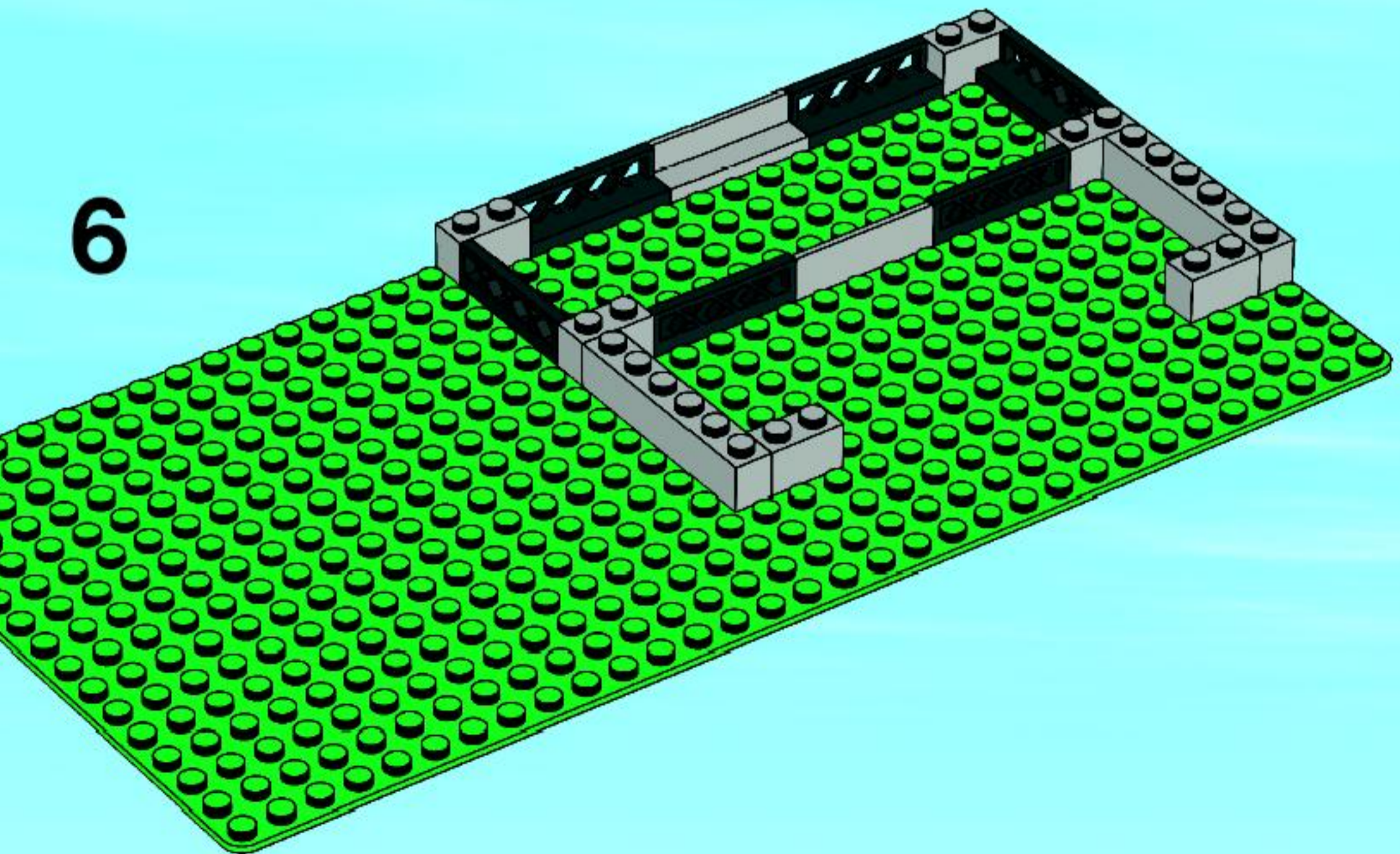

7

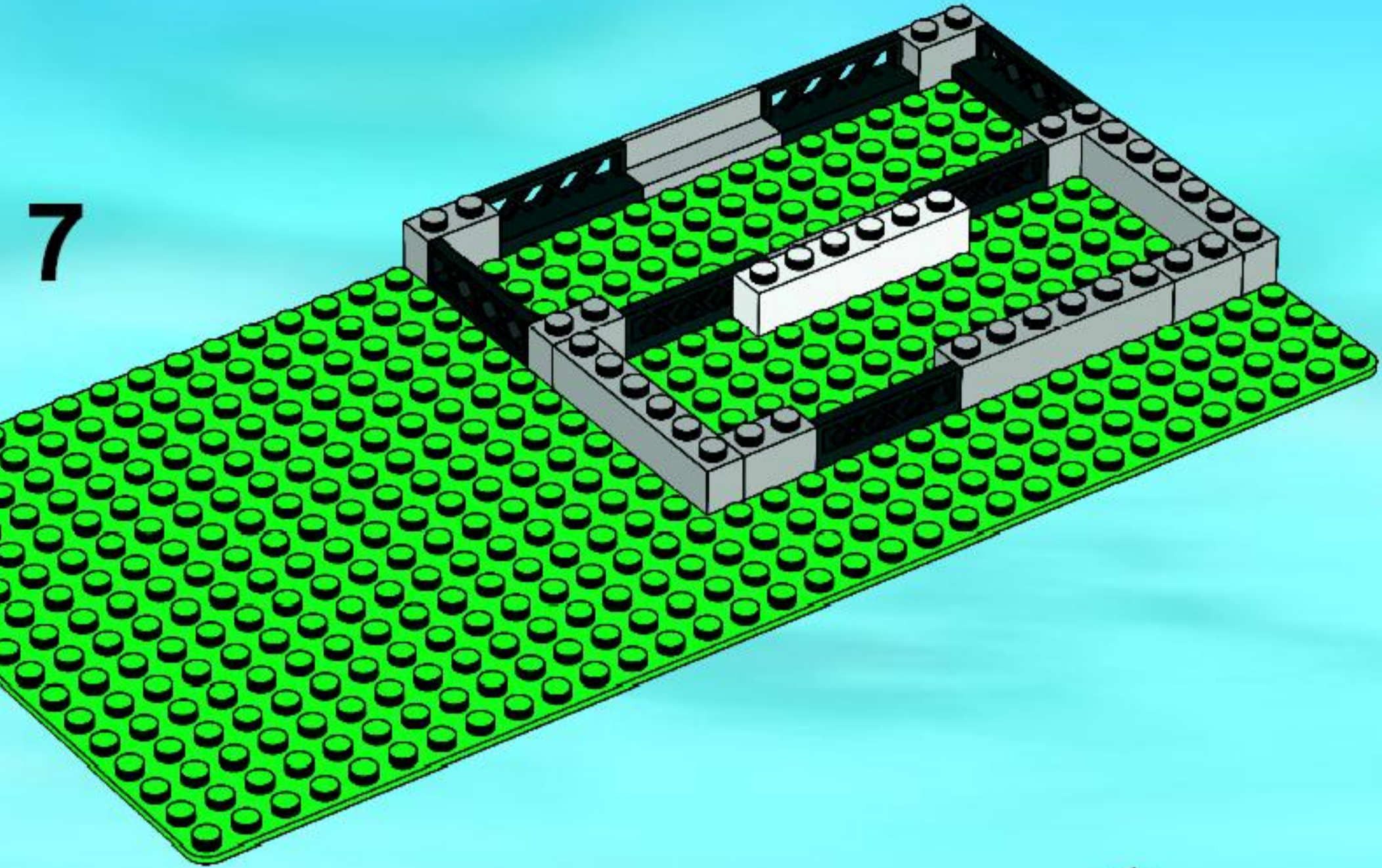

8

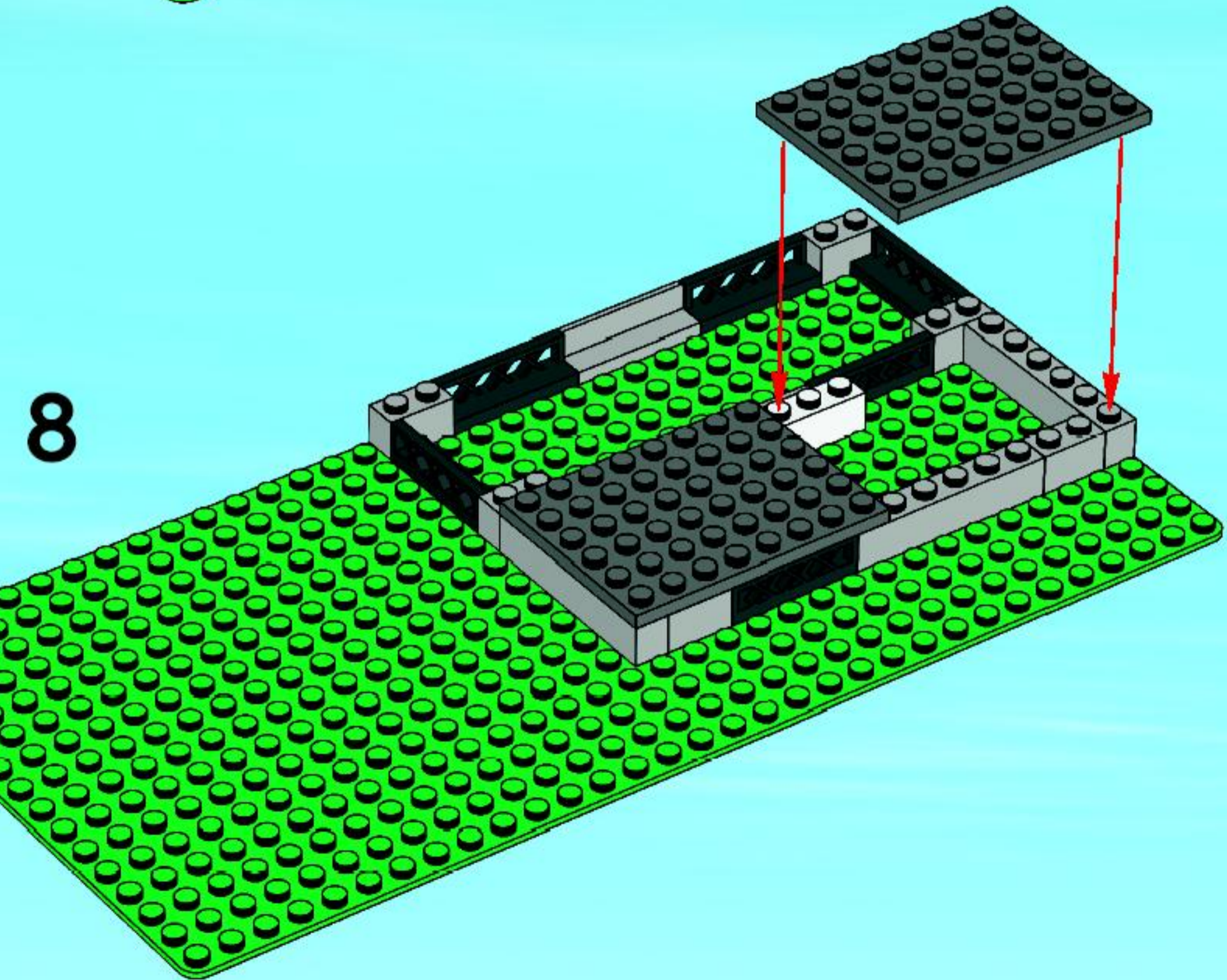



1

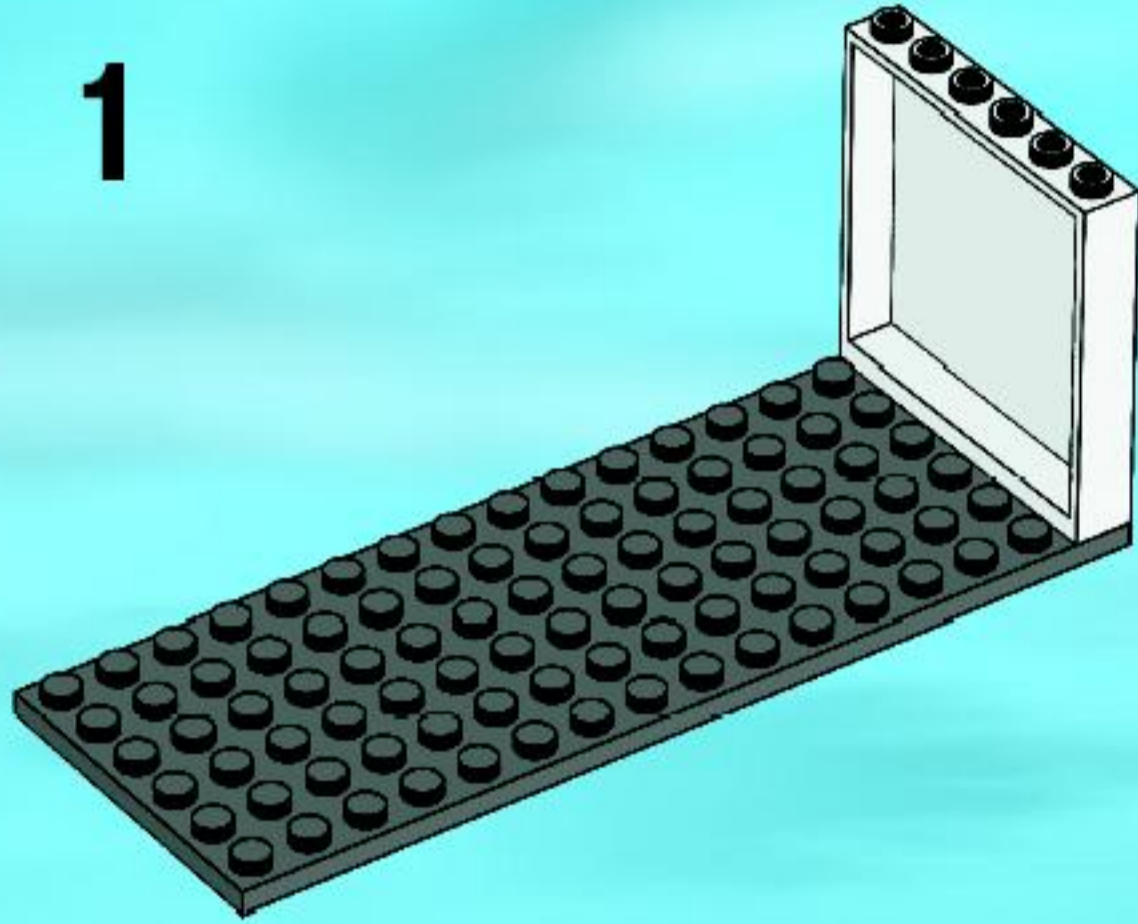

2

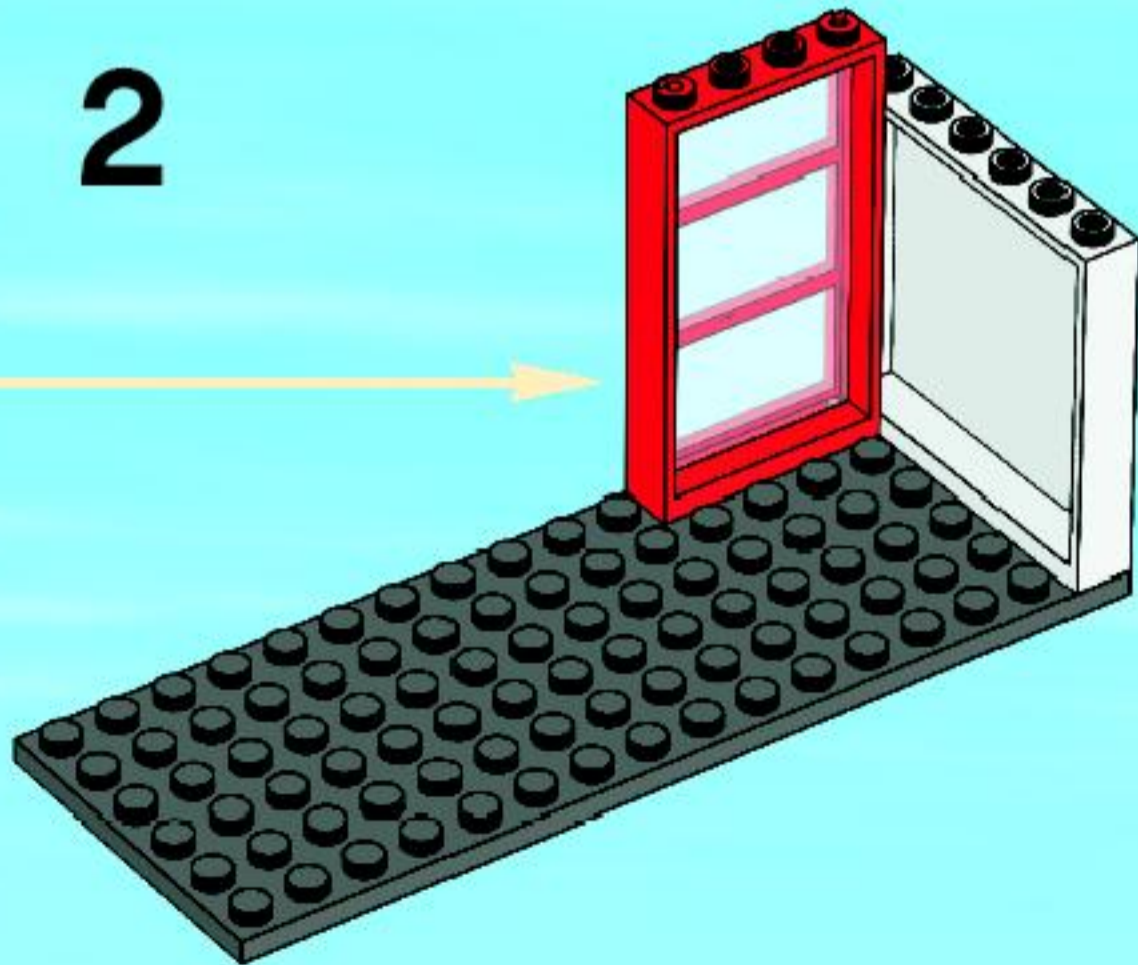
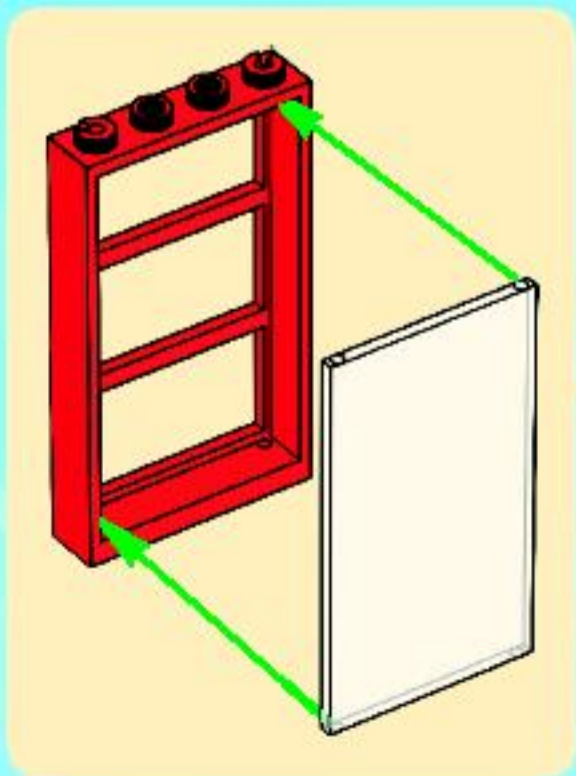

3

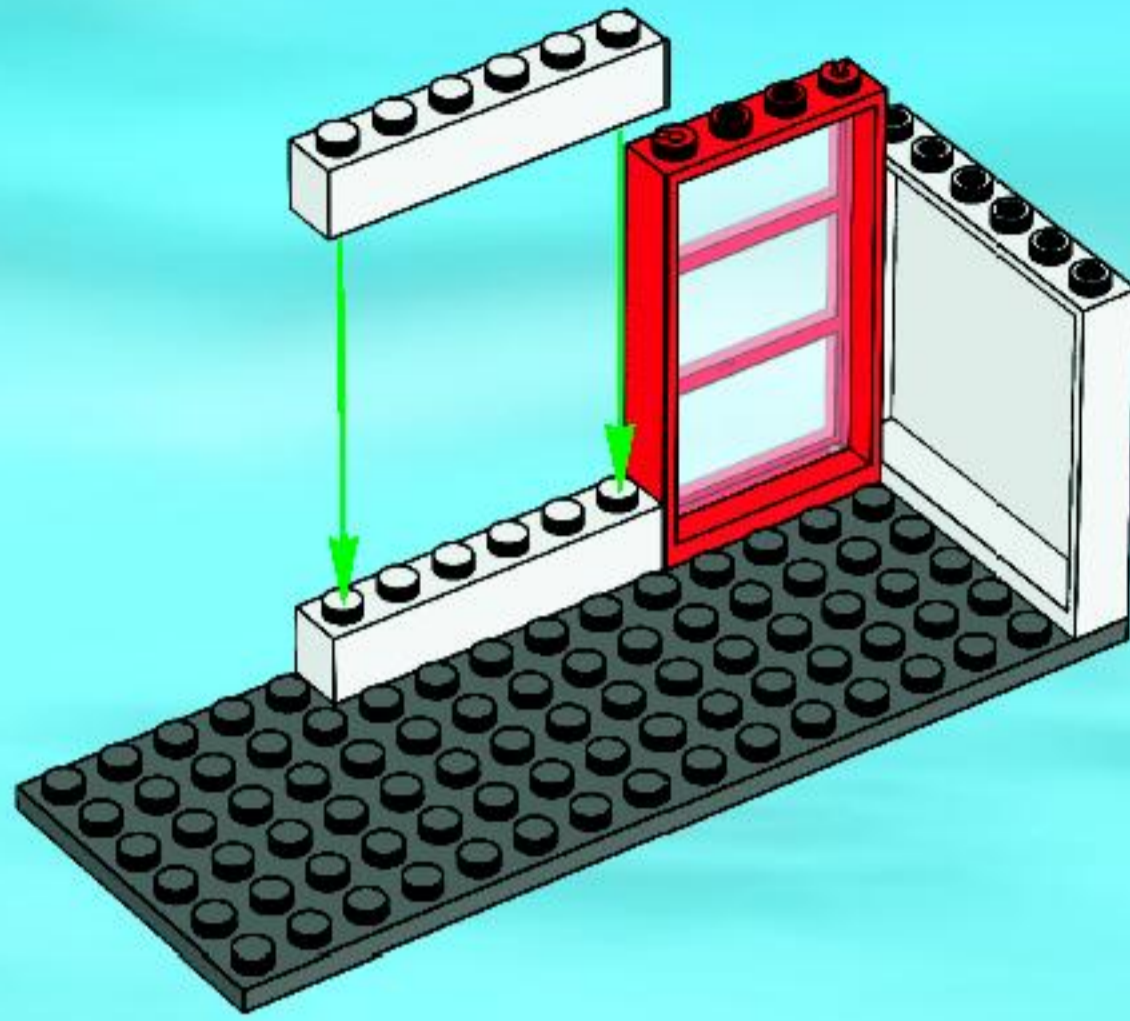

4

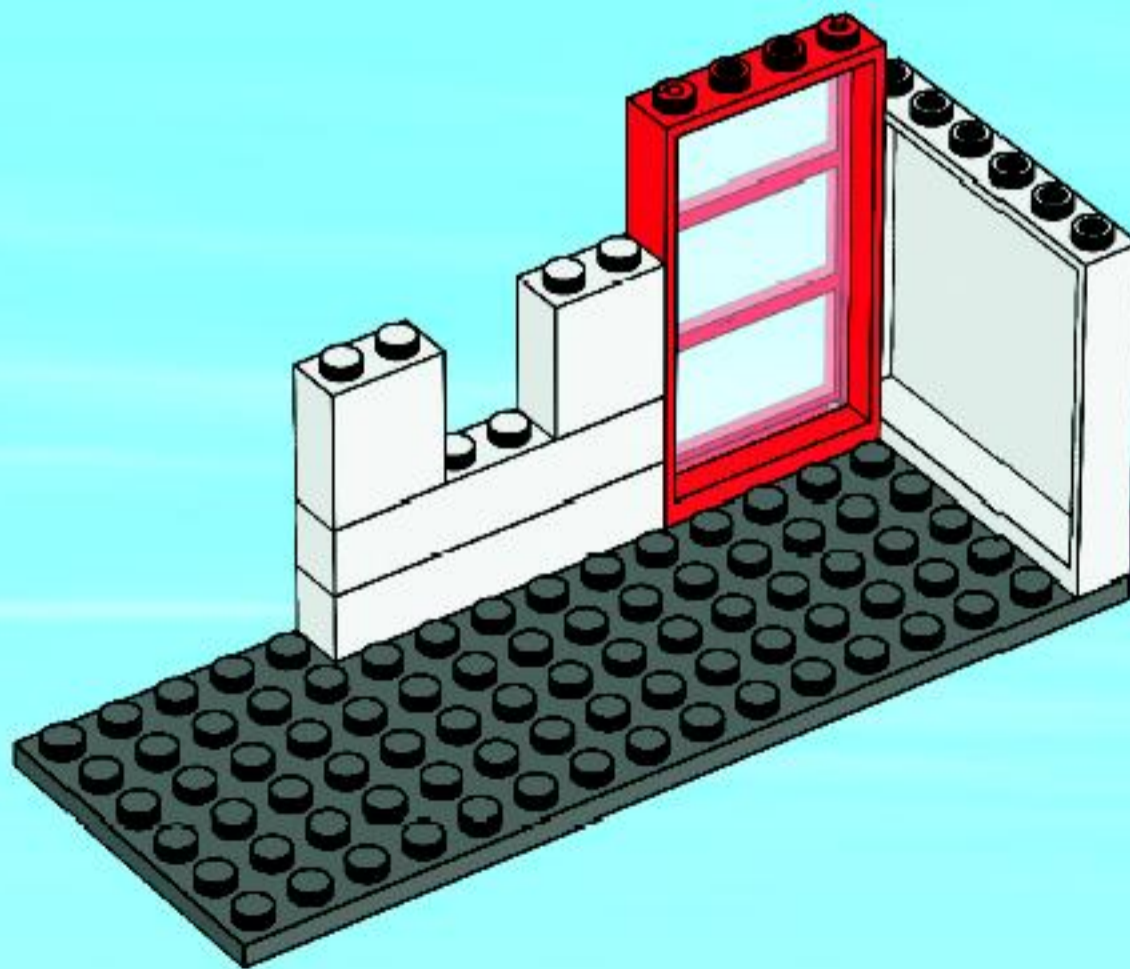

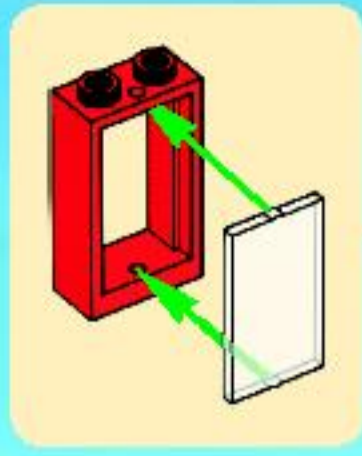

5

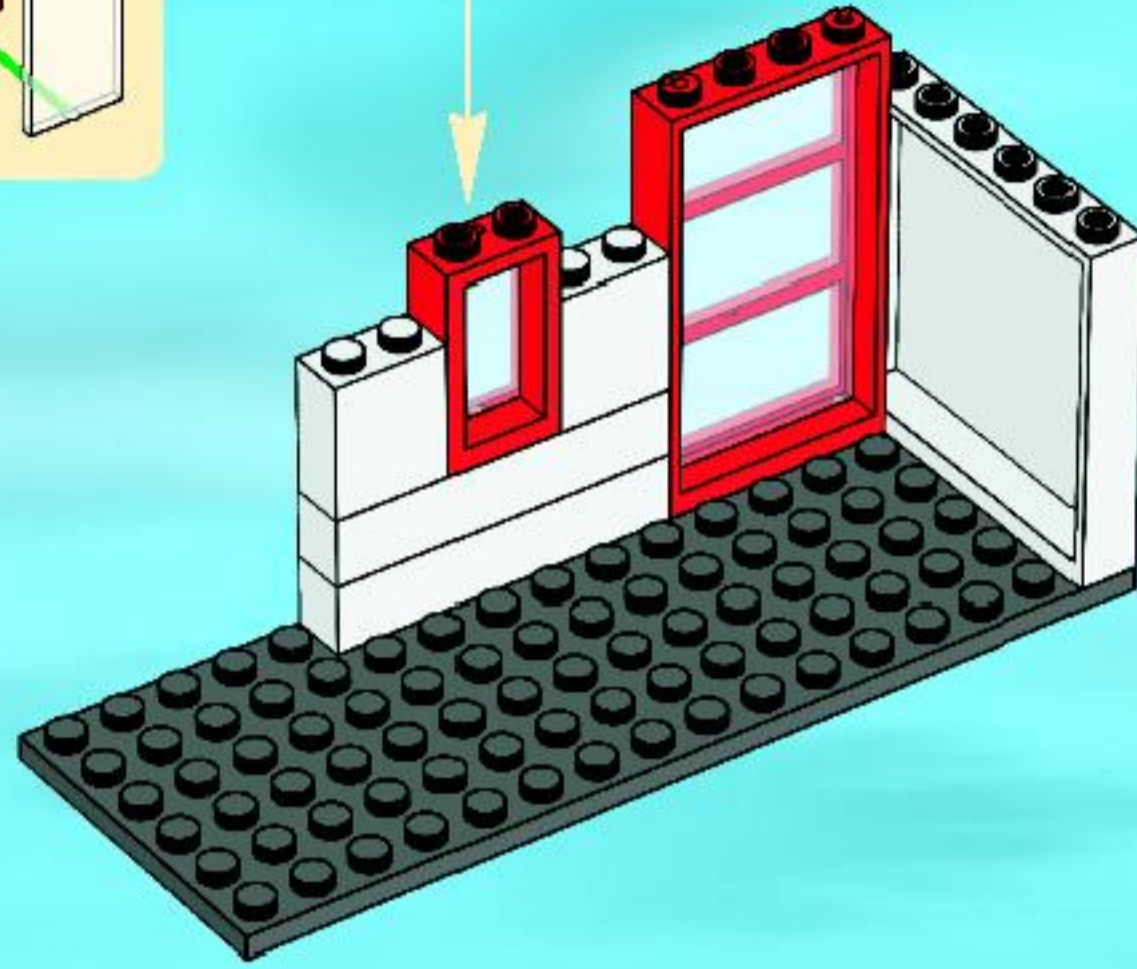

6

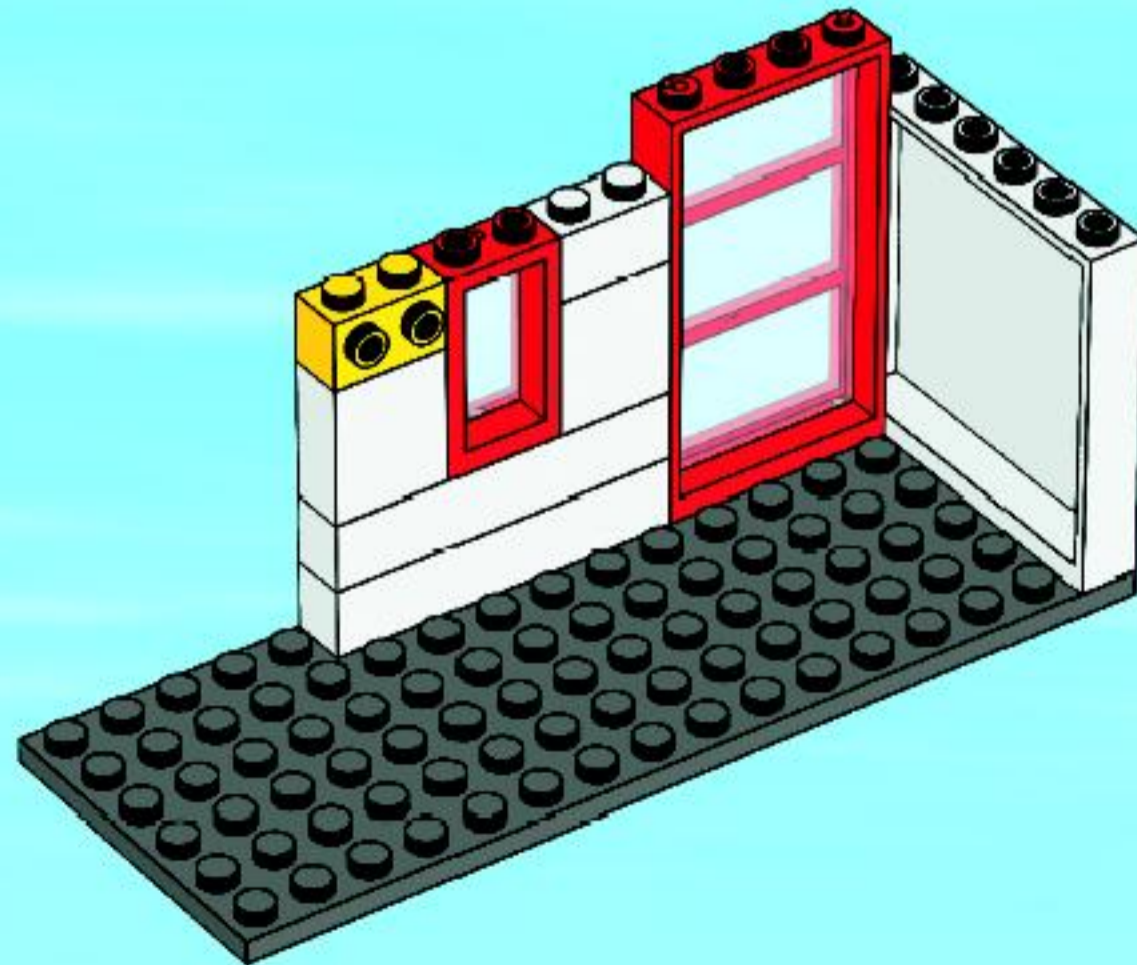

7

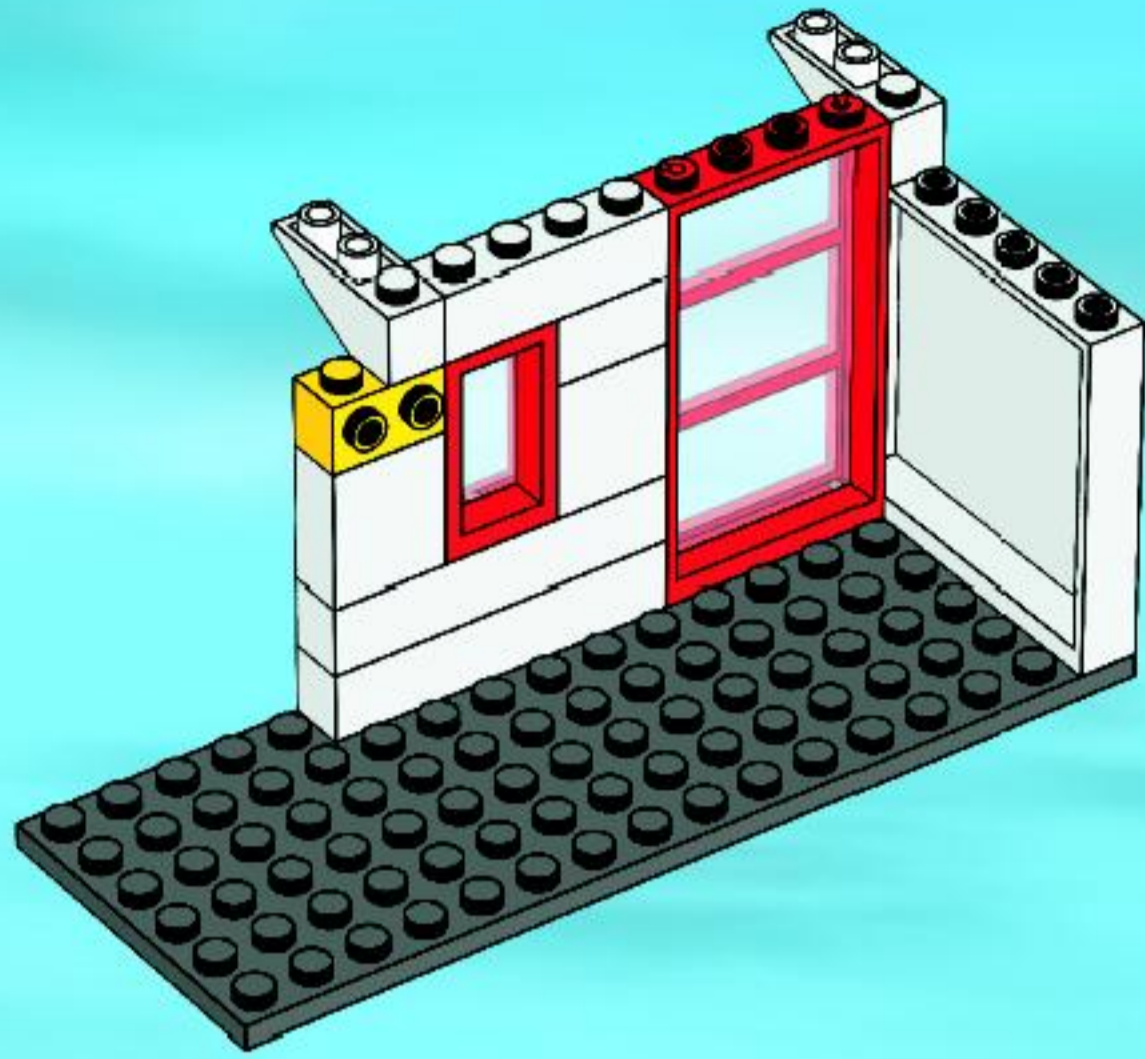

8

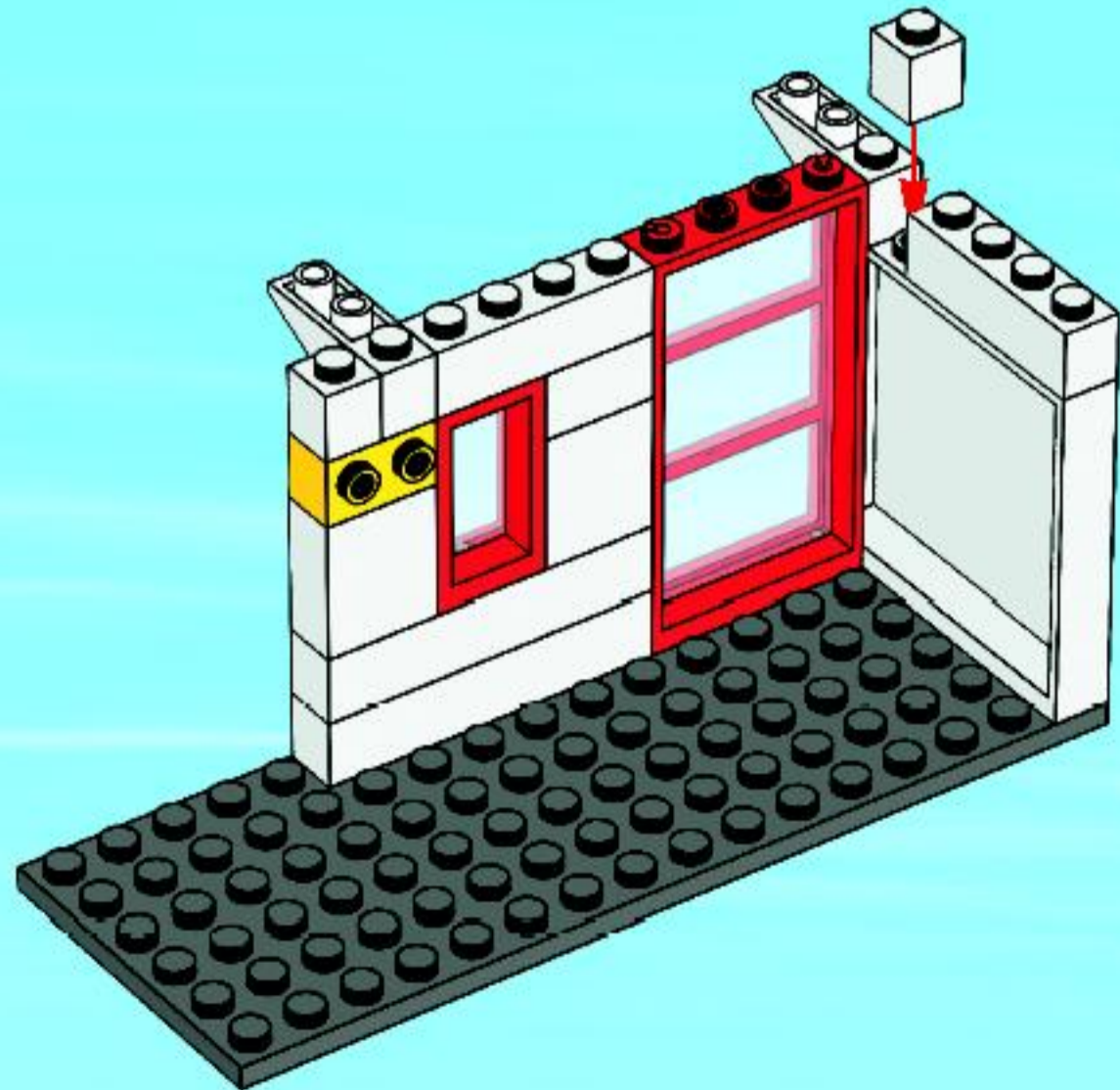

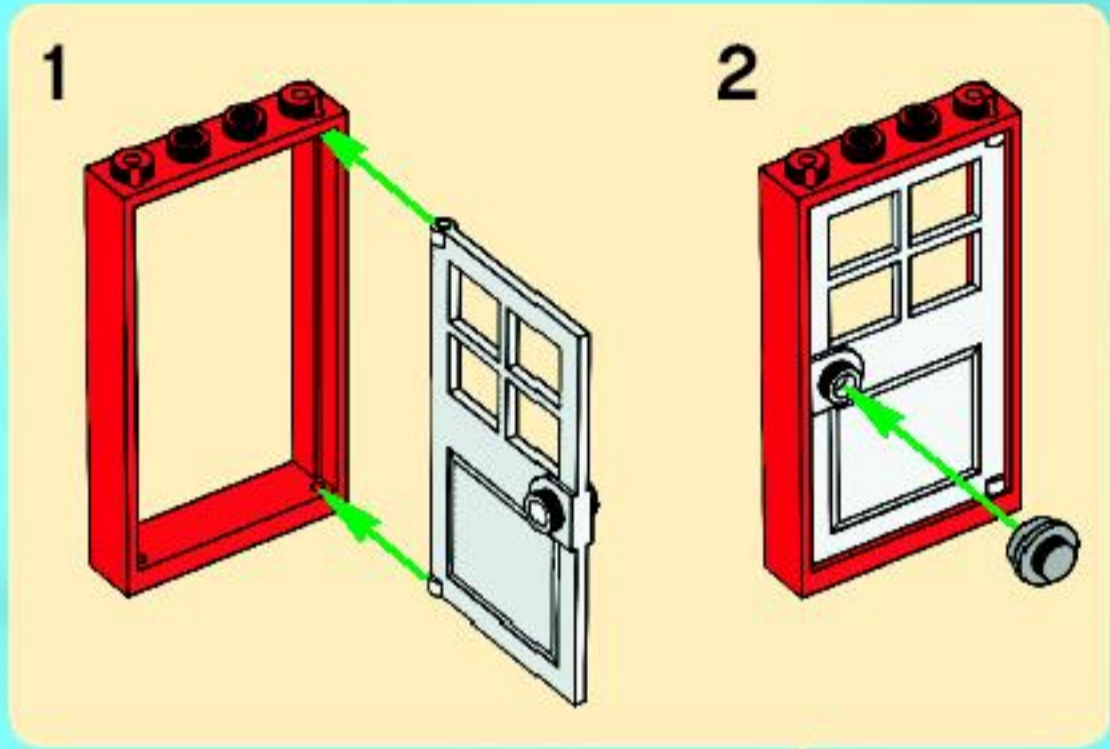

9

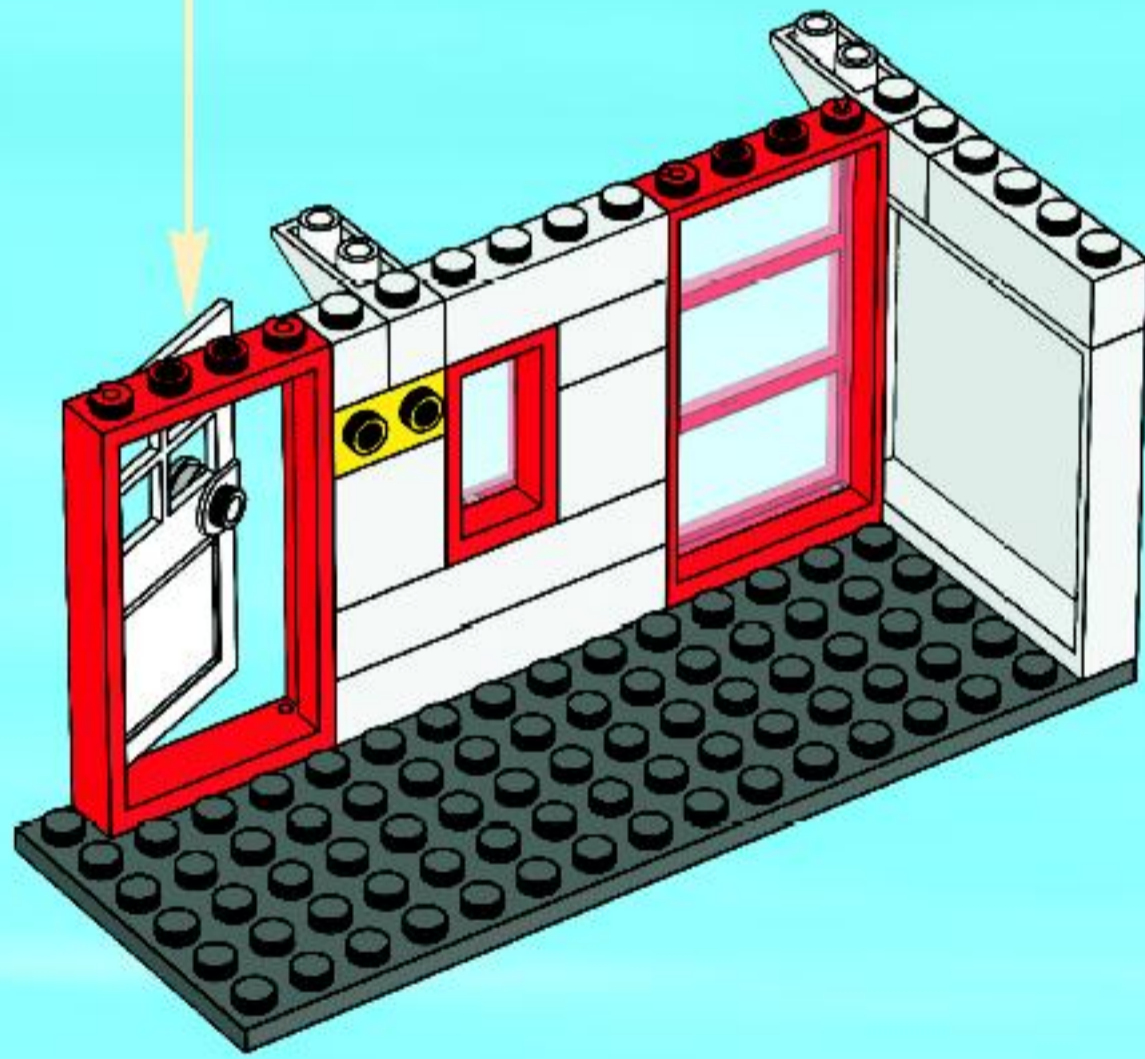

10

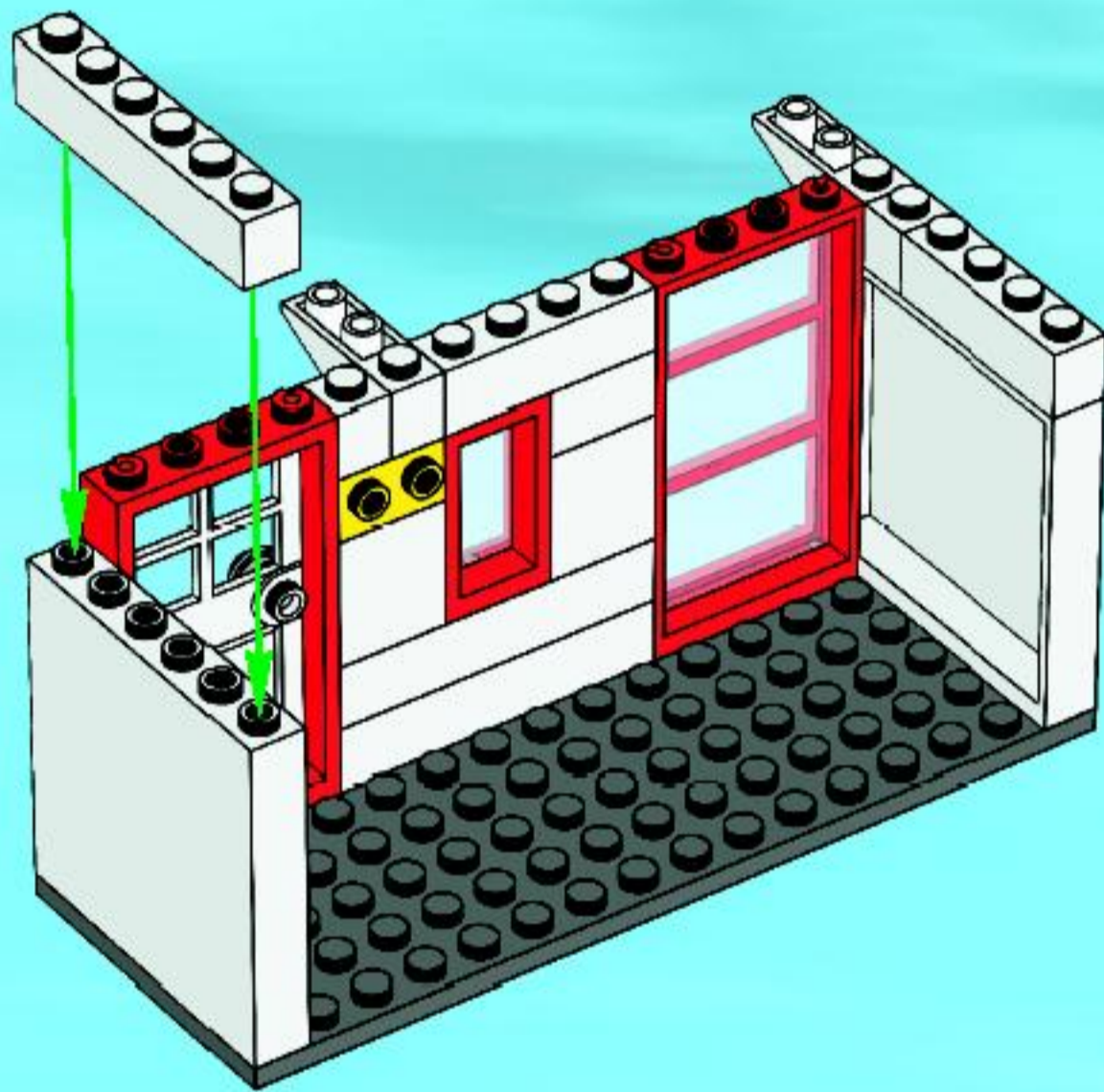

11

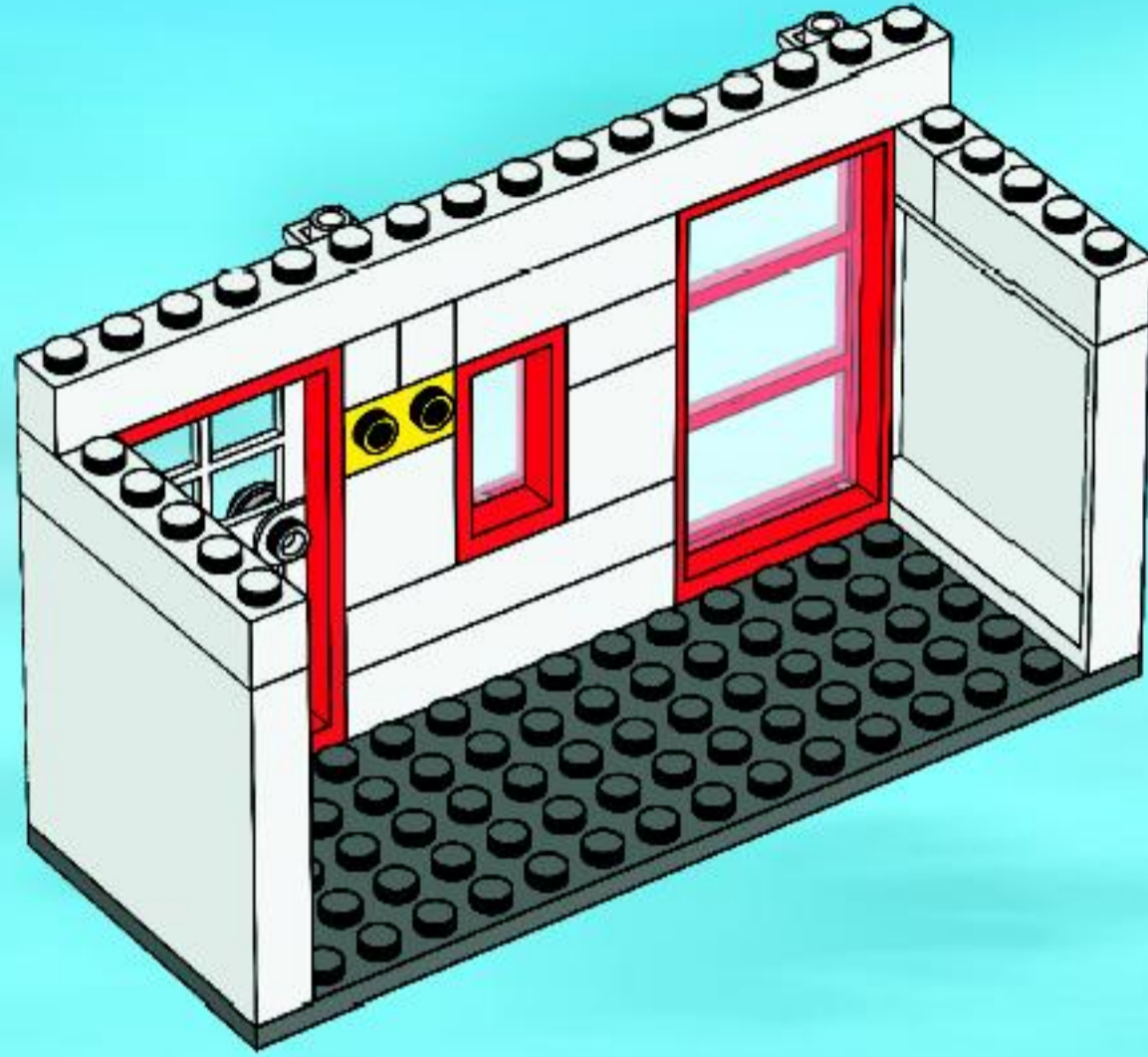

12

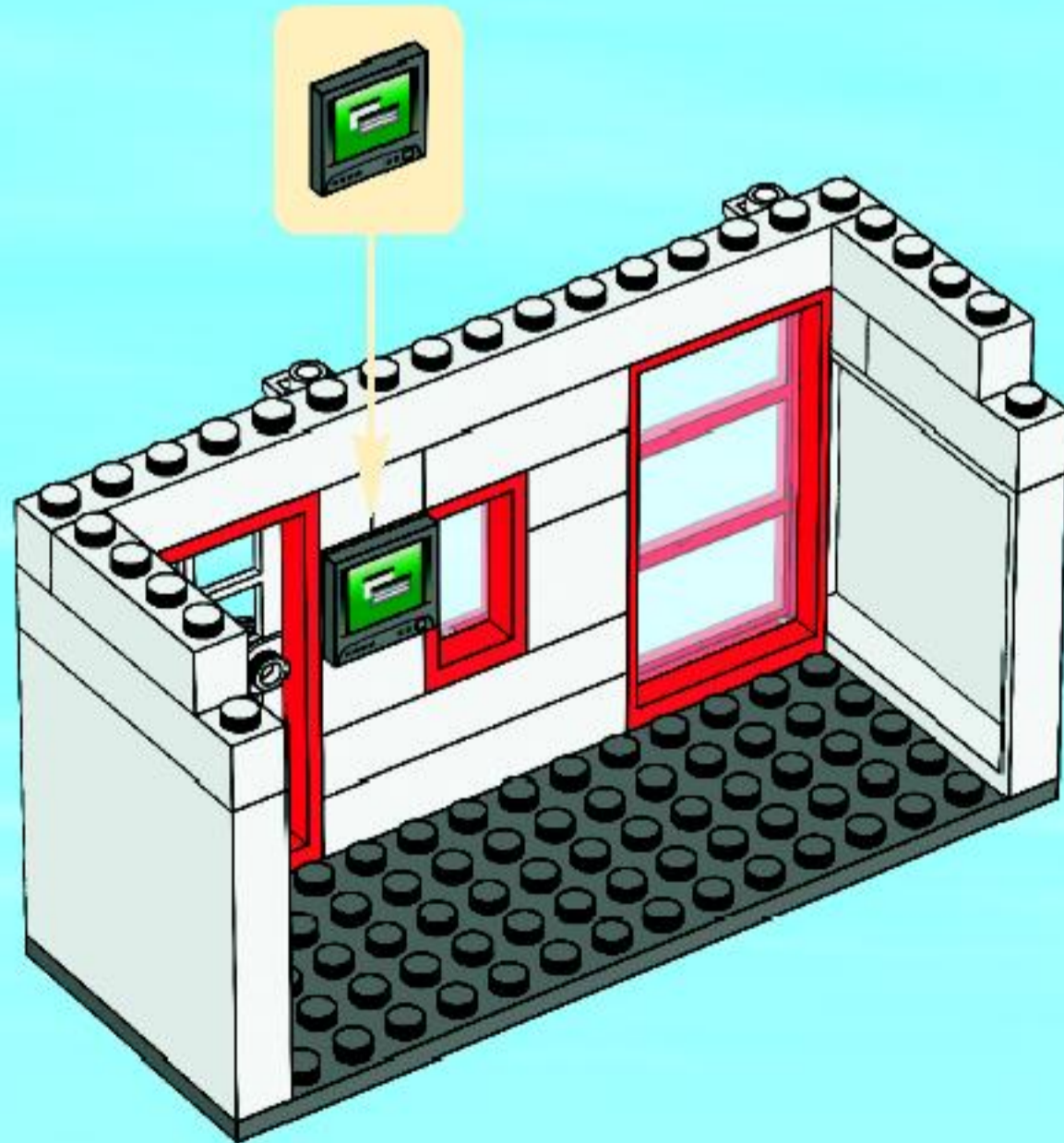

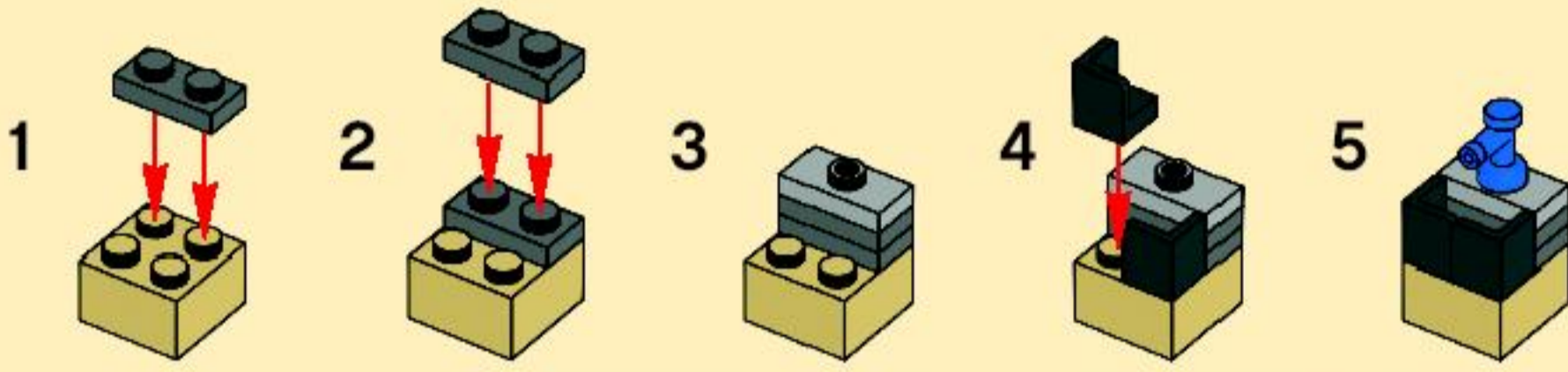

13

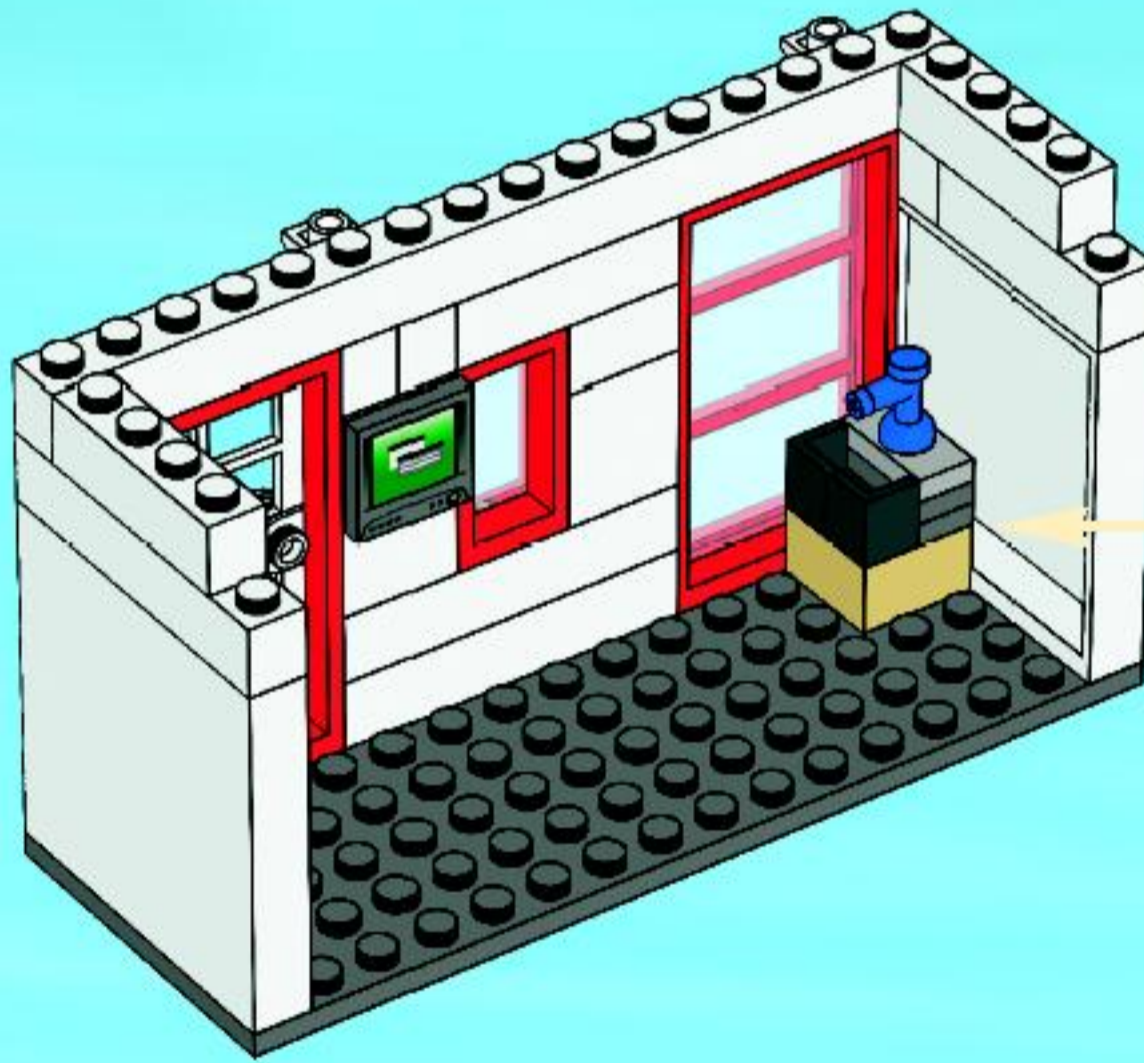

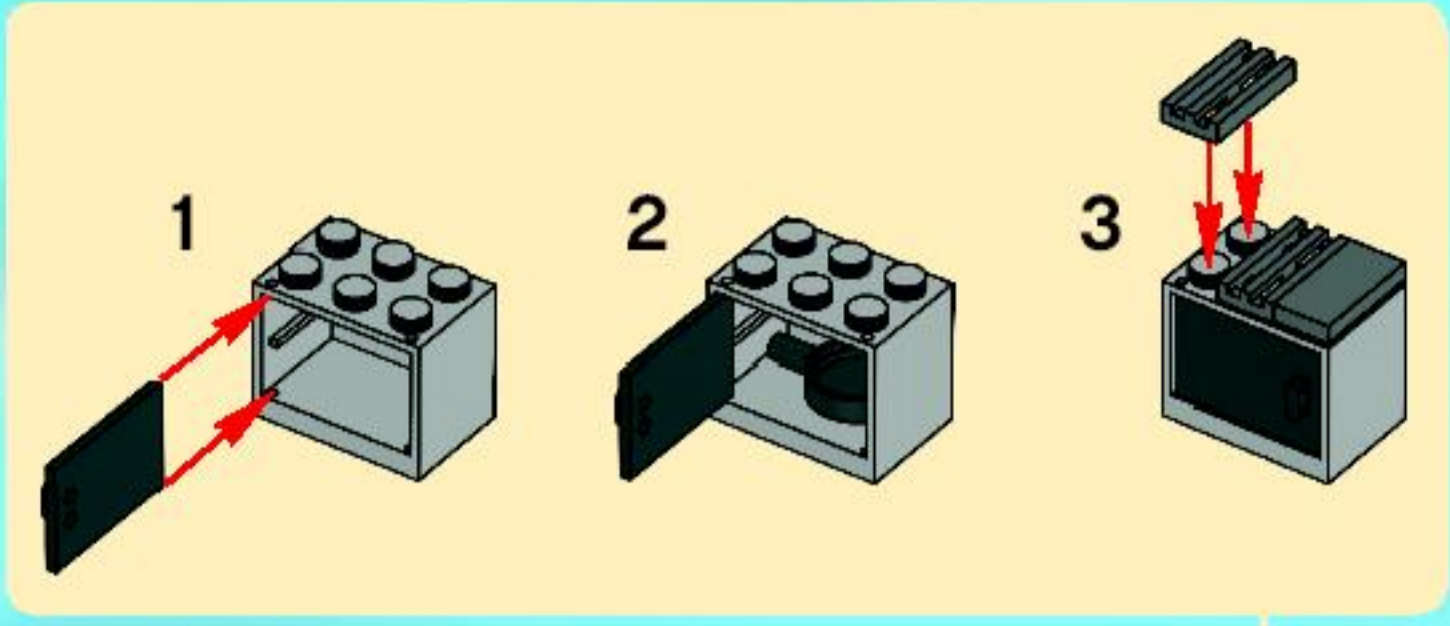

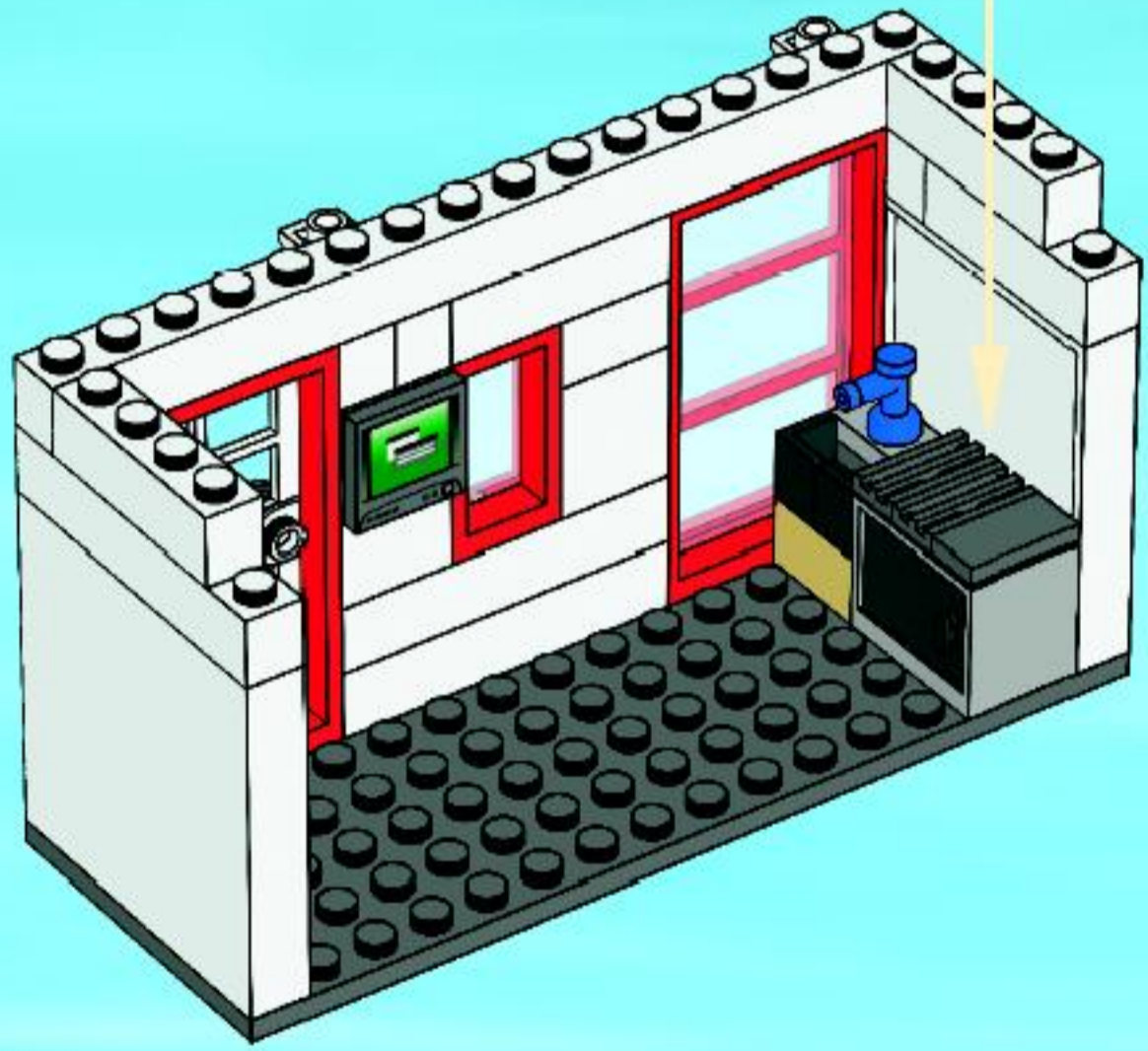

14



15

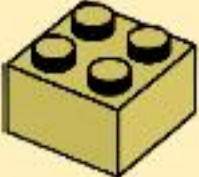
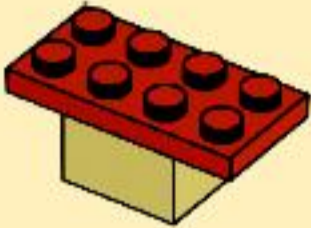

- 1 
- 2 
- 3 

16

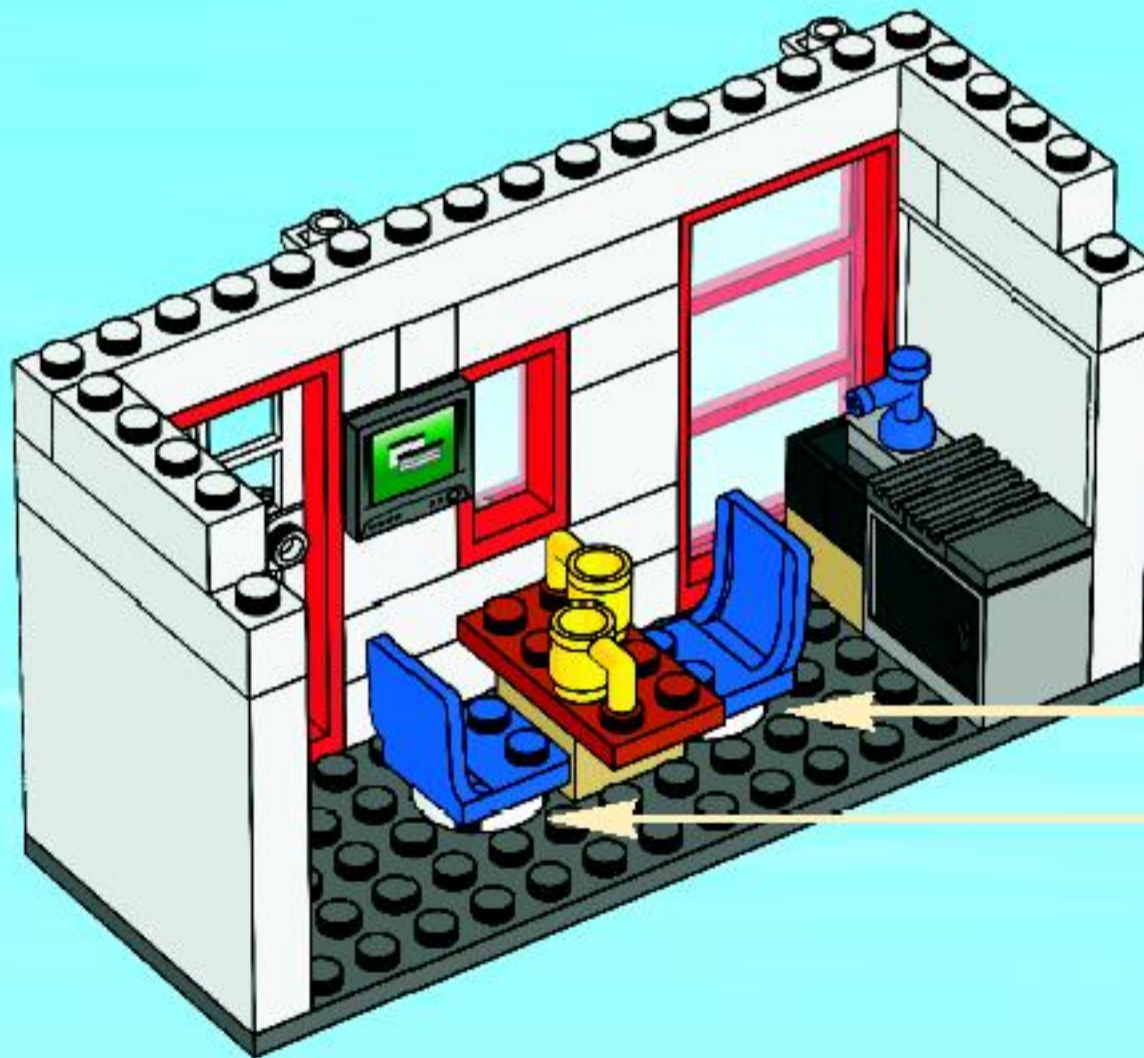

- 

2x

17

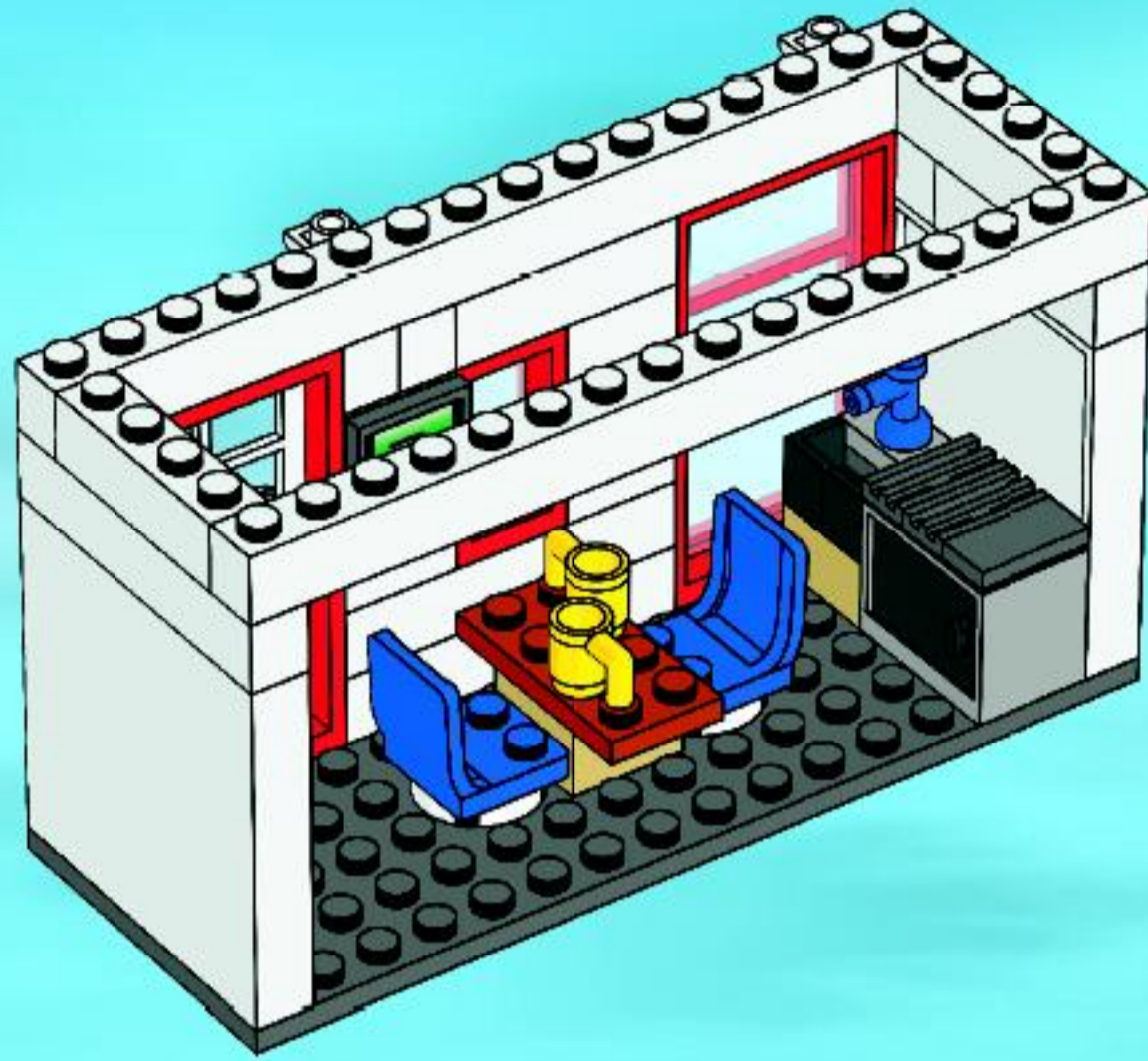

18

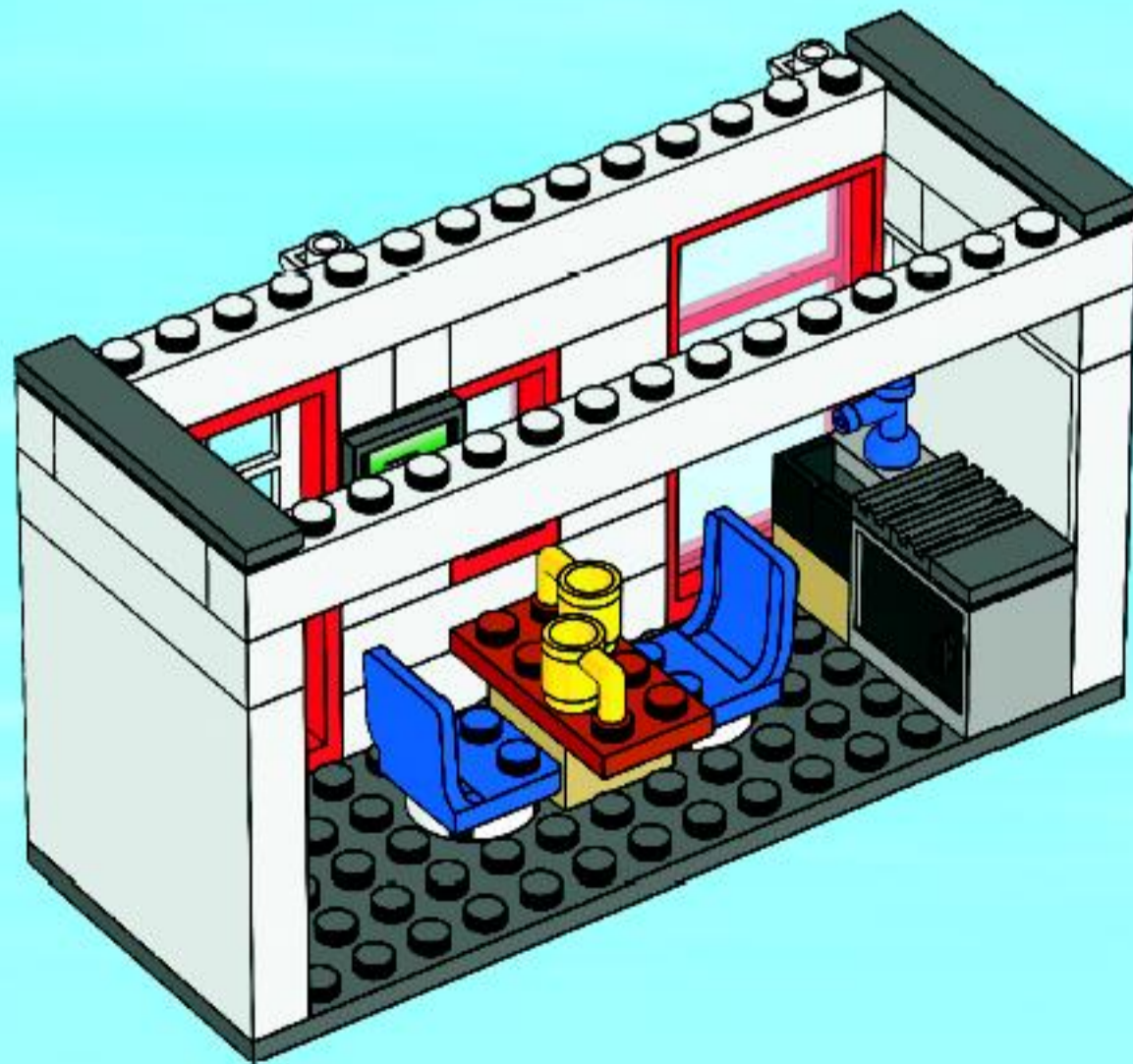

19

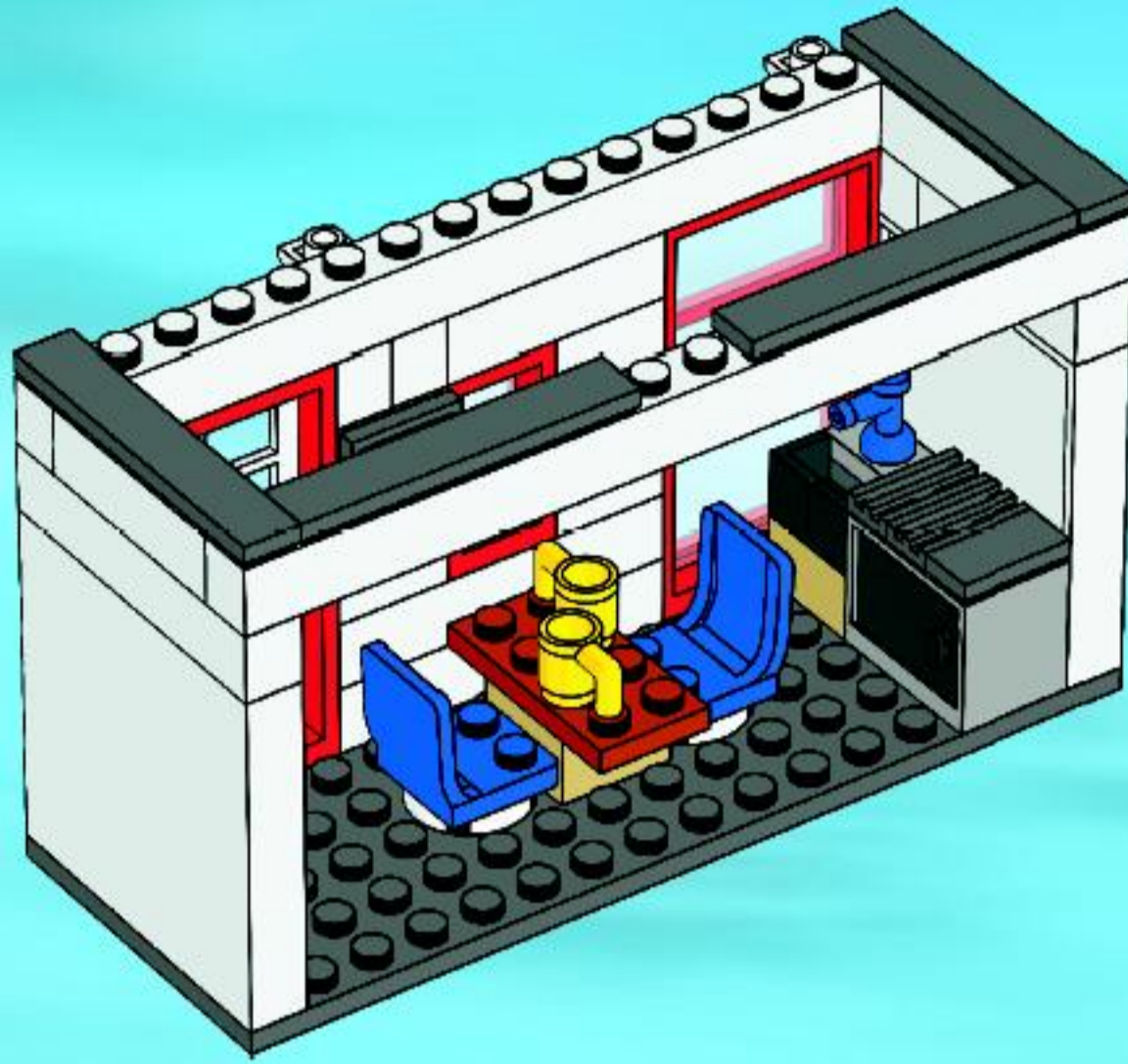

20

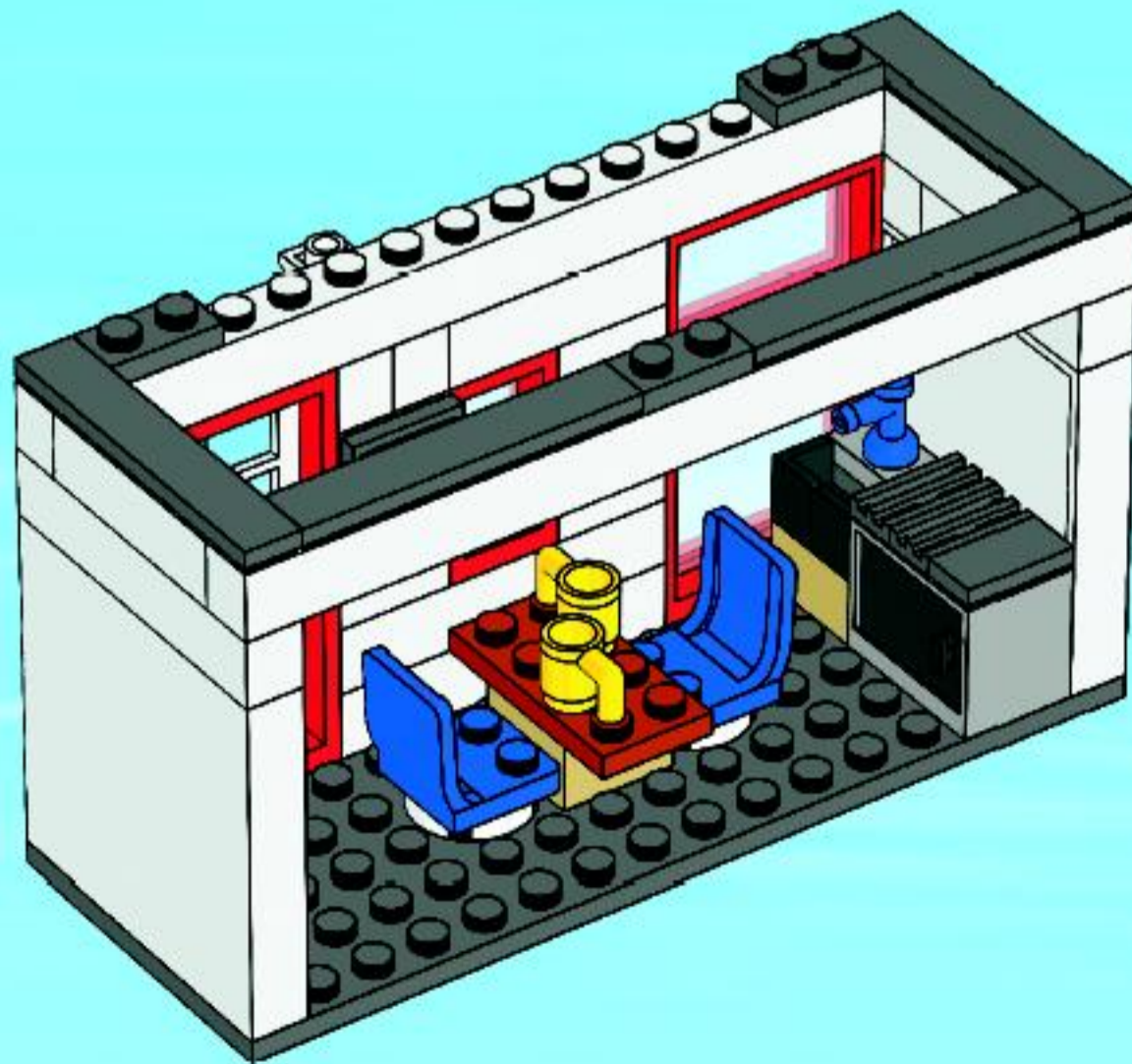

21

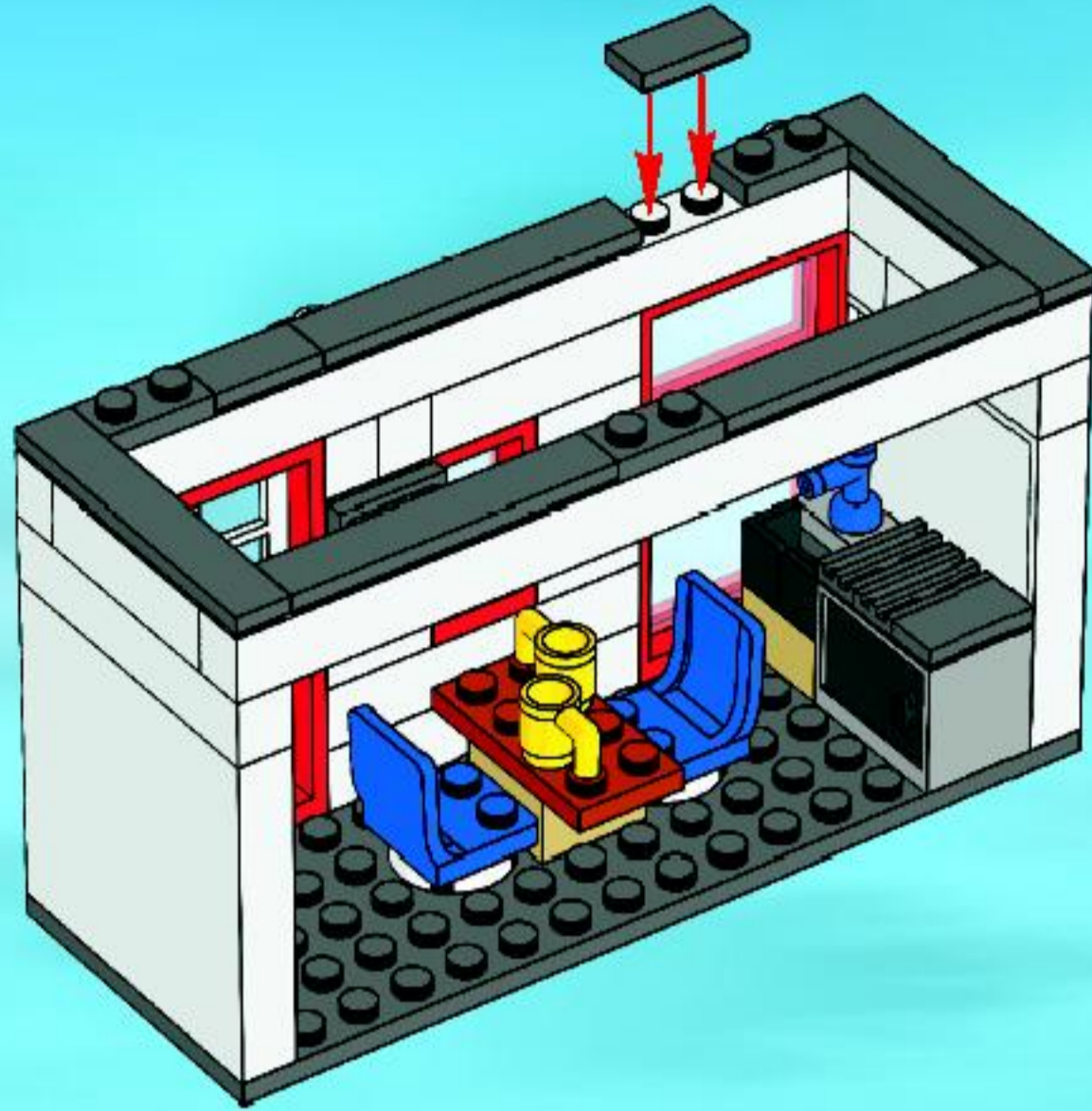

22

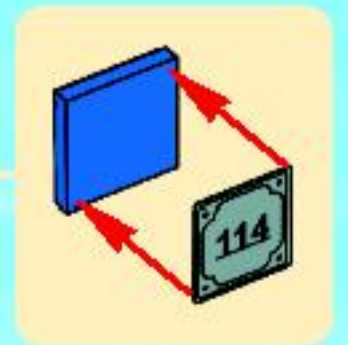
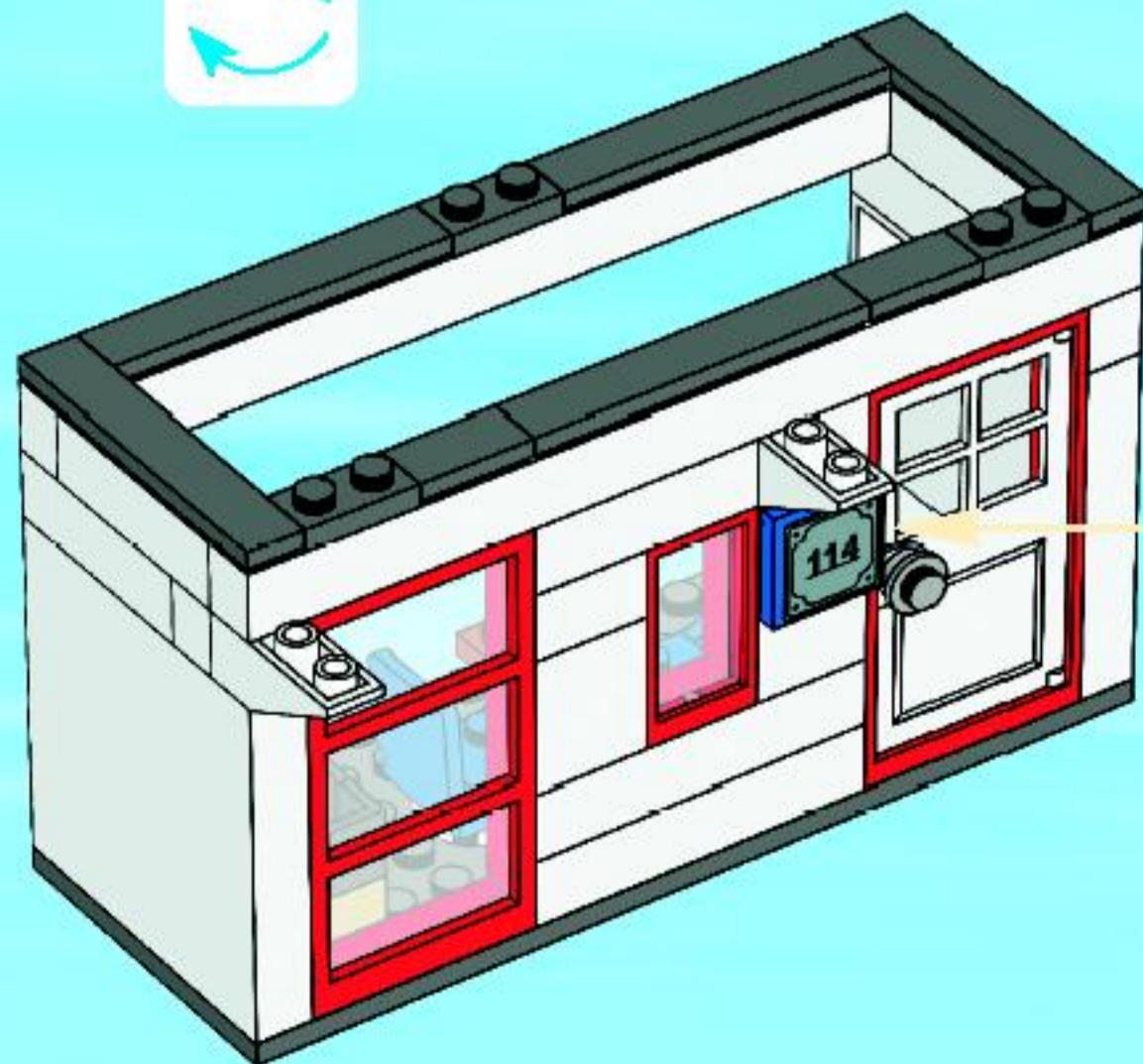

1



2

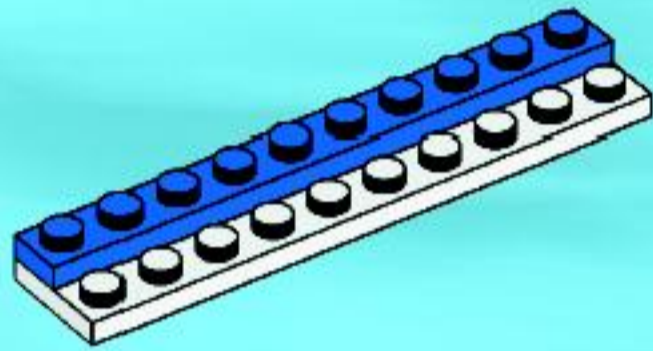

3

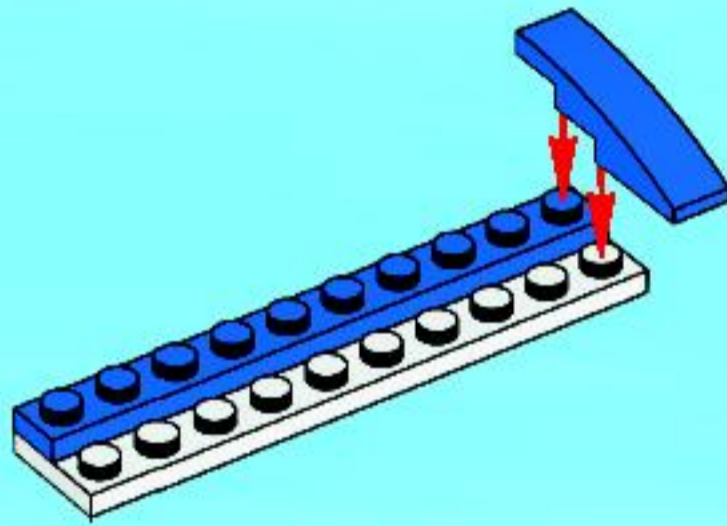

4

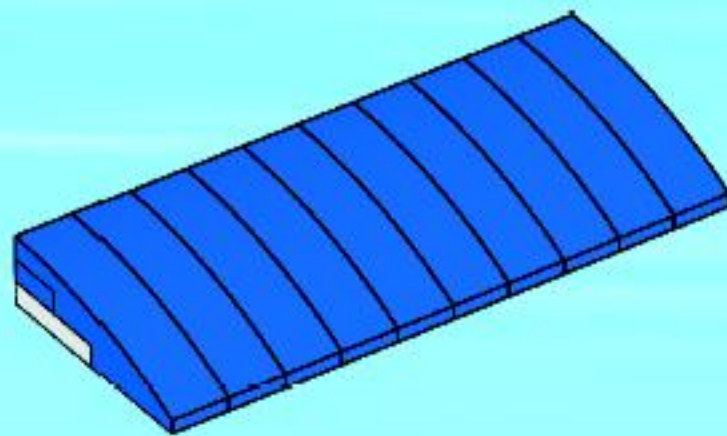

23



24

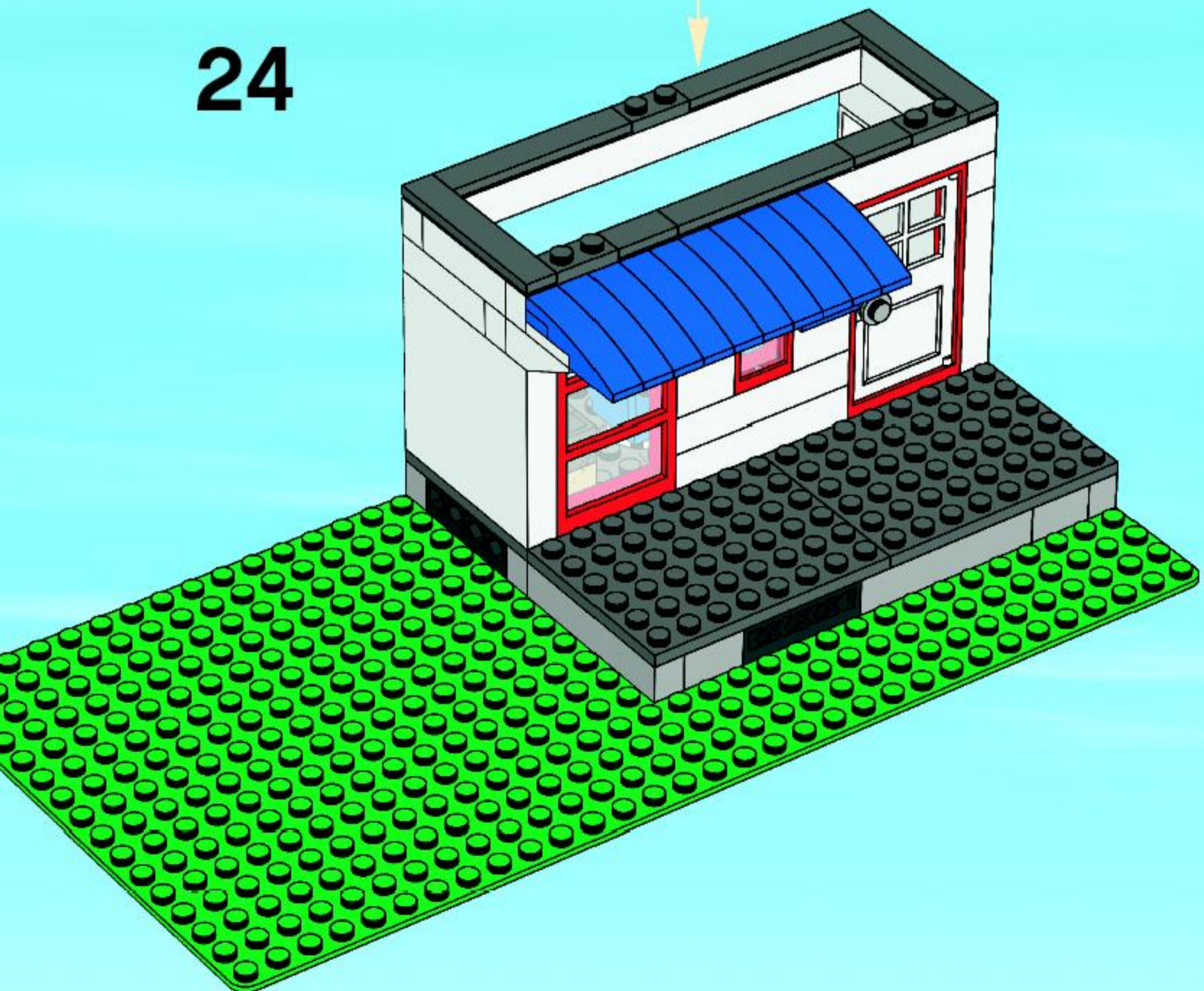

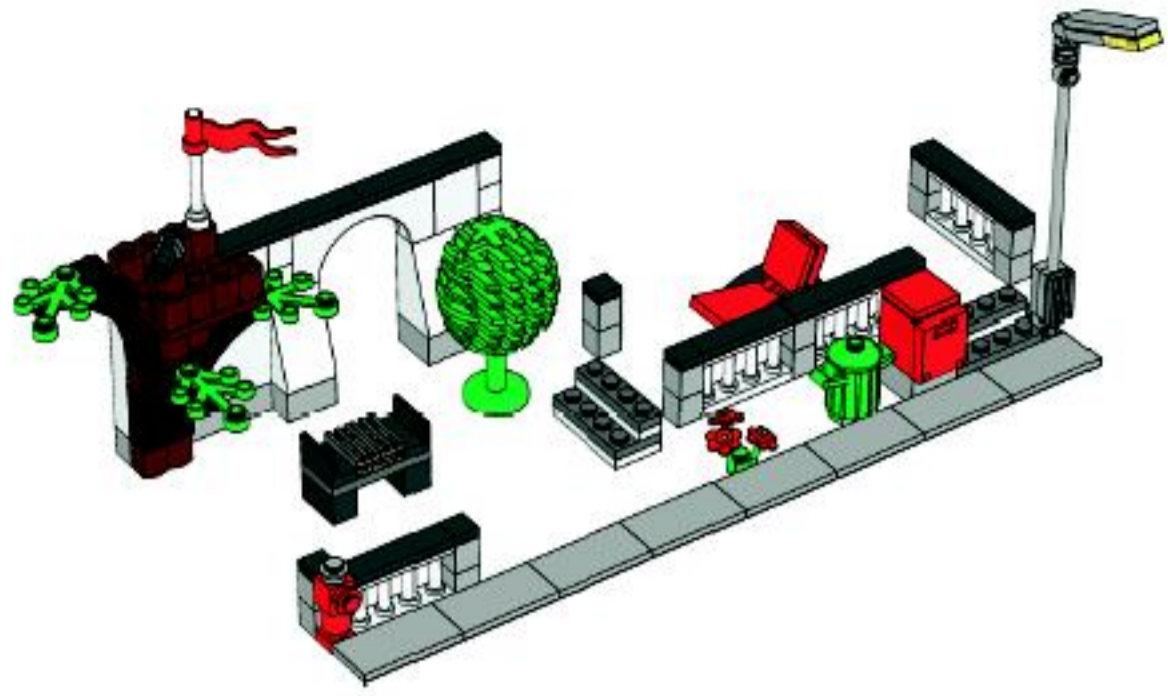

1

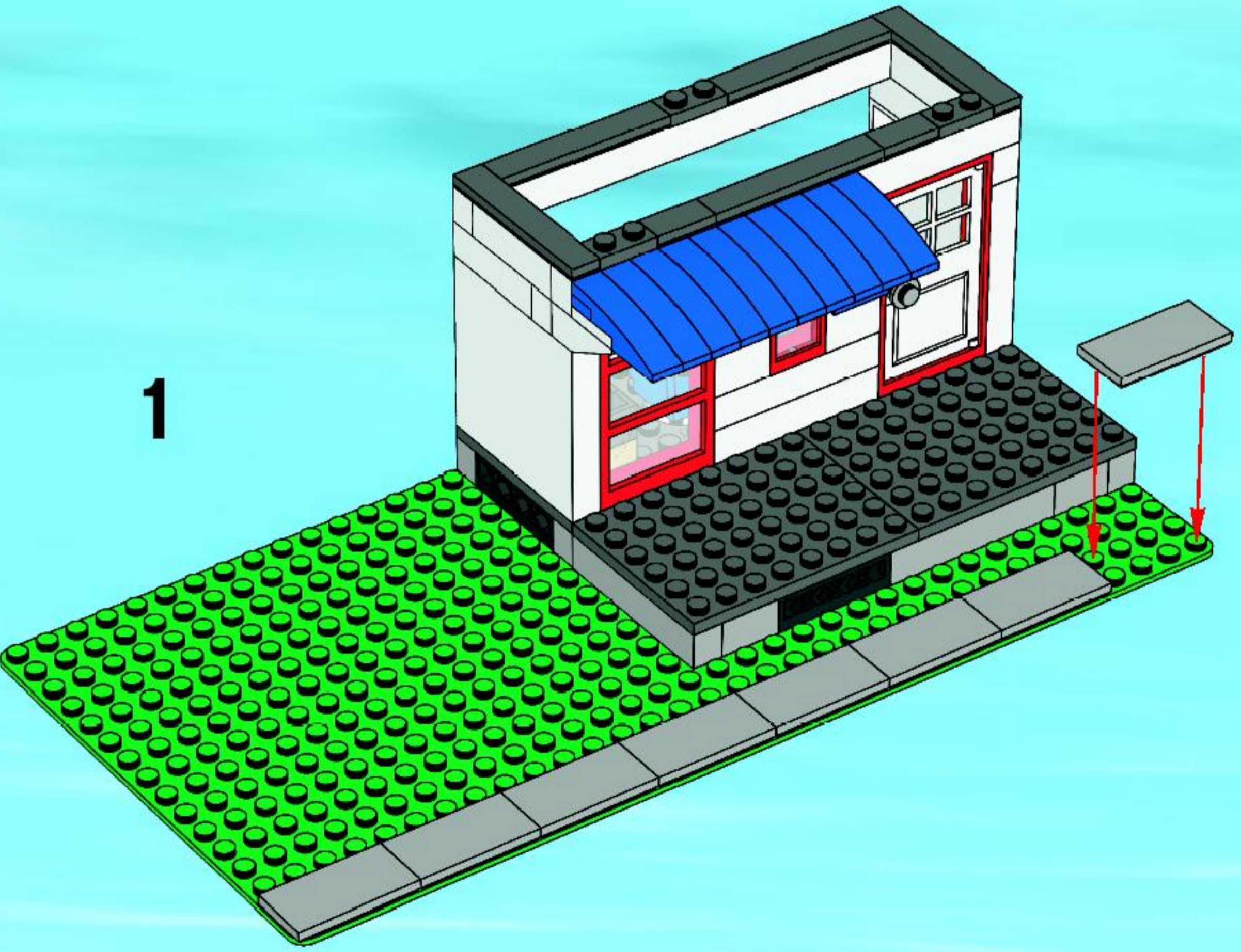

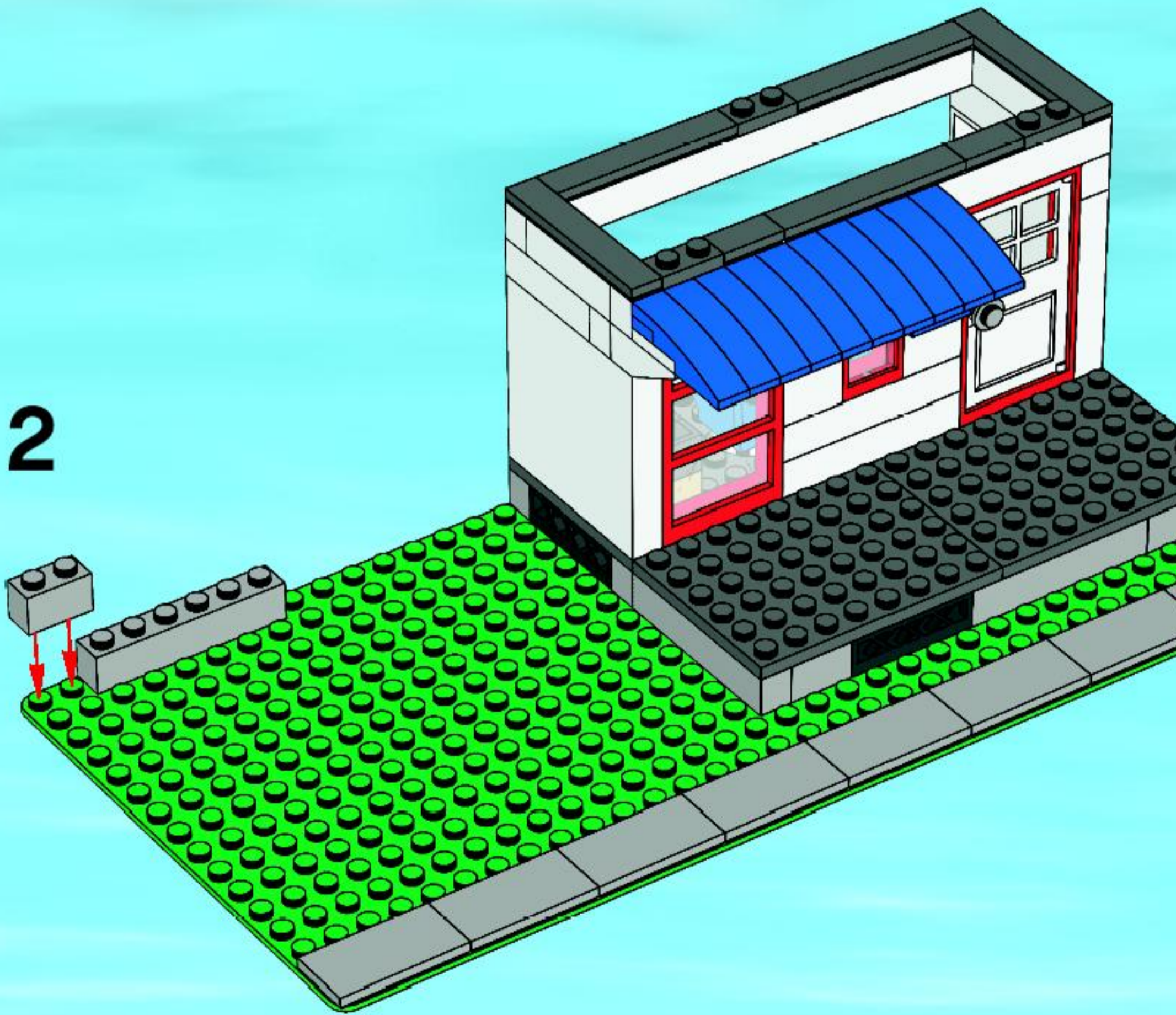

3

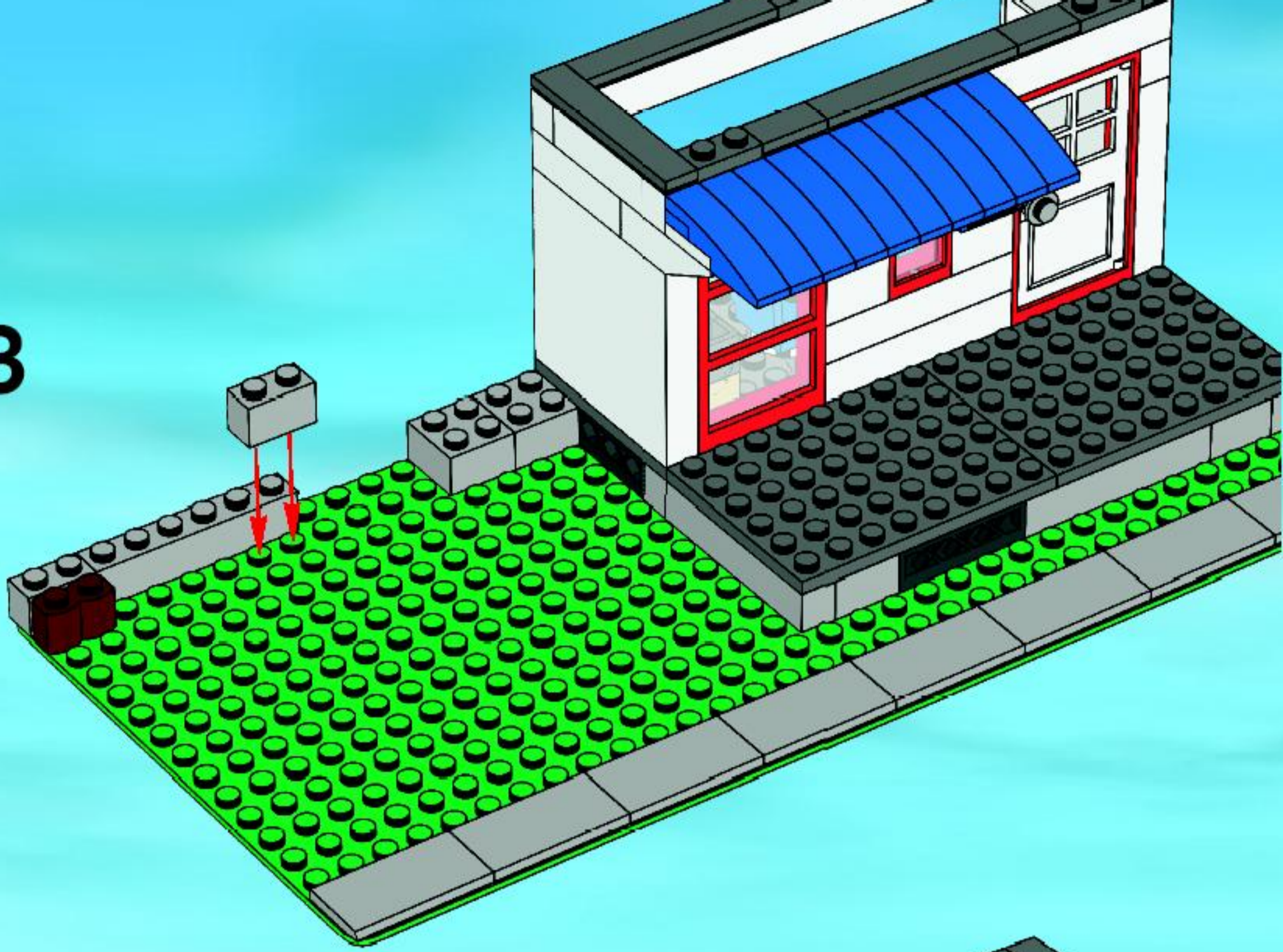

4

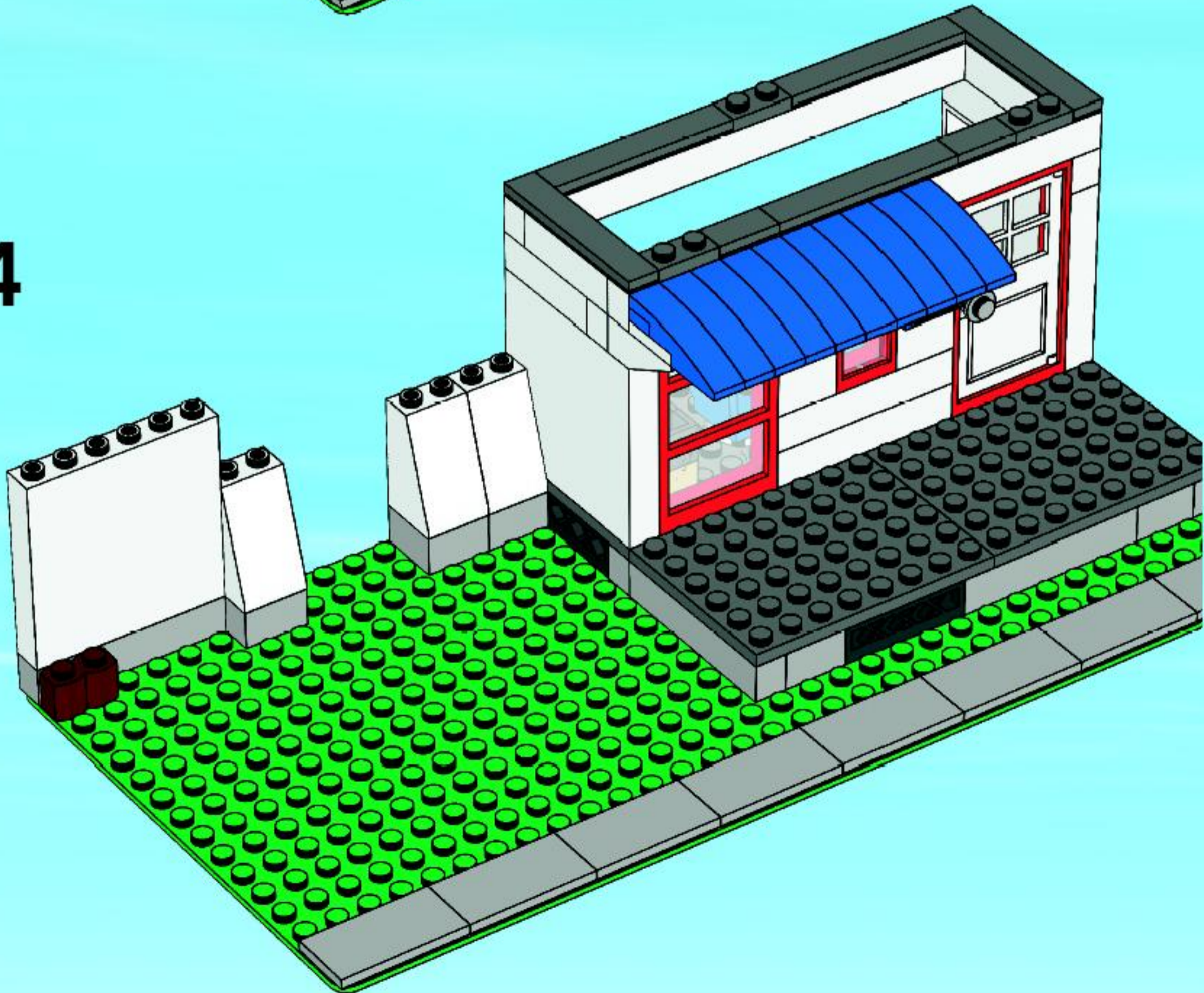

5

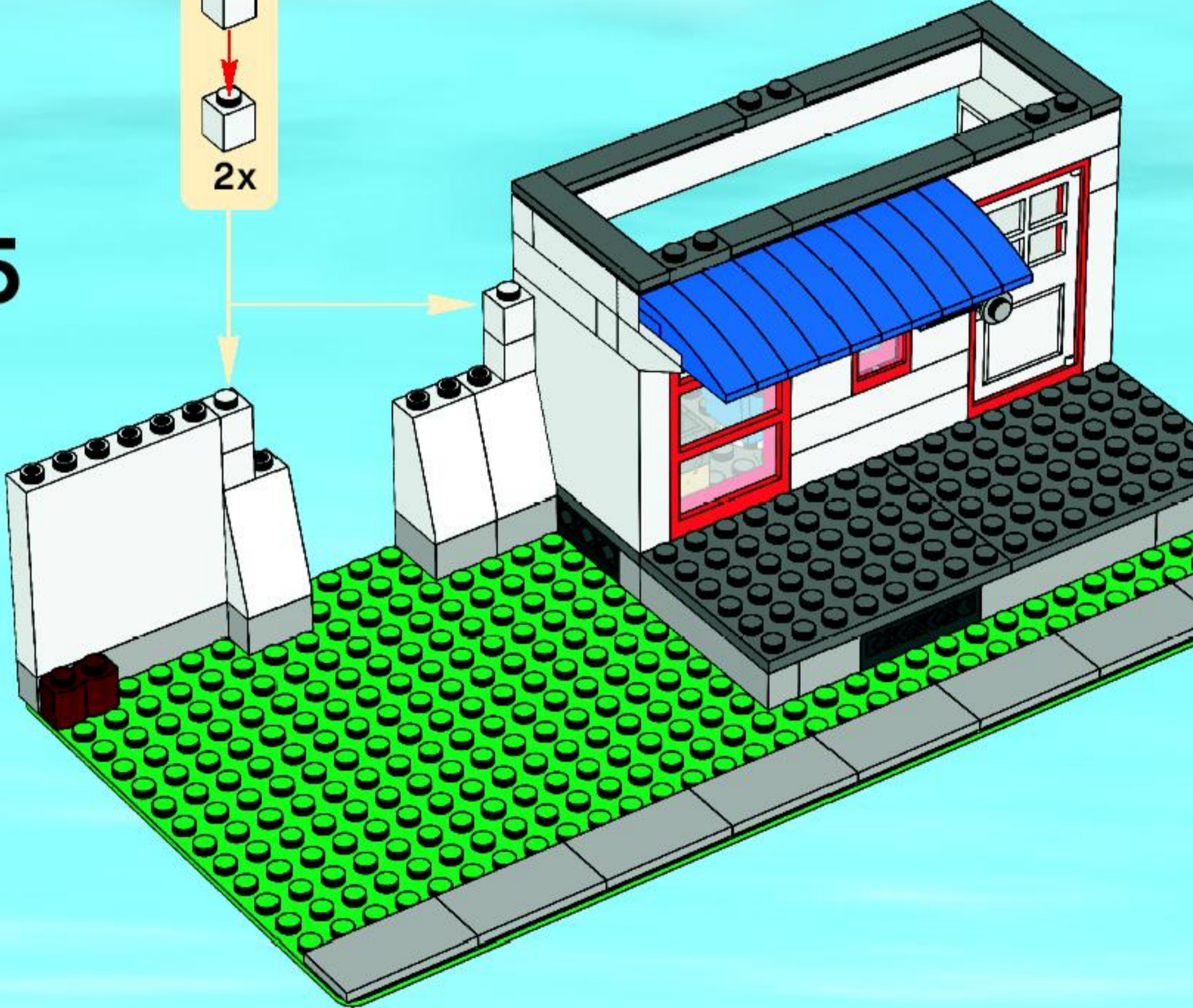
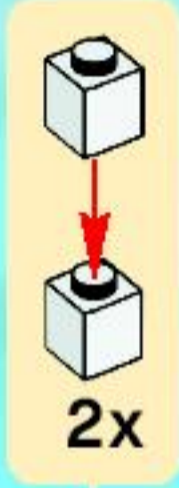

6

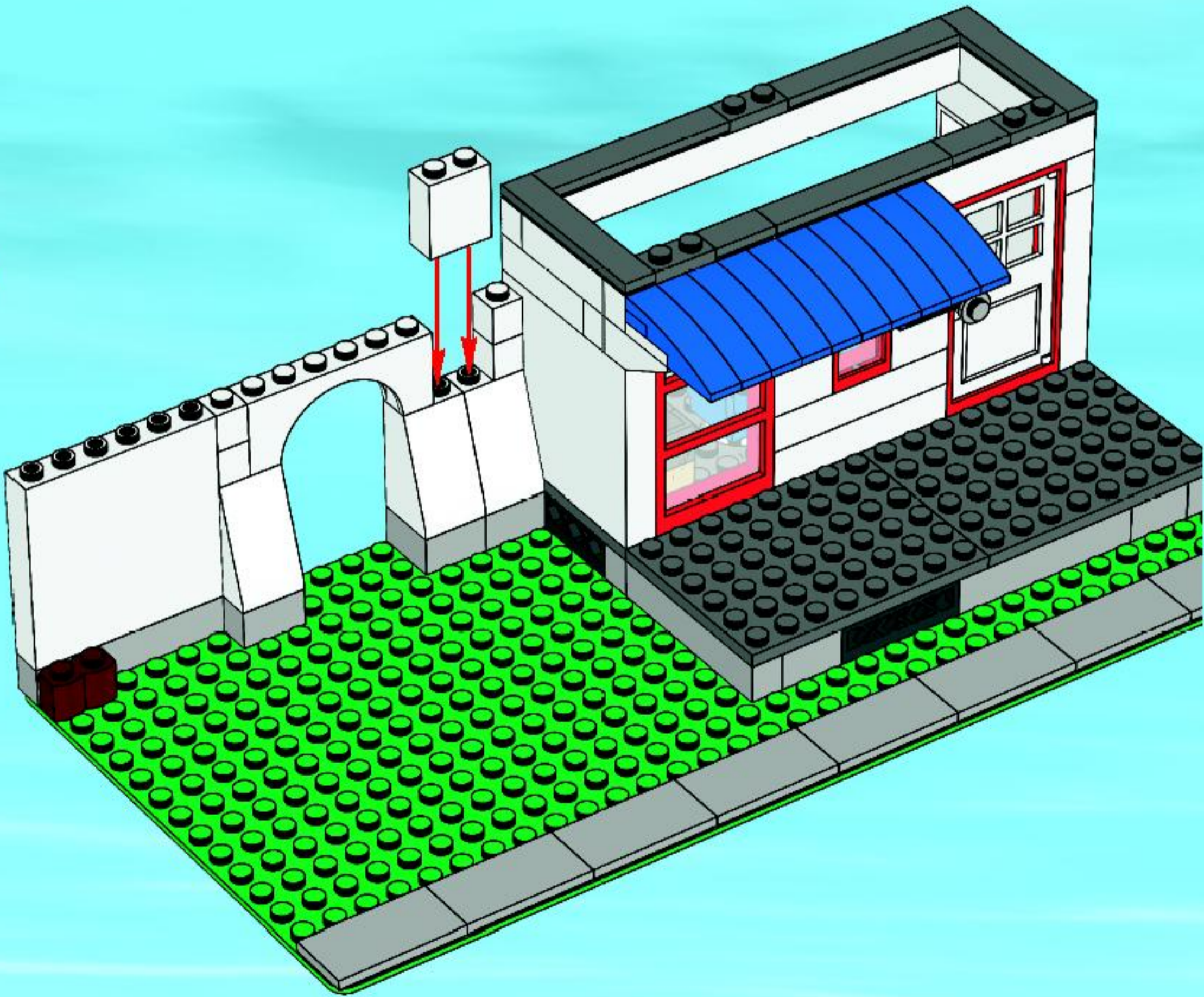

7

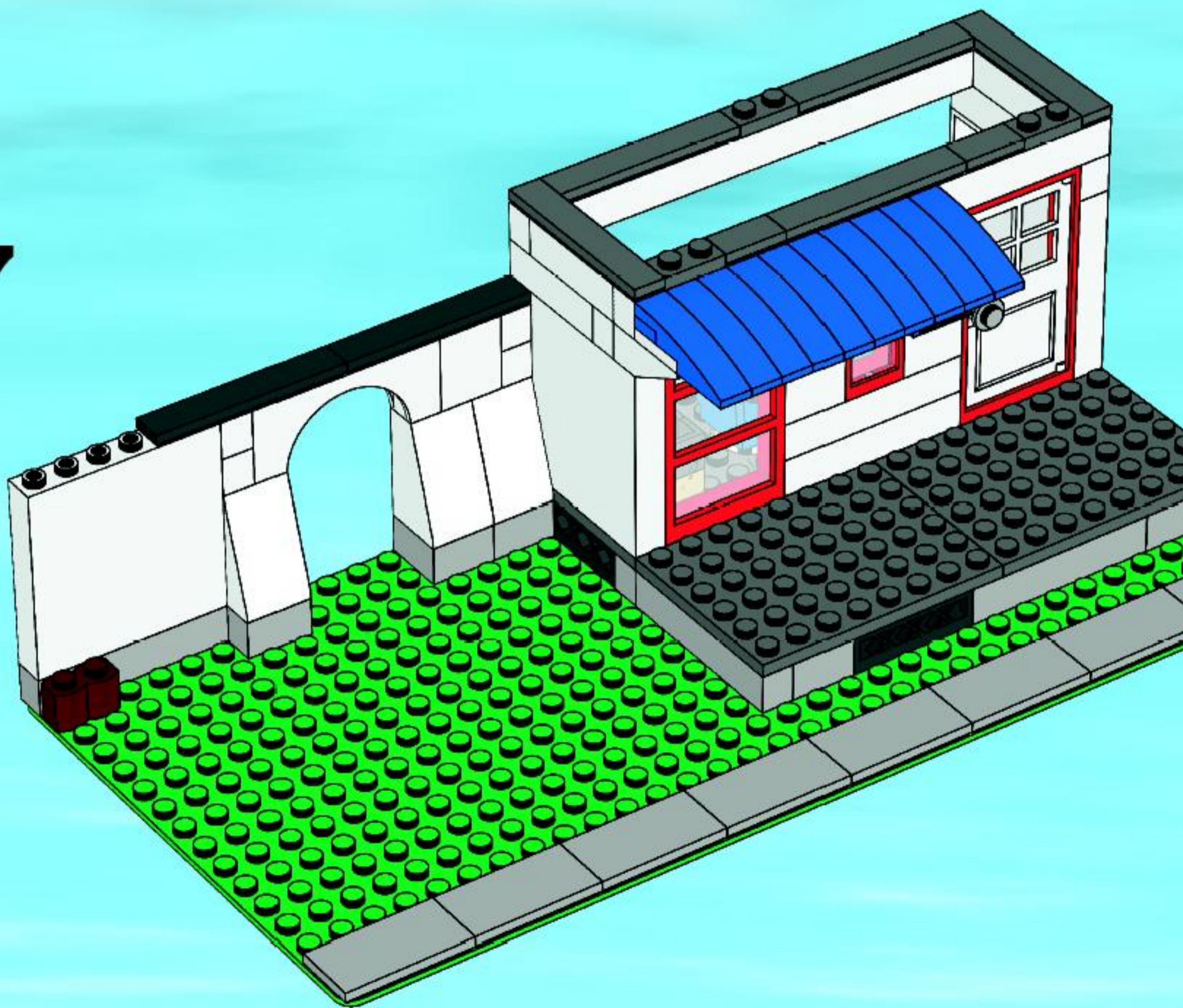

8

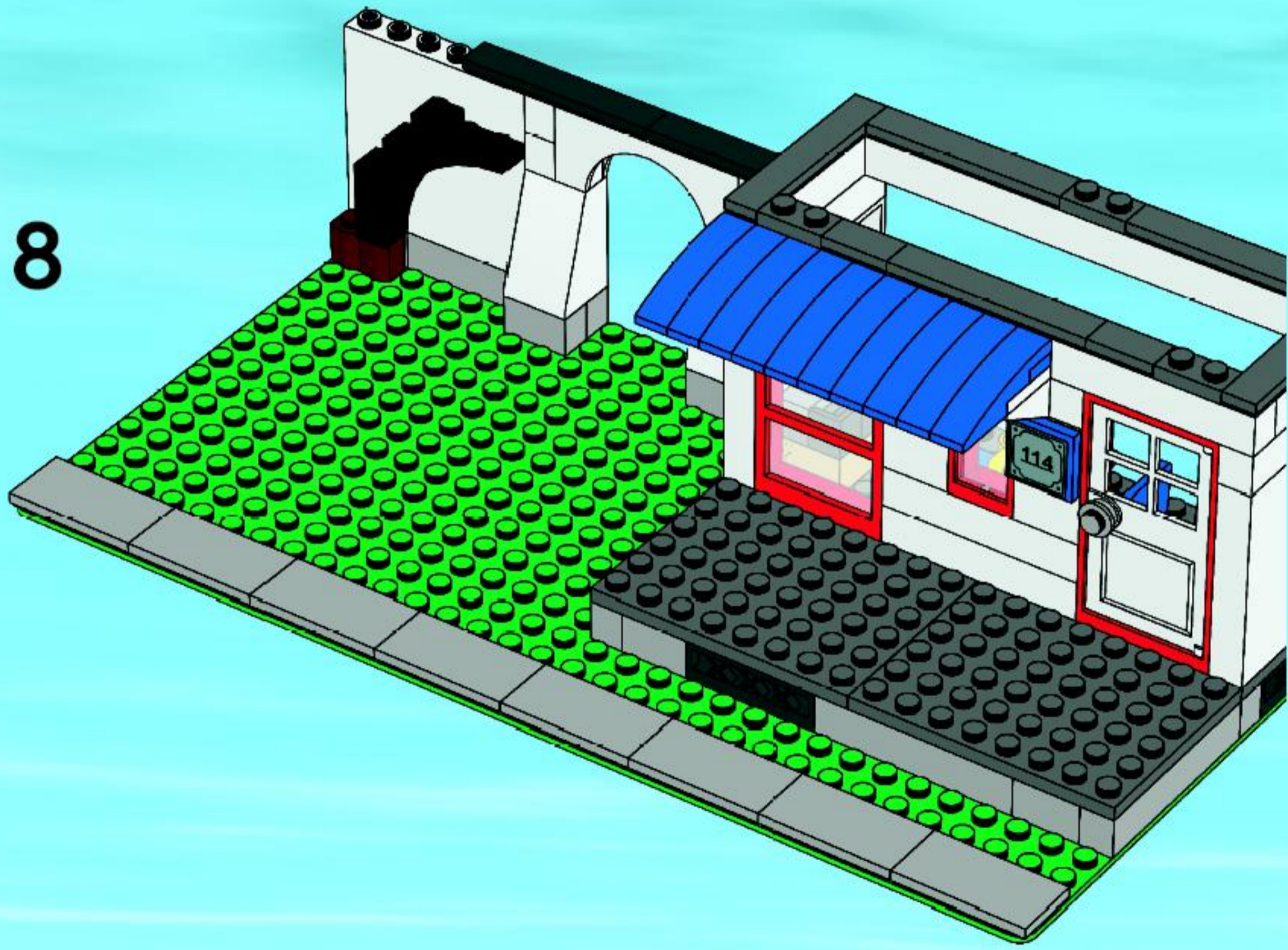

9

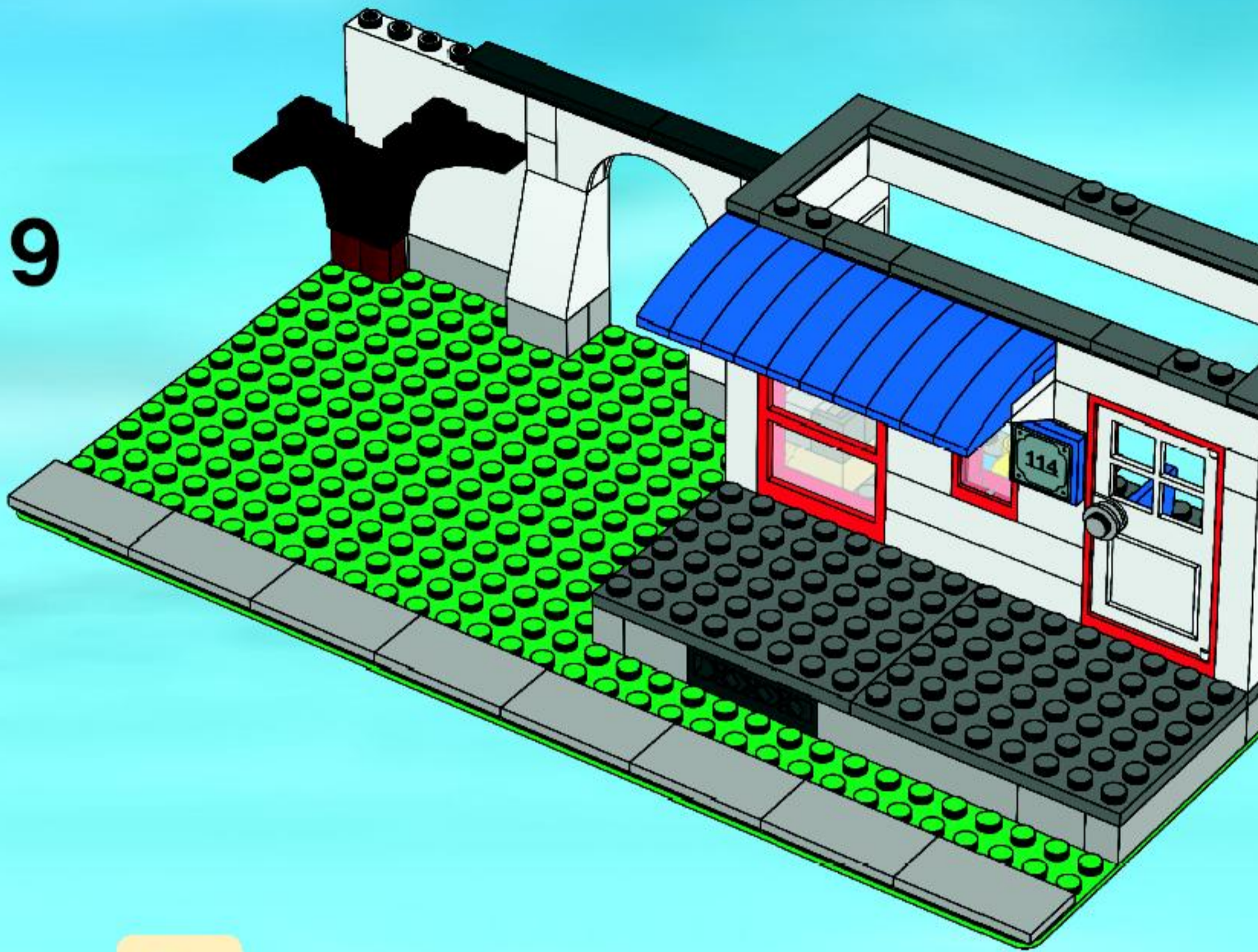

10

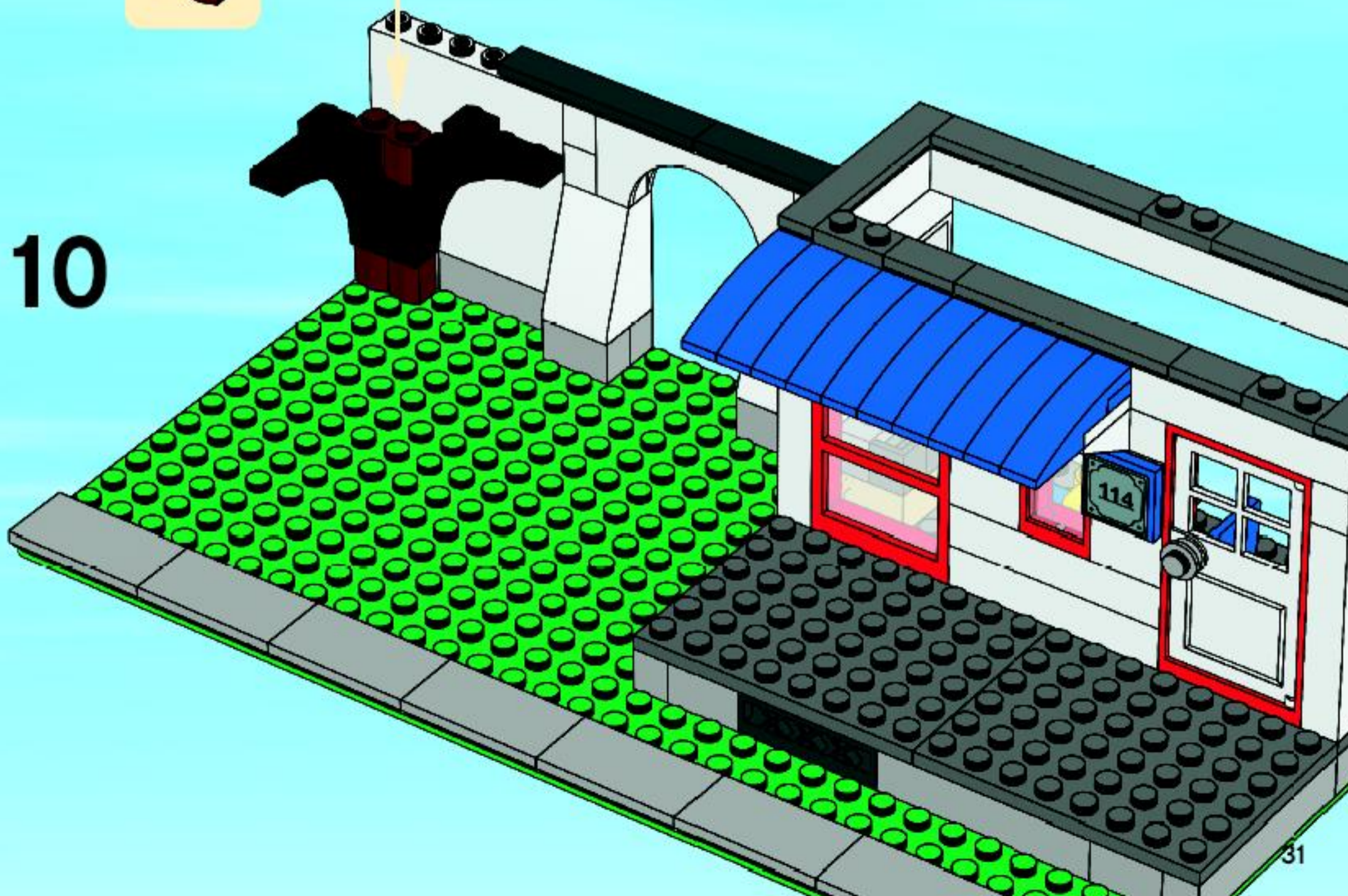

11

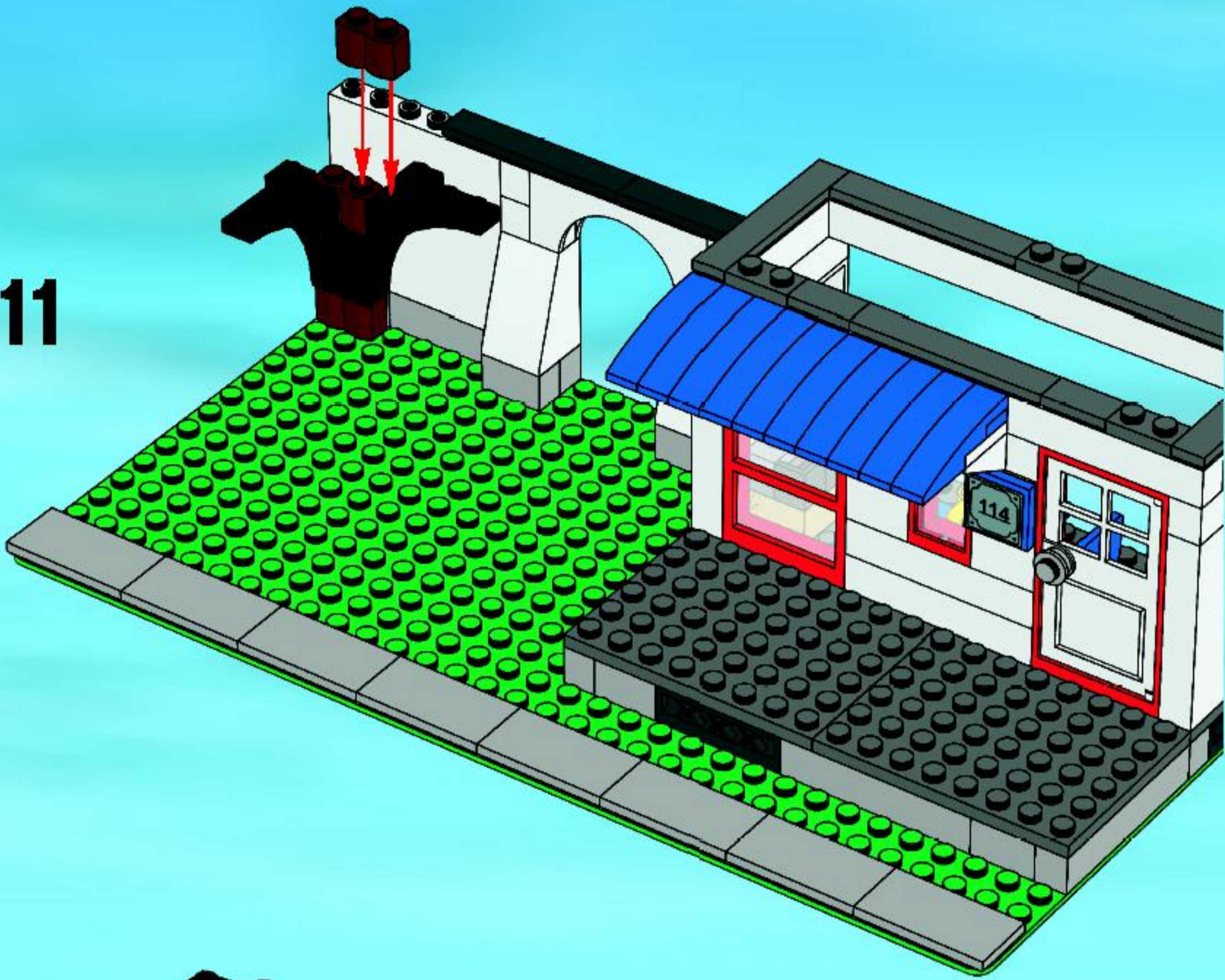

12

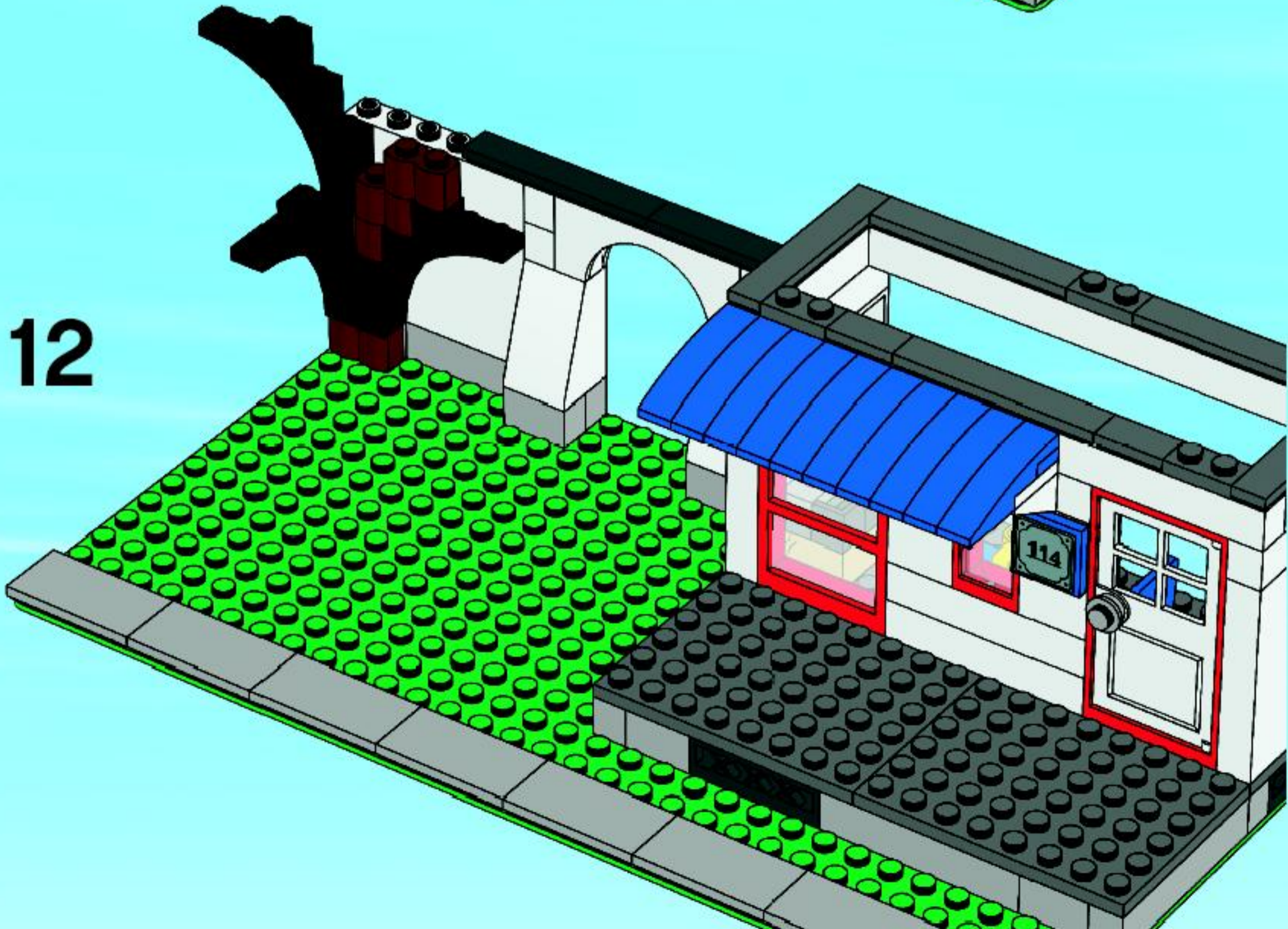

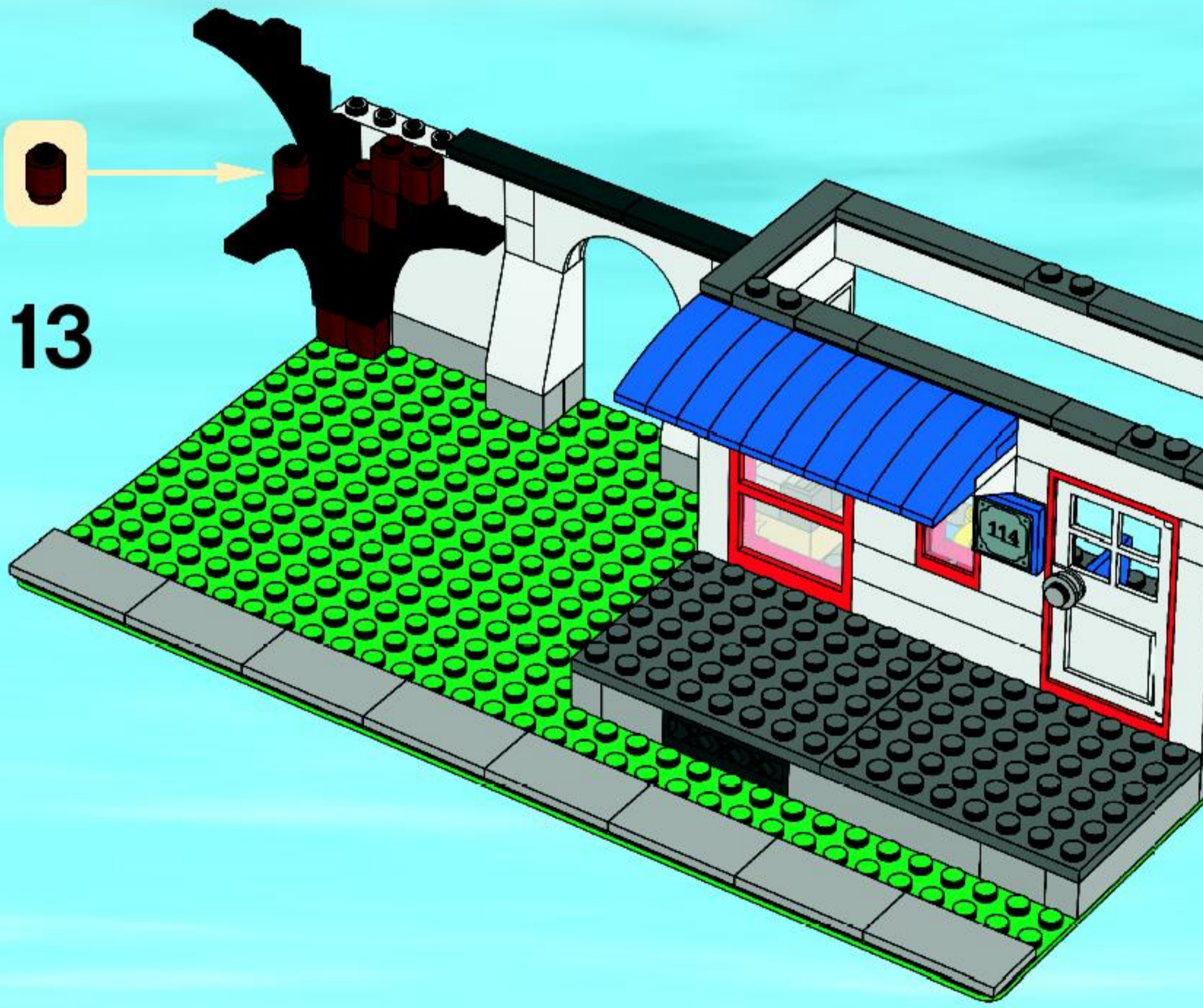

13

14

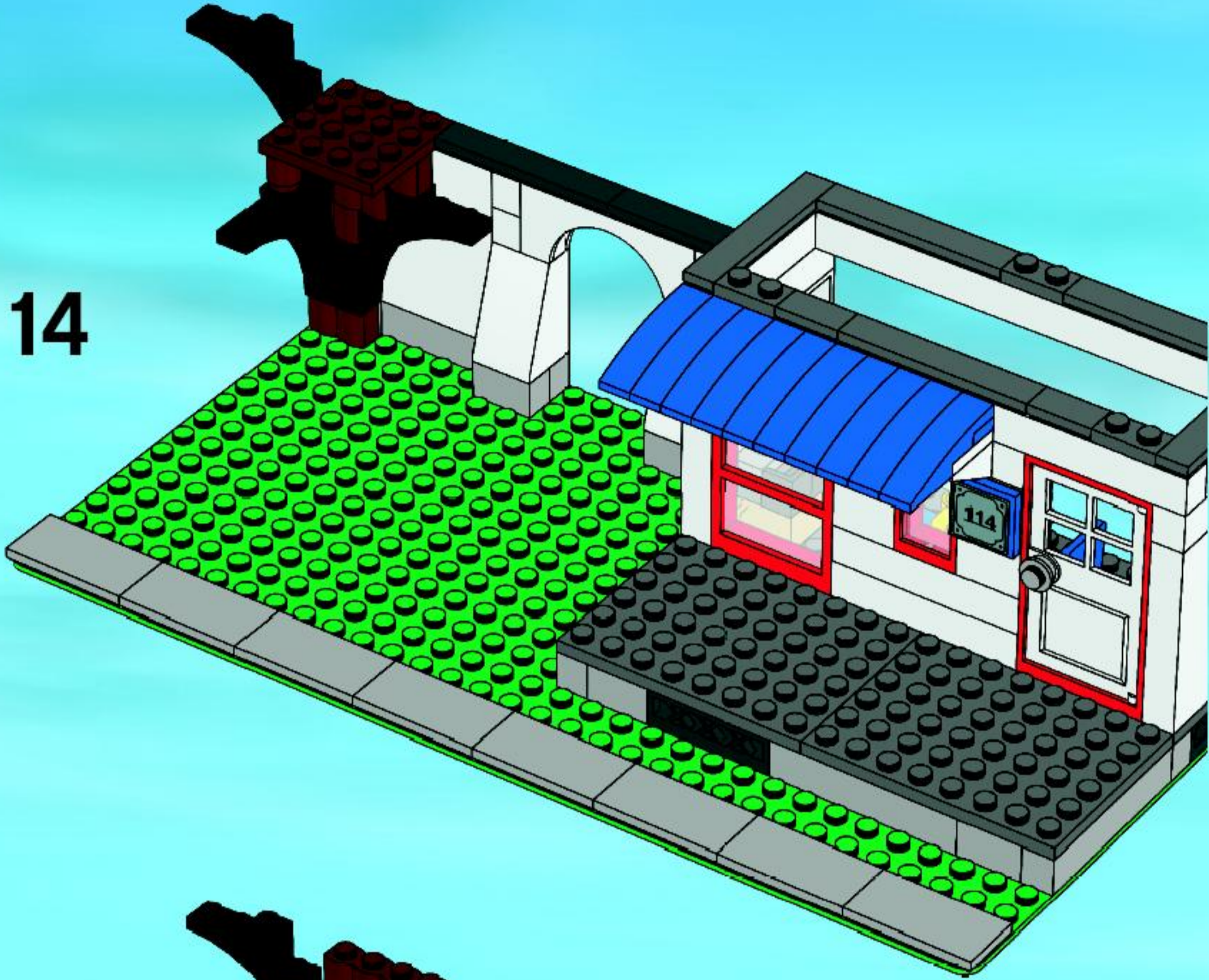

15

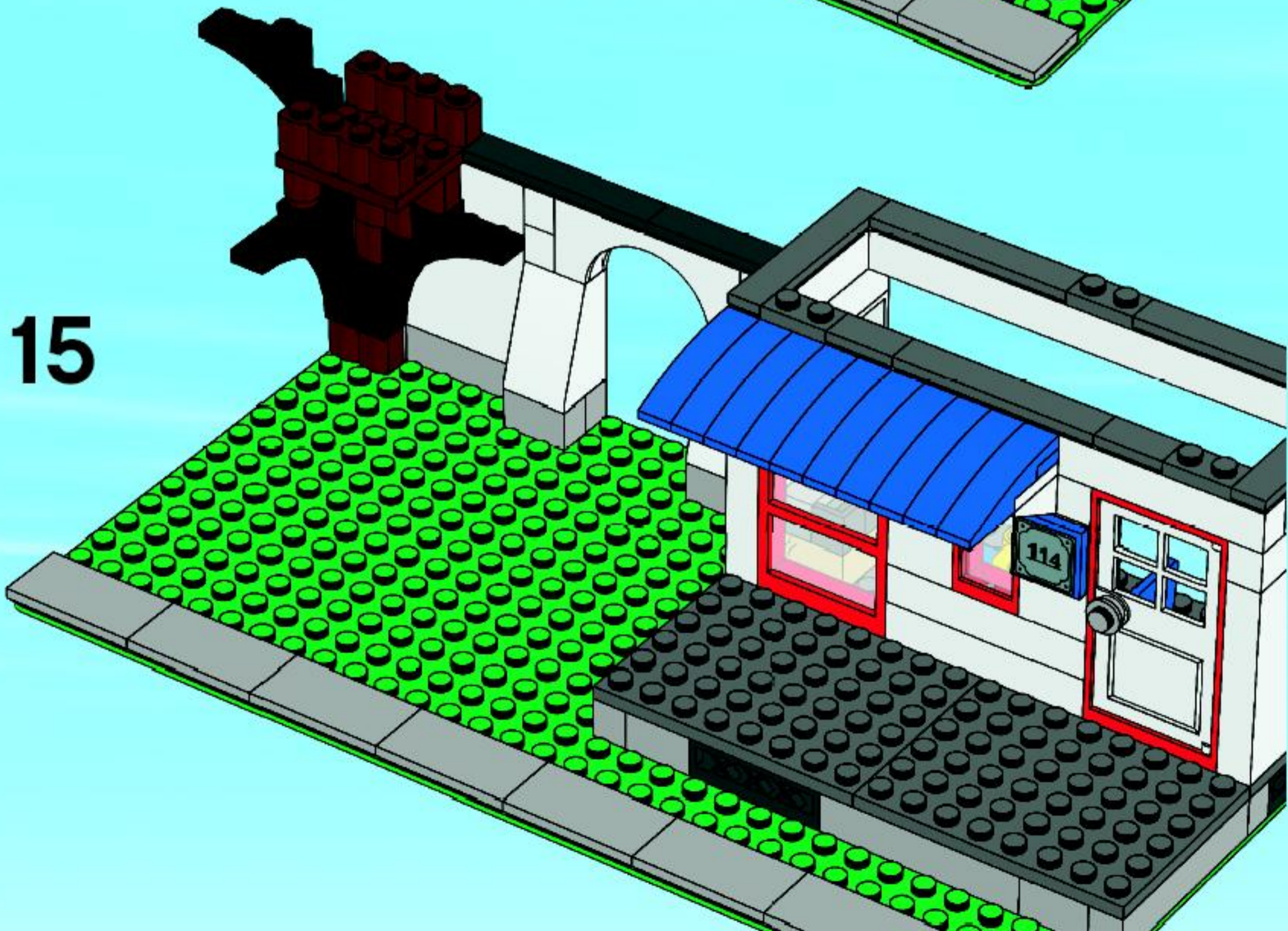

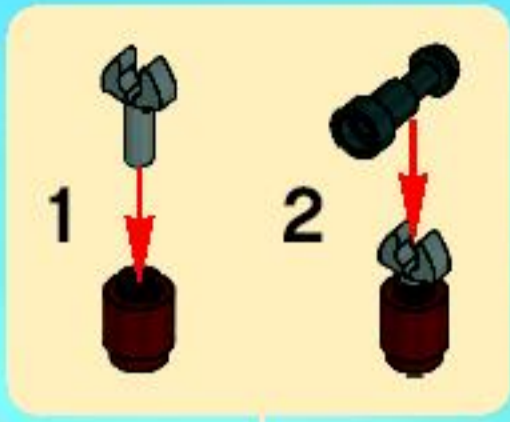

16

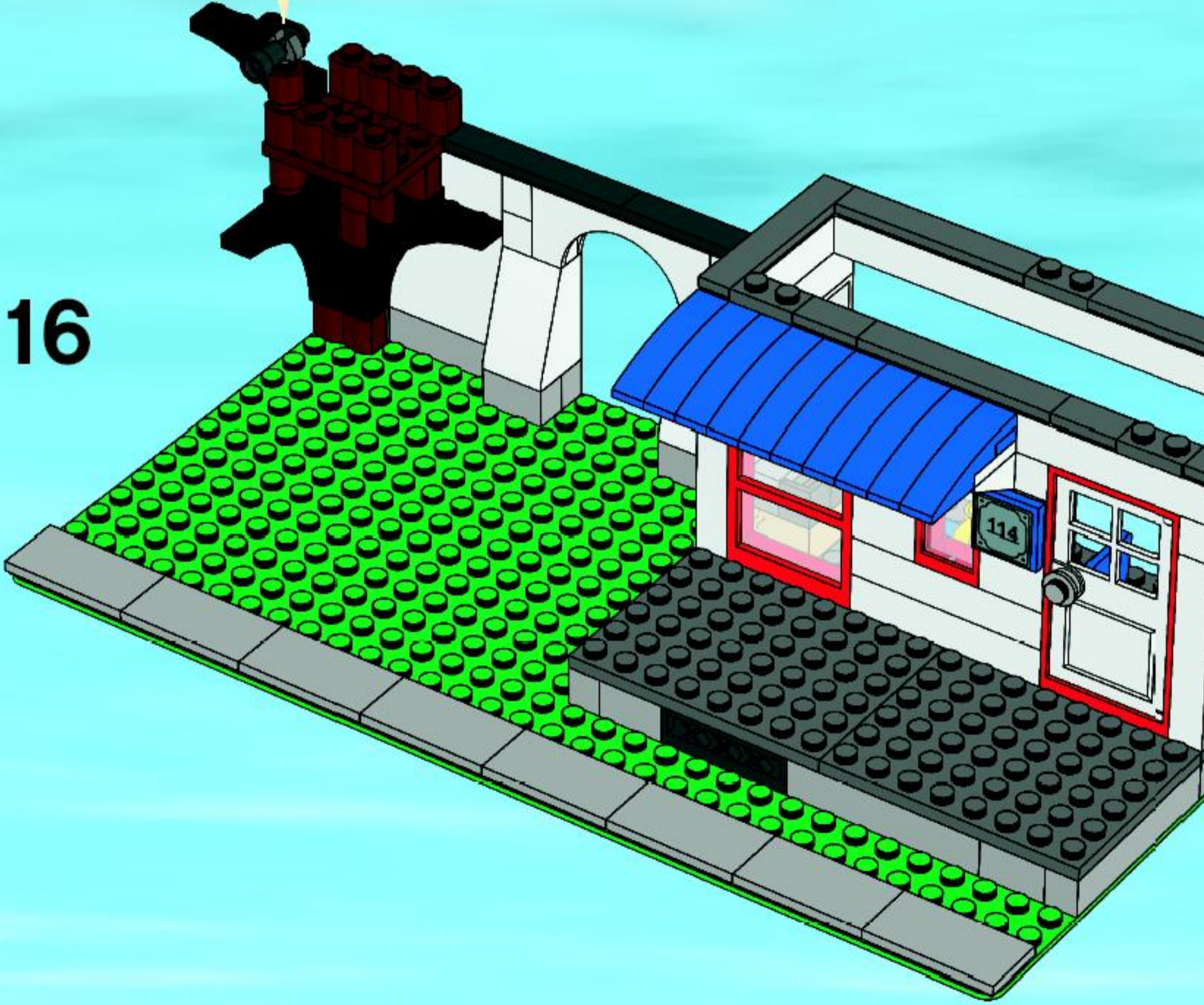

17



18



19

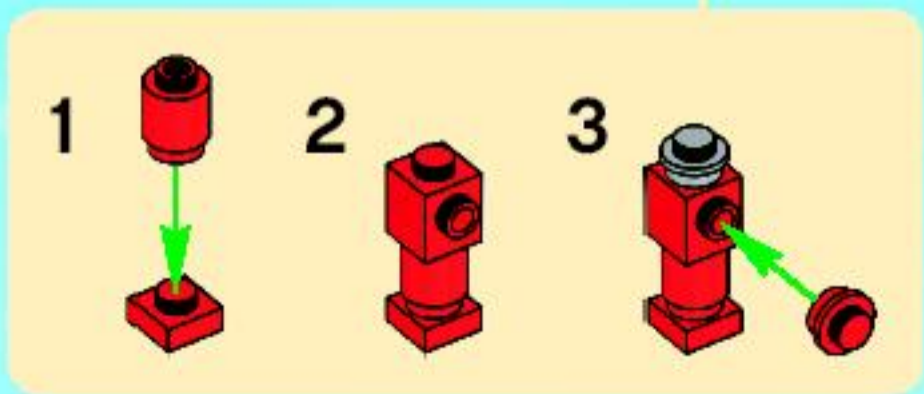
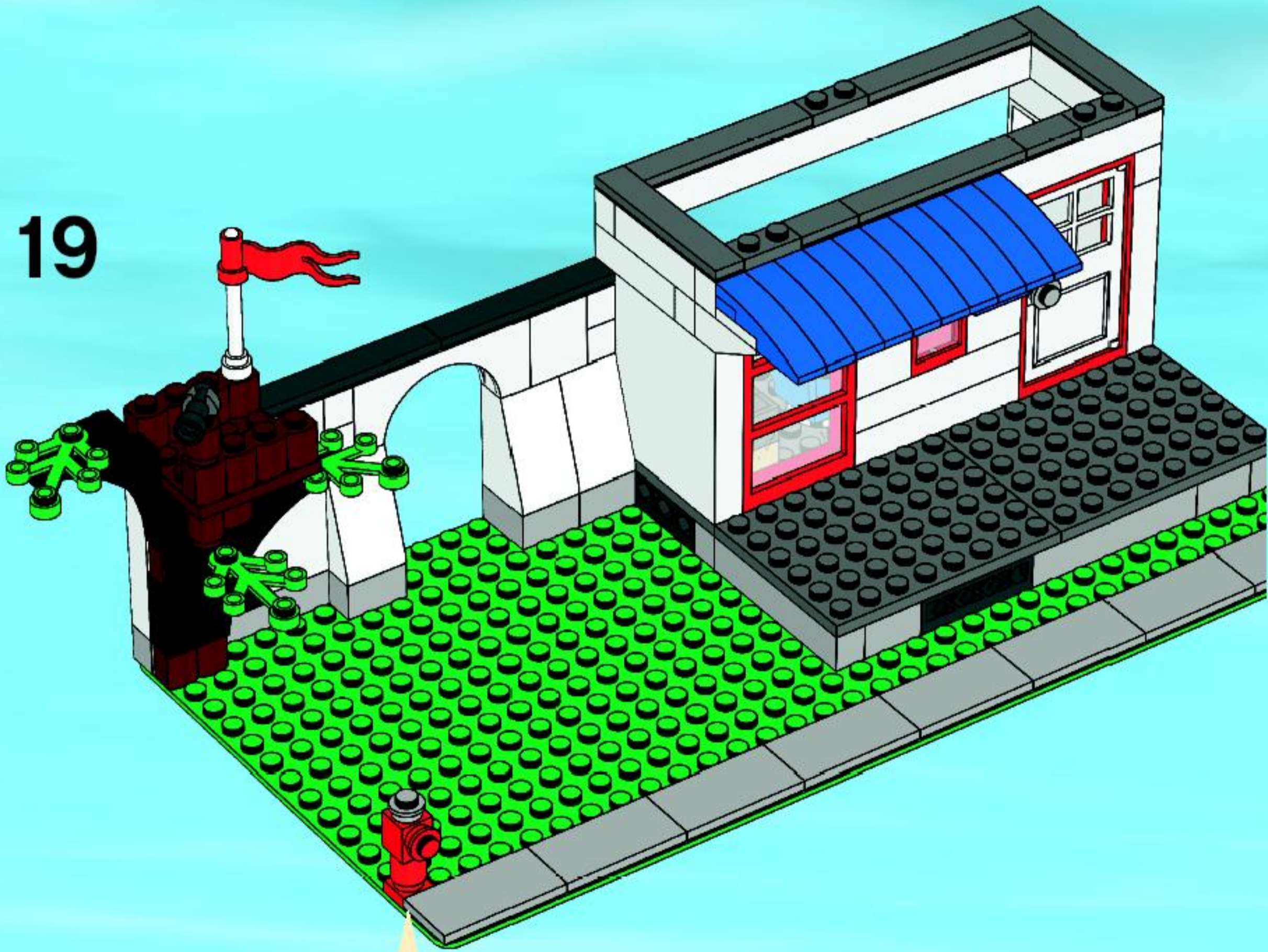

20

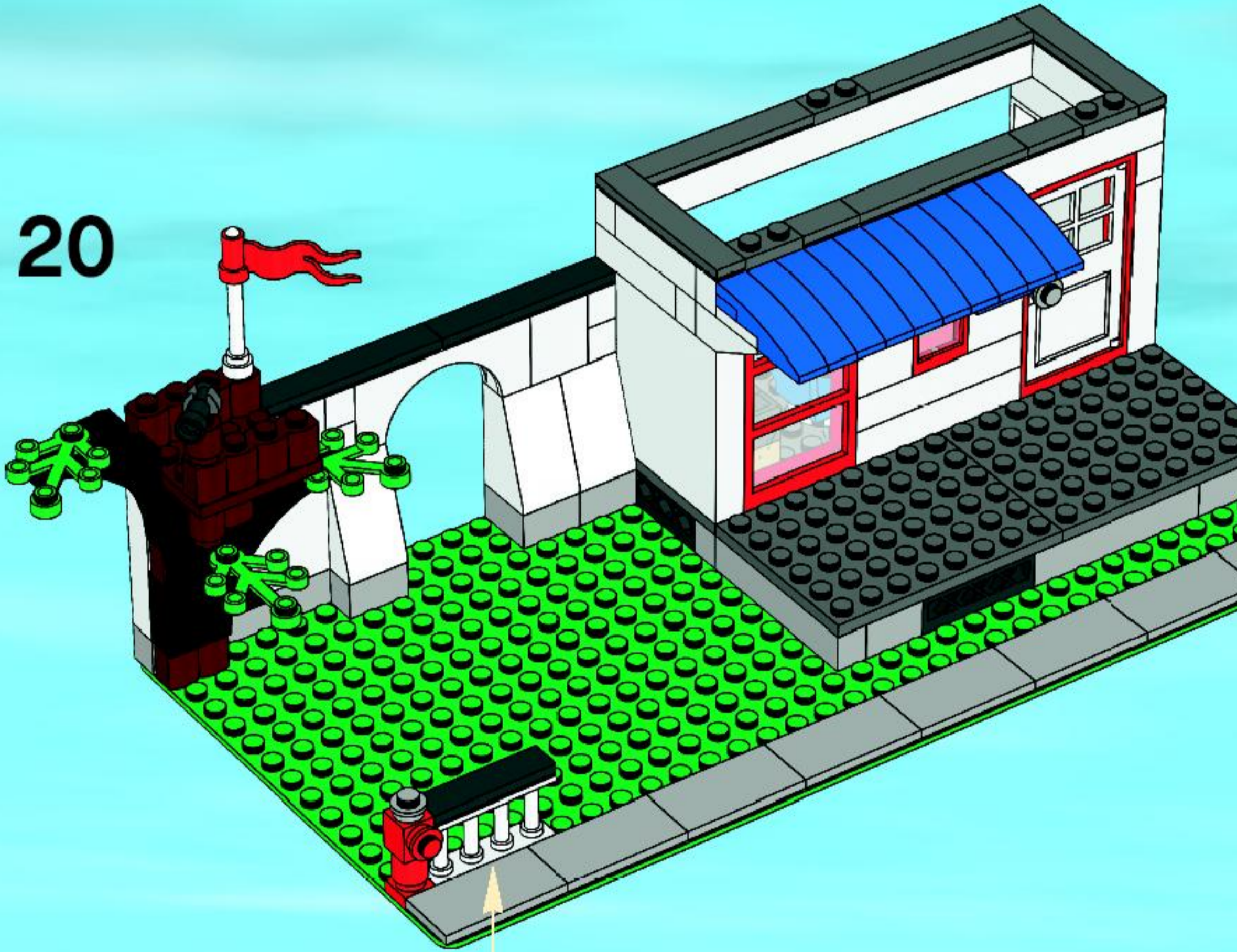

21

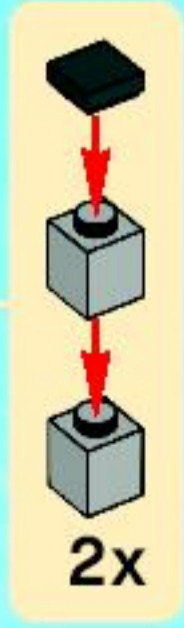
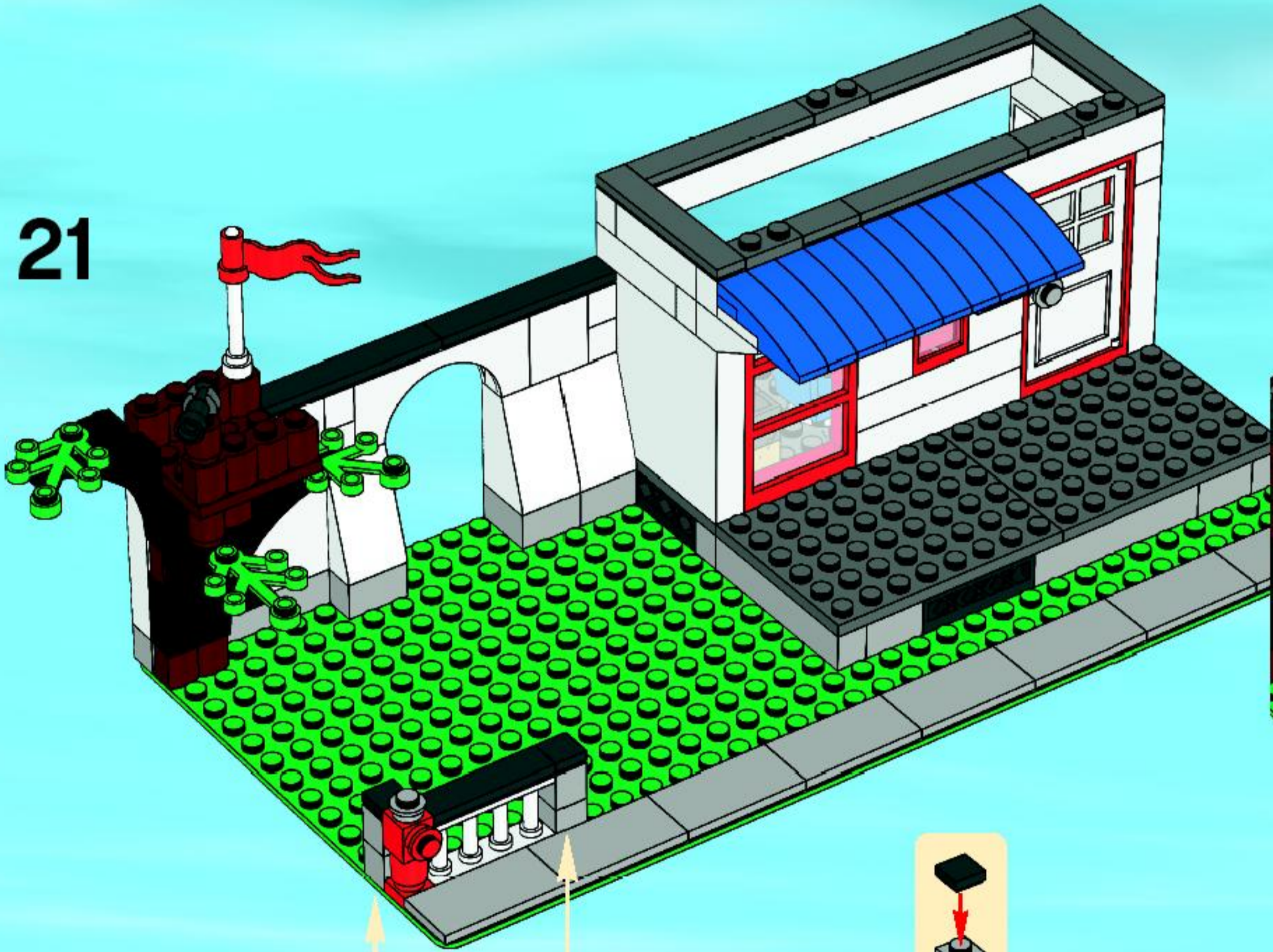

22

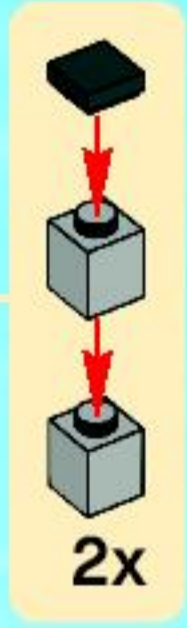
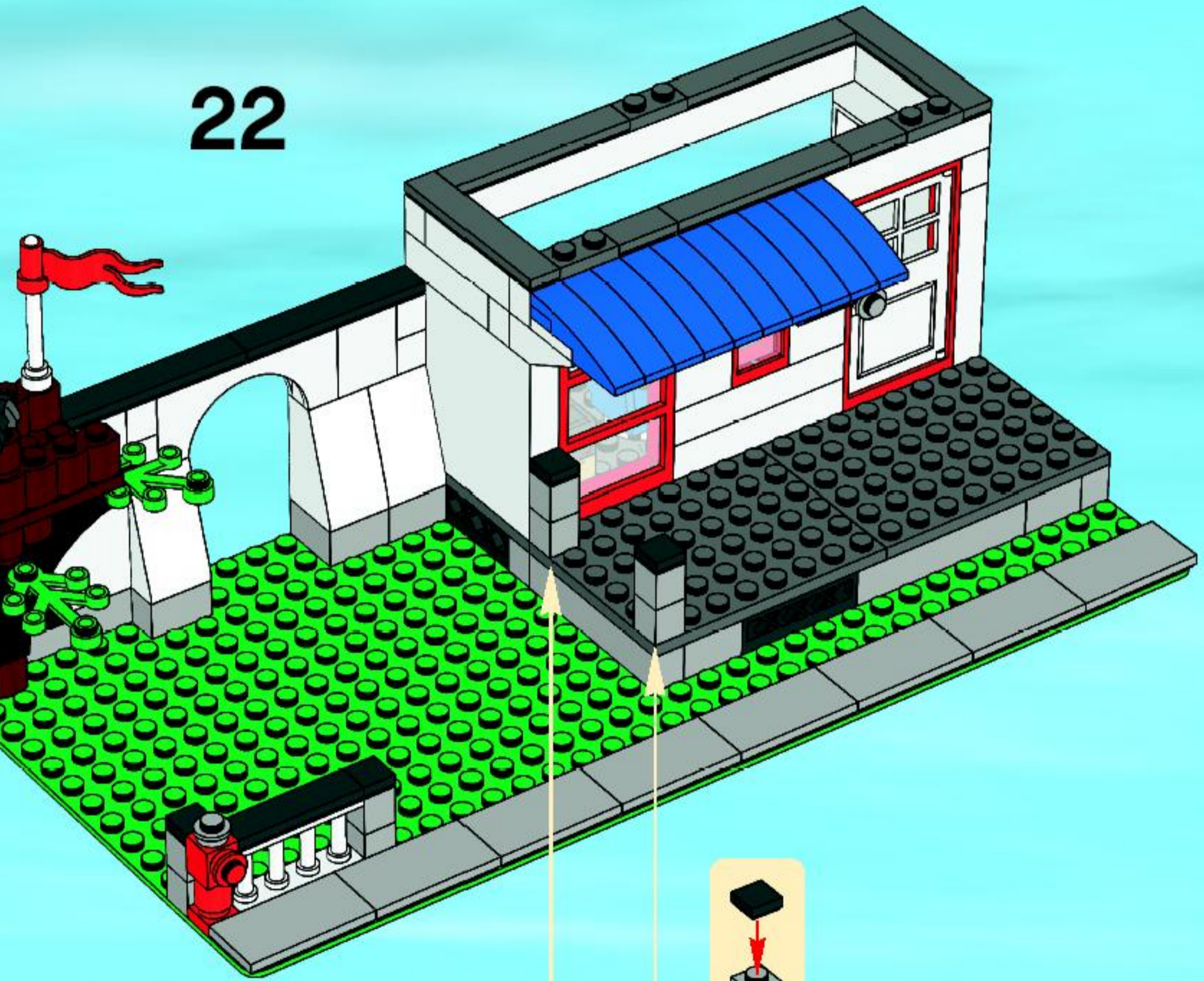

23

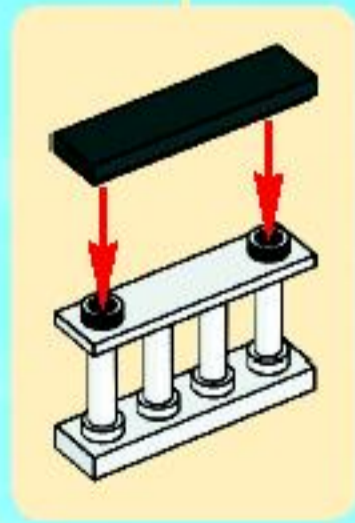
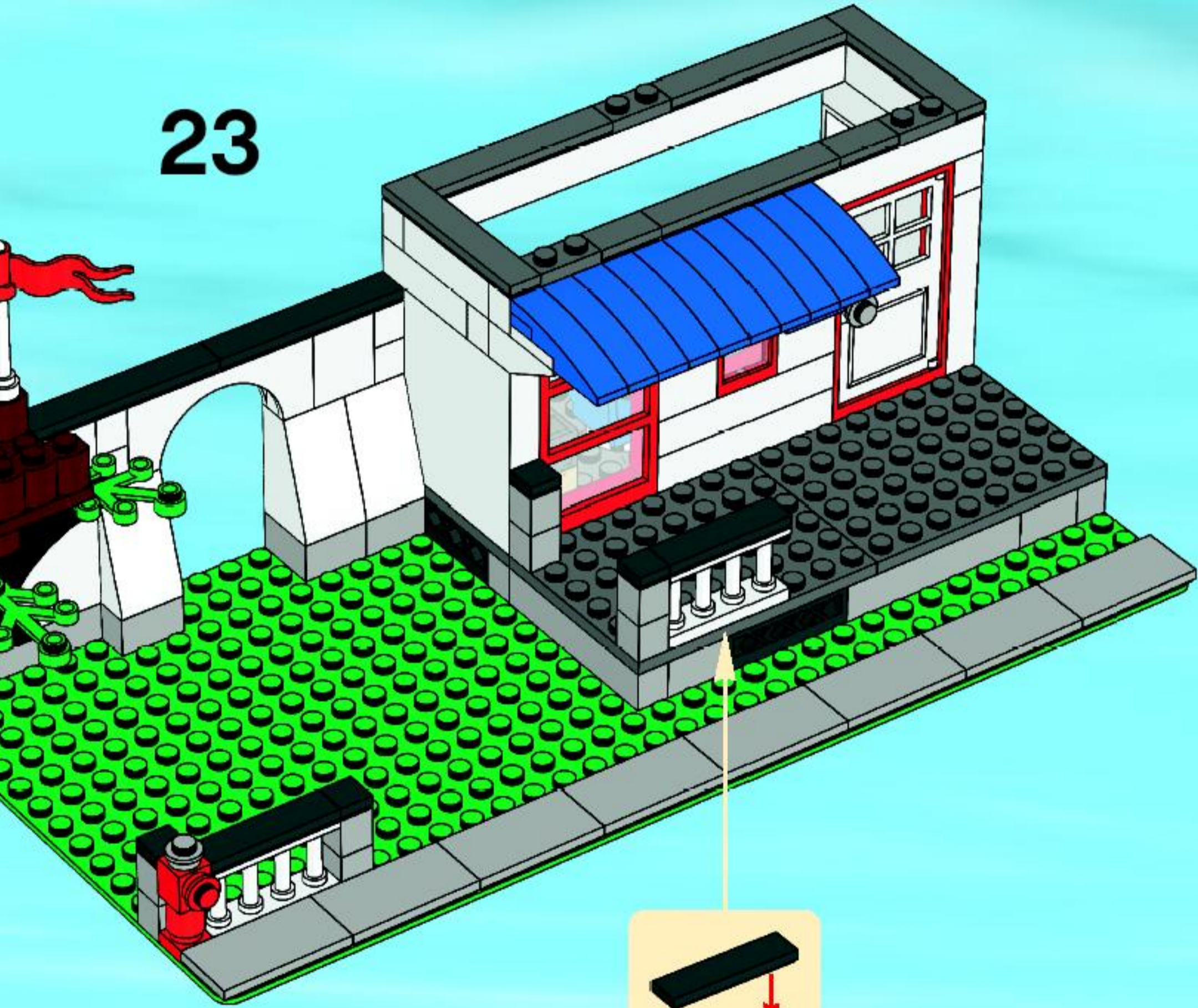

24

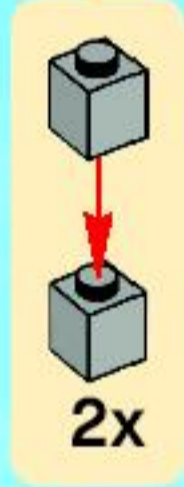
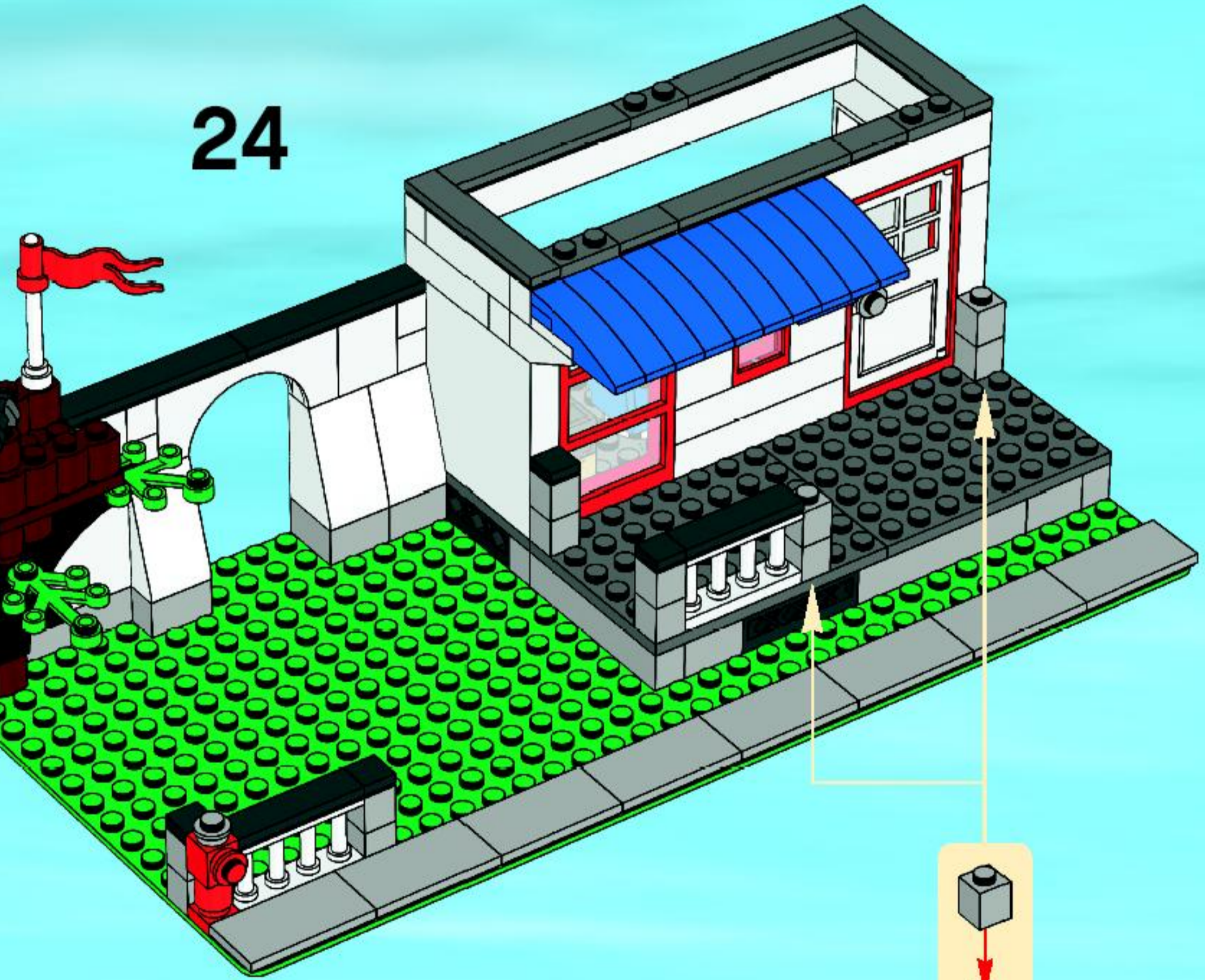

25

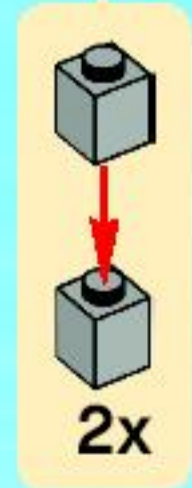
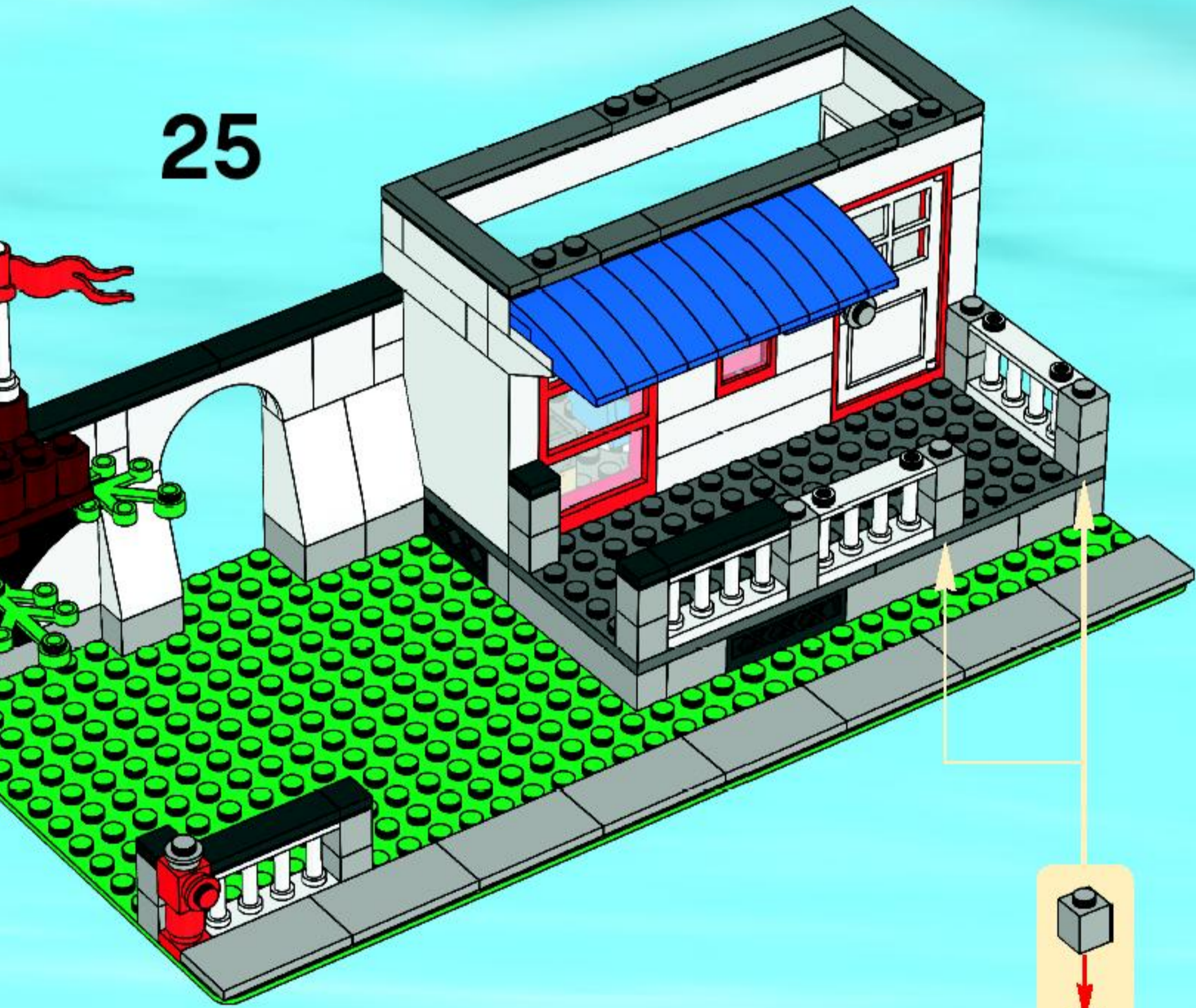

26

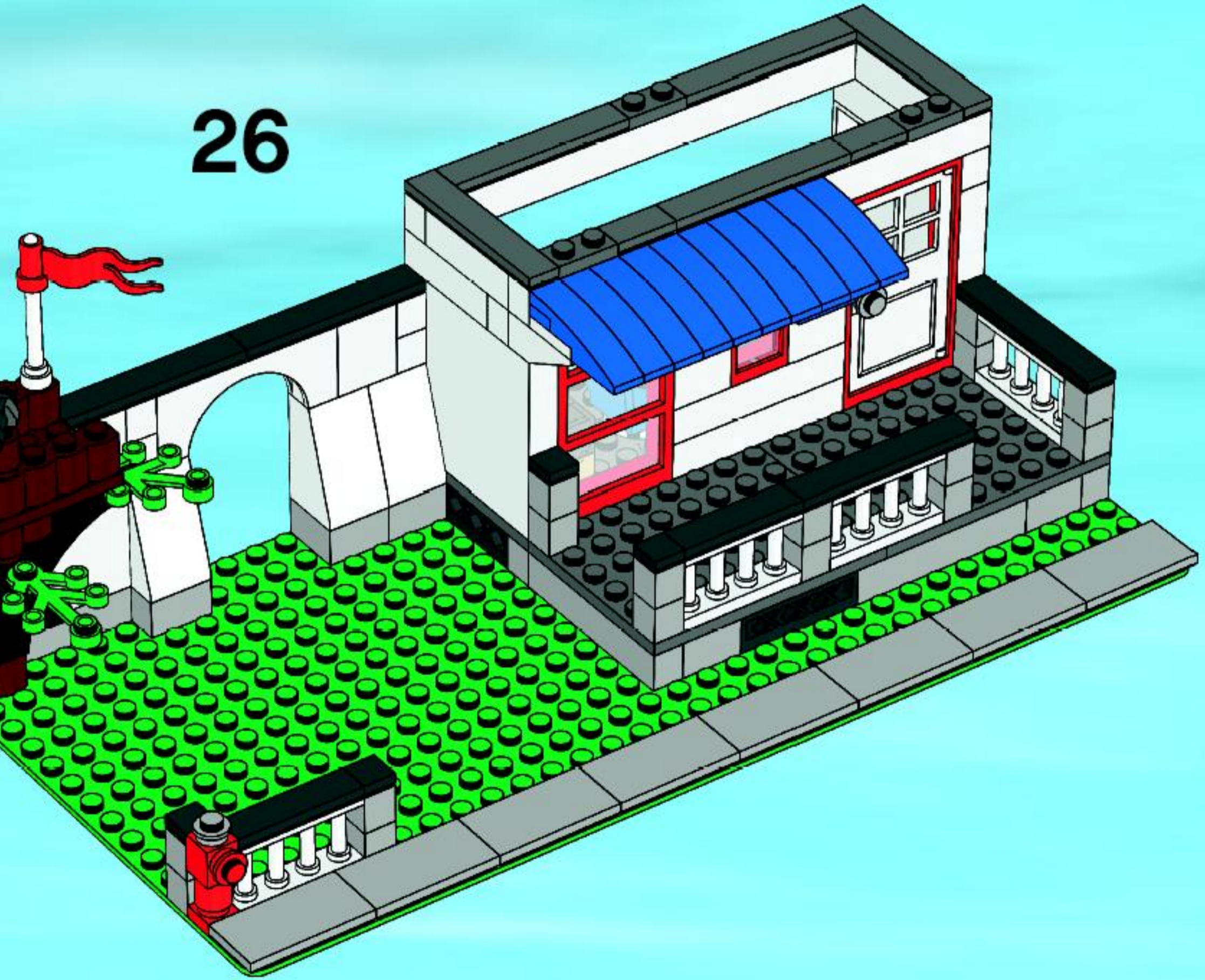

27

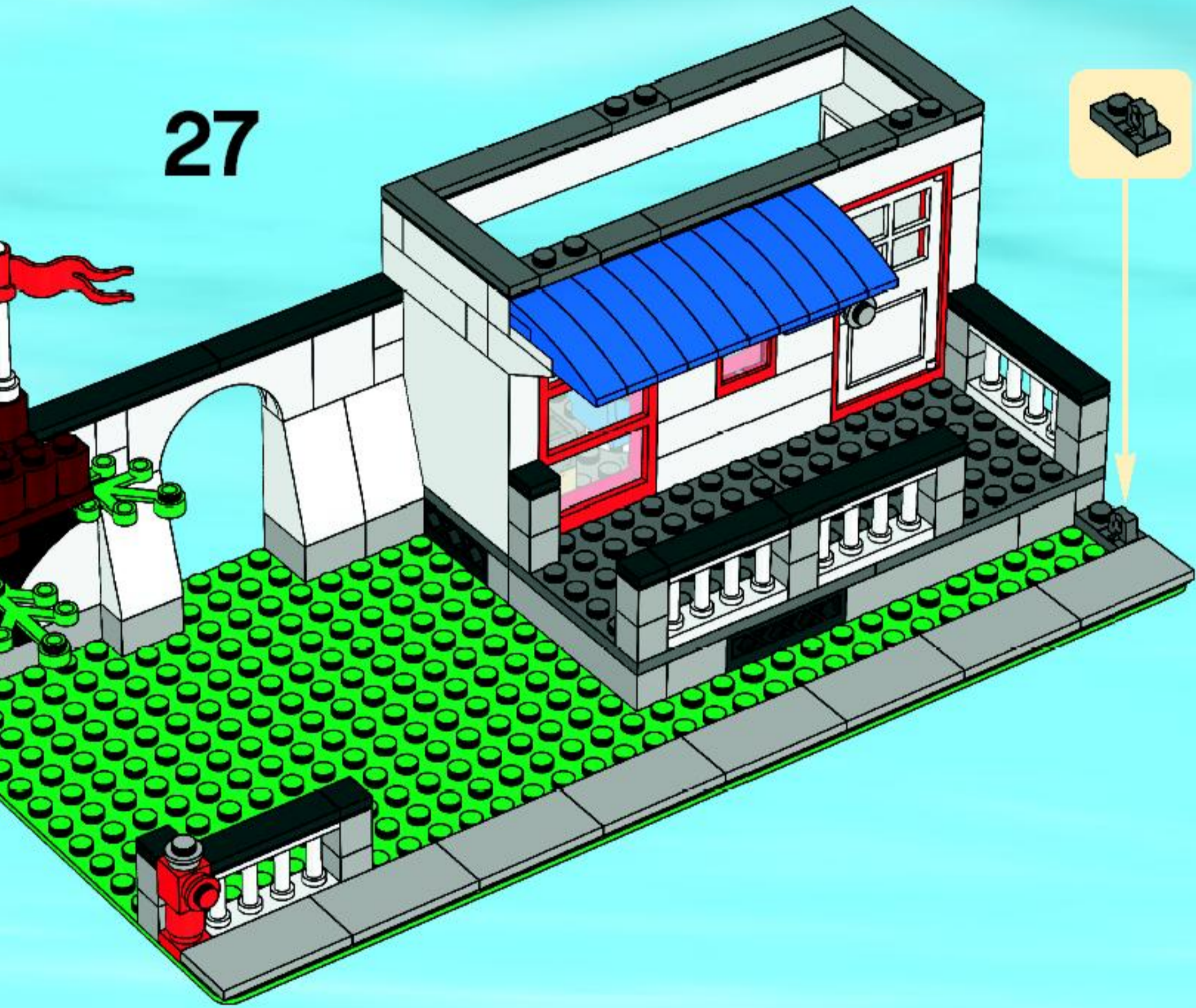

28

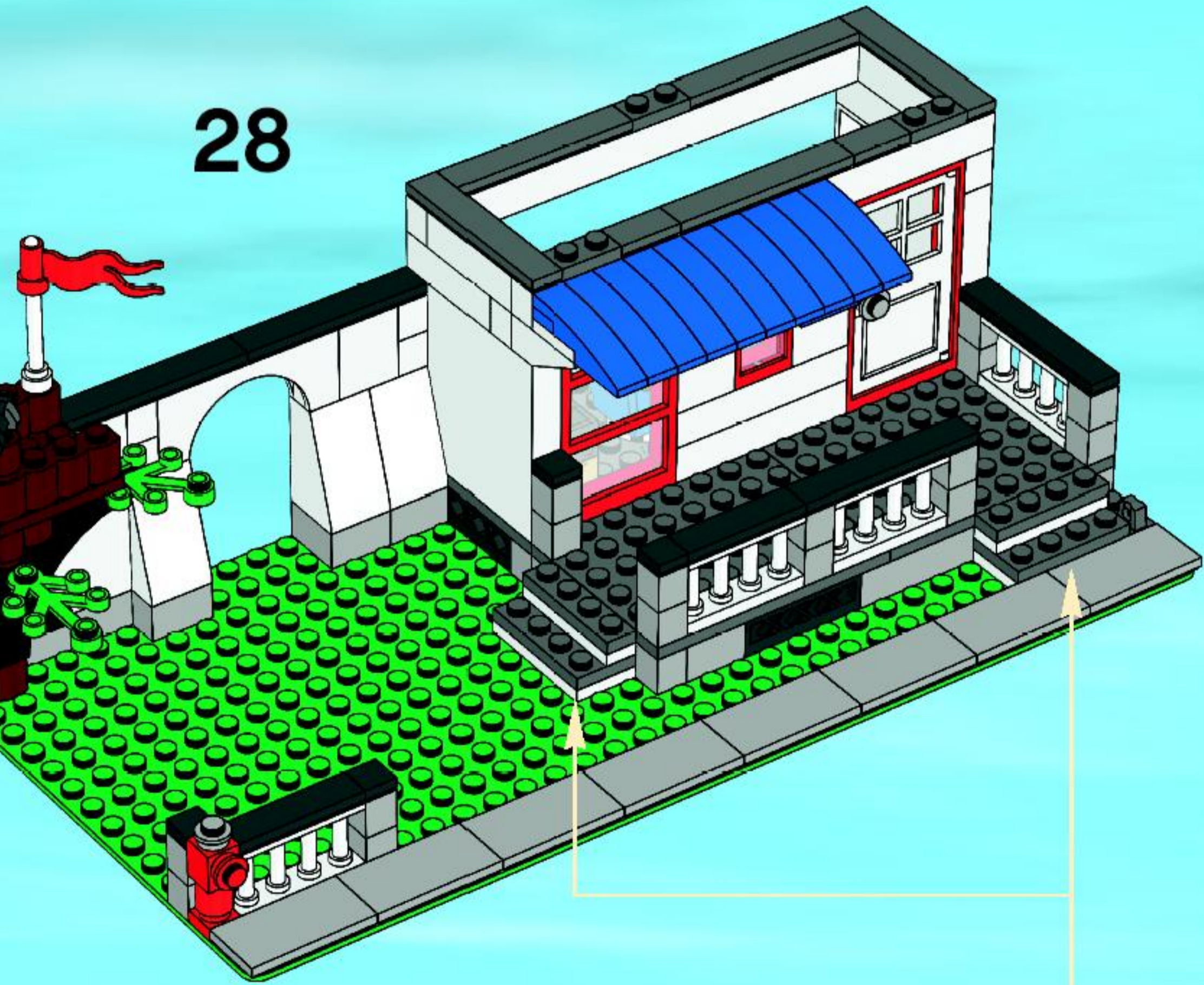

1

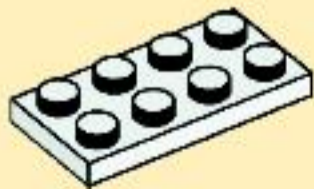

2



3

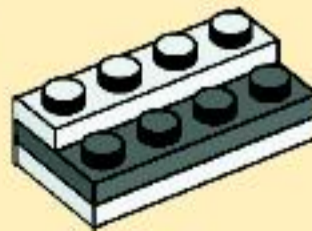

4

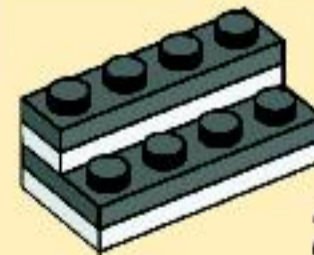

2x

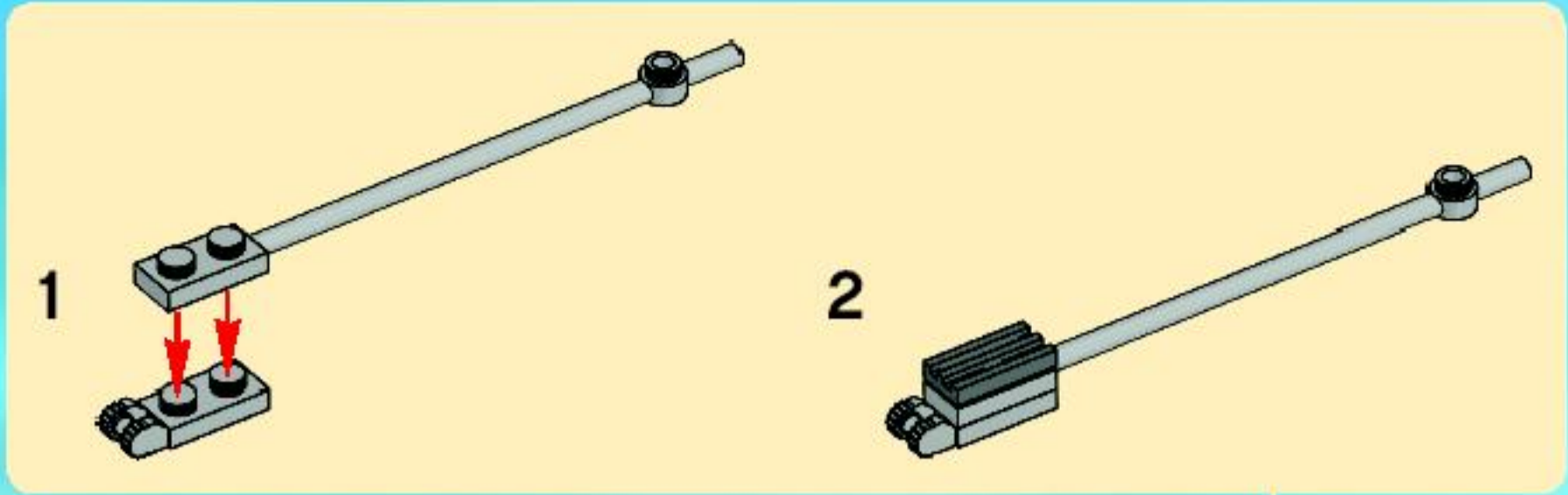

29

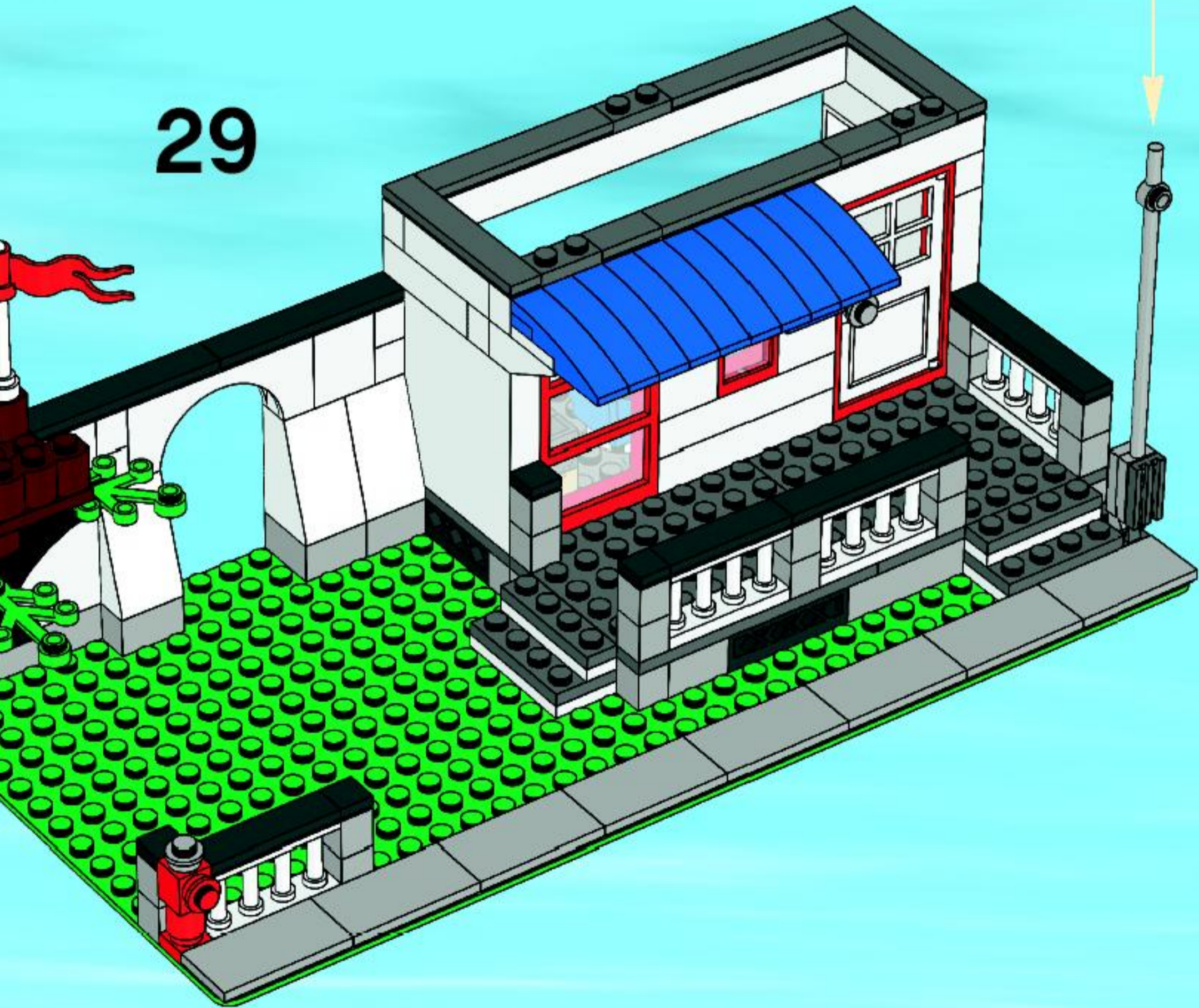

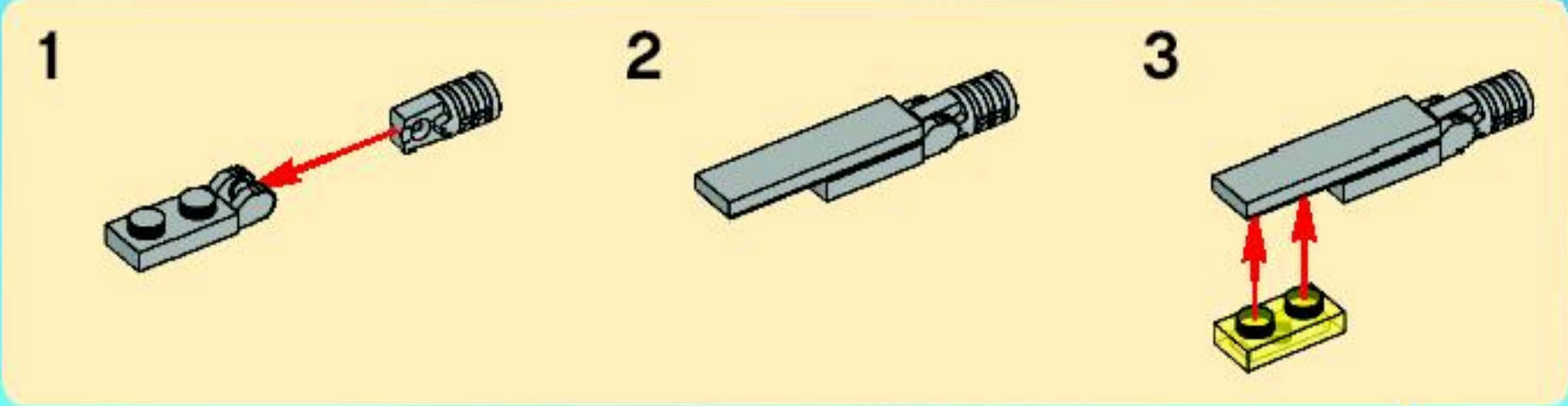

30

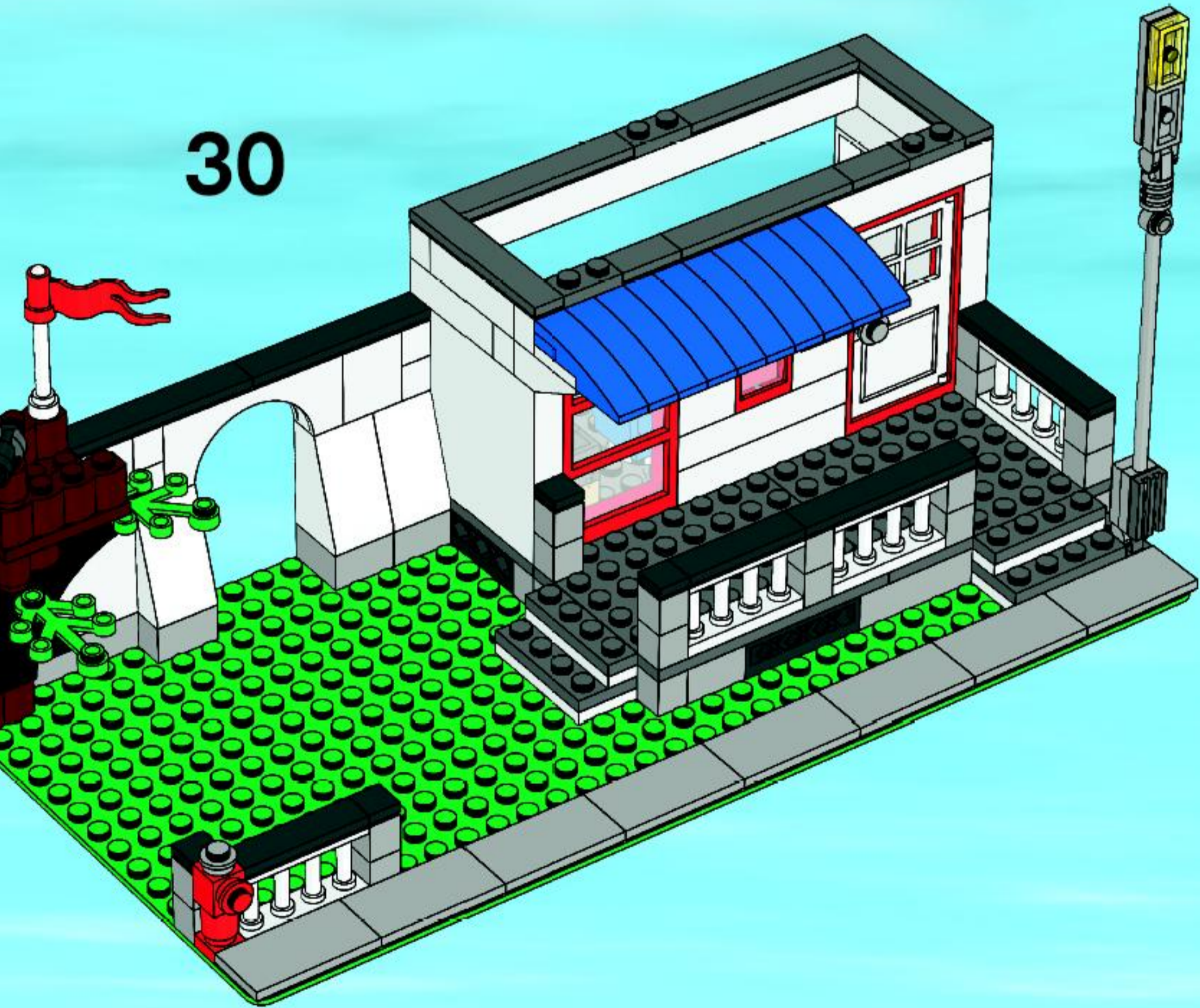

31

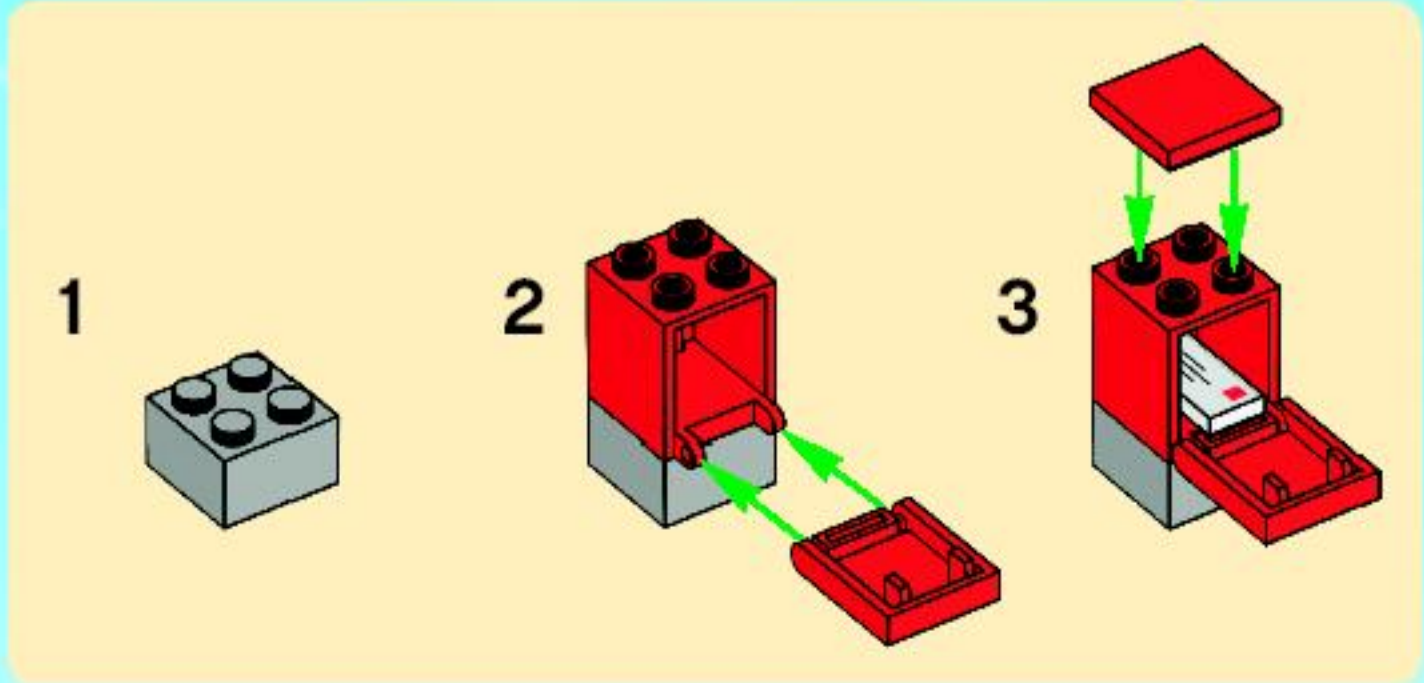
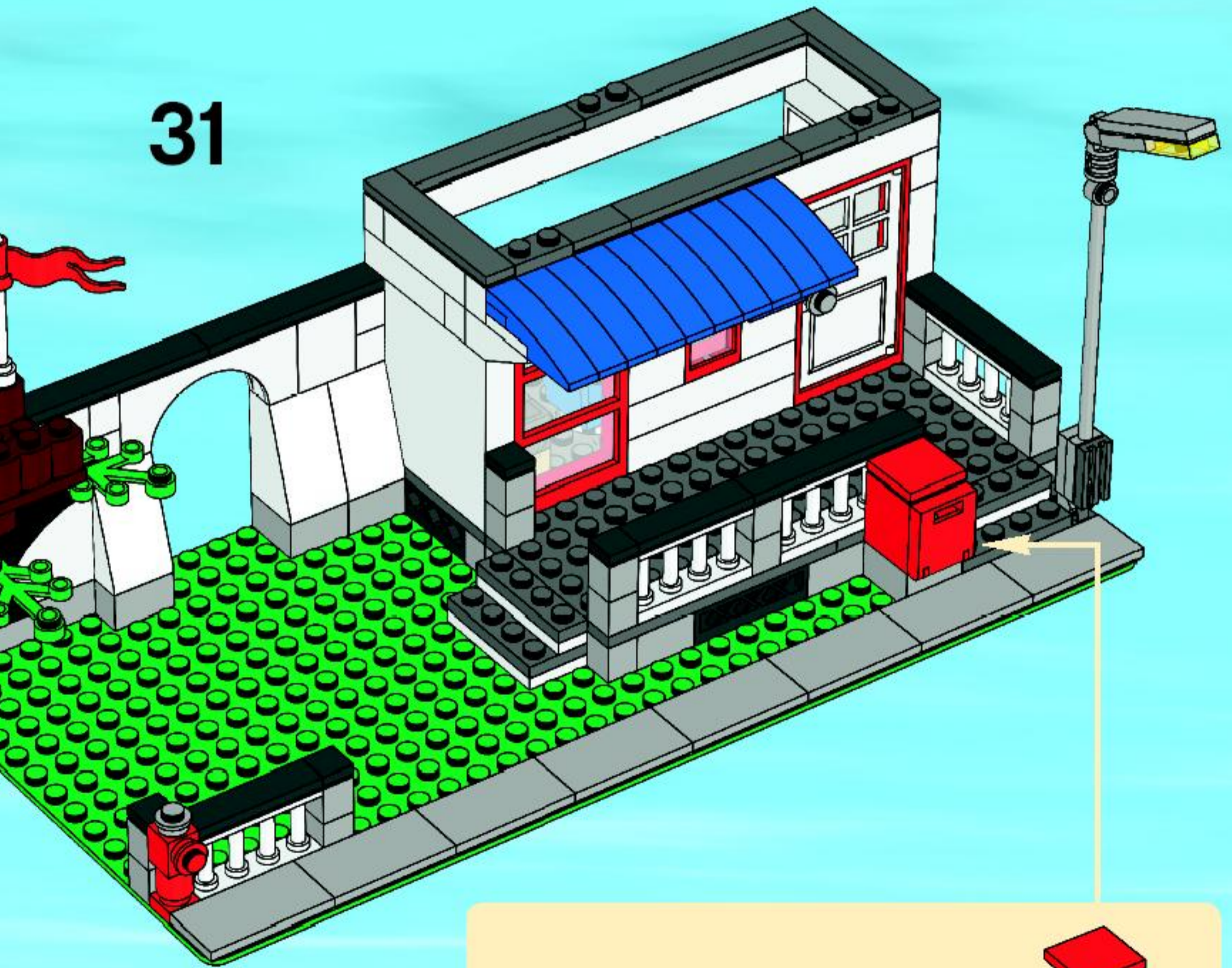

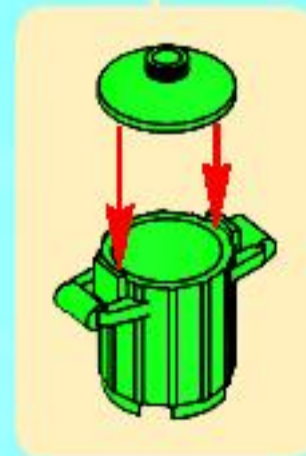
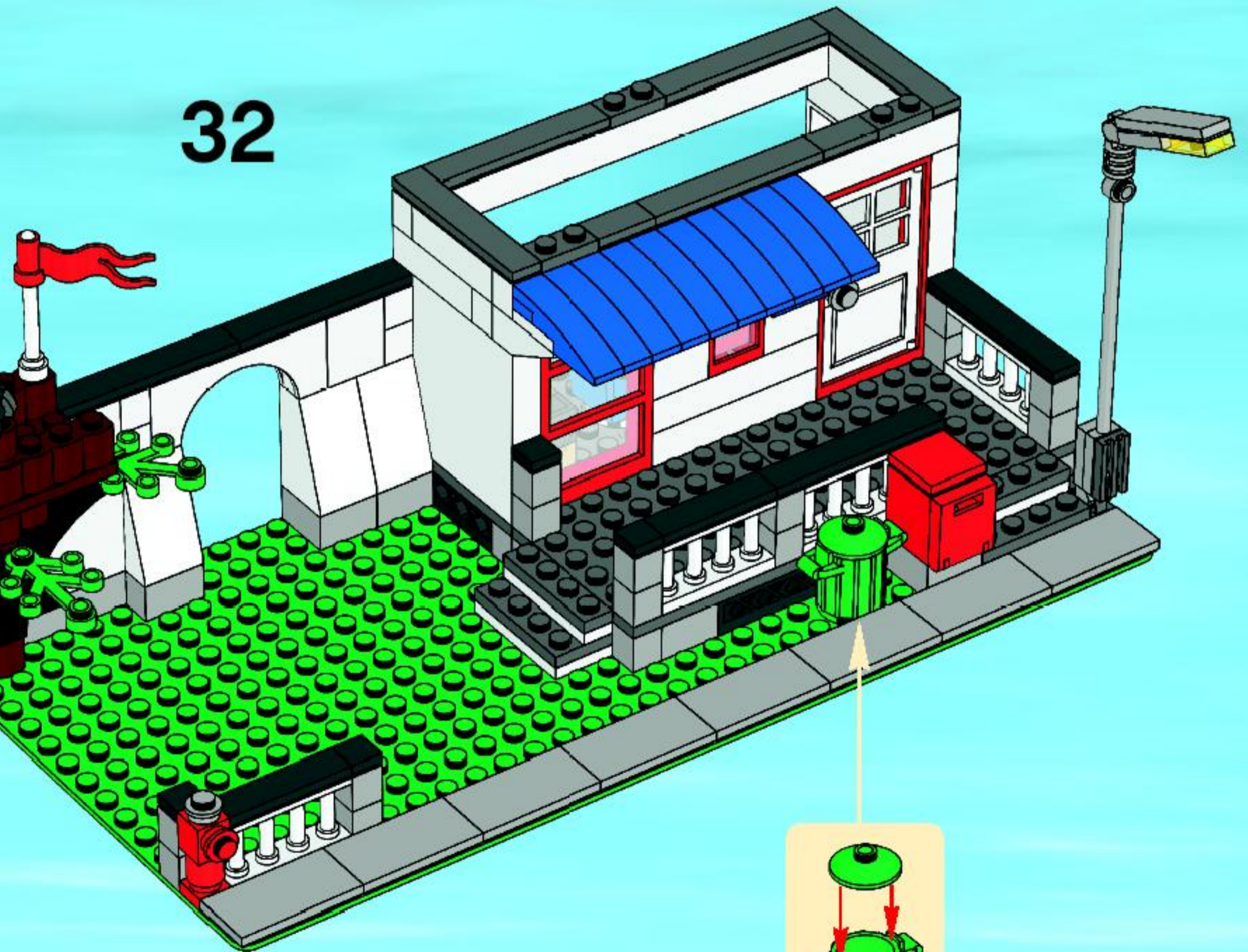

32

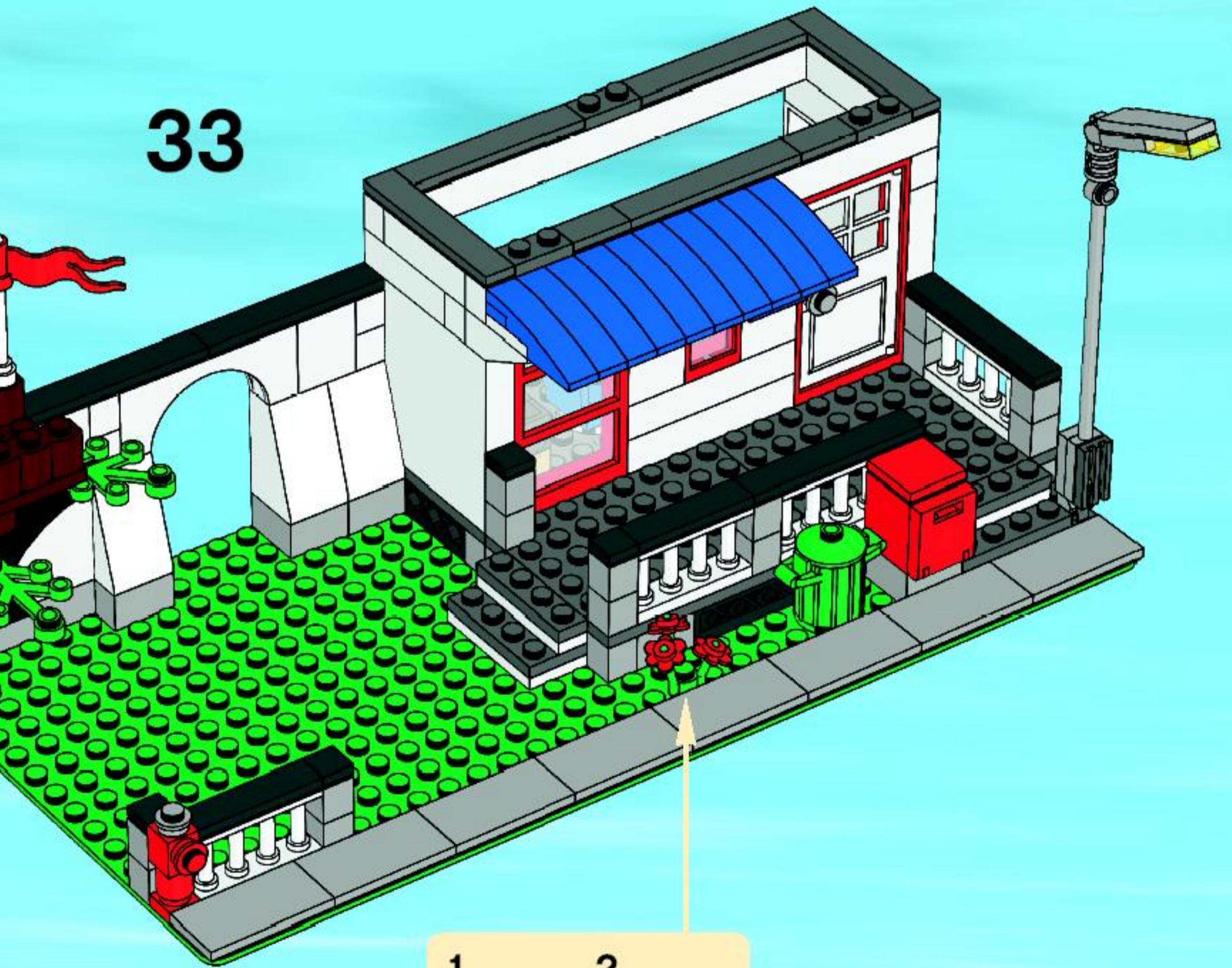

33



- 1 
- 2 

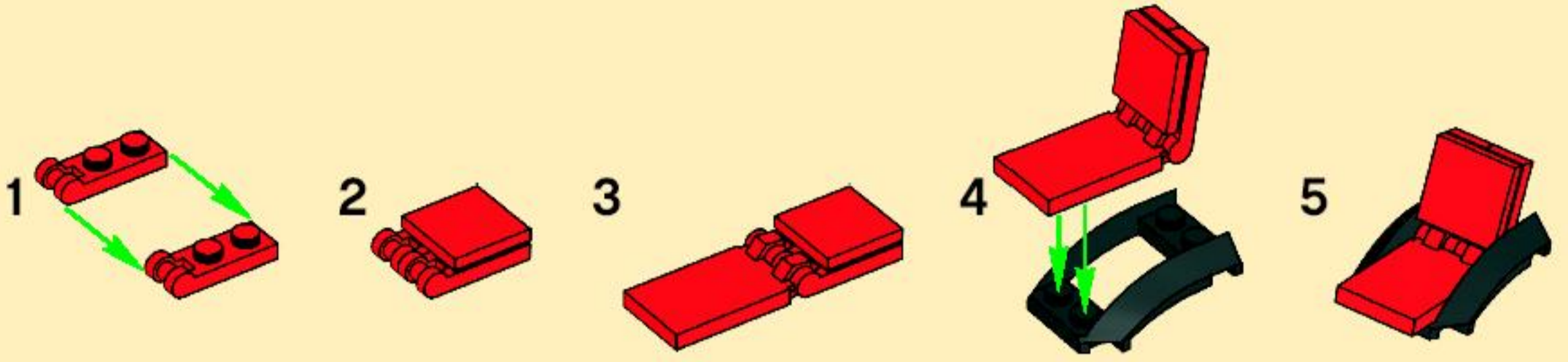

34

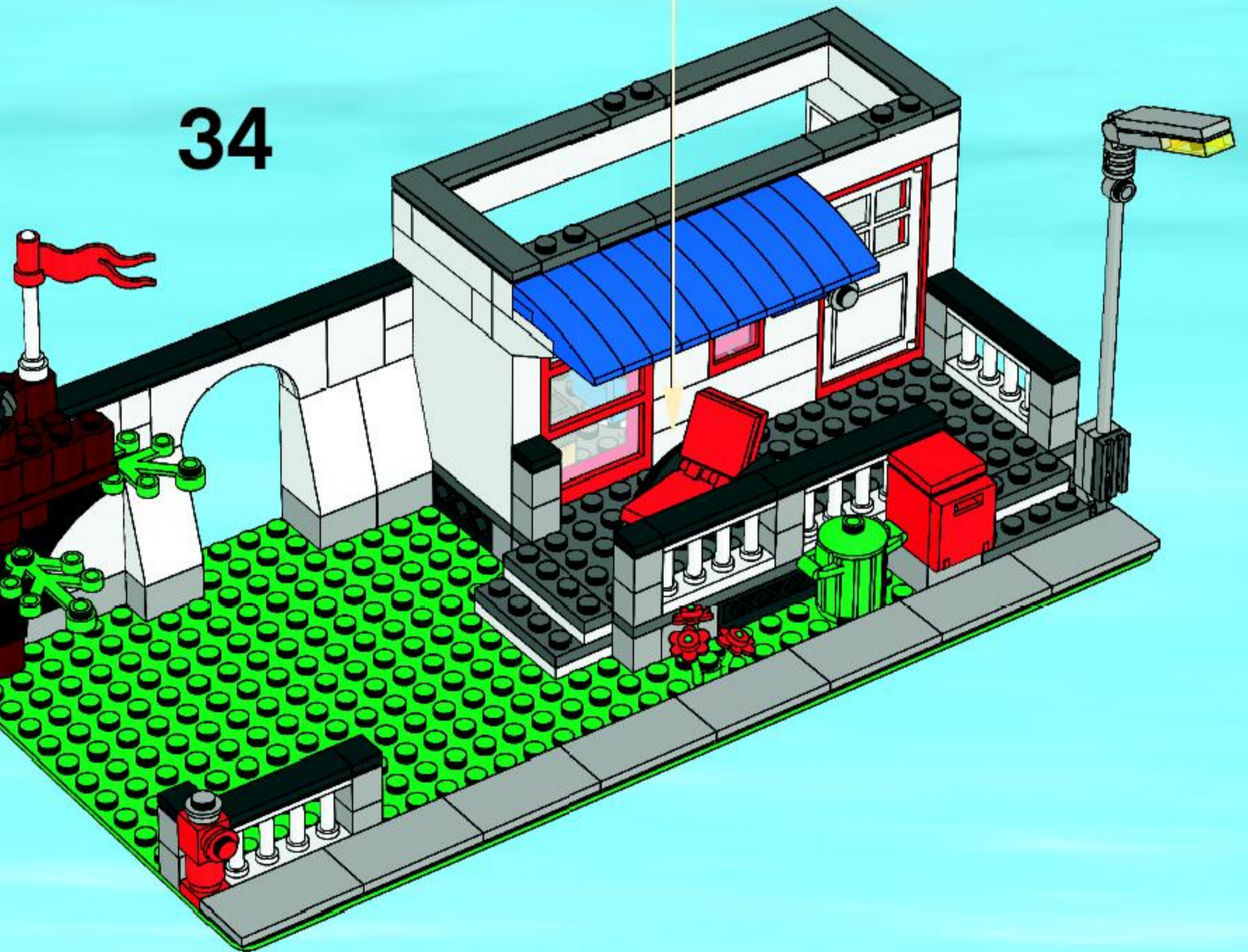

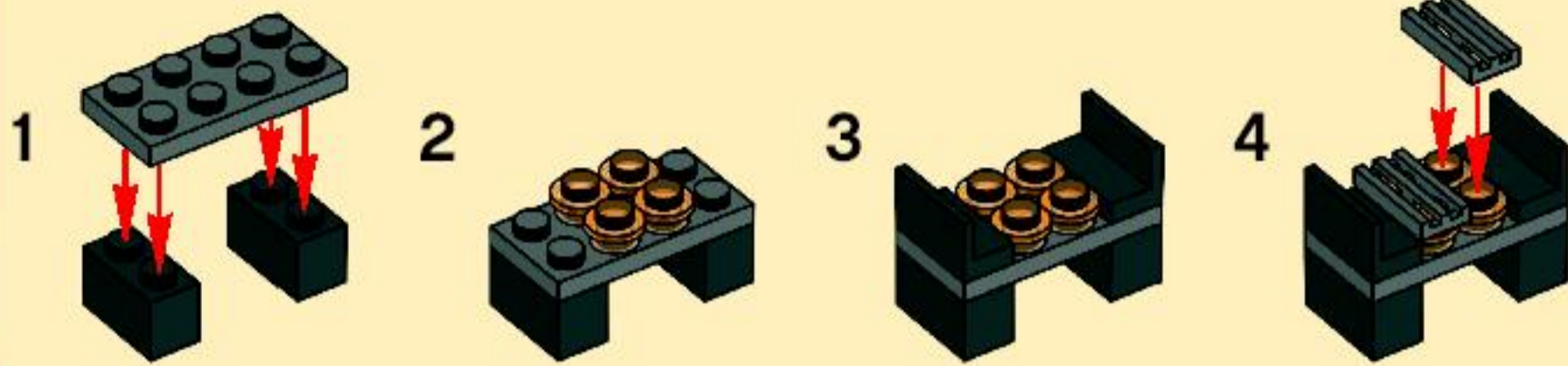

35

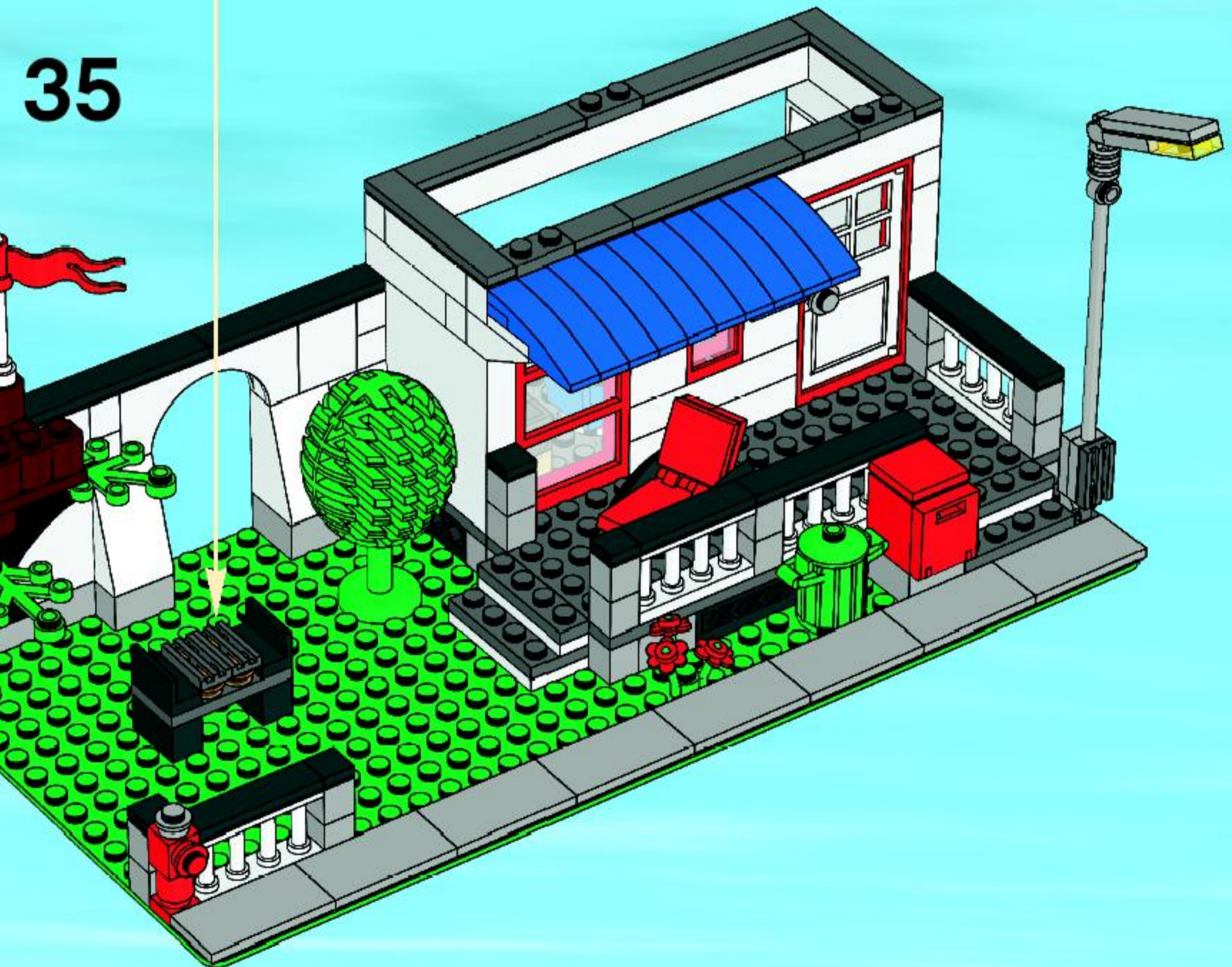



+

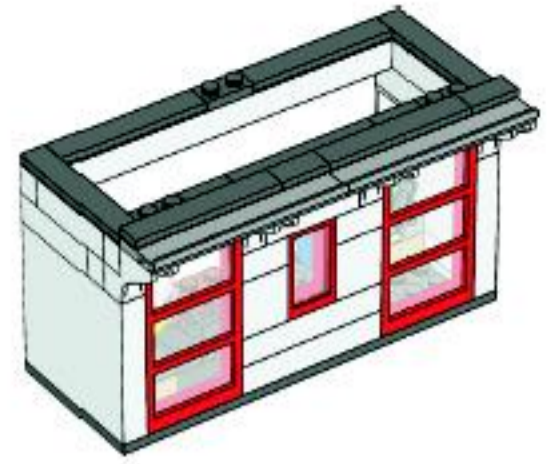

1

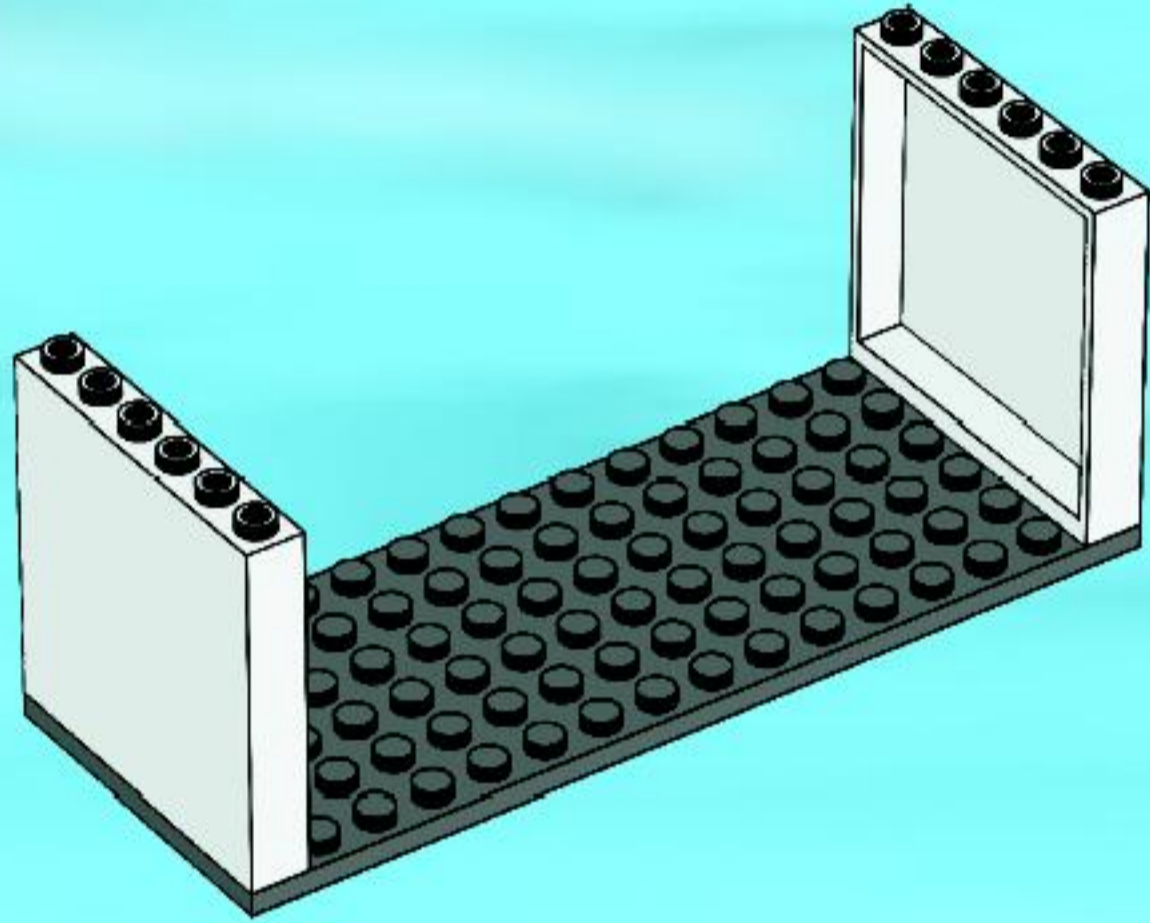

2

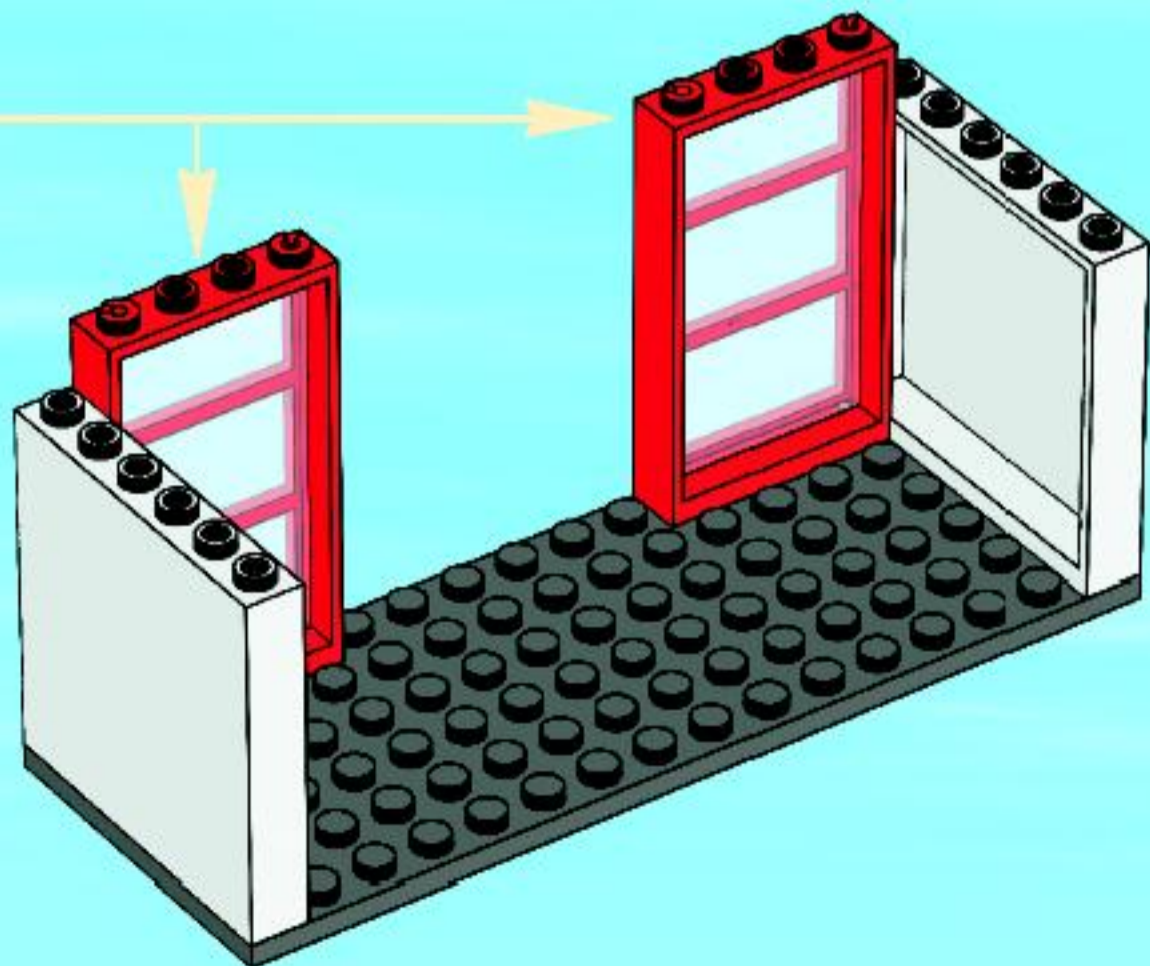
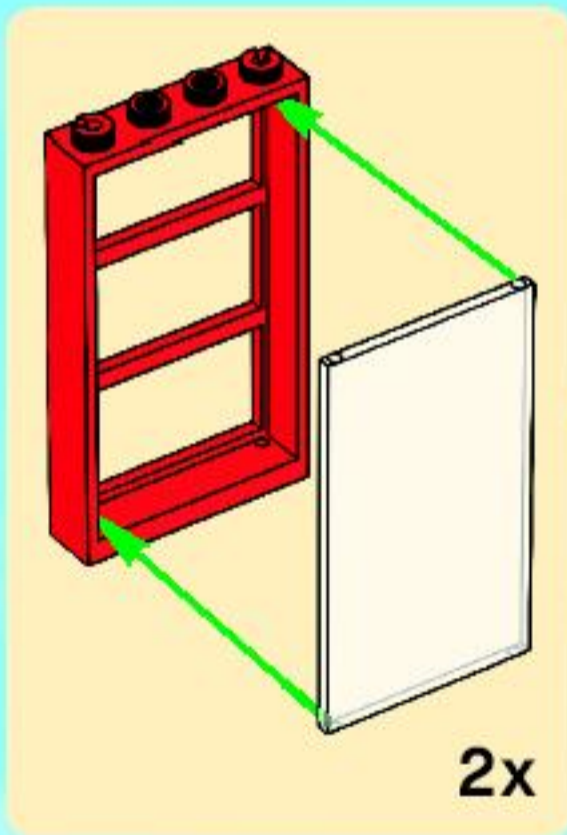

3

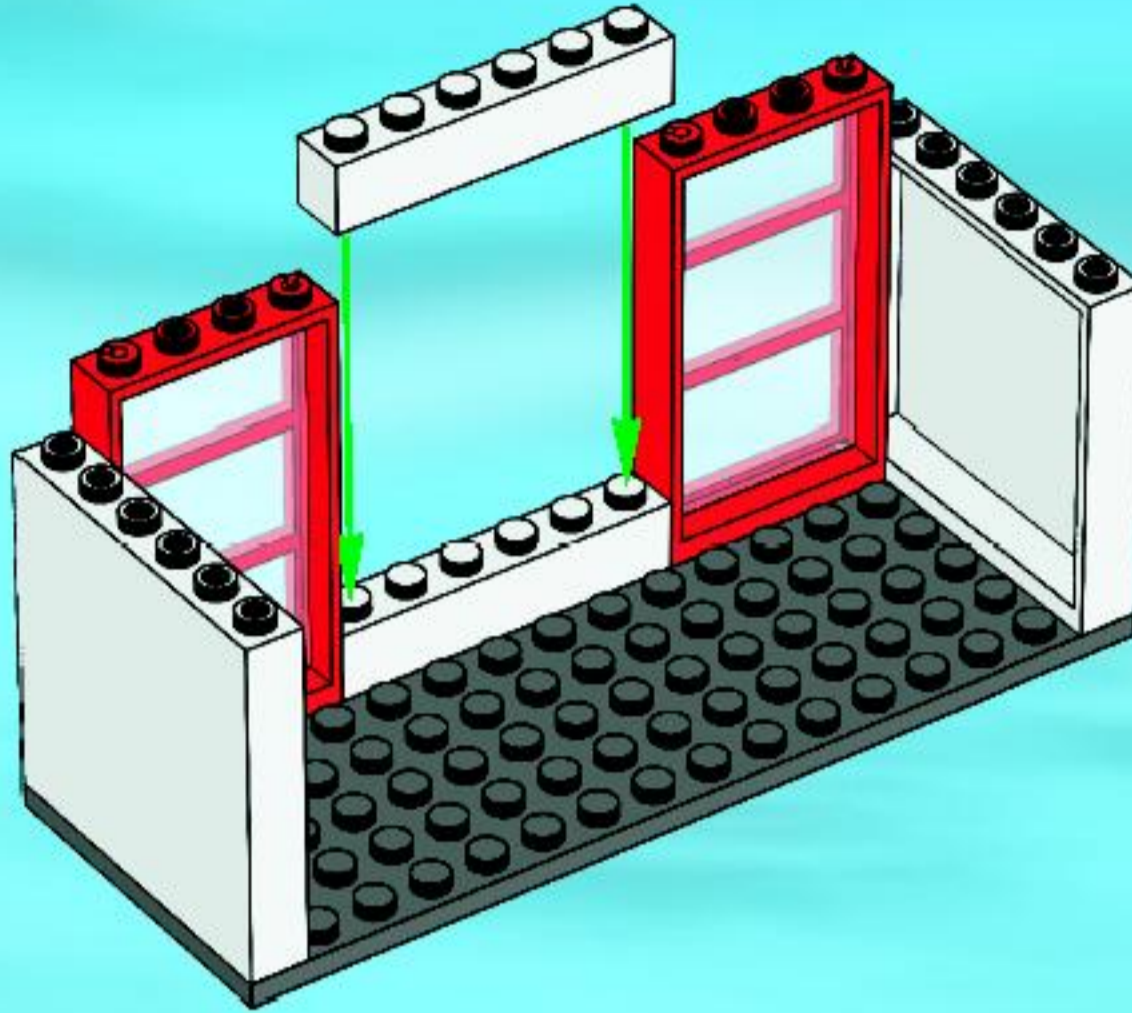

4

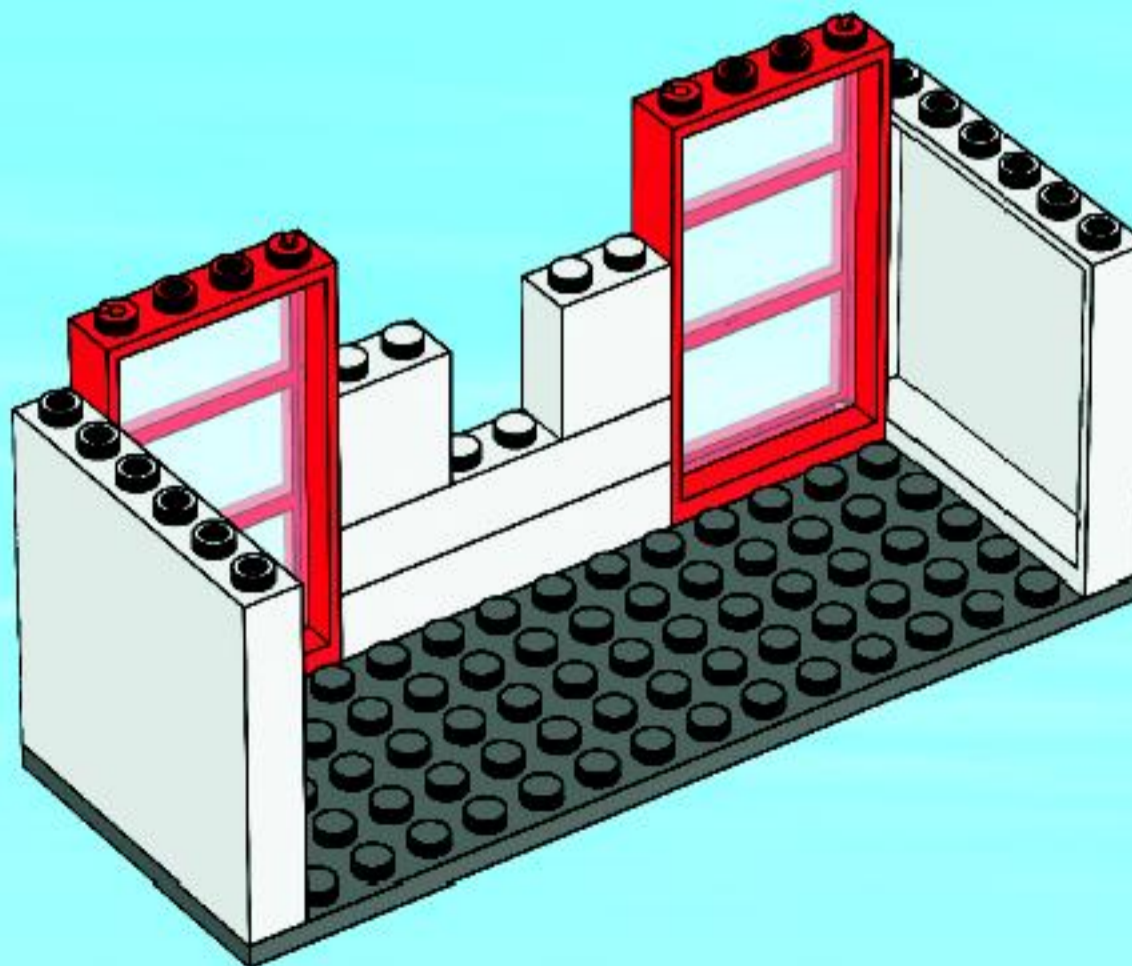

5

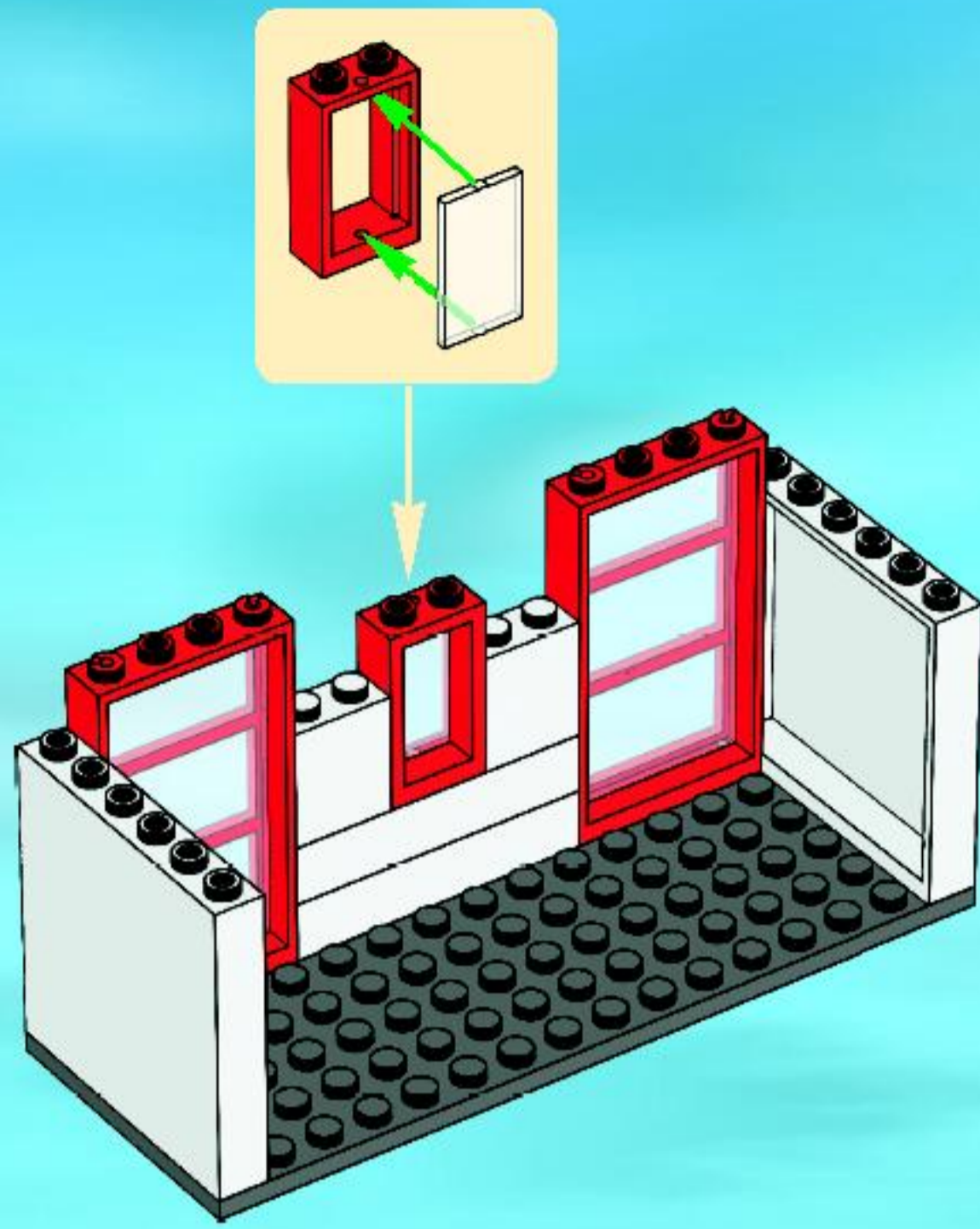

6

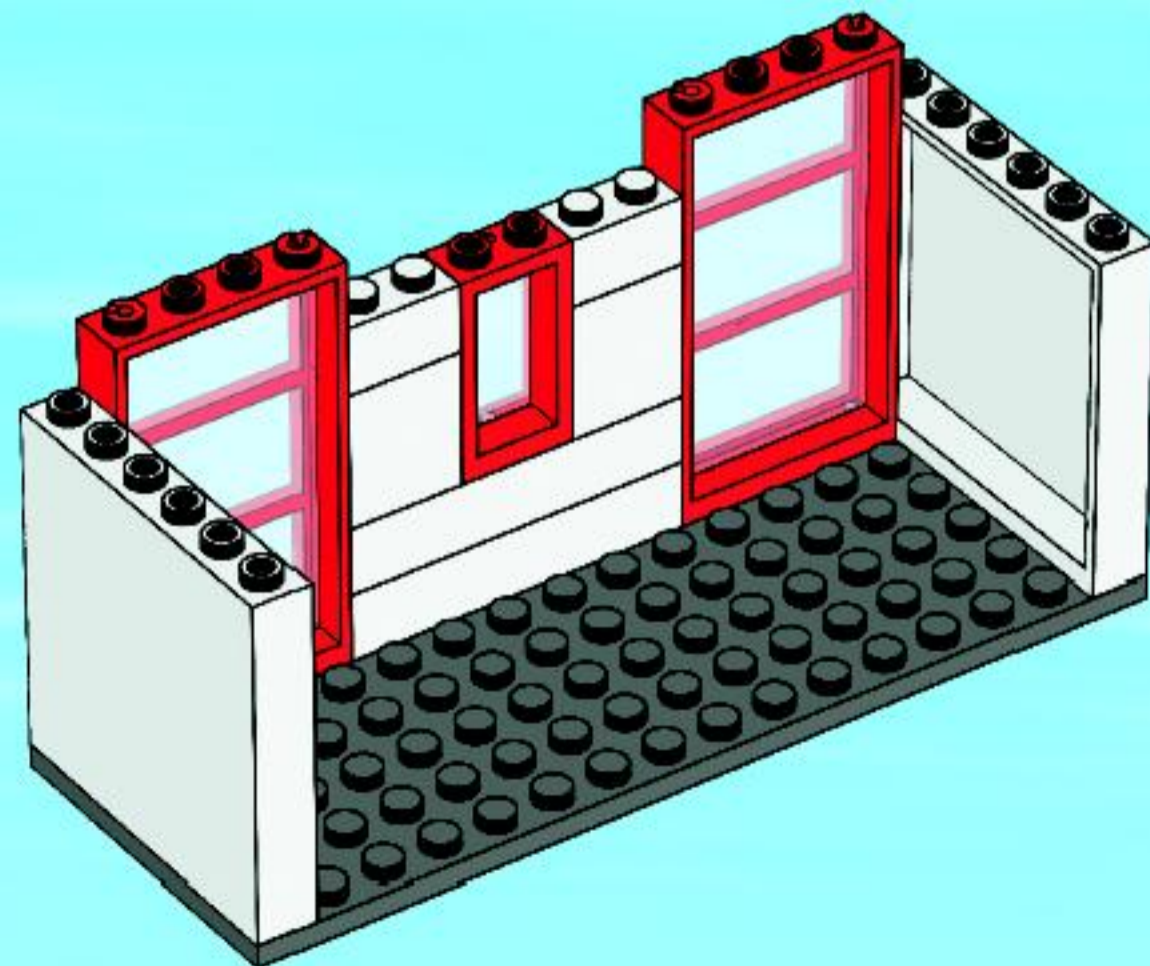

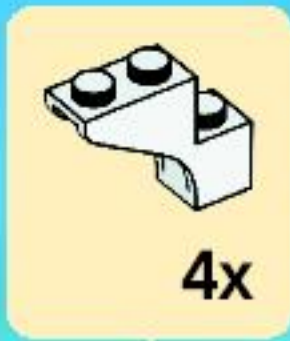

7

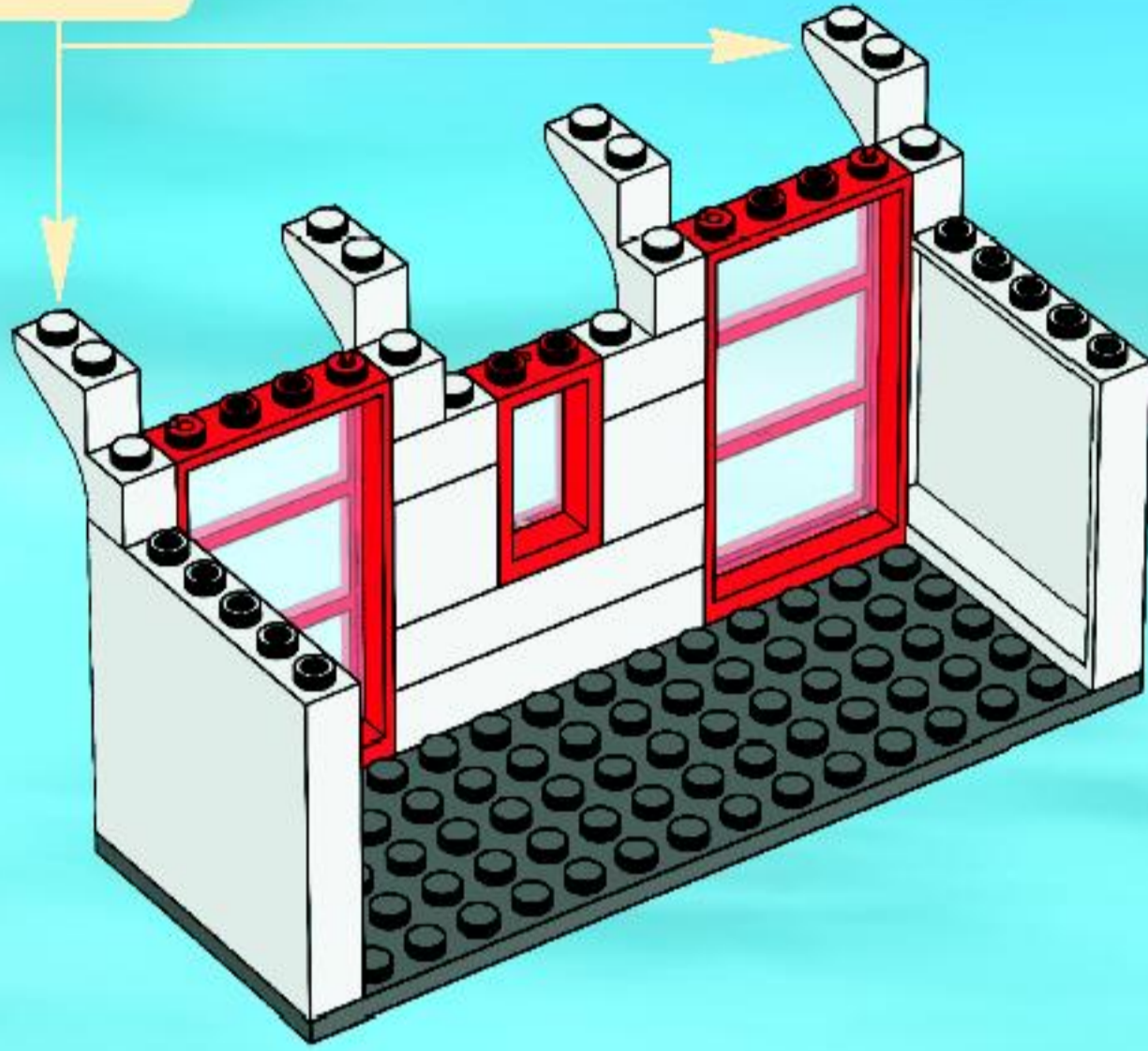

8

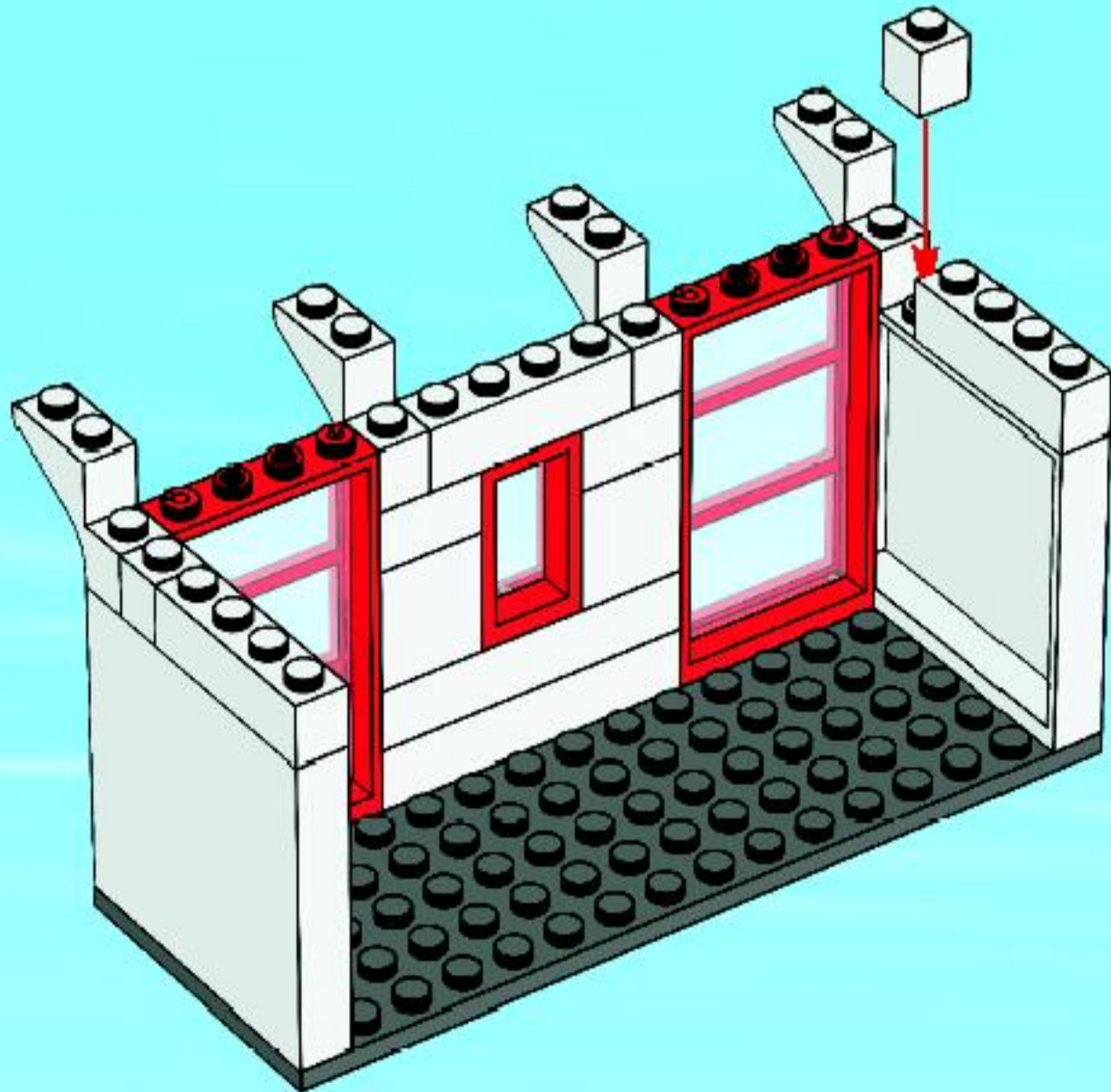

9

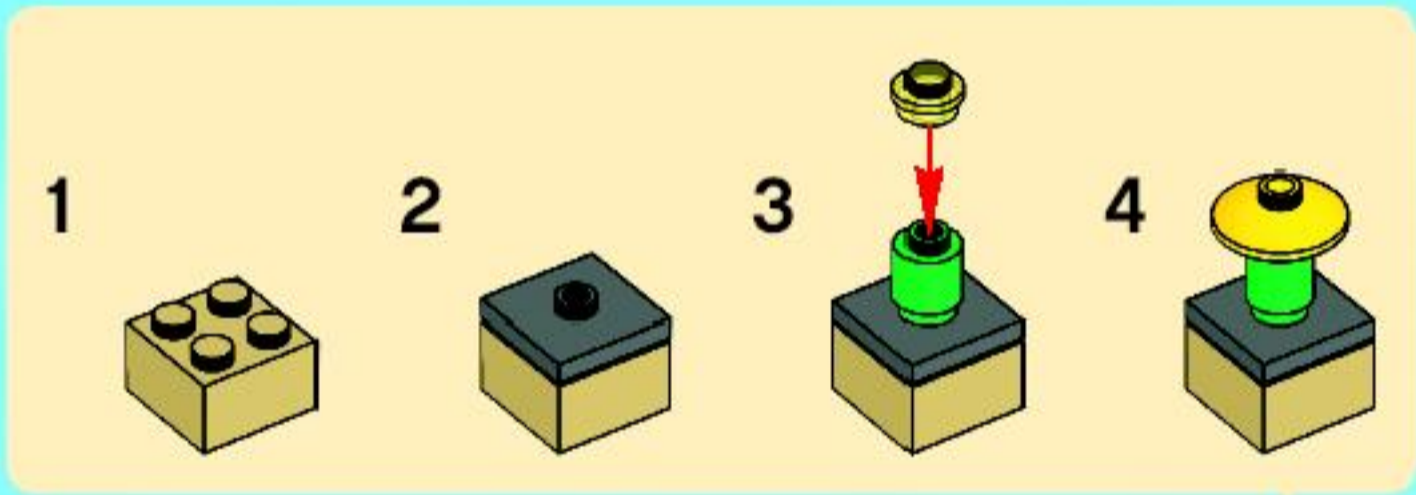
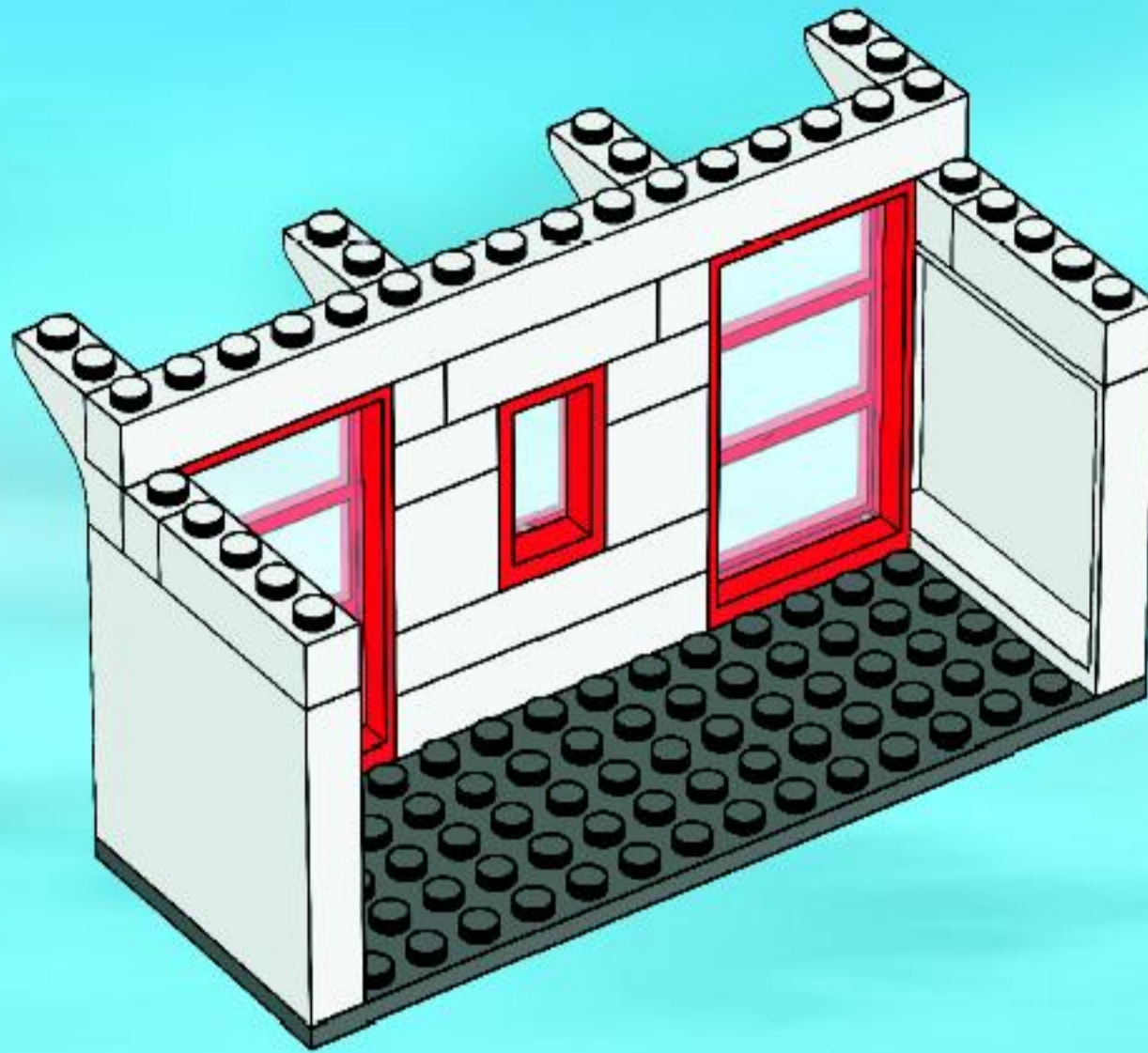

10

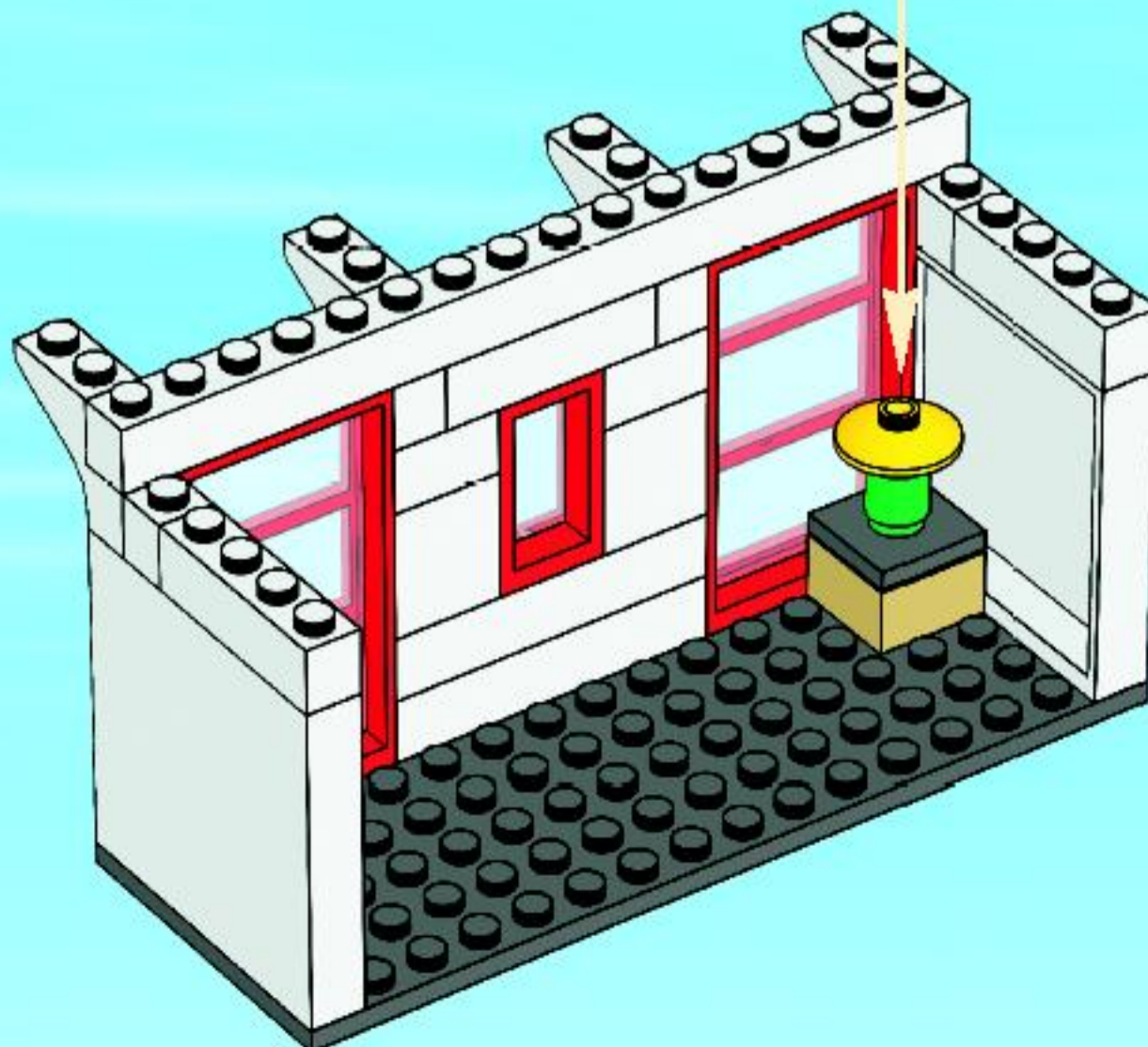

1



2

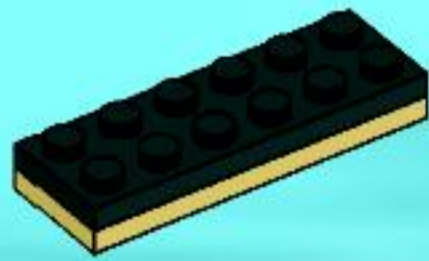

3

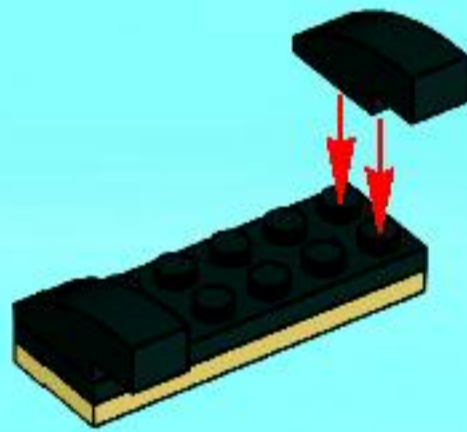

4

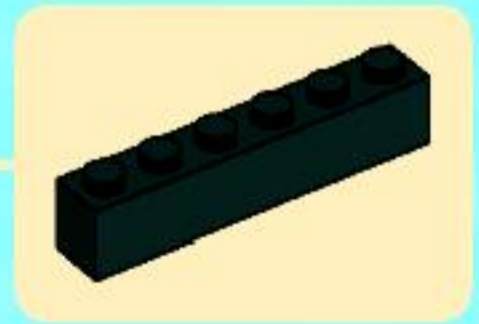

5

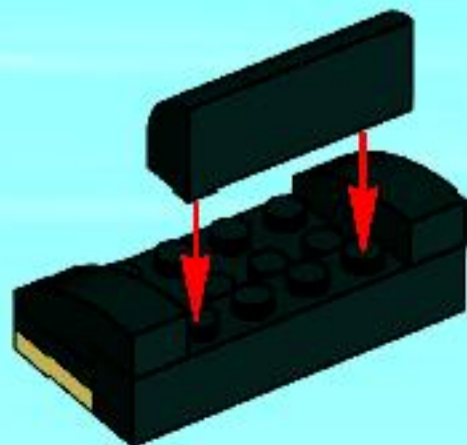

11

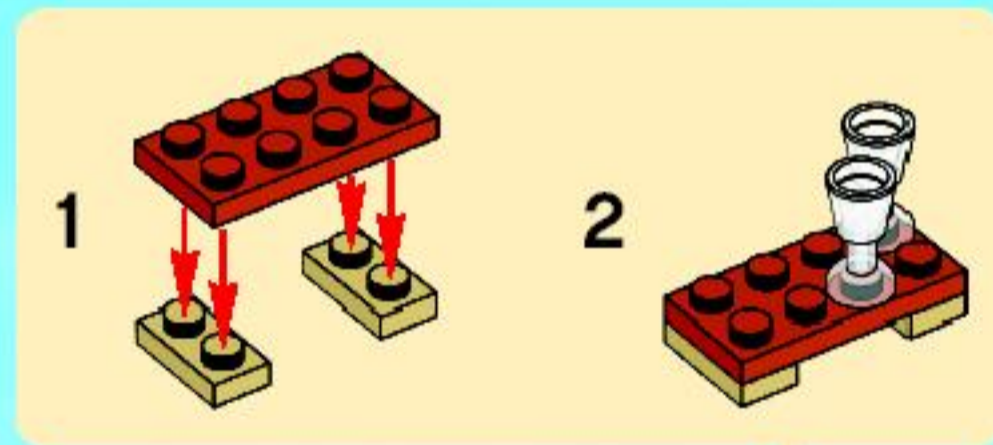
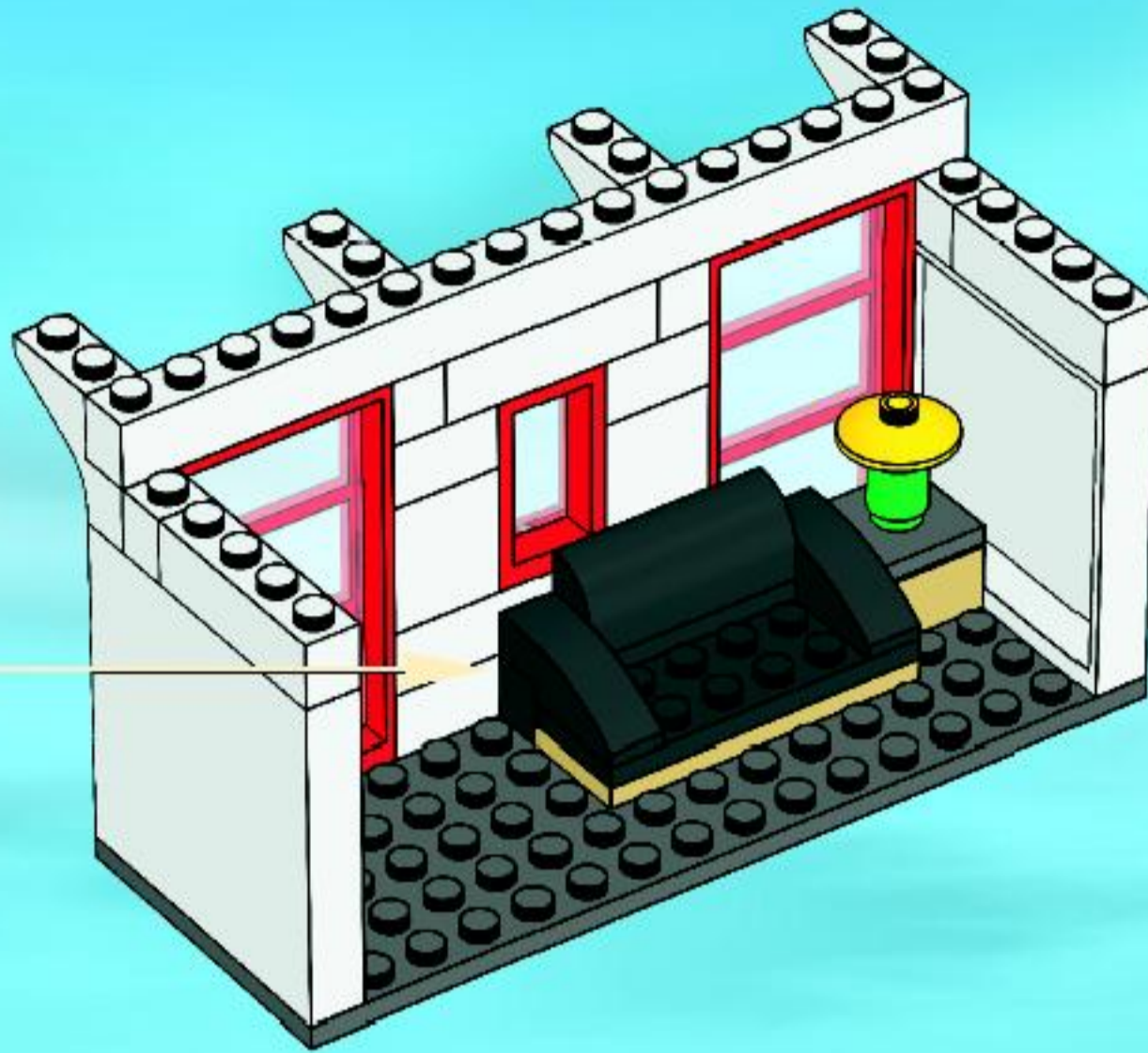

12

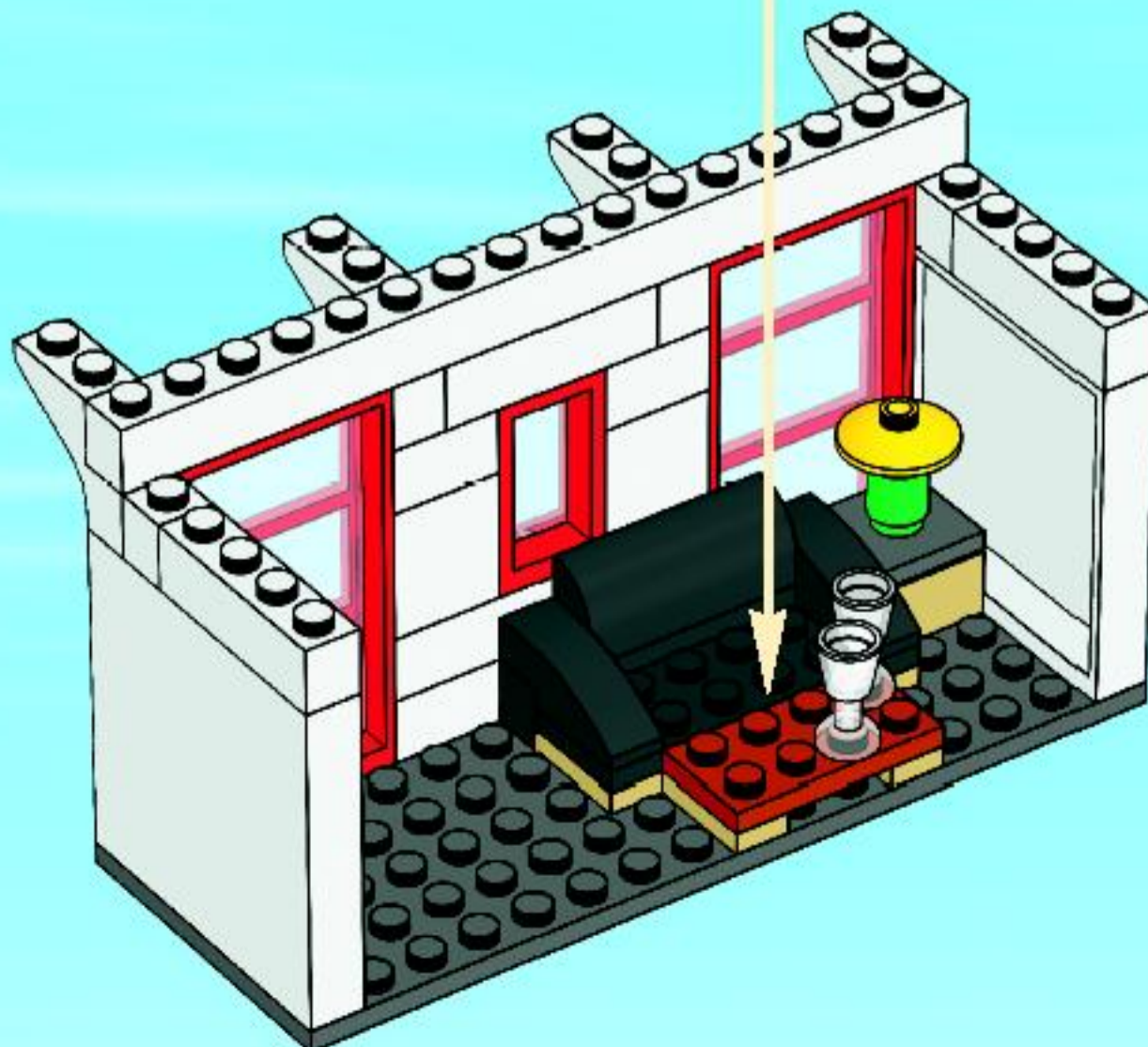

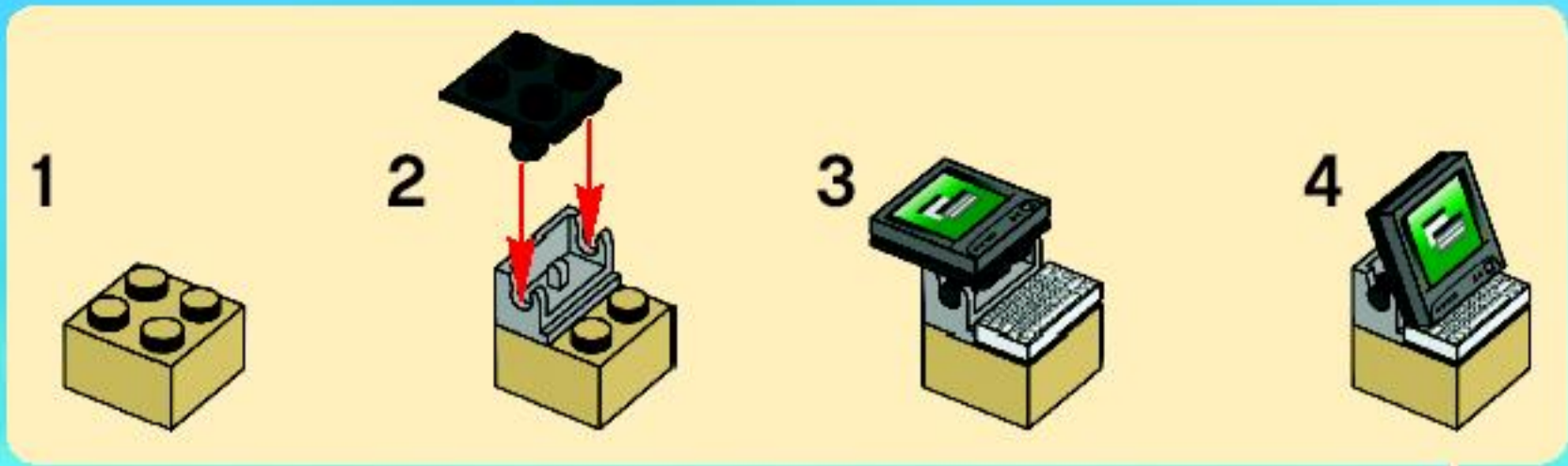

13



14

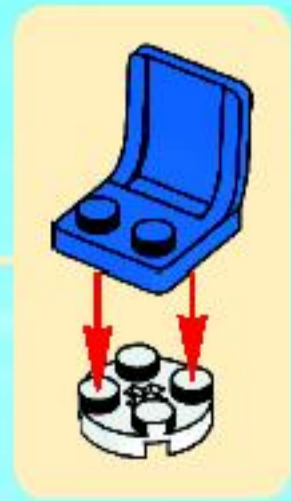
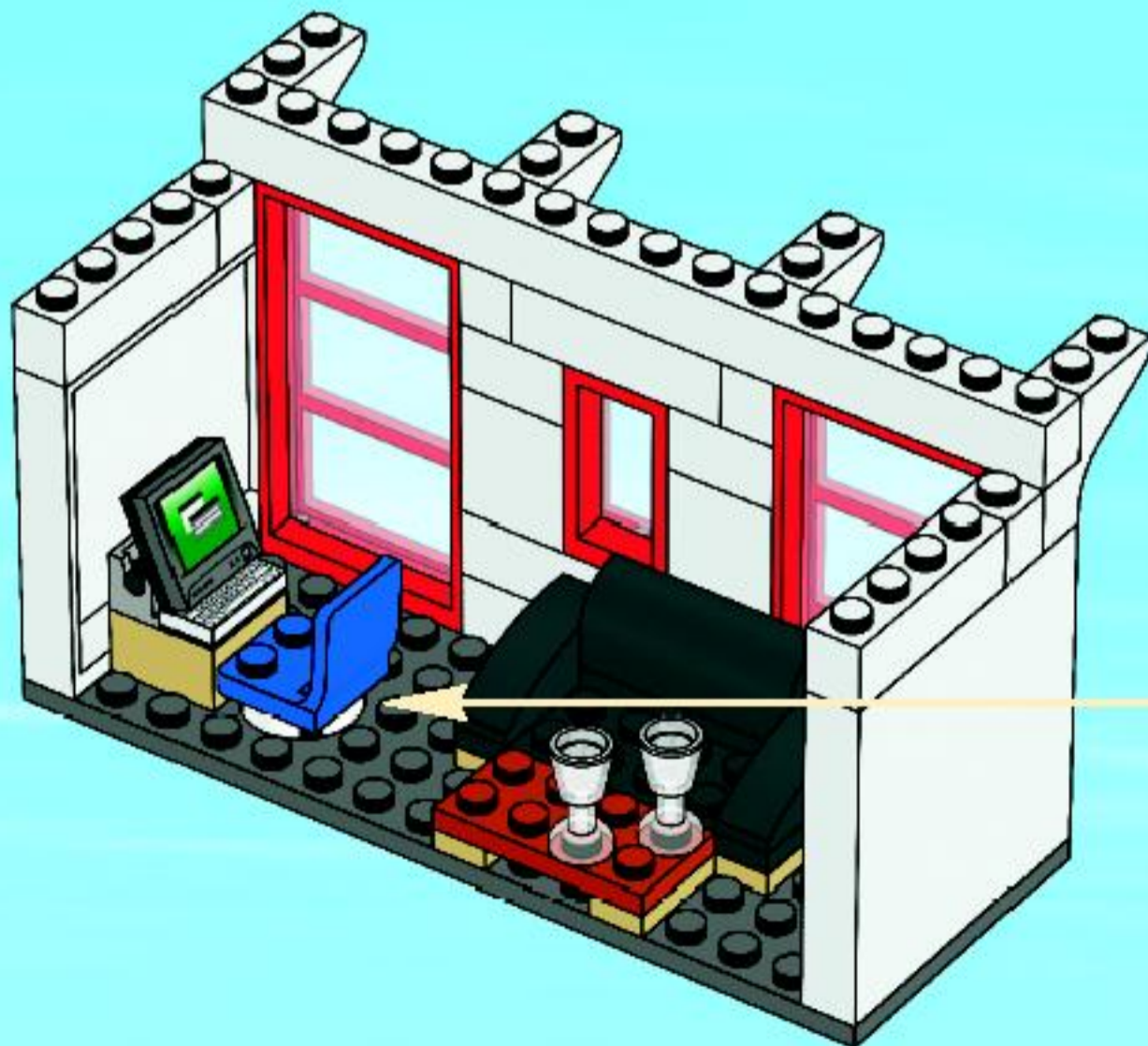

15

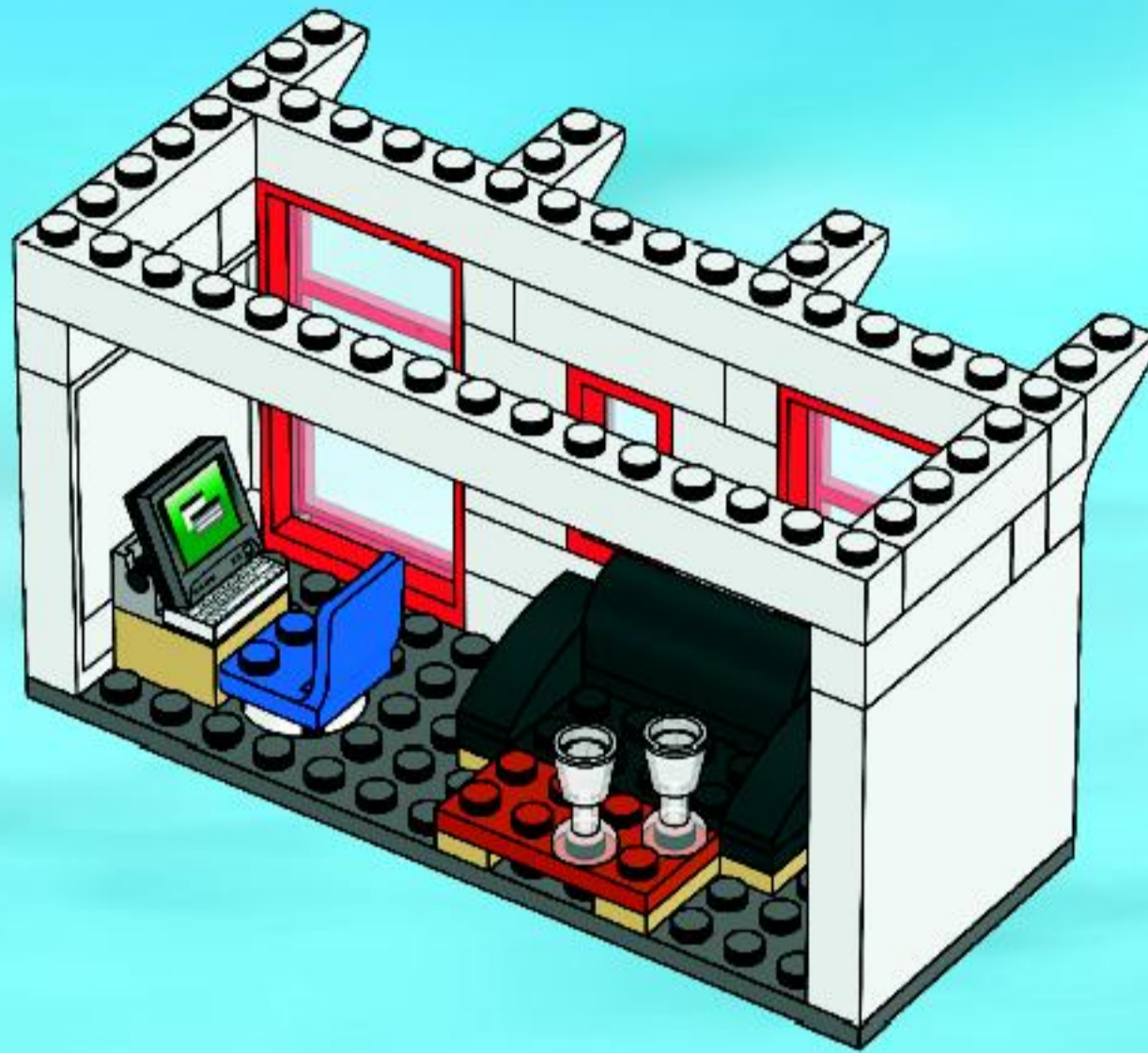

16

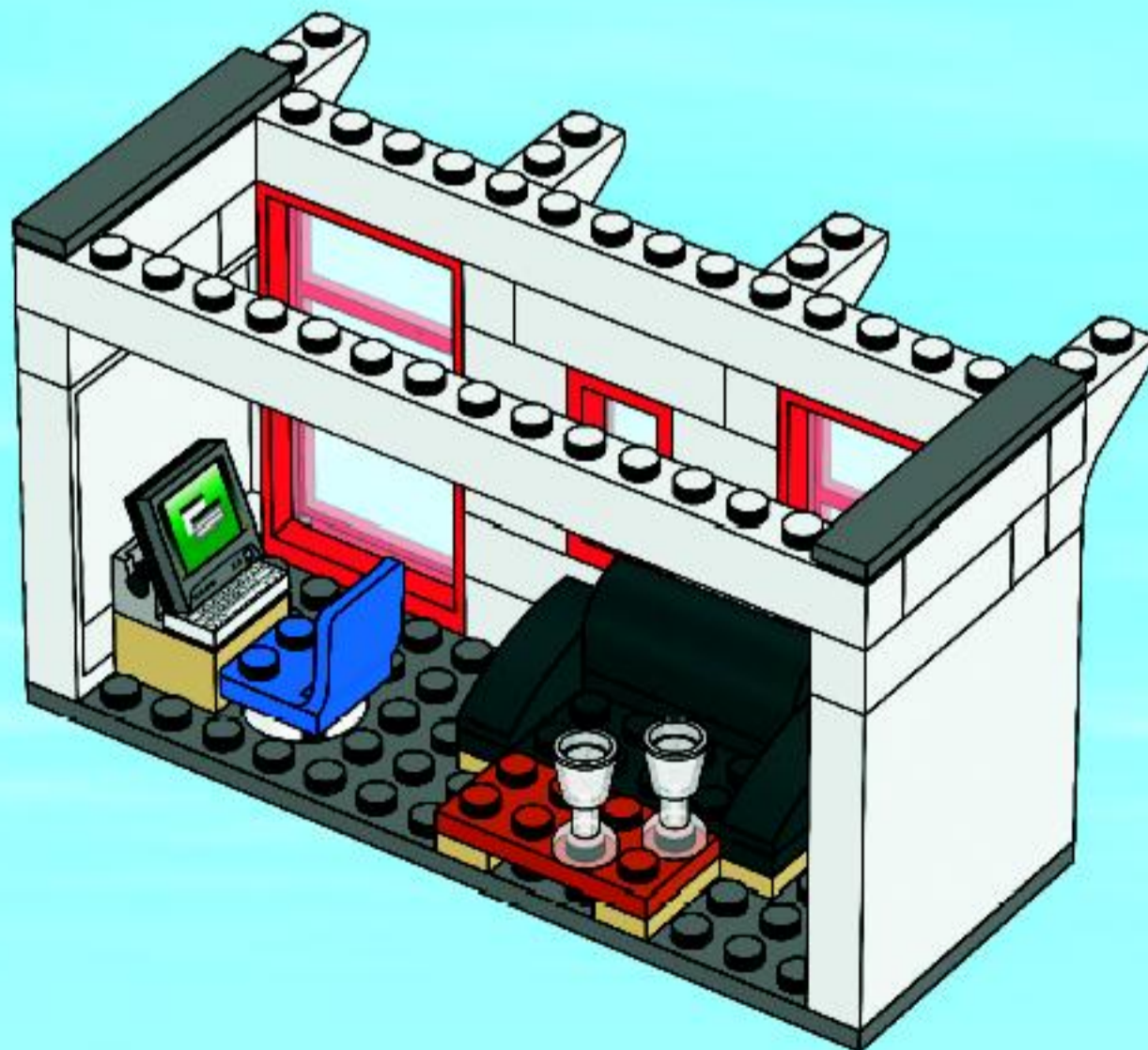

17

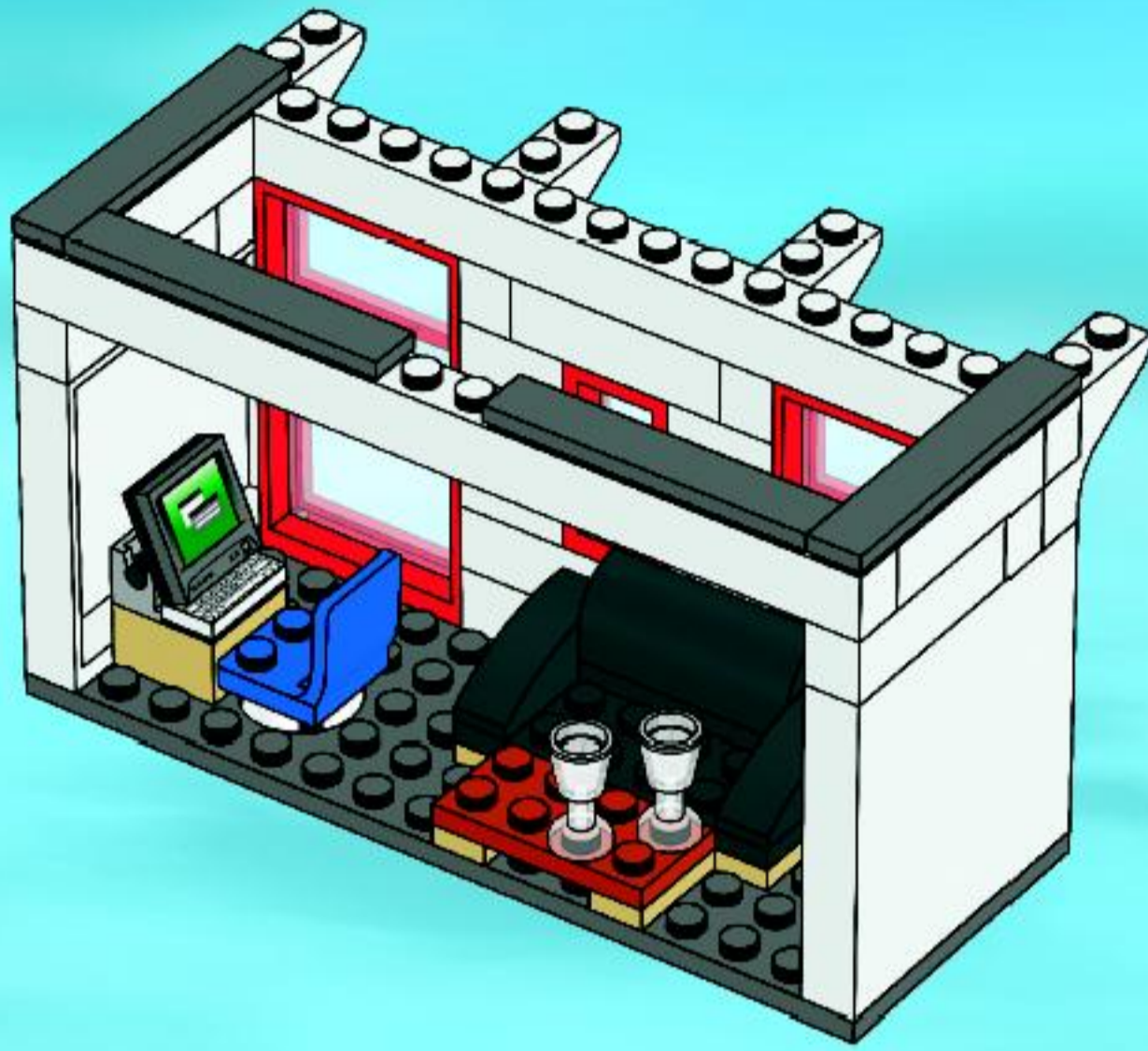

18

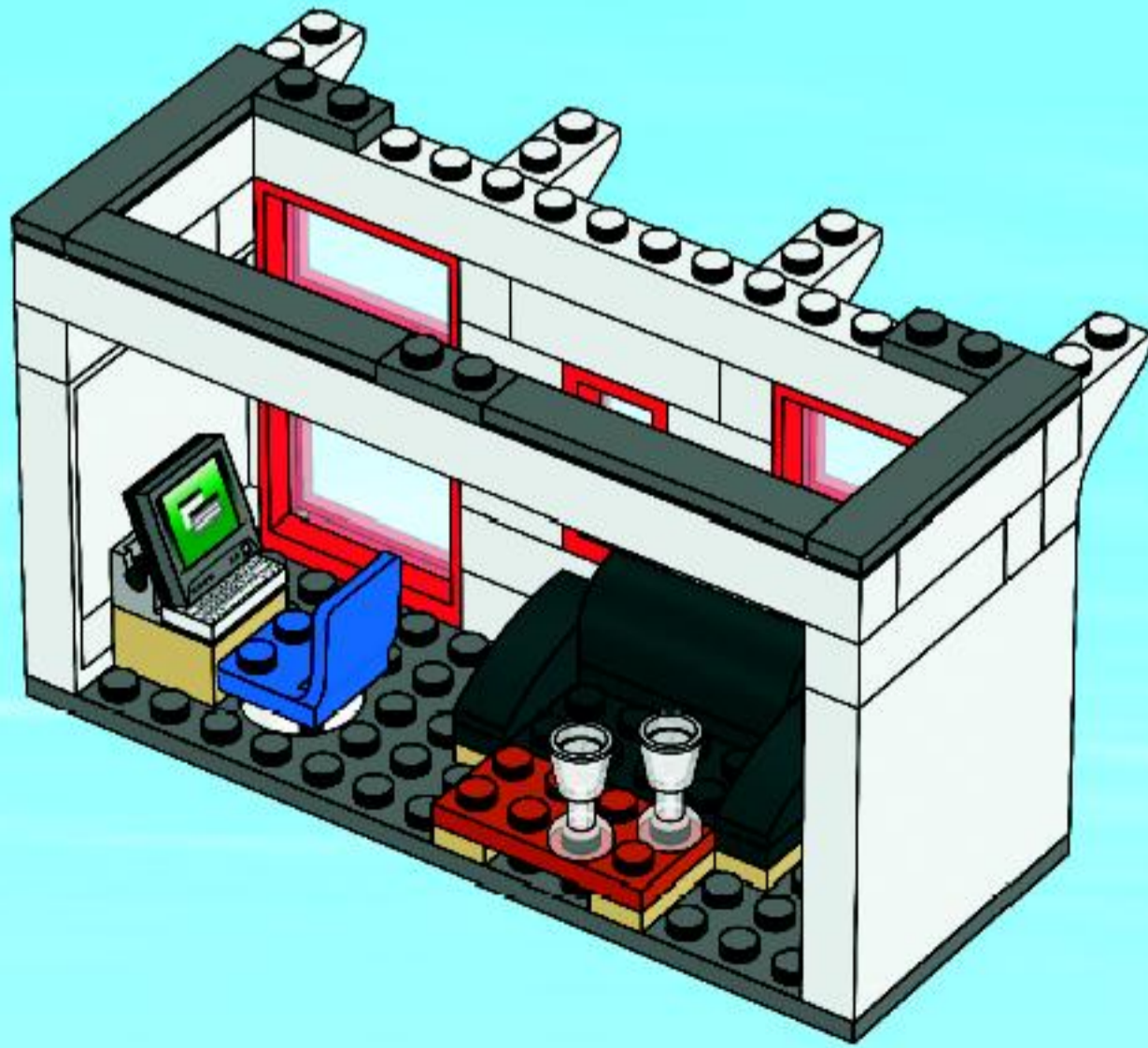

19

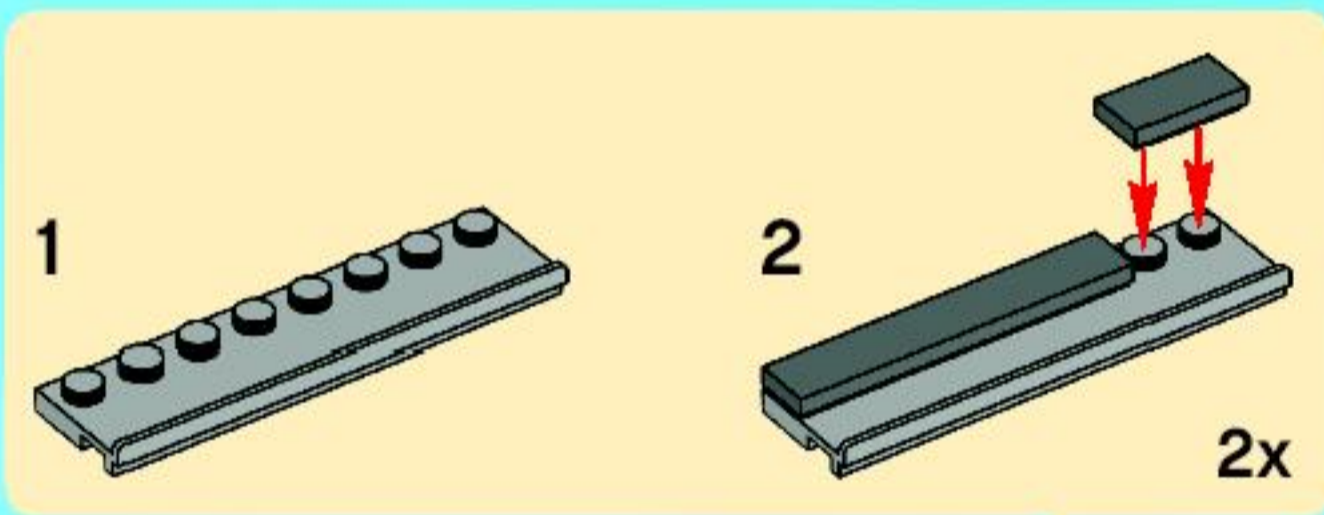
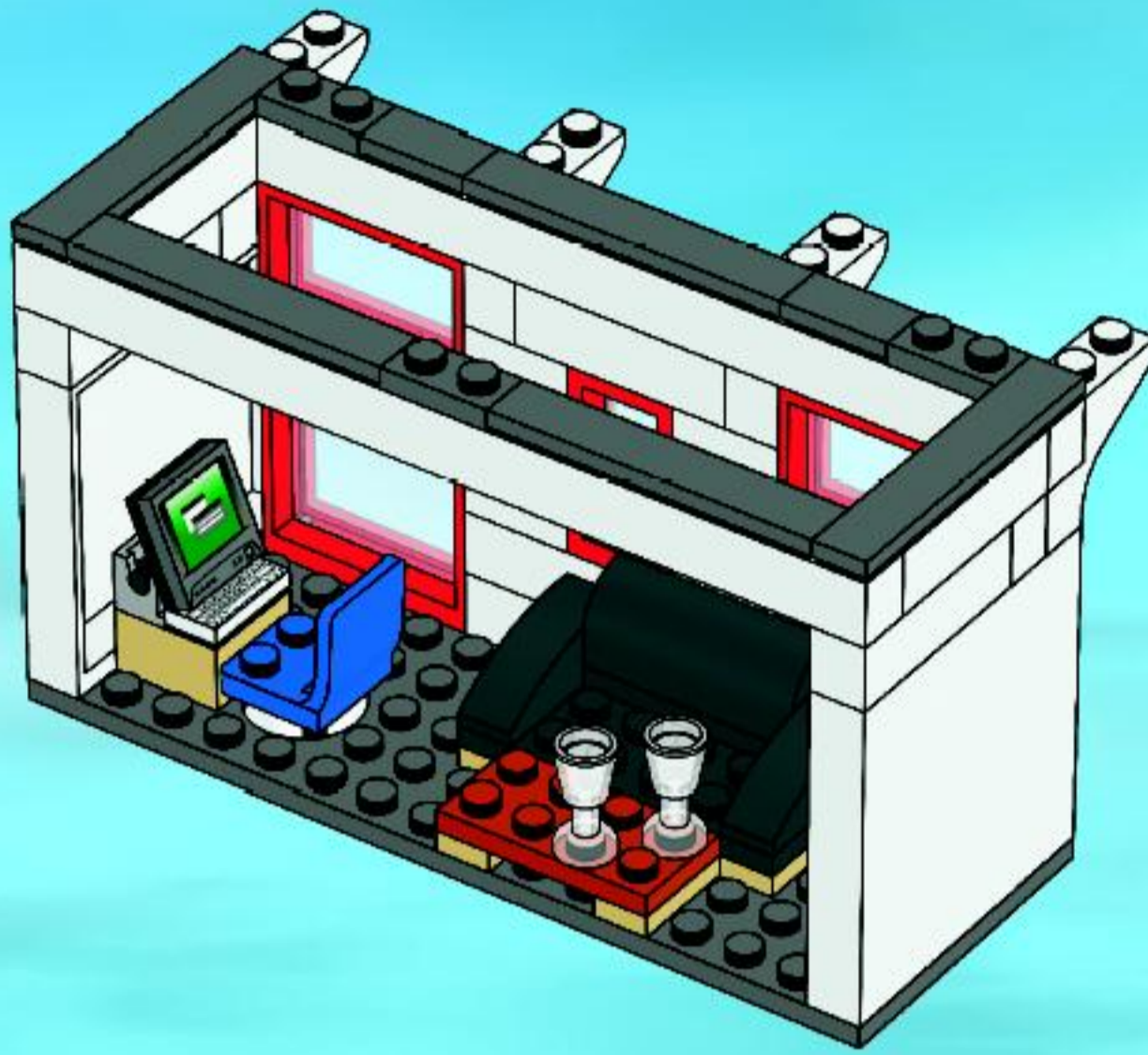

20

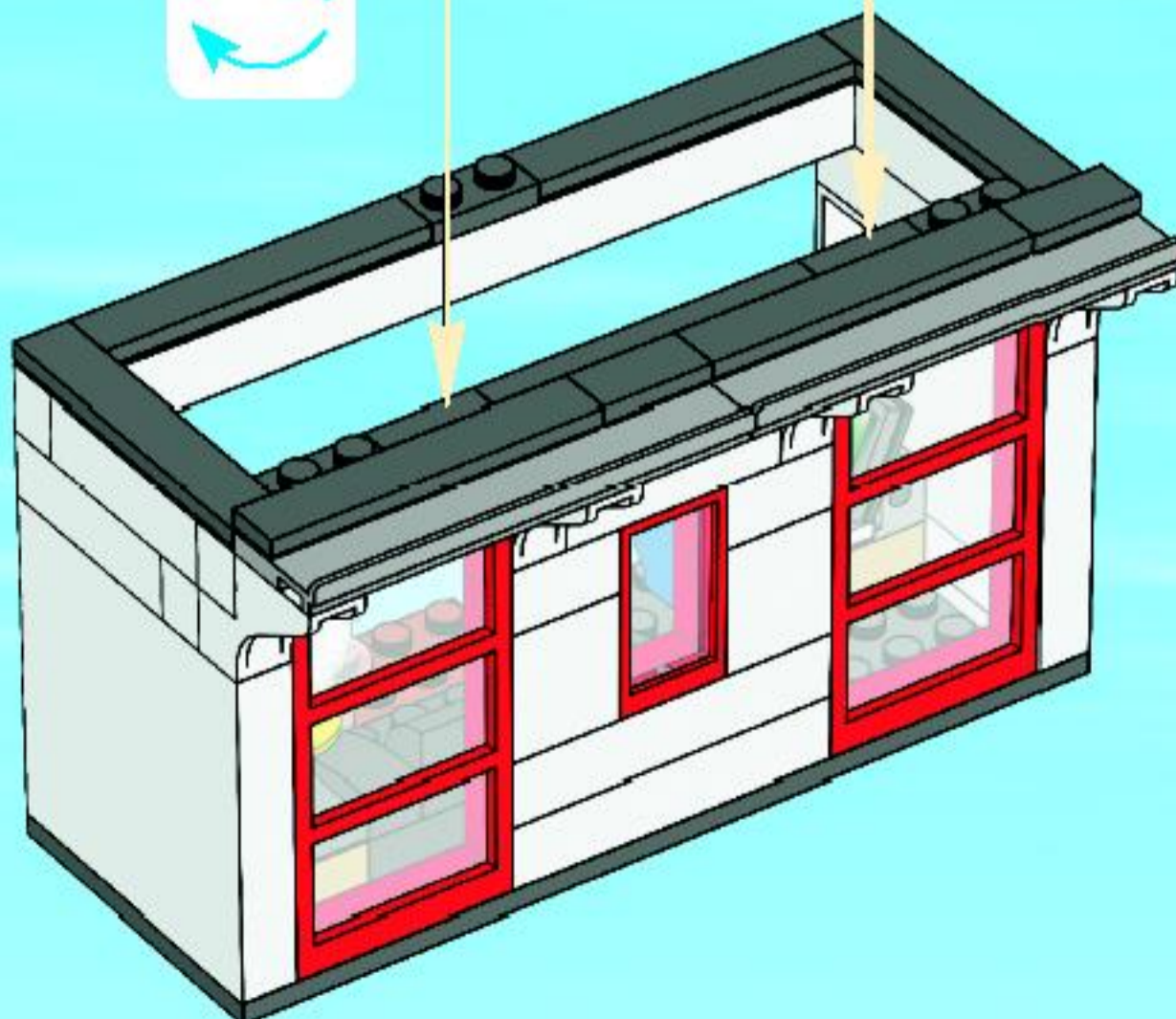

21

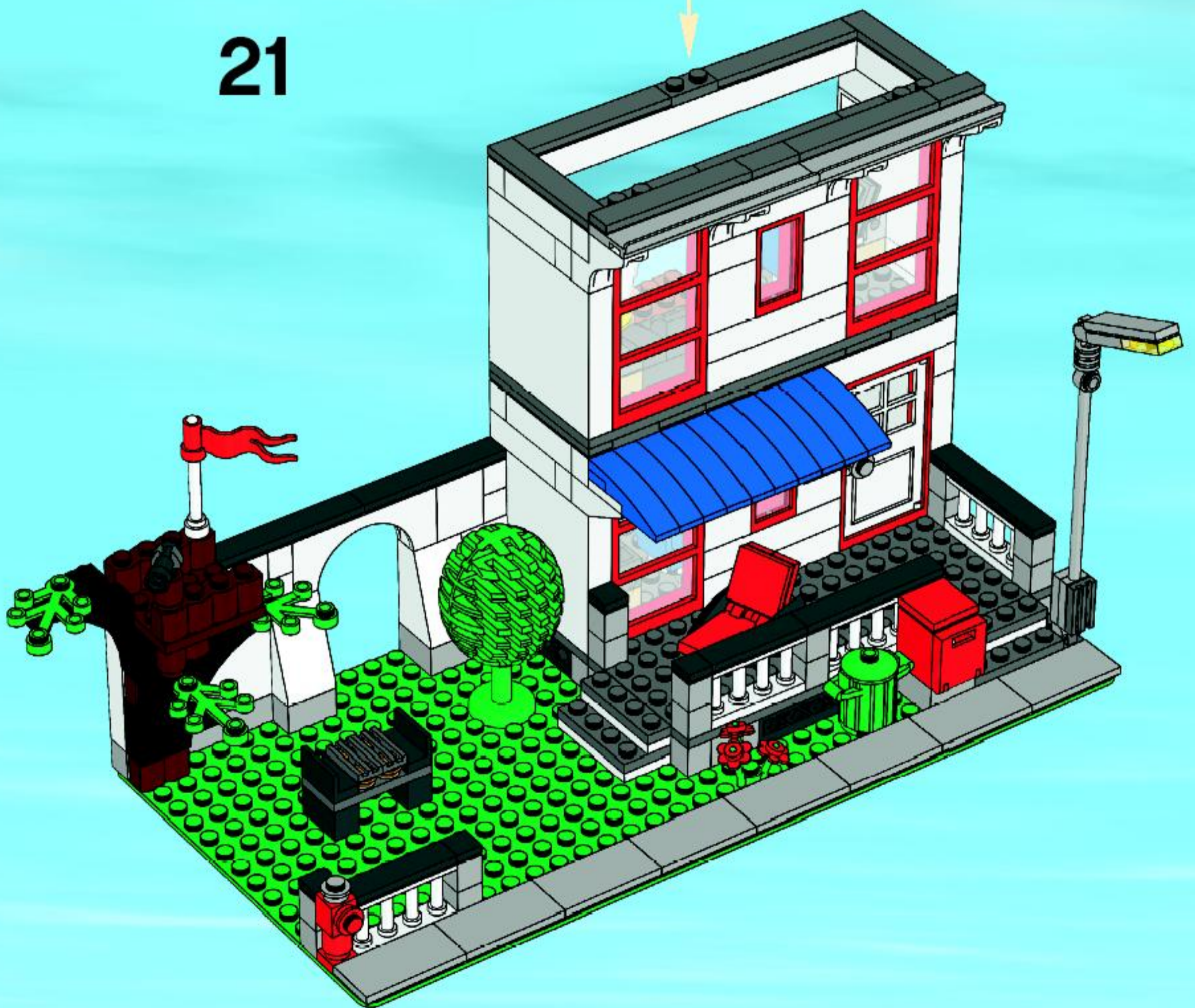



+

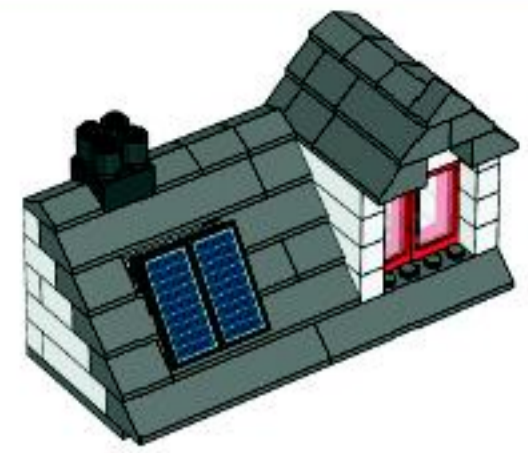

1

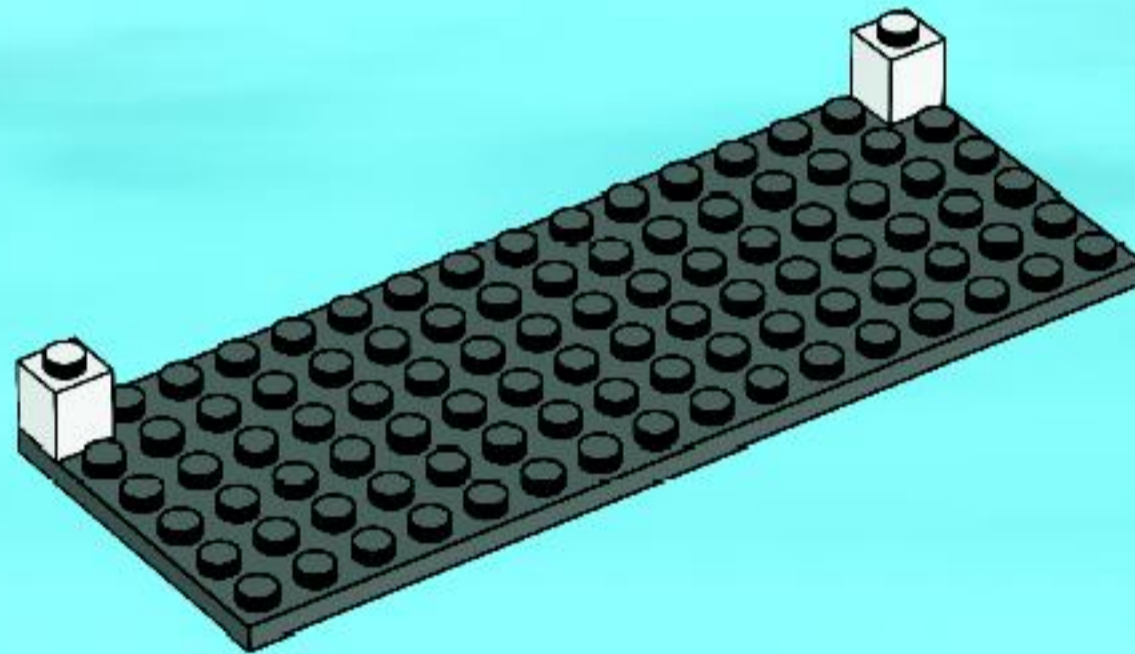

2

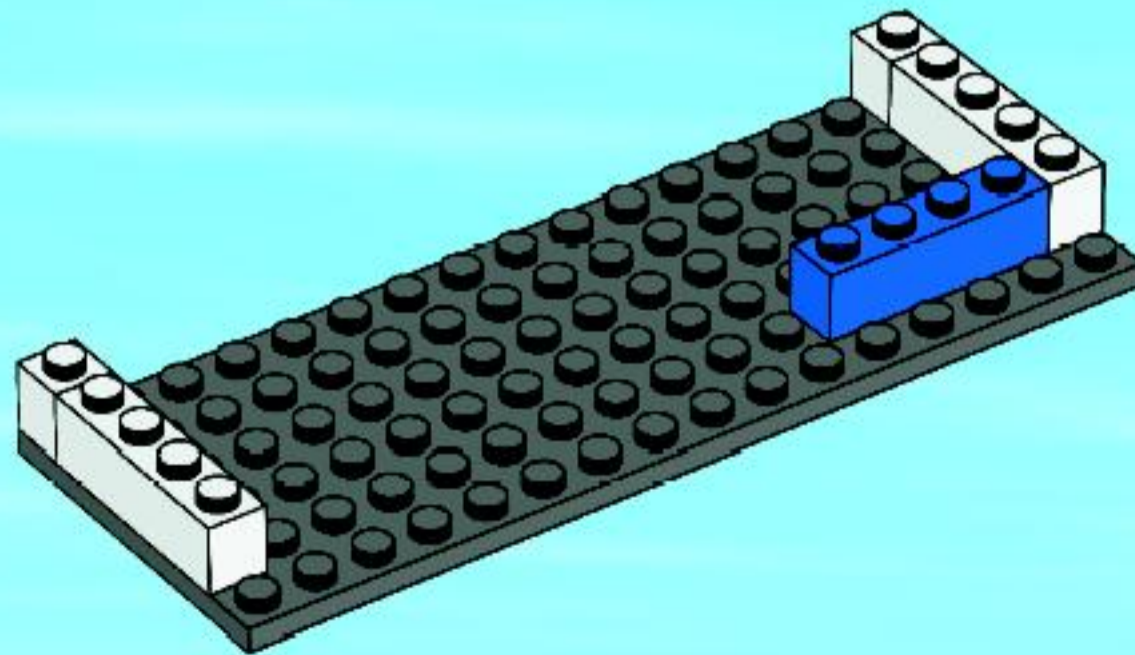

3

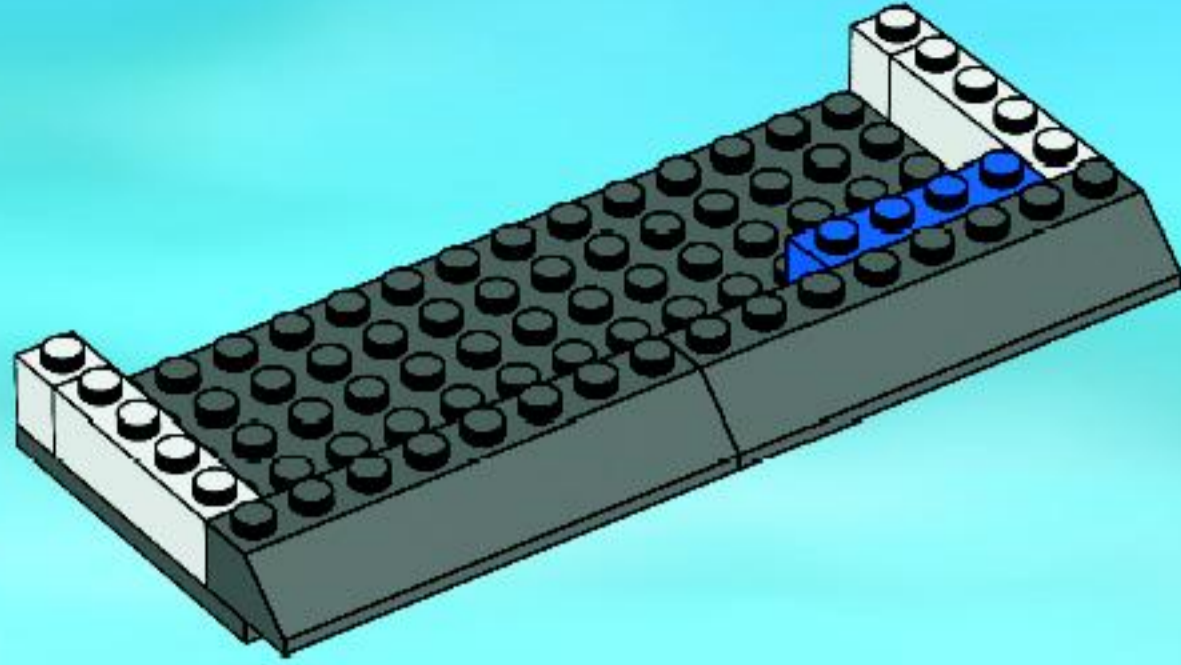

4

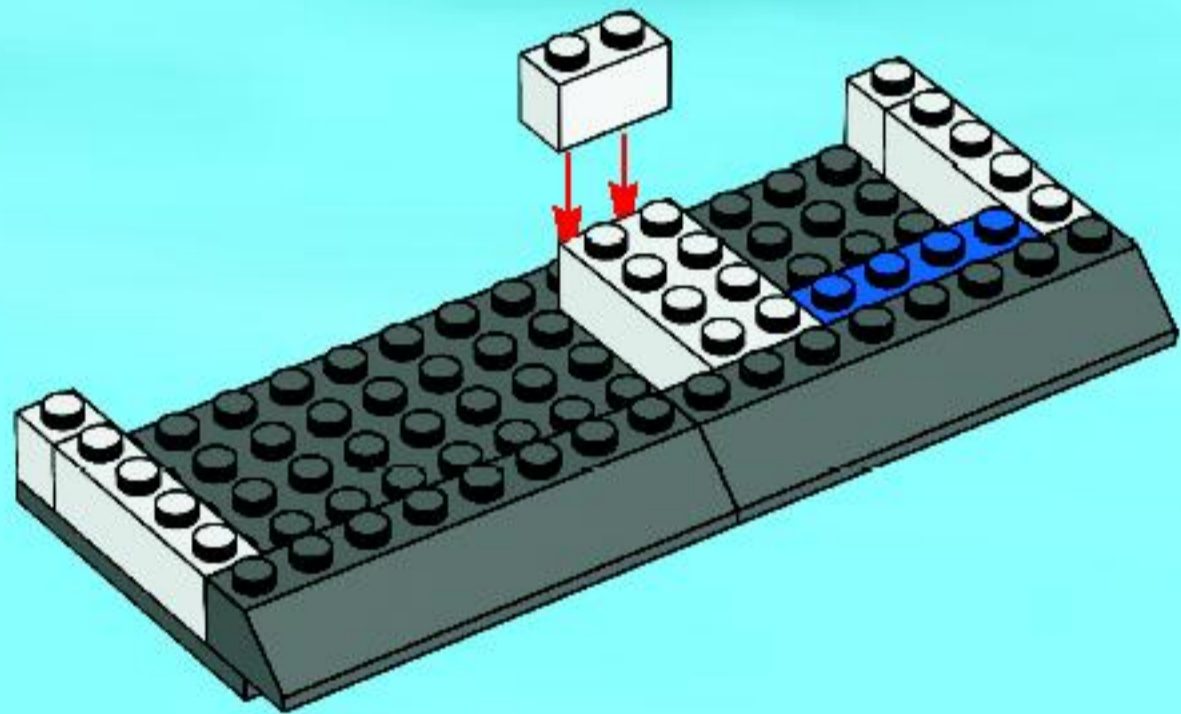

5

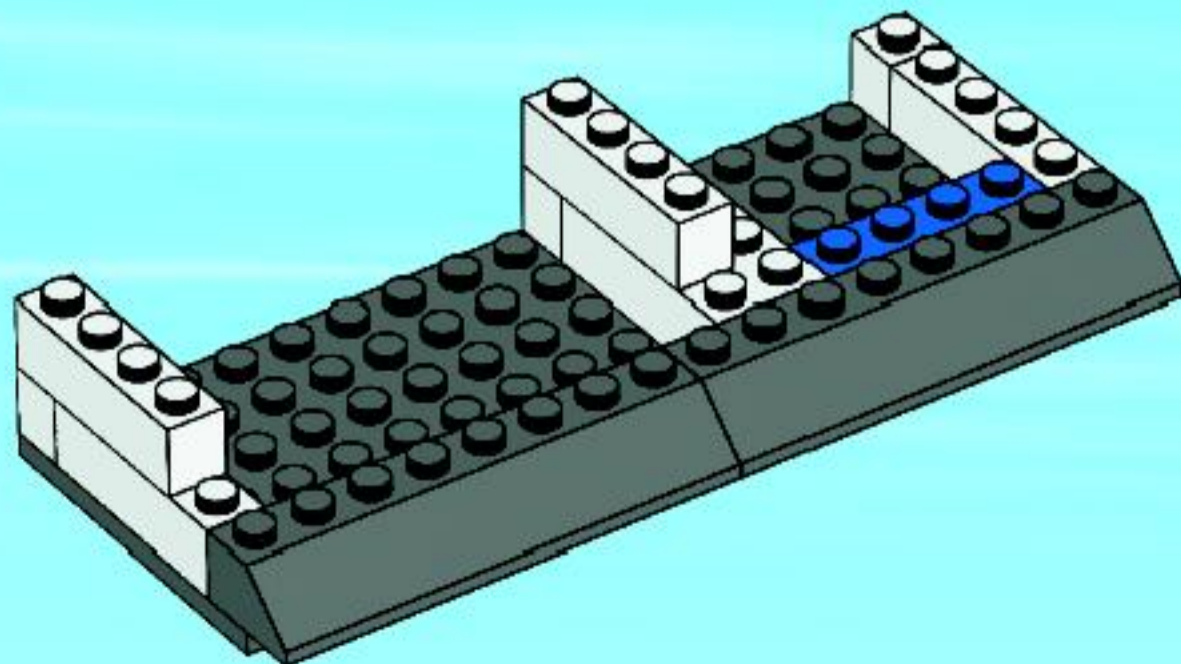

6

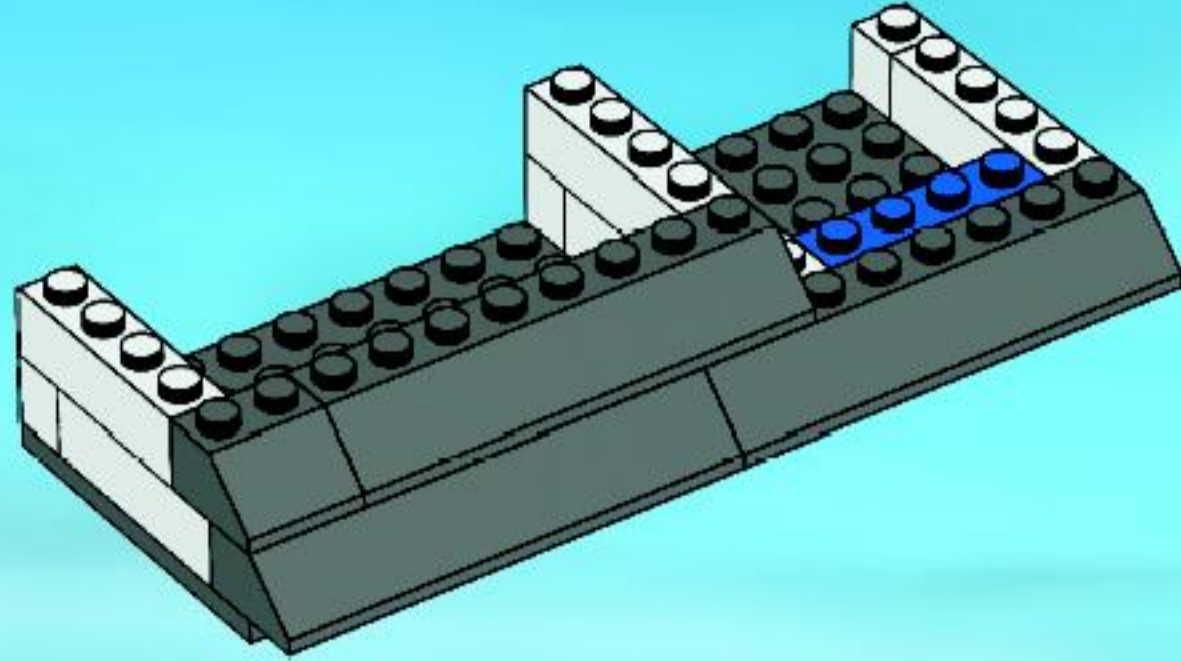

7

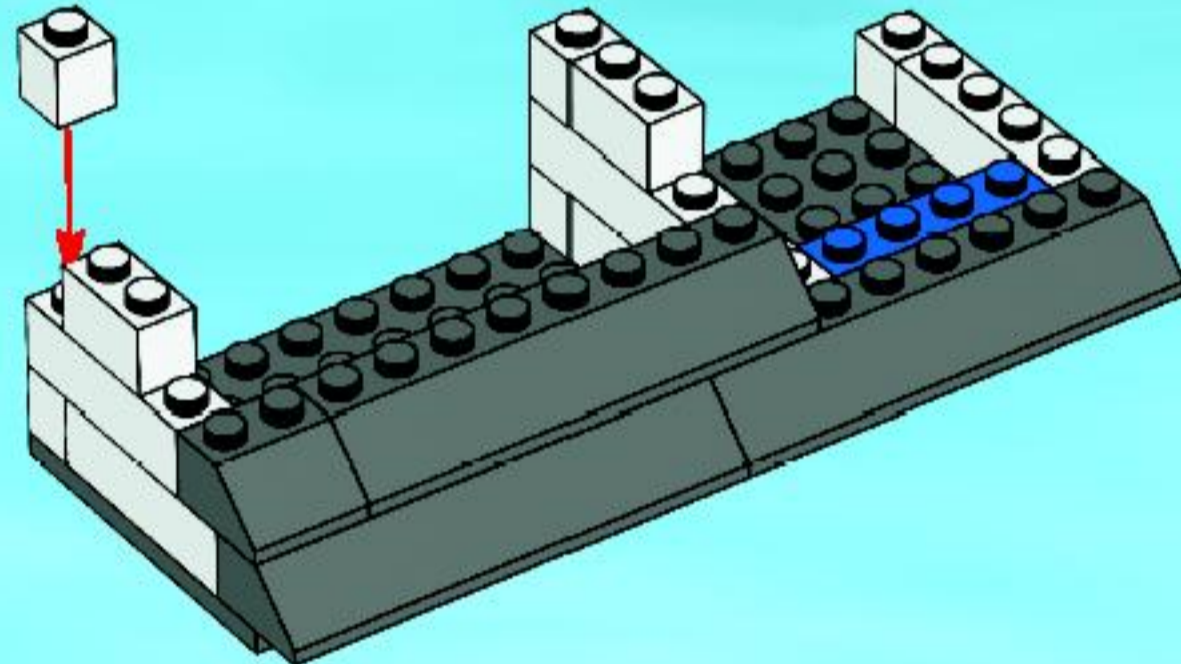

8

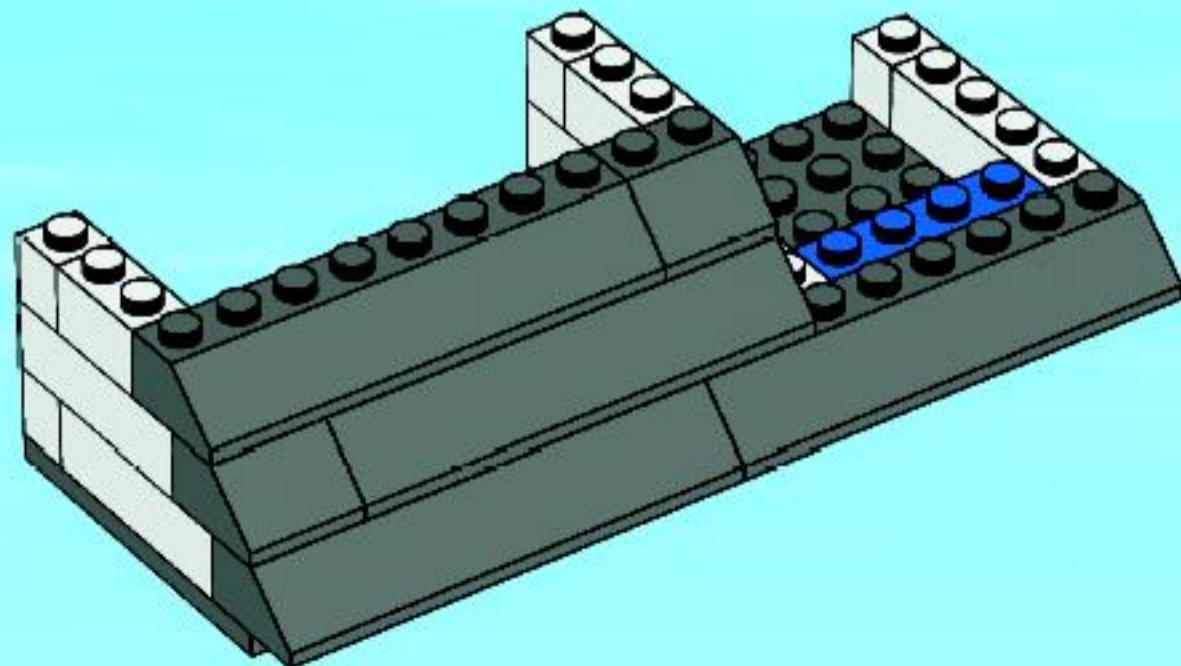

9

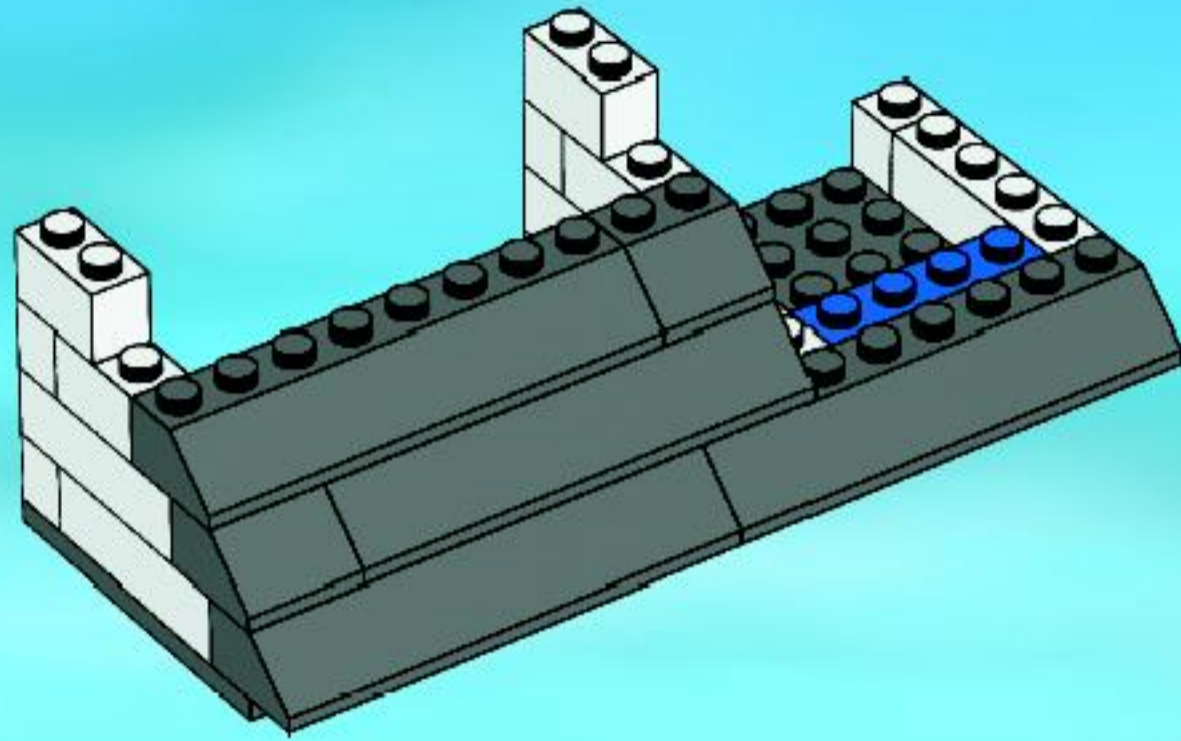

10

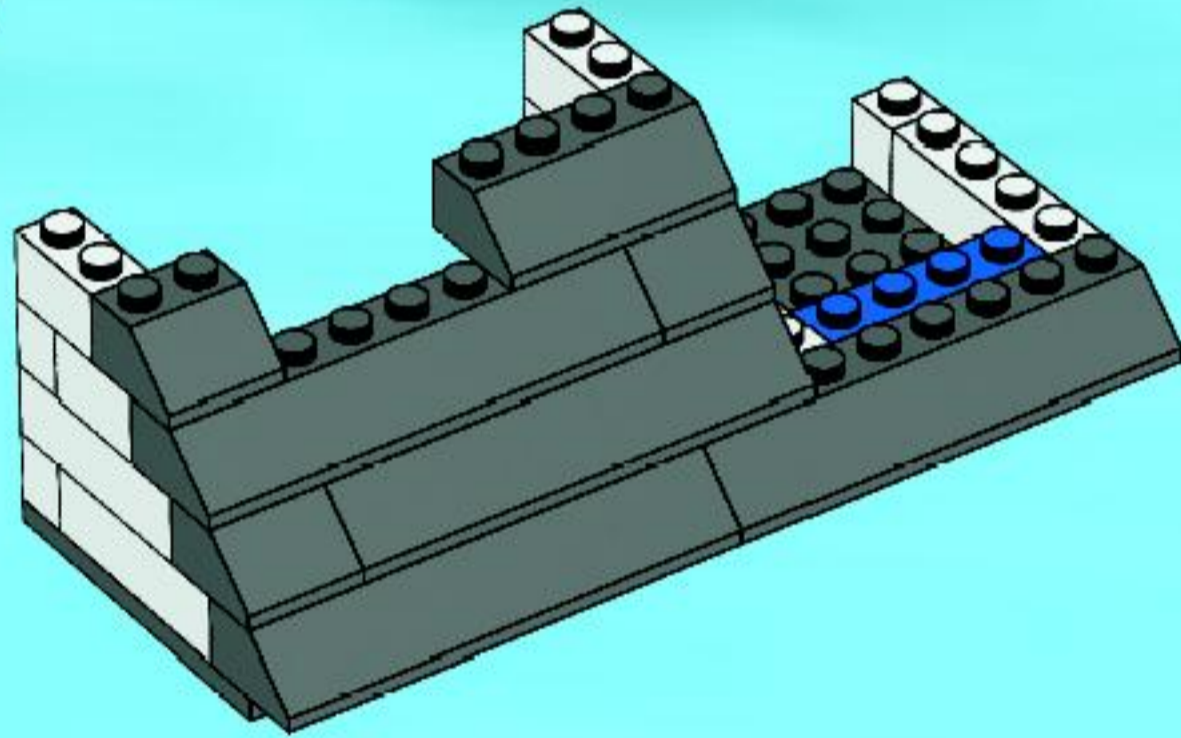

11

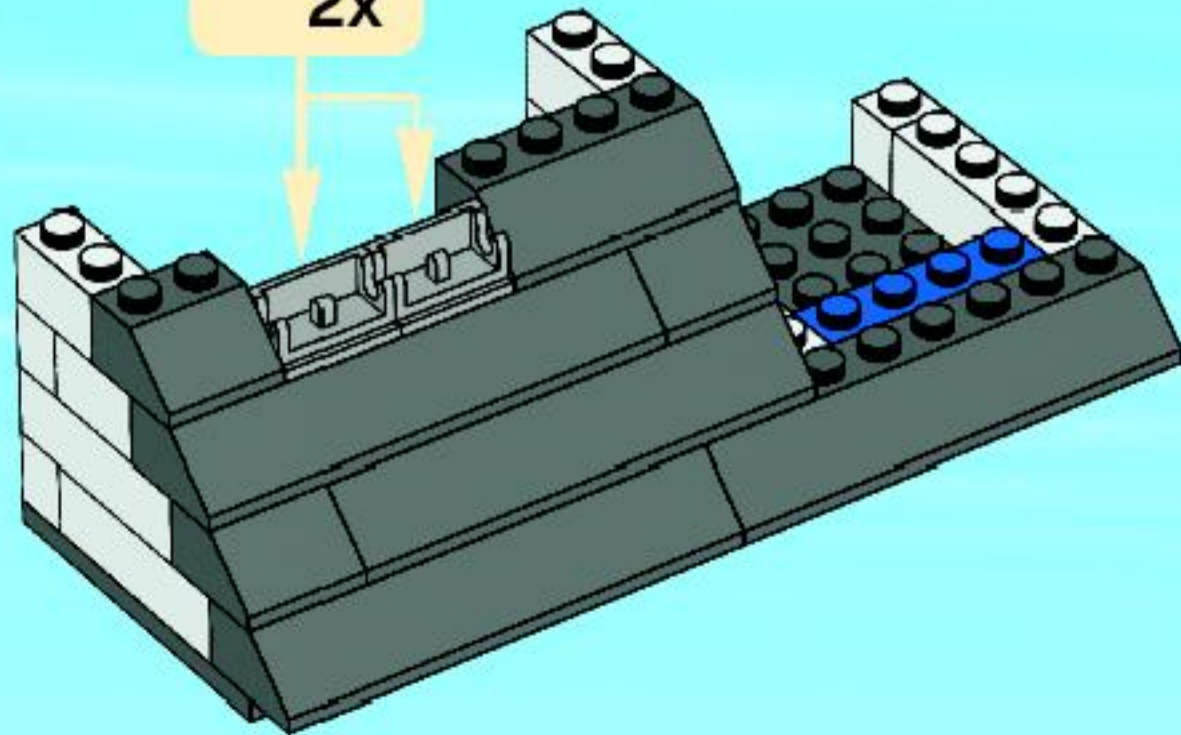
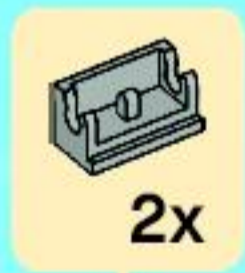

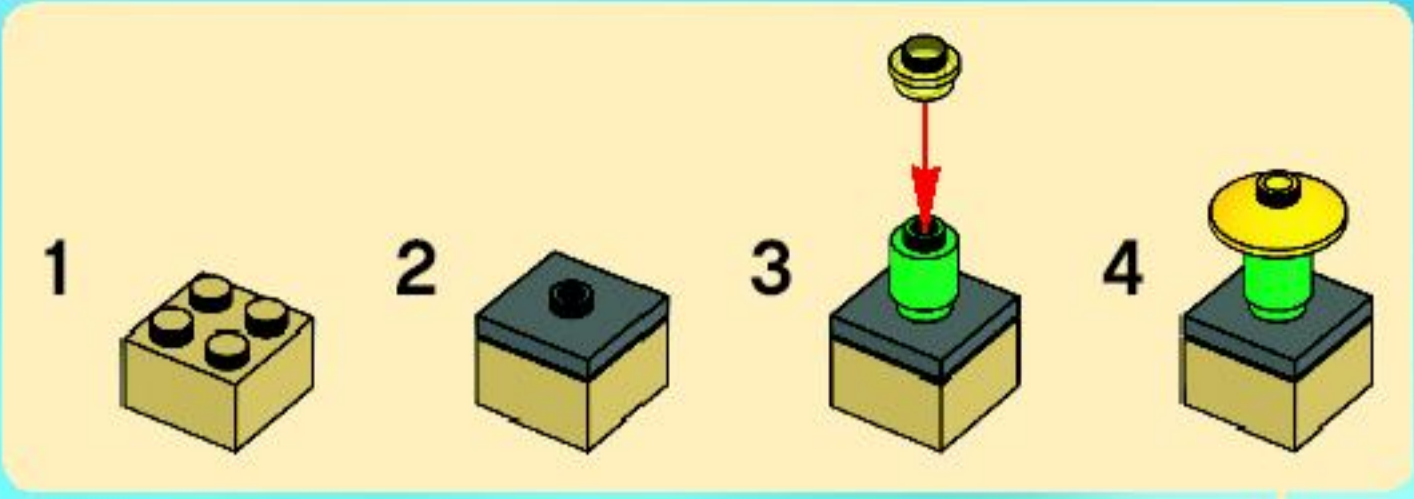

12

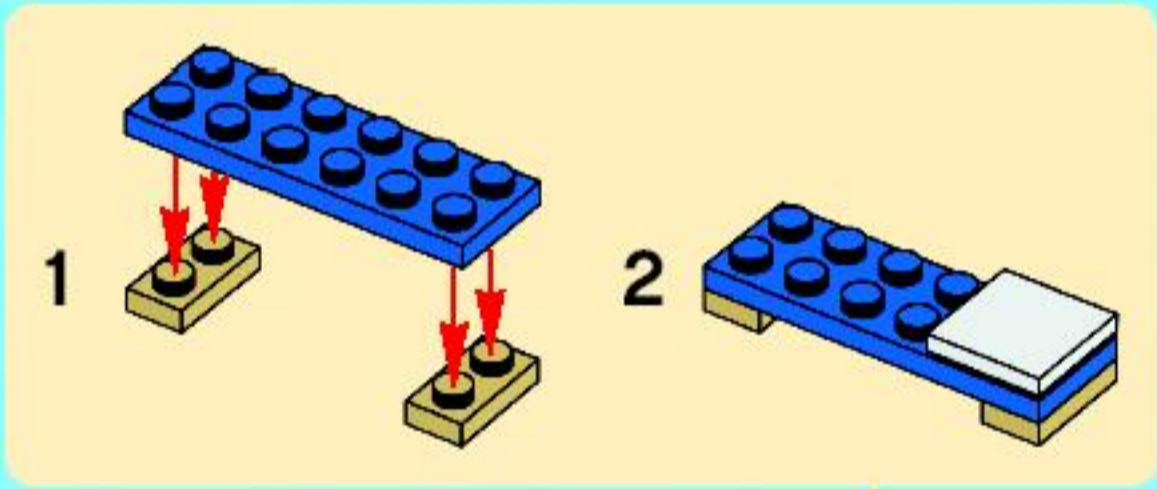
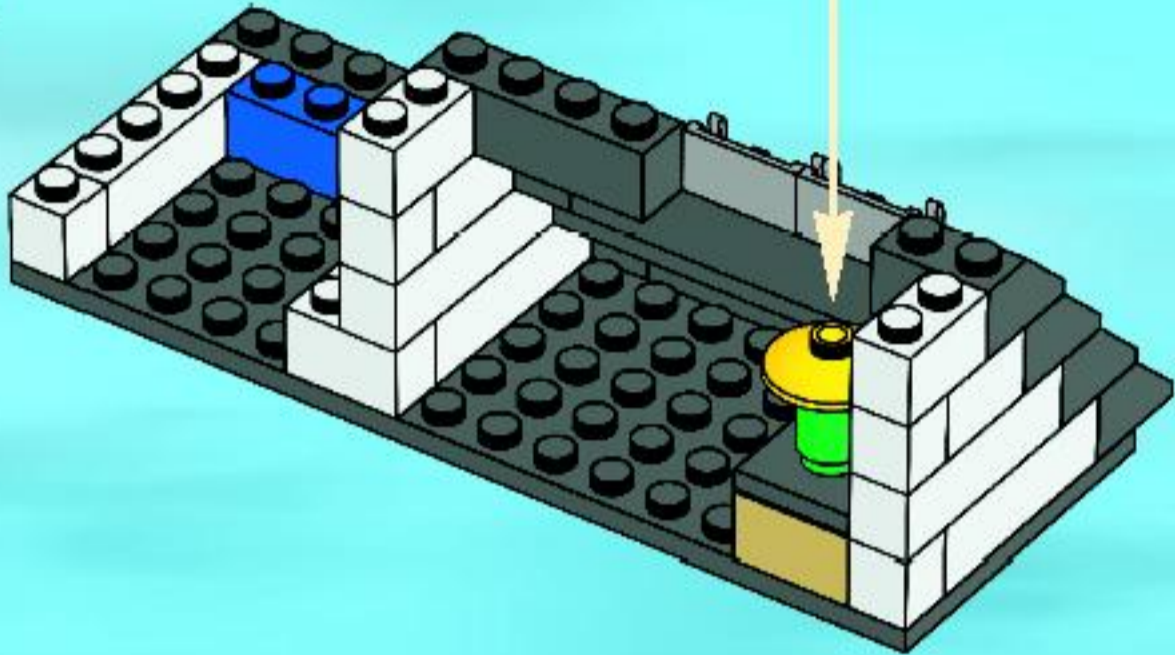

13

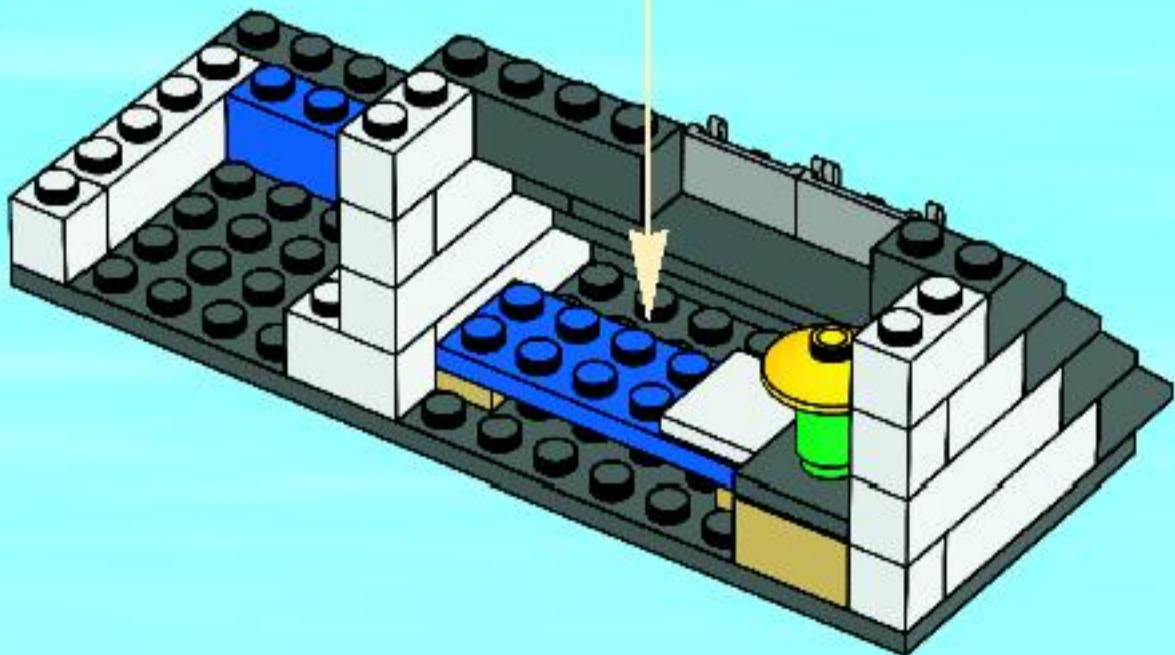

14

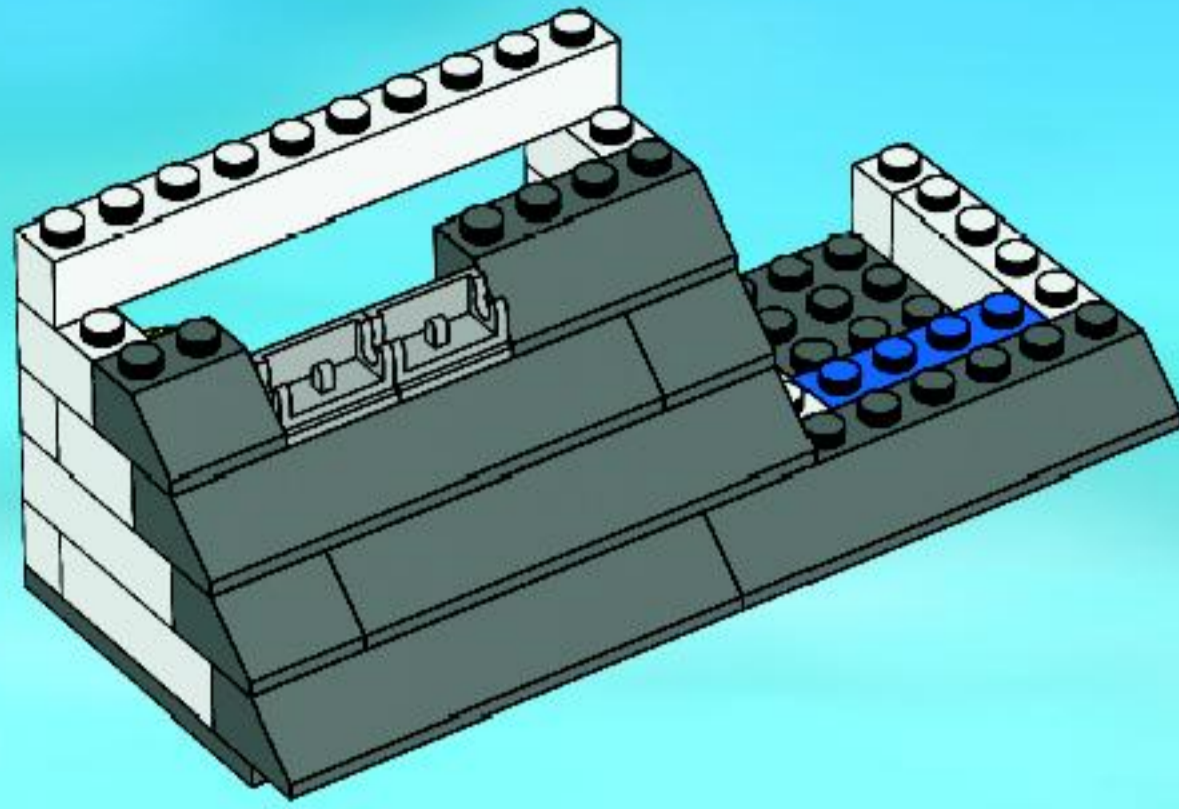

15

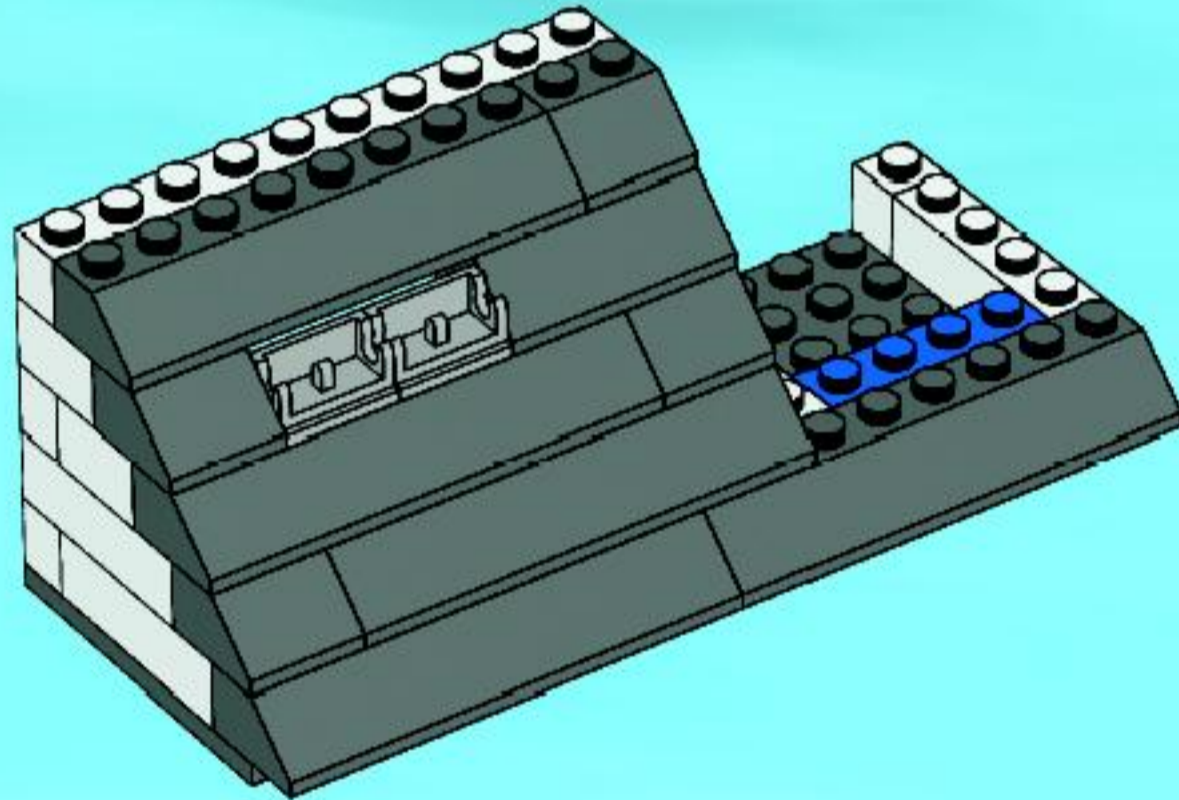

16

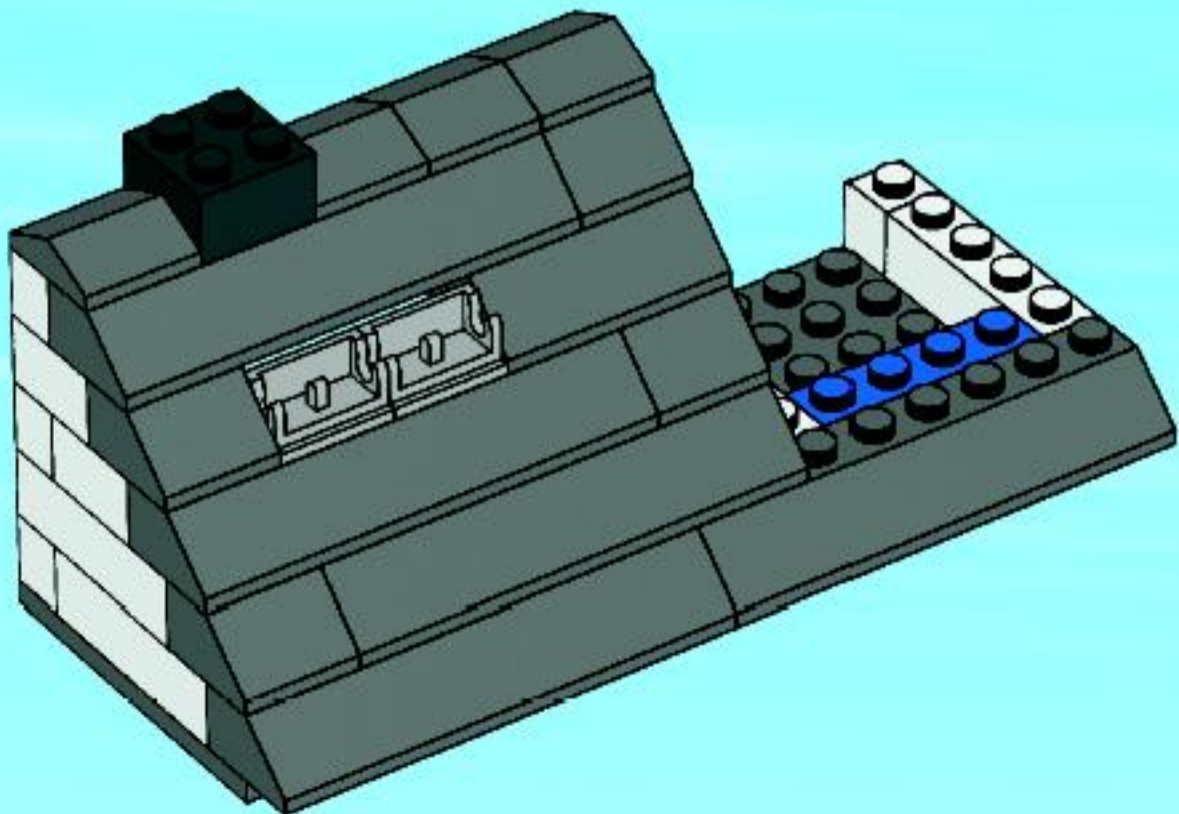

17

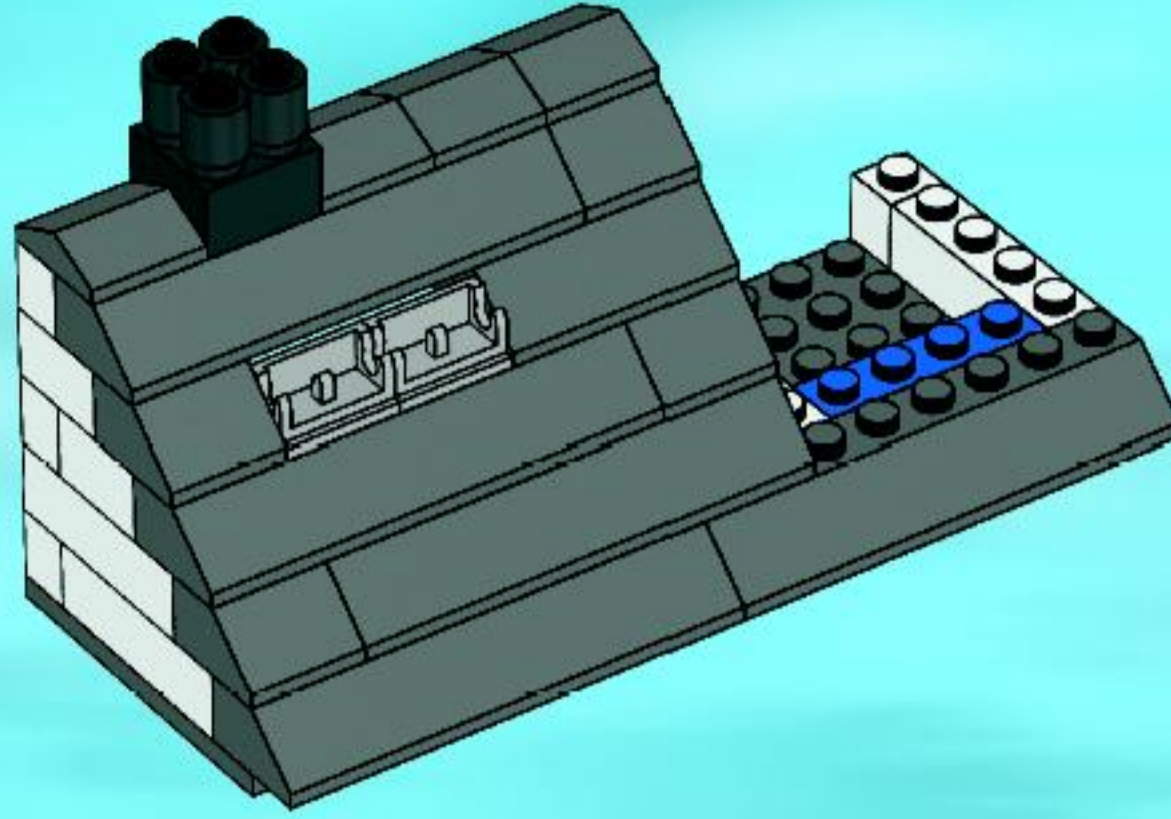

18

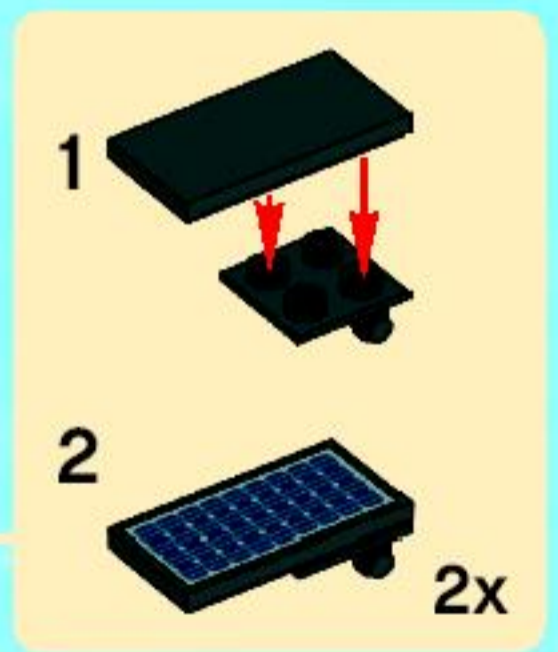
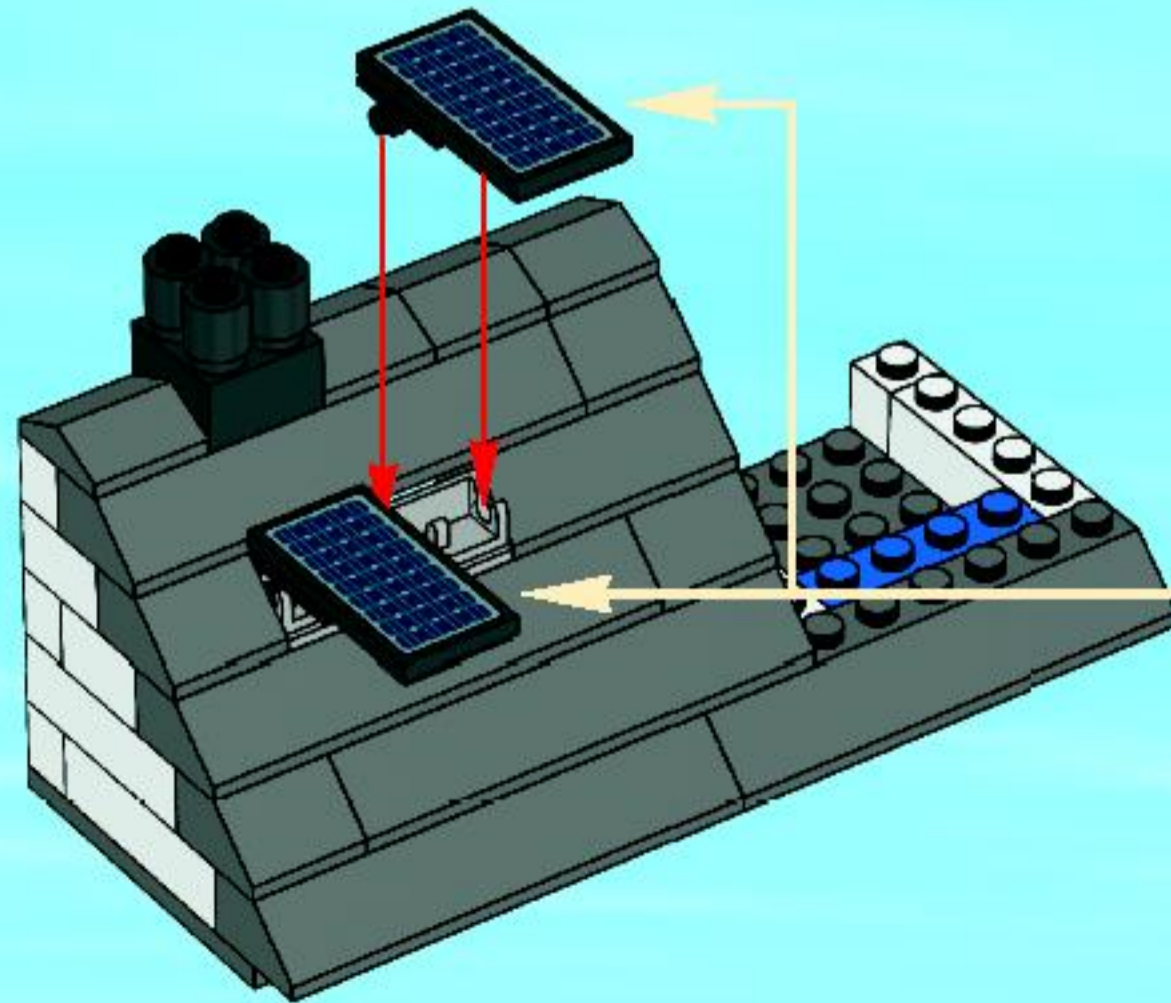

19

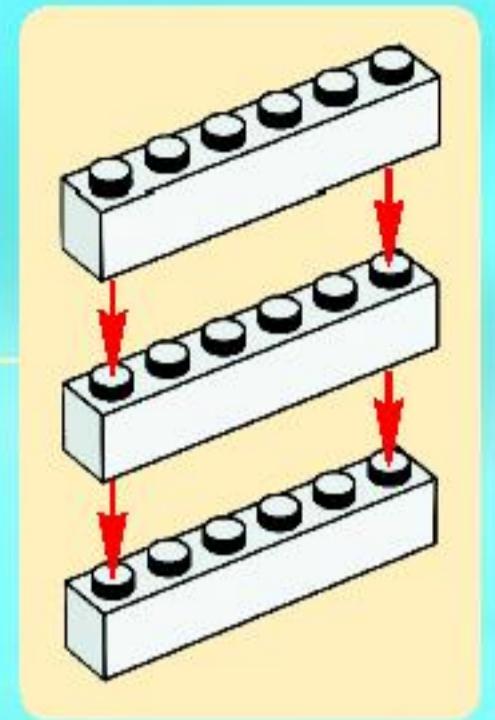
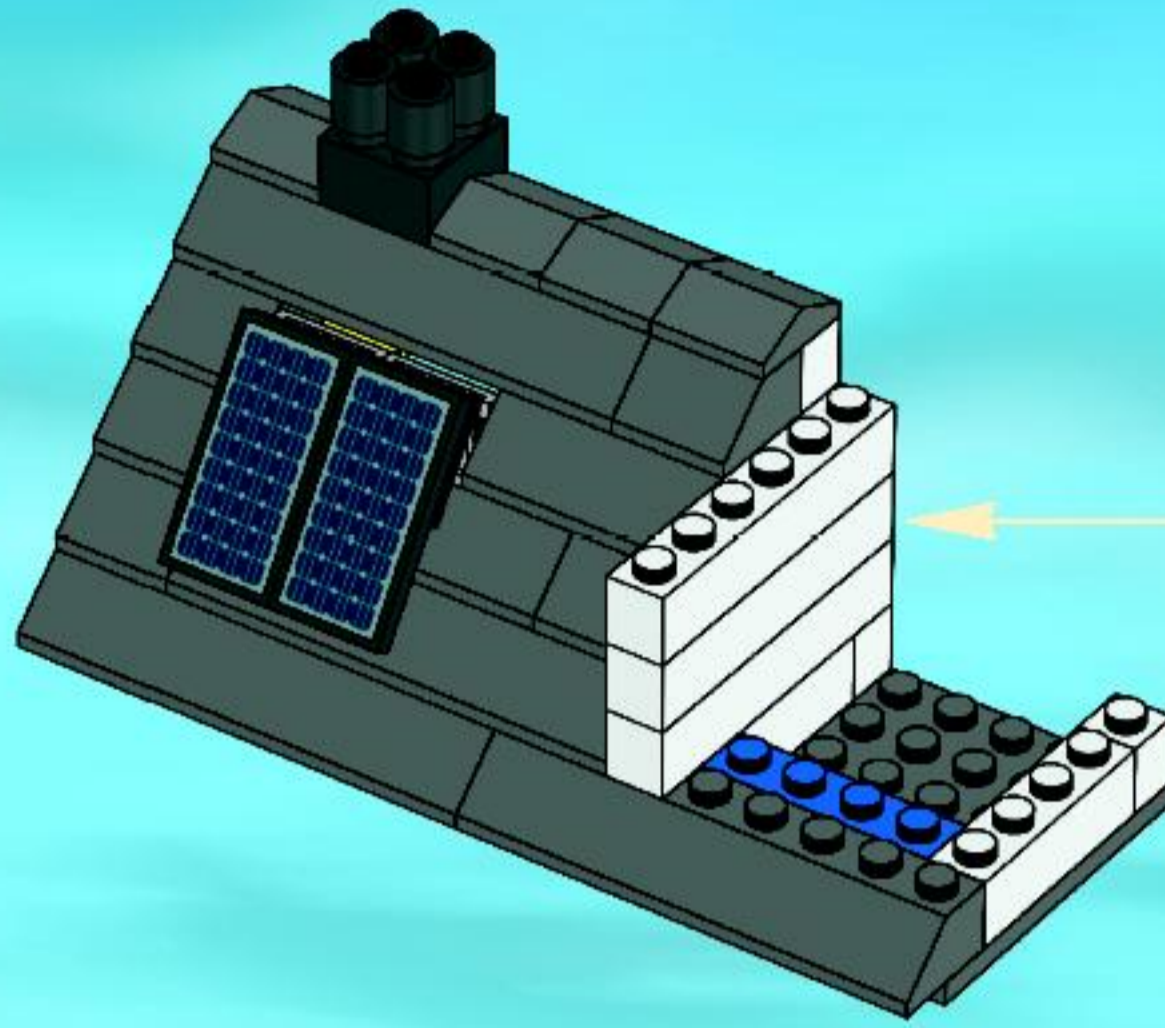

20

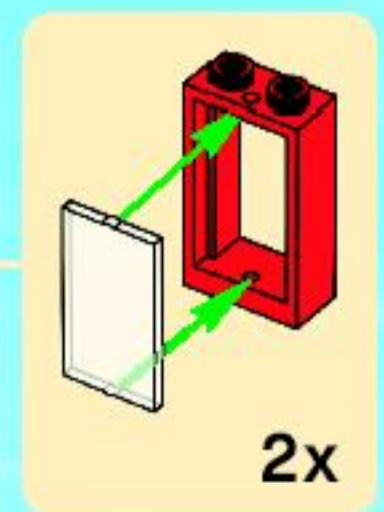
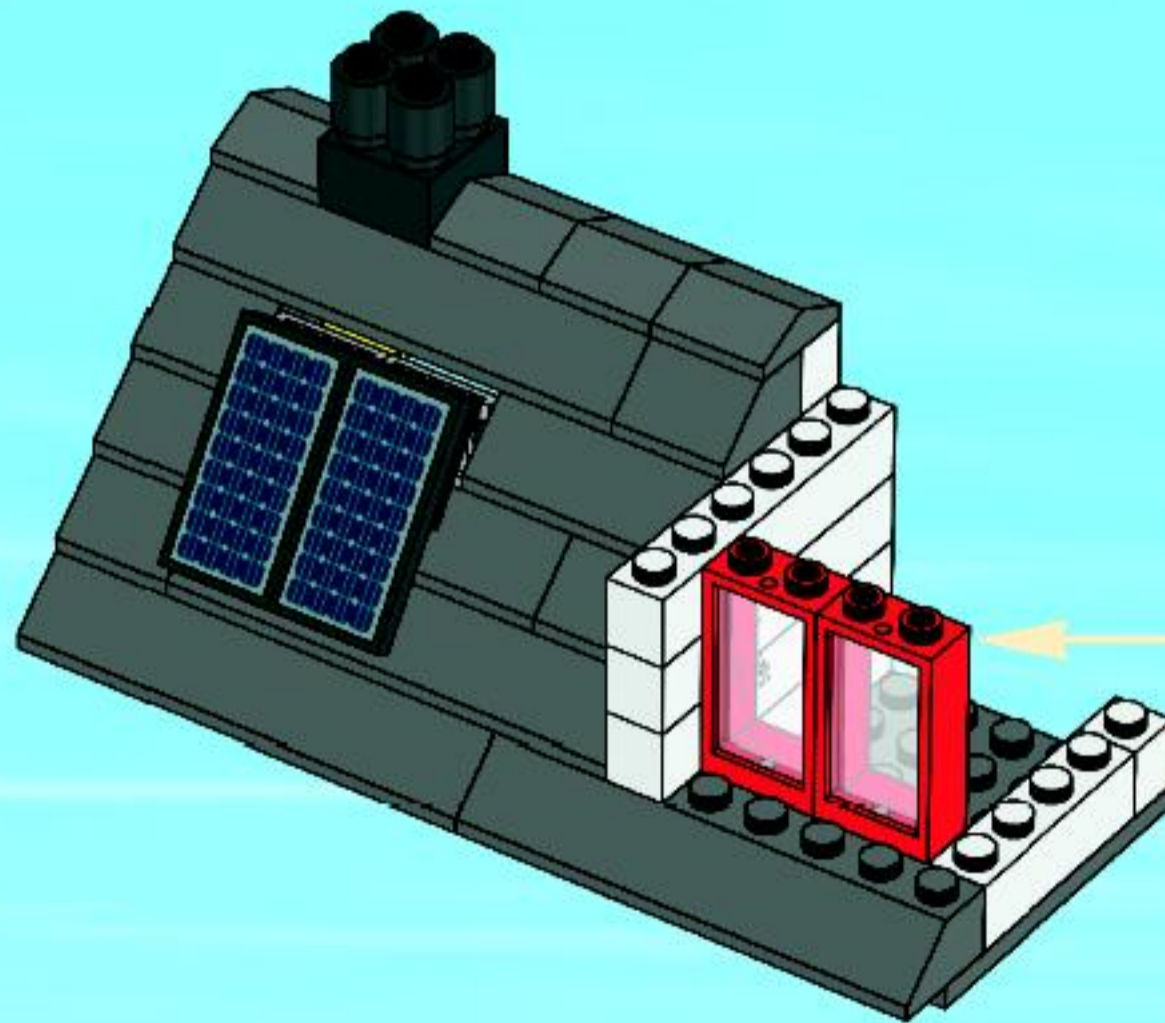

21

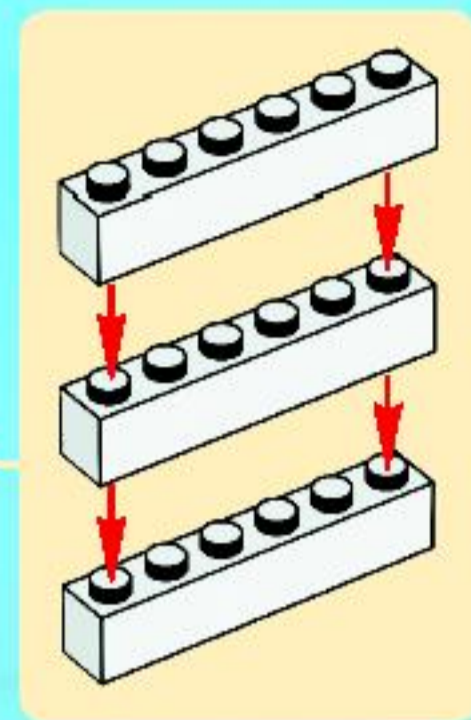
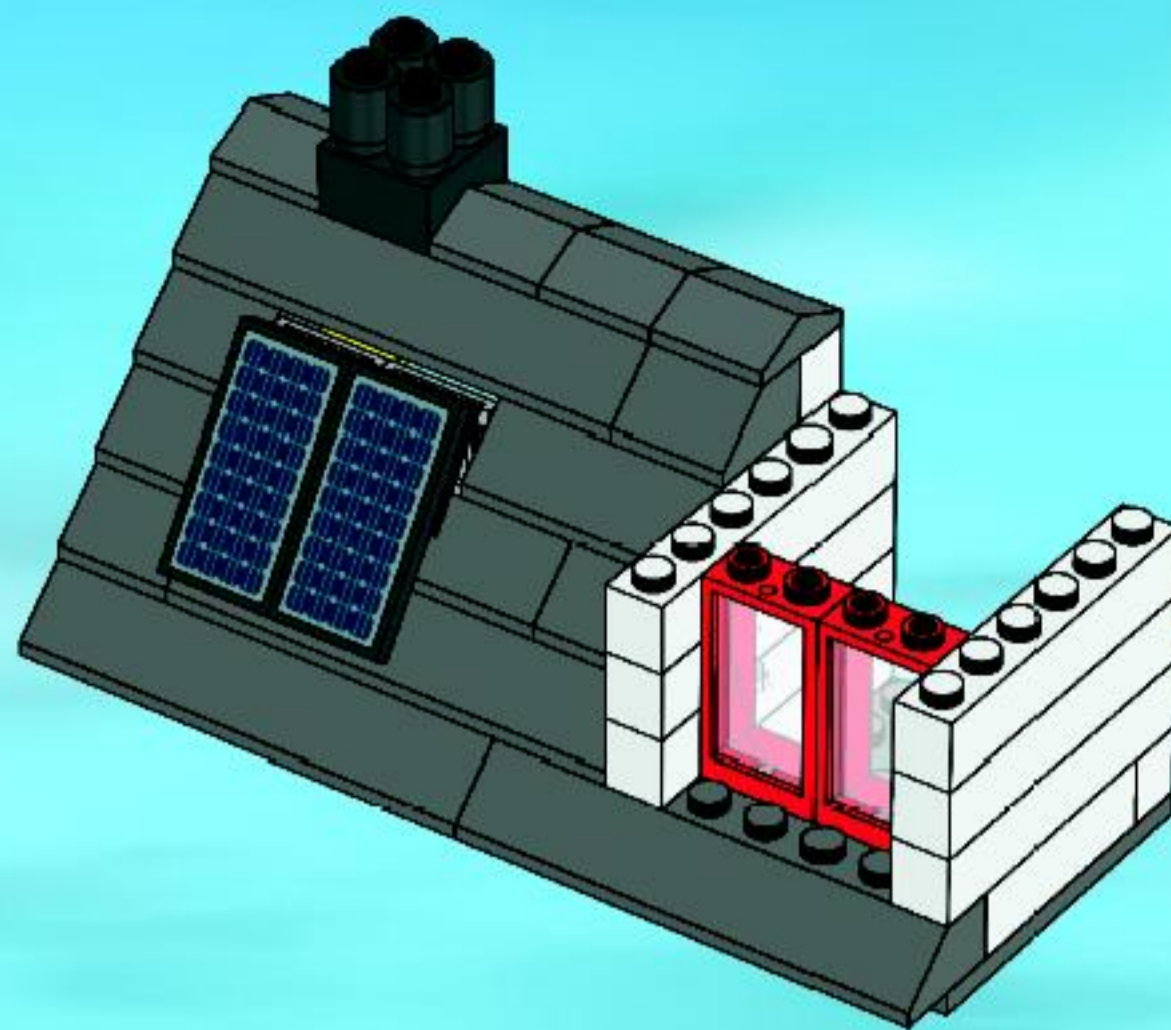

22

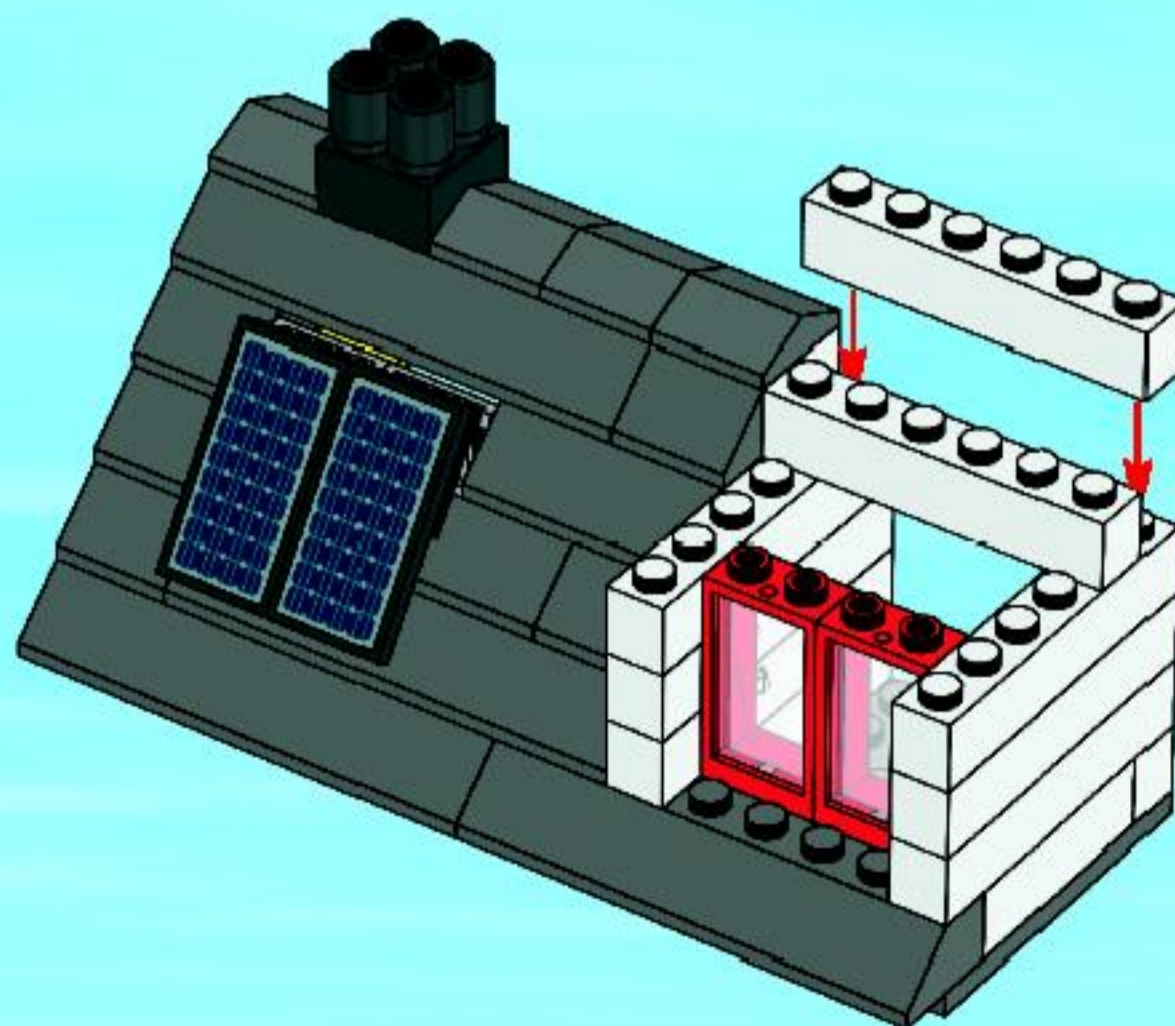

23

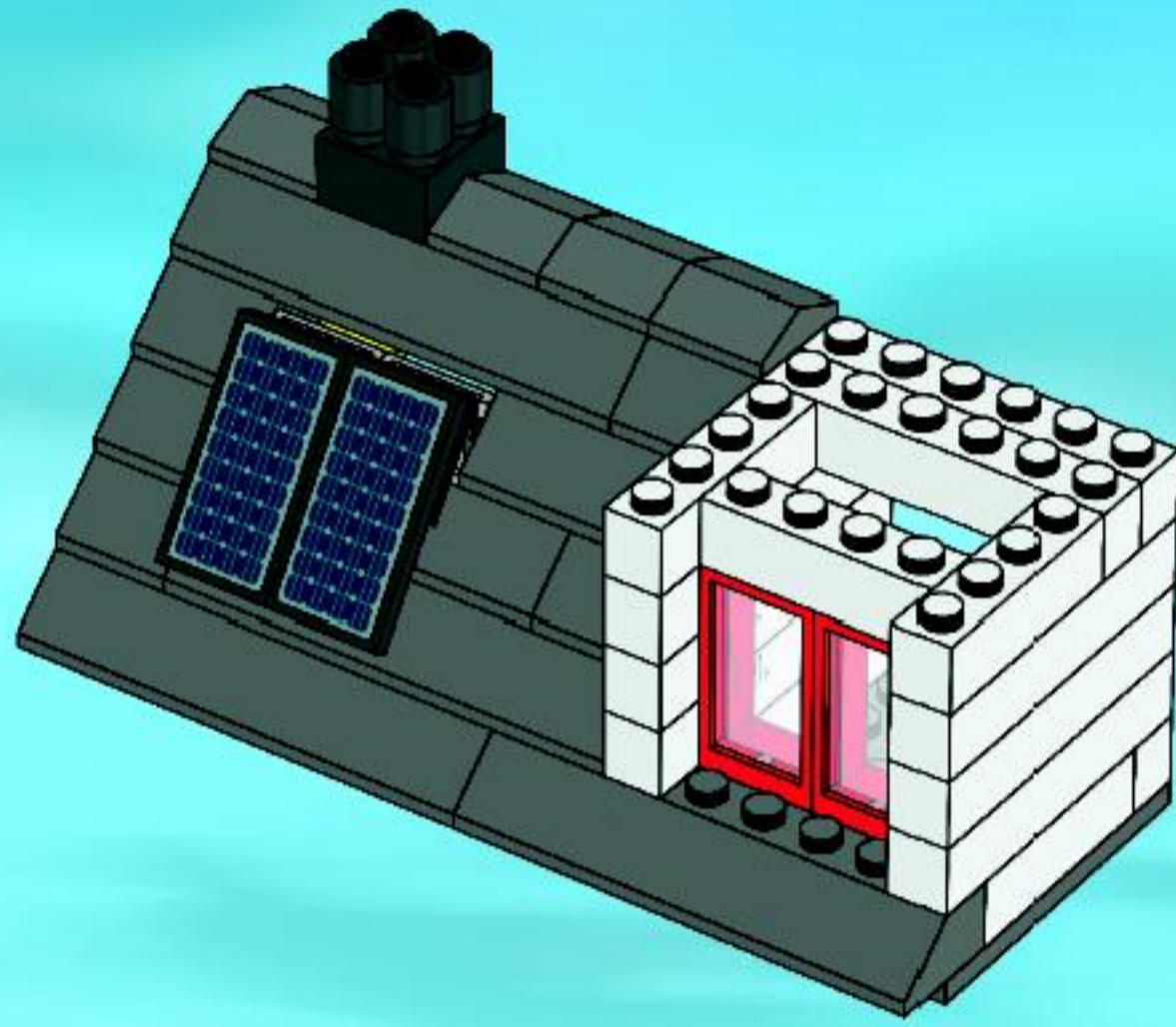

24

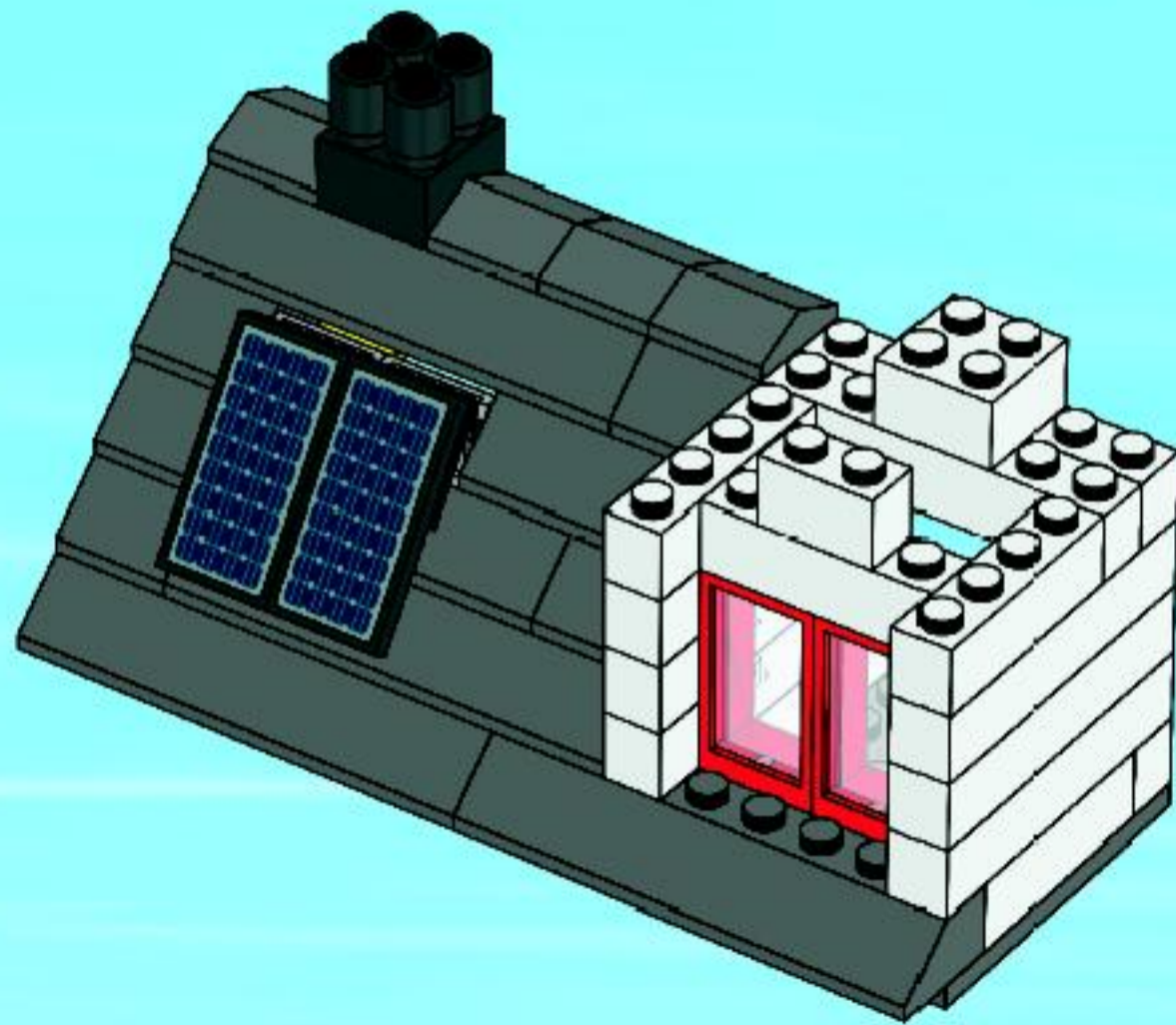

25

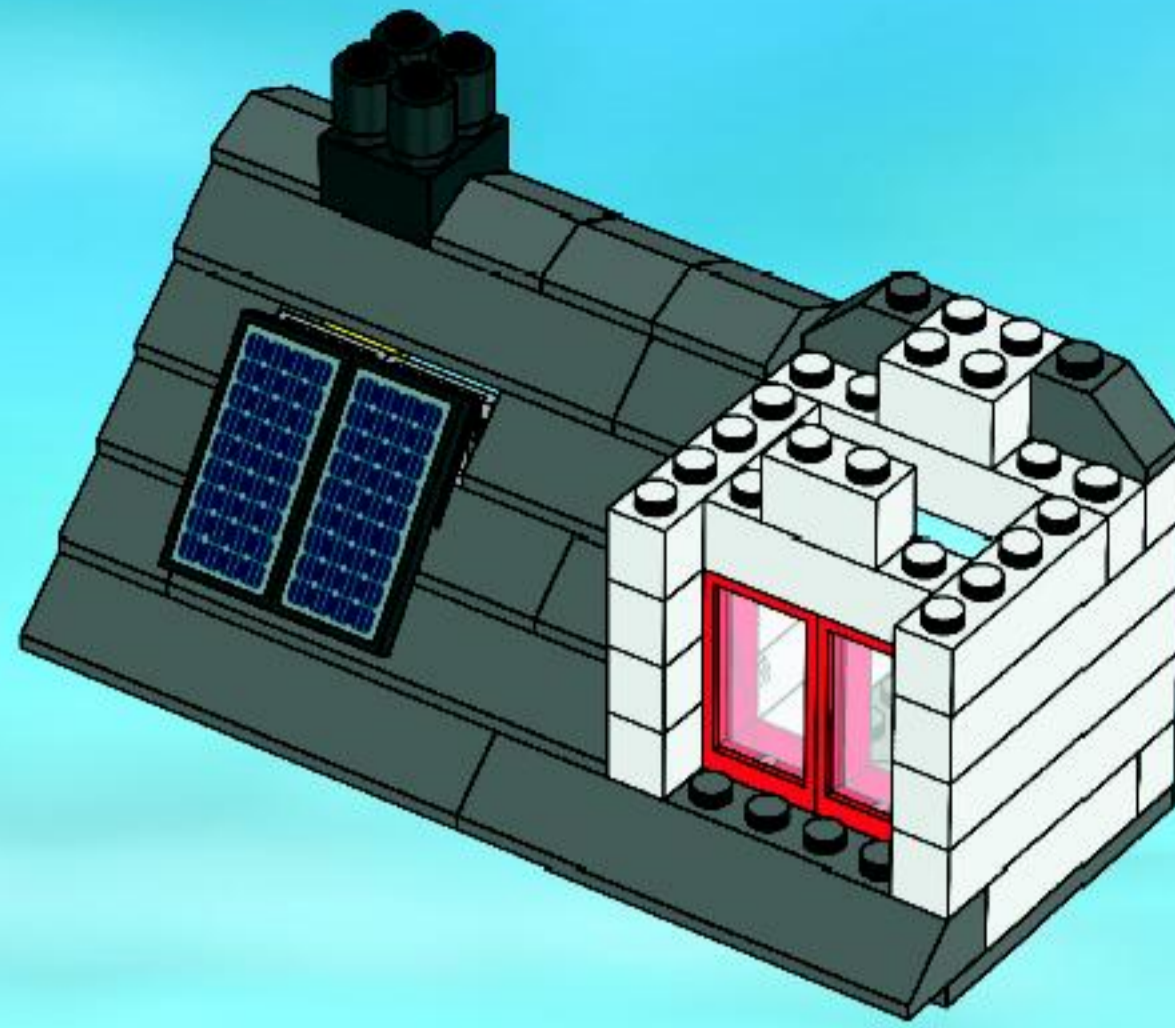

26

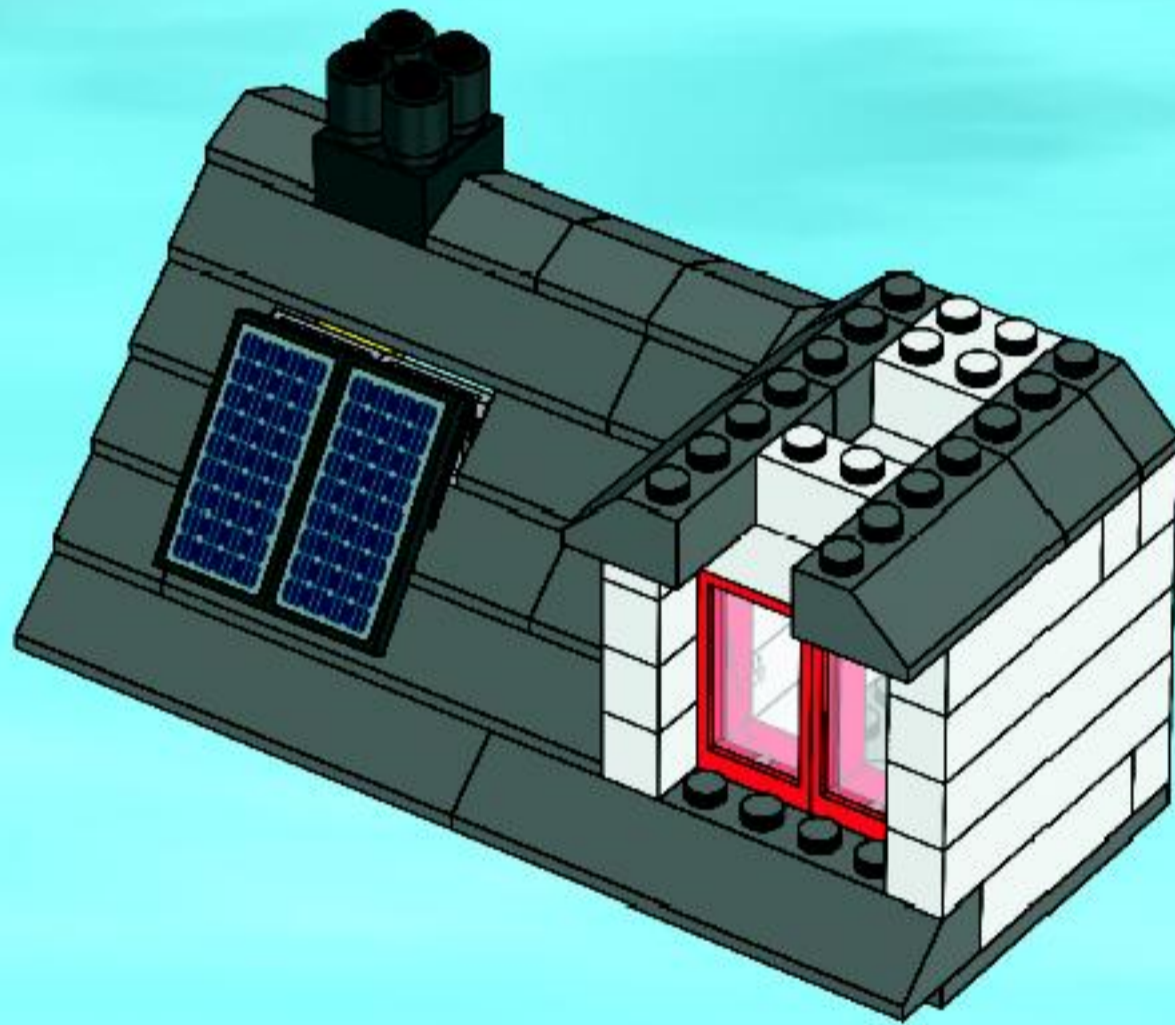

27

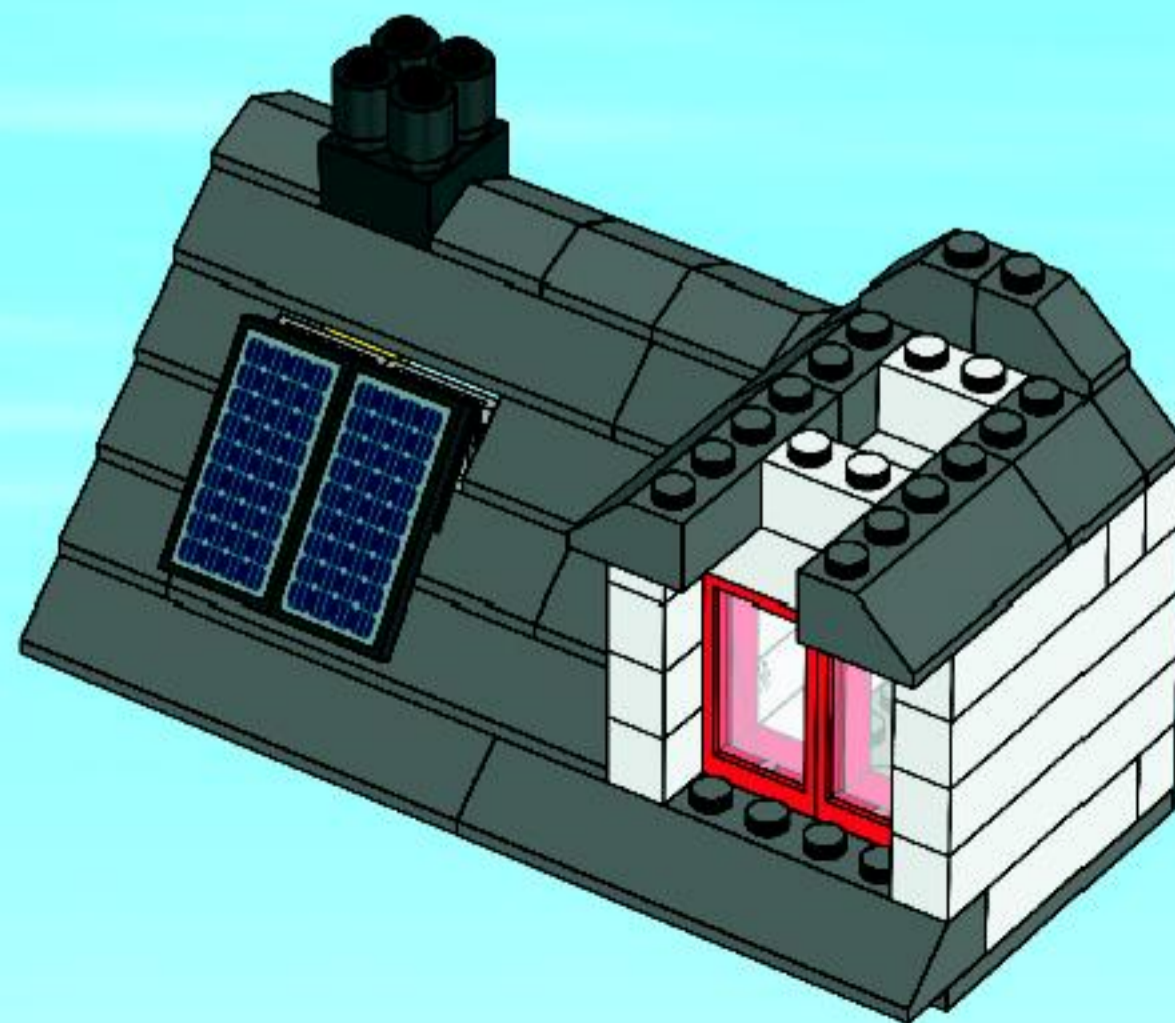

28

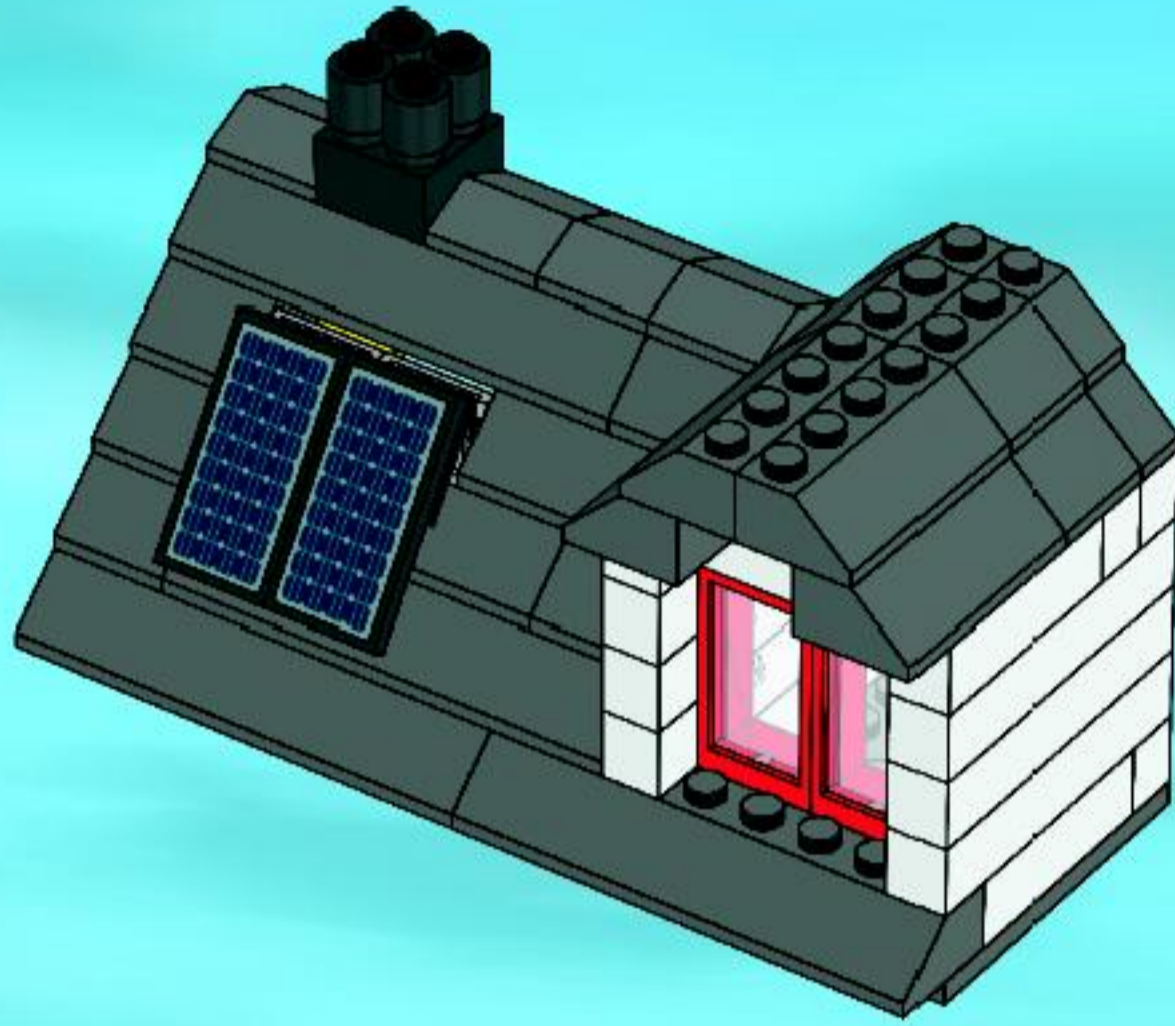

29

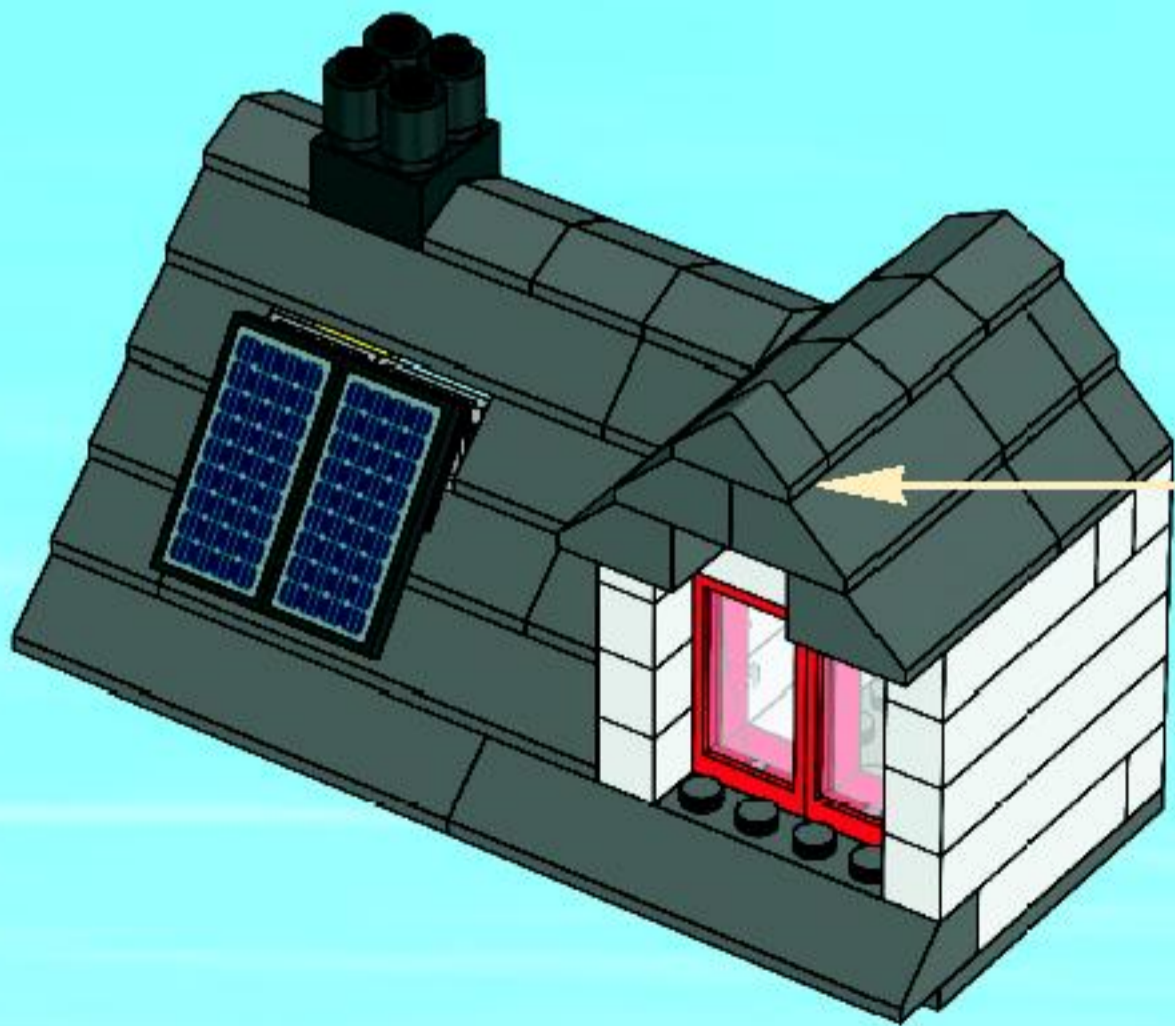

30





CITY

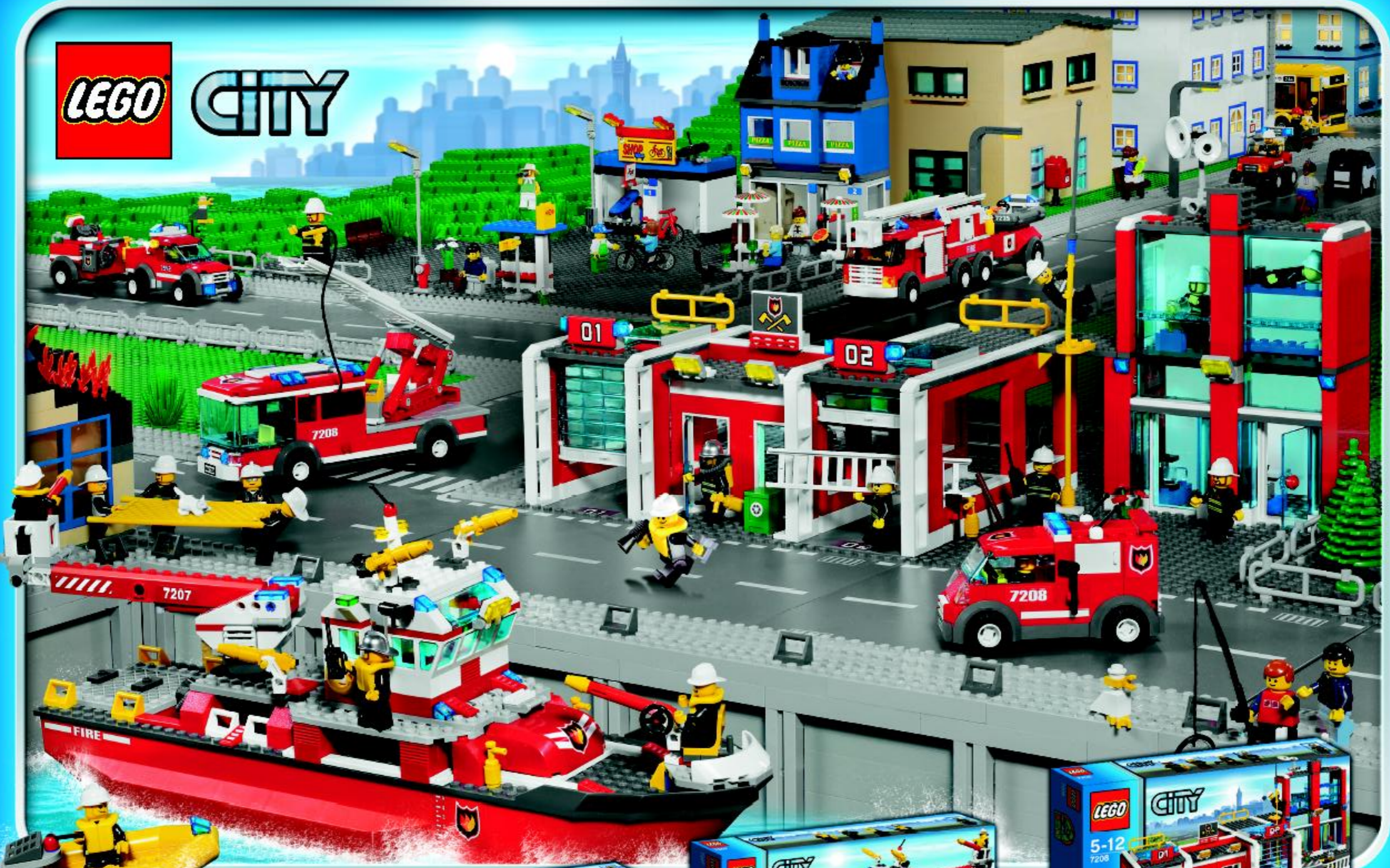

7241



7942



7239



7207



7208



CITY



3177



3178



3179



3180



3181



3182

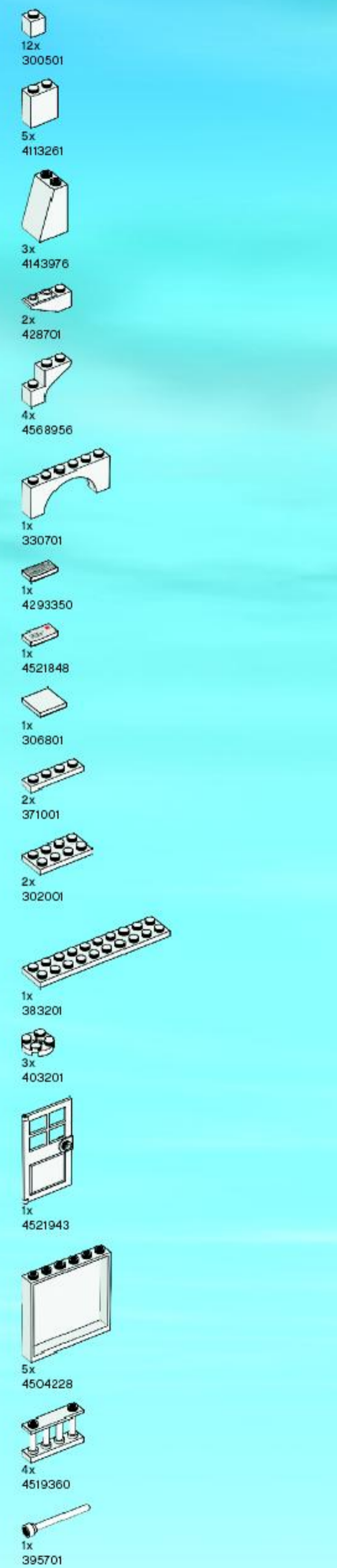
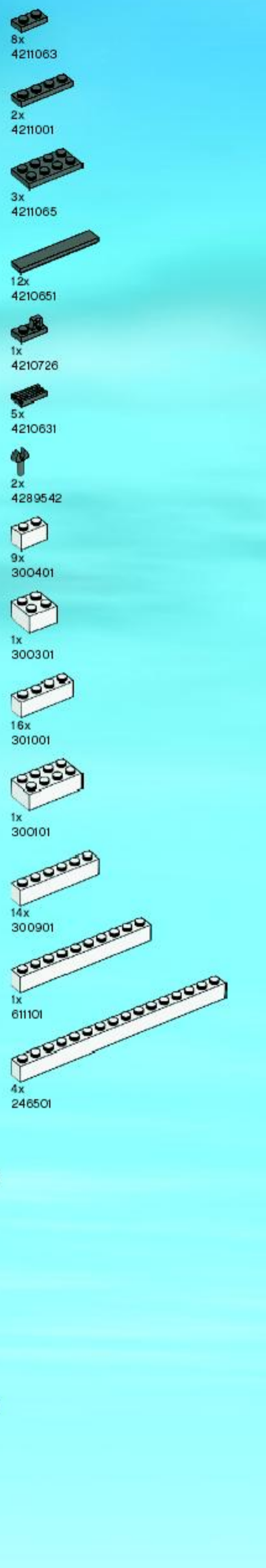
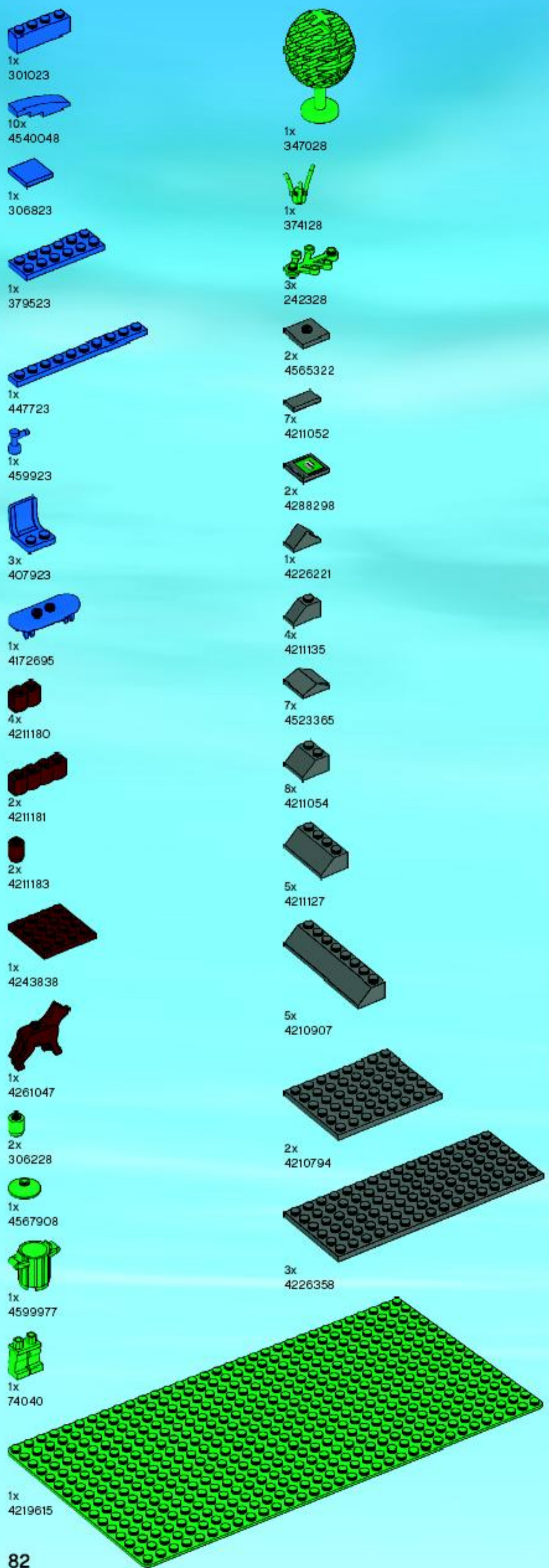

1x 9327
 1x 4570026
 1x 4549988
 5x 4114306
 4x 4113917
 1x 4113993
 1x 4558886
 1x 306221
 1x 302421
 2x 306821
 2x 4515365
 1x 4530734
 1x 614121
 4x 4536340
 3x 4503169
 1x 4550015
 1x 4521851
 1x 4261628

5x 4106915
 1x 4275870
 1x 4520952
 1x 449521
 1x 4557157
 2x 4169960
 1x 4261572
 1x 4570664
 1x 4584727
 2x 389924
 2x 300426
 1x 300326
 1x 300926
 4x 306226
 2x 4251161
 1x 4200031
 4x 307026
 2x 243126
 2x 4560182
 4x 663626
 1x 379526

1x 4193693
 2x 4106347
 2x 486526
 7x 4187209
 1x 4538456
 1x 4526110
 1x 4526756
 1x 452826
 2x 249626
 1x 4525236
 3x 4124096
 2x 4535928
 1x 4529755
 3x 4518606
 16x 4211389
 8x 4211388
 3x 4211387
 4x 4211393
 1x 4211356
 8x 4560183

1x 4211451
 2x 4211804
 2x 4222019
 2x 4211525
 1x 4265746
 2x 4211769
 1x 4520155
 1x 4211679
 3x 4211469
 1x 4211759
 4x 4536998
 3x 4508261
 2x 3000240
 1x 4194746
 2x 3005744
 4x 4222960



Customer Service
 Kundenservice
 Service Consommateurs
 Servicio Al Consumidor
www.lego.com/service or dial
 : 00800 5346 5555
 : 1-800-422-5346





WIN!

Go to www.nielsen.com/LEGO to fill out a survey for a chance to win a cool LEGO® Product. No purchase necessary. Open to all residents where not prohibited.

 www.LEGO.com



www.nielsen.com/LEGO

GEWINNE!

Nimm an der Umfrage auf www.nielsen.com/LEGO teil und hab die Chance ein cooles LEGO® Produkt zu gewinnen!

Die Teilnahme am Gewinnspiel führt zu keinerlei Kaufverpflichtungen. Teilnahme in allen nicht ausgeschlossenen Ländern möglich.

WIN!

Ga naar www.nielsen.com/LEGO, vul een enquêteformulier in en maak kans op een cool LEGO® product.

Geen aankoopverplichting, iedereen mag deelnemen, uitgezonderd ingezetenden van landen waar een enquêteverbod geldt.

GAGNE!

Visite www.nielsen.com/LEGO pour répondre à un questionnaire et avoir une chance de gagner un produit LEGO® très cool!

Aucune obligation d'achat. Ouvert à tous les résidents des pays autorisés.

当てよう!

www.nielsen.com/LEGOにアクセスして、アンケートにご記入ください。当選者にはレゴ製品を差し上げます。

お買い上げの必要はありません。購止されていない限り、すべての年齢にご利用いただけます。