

BIONICLE[®]

MAZEKA

www.BIONICLE.com

8954

LEGO



1

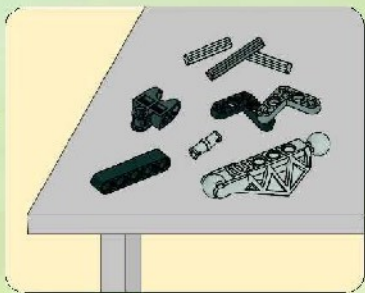

2



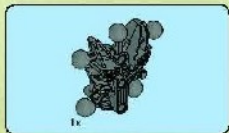
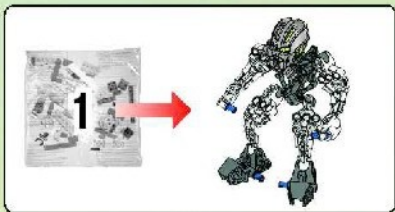
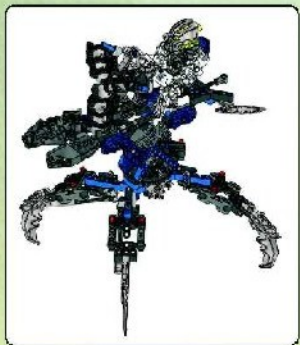

1

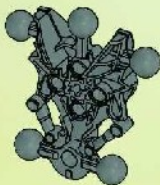



2

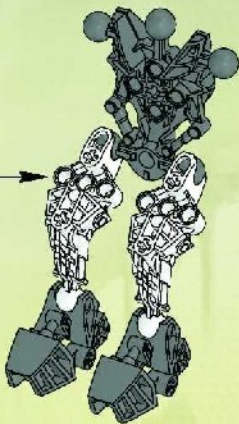
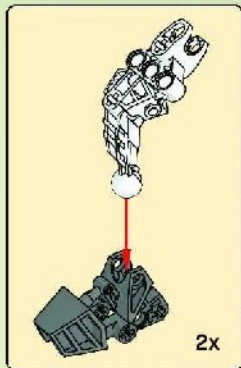



3

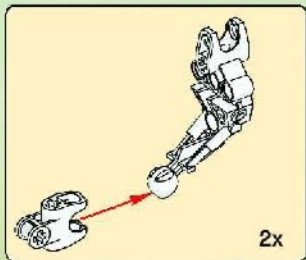

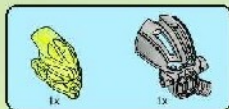

4

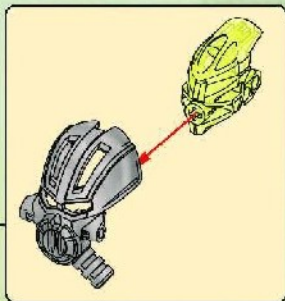
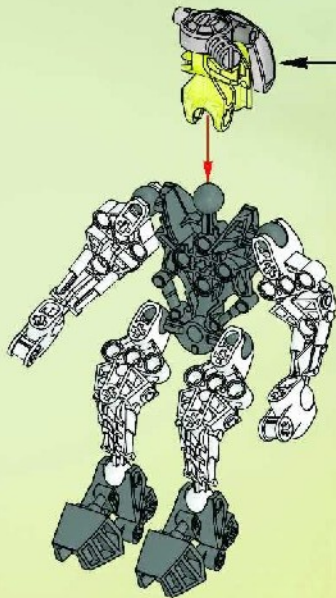

4x 

5

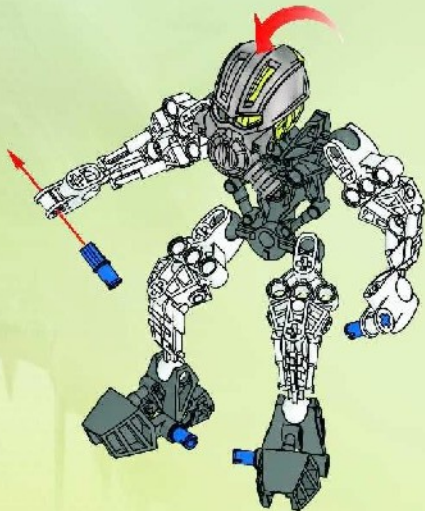

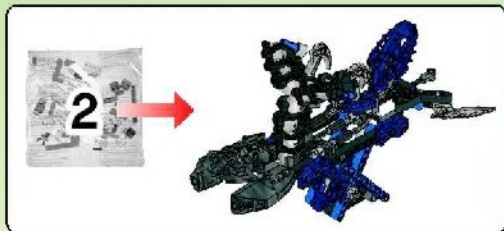

1



2





2x

3



2x

4

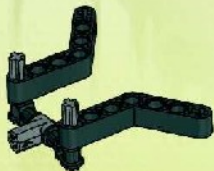

2x

5

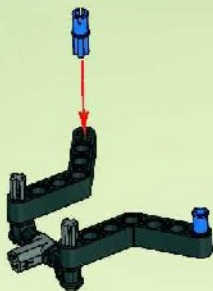

4x

6

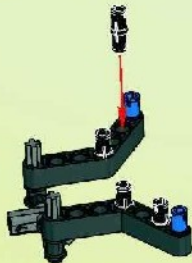

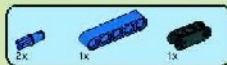

7

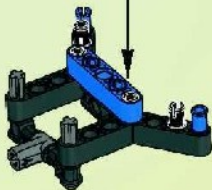
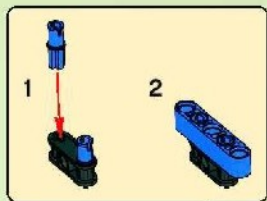

8

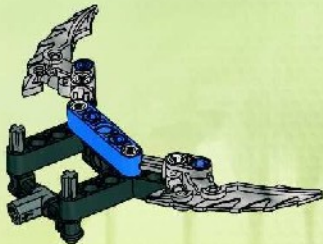



9

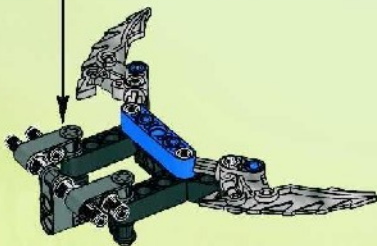
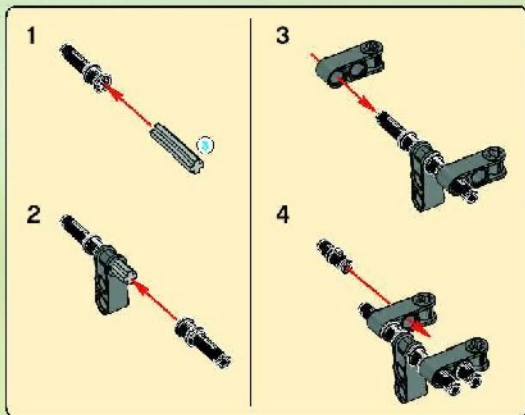



10

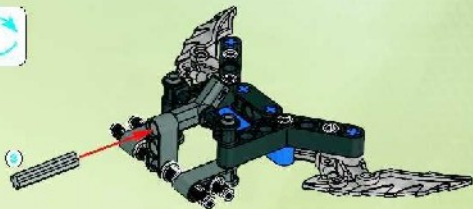

11

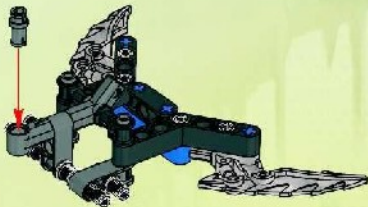



12

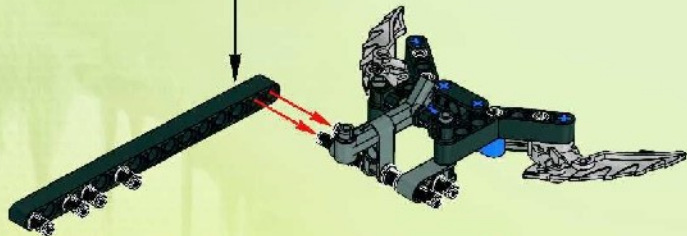
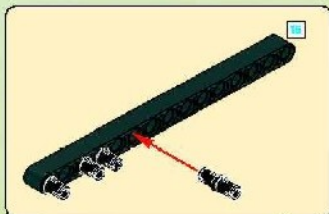



2x

13

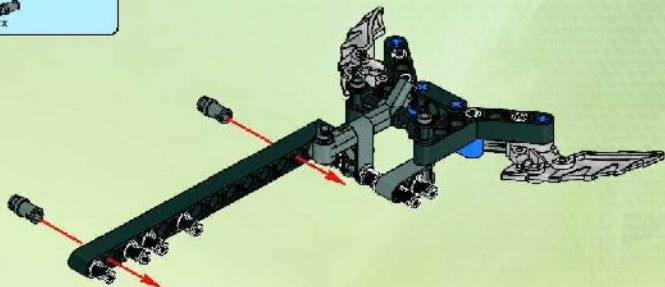

1x

14



7

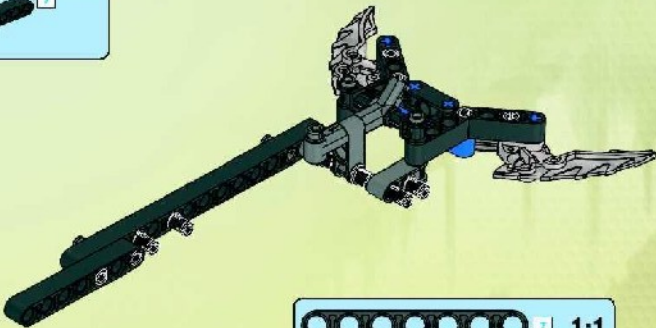

1:1



1x

1



2x

2x



1:1

2

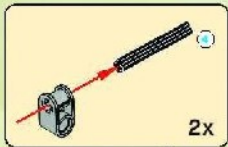

2x

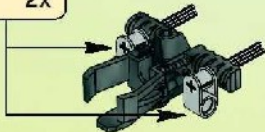



3

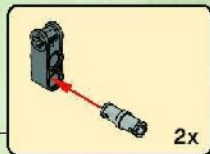
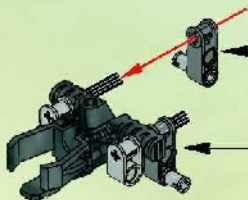

4

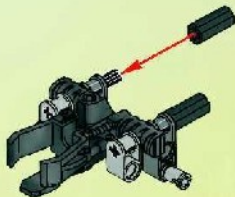

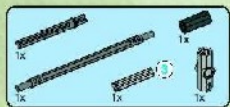

5

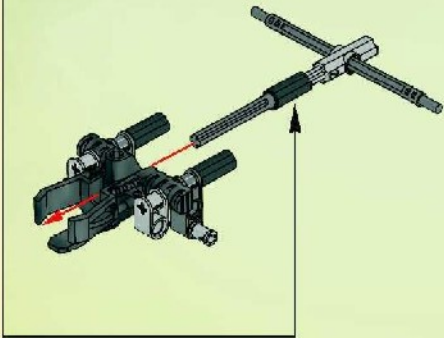
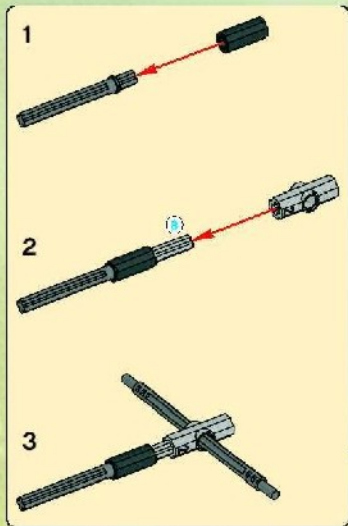

6

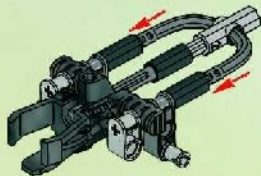

15

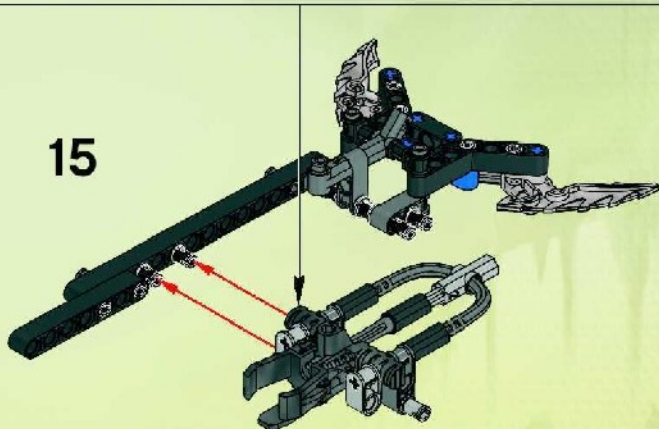

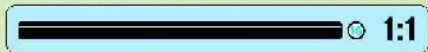

16

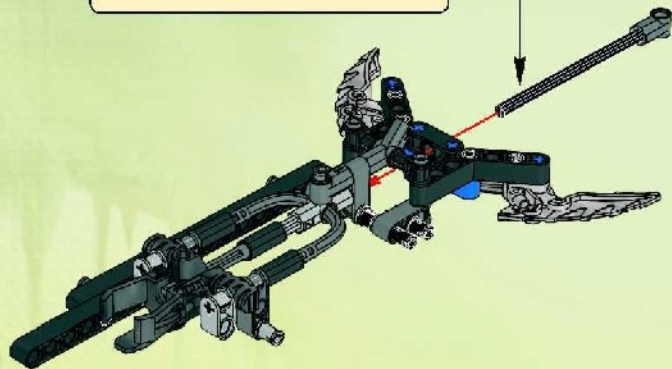
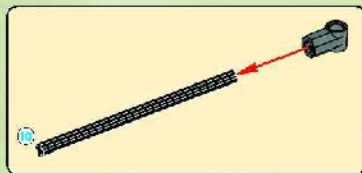



1

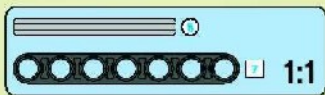
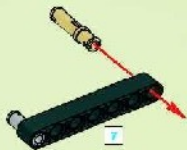

2

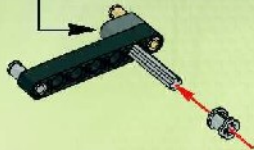

3



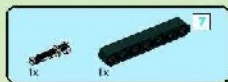
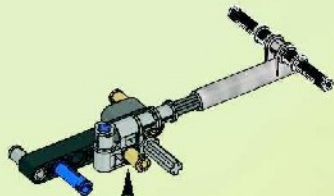

5

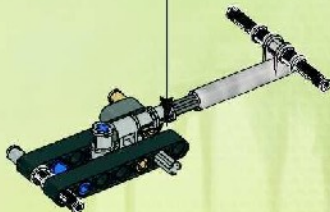
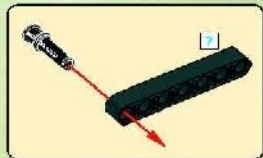



6

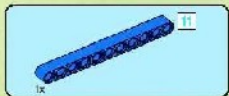
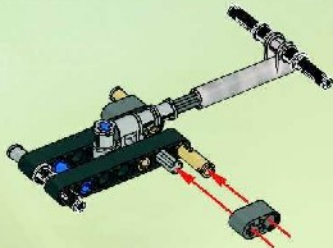

7

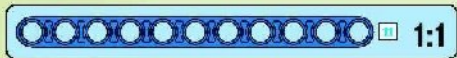



8

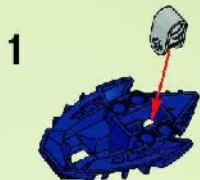

3

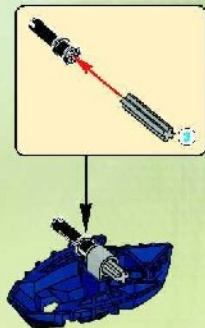

4



5

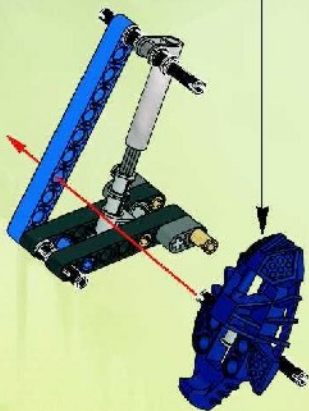

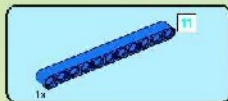

9



10

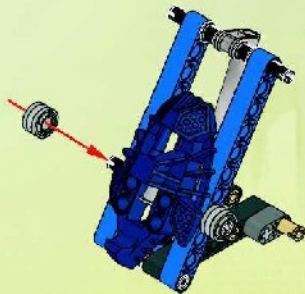

11

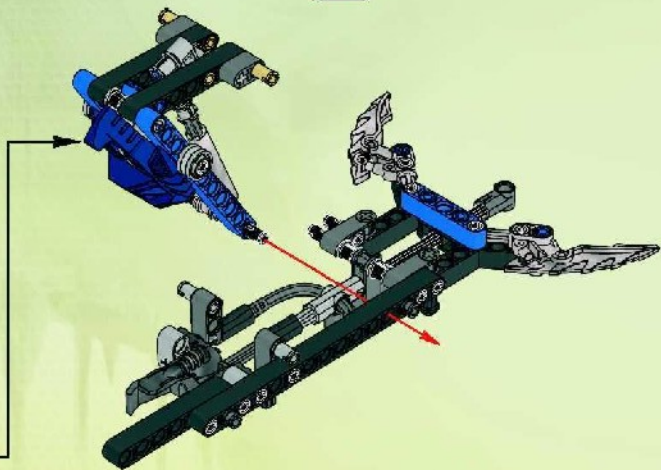

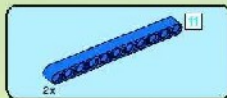

12

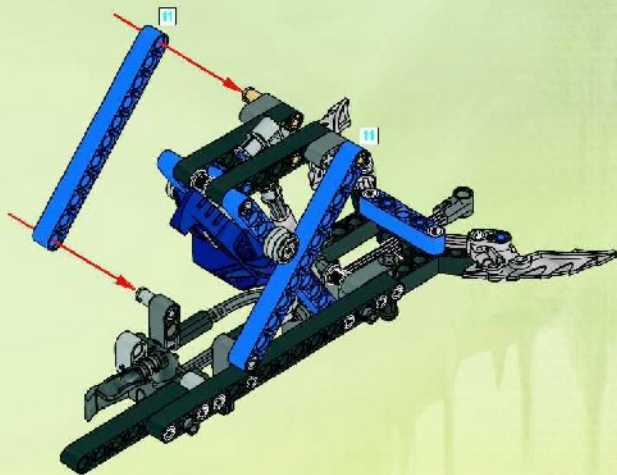

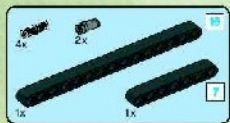

13

1



2



3

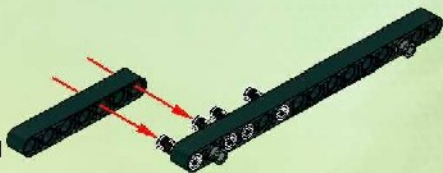



14

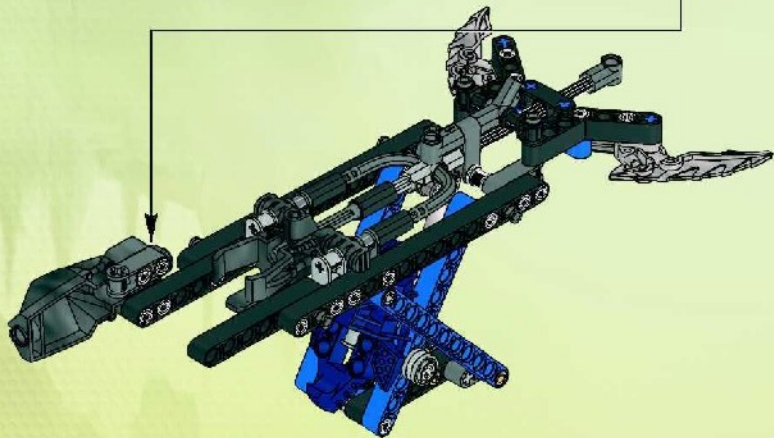
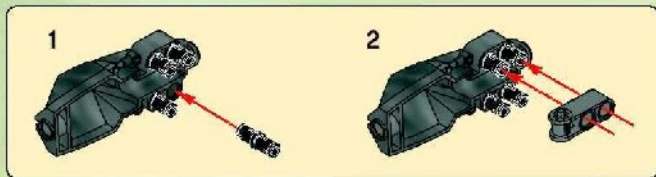



15

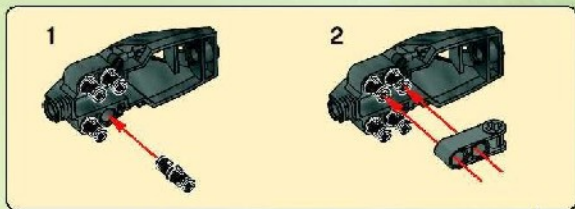

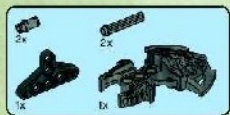

16

1



2



3



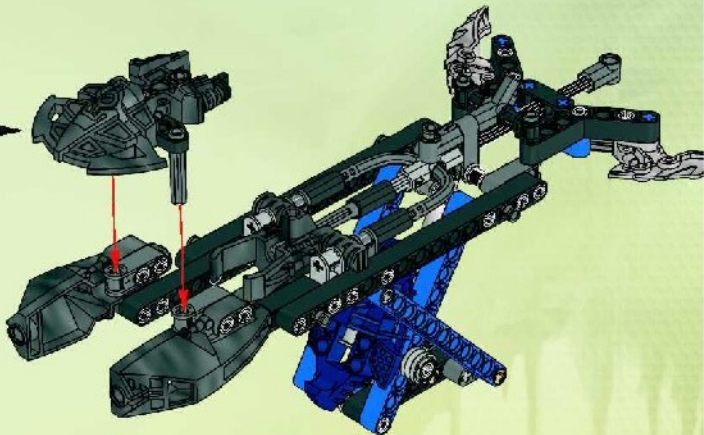

4x

17



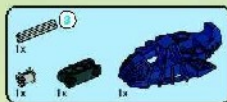

18

1



2

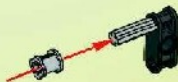

3



4

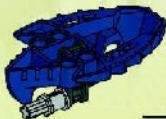

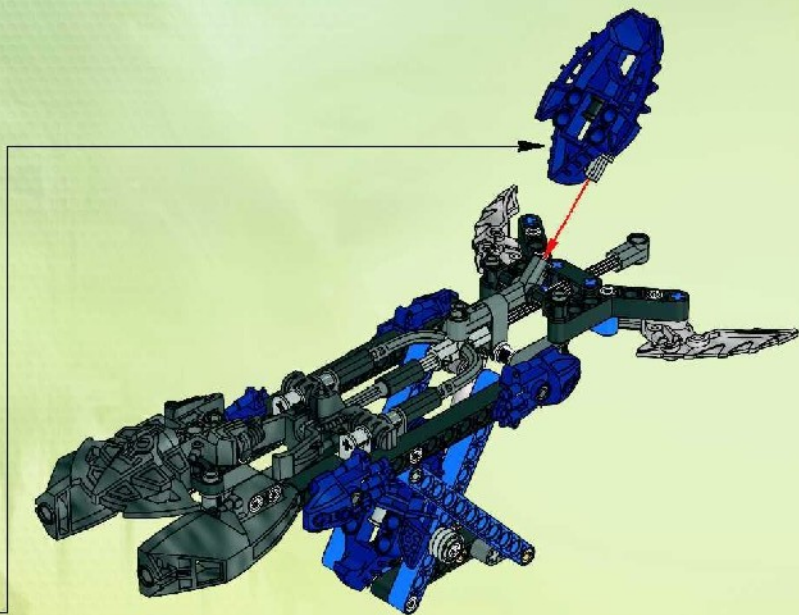

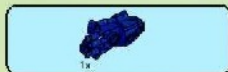

19

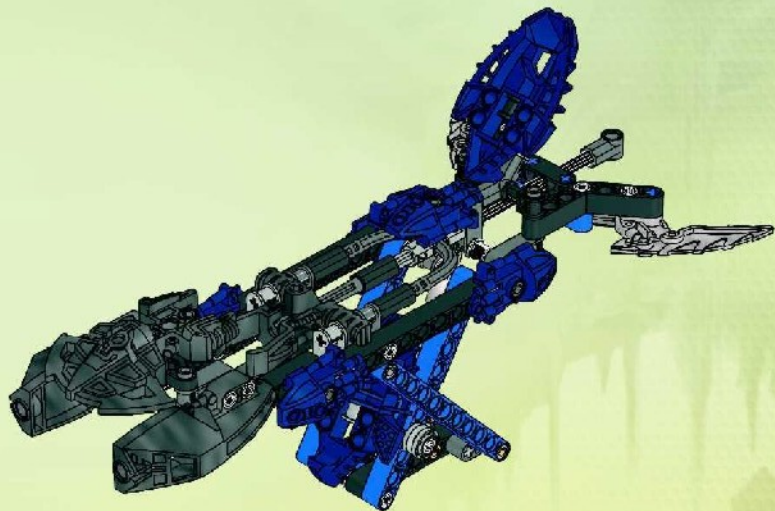

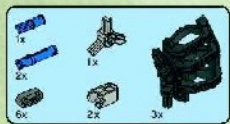

20

1

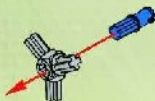

2



3

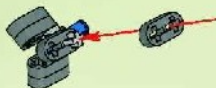

4

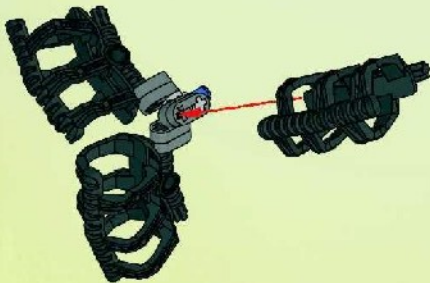

5

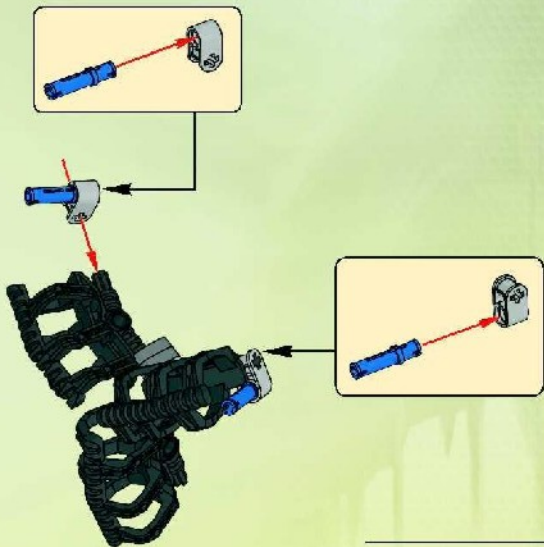

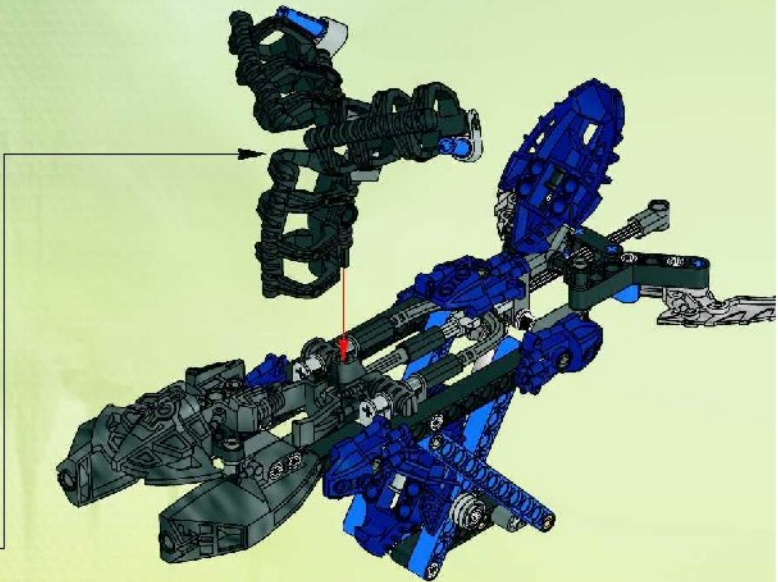



21

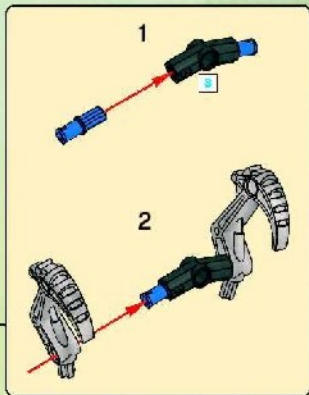
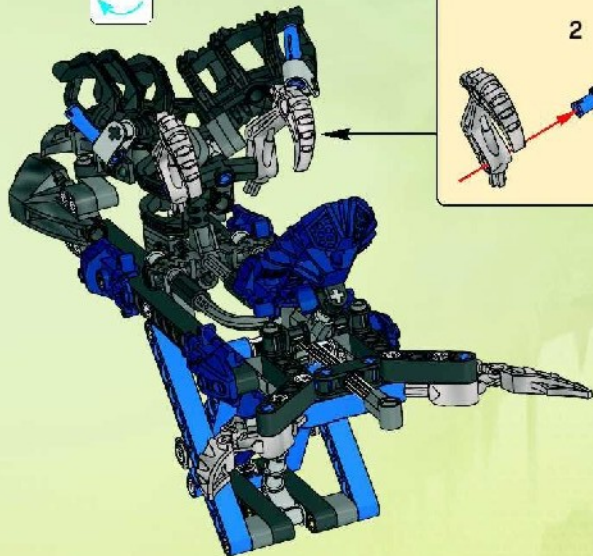



22

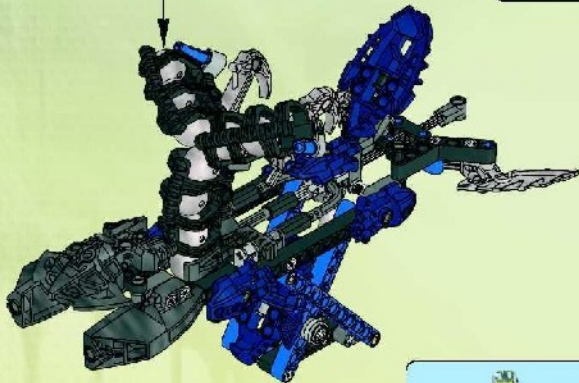

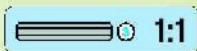
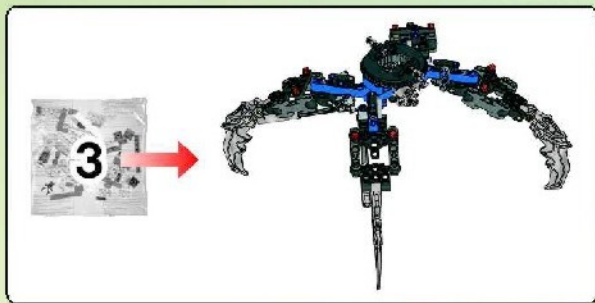

1





2

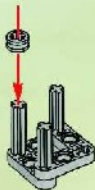

3



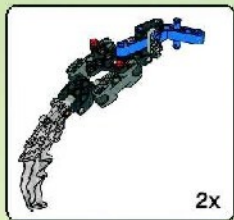

1

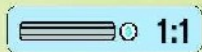
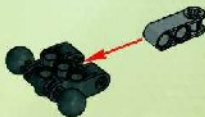

2



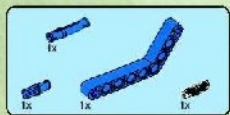

3

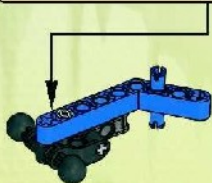
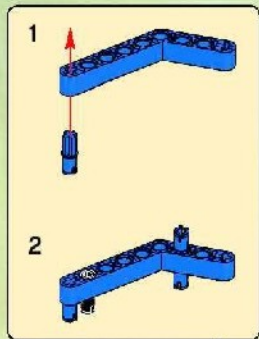

4

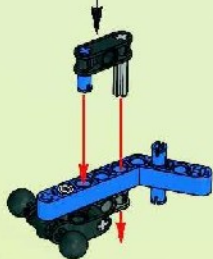



5

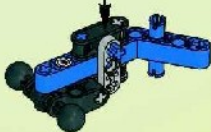
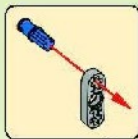

6

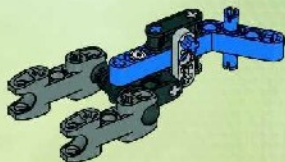

7

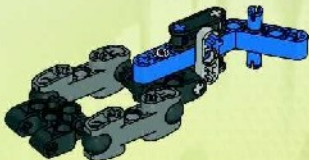



8

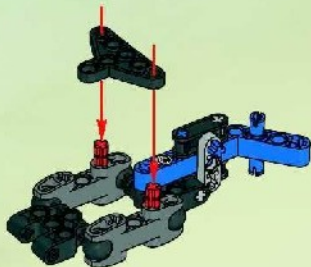

9

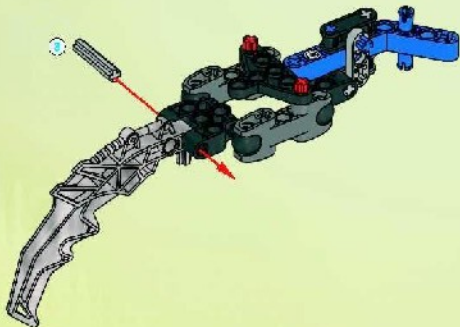

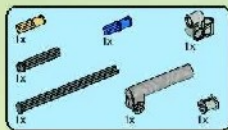

10

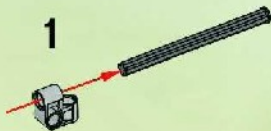

2

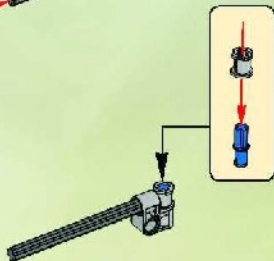

3

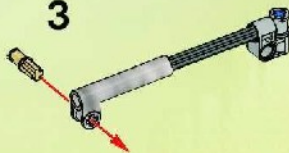

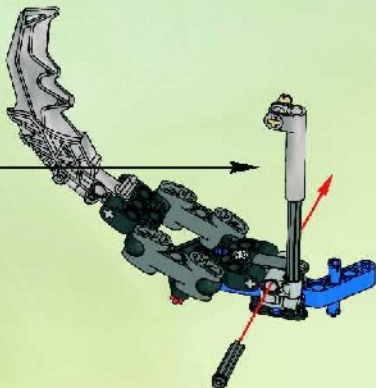

11

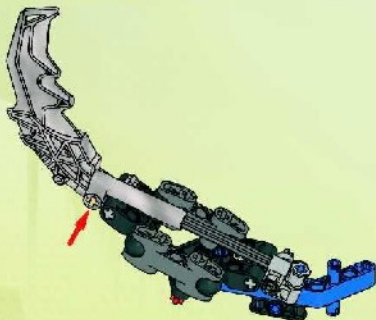

2x

12

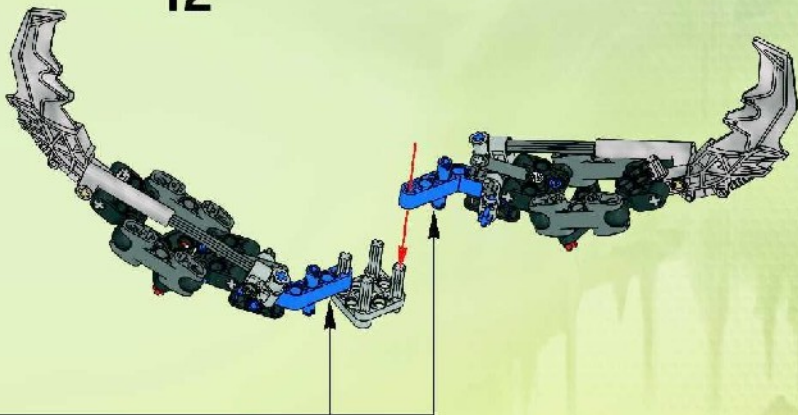

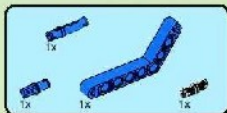
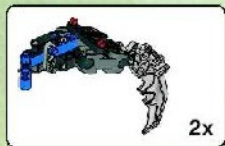

3

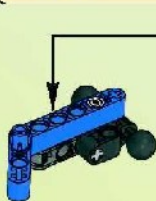
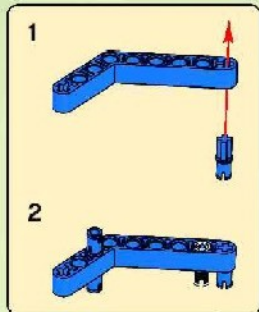



4

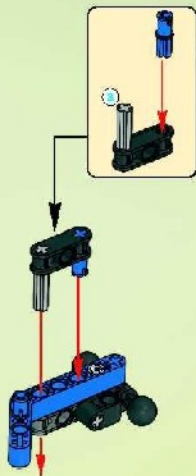

5

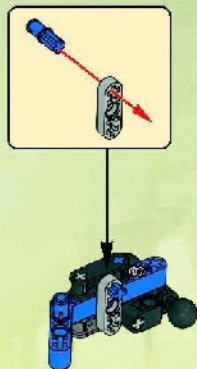



2x

6

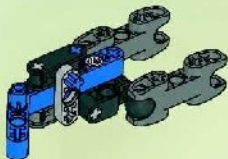

7x

7

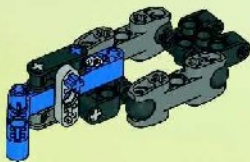



8

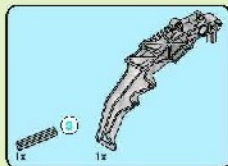
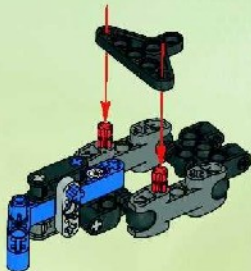

9

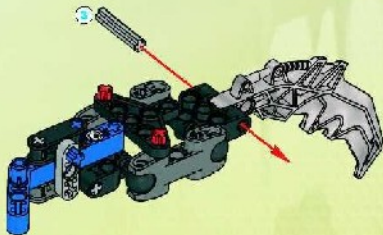

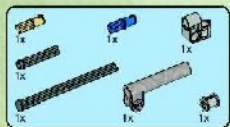

10

1

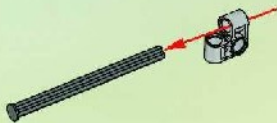

2

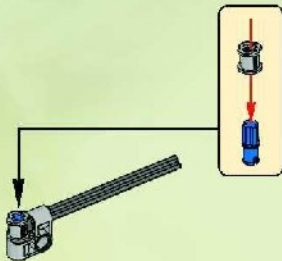

3

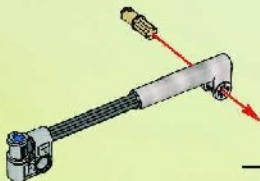

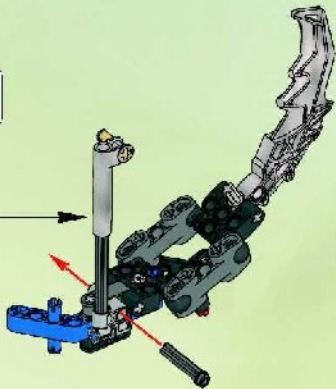

11



2x

12

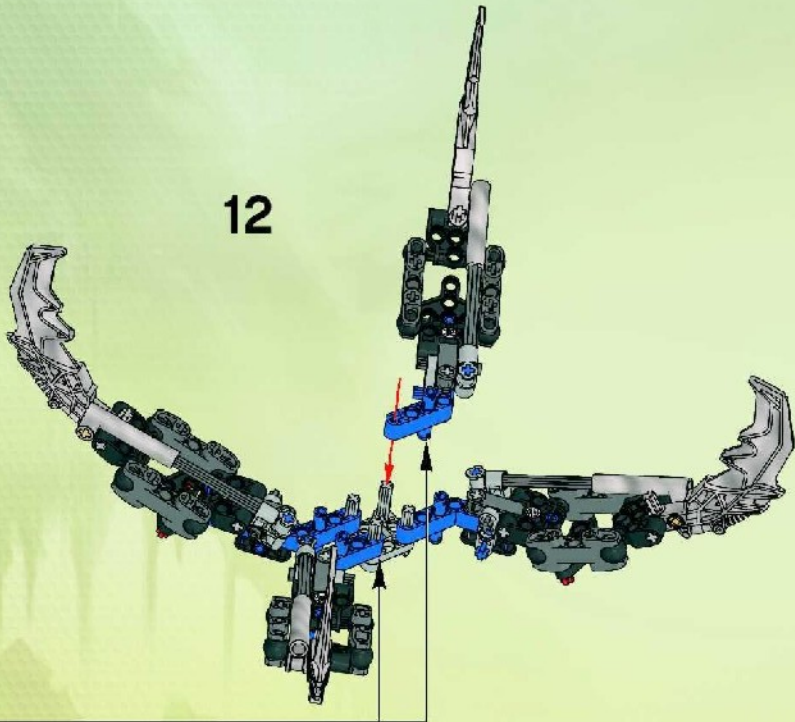



2x

13





2x

14





15



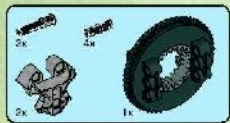

16

1

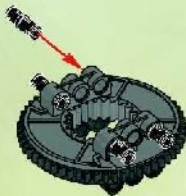

2

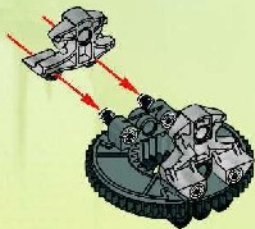

3



4







17



18

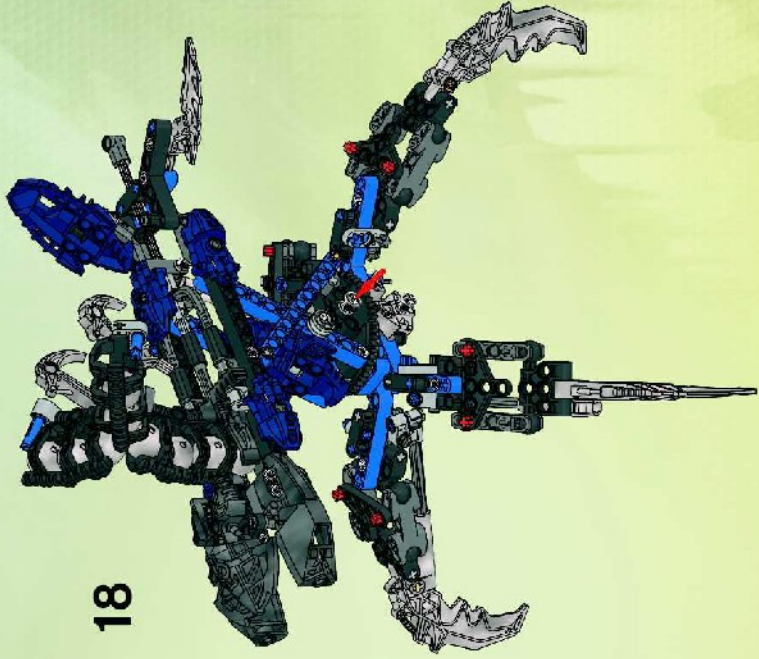

19





2x
4147224



0x
4440115



0x
4424480



1x
4114517



2x
72036



2x
4444711



4x
444740



4x
456405



2x
4542617



0x
4141910



28x
4304482



1x
4544550



4x
1634908



4x
4543315



1x
4142154



4x
403104



1x
494424



4x
4186017



11x
4140821



1x
4107011



2x
4289017



2x
410701



30x
4121715



1x
373720



2x
3735117



0x
4562151



0x
4121017



0x
4292481



2x
4128003



4x
4495901



2x
4128596



2x
4142545



1x
4549412



1x
42157



2x
42178



1x
42180



2x
42188



2x
42189



1x
42187



1x
42200



1x
42186



1x
42185



2x
42180



2x
42185



1x
42180



2x
42172



1x
42180



2x
42175



4x
42150



2x
42154



1x
42140



1x
42150



1x
42130



1x
42150



1x
42158



2x
42159



1x
45122



2x
45182



1x
42102



1x
42150



1x
44412



1x
42141



1x
45141



2x
45150



Customer Service

Kundenservice

Service Clientèle

Servicio Al Consumidor

www.lego.com/service or dial



00 800 33 46 35 35 :

1-800-422-5348 :



8598
Takanuva



8599
Vultrez

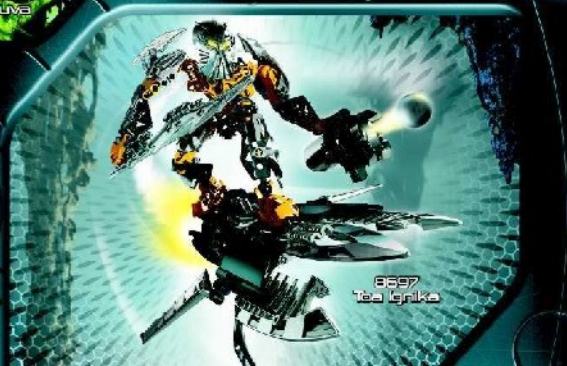

8597
Teo Ignika





69-19
Axalara T9



6942
Jetax T6



6941
Radkah T3



www.BIONICLE.com



www
BIONICLE
STORY
com



LEGO

club

FREE LEGO Magazine • GRATUIT • GRATIS LEGO Magazin



Join Today!

Abonne-toi dès aujourd'hui!

Meld je nu aan!

Jetzt anmelden!



US & Canada only

1-866-534-6258

1-877-518-5346

MEXICO



00800 5346 5555

VISIT THE
WORLD'S BIGGEST
LEGO® SHOP!

www.LEGOshop.com

www.LEGOclub.com



LES JOURNALISTES DE LA PRESSE ET LES PHOTOGRAPHEURS SONT INVITES À SE RENDRE EN VOYAGE D'AFFAIRES À LEJØS, EN NORVÈGE, EN OCTOBRE 2010. Les membres du club seront invités à assister à la conférence de presse et à la conférence de presse. Les membres du club seront invités à assister à la conférence de presse et à la conférence de presse.

Mr	<input type="checkbox"/>	Ms	<input type="checkbox"/>	Mr	<input type="checkbox"/>	Ms	<input type="checkbox"/>
Mr	<input type="checkbox"/>	Ms	<input type="checkbox"/>	Mr	<input type="checkbox"/>	Ms	<input type="checkbox"/>
Mr	<input type="checkbox"/>	Ms	<input type="checkbox"/>	Mr	<input type="checkbox"/>	Ms	<input type="checkbox"/>
Mr	<input type="checkbox"/>	Ms	<input type="checkbox"/>	Mr	<input type="checkbox"/>	Ms	<input type="checkbox"/>
Mr	<input type="checkbox"/>	Ms	<input type="checkbox"/>	Mr	<input type="checkbox"/>	Ms	<input type="checkbox"/>
Mr	<input type="checkbox"/>	Ms	<input type="checkbox"/>	Mr	<input type="checkbox"/>	Ms	<input type="checkbox"/>
Mr	<input type="checkbox"/>	Ms	<input type="checkbox"/>	Mr	<input type="checkbox"/>	Ms	<input type="checkbox"/>
Mr	<input type="checkbox"/>	Ms	<input type="checkbox"/>	Mr	<input type="checkbox"/>	Ms	<input type="checkbox"/>

LEGO is a registered trademark of the LEGO Group, Ltd. © 2009 LEGO Group. All rights reserved. LEGO is a registered trademark of the LEGO Group, Ltd. © 2009 LEGO Group. All rights reserved.

LEGO Club is a free magazine for LEGO fans. It is published quarterly. The magazine is available in English, French, German, Italian, Japanese, Korean, Spanish, and Swedish. The magazine is available in print and online. The magazine is available in print and online. The magazine is available in print and online.

LEGO Club is a free magazine for LEGO fans. It is published quarterly. The magazine is available in English, French, German, Italian, Japanese, Korean, Spanish, and Swedish. The magazine is available in print and online. The magazine is available in print and online.

LEGO Club is a free magazine for LEGO fans. It is published quarterly. The magazine is available in English, French, German, Italian, Japanese, Korean, Spanish, and Swedish. The magazine is available in print and online. The magazine is available in print and online.

www.acnielsen.aim.dk/LEGO



WIN LEGO® PRODUCTS

No purchase necessary.
Open to residents of all countries where
not prohibited.
Go to www.lego.com for official rules and details.

WIN LEGO® PRODUCTEN

Kopen niet nodig.
Open voor alle leeftijdsgroepen in alle landen
waar geen verbod geldt.
Ga naar www.lego.com voor de officiële regels en details.

GEWINNE LEGO® PRODUKTE

Die Teilnahme am Gewinnspiel ist nur
vollständig bei Kaufteilnahme.
Sie können teilnehmen in allen ausgeschickten
Ländern teilhaben.
Die offiziellen Regeln und Details sind auf unserer
Partner-App unter www.lego.com.



GAGNE DES PRODUITS LEGO®

Aucun achat, ni achat nécessaire.
Ouvert à tous les âges et aux résidents de
tous les pays sauf en cas d'interdiction.
Renseignez-vous sur www.lego.com pour obtenir plus
de détails et le règlement officiel.

LEGO®製品を「当てよう」

購入は不要です。
禁止されていない国や、あらゆる
年齢層、世界中に公開の国や国
の方々にご利用いただけます。
公式規則および詳細につきましては、
www.lego.comをご覧ください。



 www.LEGO.com

©2018 The LEGO Group. 4537400