

LEGO

トクシュブタイ

毒蜘蛛

8117



IRON DRONE





1

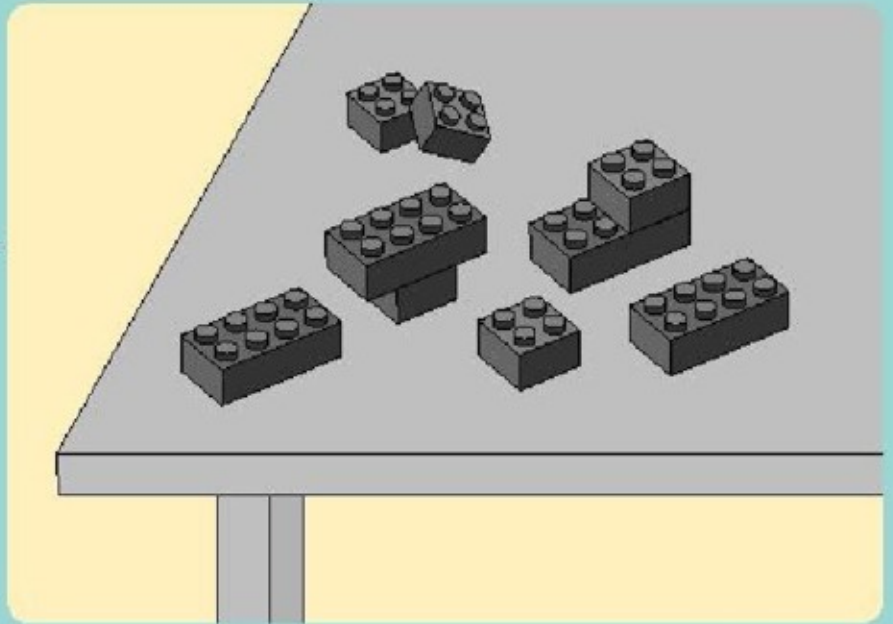
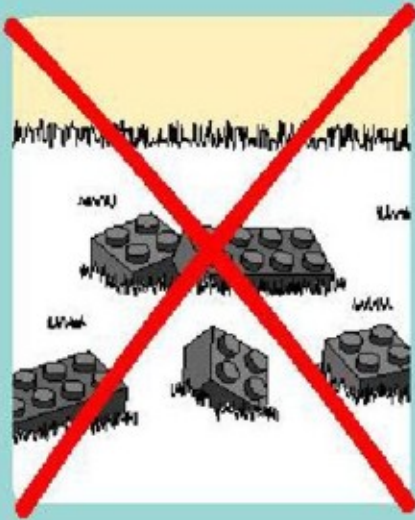

2





3

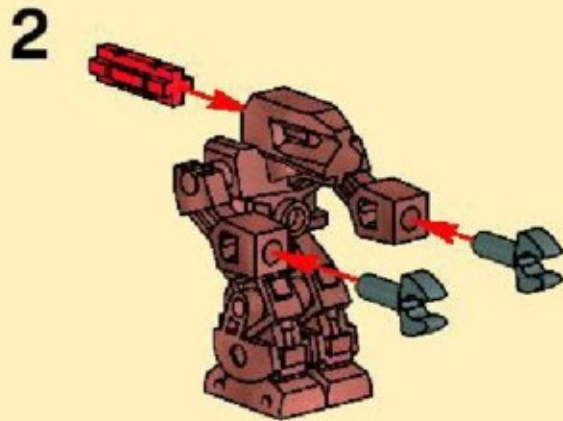
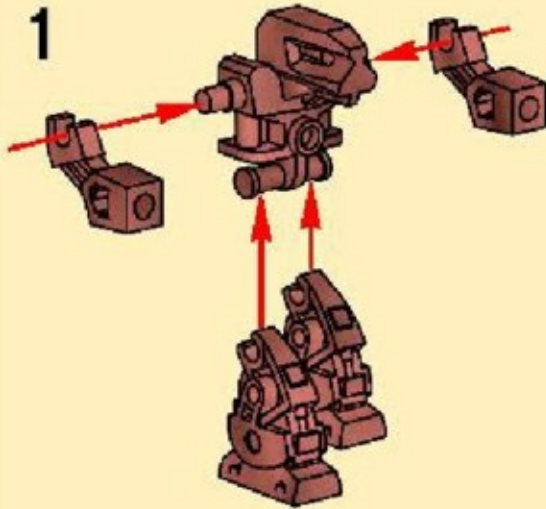



1



2



3





4

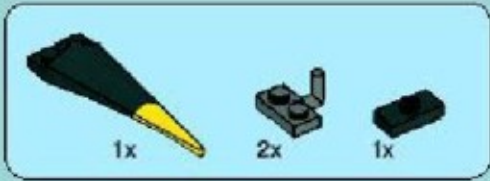
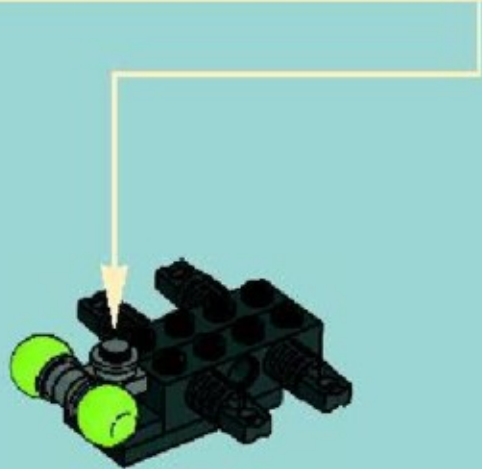
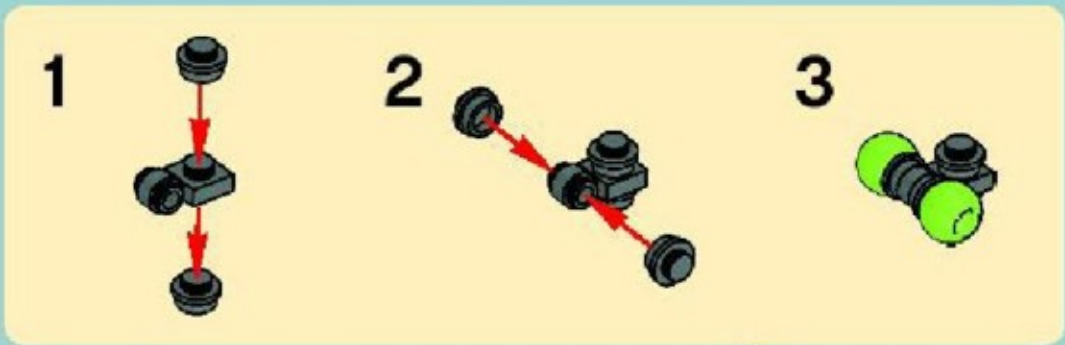

5

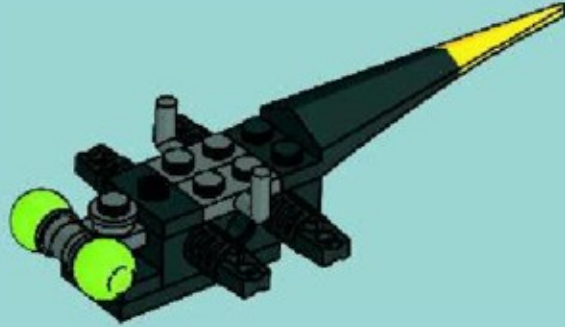



3x

6

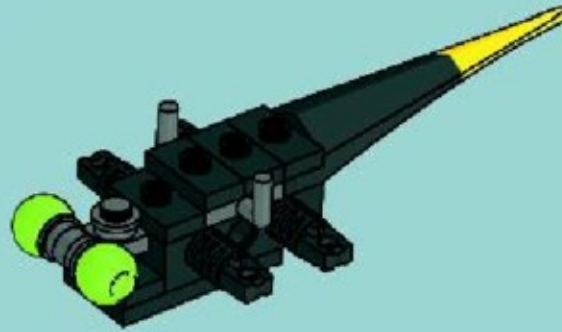

1x



1x

7

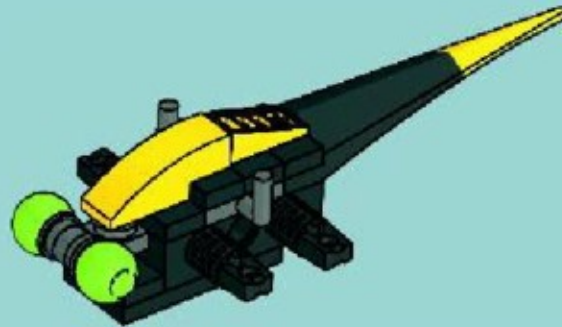

8

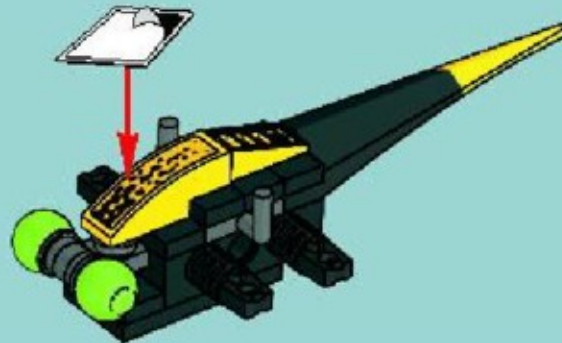



1x



1x

9

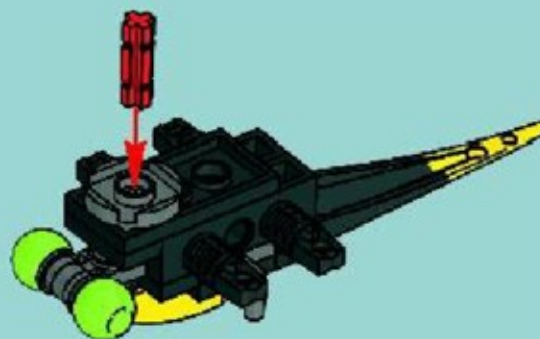

1x

10

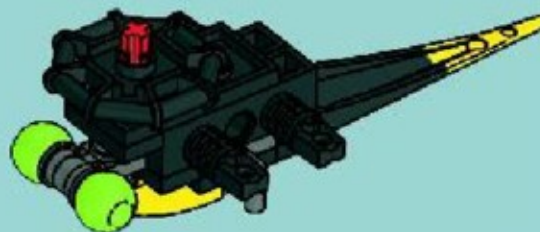

1x

11

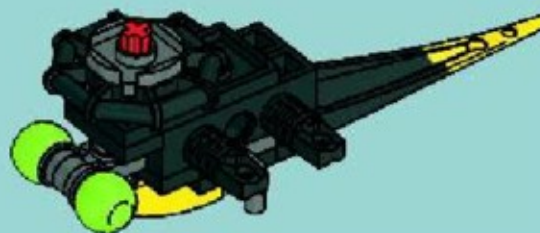



12

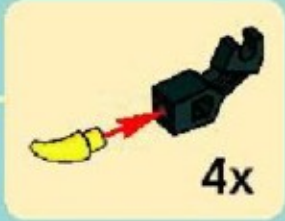

13



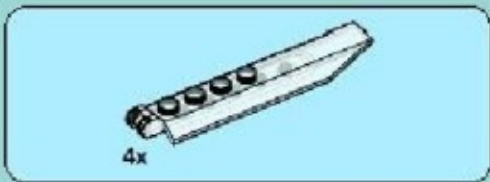

14

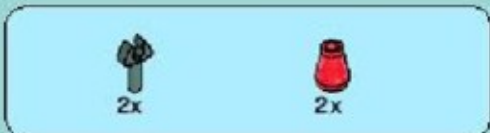
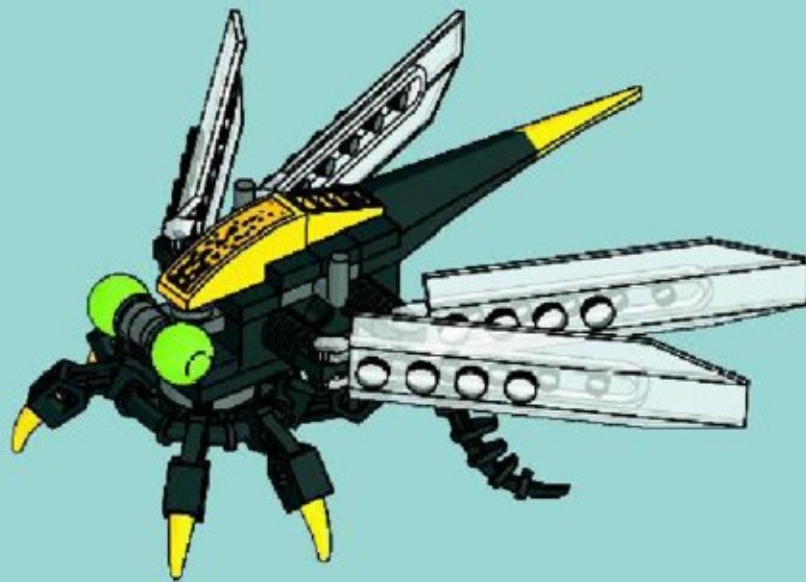

15





1x

1



2x

2

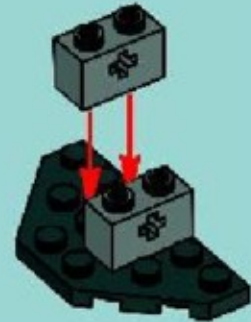

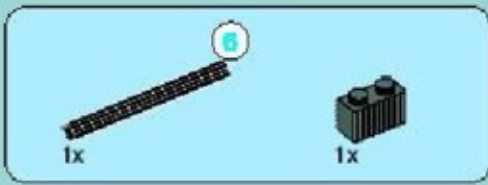

3



4



5





6

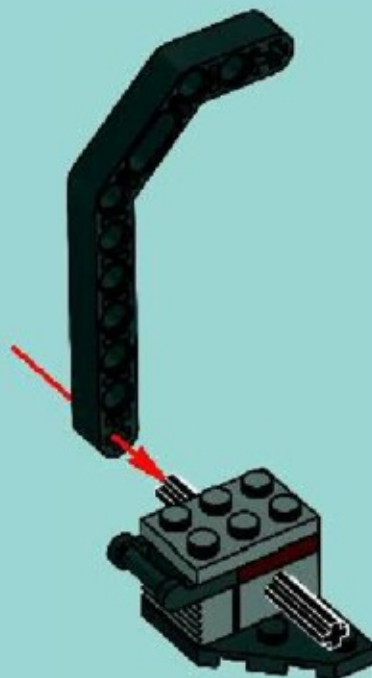

7

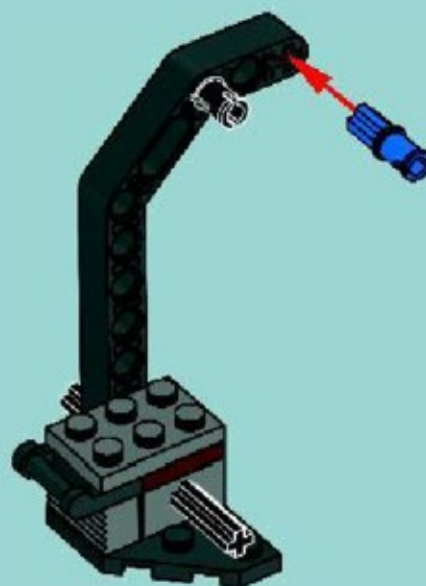

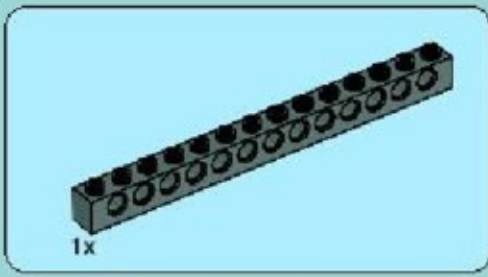

8

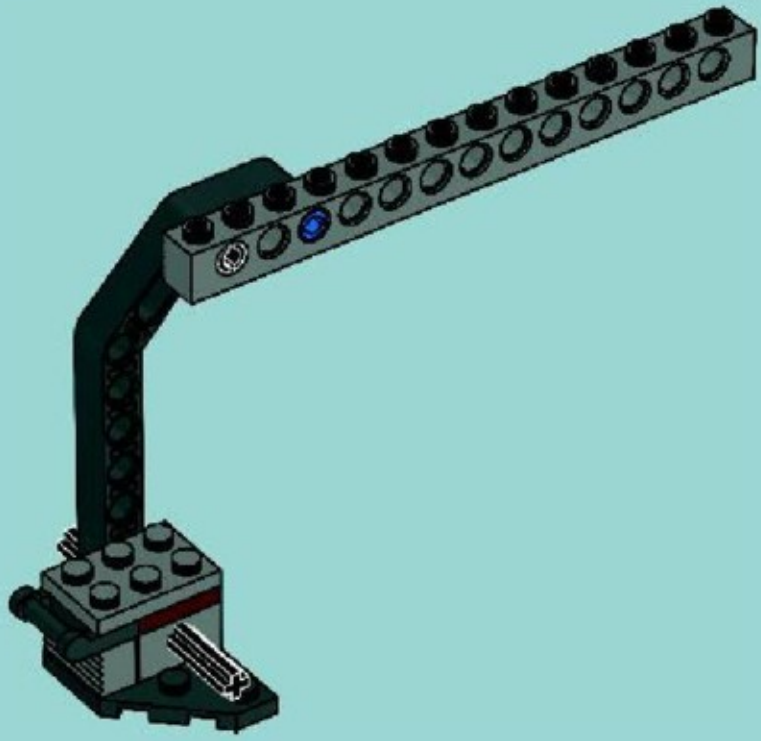

9

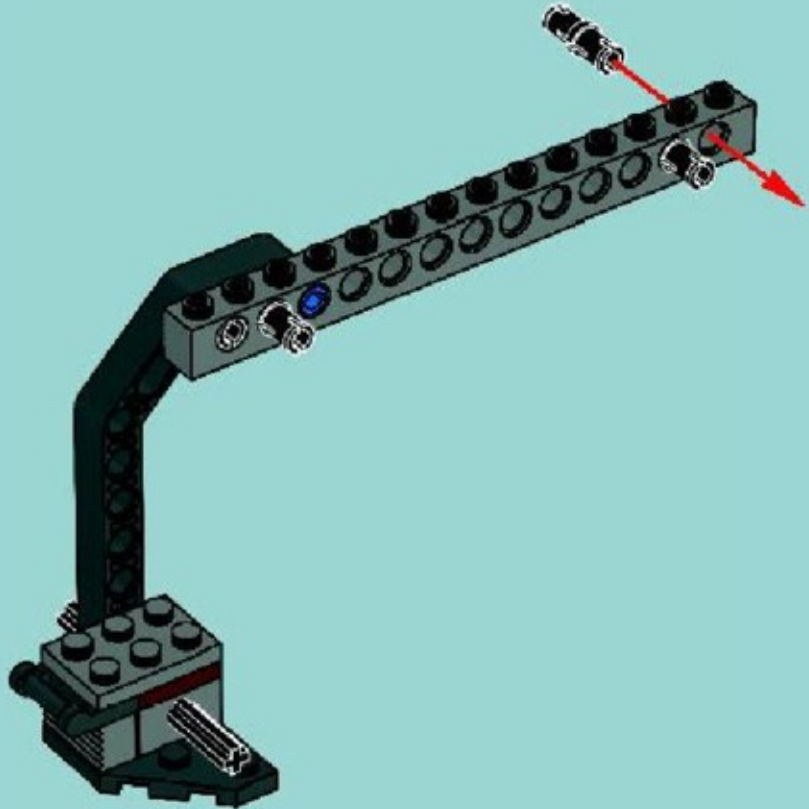

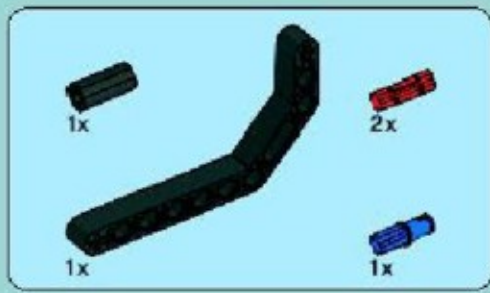

10

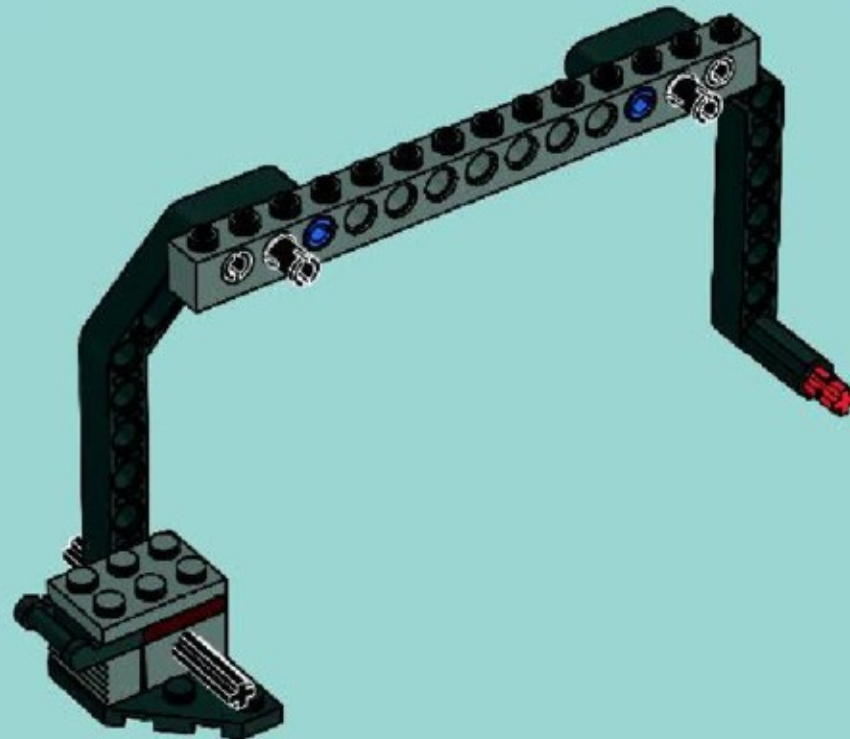
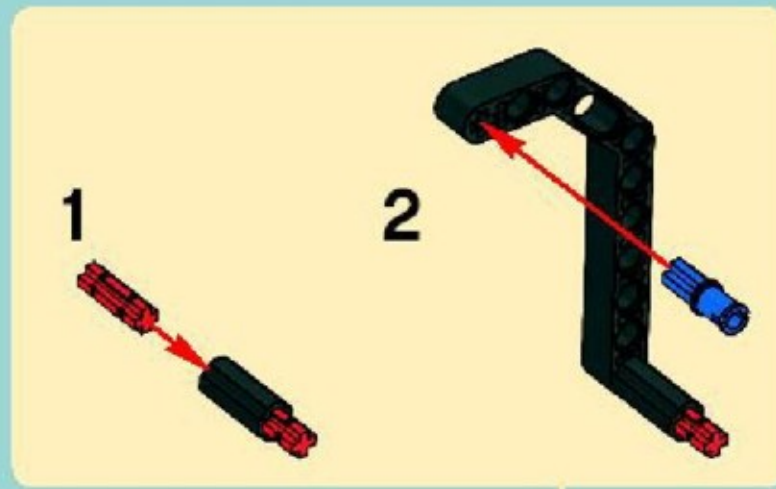

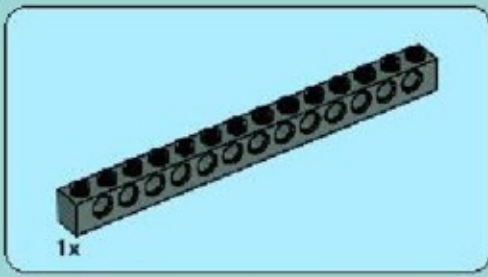

11

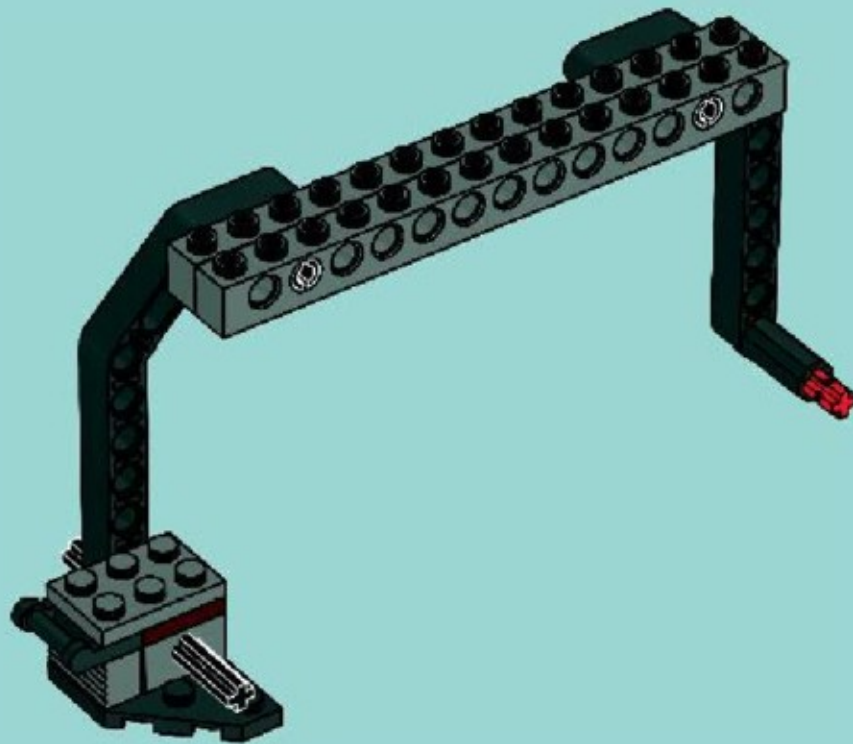



12

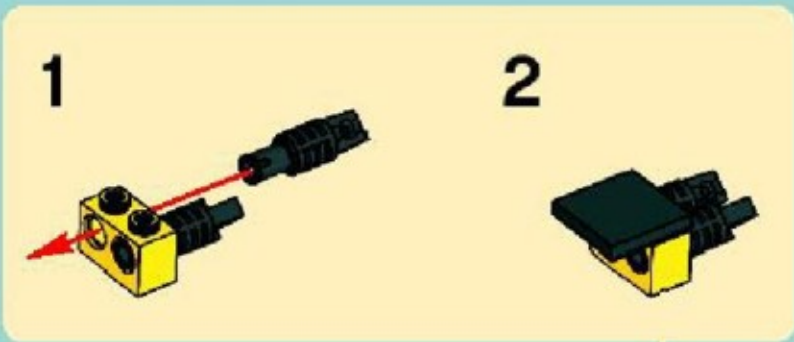

2

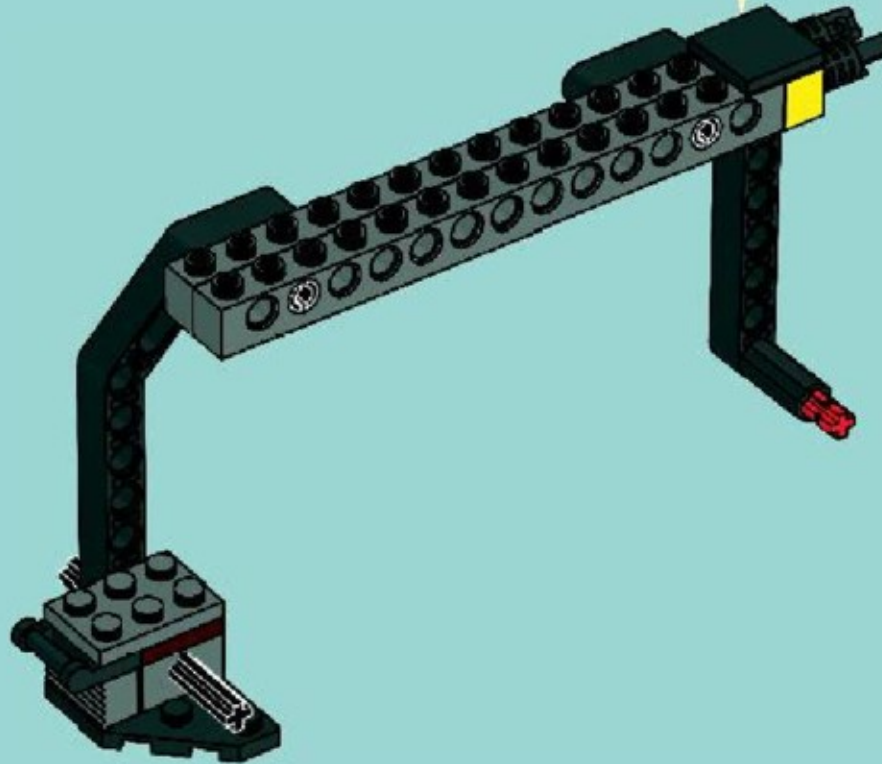



13

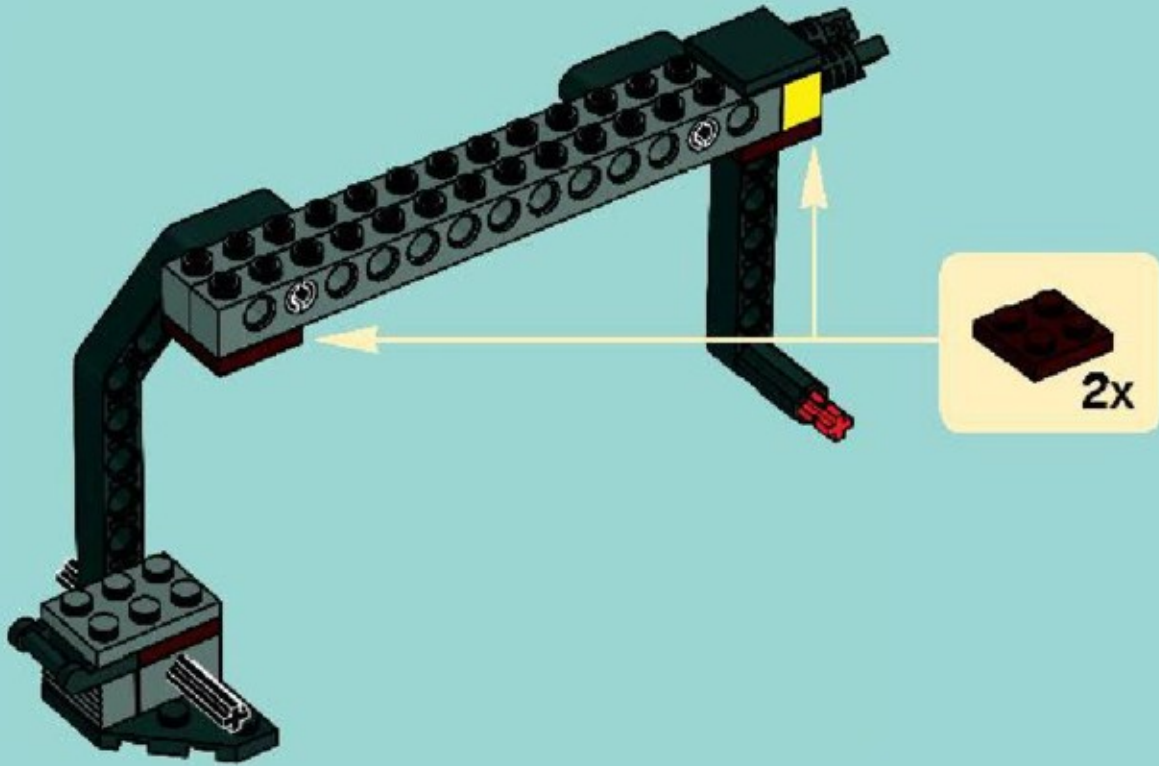



2x

14

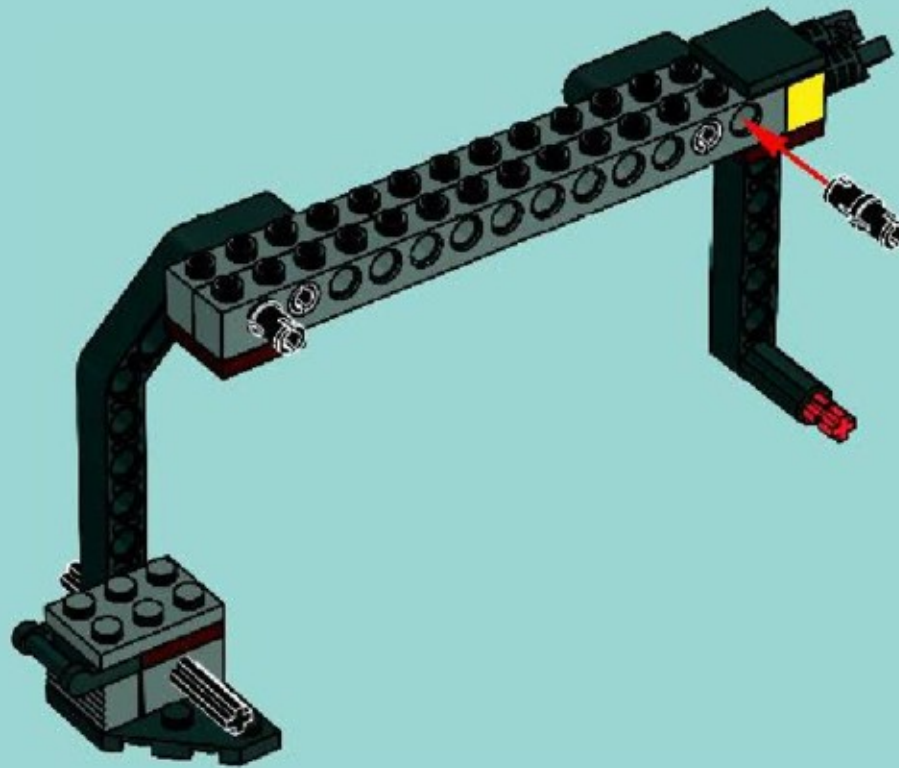



15

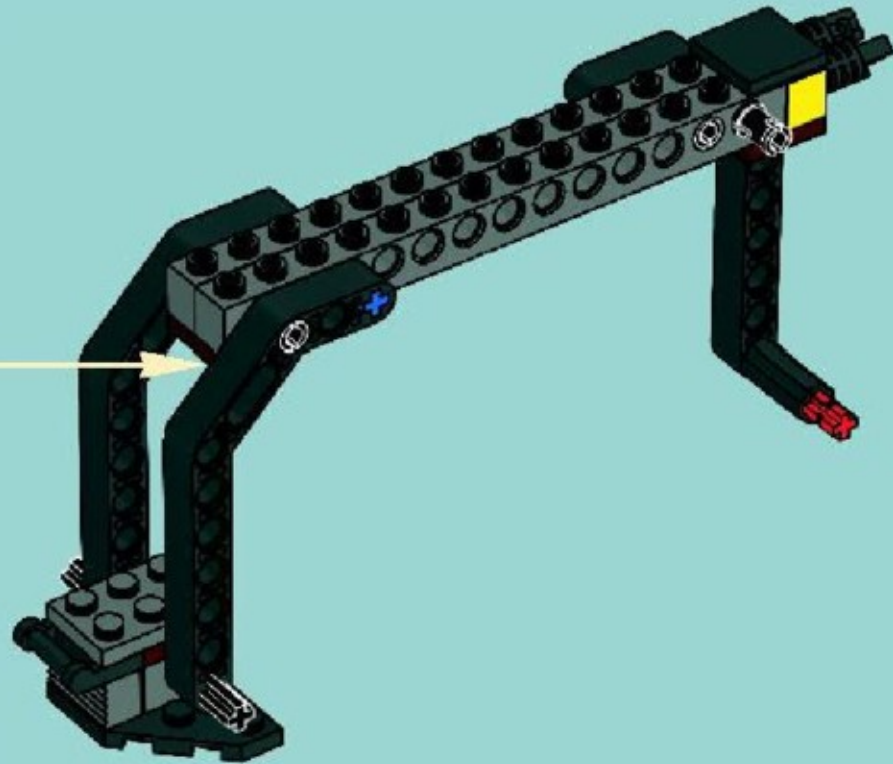



16

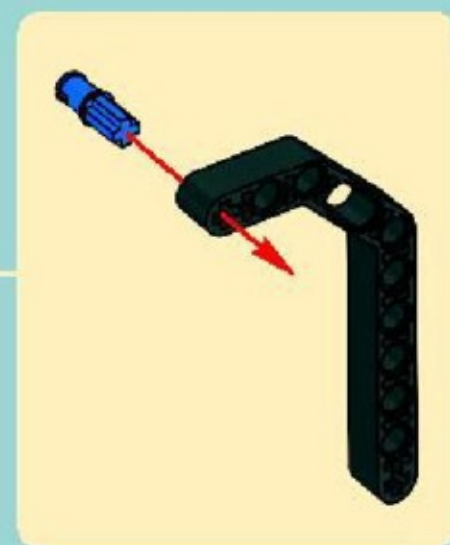
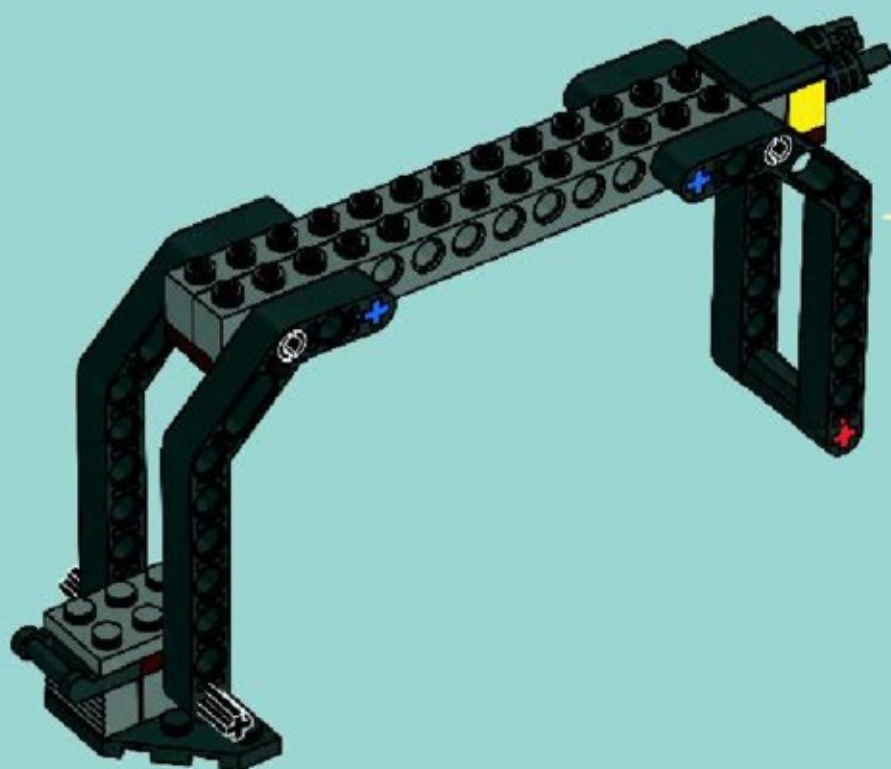



2x



1x

17

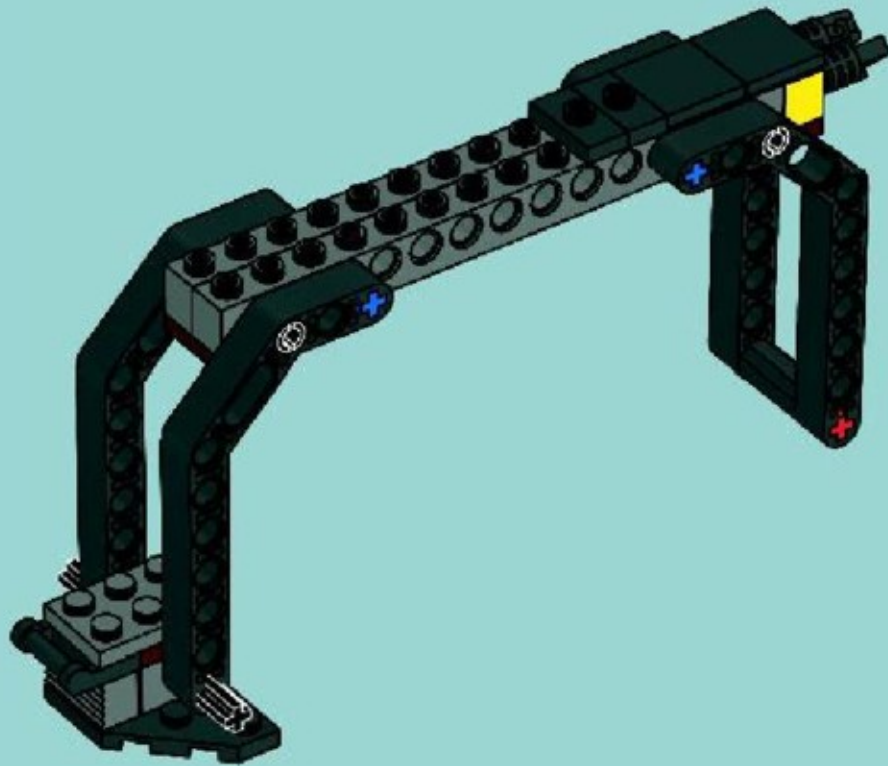



2x



1x

18

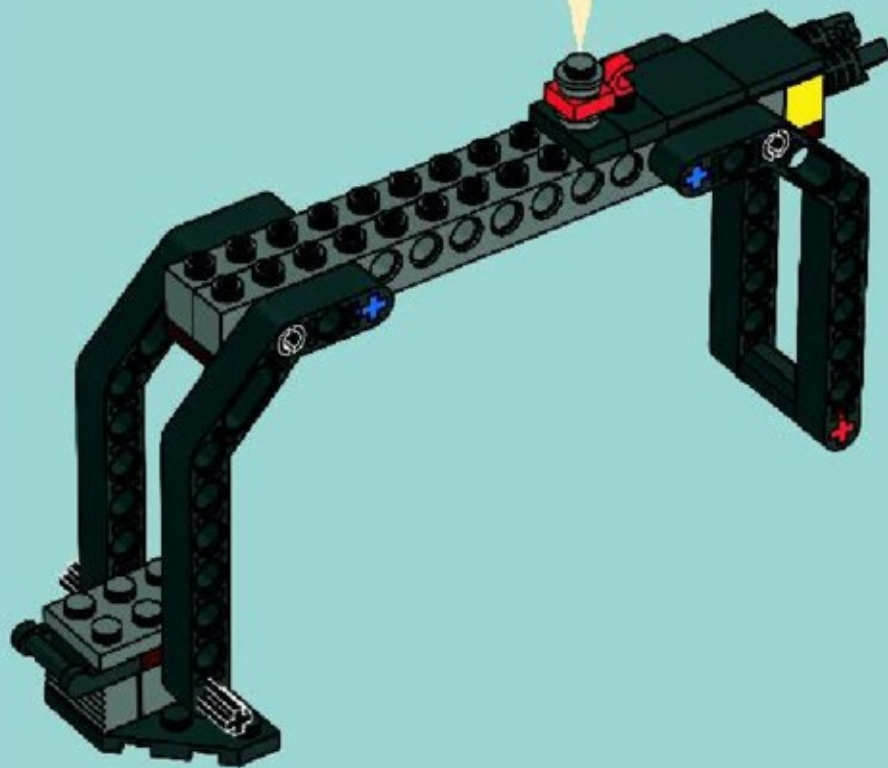
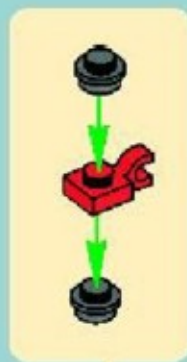



19

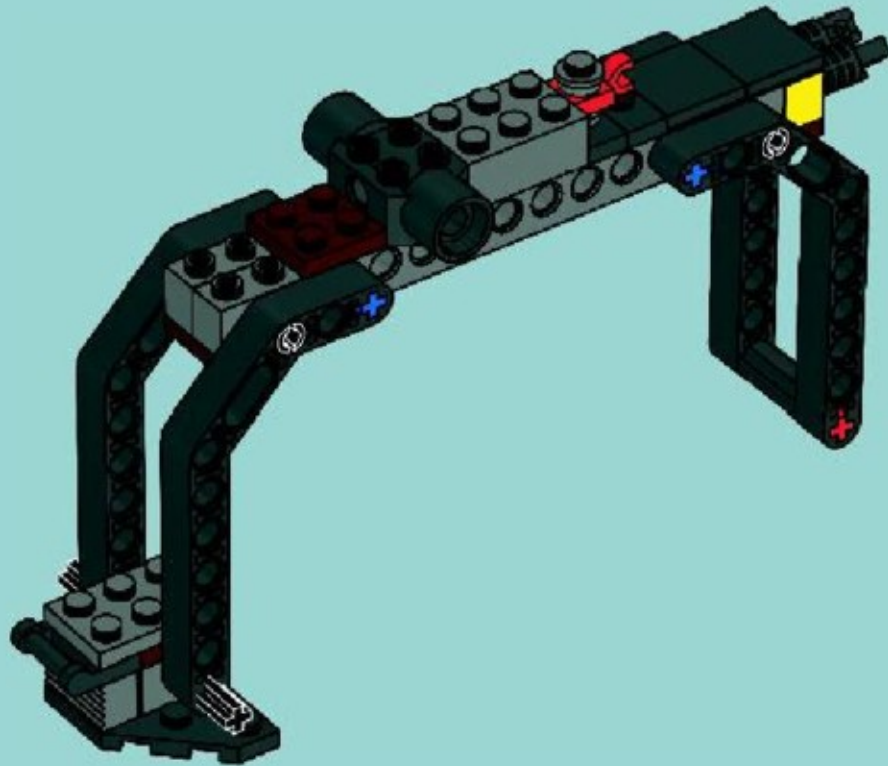



2x



1x

20

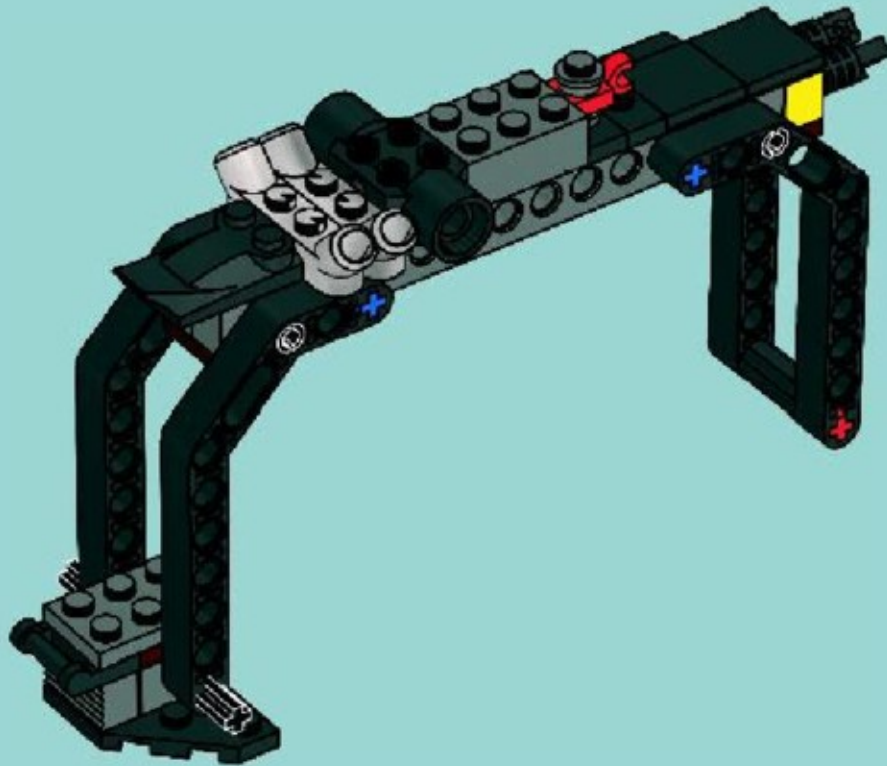

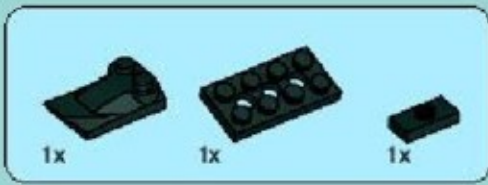

21

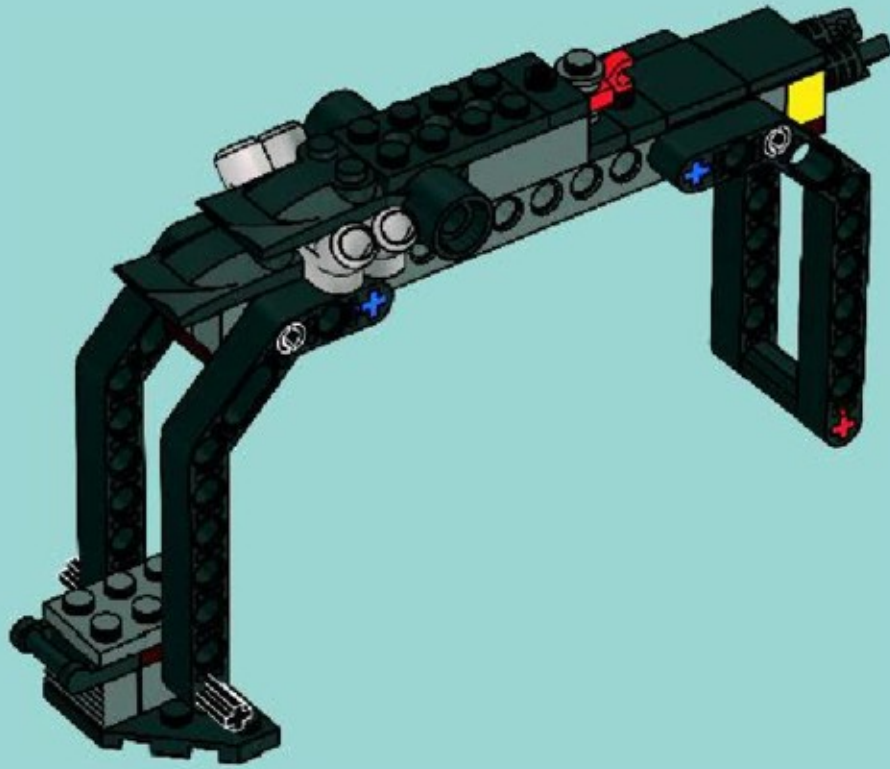



3x

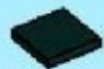

1x

22

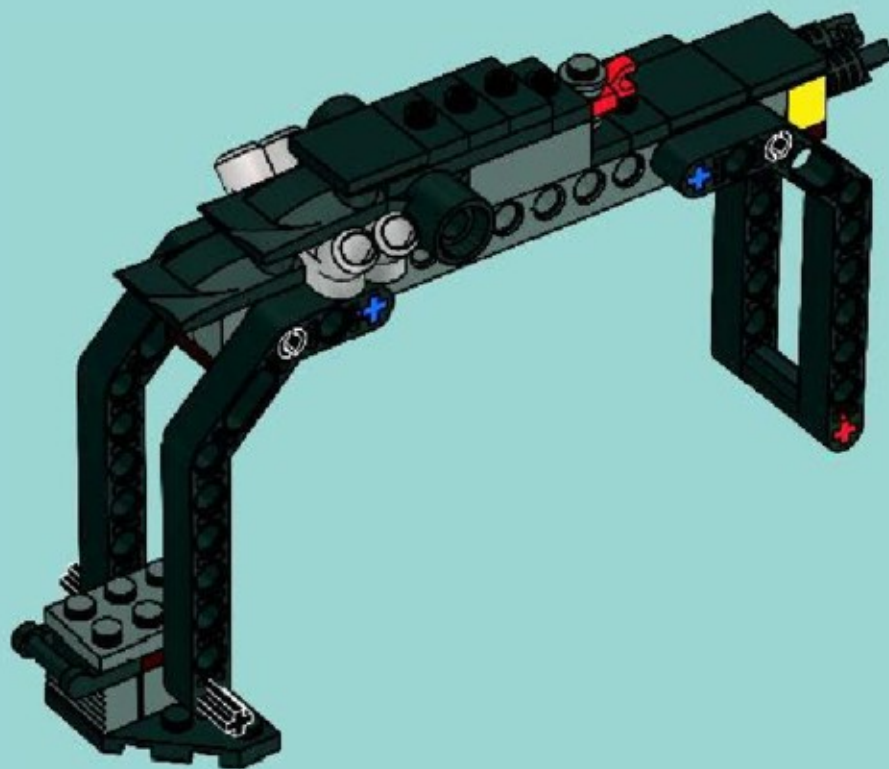



23

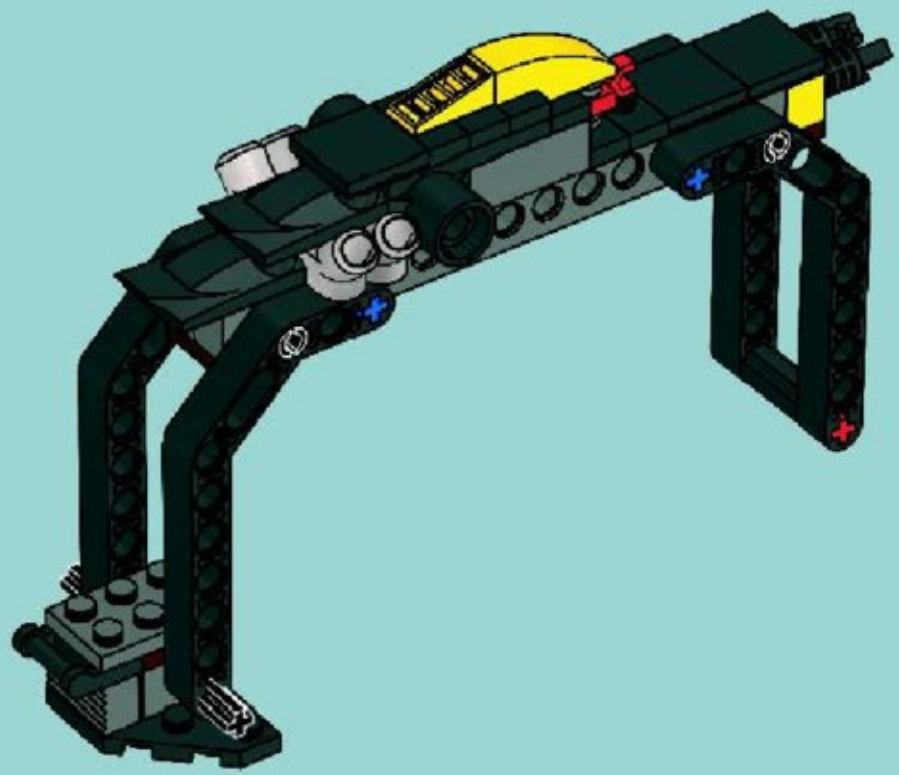

24

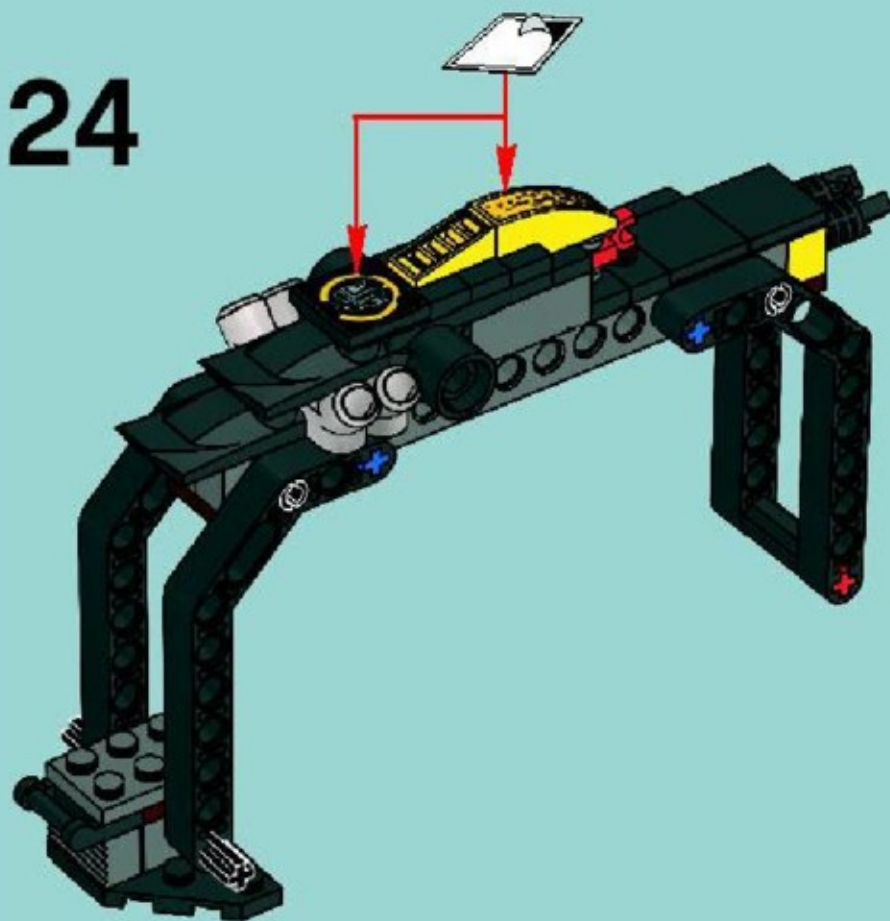

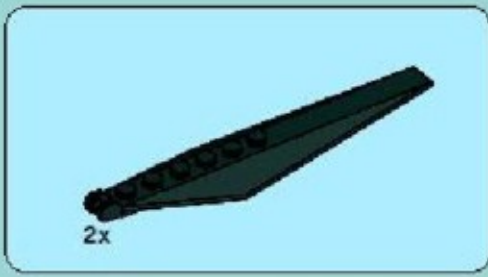

25

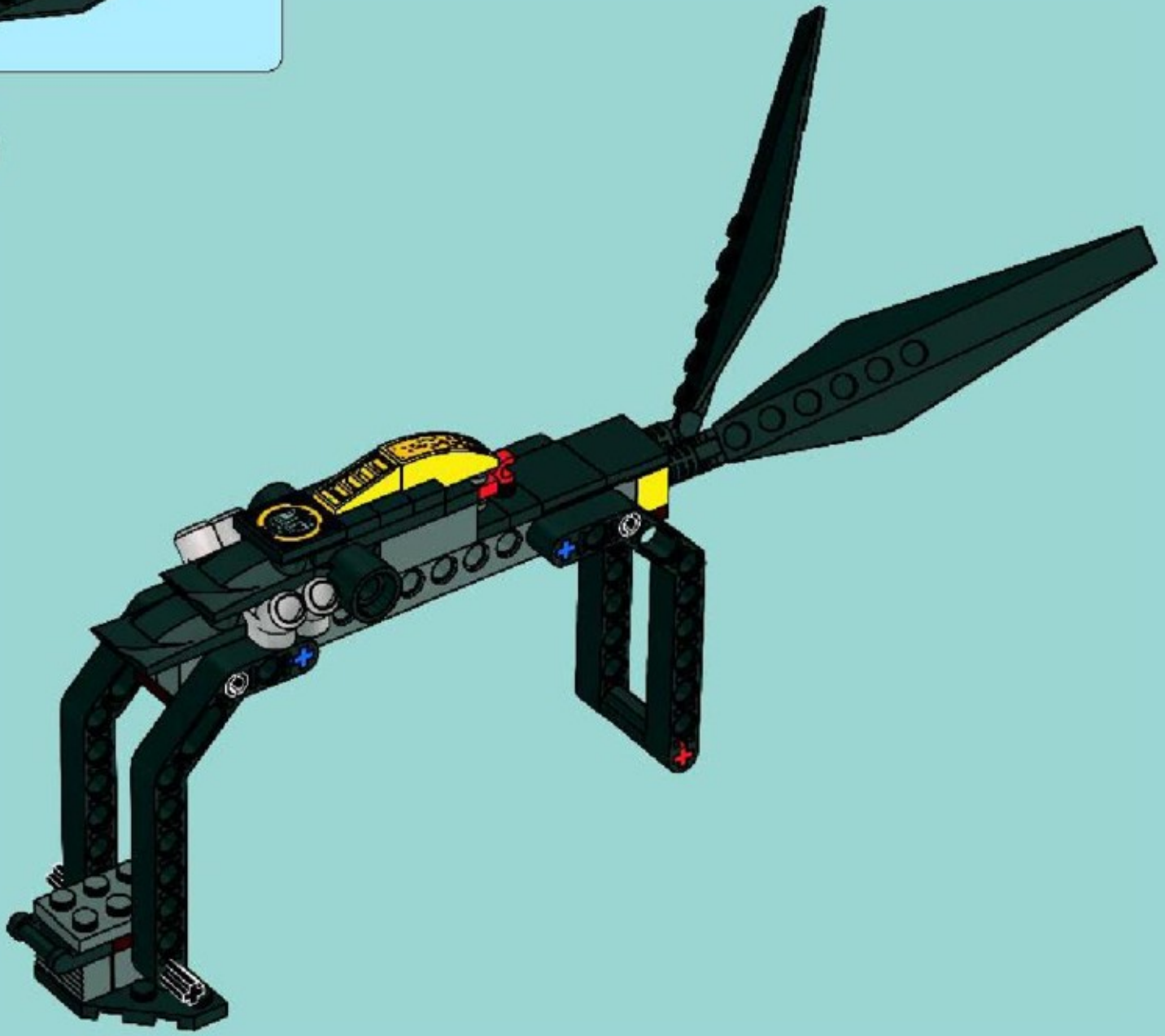

26

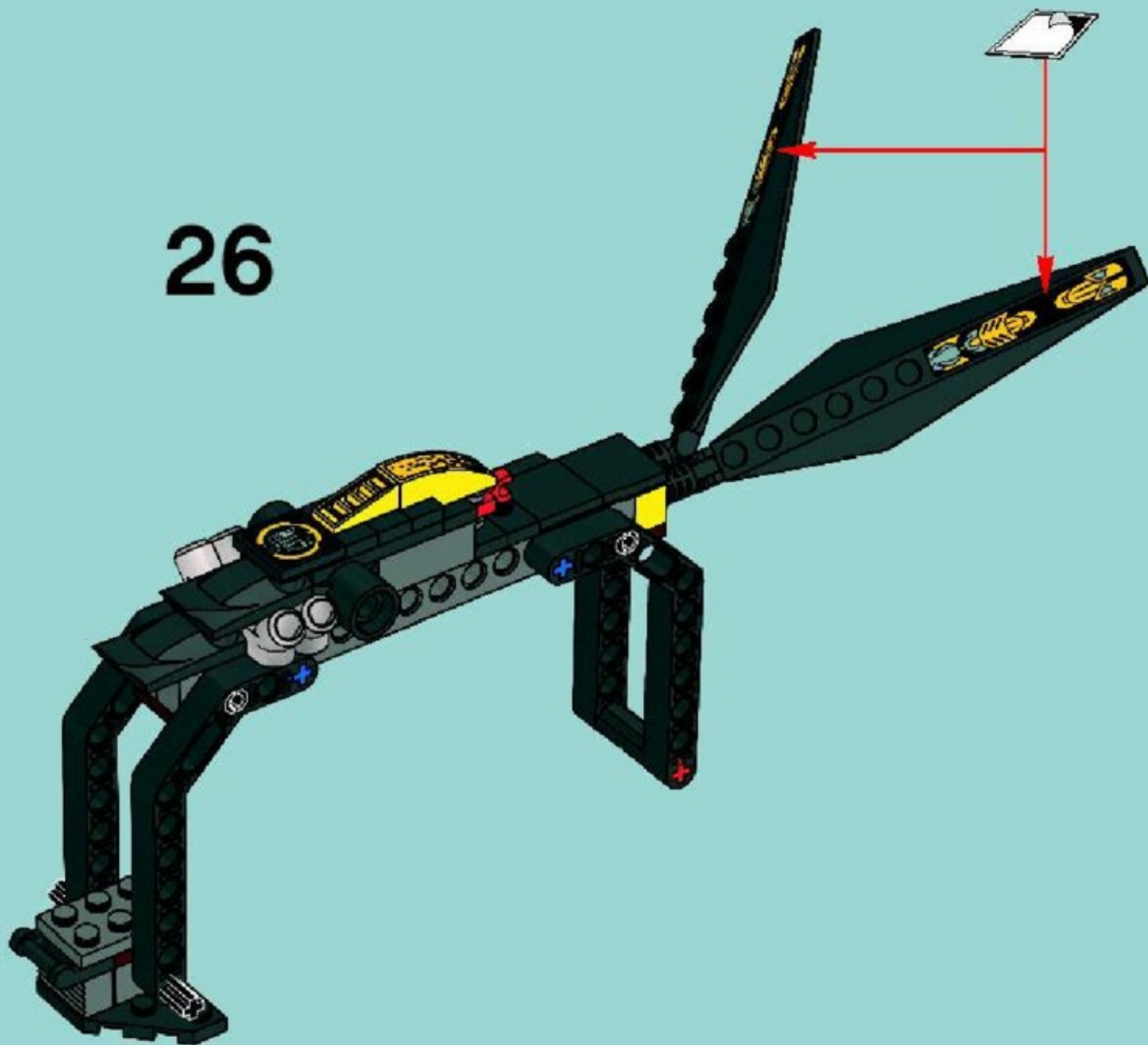



2x

27

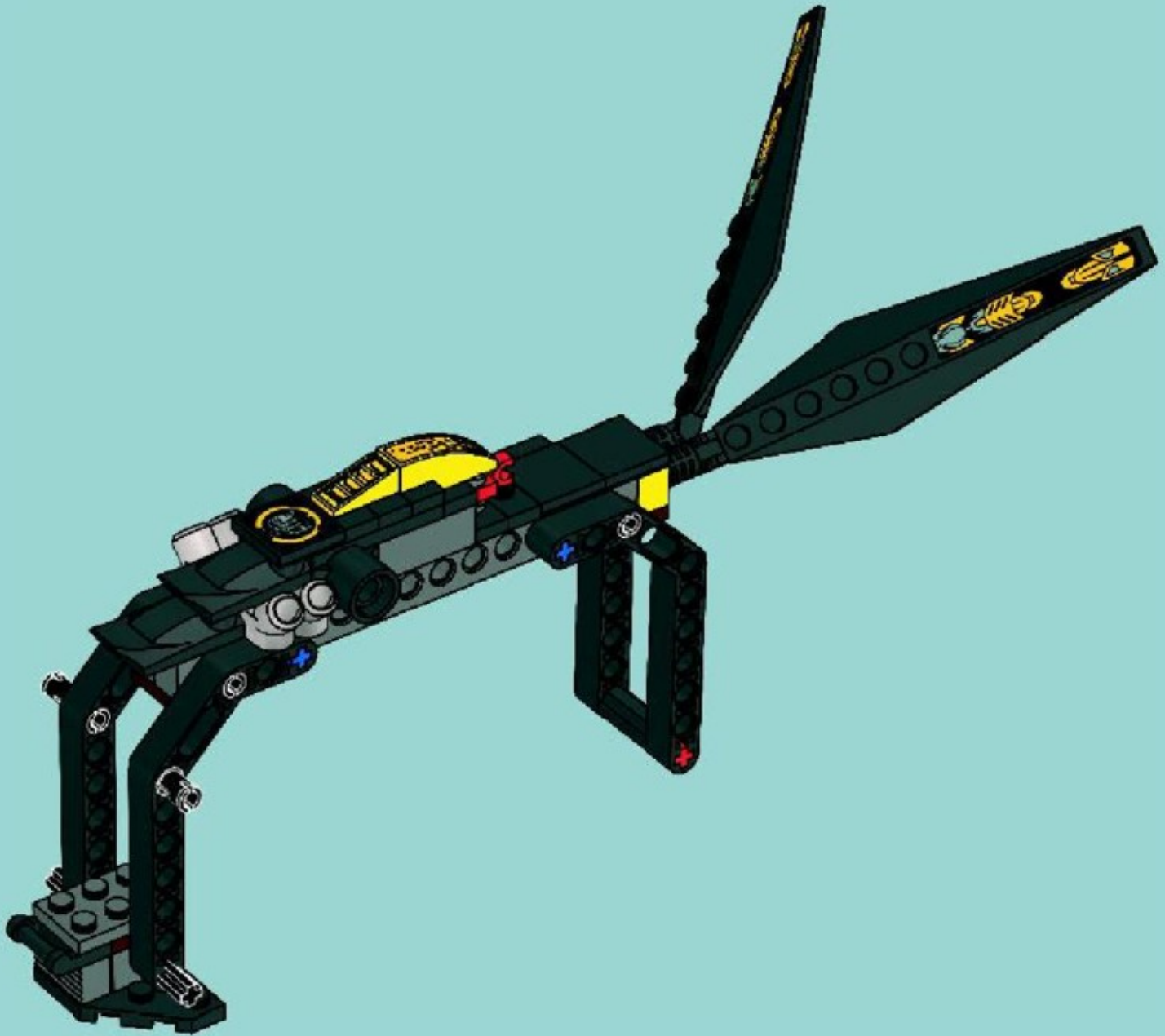



28

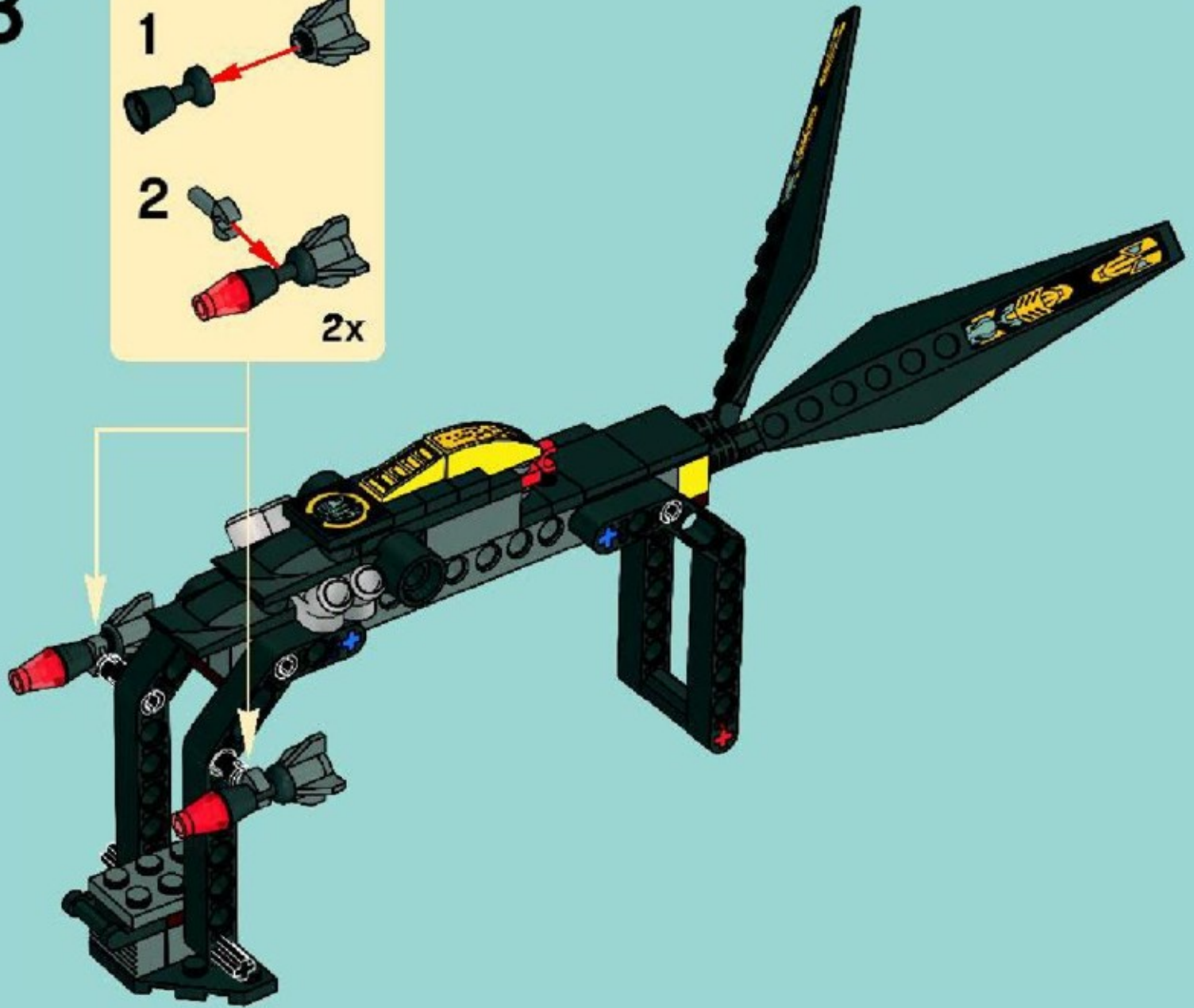
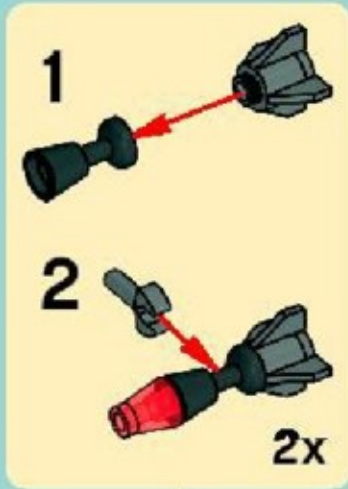

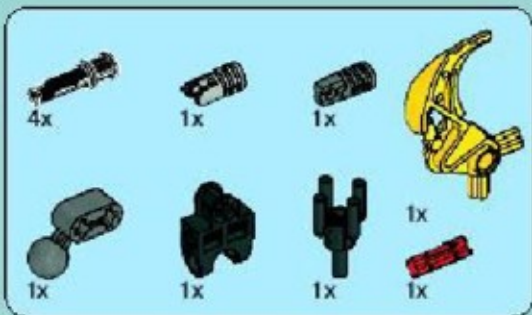

29

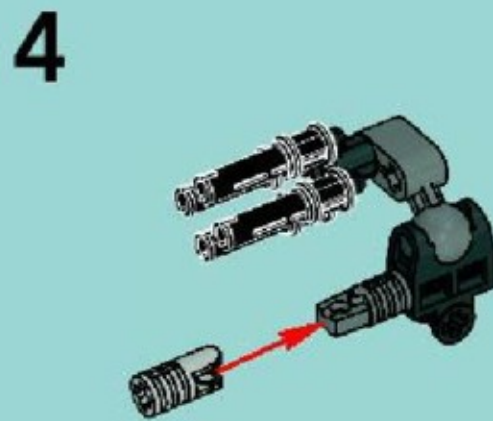
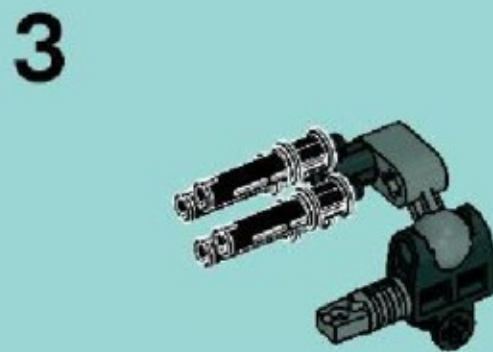
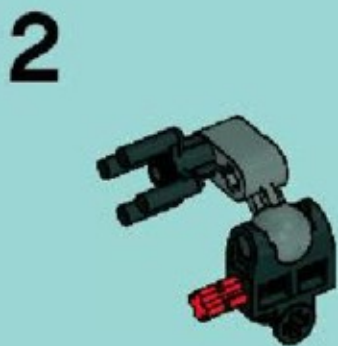
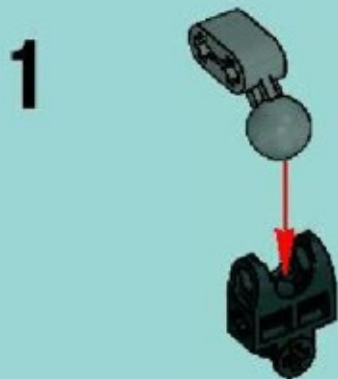

5

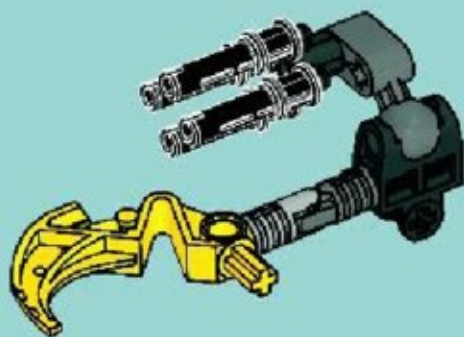

30

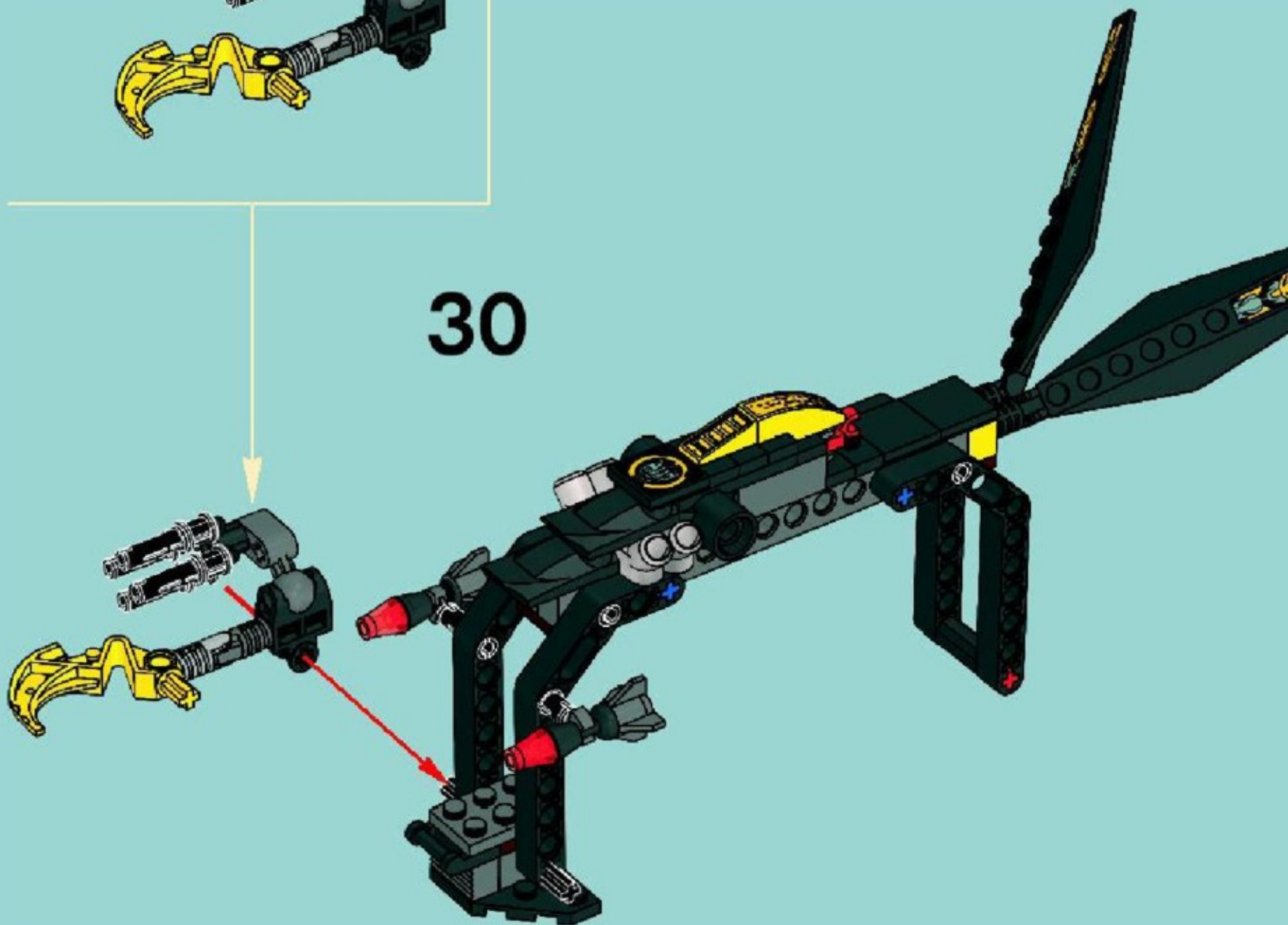

31

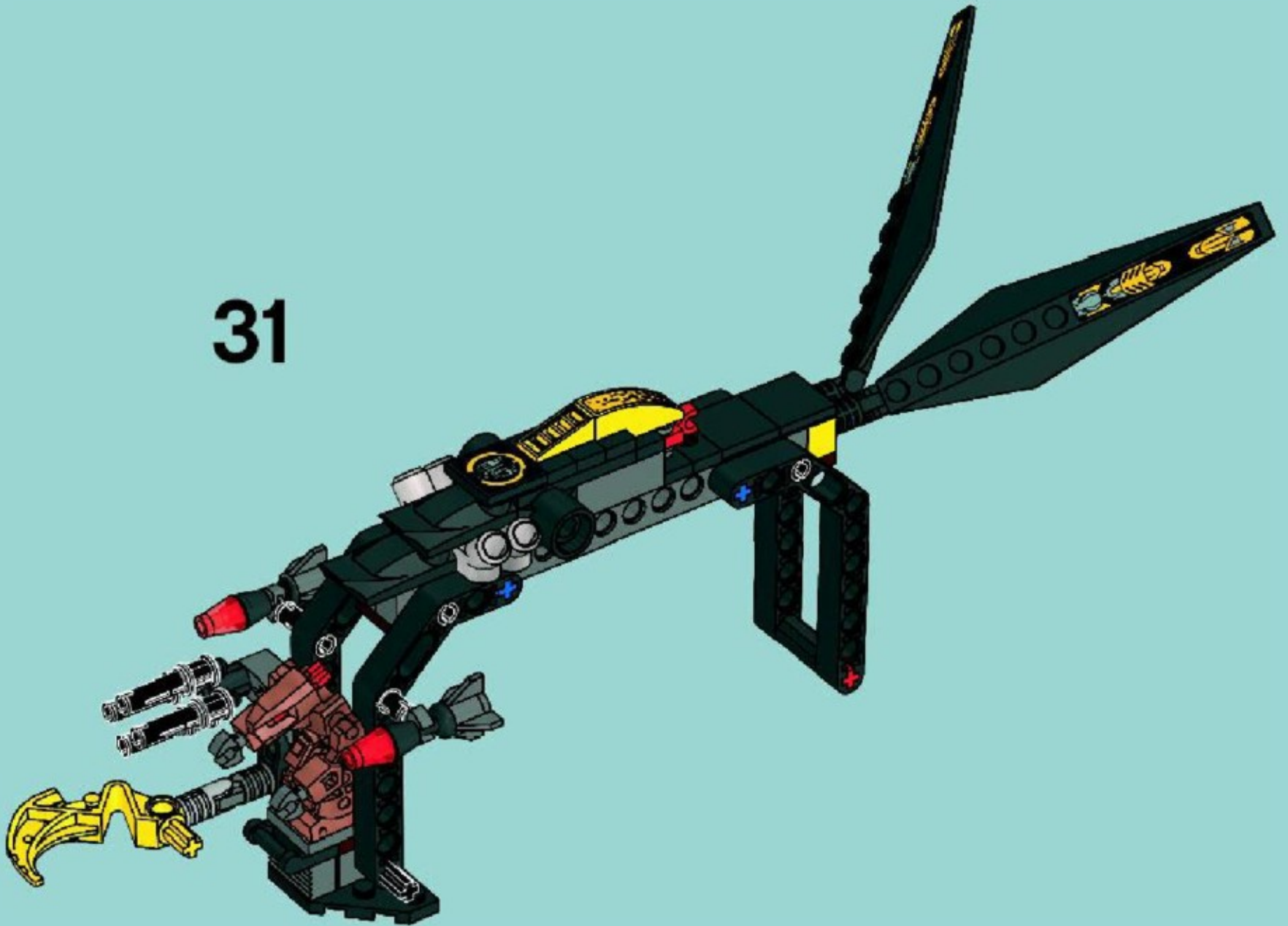

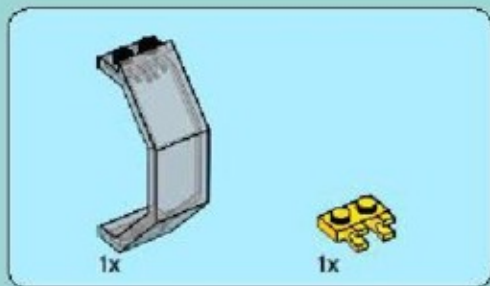

32

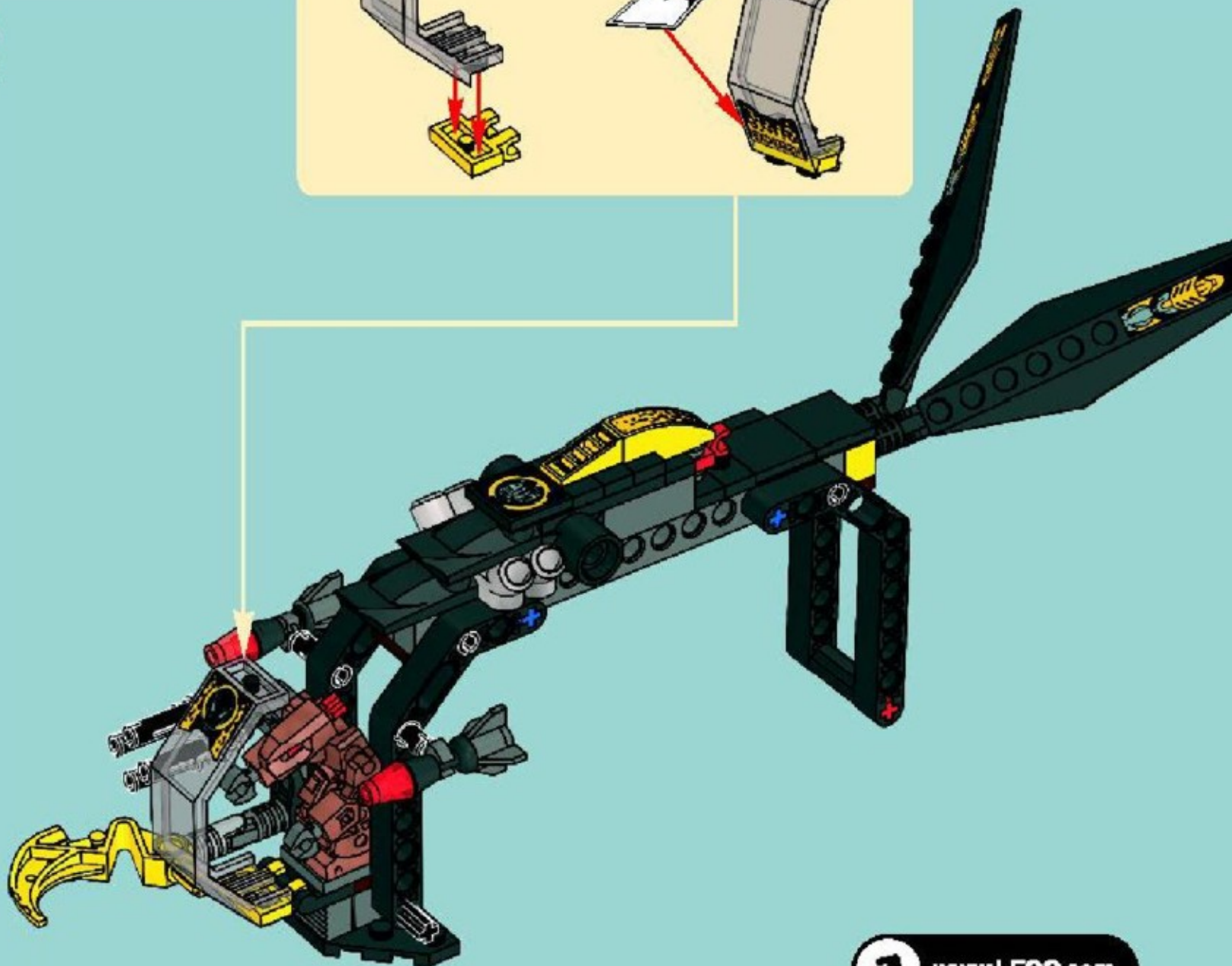
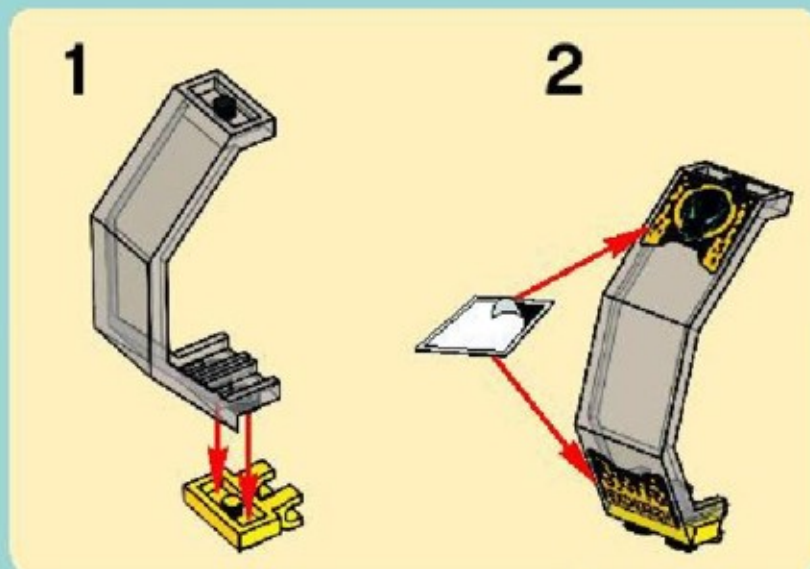

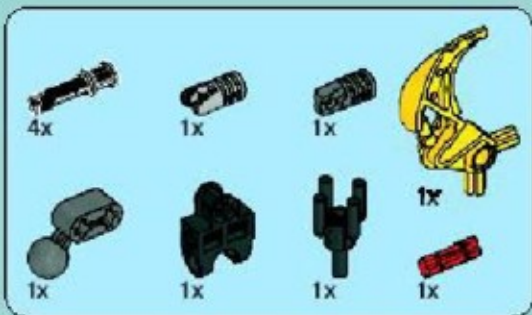

33

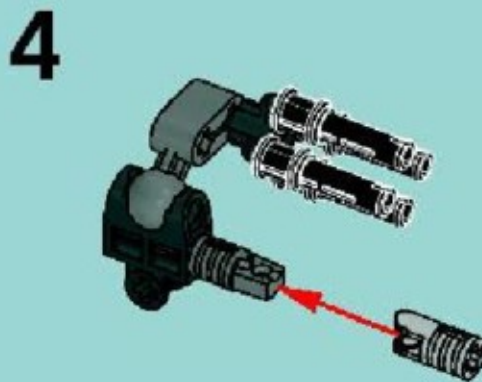
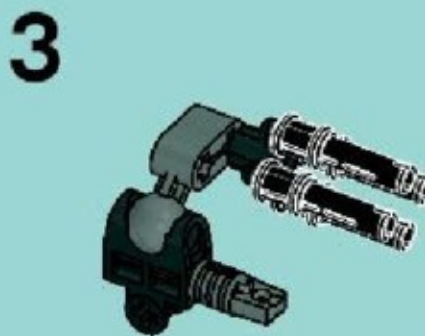
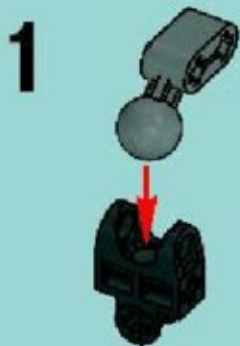

5

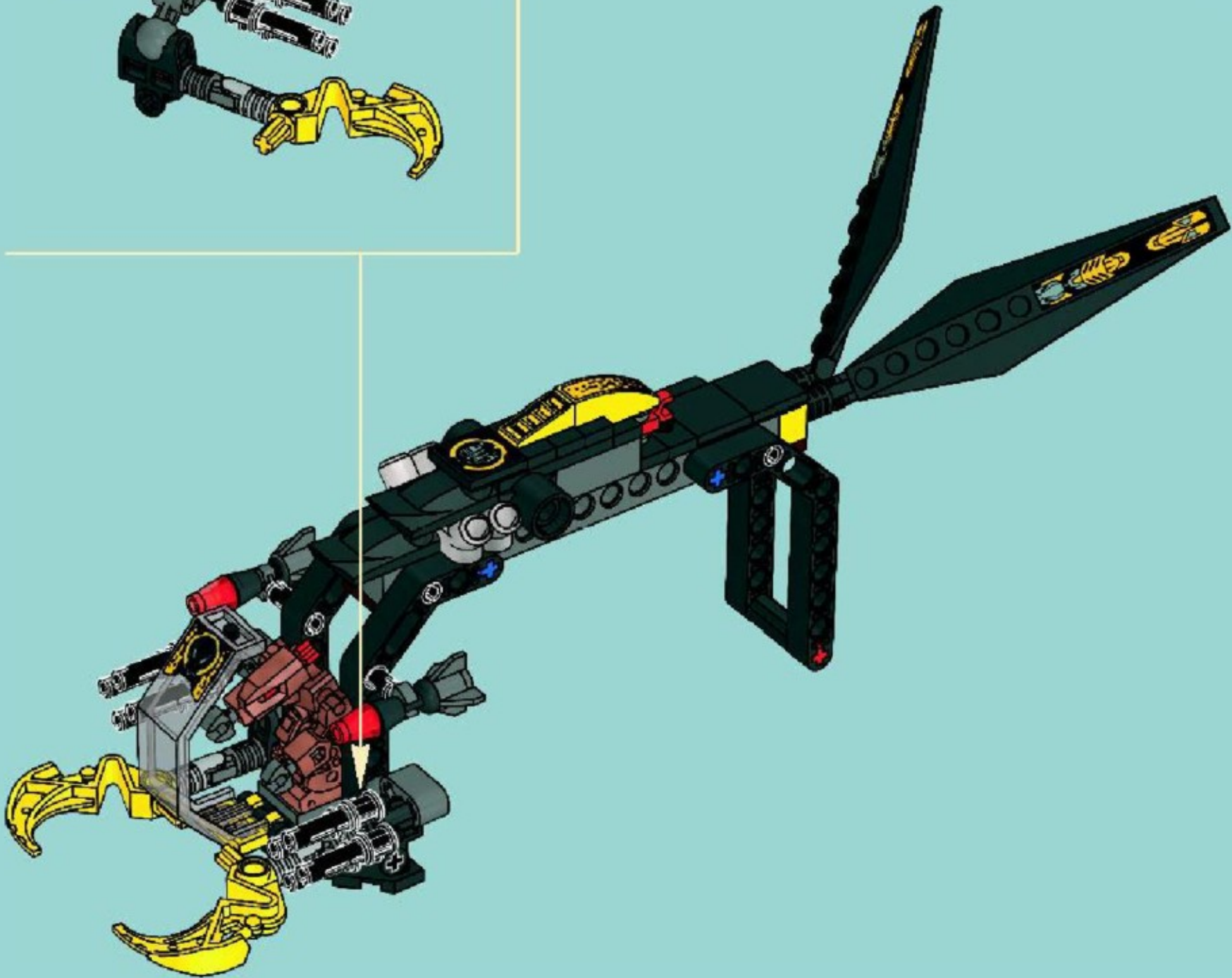
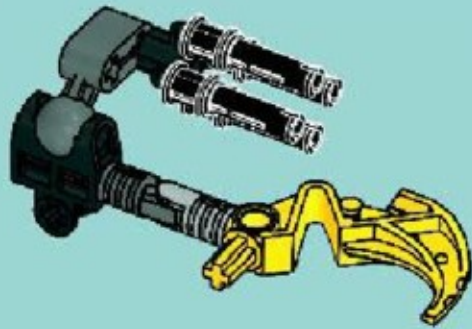

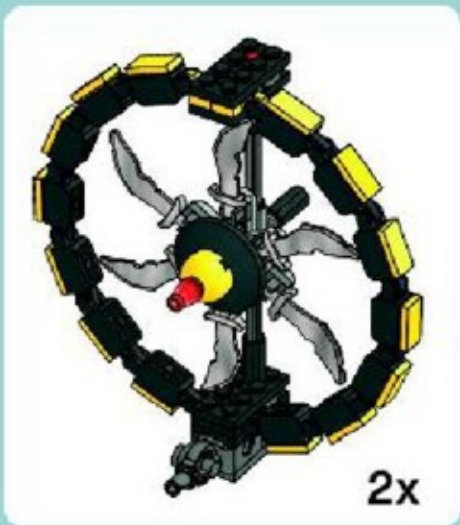

1



2

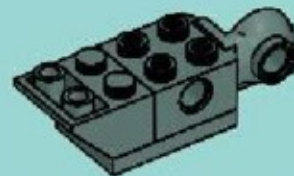

3

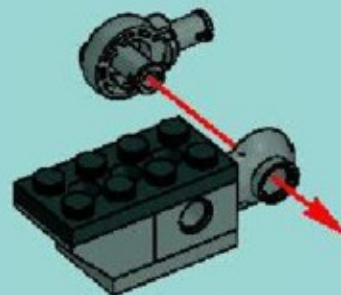



2x



1x

4

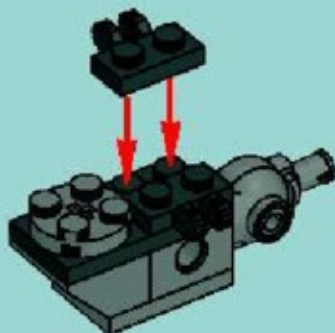

1x



1x

5



1x



1x

6

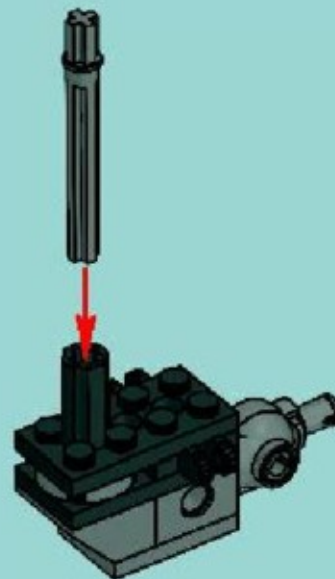



7

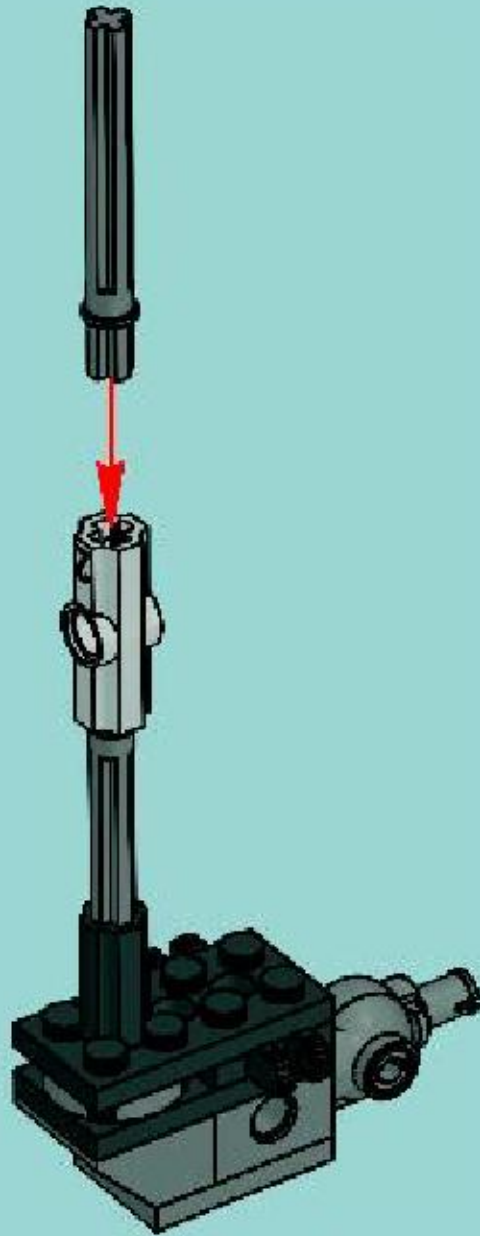

8

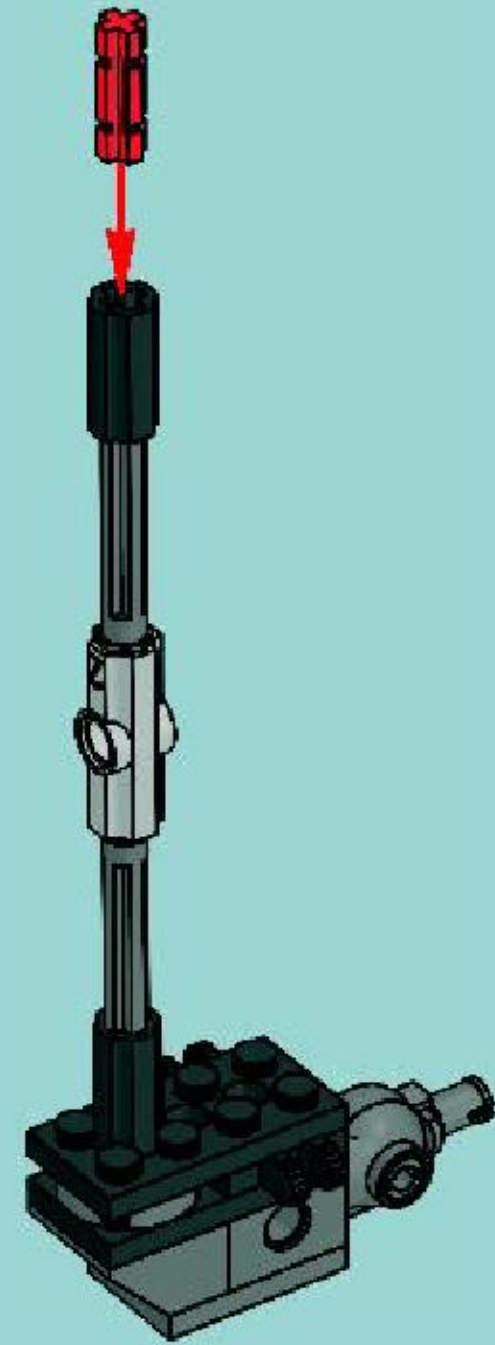



9

1



2



3

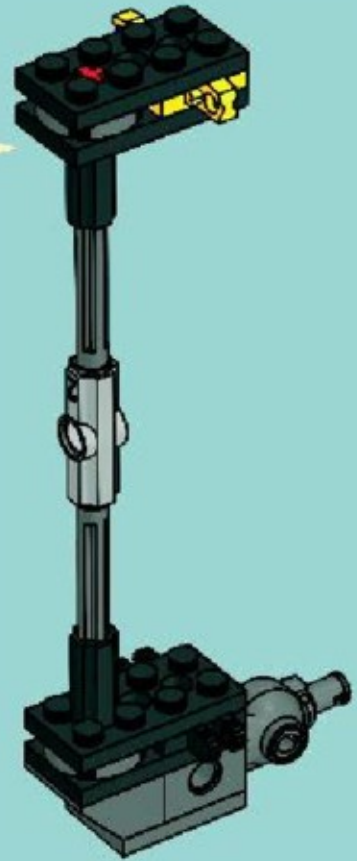



1



2



3



 5 1:1



4

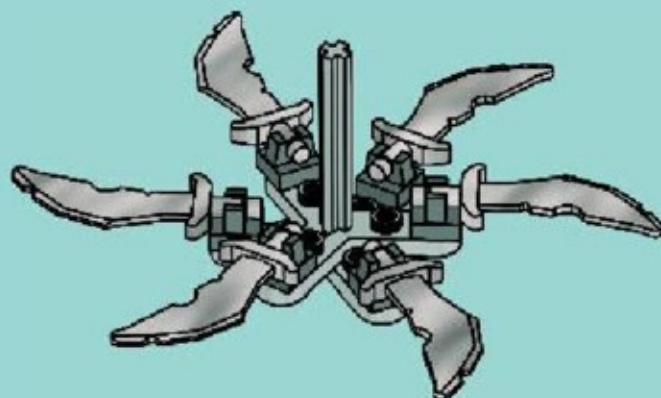

5

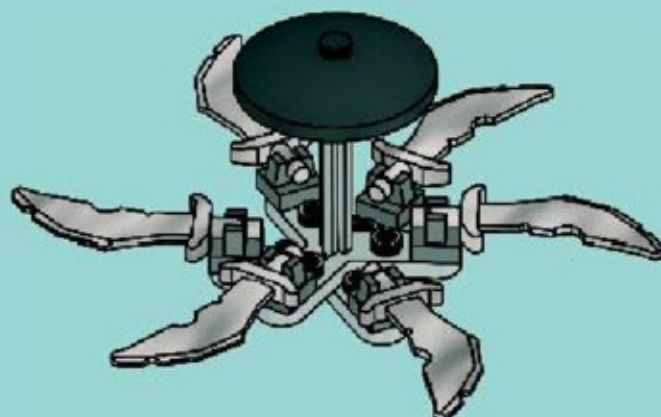



6

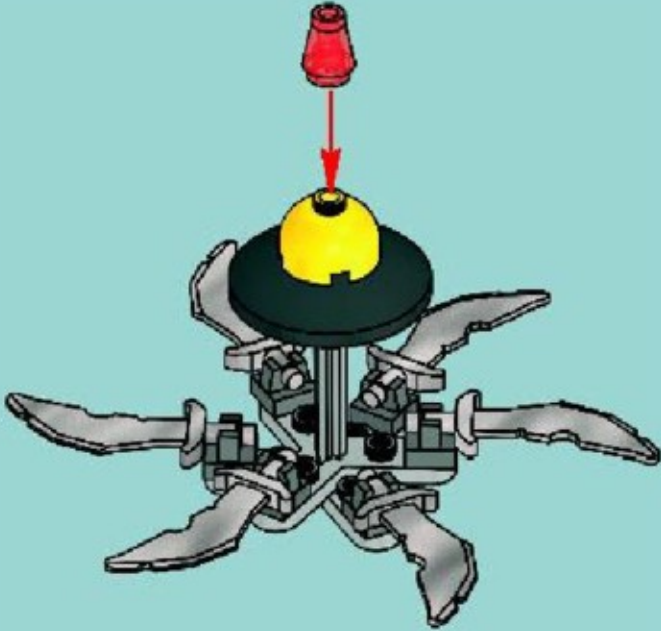

7

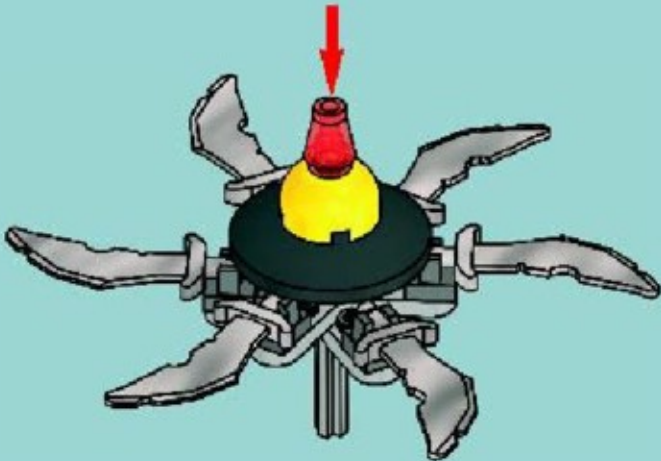



1x

10





11

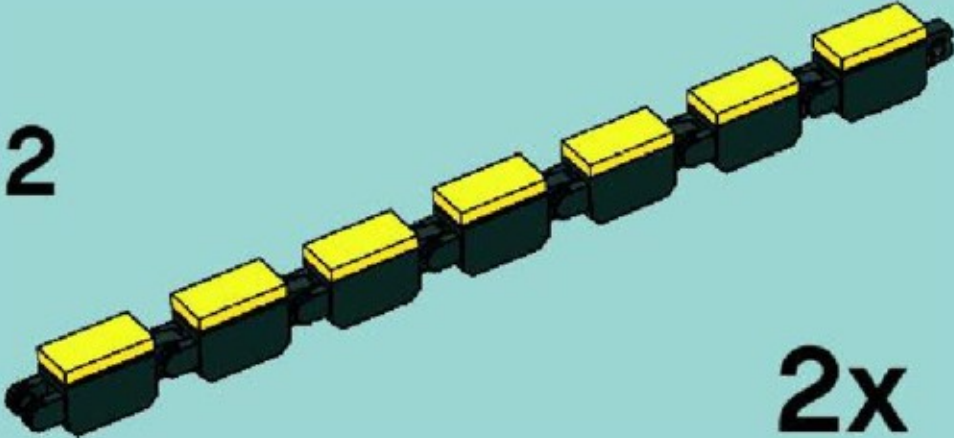
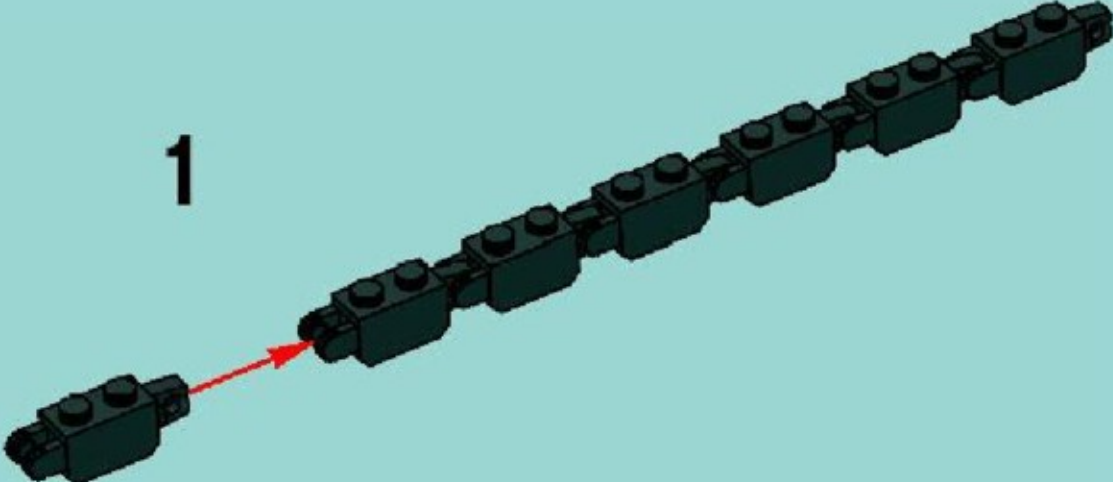

2x

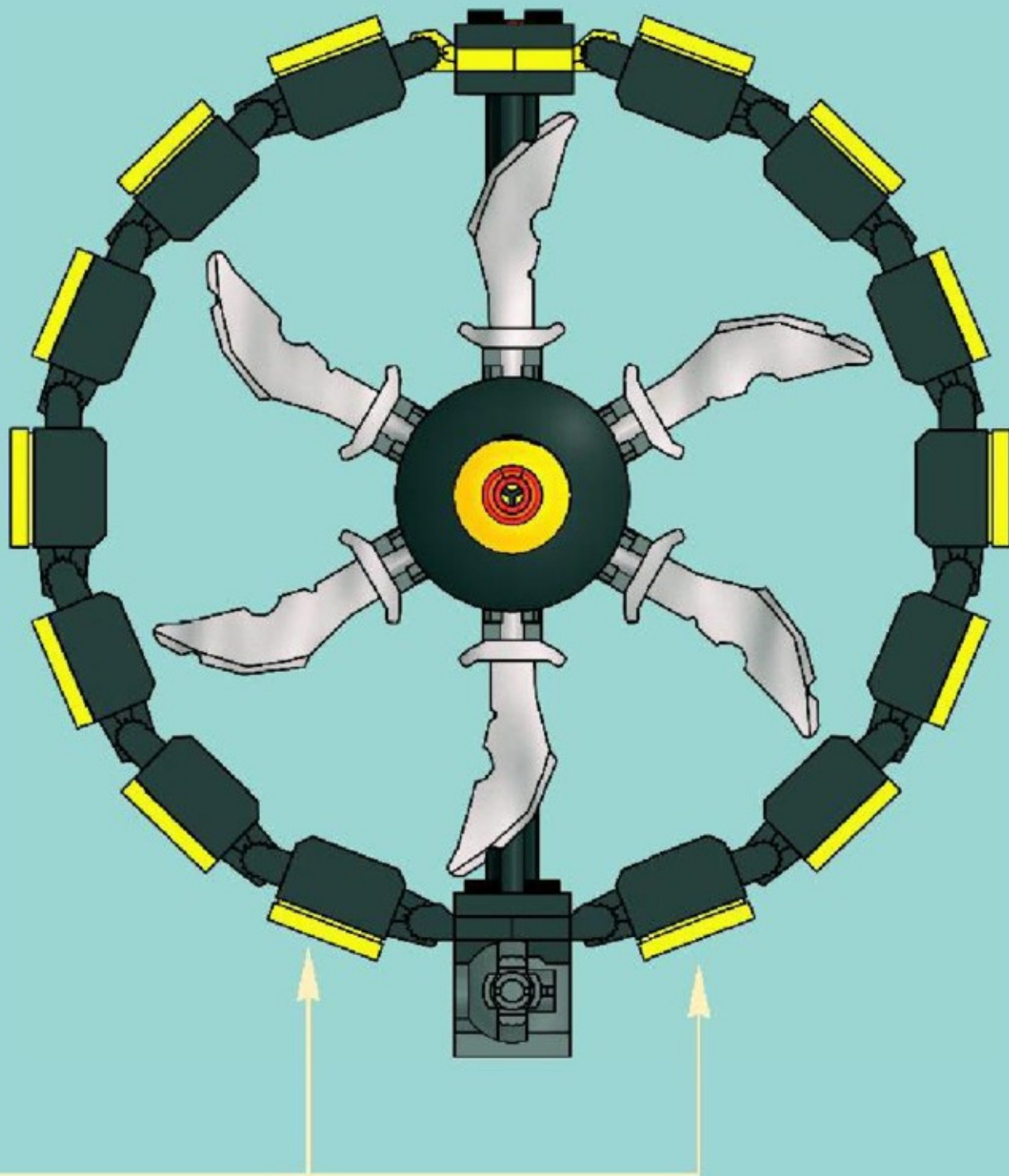

2x

34

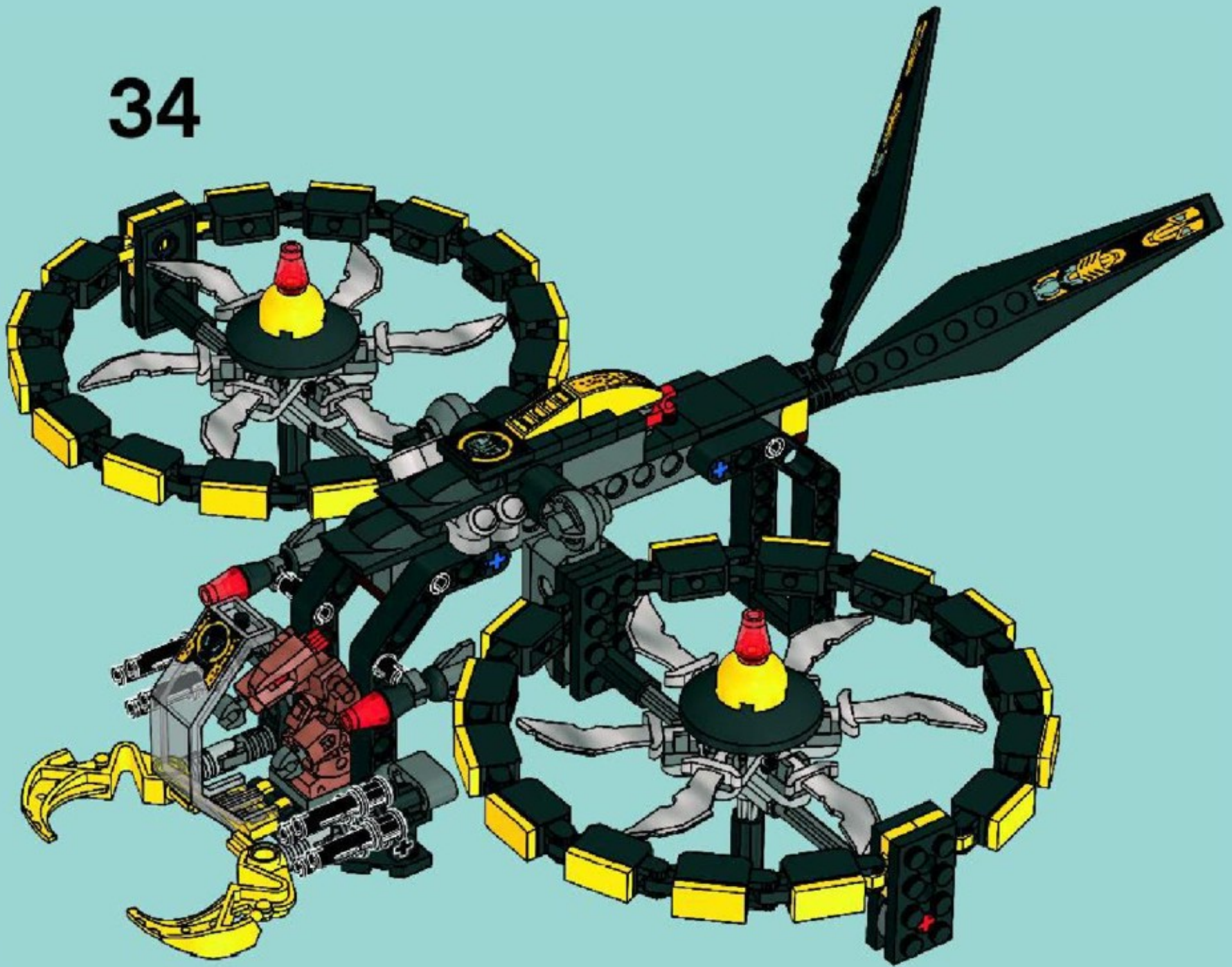



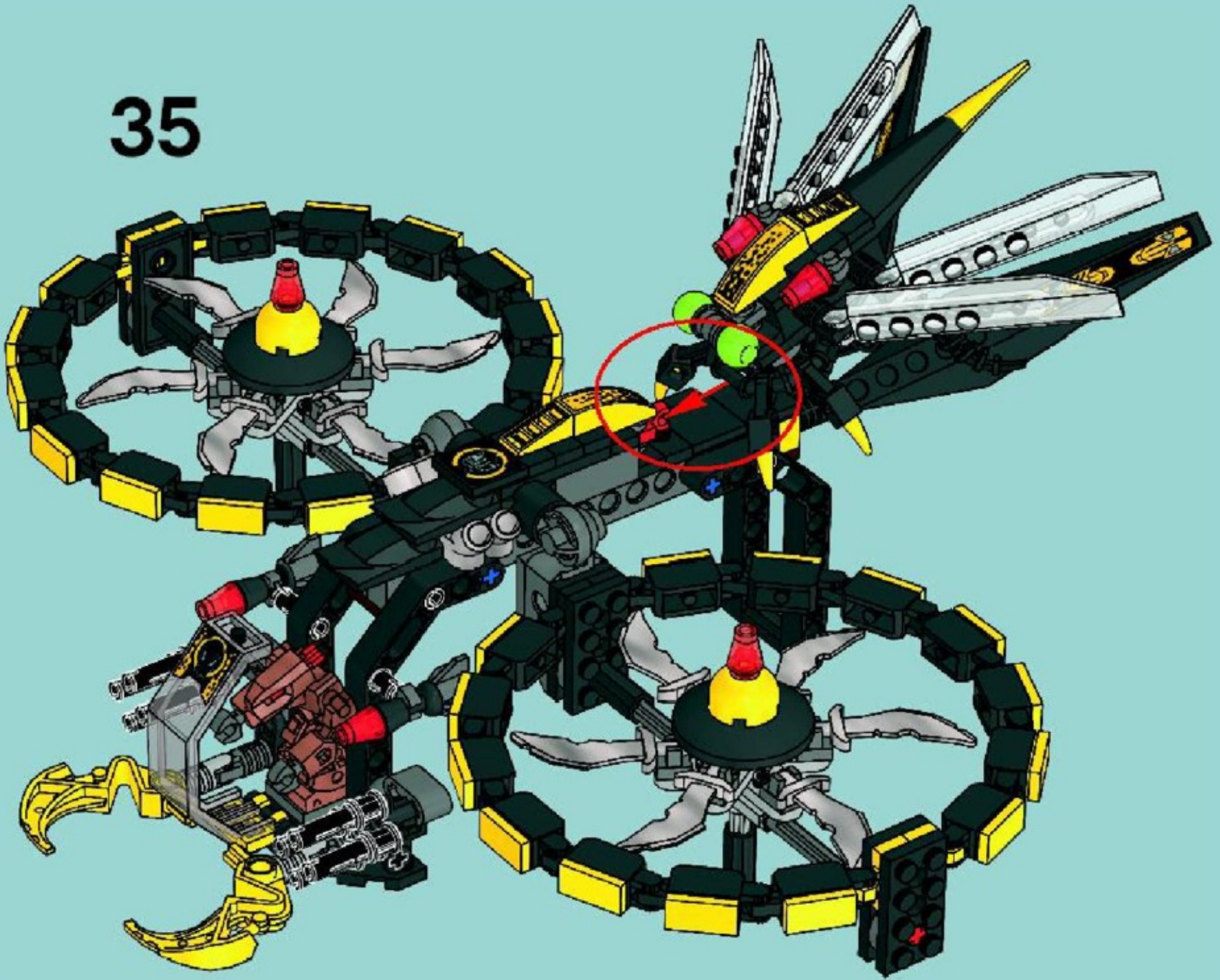



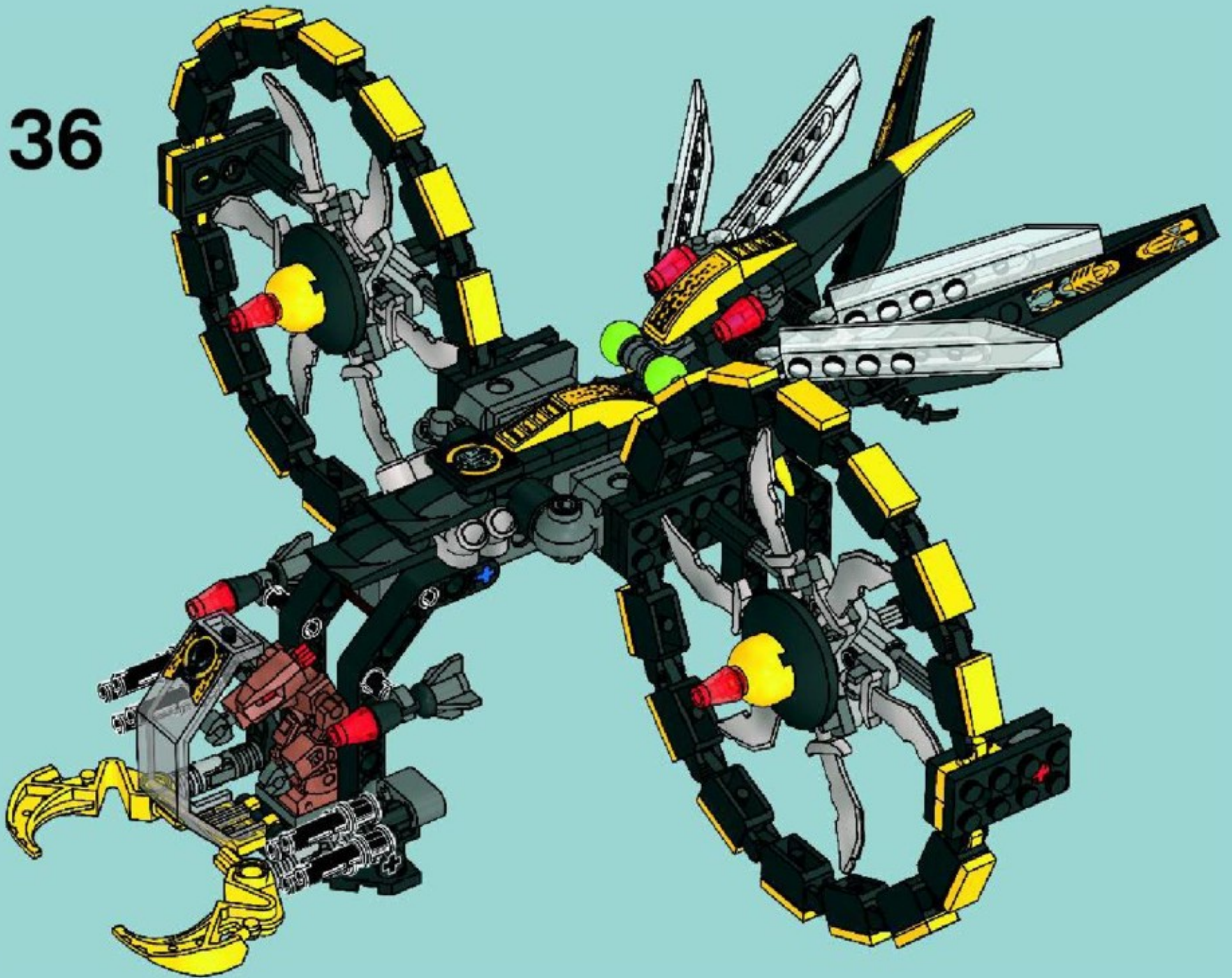



























































35



36



- | | | | | | |
|---|---|--|---|---|---|
| 
1x
4501020 | 
2x
4218656 | 
4x
4111998 | 
11x
379426 | 
2x
4222047 | 
6x
4211042 |
| 
2x
4291056 | 
26x
306924 | 
2x
4503884 | 
1x
4225201 | 
4x
4262978 | 
3x
4211043 |
| 
2x
4291054 | 
4x
4521048 | 
1x
4521166 | 
4x
4515340 | 
4x
4508553 | 
2x
4250885 |
| 
1x
4291057 | 
4x
4185617 | 
1x
4275826 | 
10x
370926 | 
2x
4210935 | 
1x
4210636 |
| 
4x
4218695 | 
1x
4515171 | 
8x
4121715 | 
2x
4285883 | 
2x
4225975 | 
2x
4211000 |
| 
10x
4142865 | 
2x
4521167 | 
1x
241926 | 
2x
396026 | 
1x
4211105 | 
6x
4210633 |
| 
1x
601921 | 
2x
4522705 | 
1x
370626 | 
6x
4159335 | 
2x
4289258 | 
2x
4211137 |
| 
6x
618841 | 
6x
4140801 | 
7x
4512363 | 
2x
4288838 | 
2x
4210694 | 
4x
4522776 |
| 
4x
4206482 | 
2x
4159103 | 
2x
4223189 | 
2x
4290718 | 
2x
4522784 | 
2x
4518406 |
| 
1x
4201615 | 
6x
4294996 | 
3x
306826 | 
2x
4211567 | 
1x
4210828 | 
12x
4518474 |
| 
2x
4247771 | 
26x
4167106 | 
2x
4119328 | 
2x
4211639 | 
12x
4211069 | |
| | 
2x
370126 | 
1x
4514342 | | | |

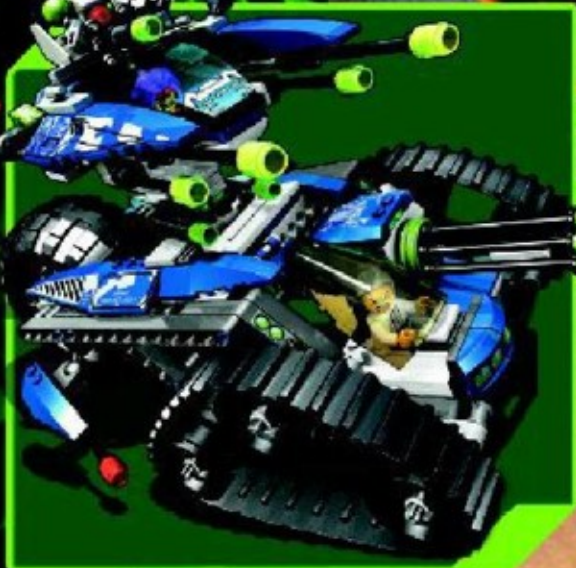

グッシュブタイ

ゴッドキング





Customer Service
Kundenservice
Service Consommateurs
Servicio Al Consumidor

www.lego.com/service or dial

 : 00800 5346 5555

 : 1-800-422-5346



club™



FREE LEGO Magazine • GRATUIT • GRATIS LEGO Magazin

Join Today!

**Abonne-toi
dès aujourd'hui!**

Meld je nu aan!

Jetzt anmelden!



US & Canada only

1-866-534-6258 / 1-877-518-5346

(in France)



00800 5346 5555

www.LEGOclub.com

**VISIT THE WORLD'S
BIGGEST LEGO® SHOP!**

www.LEGOshop.com



YES! I want to join the LEGO® Club FREE!

OUI ! Je veux m'abonner au Club LEGO® GRATUITEMENT !

Ja! Ich möchte Mitglied im kostenlosen LEGO Club werden.

Ja! Ik wil graag GRATIS lid worden van de LEGO Club.

First Name
Prénom
Vorname
Voornaam

Last name
Nom de famille
Familienam
Achter naam

Date of Birth
Date de naissance
Geburtsdag
geboortedatum

Boy
Garçon
Junge
Jongen

Girl
Fille
Mädchen
Meisje

Street, No.
Rue
Strasse, Hausnr.
straat, huisnr.

City/County
Ville
Stadt
Woonplaats

State
Prov.

Zip/Postcode
code Postal
PLZ
Postcode

Country
Pays
Land

Email

Parent's signature
Signature d'un parent
Unterschrift Erziehungsberechtigter
Handtekening ouders

The English version of the magazine can only be mailed to addresses in the US, Canada, the UK, and Republic of Ireland. Club membership is valid for 2 years and includes free copies of the LEGO Magazine. In the US and Canada please allow up to 6 weeks for delivery of your first magazine. By signing this form you consent the LEGO Club to use your child's data for LEGO mailings. The data will only be used for LEGO mailings and will not be sold, rented or otherwise disclosed to any company outside the LEGO Company except for disclosure to companies acting as our agents to help us provide services requested by the child. This coupon good for one free membership per person, group or organization. If you would not like to receive other communication from the LEGO company please tick here: . The version Française de magazine peut être postée uniquement au Canada. L'abonnement est valide pour 2 ans et inclut des exemplaires gratuits du Magazine LEGO. Aux É.-U. et au Canada, allowez 6 semaines pour la livraison initiale. En remplissant ce formulaire, vous consentez à ce que LEGO utilise les informations de votre enfant pour des envois postaux de LEGO. L'information sera utilisée uniquement pour des envois postaux par LEGO et ne sera en aucun cas, vendue, louée, échangée ou divulguée à d'autres compagnies autres que la compagnie LEGO, à l'exception des compagnies affiliées qui nous procurent des services auxquels l'enfant en a fait la demande. Das deutschsprachige Angebot gilt nur für die Länder D, A, U und CH. Die kostenlose Mitgliedschaft beinhaltet die Zusendung des LEGO Magazins und endet nach zwei Jahren. Für die Mitglieder entstehen keine Verpflichtungen. Es kann bis zu drei Monate dauern, bis das erste Magazin zugestellt wird. Mit Ihrer Unterschrift erklären Sie sich einverstanden, dass die Daten Ihres Kindes zum Zweck einer LEGO Club-Mitgliedschaft von der LEGO Gruppe gespeichert werden. Die Daten werden vertraulich behandelt und nicht an Dritte weitergegeben, außer an Dienstleister des LEGO Clubs. Wenn Sie später von LEGO Club keine weiteren Informationen von der LEGO Company bekommen möchten bitte hier ankreuzen: . Door dit formulier te tekenen geeft u de LEGO Club toestemming om bovenstaande gegevens te gebruiken voor het toezenden van LEGO mailings. Uw gegevens worden uitsluitend gebruikt voor mailings van LEGO en zullen niet worden verkocht, verhuurd of op welke wijze dan ook verspreid aan derden buiten de LEGO groep, uitgezonderd de organisaties die namens ons optreden om de service te verlenen waar uw kind om gevraagd heeft.



BG28

Mail to: / Poster à:
LEGO Club
P.O. Box 1157
Enfield, CT USA
06083-1157



B108U

Mail to:
LEGO Club
33 Bath Road
Slough SL1 3UF
United Kingdom



B108C

Per Post on:
LEGO® Club
Postfach 14 15
D-36243
Niederaula



www.acnielsen.aim.dk/LEGO



WIN LEGO® PRODUCTS

No purchase necessary.
Open to residents of all countries where
not prohibited.
Go to www.acnielsen.aim.dk/LEGO for official rules and details.

WIN LEGO® PRODUCTEN

Kopen niet nodig.
Open voor alle leeftijden, en in alle landen
waar geen verbod geldt.
Ga naar www.acnielsen.aim.dk/LEGO voor officiële regels en details.

GEWINNE LEGO® PRODUKTE

Die Teilnahme am Gewinnspiel führt zu
keinerlei Kaufverpflichtungen.
Sie können in allen nicht ausgeschlossenen
Ländern teilnehmen.
Die offiziellen Regeln und nähere Informationen
finden Sie unter www.acnielsen.aim.dk/LEGO.

GAGNE DES PRODUITS LEGO®

Aucun achat n'est nécessaire.
Ouvert à tous les âges et aux résidents de
tous les pays, sauf en cas d'interdiction.
Rendez-vous sur www.acnielsen.aim.dk/LEGO pour obtenir plus
de détails et le règlement officiel.

レゴ®製品を「当てよう」

購入は不要です
禁止されていない限り、あらゆる
年代およびあらゆる国の居住者の
方々にご利用いただけます。
公認規則および詳細につきましては、
www.acnielsen.aim.dk/LEGOをご覧ください

