

The LEGO logo is displayed in its characteristic white font with a black outline, set against a red square background.The Harry Potter logo is written in a stylized, golden, gothic font with a lightning bolt through the letter 'P', set against a blue, glowing background.

⚠ WARNING: CHOKING HAZARD.
Toy contains small parts and a small ball.
Not for children under 3 years.

⚠ AVERTISSEMENT : RISQUE D'ÉTOUFFEMENT.
Le jouet contient des petites pièces ainsi qu'une petite boule.
Il ne convient pas aux enfants de moins de 3 ans.

⚠ ADVERTENCIA: PELIGRO DE ASFIXIA.
Juguete que contiene partes pequeñas y una pelota
pequeña. No recomendado para niños menores de 3 años.

4726

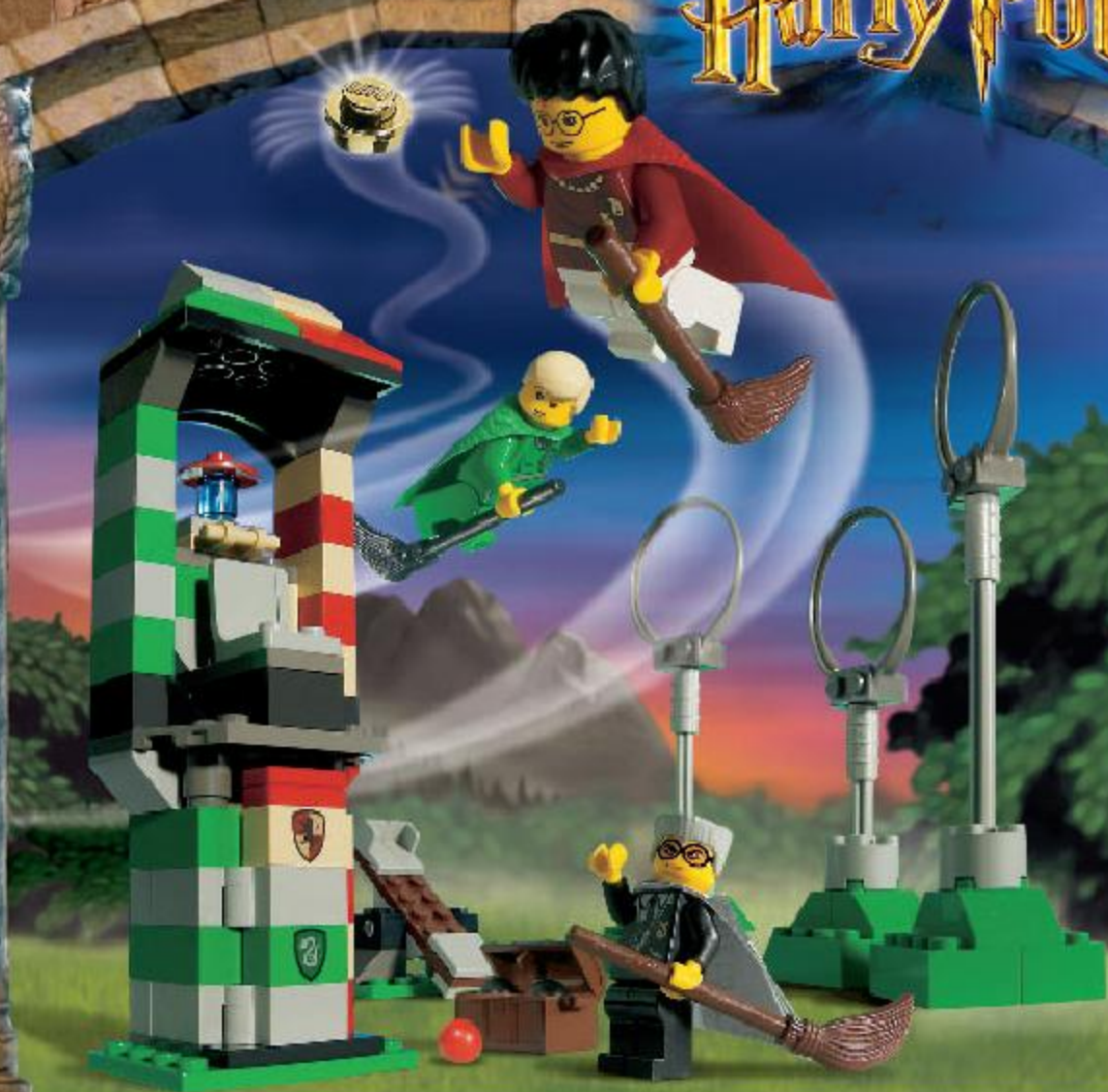

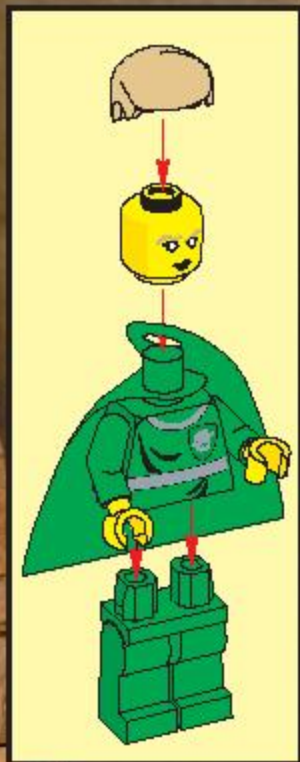

1

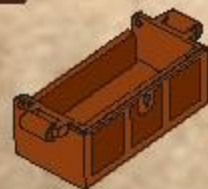

2

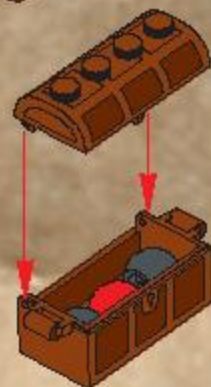

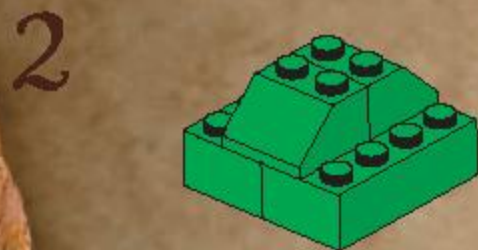
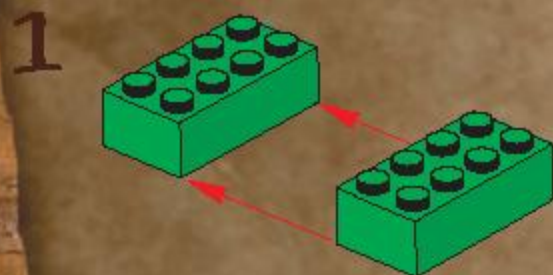
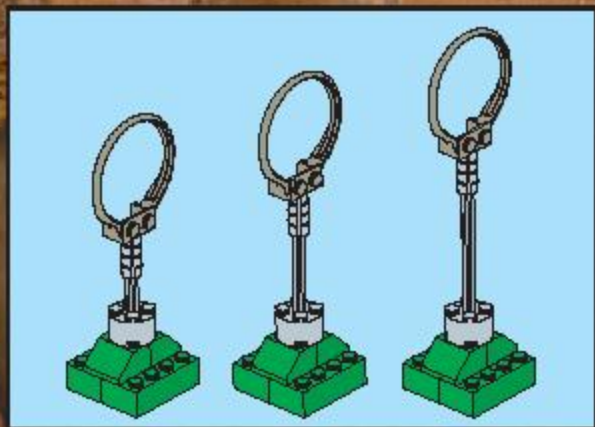

3

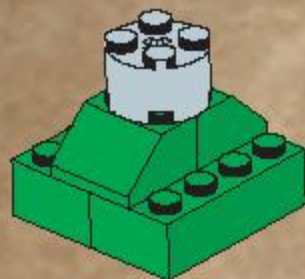

4

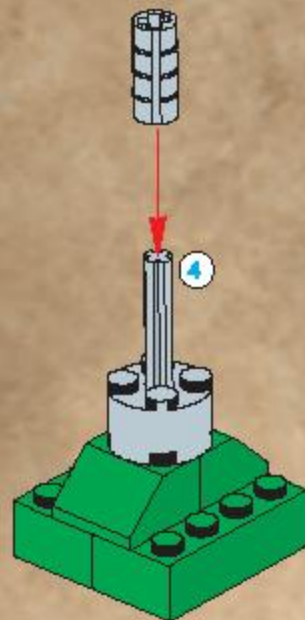

5

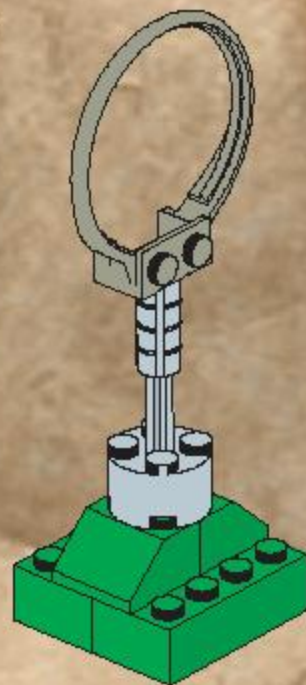

1

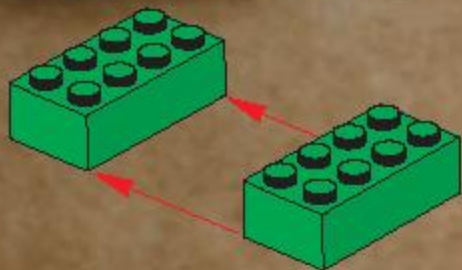

2

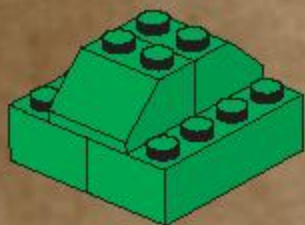

3

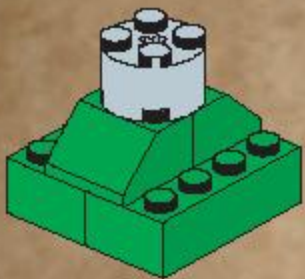

4

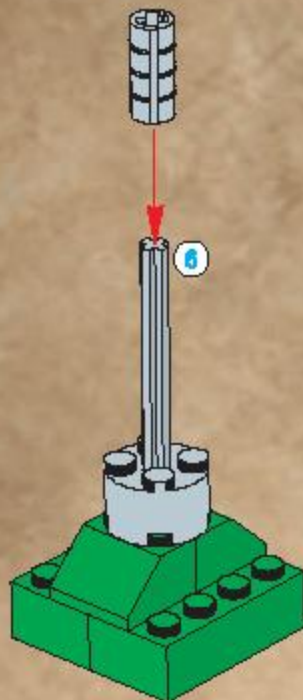

5

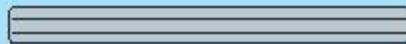
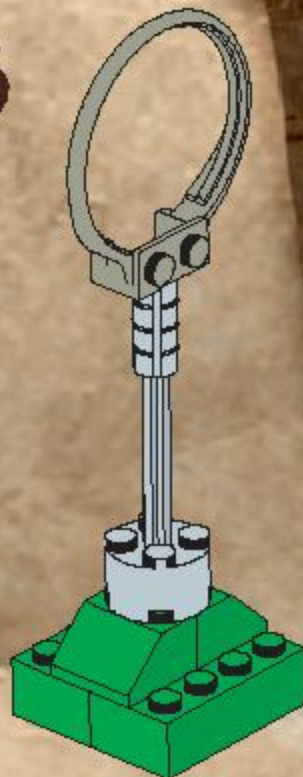

1:1

1

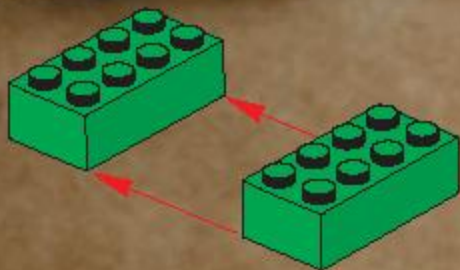

2

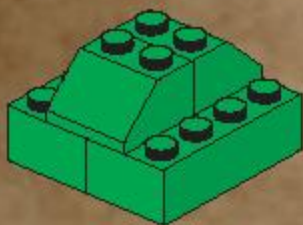

3

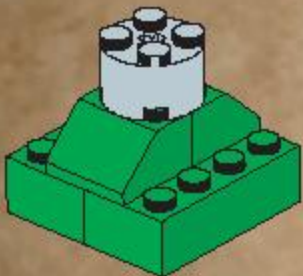

4



5

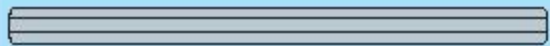
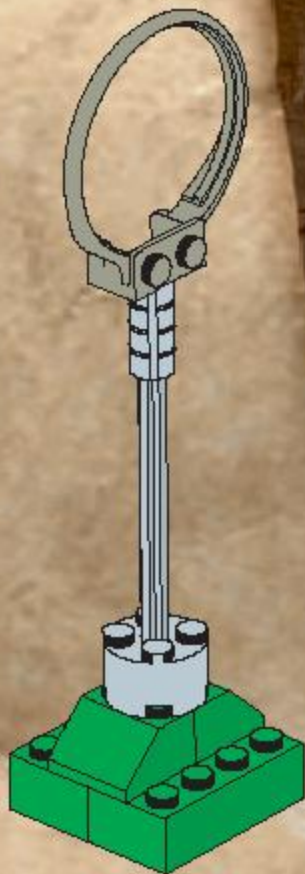

1:1

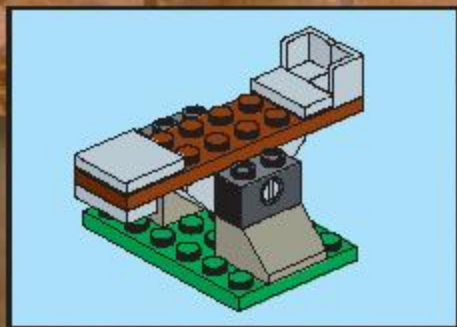

1



2

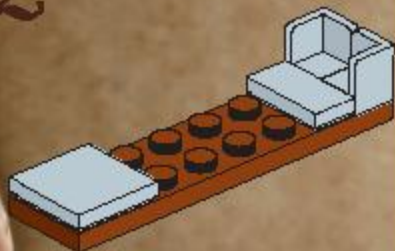

3

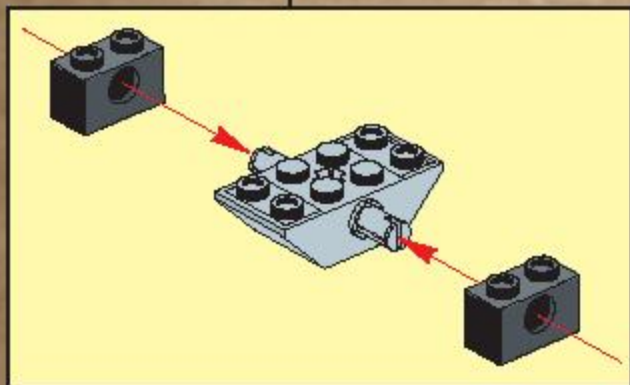
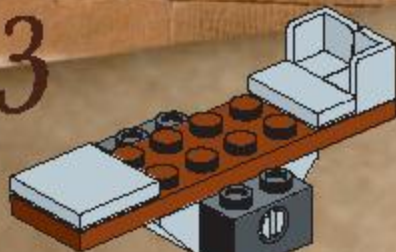

4

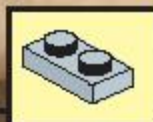
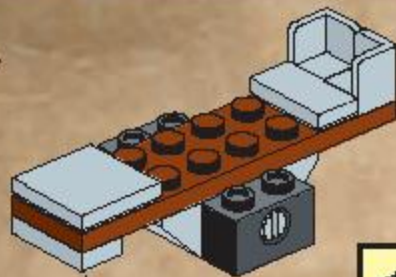

5

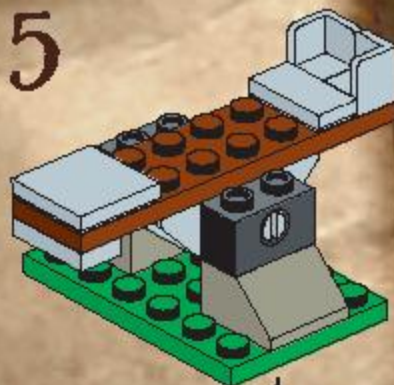

1

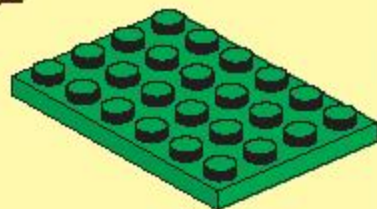

2

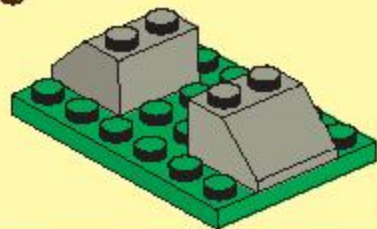

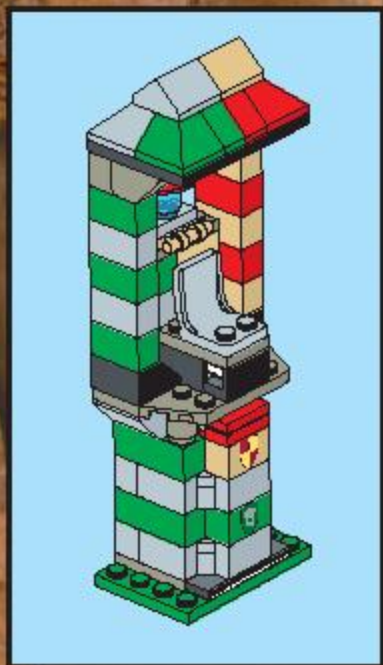

1

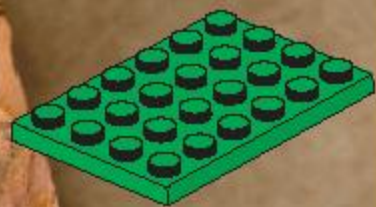

2

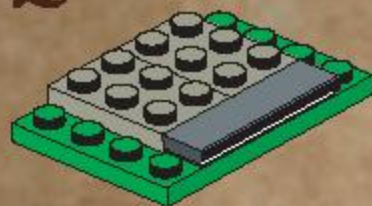

3

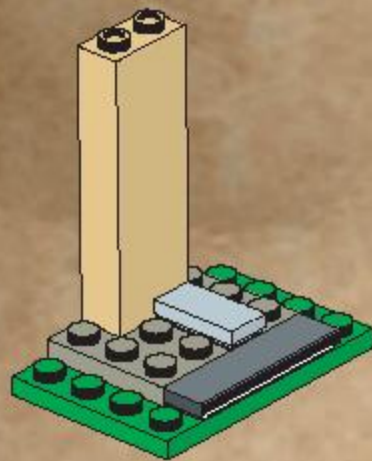

4

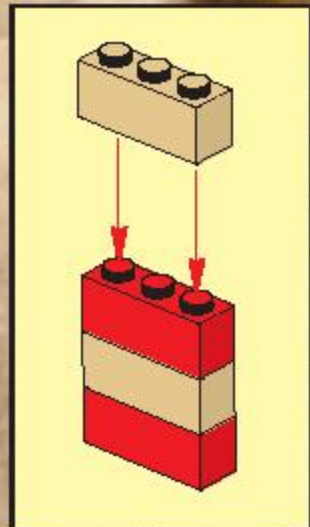
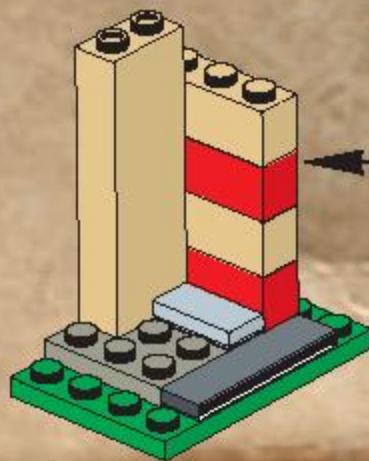

5

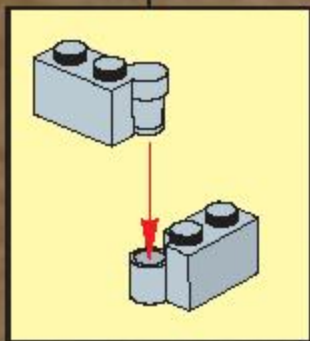
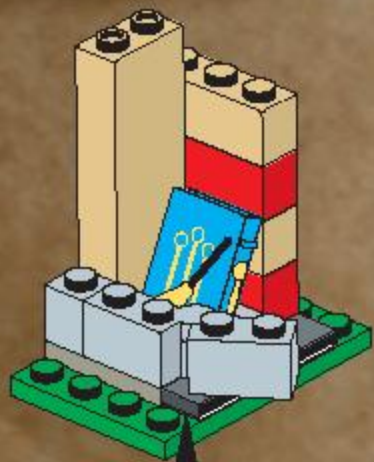

6

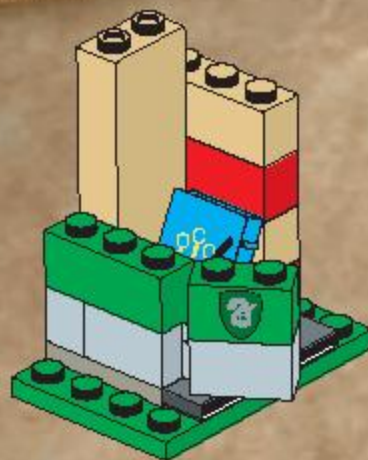

7

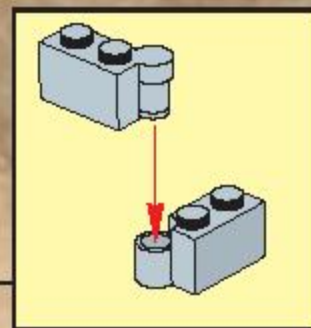
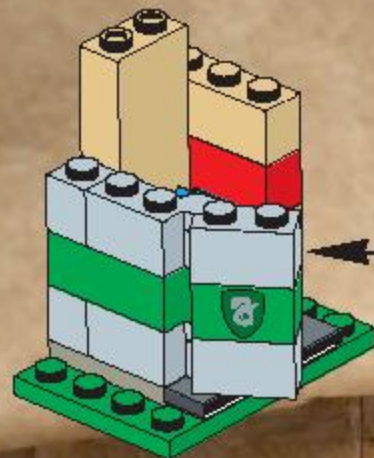

8

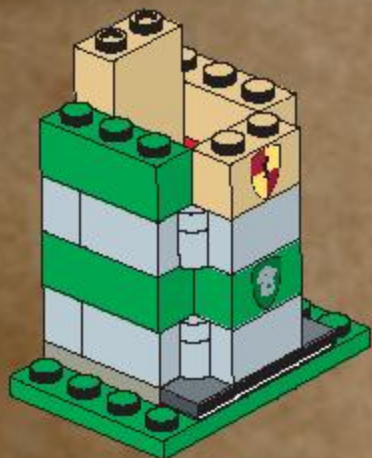

9

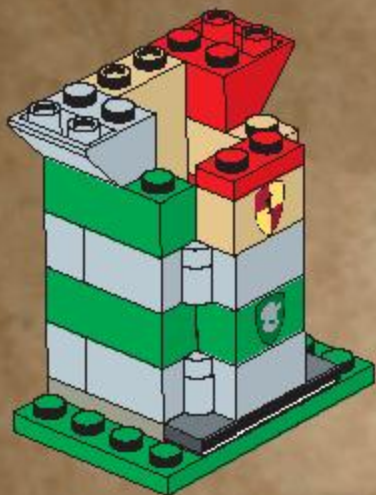

10

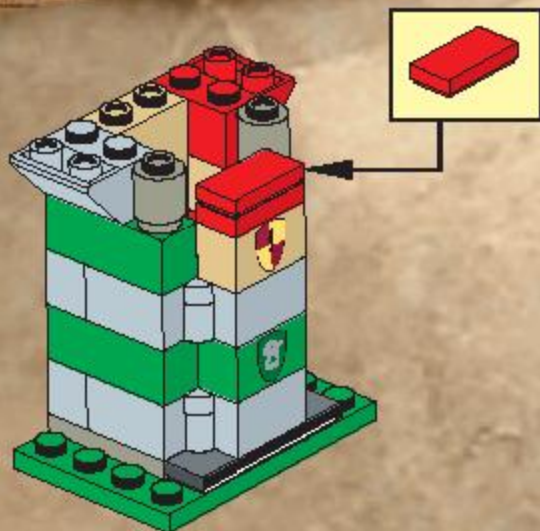

11

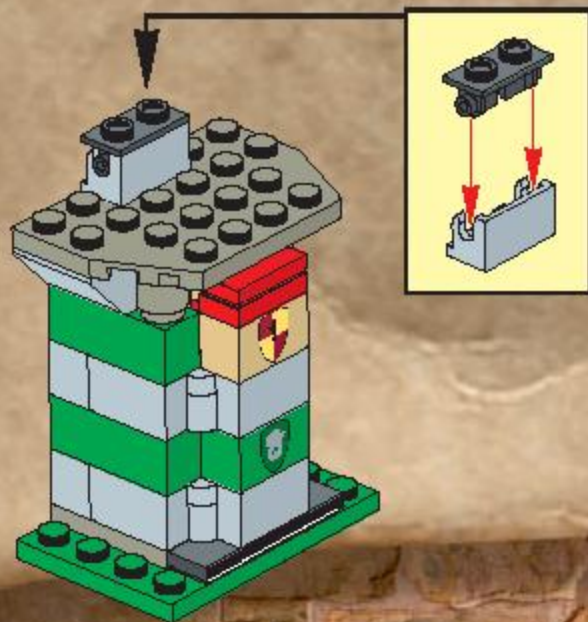

12

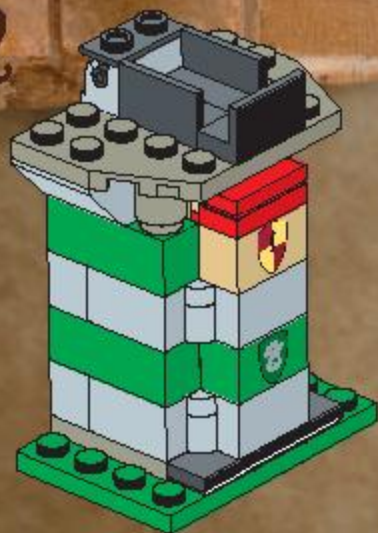

13

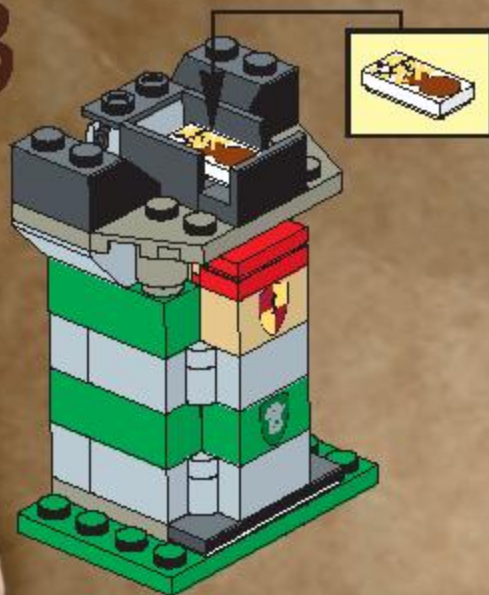

14

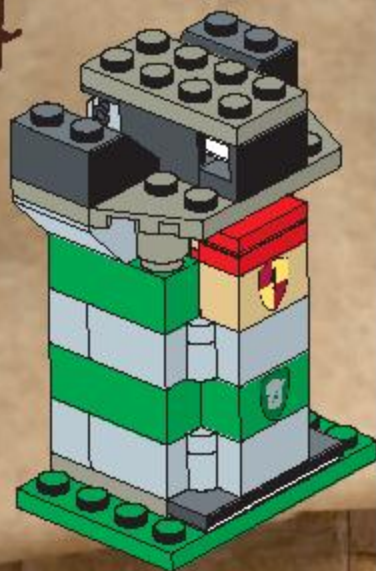

15

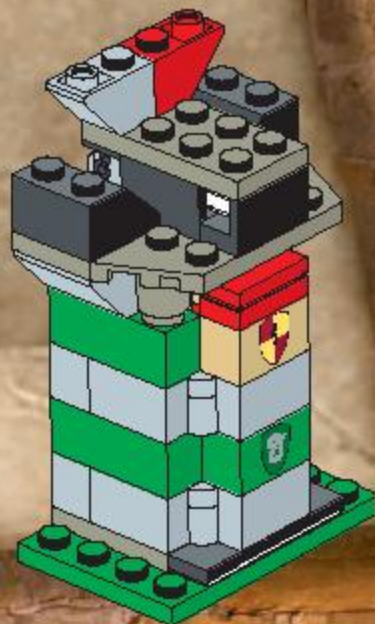

16

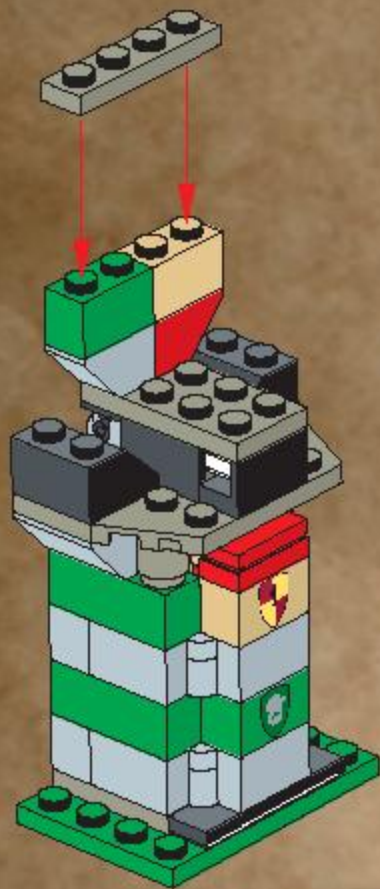

1



2



3



4



17

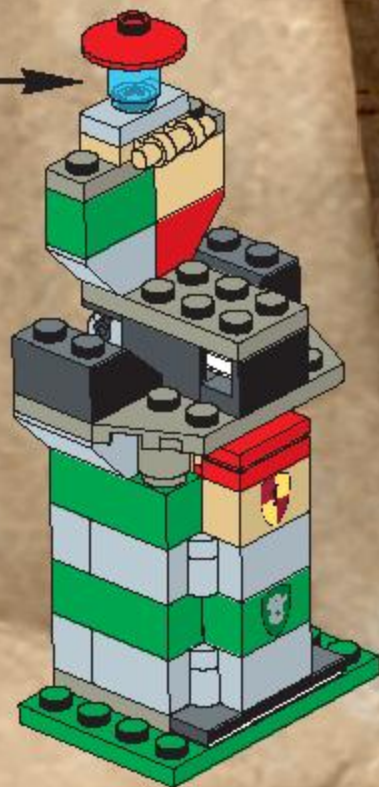

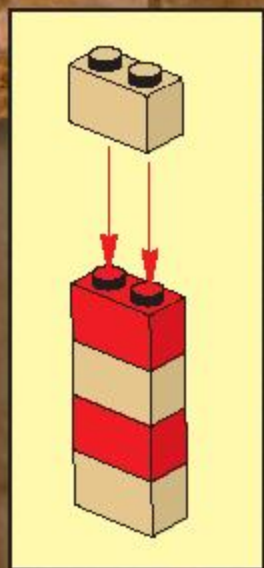

18

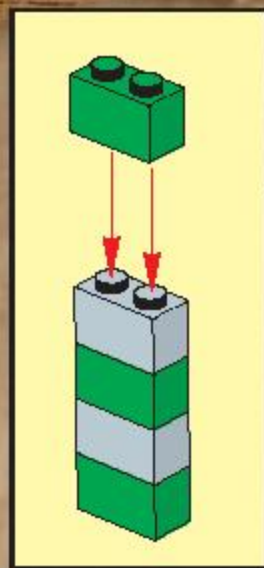
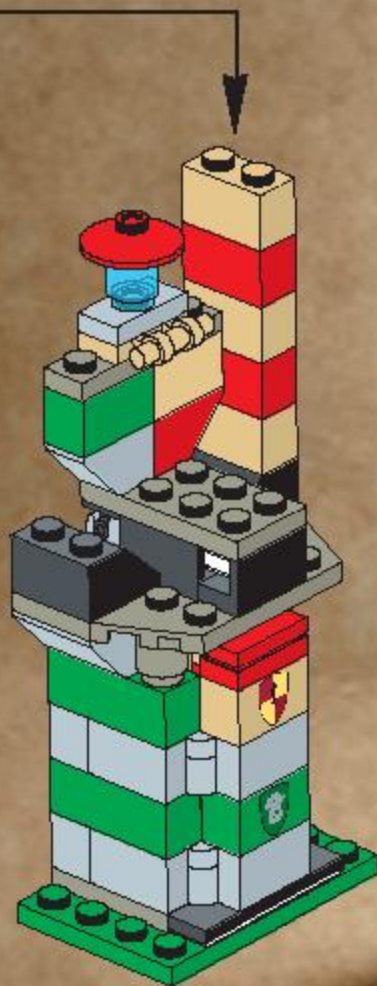

19

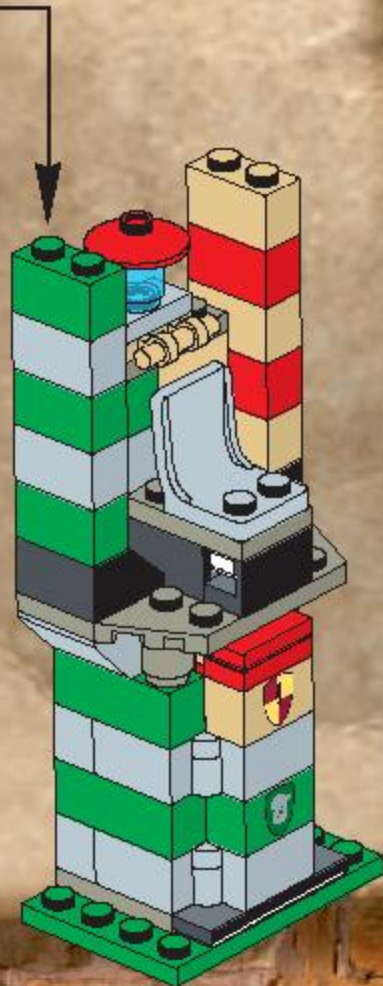

20

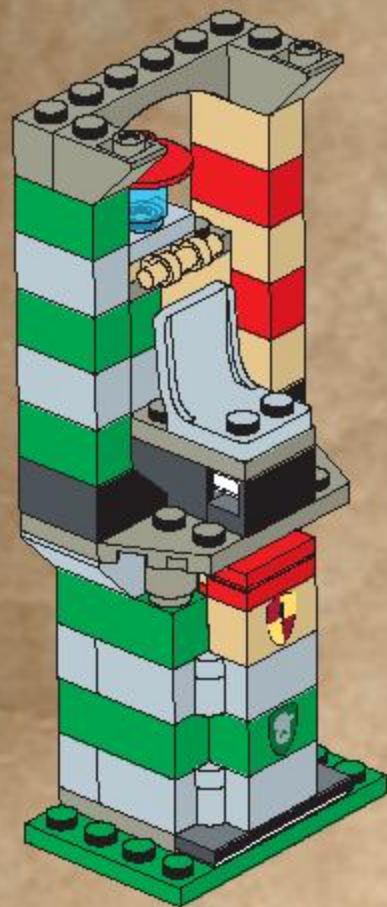

1

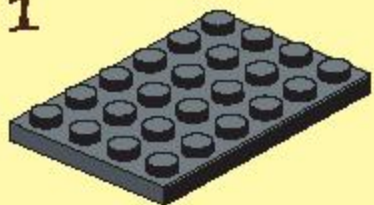

2

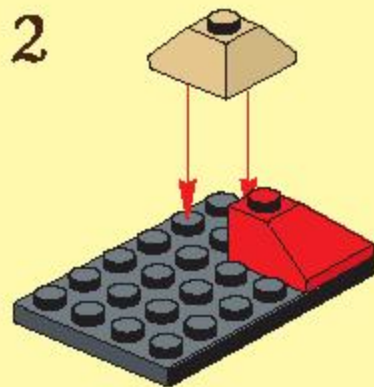

3

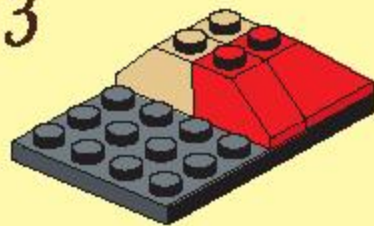

4

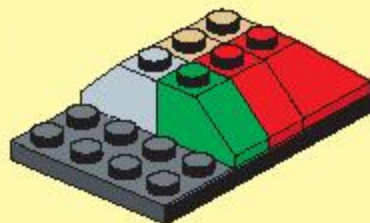

5

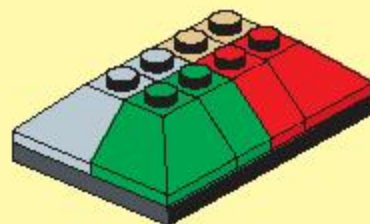

6

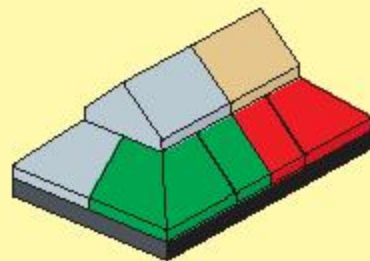

21

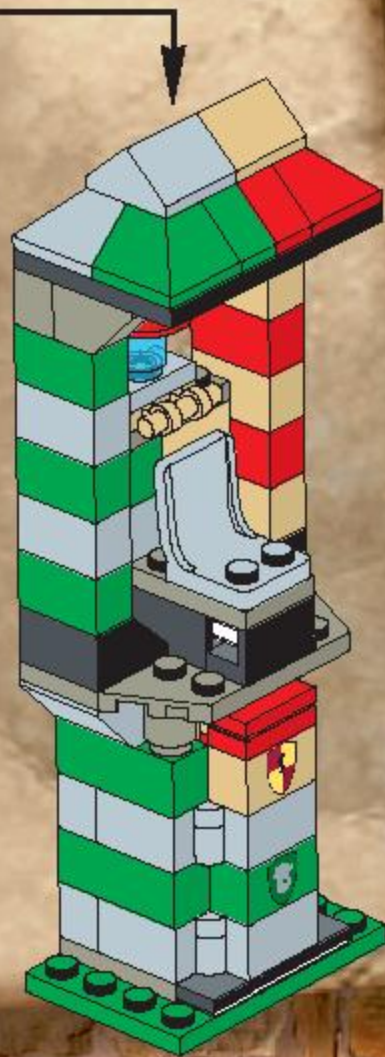



LEGO and the LEGO logo are trademarks of the LEGO Group.
©2002 The LEGO Group.

HARRY POTTER, characters, names and related indicia are trademarks of
and © Warner Bros.
Harry Potter Publishing Rights © J.K. Rowling.
[182]



LEGO and the LEGO logo are trademarks of the LEGO Group.
©2002 The LEGO Group.

HARRY POTTER, characters, names and related indicia are trademarks of and © Warner Bros.

WB SHIELD: TM & © Warner Bros.

Harry Potter Publishing Rights © J.K. Rowling

(02)

www.harrypotter.com

www.LEGO.com

JOIN THE FUN!