



40648





FR  
**DONNEZ**  
OU  
**RECYCLEZ**



OU



OU



ASSOCIATION    MAGASIN    DÉCHÈTERIE

Adresses sur [quefairedemesdechets.fr](http://quefairedemesdechets.fr)



[LEGO.com/sustainable-packaging](http://LEGO.com/sustainable-packaging)

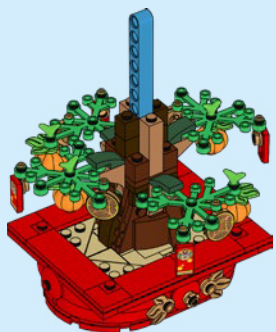
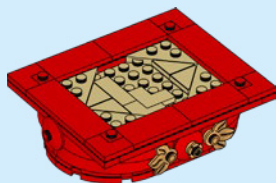

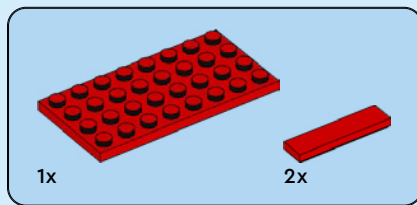

1

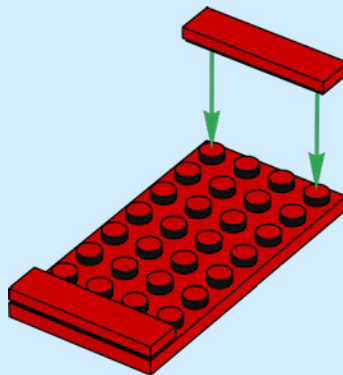



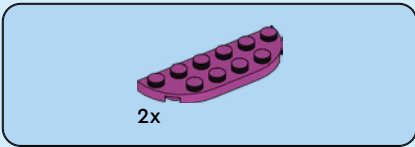

2

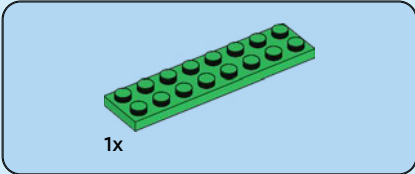
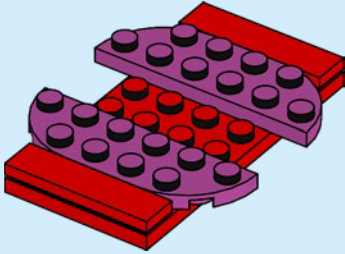

3

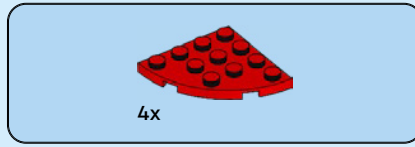
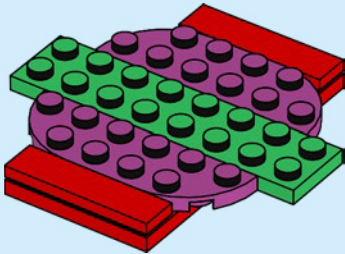

4

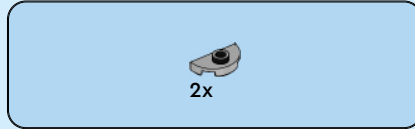
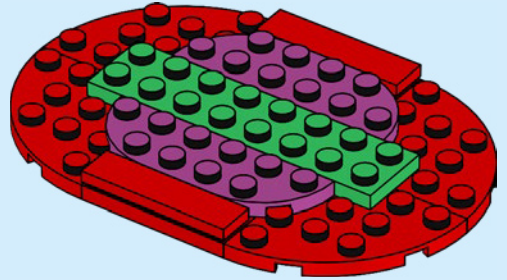

5

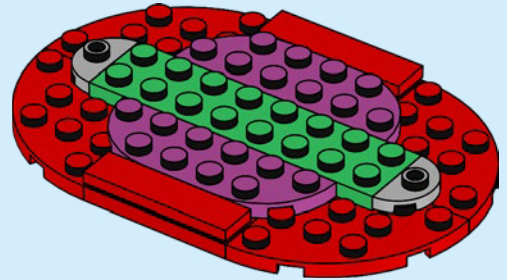



4x

6

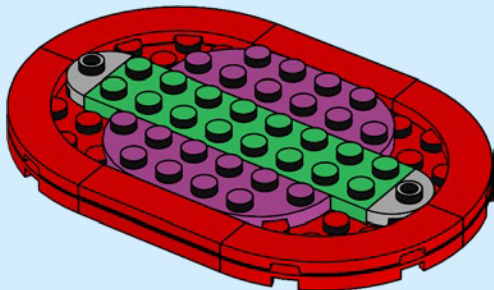

4x

7

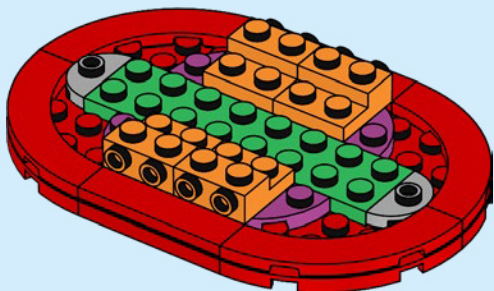

2x

8

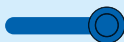
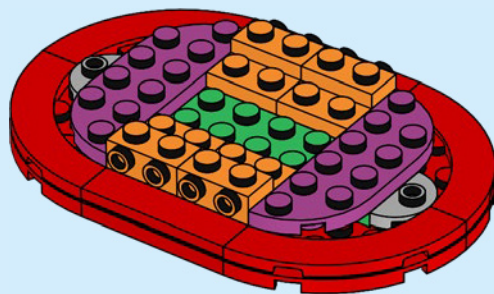



2x

9

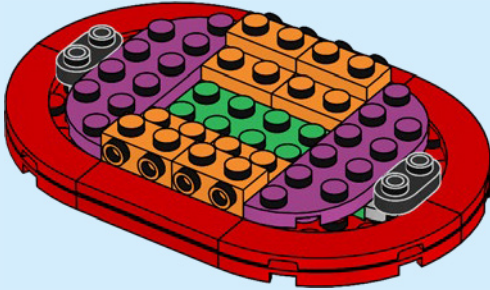

2x

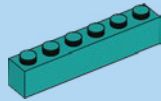

2x

10

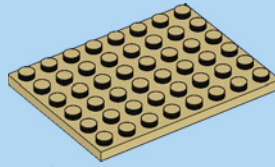
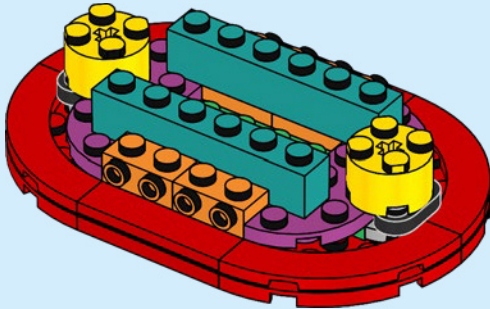

1x



2x

11

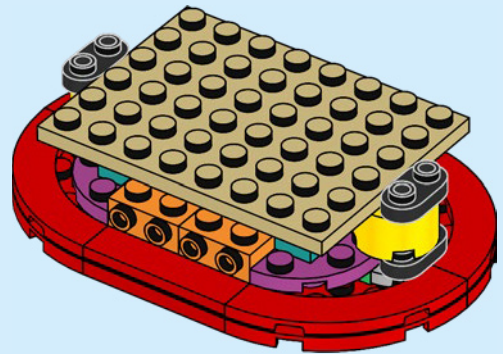

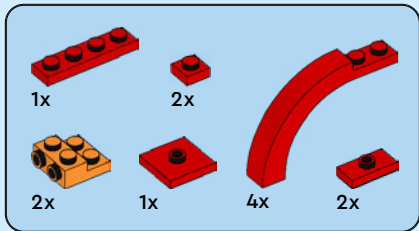

12

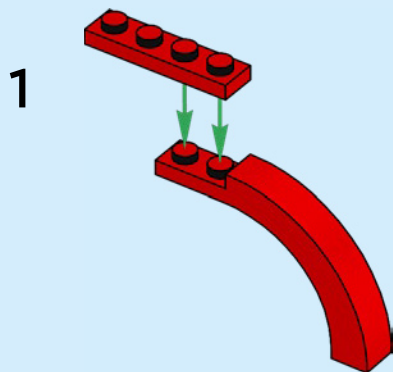

2

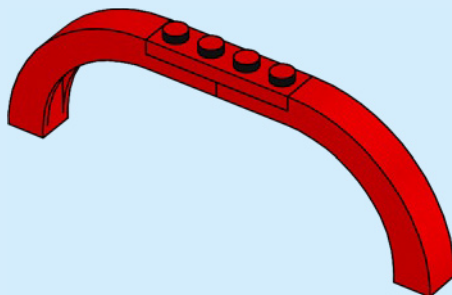

3

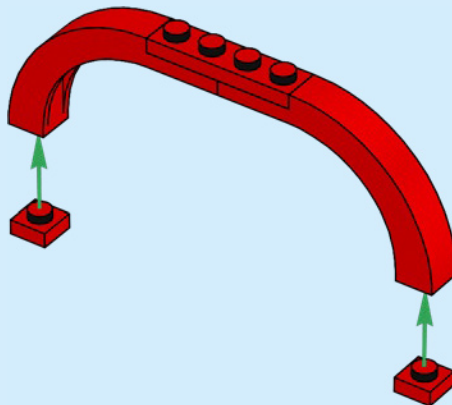



4

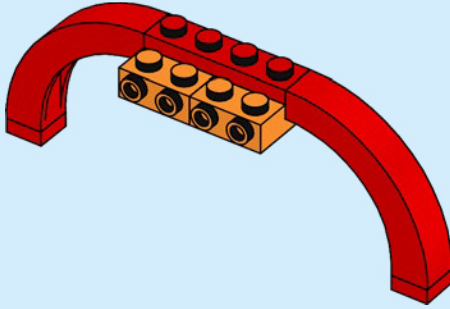

5

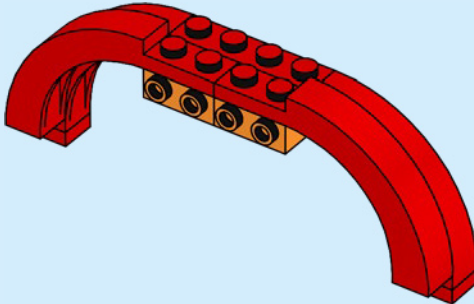

6

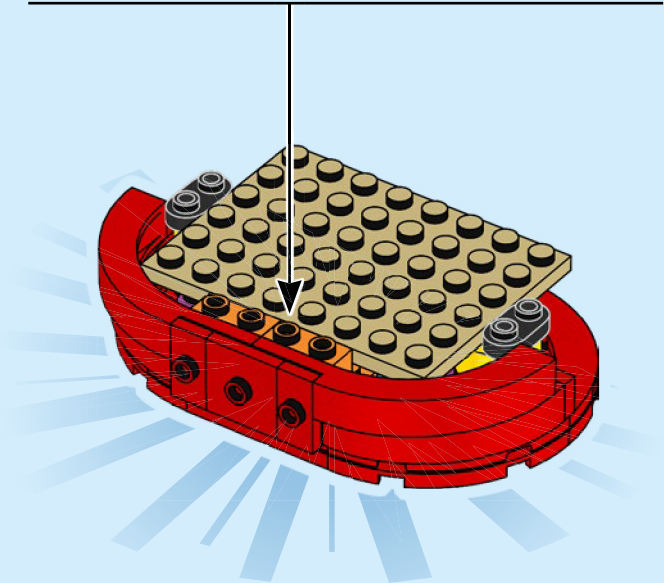
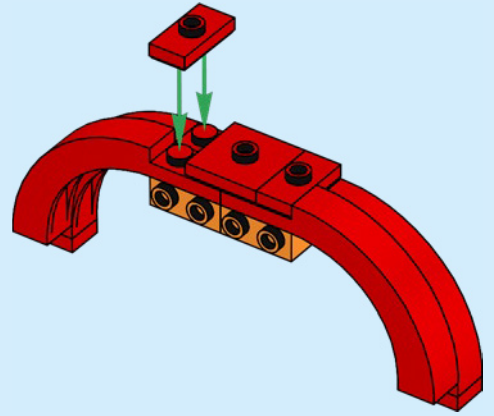

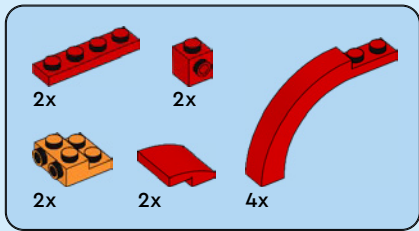

13

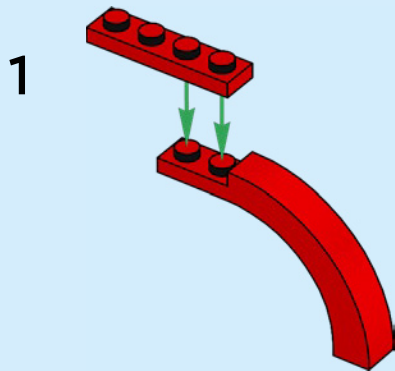

2

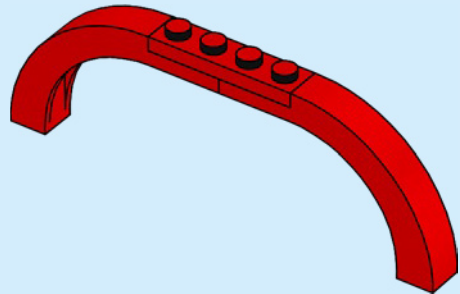

3

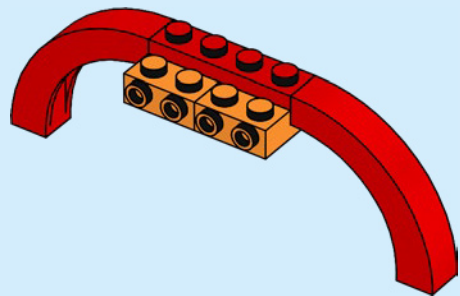

4

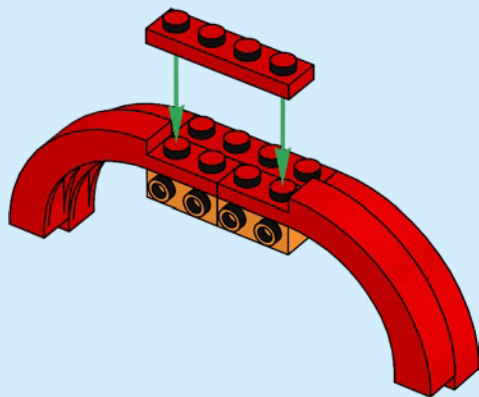

5

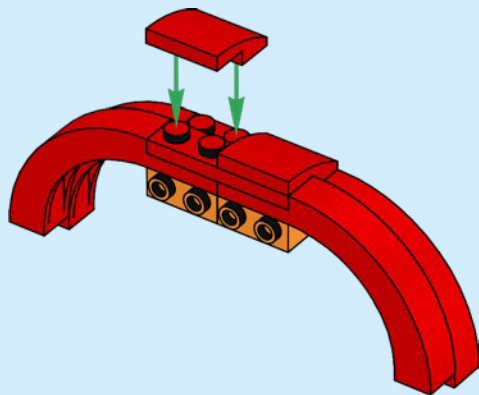

6

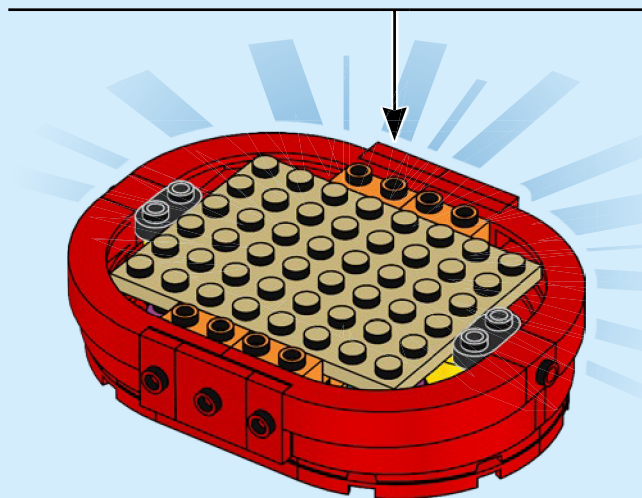
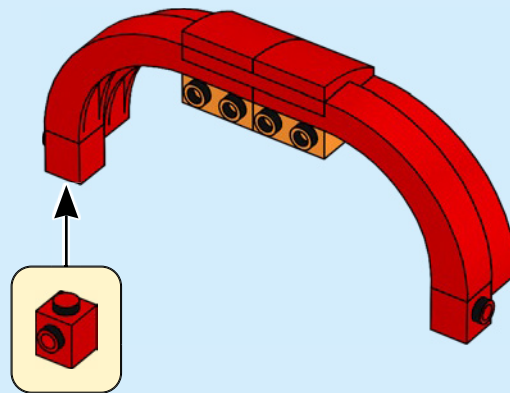

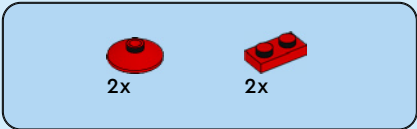

14

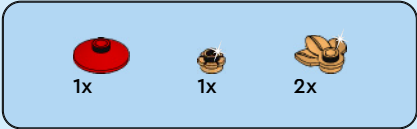
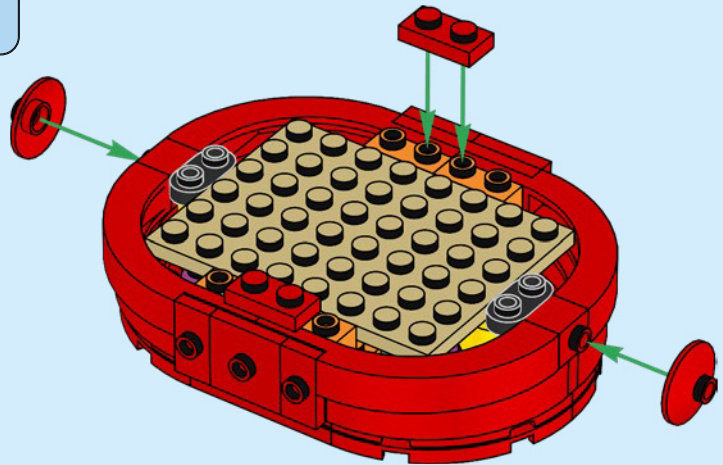

15

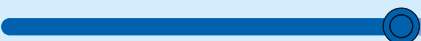
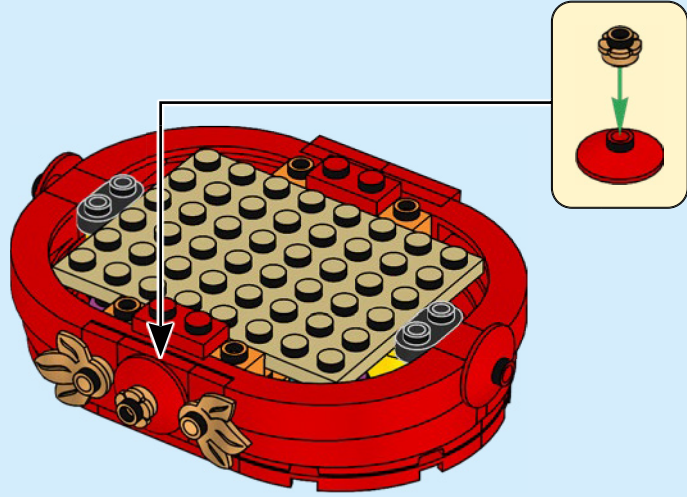



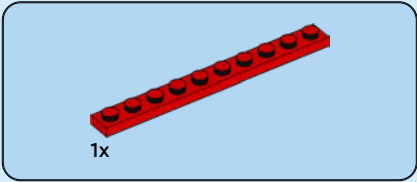
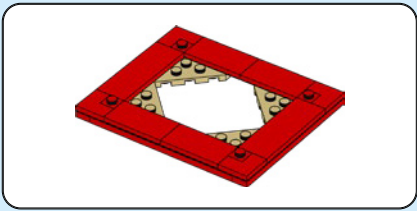

16

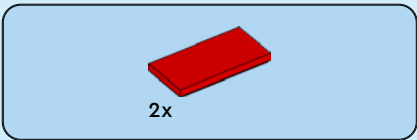
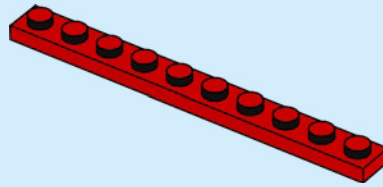

17

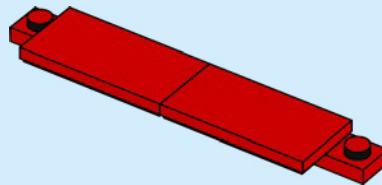

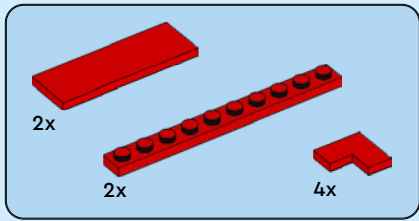

18

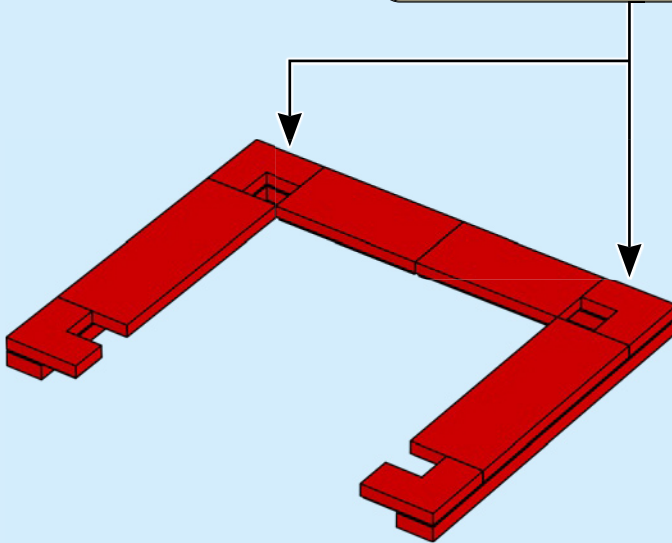
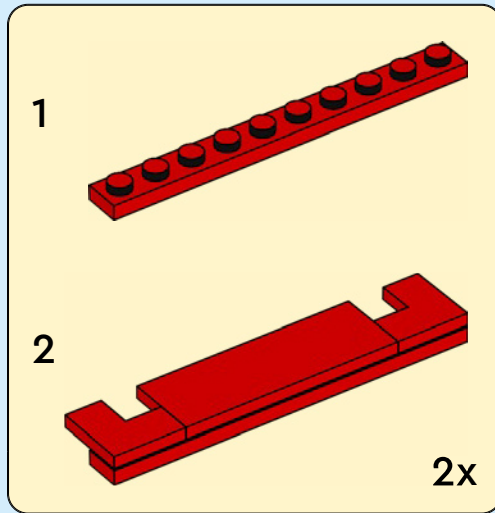

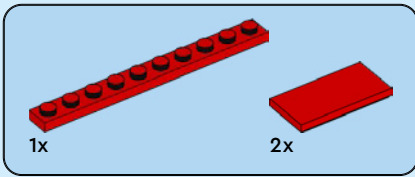

19

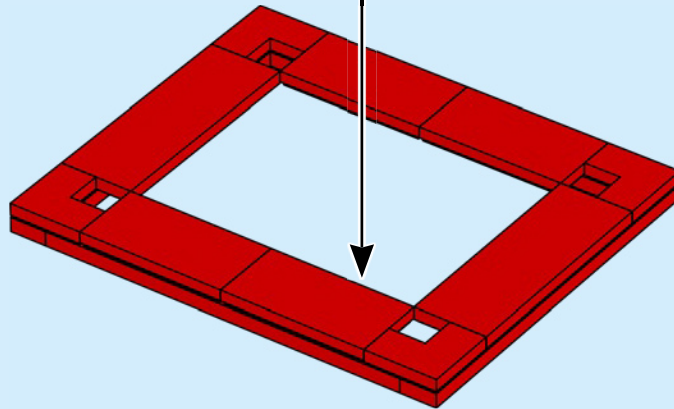
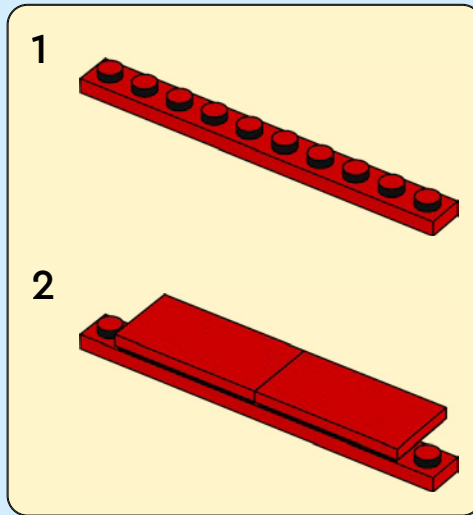

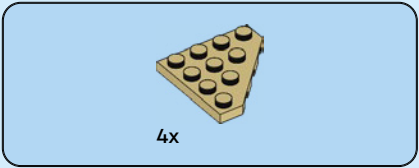

20

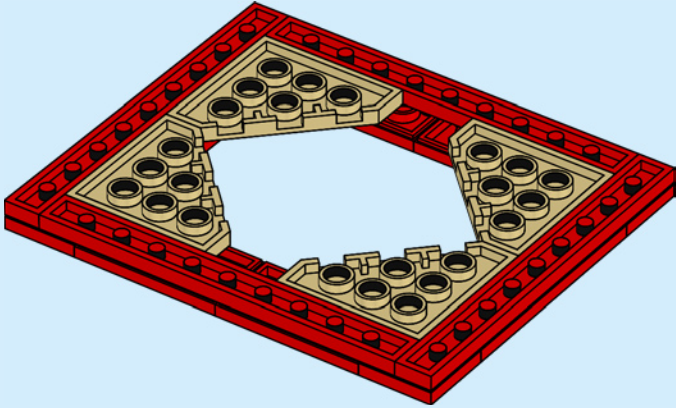

21

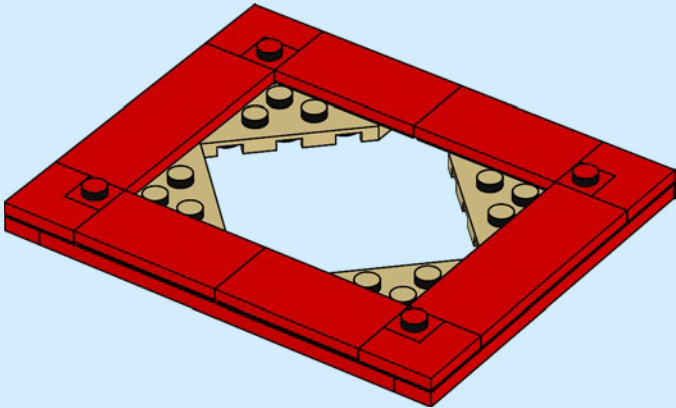



22

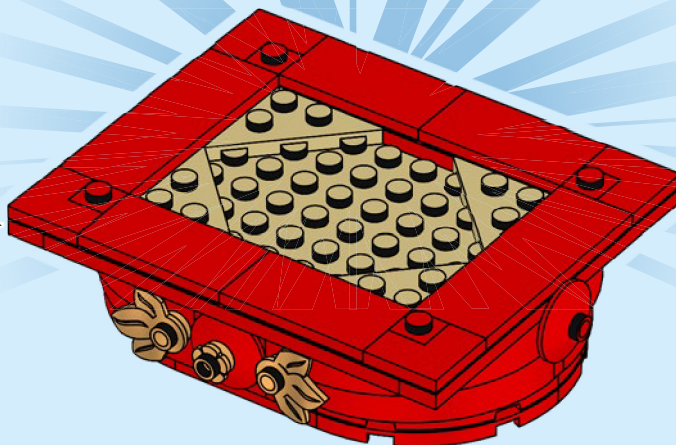

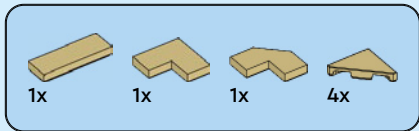

23

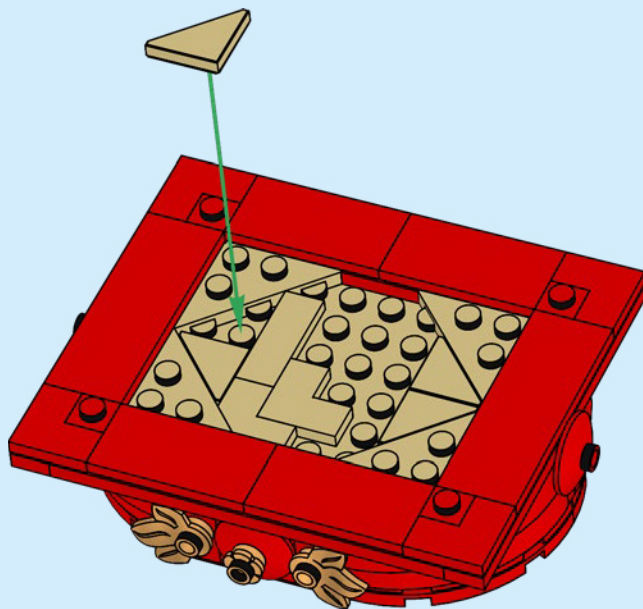

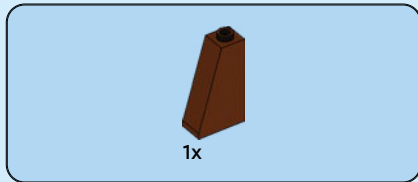
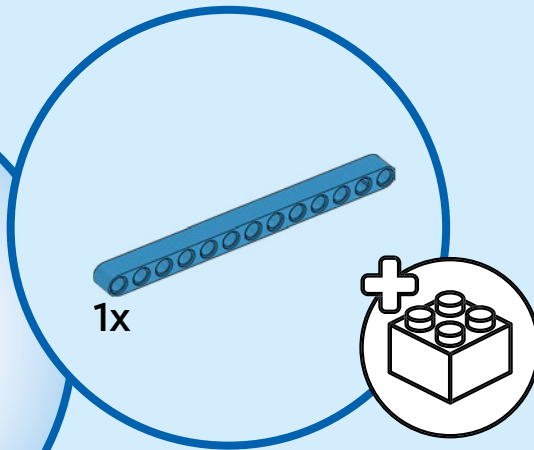

24

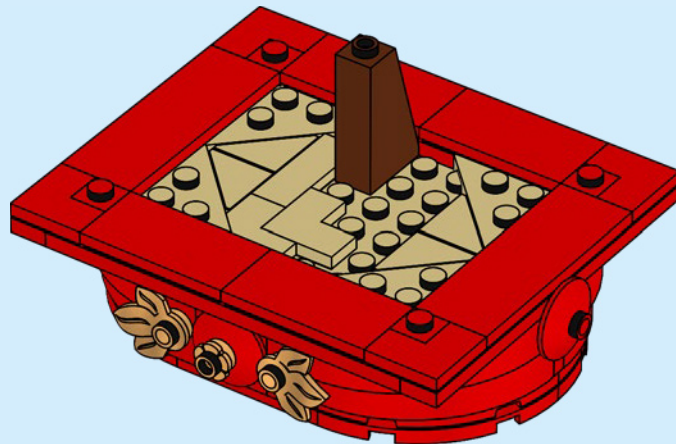

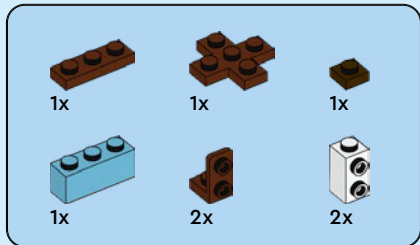

25

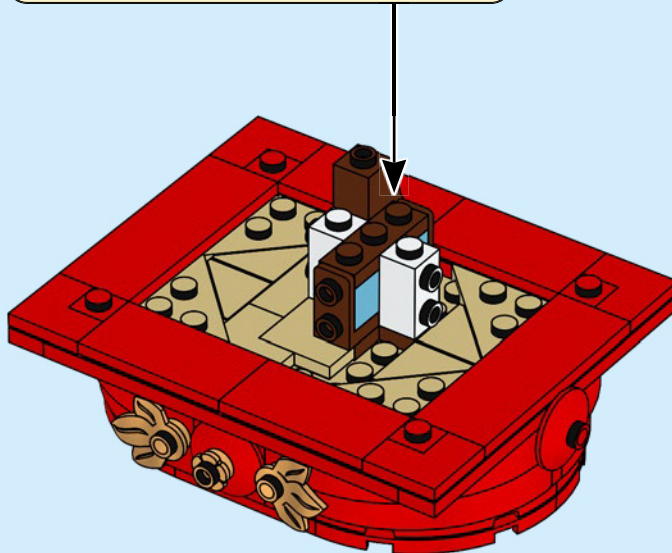
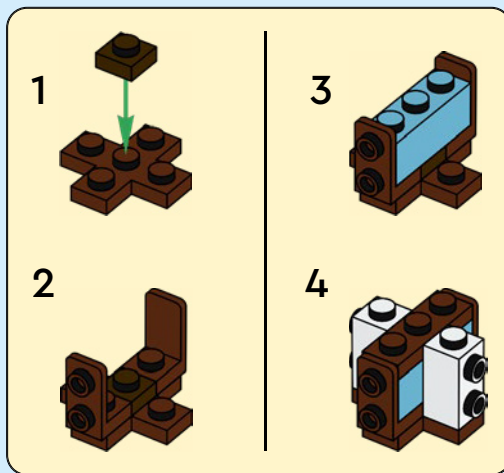



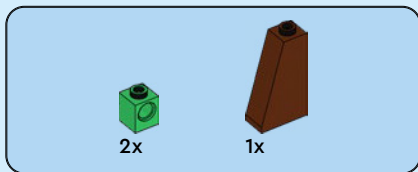

26

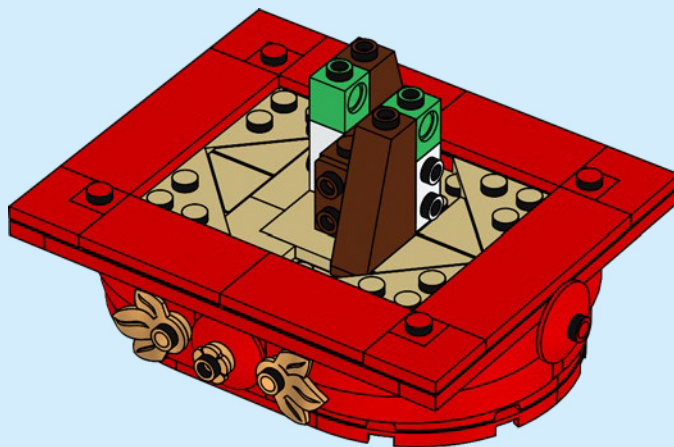

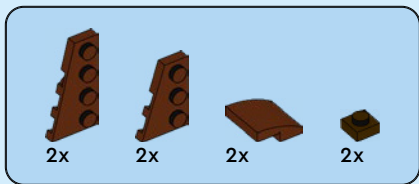

27

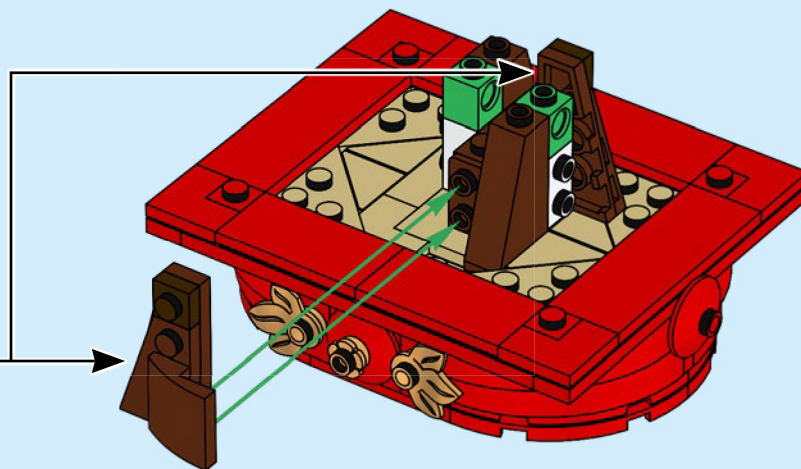
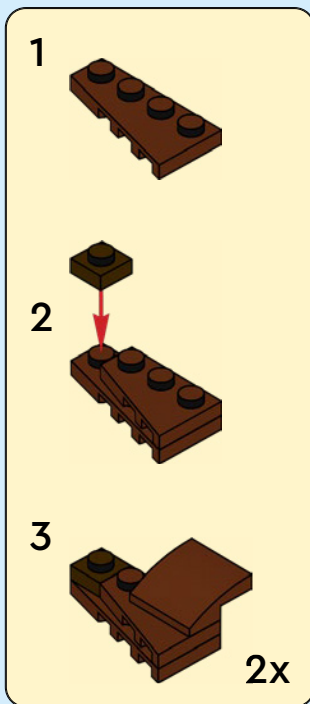



2x



1x



1x

28

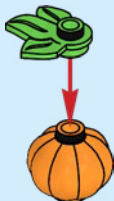

1x



1x

29

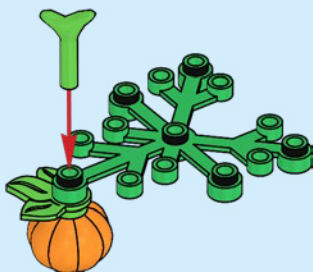

1x

30

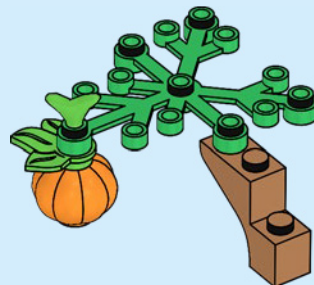

1x

31

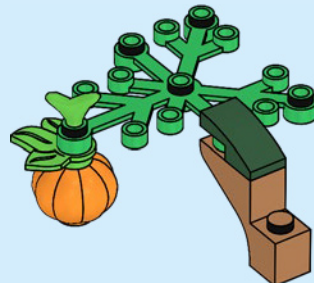



32

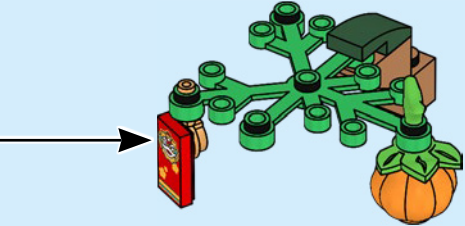

33

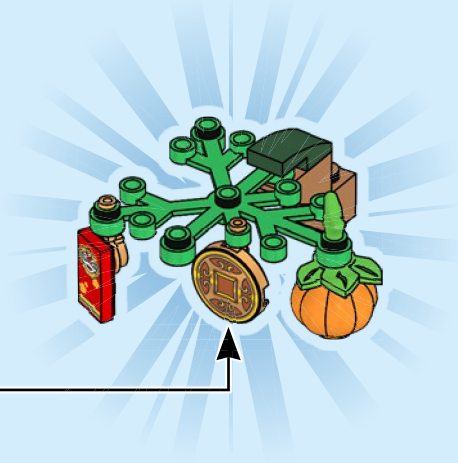
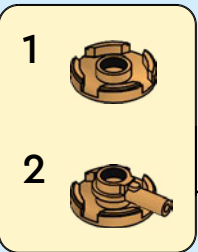

2x



34

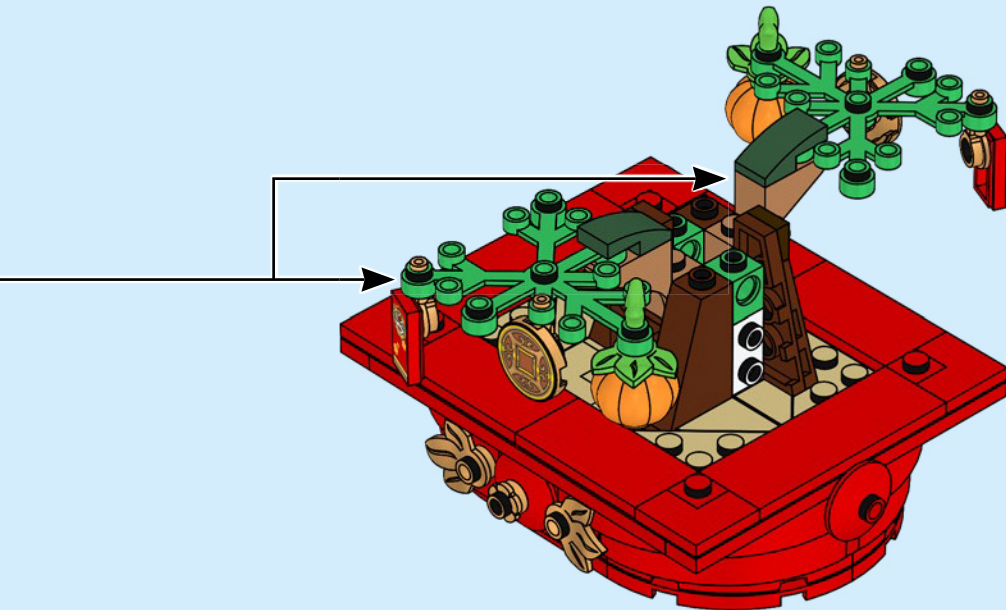

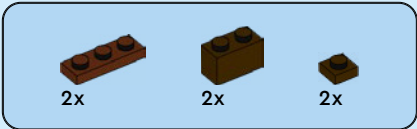

35

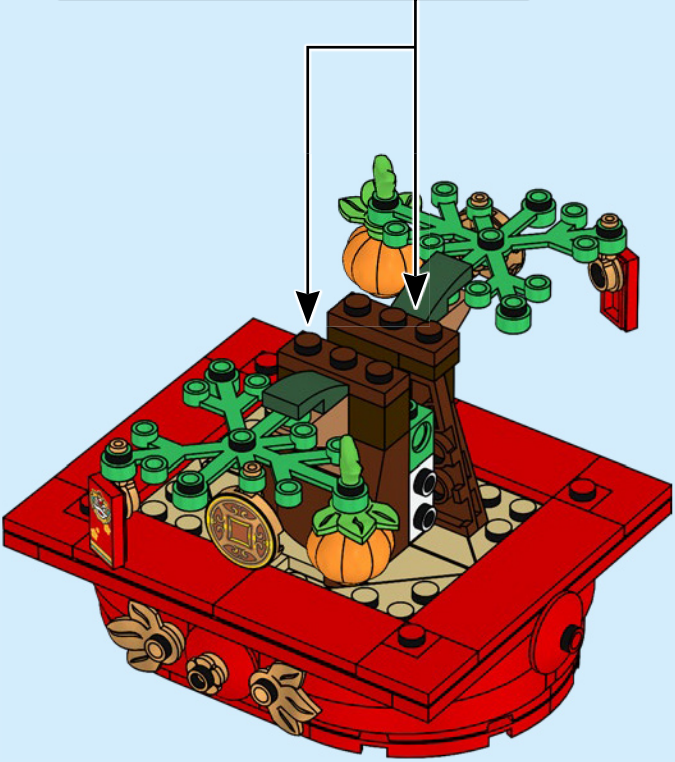
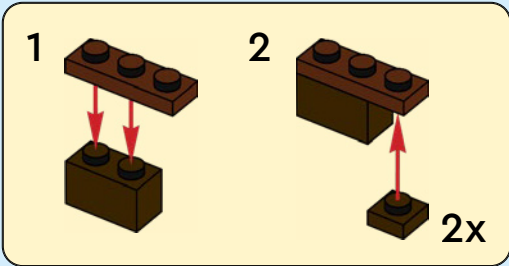



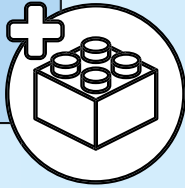
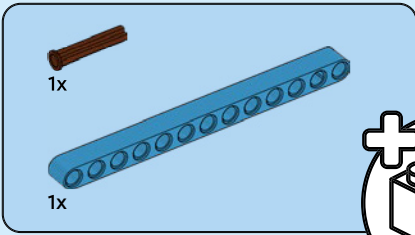

36

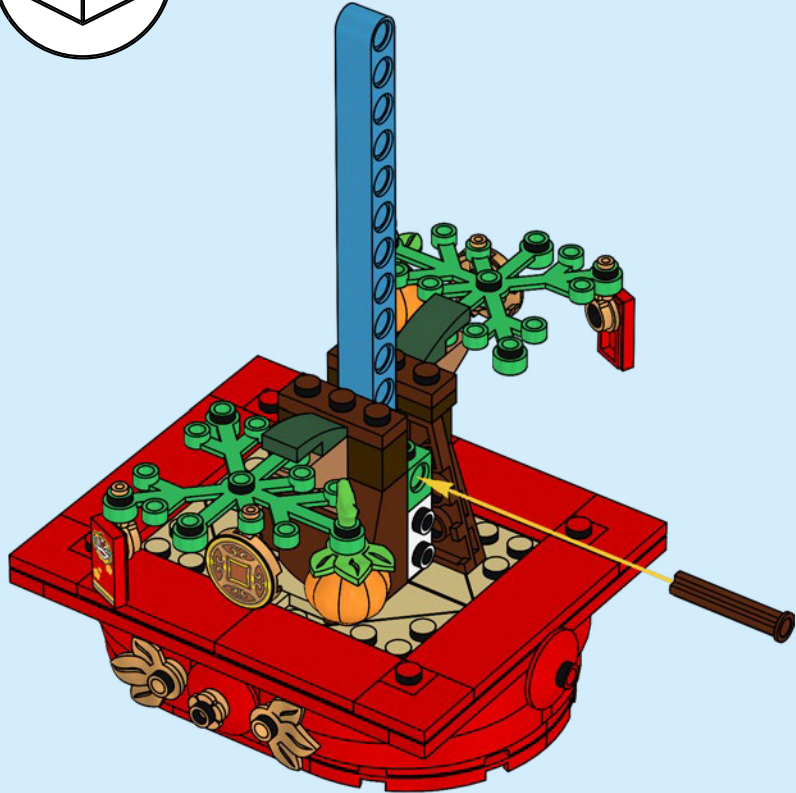

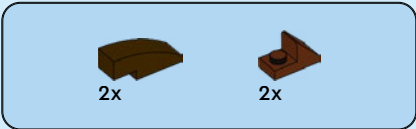

37

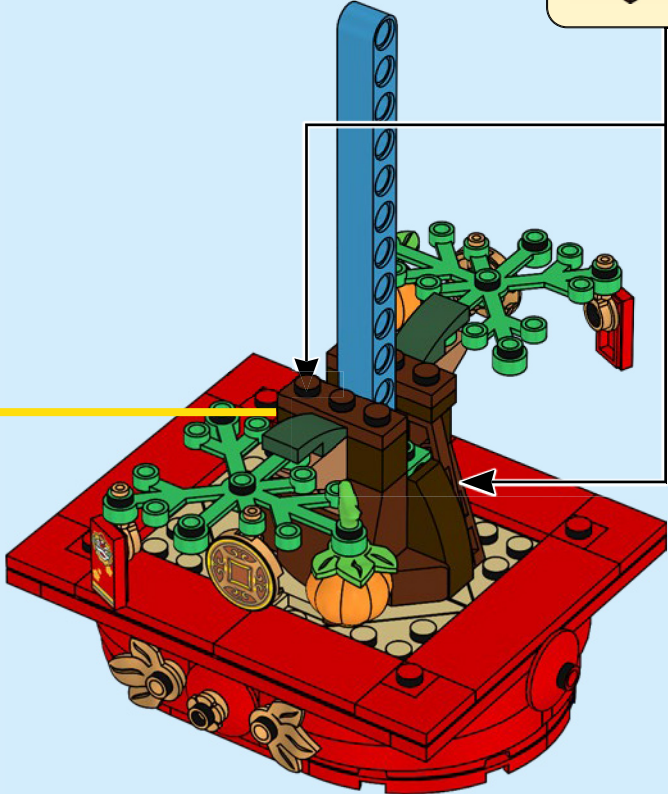
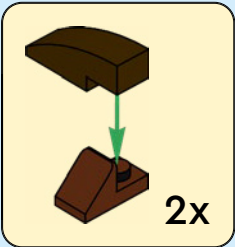



38

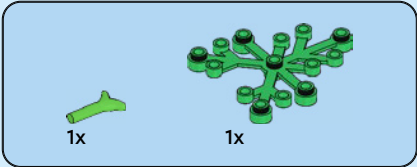

39

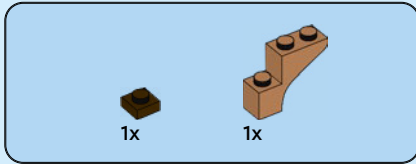
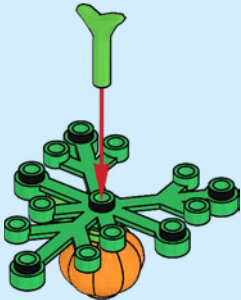

40

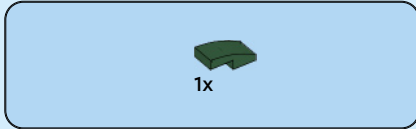
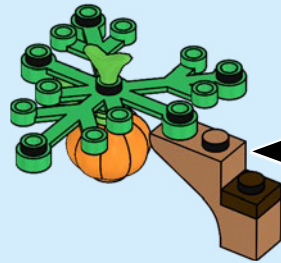
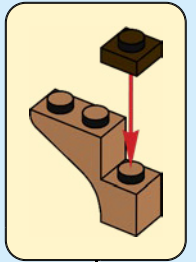

41

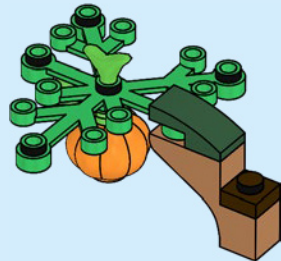

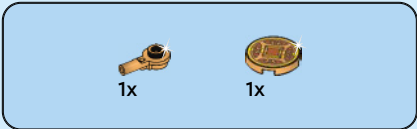

42

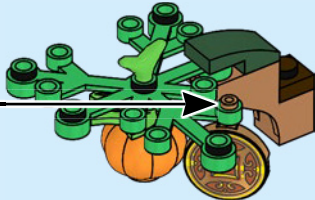
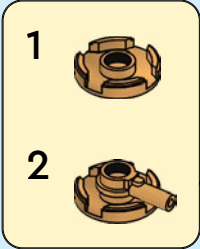

43

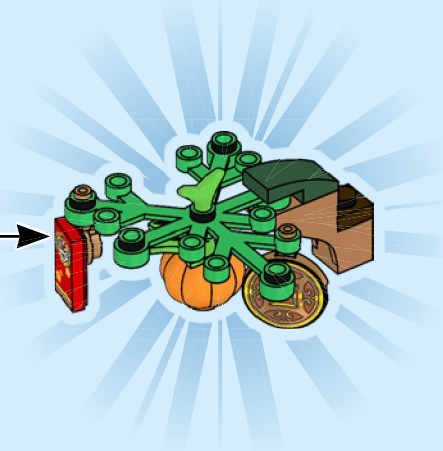

2x

44

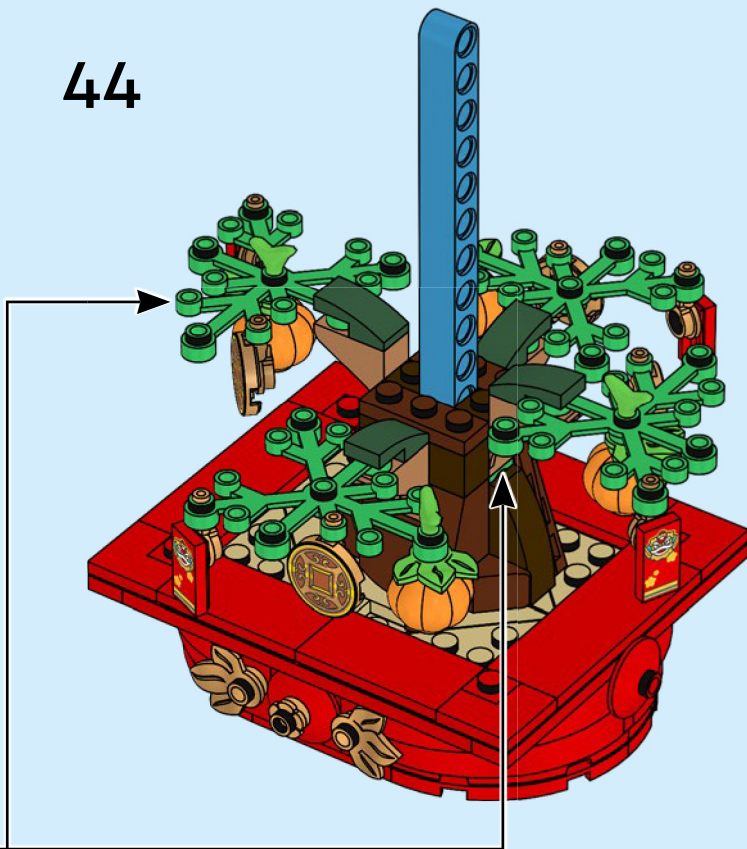

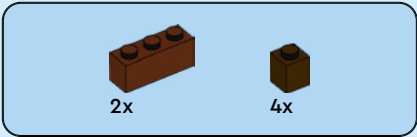

45

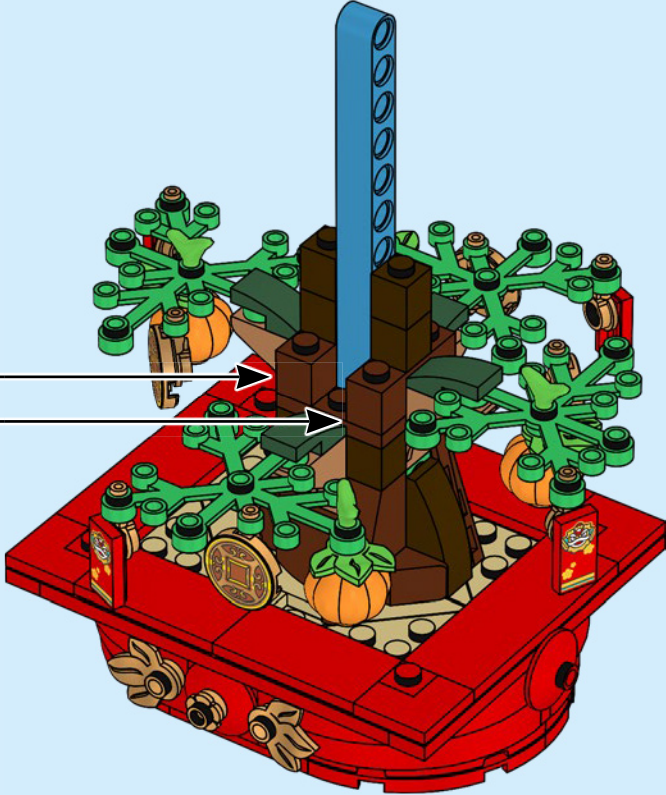
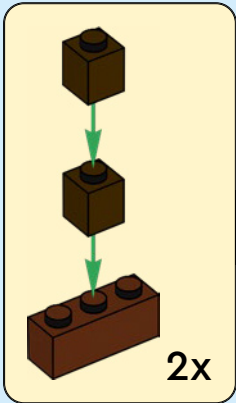



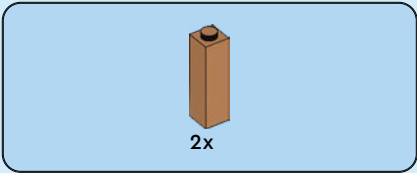

46

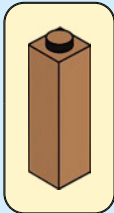

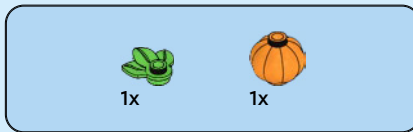

47

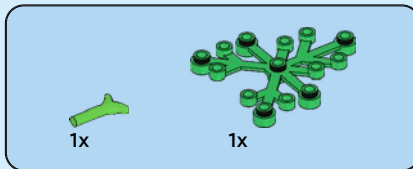

48

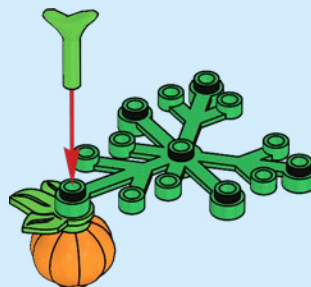

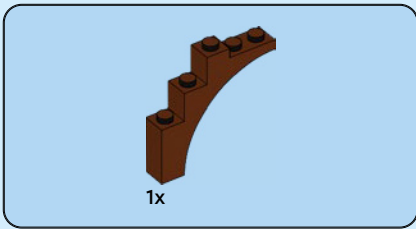

49

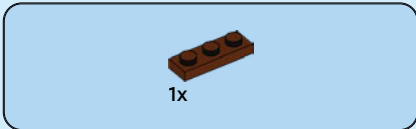

50

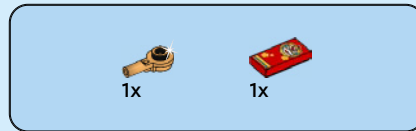

51



52

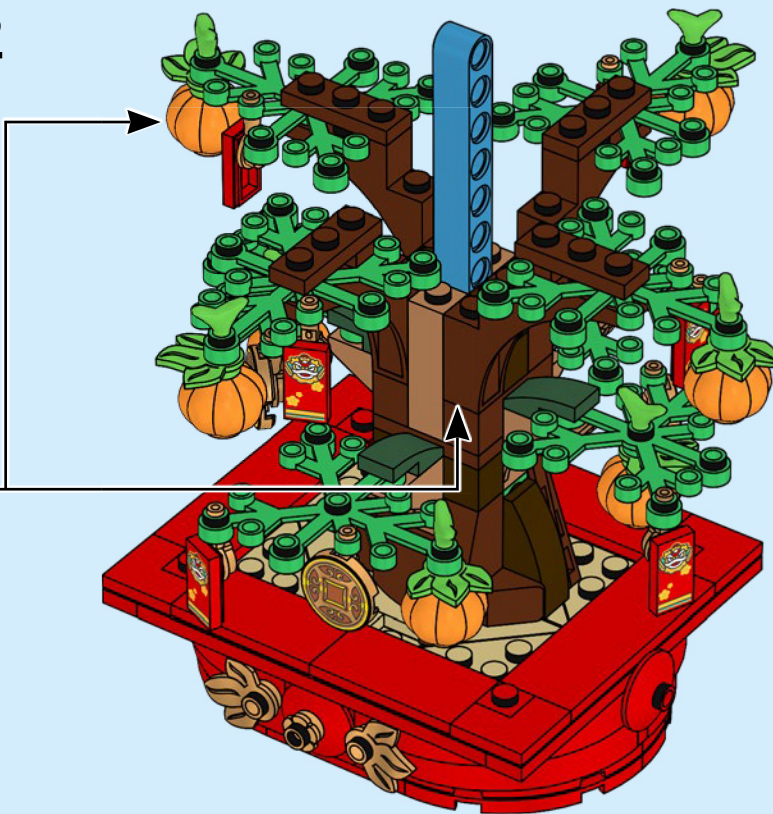

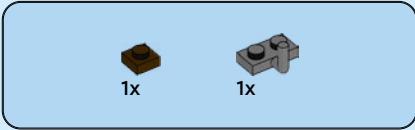

53

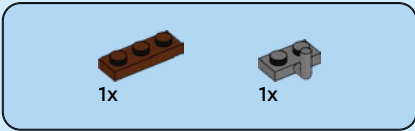
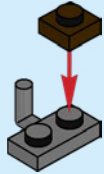

54

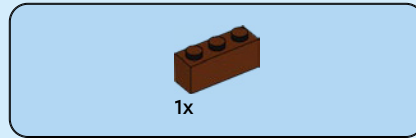
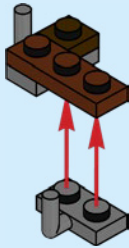

55

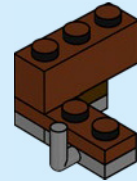

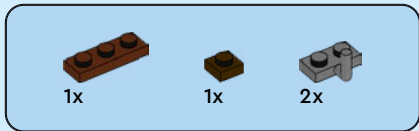

56

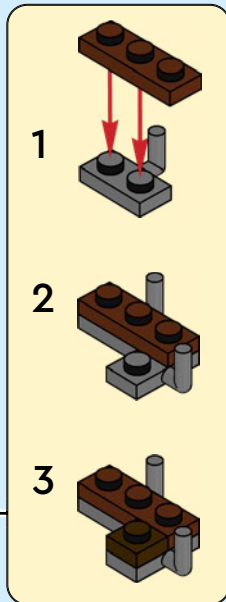
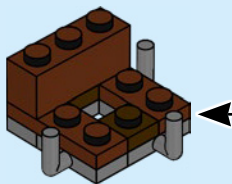

57





58



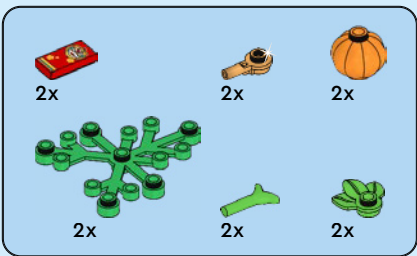

59

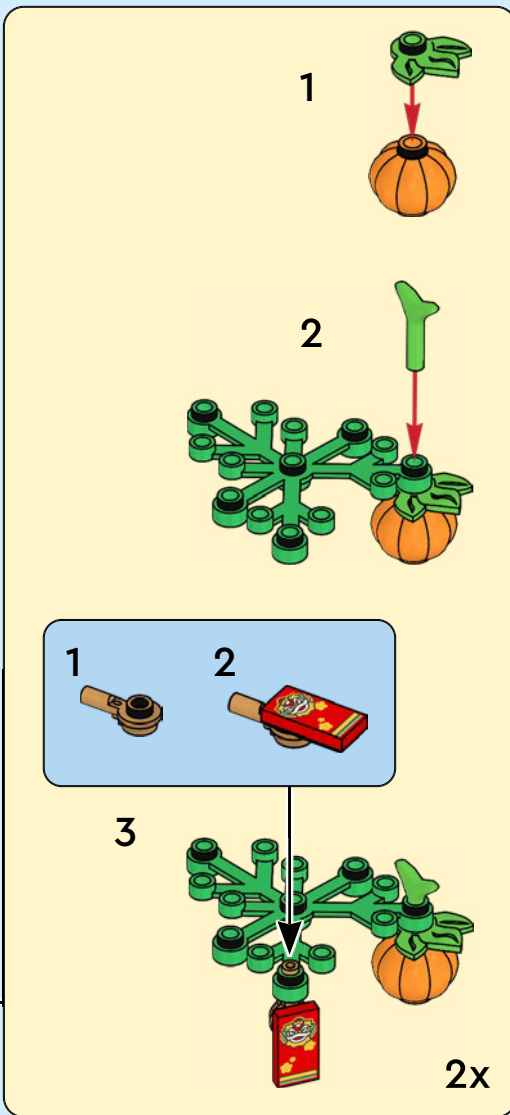
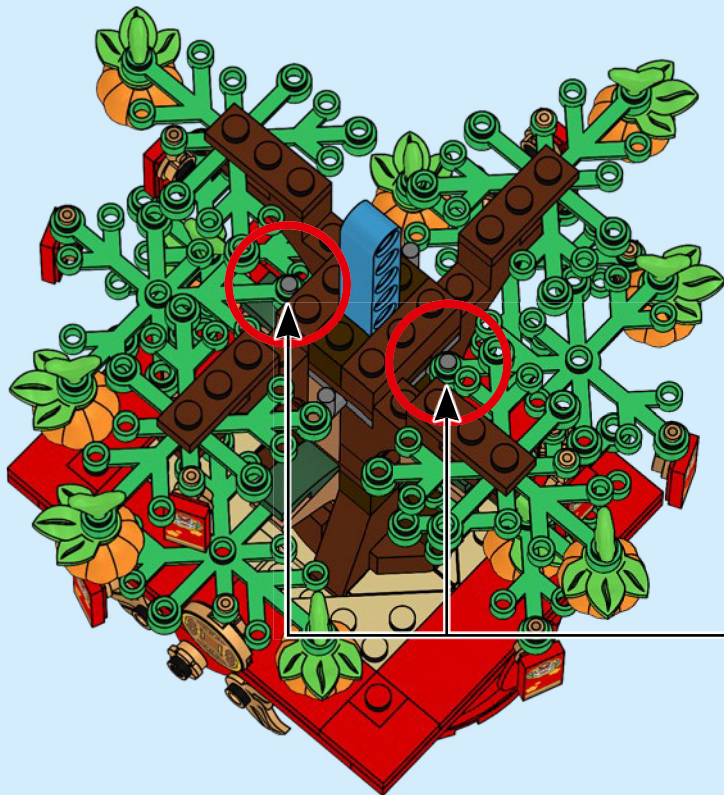

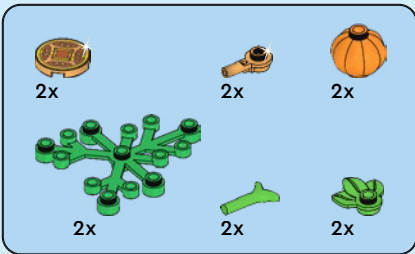

60

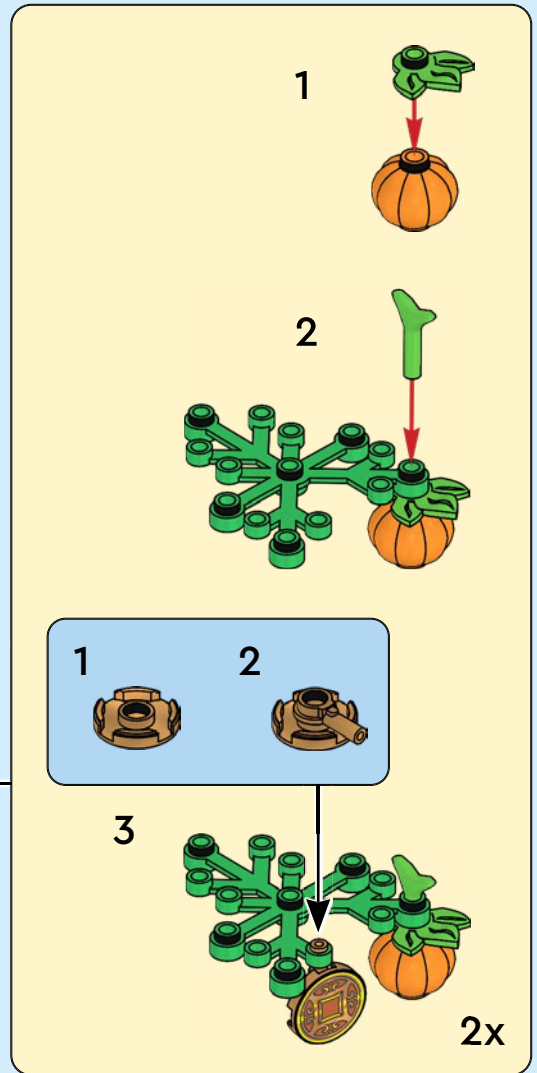
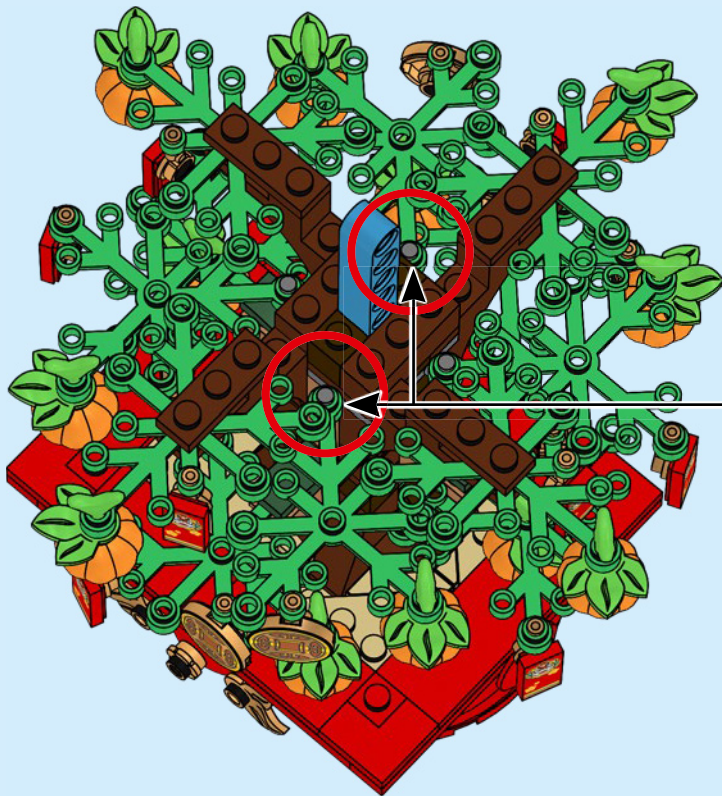

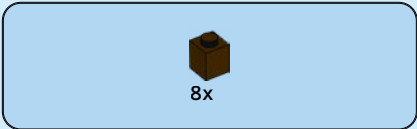

61

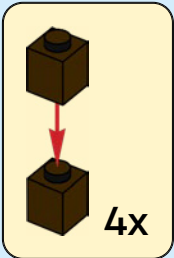



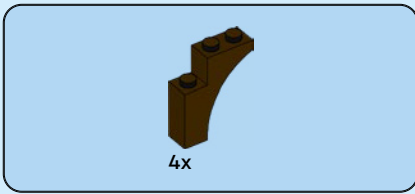

62





2x



2x



63









2x



1x



1x

64



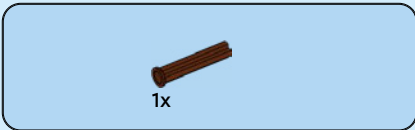

65





4x



4x



4x



4x



8x



4x



8x



8x

66

1



2

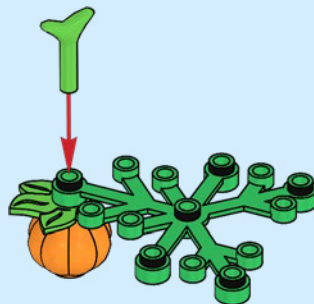

3

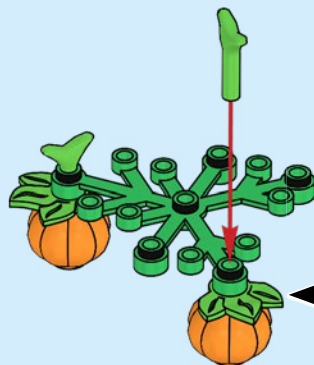



4

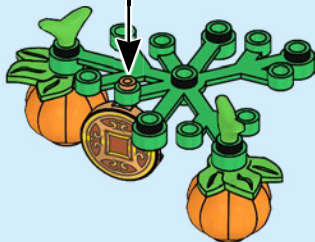

5



4x

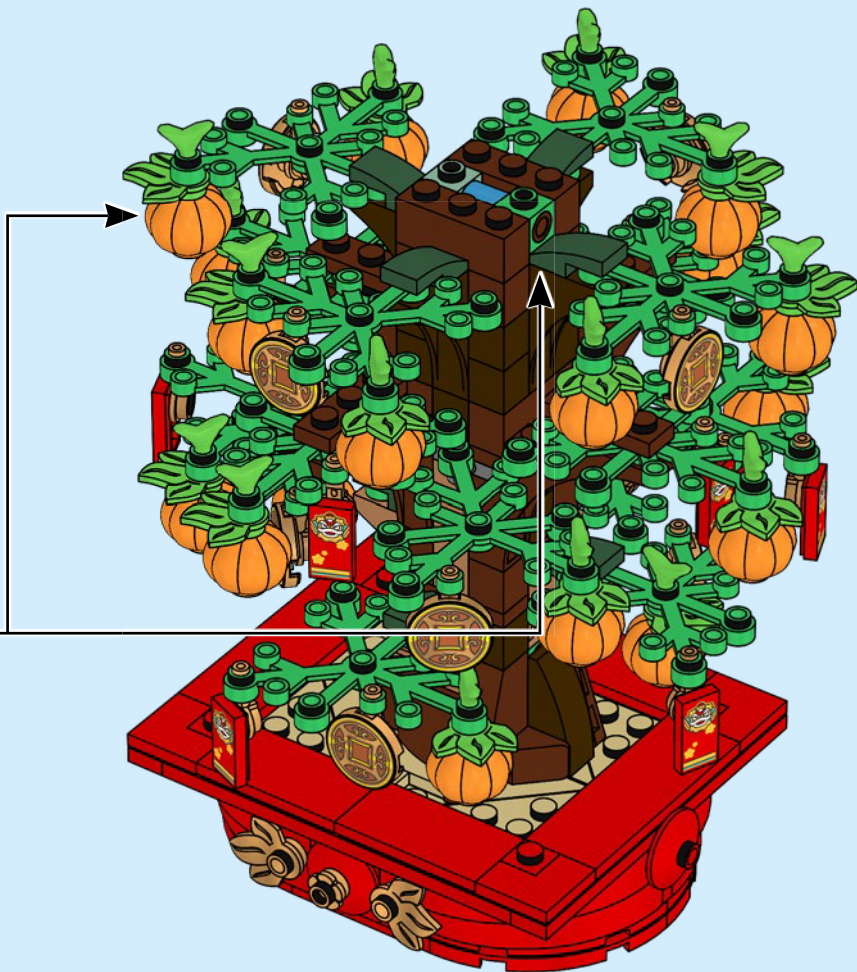



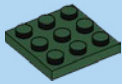

1x

67







1x

68



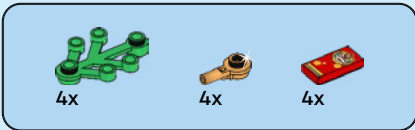

69



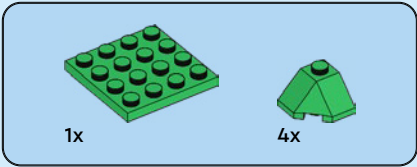

70

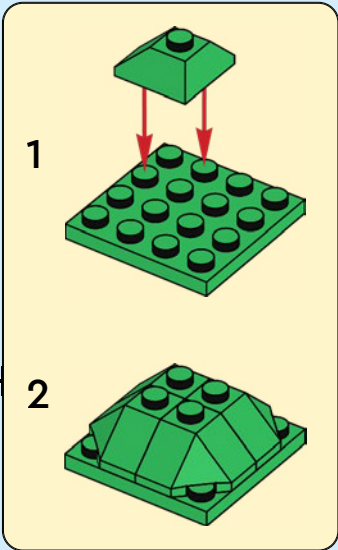

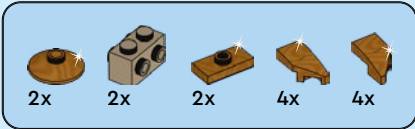

71

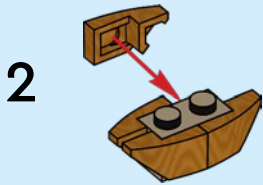
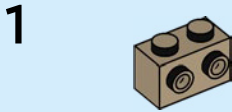









4x  
6314477



1x  
6265572



1x  
6173057



1x  
6131896



4x  
6034852

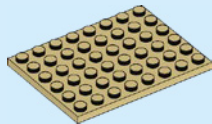

1x  
6070501



4x  
6297811



4x  
447721

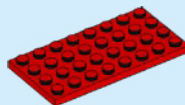

1x  
303521

58



2x  
6092565



1x  
6126048



4x  
6078641



3x  
371021



2x  
243121



4x  
4560179



2x  
6335578



3x  
4585146



8x  
6297822



4x  
6390262



2x  
4558886



6x  
302421



2x  
302321



14x  
6430676



2x  
6105976



8x  
6289113



20x  
6267125



20x  
6182261



20x  
4119479



3x  
4522678



4x  
6297286

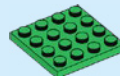

1x  
4243821

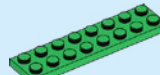

1x  
303428



4x  
6268814



16x  
6266968

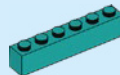

2x  
6396079



8x  
6055225



1x  
6253285



4x  
6133853



8x  
4211220



2x  
6075287



2x  
4270470



2x  
6146858

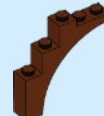

4x  
6044725



2x  
6050918



9x  
4211152



2x  
4205470



2x  
6021339



3

2x  
6135494

2x  
6135609

24x  
6335111

2x  
6341553

2x  
6420741

10x  
6420446

2x  
6378362

4x  
6210270

1x  
6209691

4x  
4568955

4x  
6261355

2x  
6219088

9x  
6194729

2x  
6218841

4x  
6386791

16x  
6226437

2x  
614324

4x  
6386790

2x  
6058257

1x  
6359069

2x  
6347533

2x  
6022199

1x  
6223734

2x  
6078236

4x  
6177917

1x  
6211953

13



 [LEGO.com/service](https://www.LEGO.com/service)

YOU COULD

# WIN



Scan this QR code or go to  
**LEGO.COM/PRODUCTFEEDBACK** and give us  
your short feedback about this LEGO® set for a  
chance to win a cool LEGO prize.

Terms and Conditions apply\*

**DE: Du könntest GEWINNEN.** Es gelten die Teilnahmebedingungen\* **FR: Tu pourrais GAGNER.** Des conditions s'appliquent\* **IT: Potresti VINCERE tu.** Termini e condizioni sono applicabili\* **ES: Puedes GANAR.** Aplican términos y condiciones\* **PT: Poderá GANHAR.** Aplicam-se termos e condições\* **JA: プレゼント付き! 利用規約が適用されます\*** **ZH: 轻松获奖. 条款和条件适用\*** **KO: 상품의 주인이 되어보세요. 소정의 약관이 적용됩니다\*** **RU: Вы можете ВЫИГРАТЬ.** Действуют положения и условия\* **PL: Szansa na WYGRANĄ.** Obowiązują warunki korzystania\* **CS: Máte šanci VYHRÁT.** Platí všeobecné smluvní podmínky\* **SK: Máte šancu VYHRAŤ.** Platia všeobecné zmluvné podmienky\* **HU: TE IS NYERHETSZ.** Felhasználási feltételek érvényesek\* **RO: Ai putea CÂȘTIGA.** Se aplică termeni și condiții\* **BG: Можете да СПЕЧЕЛИТЕ.** Има определени правила и условия\* **LV: Tu vari LAIMĒT.** Ir spēkā noteikumi un nosacījumi.\* **ET: Sul on võimalus VÕITA.** Kehtivad tingimused\* **LT: Jūs galite LAIMĖTI.** Taikomos sąlygos\*

\*[LEGO.com/productfeedback-terms](https://www.lego.com/productfeedback-terms)