



BRICK HEADZ

40541



[LEGO.com/brickheadz](https://www.lego.com/brickheadz)



We're switching from plastic to paper-based packaging. That's why you might find a mix of paper and plastic in our boxes!

Wir stellen von Kunststoffverpackungen auf Verpackungen auf Papierbasis um. Möglicherweise findest du deshalb sowohl Papier als auch Kunststoff in unseren Boxen!

Nous abandonnons progressivement les emballages en plastique au profit d'emballages à base de papier. Il est donc possible que vous trouviez à la fois du papier et du plastique dans nos boîtes !

Stiamo passando dagli imballaggi di plastica a quelli basati su carta. Ecco perché potreste trovare un mix di carta e di plastica nelle nostre confezioni!

Estamos sustituyendo las bolsas de plástico por bolsas con base de papel. ¡Por eso, puede que encuentres una mezcla de papel y de plástico en nuestras cajas!

Estamos a substituir as nossas embalagens de plástico por embalagens à base de papel. Por isso poderá encontrar um misto de papel e plástico nas nossas caixas!

Átállunk a műanyagról a papír alapú csomagolásra. Ezért előfordulhat, hogy a dobozainkban papír és műanyag zacskót egyaránt találasz!

Mēs pārejam no plastmasas iepakojuma uz iepakojumu, kurā izmantots papīrs. Tāpēc mūsu kārbās var būt gan papīra, gan plastmasas daļas.

Trecem de la ambalajele din material plastic la ambalaje pe bază de hârtie. Iată de ce s-ar putea să găsești un amestec de hârtie și material plastic în cutiile noastre!

我们正在从塑料包装向纸基包装过渡。这就是为什么你可能会发现我们的包装盒中同时出现塑料和纸质材料！

[LEGO.com/sustainable-packaging](https://www.lego.com/sustainable-packaging)

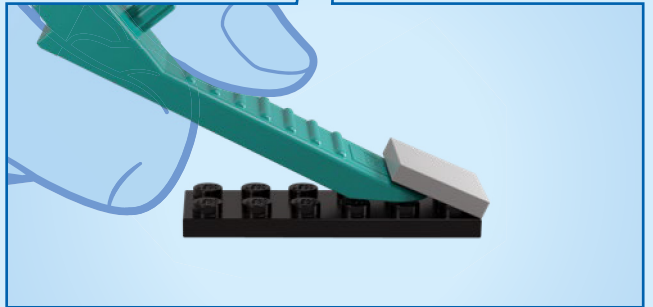
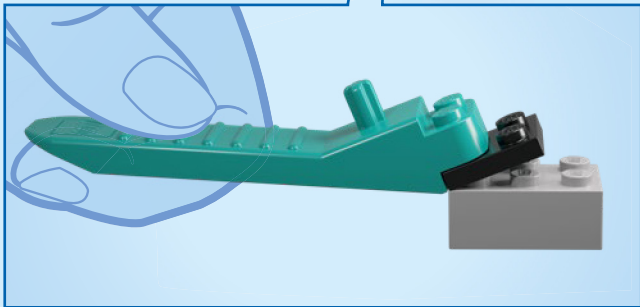
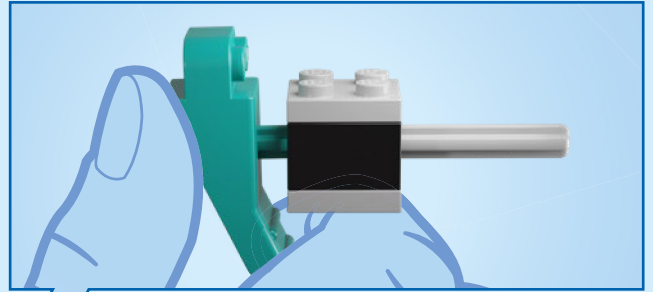
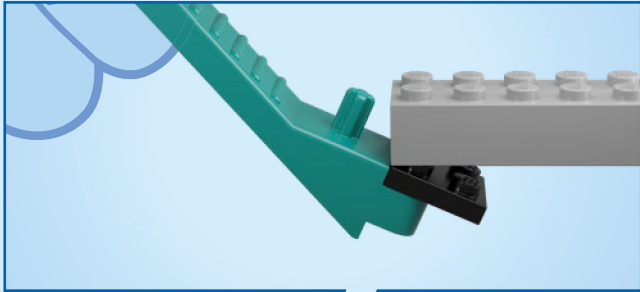

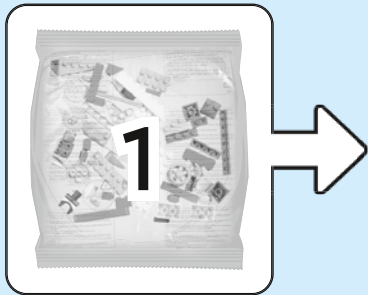

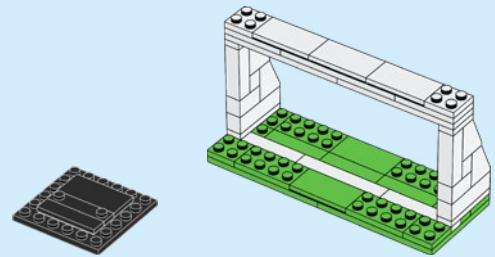
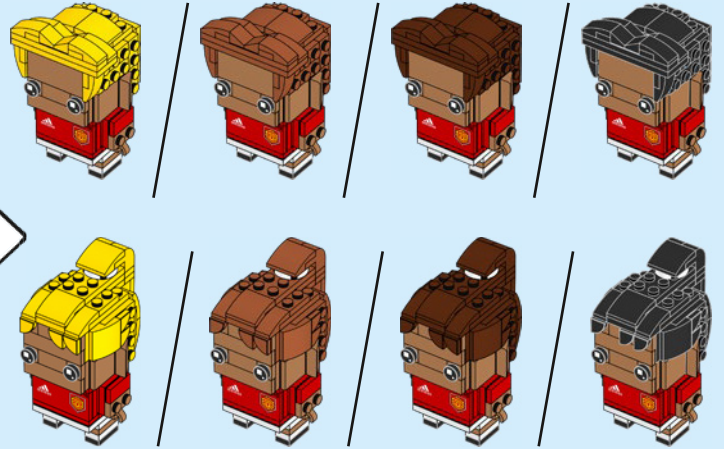

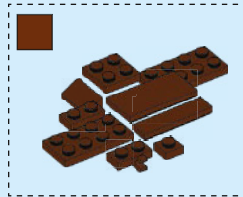
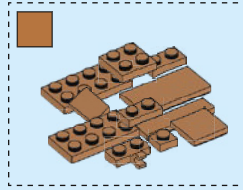
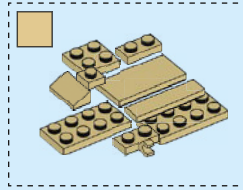
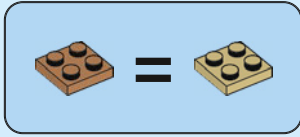

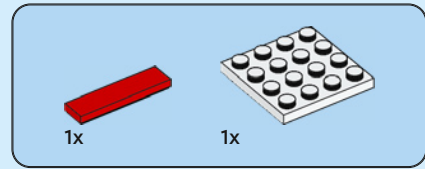

1

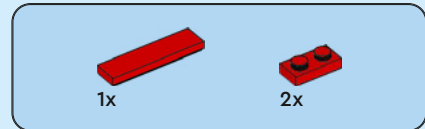
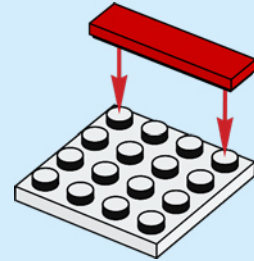

2

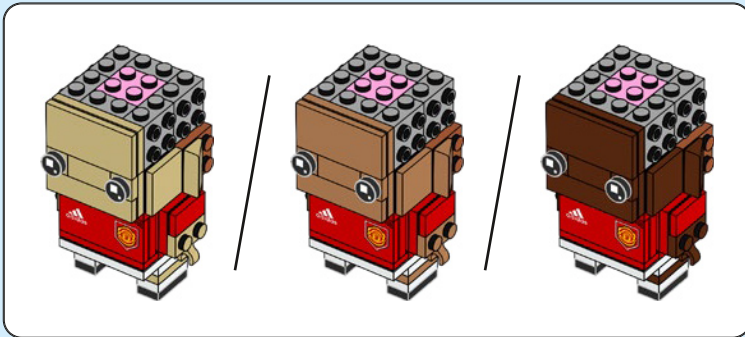
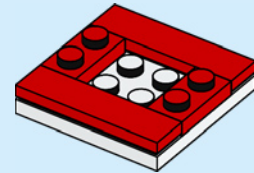

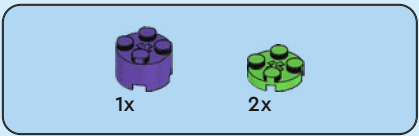

3

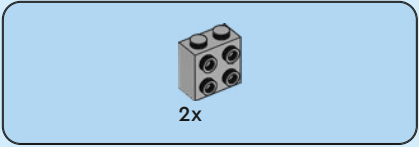
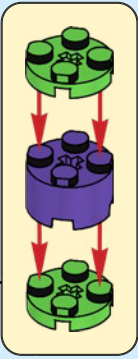
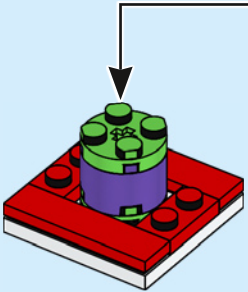

4

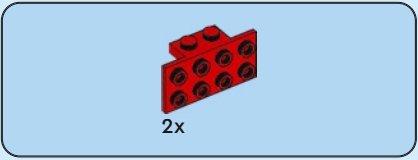
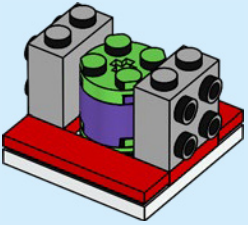

5

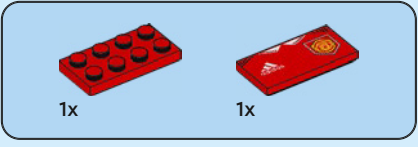
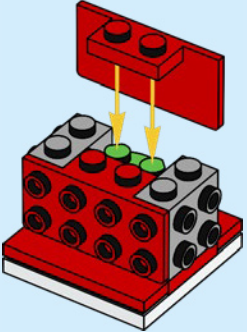

6

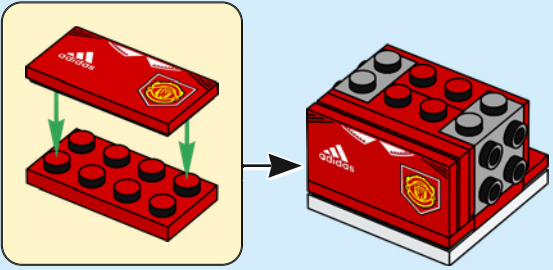

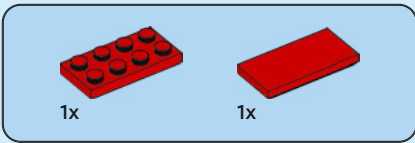

7

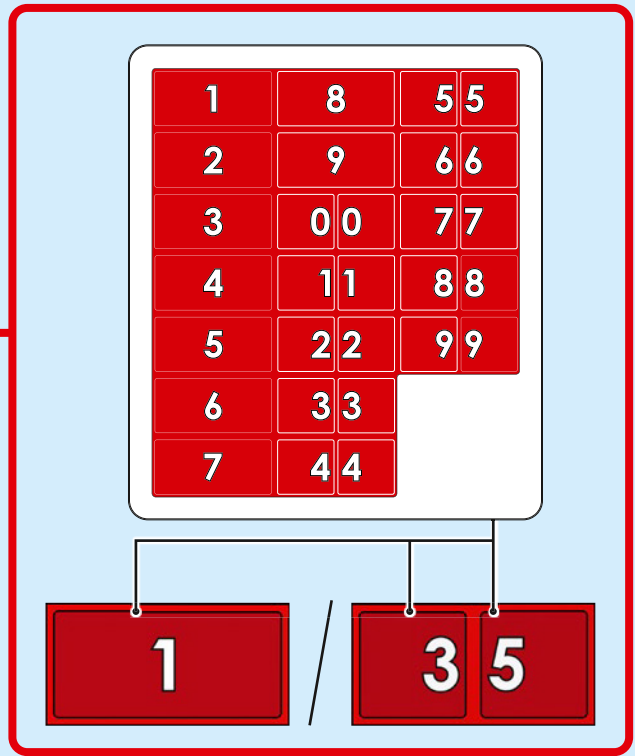
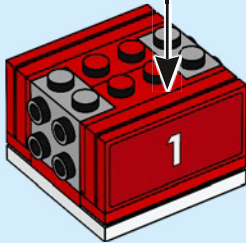
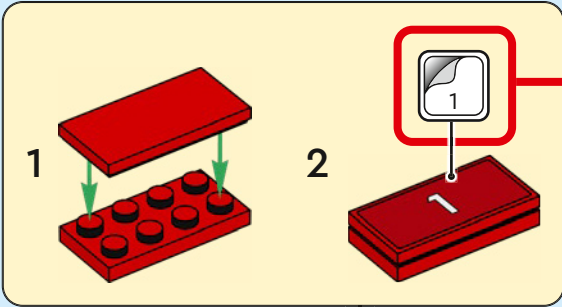

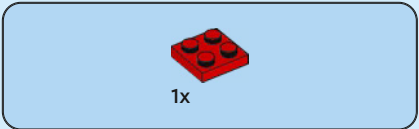

8

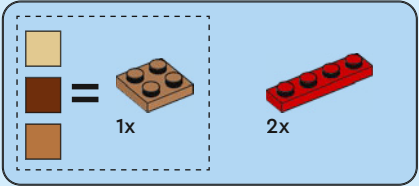
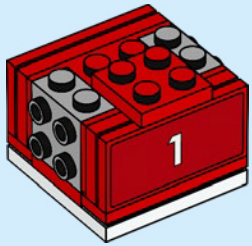

9

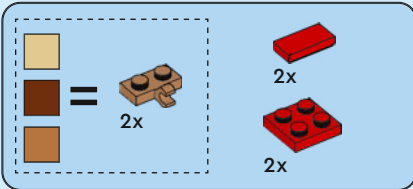

10

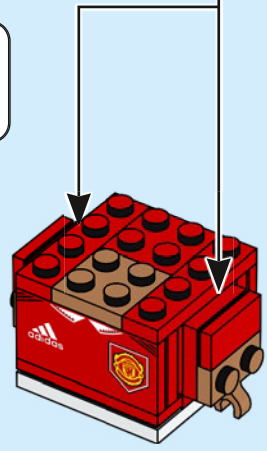
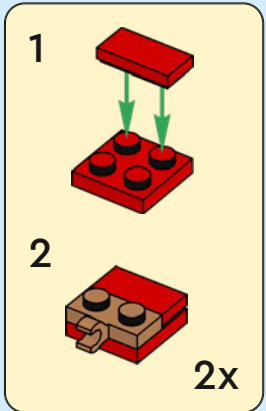



6x

11

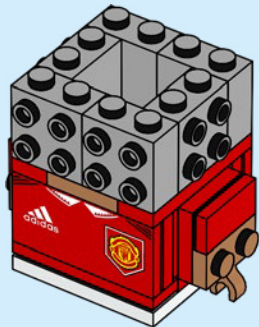

3x

12

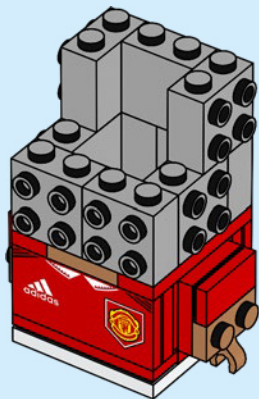

1x



1x



2x

13

1

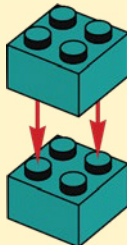

2

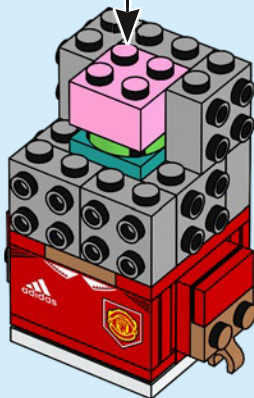
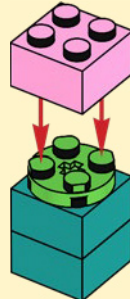

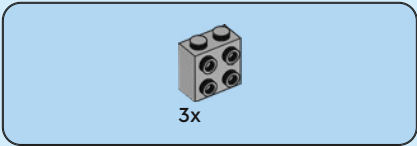

14

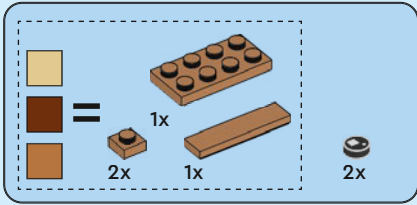
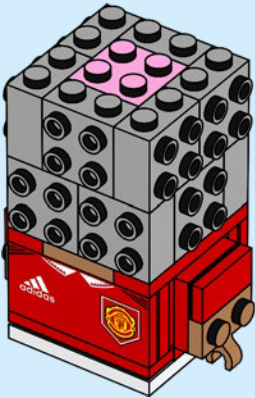

15

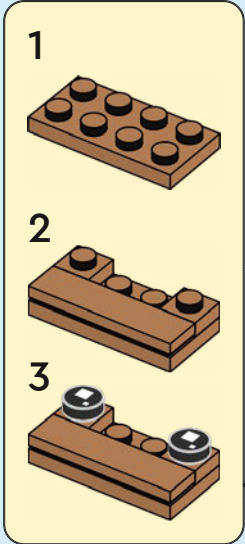

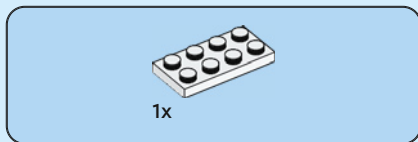

16

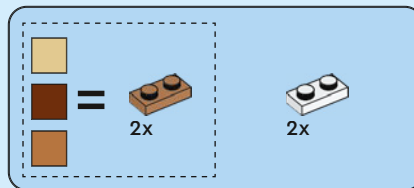
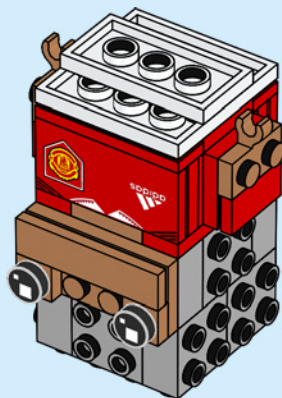

17

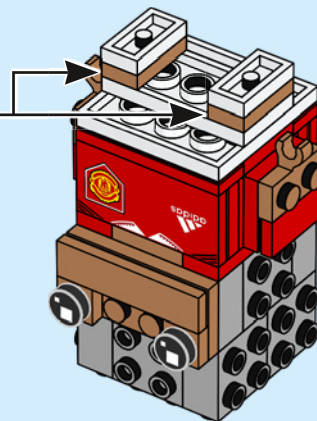
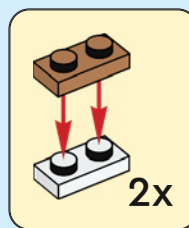



2x

18

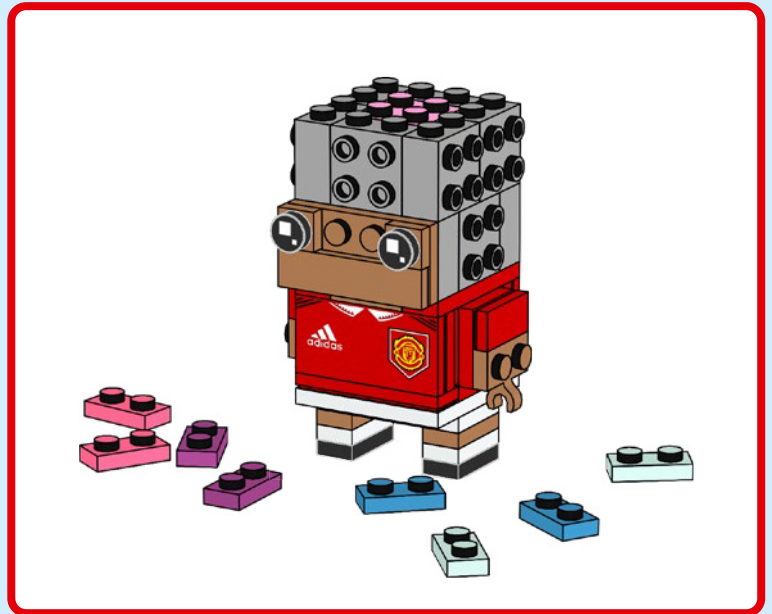
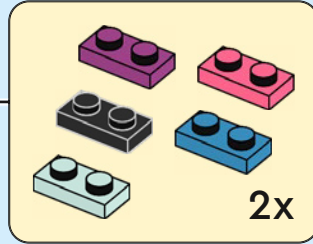
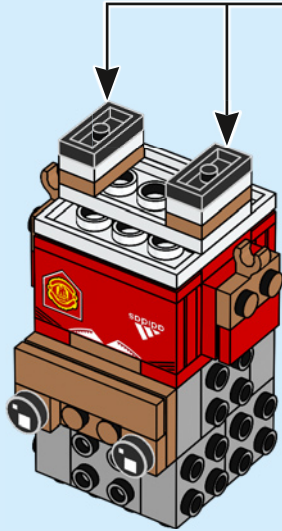

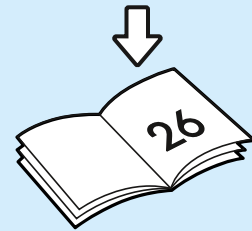
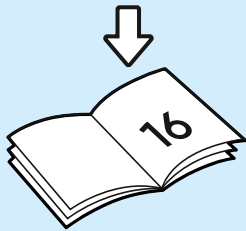
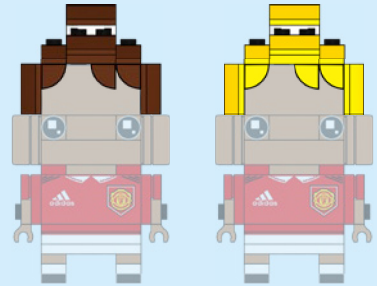
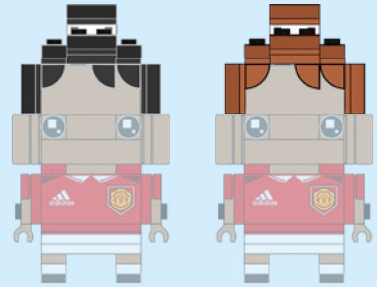

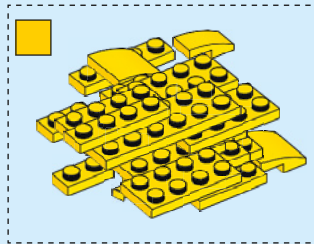
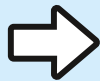
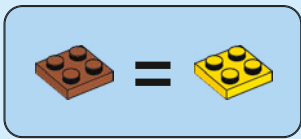
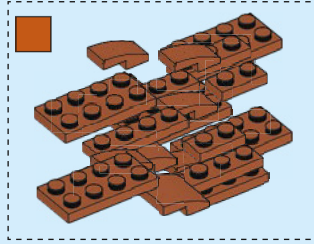
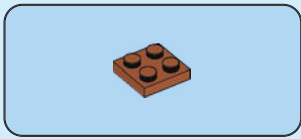
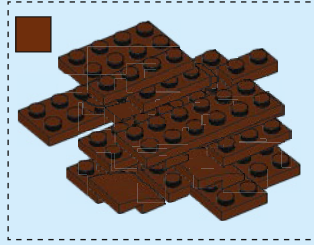
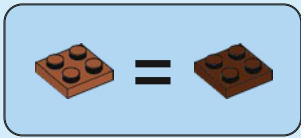
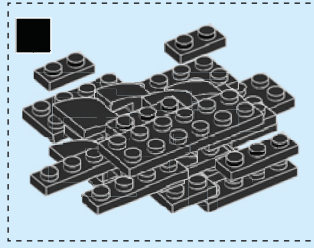
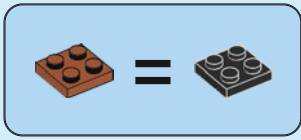

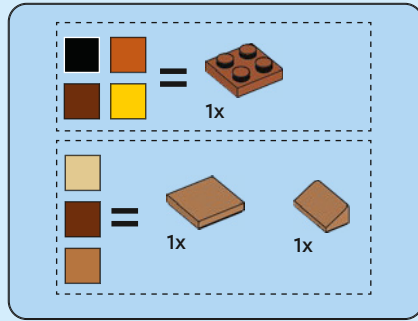
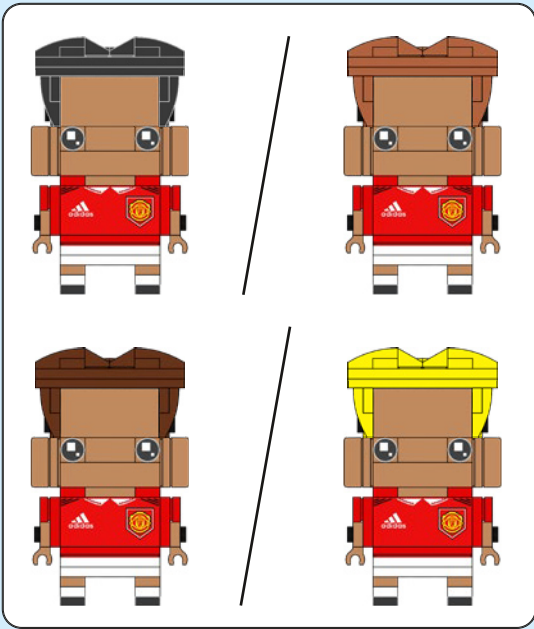

19

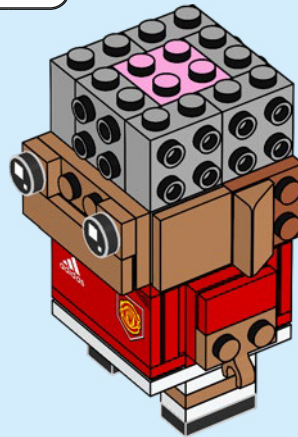
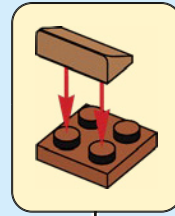

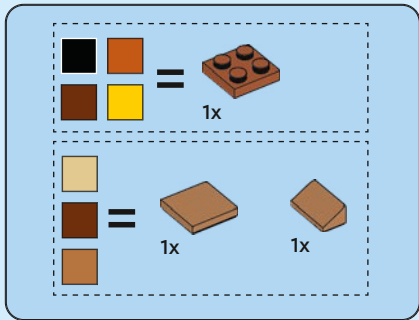

20

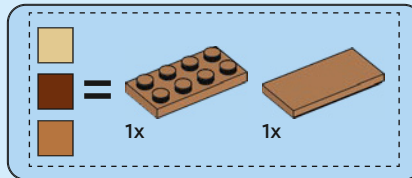
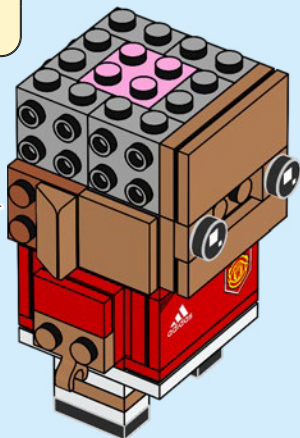
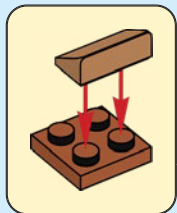

21

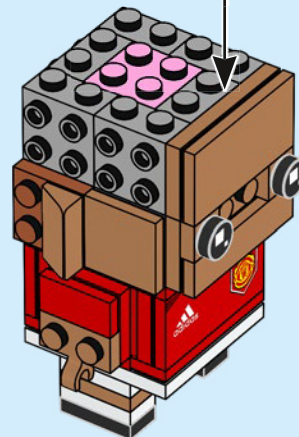
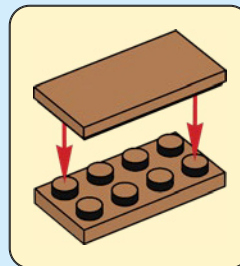

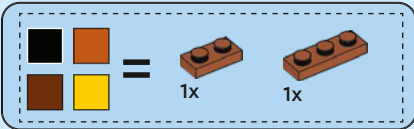

22

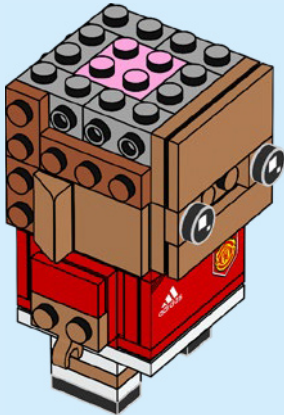
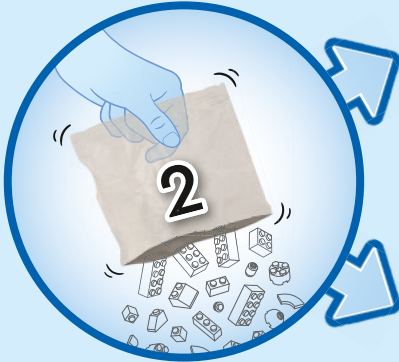

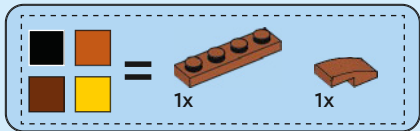

23

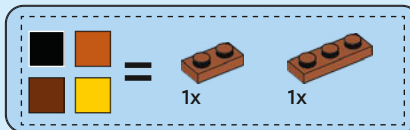
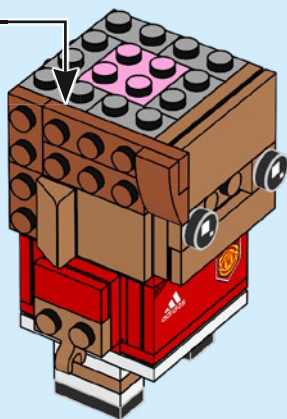
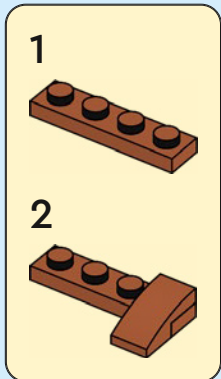

24

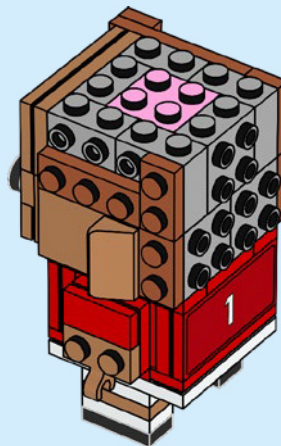

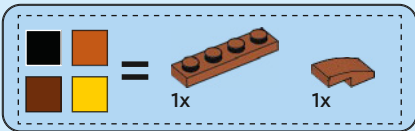

25

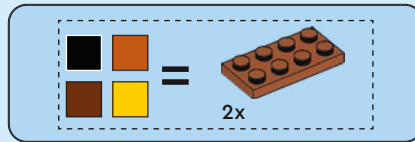
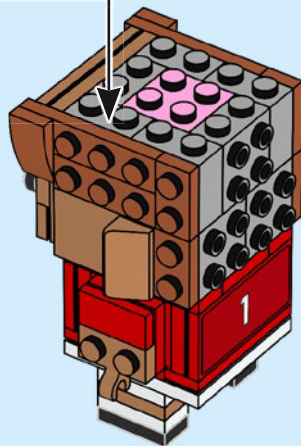
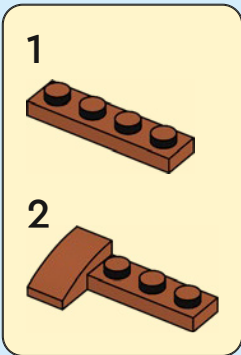

26

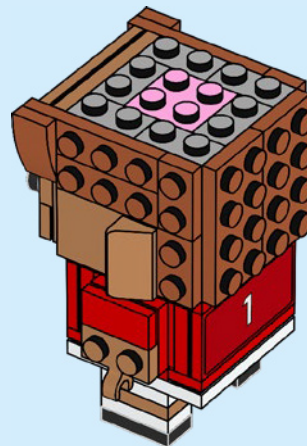

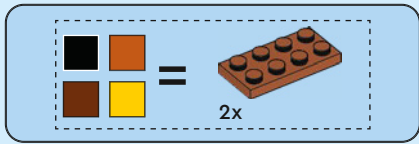

27

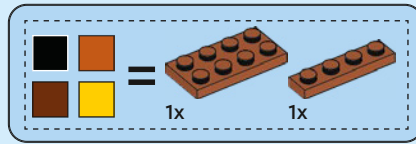
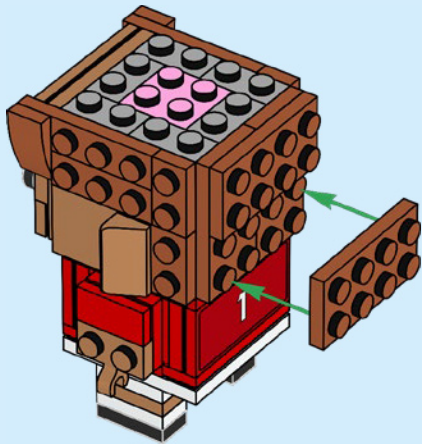

28

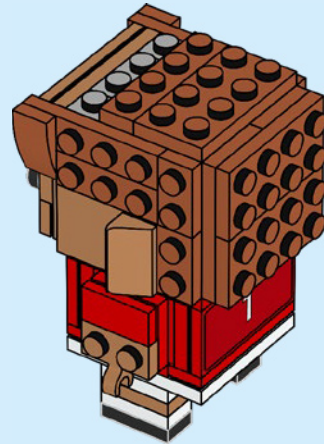

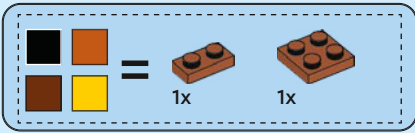

29

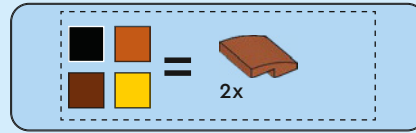
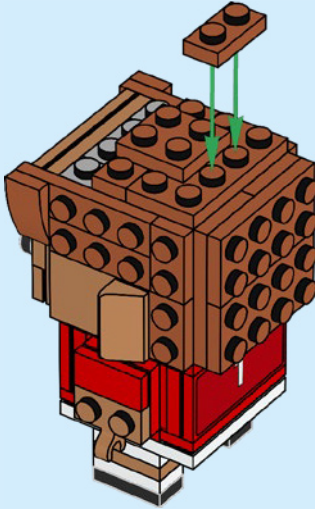

30

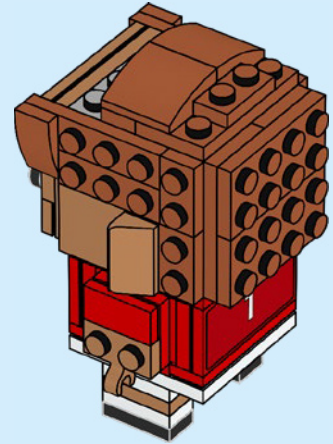

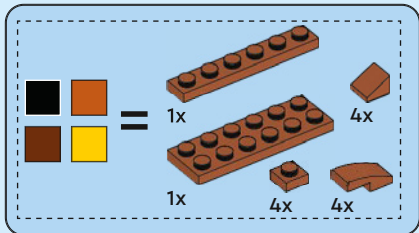

31

1

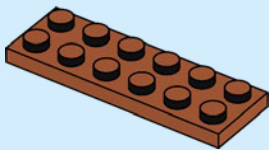

2

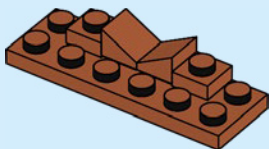

3

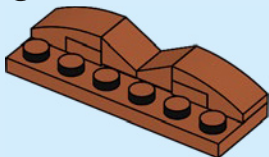

4

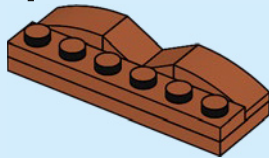

5

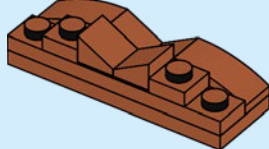

6

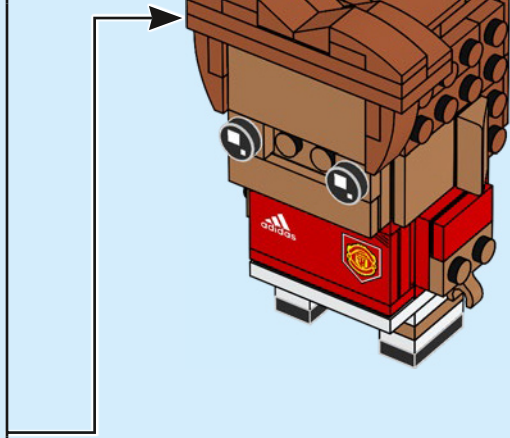
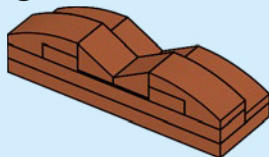

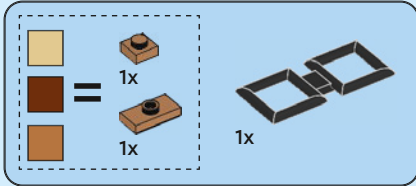

A

1

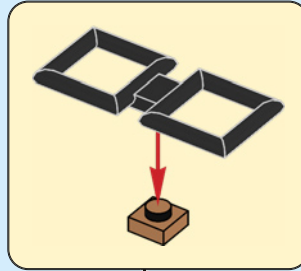

2

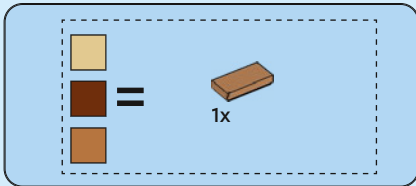
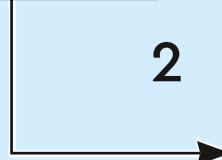

B



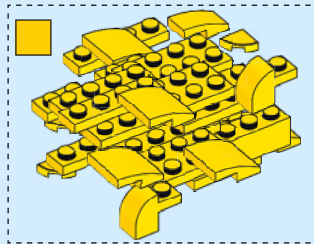
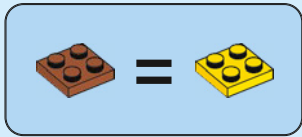
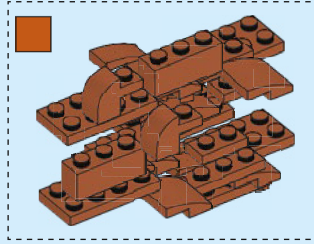
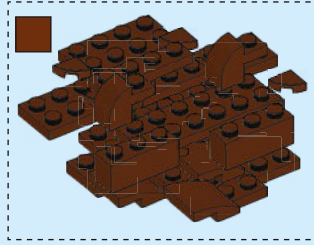
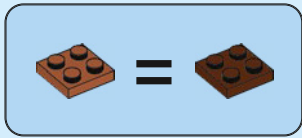
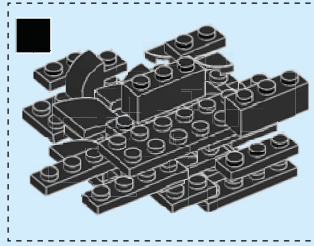
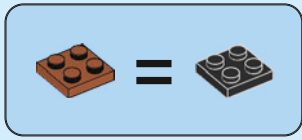

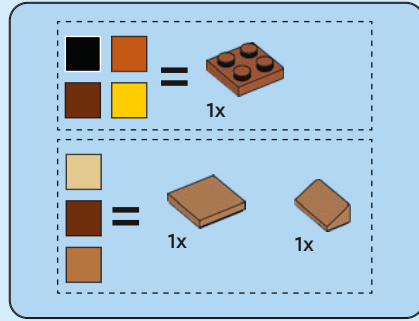

19

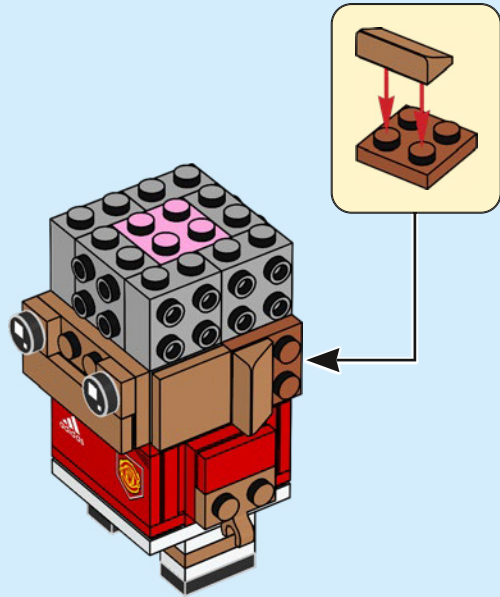

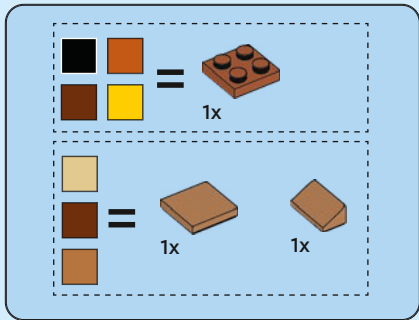

20

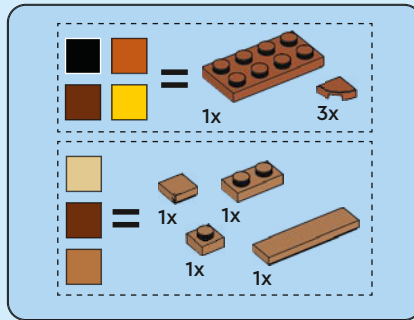
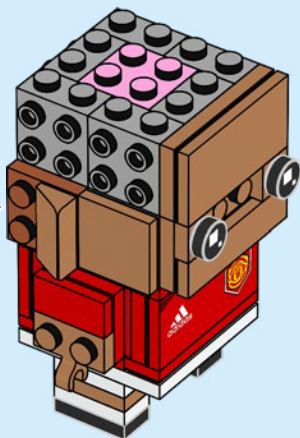
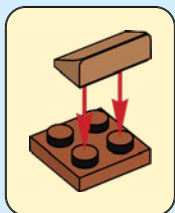

21

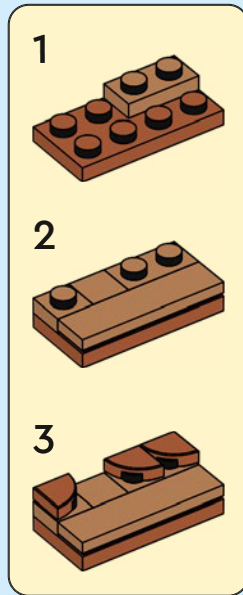

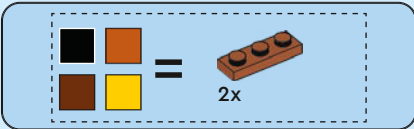

22

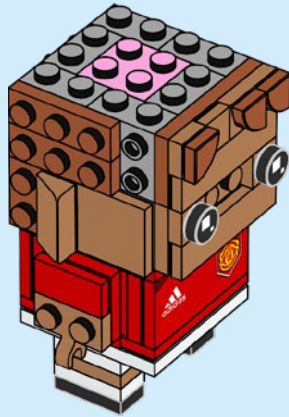
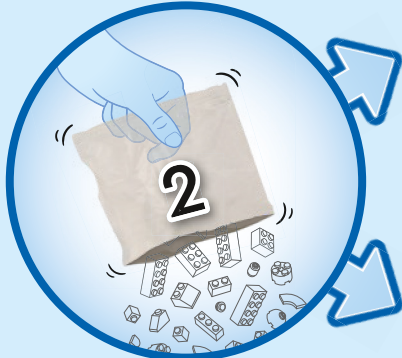

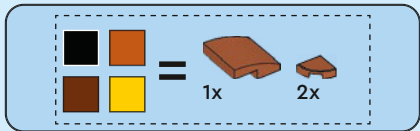

23

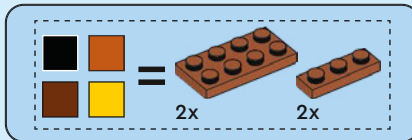
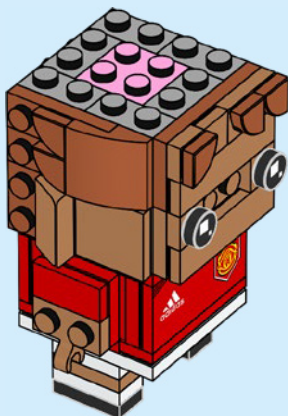

24

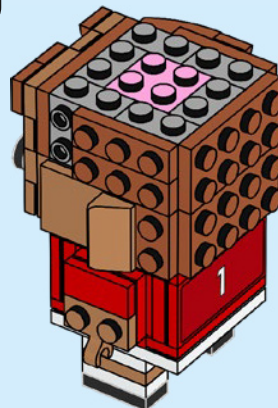

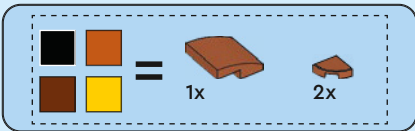

25

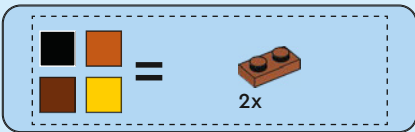
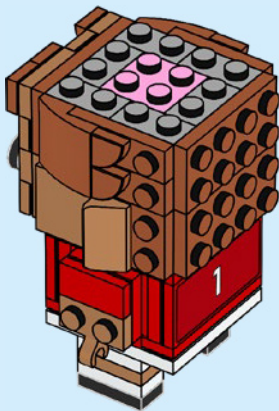

26

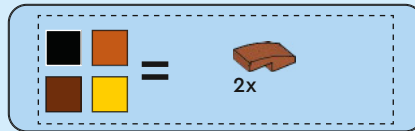
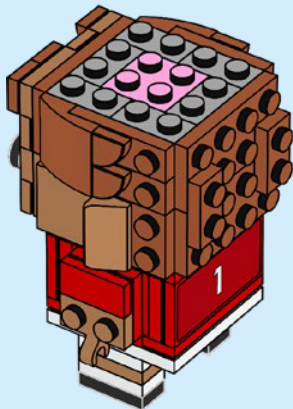

27

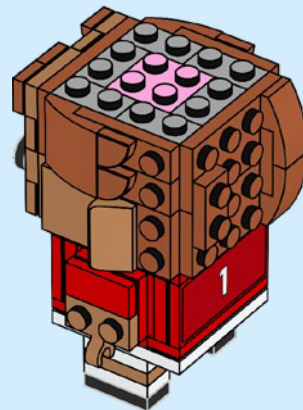

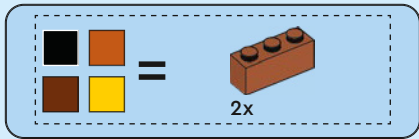

28

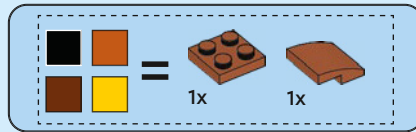
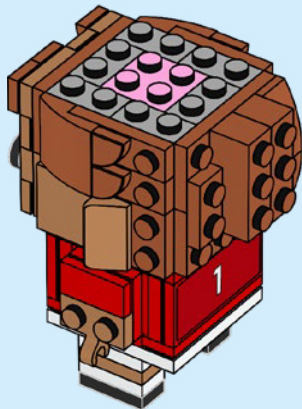

29

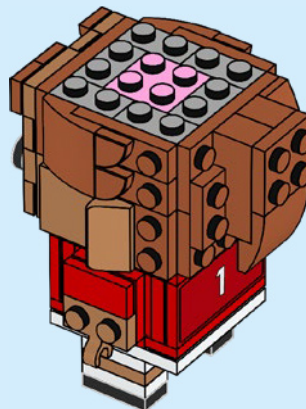

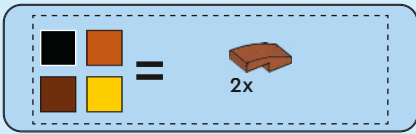

30

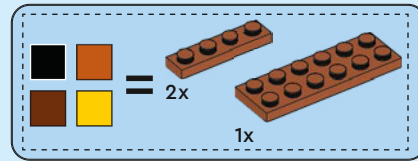
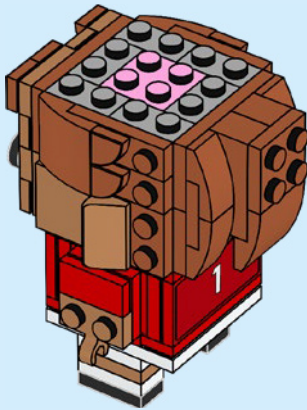

31

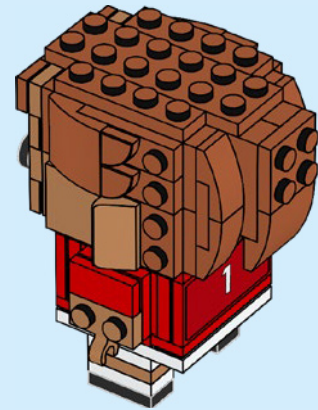

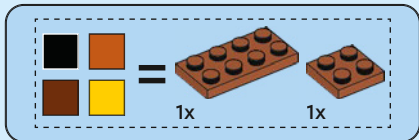

32

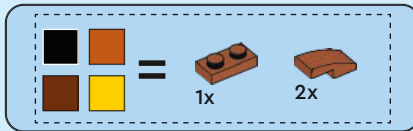
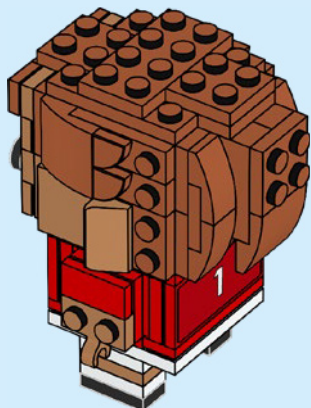

33

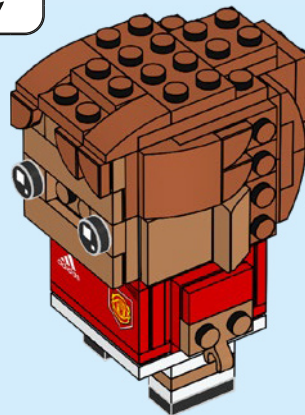

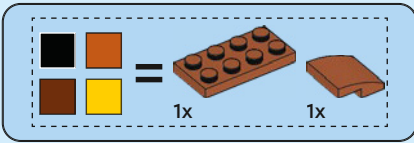

34

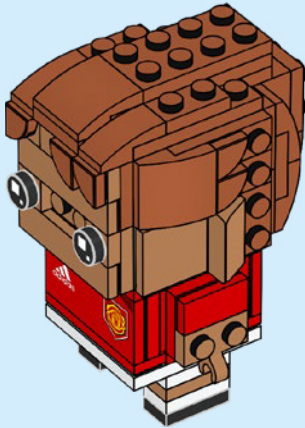

35

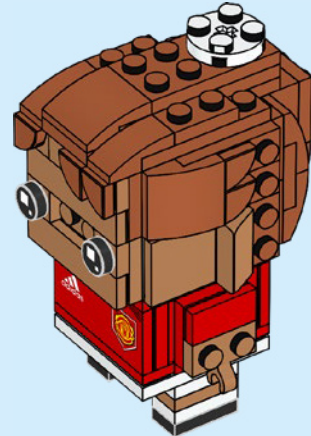

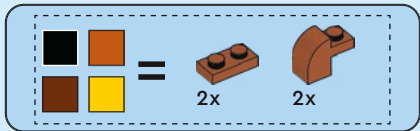

36

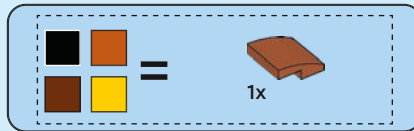
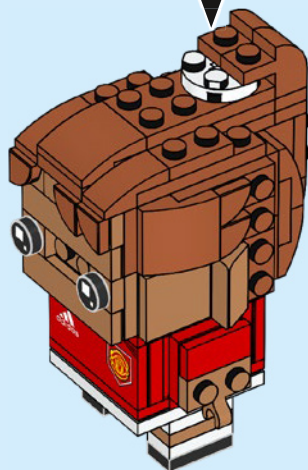
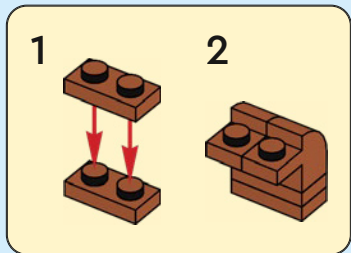

37

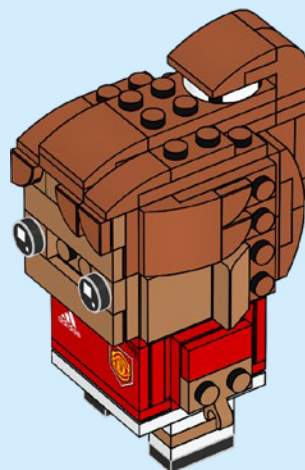

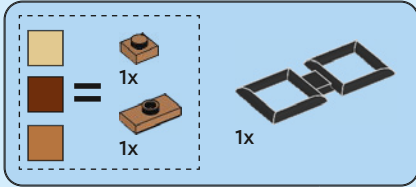

A

1

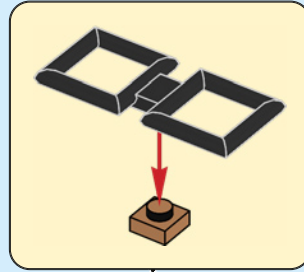

2

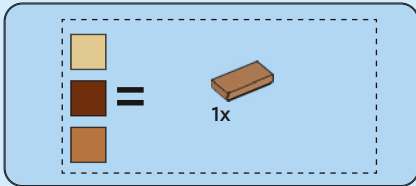

B



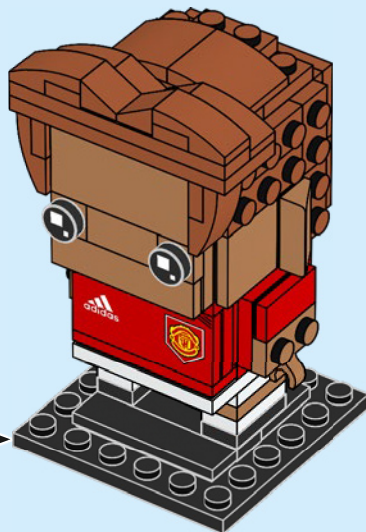
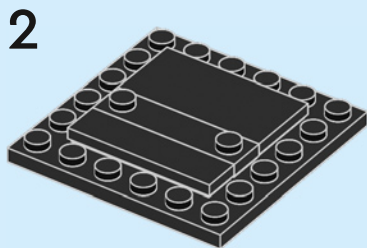
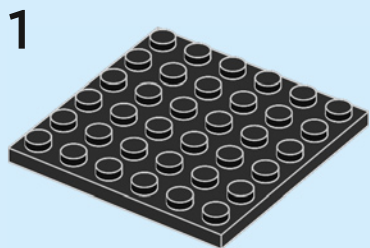
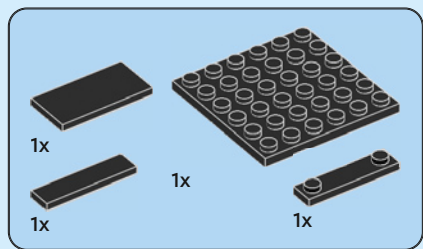

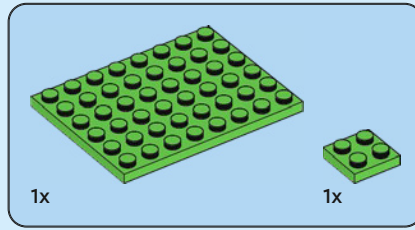
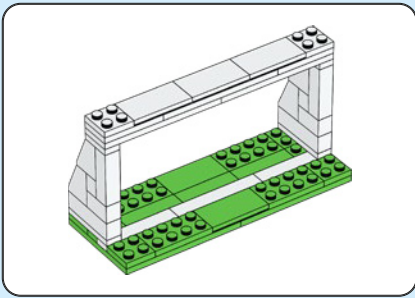

1

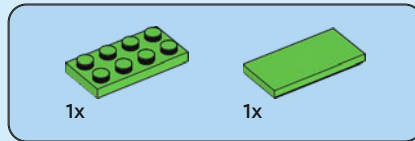
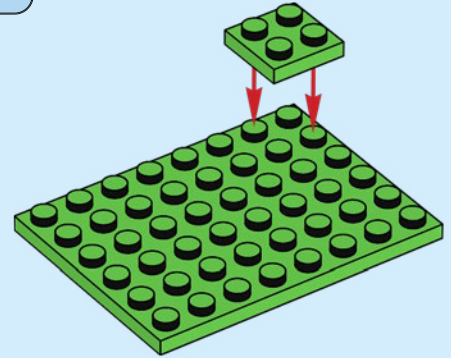

2

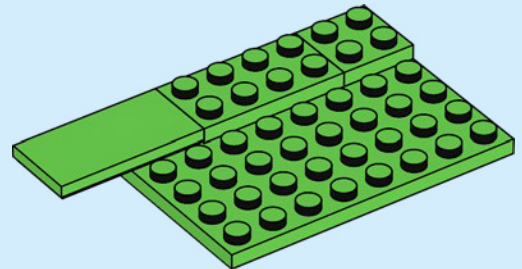

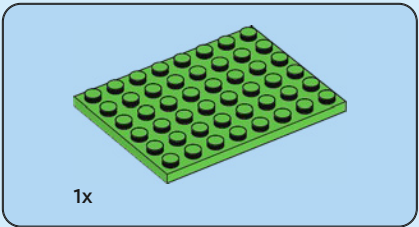

3

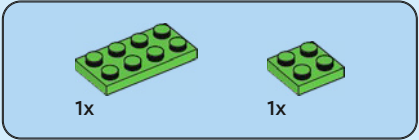
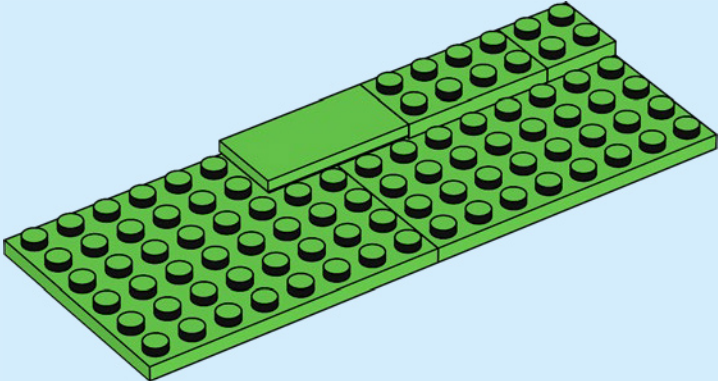

4

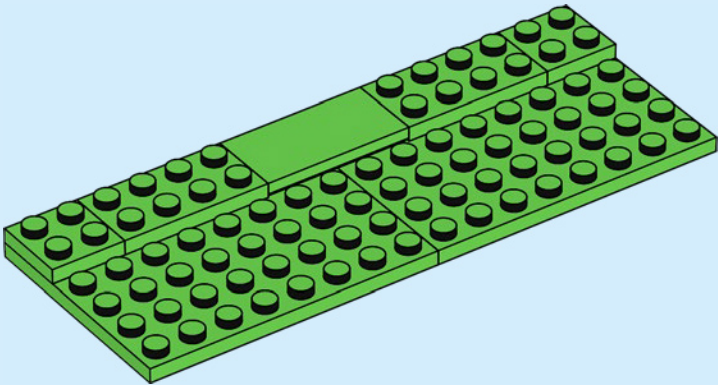

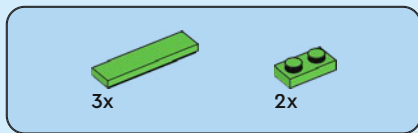

5

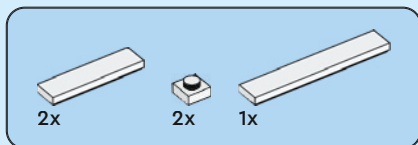
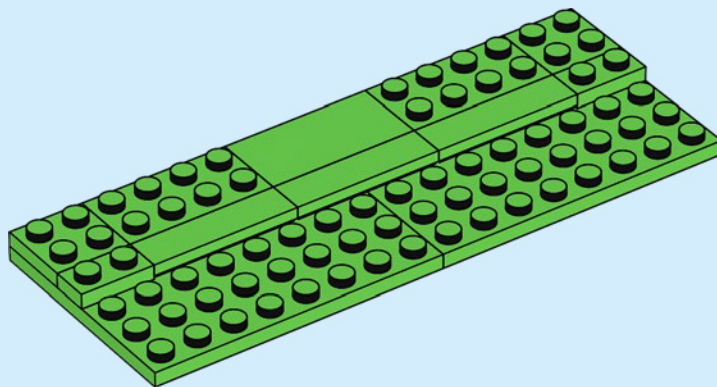

6

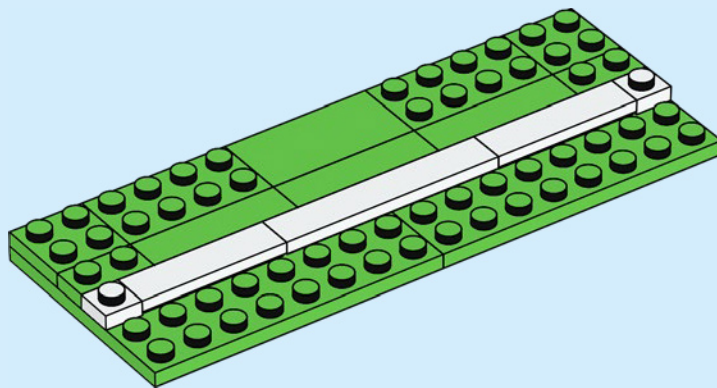

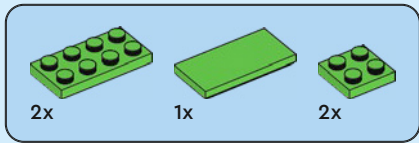

7

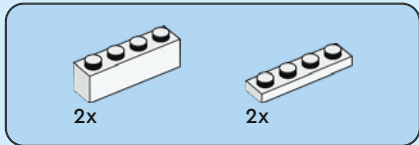
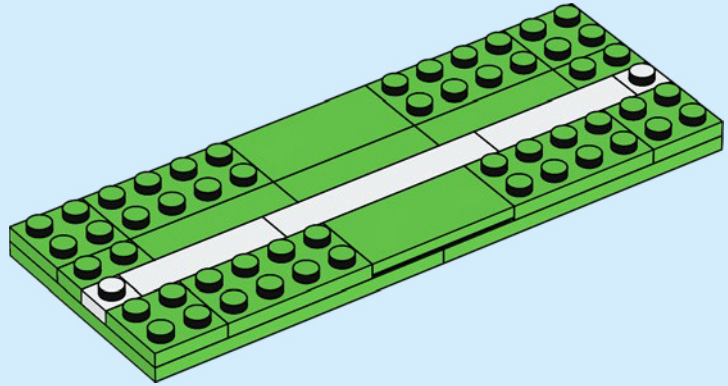

8

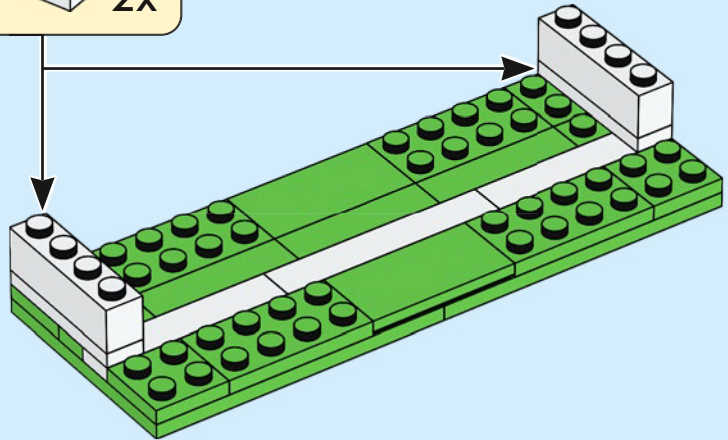
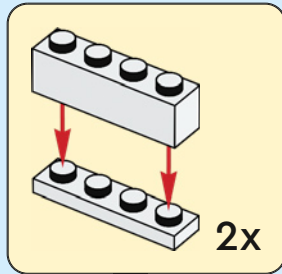

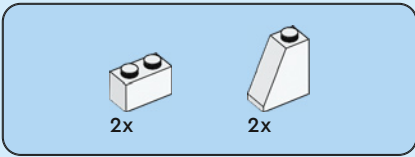

9

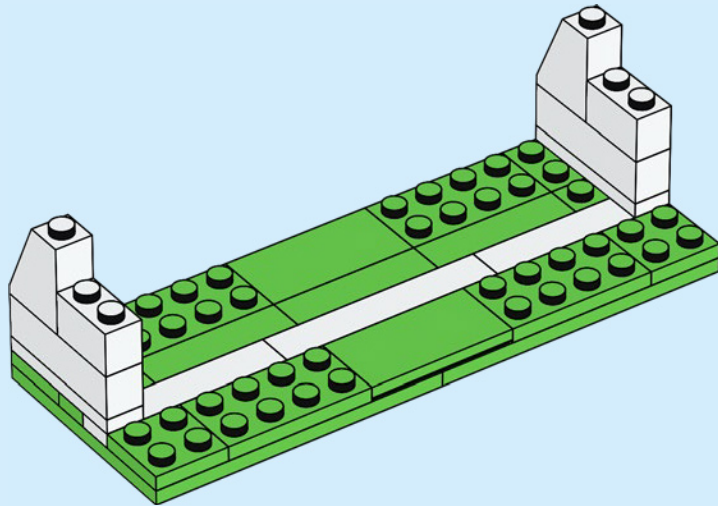



2x

10

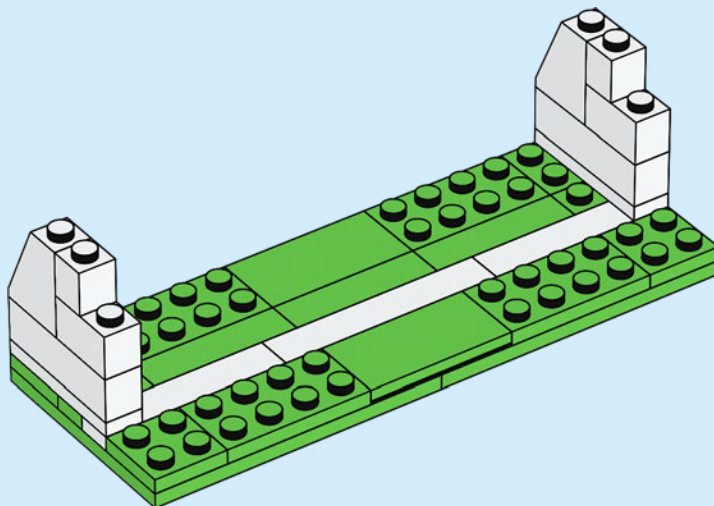

2x



2x

11

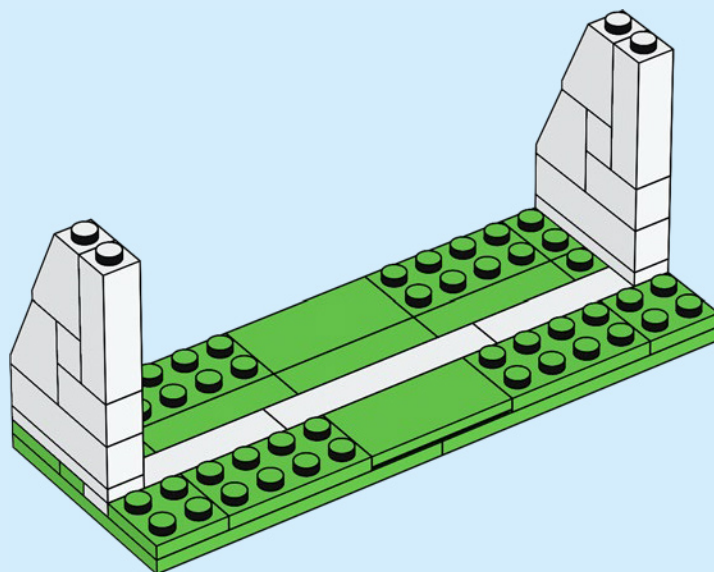



2x

12

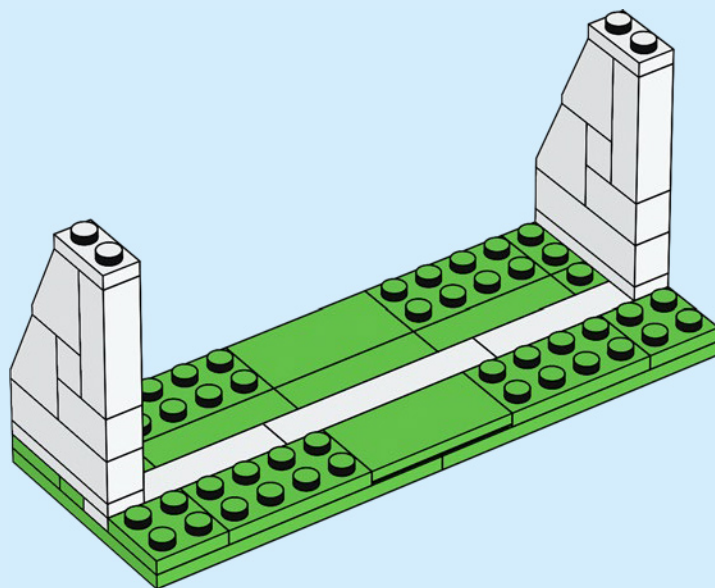

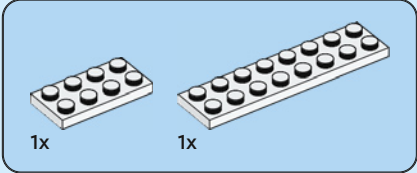
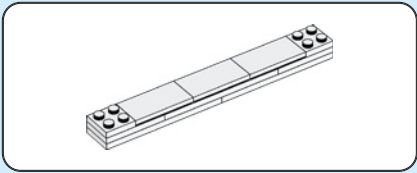

13

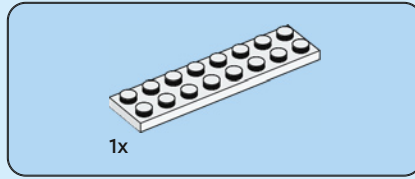
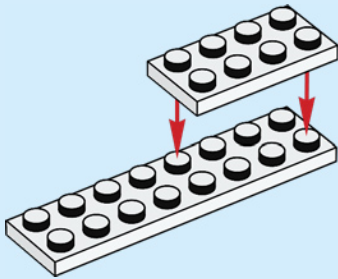

14

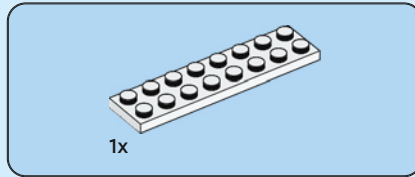
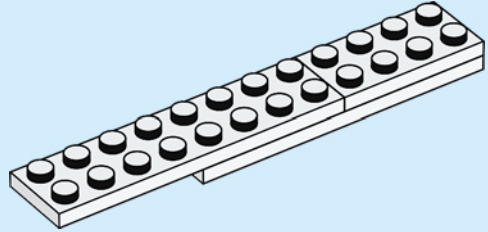

15

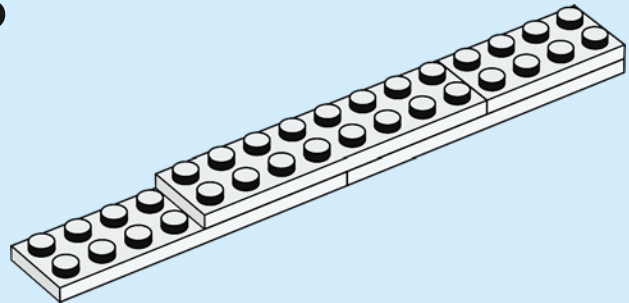

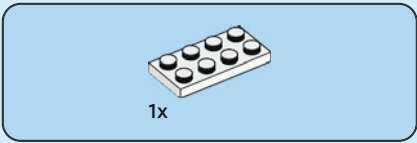

16

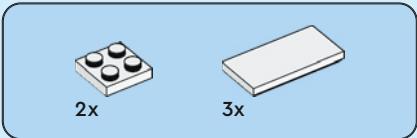
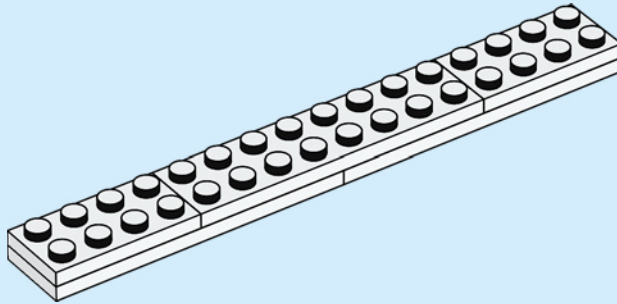

17

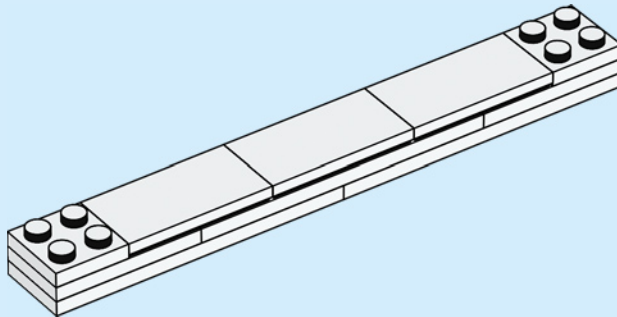

18

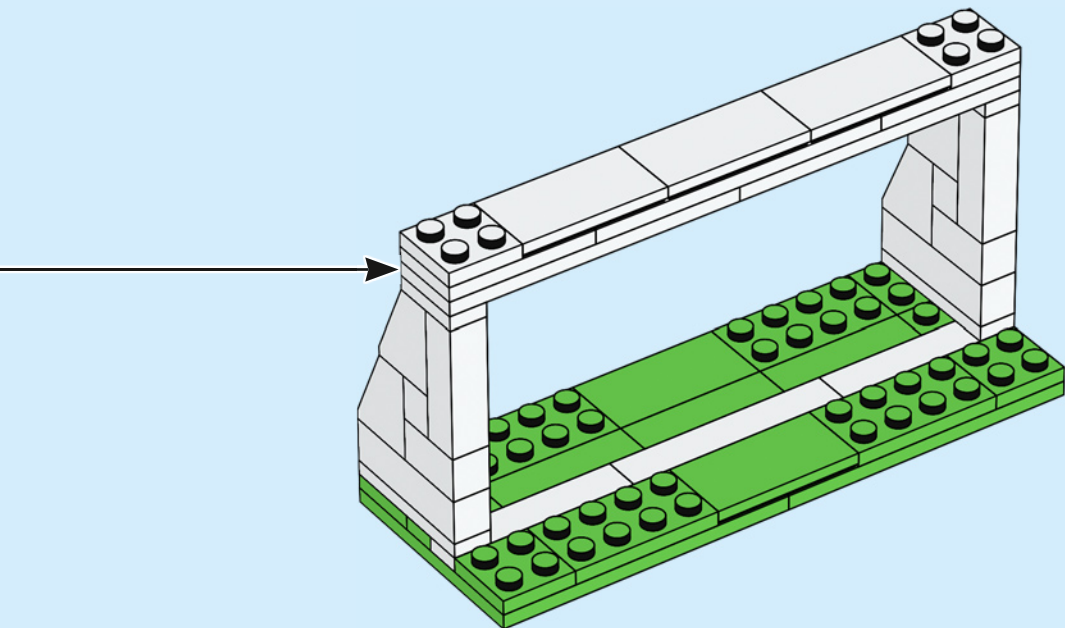

19

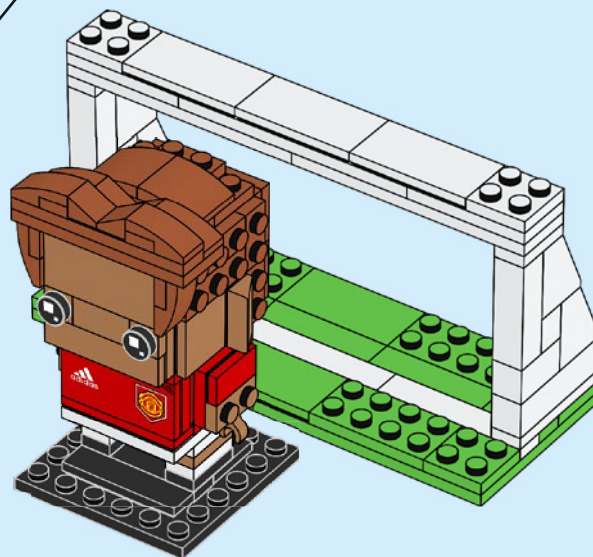
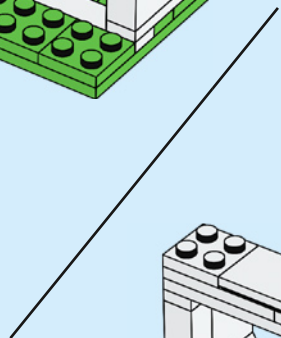
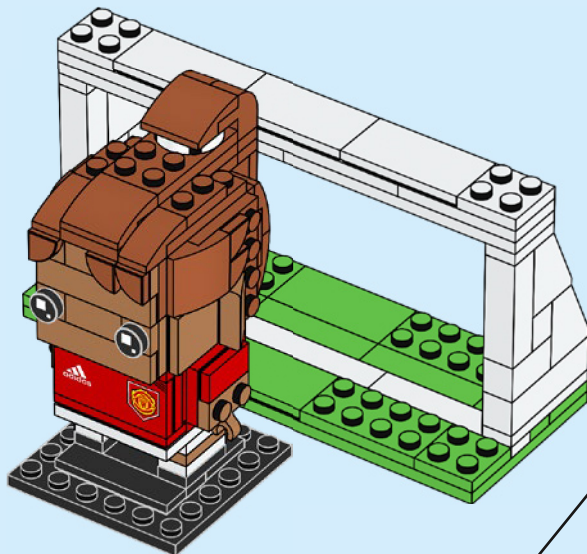





MAN
UTD





2x
302401

2x
300501

2x
6055541

2x
403201

2x
300401

4x
4515370

4x
302301

2x
302201

2x
243101

2x
371001

2x
301001

2x
301001

3x
4560178

3x
302001

1x
6122047

1x
663601

1x
4243812

3x
303401

4x
4159553

1x
4125253

2x
4624086

1x
6092587

3x
4113917

2x
6313119

1x
4114026

2x
4185177

4x
4114084

2x
4550324

1x
6122047

4x
4113233

10x
4114309

2x
302321

2x
306921

3x
302221

2x
6118830

2x
371021

2x
243121

1x
6404513

2x
302021

3x
4560179

4x
6223040

5x
6188477

6x
6104342

7x
6228968

6x
4570877

6x
6186009

2x
6186021

6x
4615606

6x
6104344

8x
6186007

2x
6263221

3x
6074892

9x
4535928

1x
6253418

1x
6219673

6x
6029947

5x
4550348

6x
302324

2x
6361082

6x
302224

6x
6079007

8x
362324

2x
362224

3x
371024

4x
301024

9x
302024

1x
366624

1x
379524

6x
4504381

7x
6195183

4x
302424

2x
6184784

6x
6053077

8x
362326

2x
362226

3x
371026

1x
6254045

1x
243126

1x
4560182

9x
302026

1x
366626

1x
395826



5x
4548180



4x
301026



2x
6284077



4x
302426



6x
4504382



6x
302226



7x
6172383



6x
6047276



8x
302326



1x
6208551

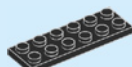

1x
379526



2x
6314091

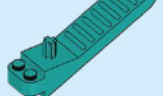

1x
6254100



3x
6138624



2x
6343326



4x
6357612



3x
6195267



4x
6141590



2x
6282120

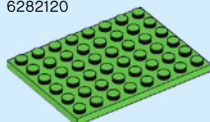

2x
6340684



2x
6146701



2x
6258094



2x
4653988



2x
6103415



2x
4271949



8x
4221744



6x
4504376



1x
4211288



7x
6149677



7x
6035291



11x
4211150



6x
6069984



2x
6313124



1x
6092590



2x
6335567



1x
4211151



10x
4216695



4x
4211225



6x
6146858



8x
4211152



2x
4211220



2x
4211194



7x
4211190



19x
4211186



1x
4579690



1x
4221590



1x
4211247



14x
6123809



1x
4550359



1x
4622176



1x
6292154



4x
6215606



1x
6177146



2x
6218358



2x
6313132



3x
6218360



1x
6021997



2x
6102990



4x
6056383



2x
6102998



10x
6093494



1x
6218359



4x
6167700

Customer Service
 Kundenservice
 Service Client
 Assistenza clienti
 Atención al cliente
 Serviço de Apoio ao Consumidor
 Ügyfélszolgálat
 Klientu apkalpošanas dienests
 Serviciul pentru clienț
 客户服务
 コンシューマーサービス
 고객 서비스
LEGO.com/service

WIN

Terms & Conditions apply

Scan this QR code or go to **LEGO.COM/PRODUCTFEEDBACK** and give us your short feedback about this LEGO® set for a chance to win a cool LEGO prize.



GEWINNE

Scanne diesen QR-Code oder geh auf LEGO.COM/PRODUCTFEEDBACK

und gib uns dein kurzes Feedback zu diesem LEGO® Set. Dann hast du die Chance, einen coolen LEGO Preis zu gewinnen.

Es gelten die Teilnahmebedingungen

GAGNE

Scannez ce code QR ou rendez-vous sur LEGO.COM/PRODUCTFEEDBACK

pour donner votre avis sur ce produit LEGO® et avoir une chance de gagner un prix LEGO.

Voir Conditions Générales

GANAN

Escanea este código QR o visita LEGO.COM/PRODUCTFEEDBACK

y comparte con nosotros tu opinión sobre este set LEGO® para tener la oportunidad de ganar un fantástico premio LEGO.

Términos y Condiciones aplicables

获取奖品

只需扫描此二维码或访问 LEGO.COM/PRODUCTFEEDBACK,

就这款乐高®套装提供简短反馈, 就有机会赢得很酷的乐高奖品。

《条款及条件》适用

LEGO and the LEGO logo are trademarks of the LEGO Group. ©2022 The LEGO Group.
Crest © 1997 Manchester United Football Club Ltd
Adidas, the 3-bars logo and 3-Stripes mark are registered trademarks of adidas, used with permission.

6429046