



# CREATOR™

40568



 [LEGO.com](https://www.LEGO.com)



Stiamo passando dagli imballaggi di plastica a quelli basati su carta. Ecco perché potrete trovare un mix di carta e di plastica nelle nostre confezioni!

Estamos sustituyendo las bolsas de plástico por bolsas con base de papel. ¡Por eso, puede que encuentres una mezcla de papel y de plástico en nuestras cajas!

Estamos a substituir as nossas embalagens de plástico por embalagens à base de papel. Por isso poderá encontrar um misto de papel e plástico nas nossas caixas!

Átállunk a műanyagról a papír alapú csomagolásra. Ezért előfordulhat, hogy a dobozainkban papír és műanyag zacskót egyaránt találsz!

We're switching from plastic to paper-based packaging. That's why you might find a mix of paper and plastic in our boxes!

Wir stellen von Kunststoffverpackungen auf Verpackungen auf Papierbasis um. Möglicherweise findest du deshalb sowohl Papier als auch Kunststoff in unseren Boxen!

Nous abandonnons progressivement les emballages en plastique au profit d'emballages à base de papier. Il est donc possible que vous trouviez à la fois du papier et du plastique dans nos boîtes !

Mēs pārejam no plastmasas iepakojuma uz iepakojumu, kurā izmantots papīrs. Tāpēc mūsu kārbās var būt gan papīra, gan plastmasas daļas.

Trecem de la ambalajele din material plastic la ambalaje pe bază de hârtie. Iată de ce s-ar putea să găsești un amestec de hârtie și material plastic în cutiile noastre!

我们正在从塑料包装向纸基包装过渡。这就是为什么你可能会发现我们的包装盒中同时出现塑料和纸质材料！

**LEGO.com/sustainable-packaging**



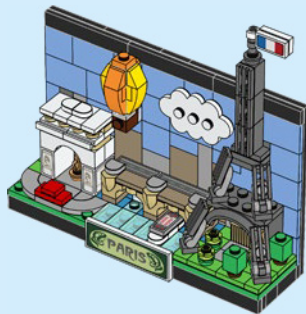
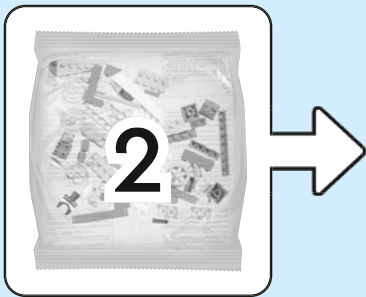
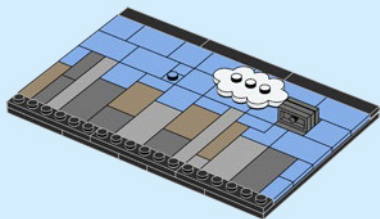
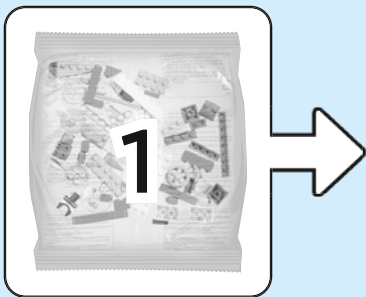

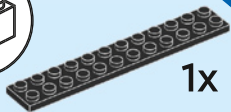

1x

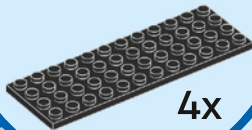

4x

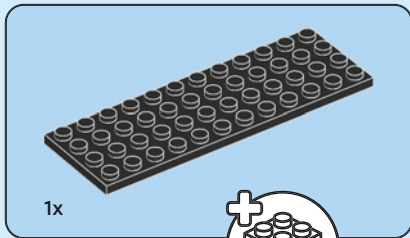

1x

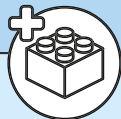

1

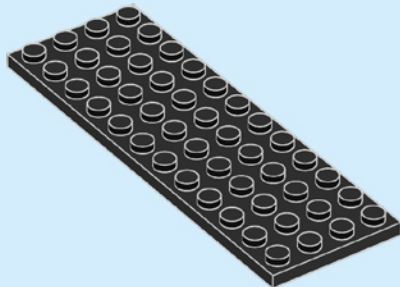

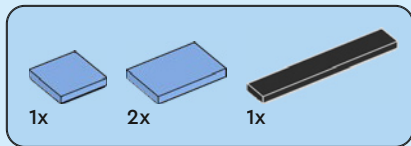

2

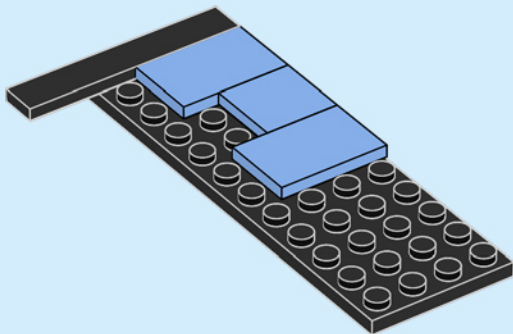

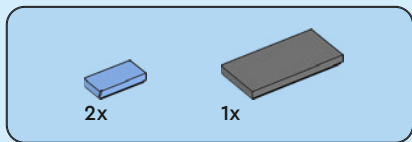

3

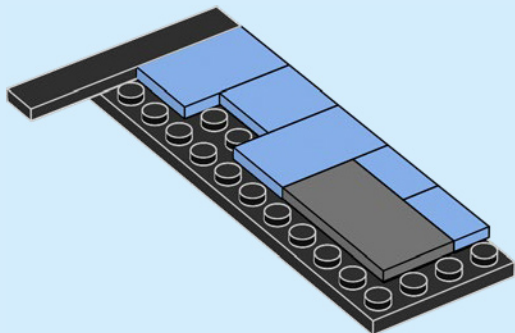

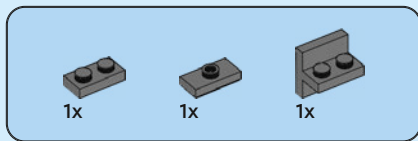

4

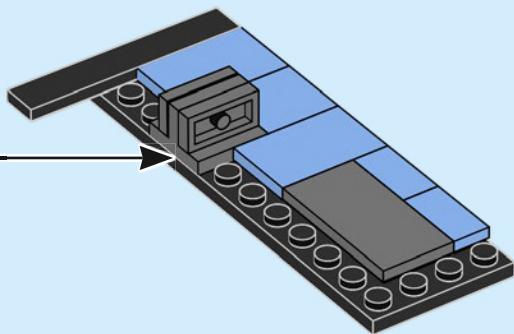
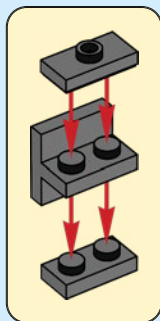



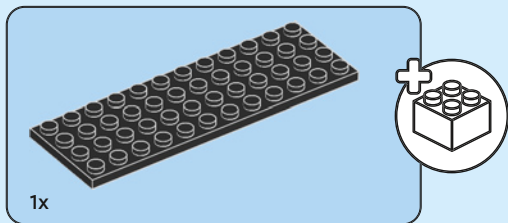

5

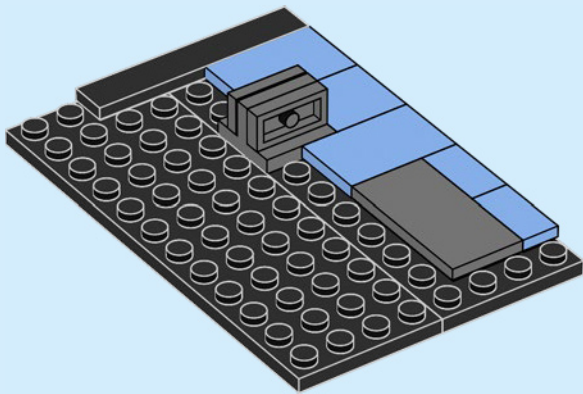

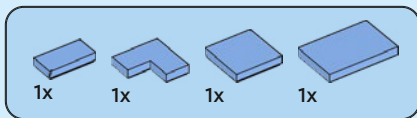

6

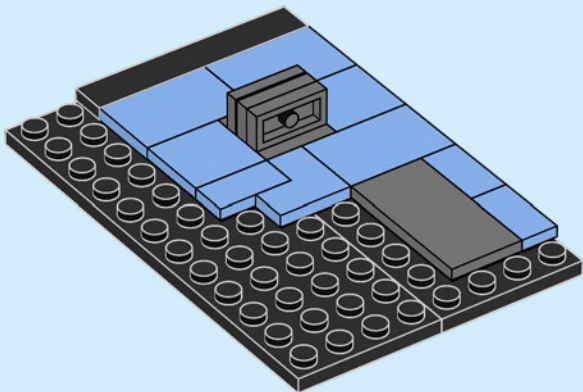

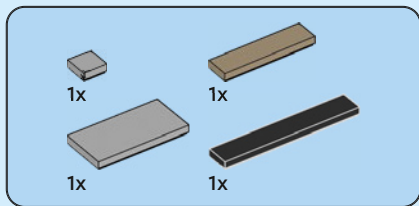

7

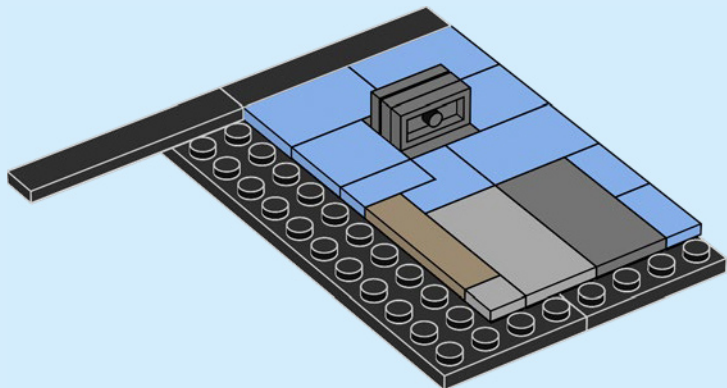

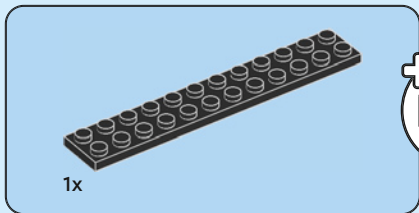

8

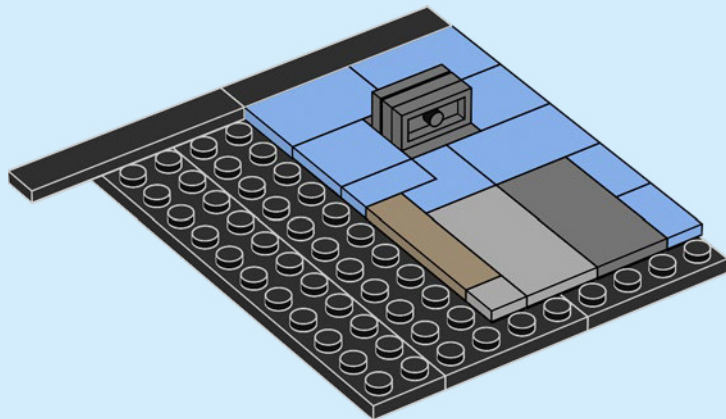

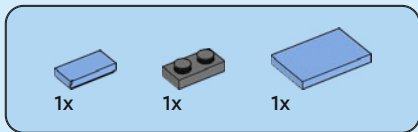

9

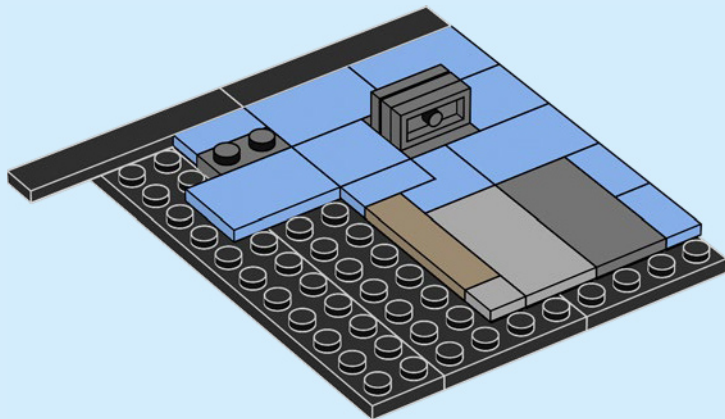

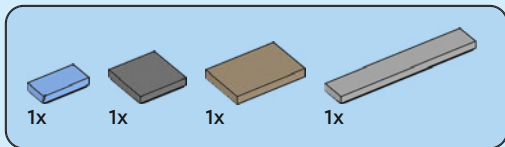

10

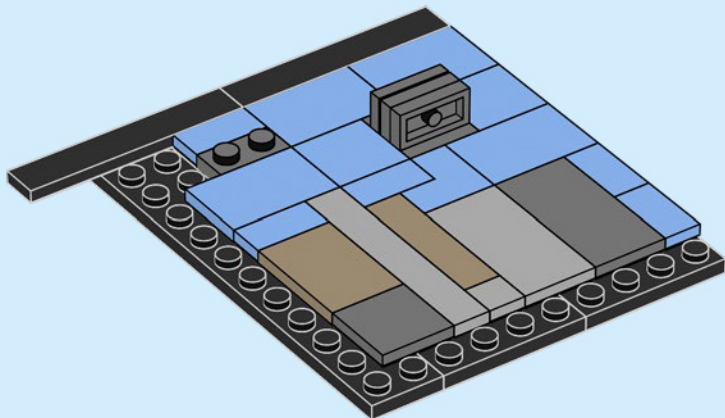



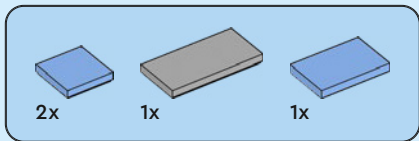

12

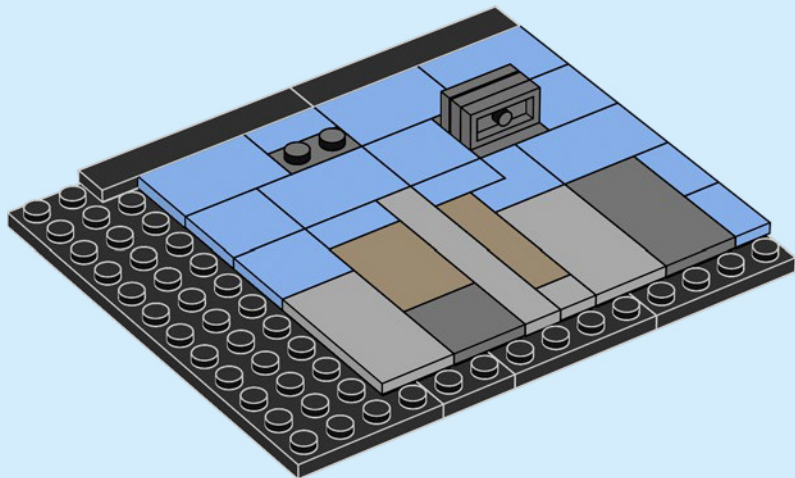



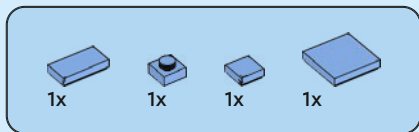

13

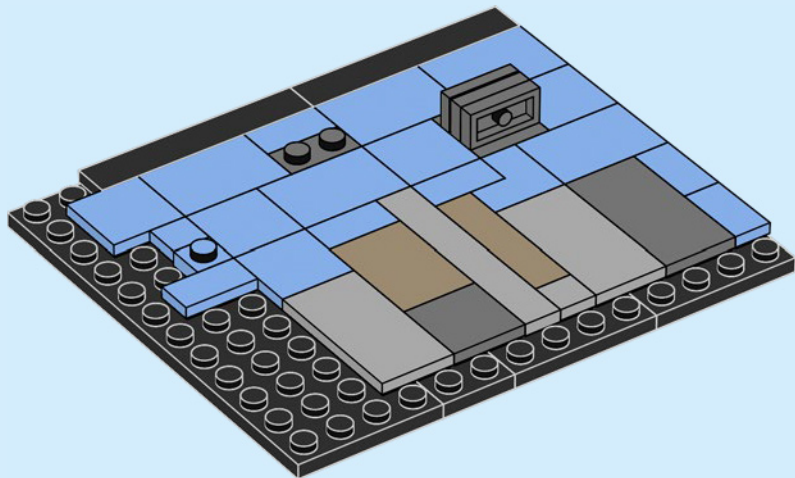

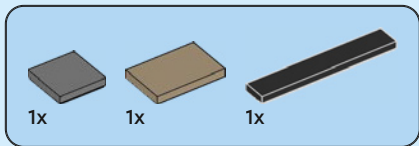

14

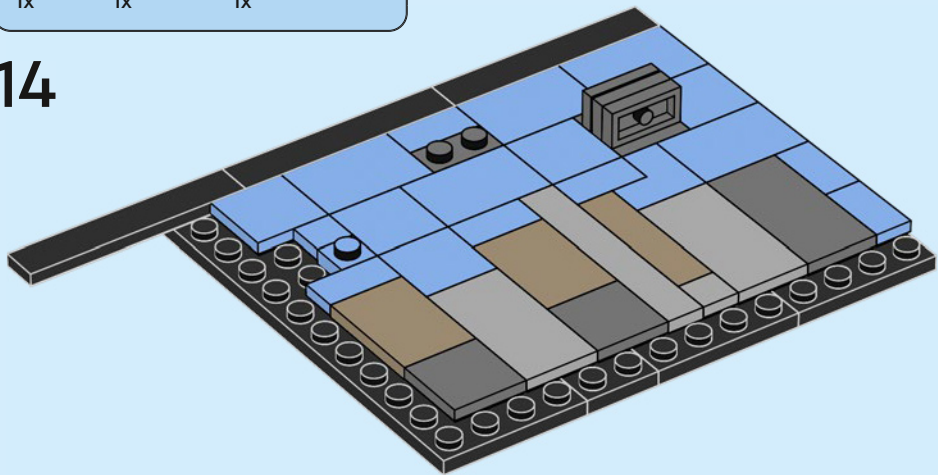

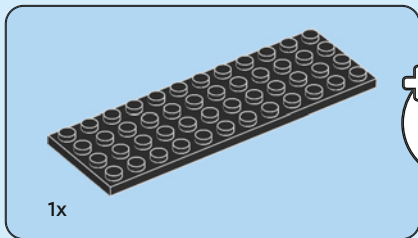

15

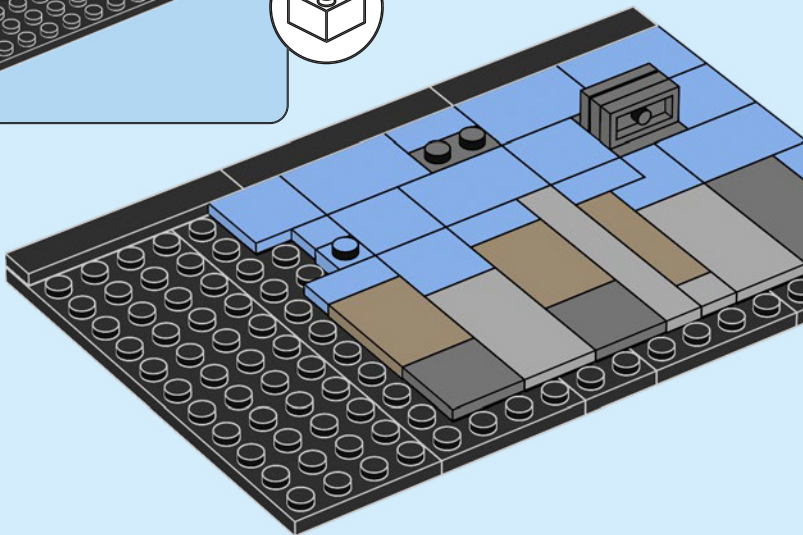



1x

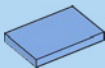

3x

# 16

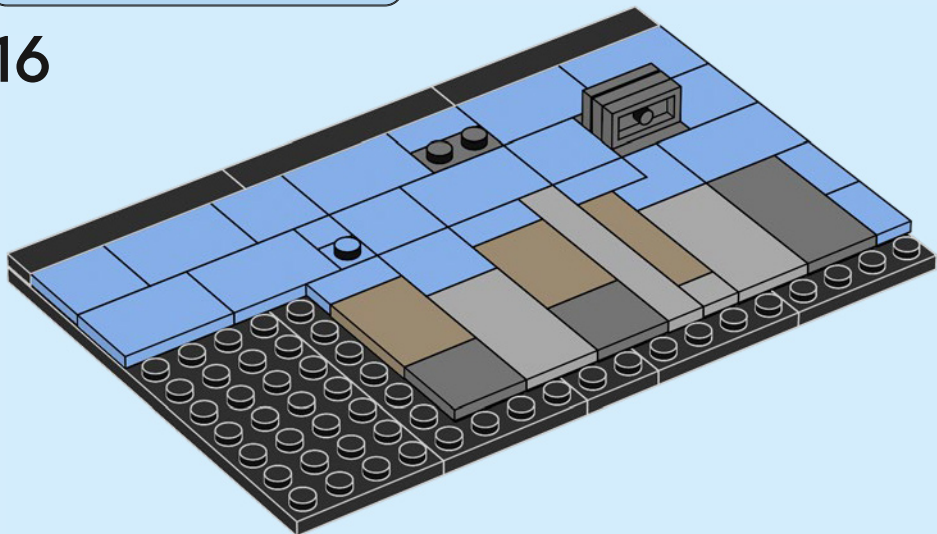

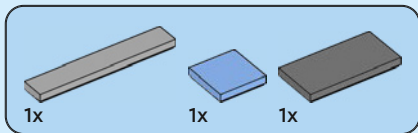

17

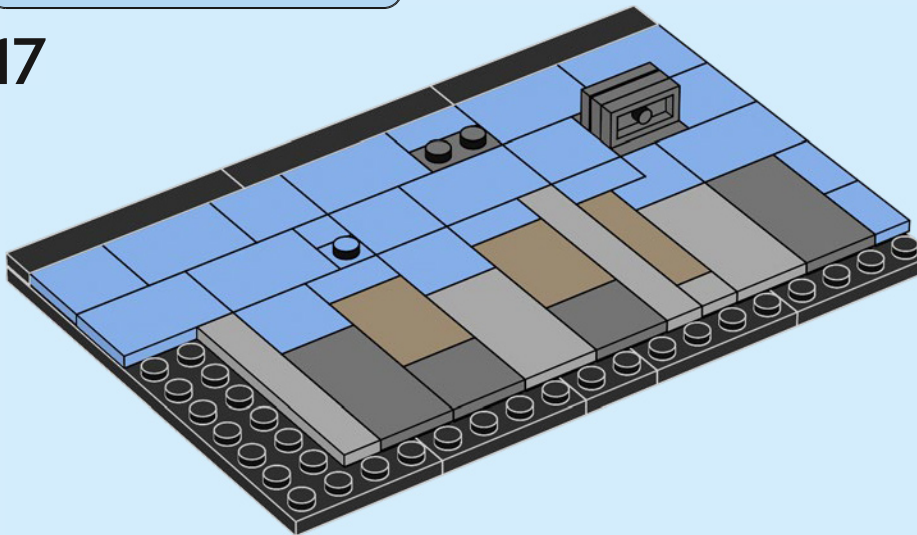

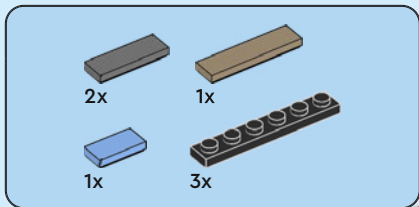

18

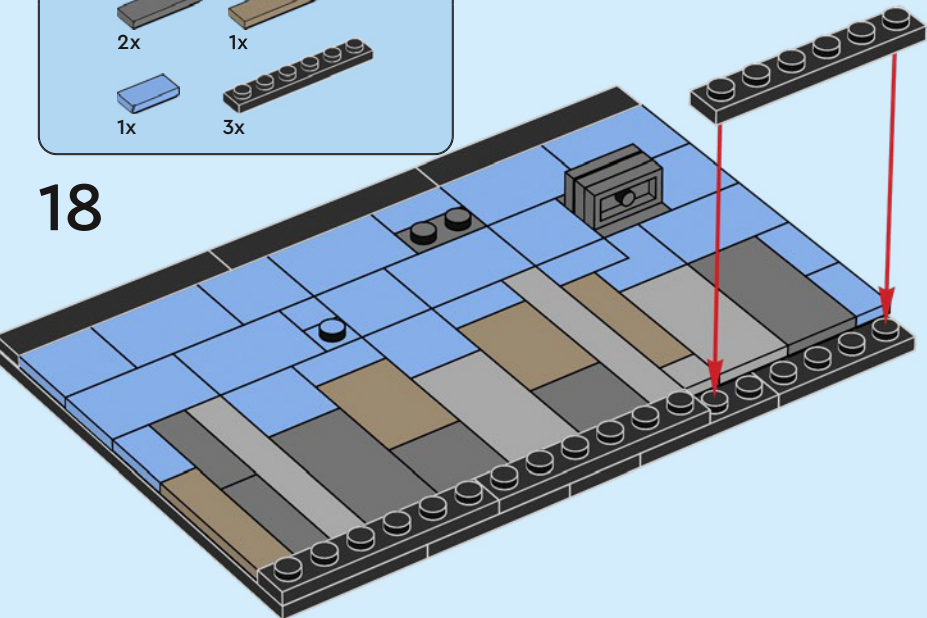

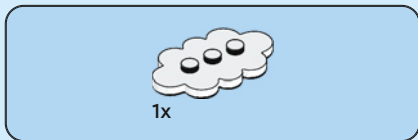

19

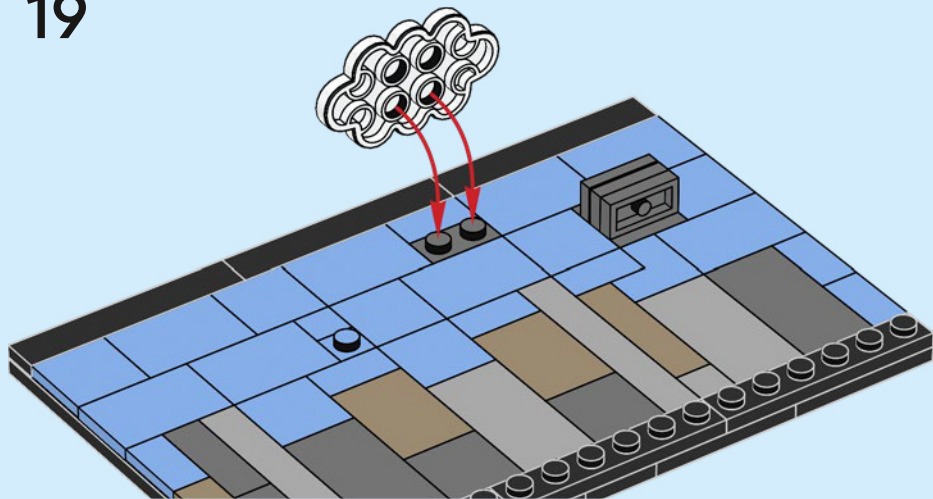

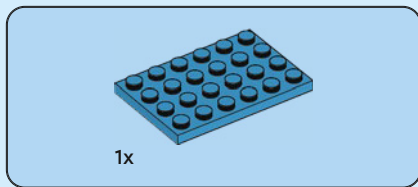

20

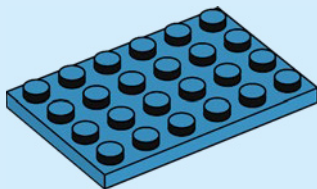



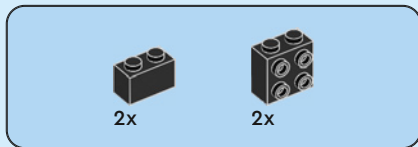

21

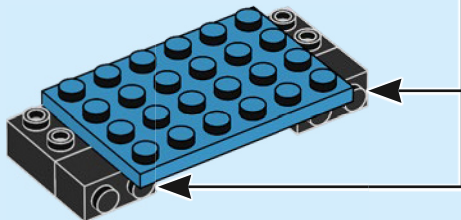
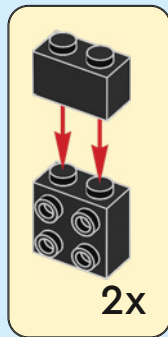

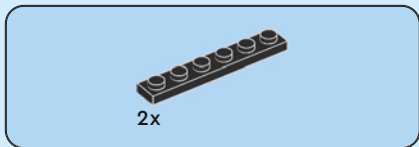

22

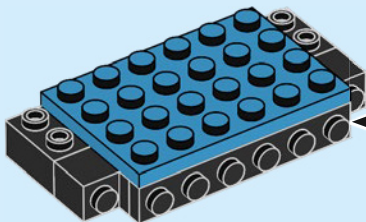
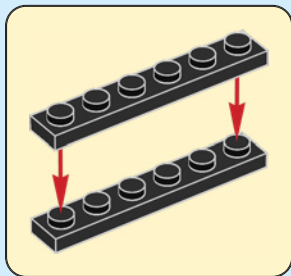

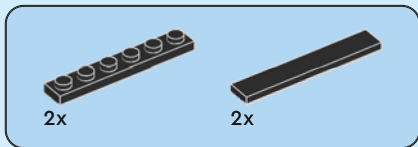

23

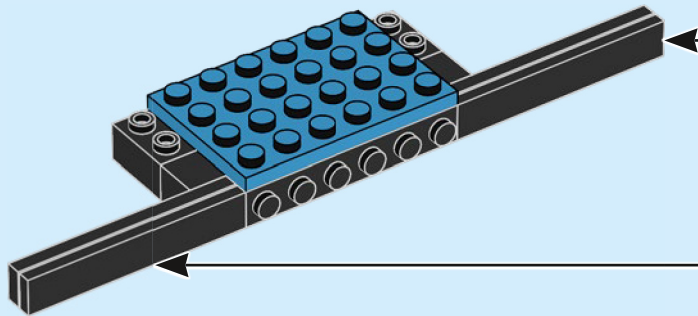
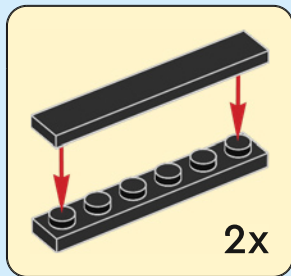

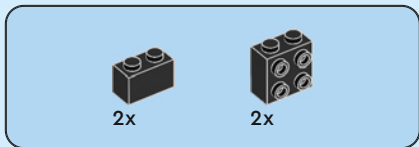

24

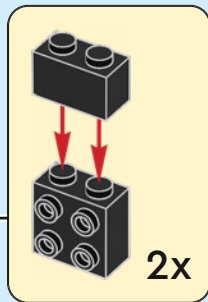
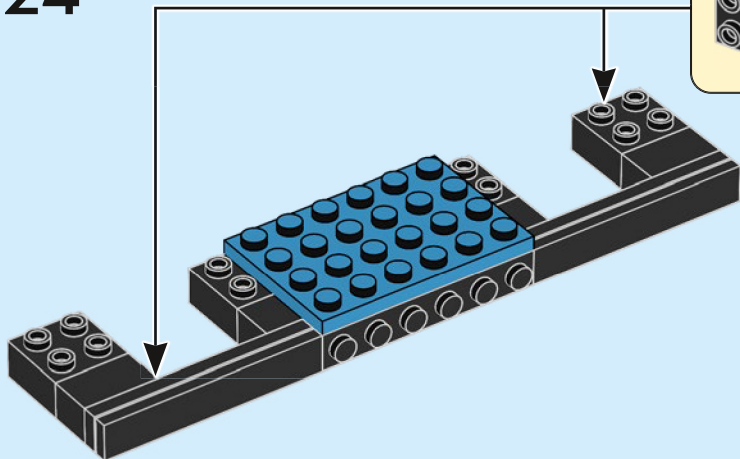

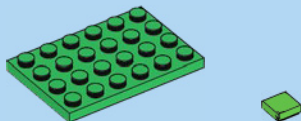
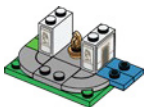

1x

2x

25

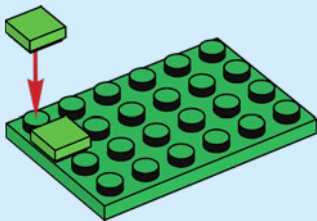

1x

26

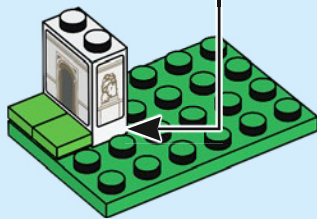
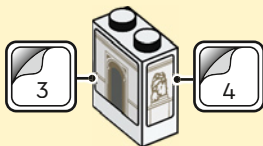



1x



1x

# 27

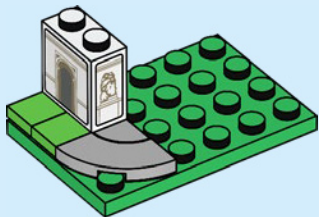

1x



1x

# 28

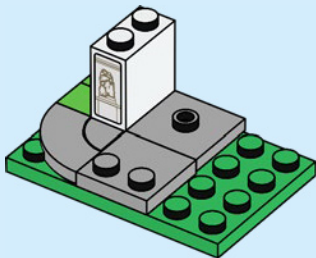



1x



1x

# 29

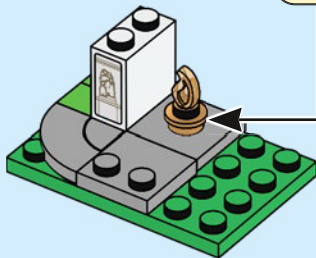
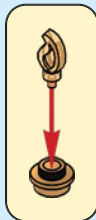

1x



1x

# 30

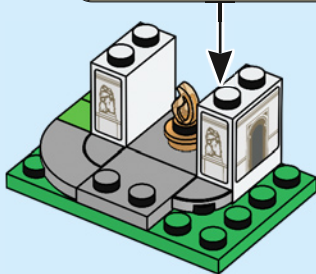
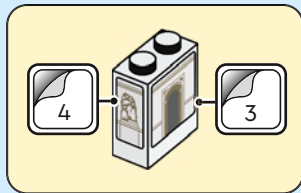



2x



1x

# 31

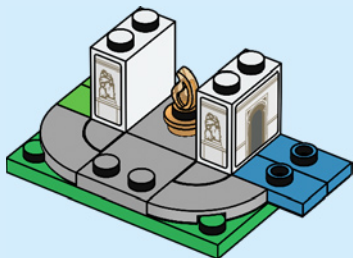



32

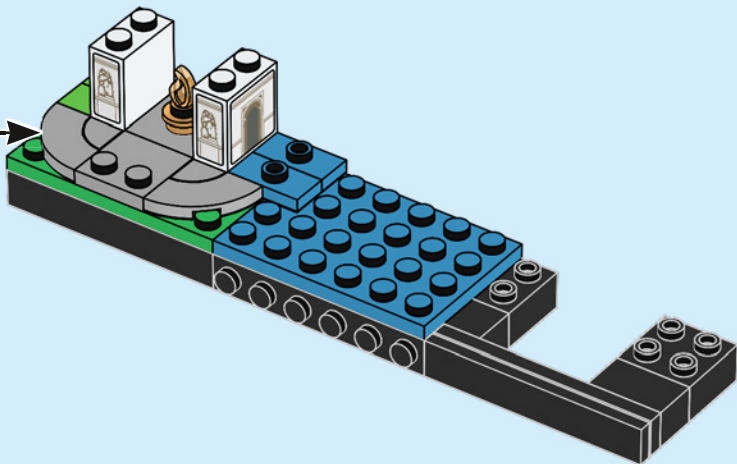

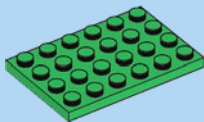

1x

33

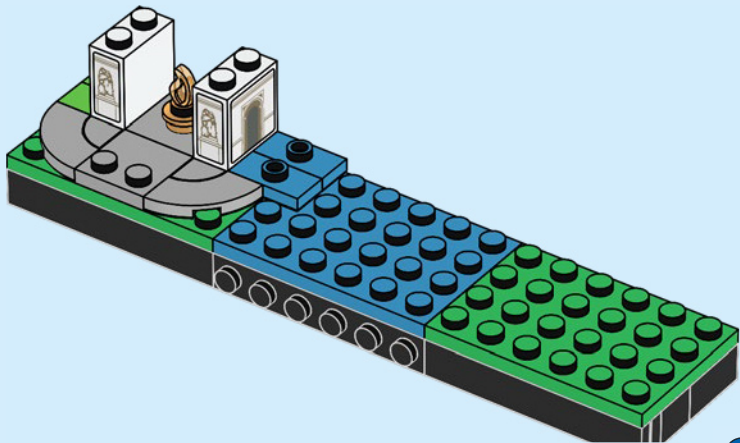

34





1x



1x

# 34

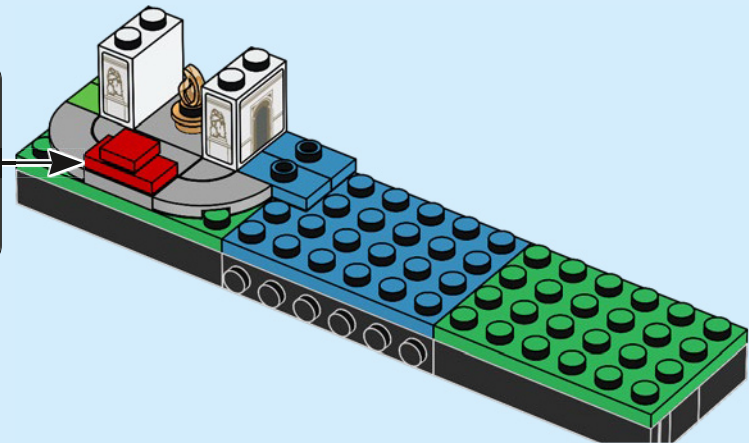
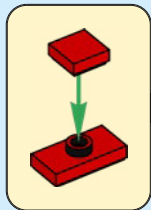



2x



1x

# 35

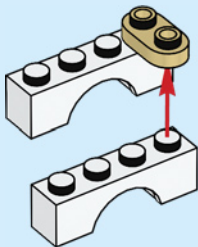

36



3x

# 36

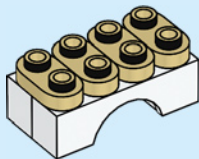



1x



2x

# 37

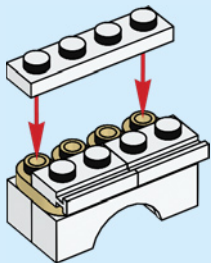

1x



4x

# 38

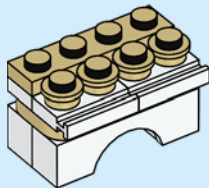



2x



2x

# 39

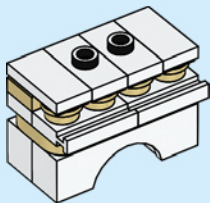

2x

# 40

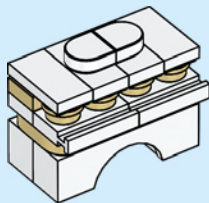

41

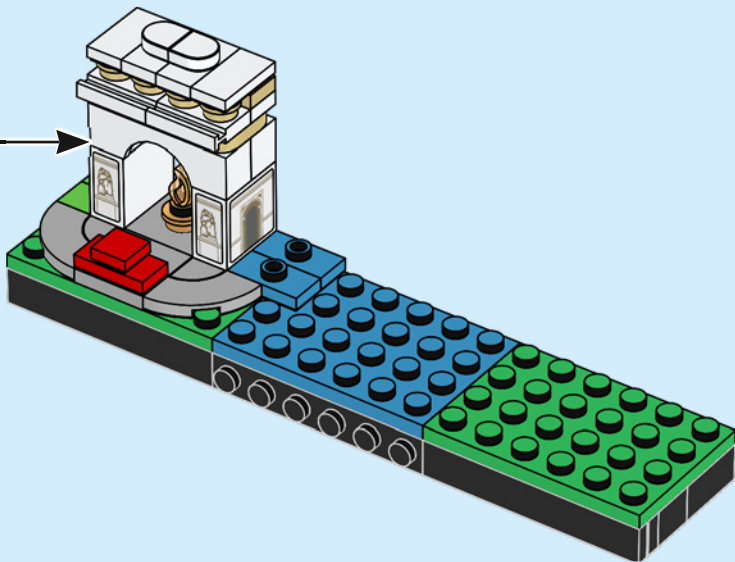



4x



2x

42

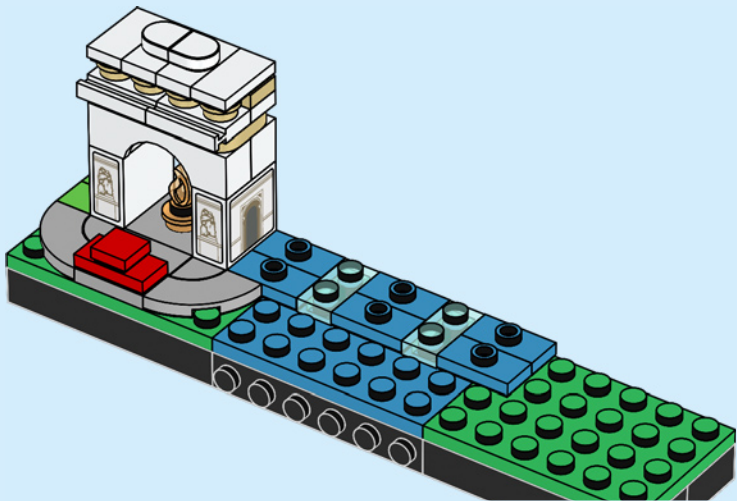





1x



5x

43

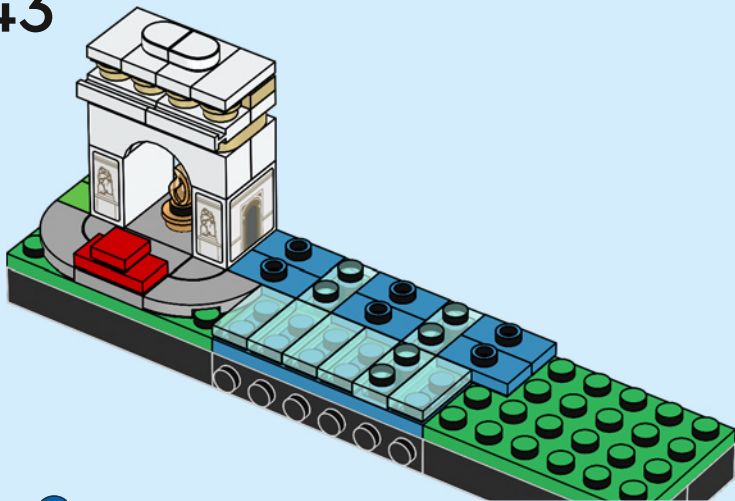



1x



1x



44

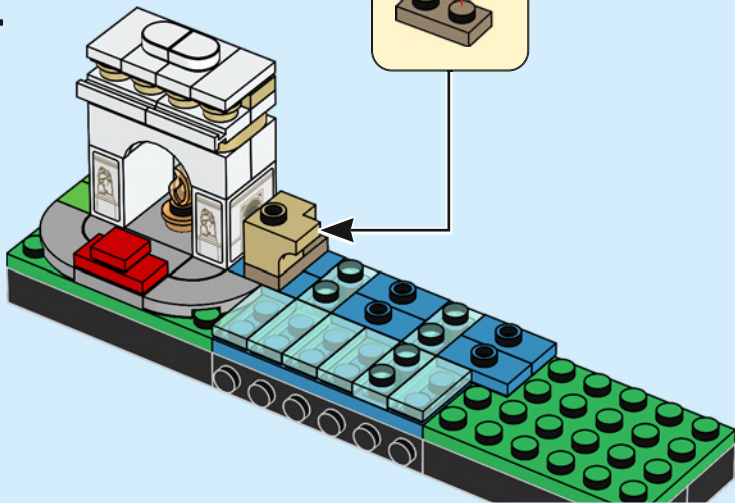



2x

45

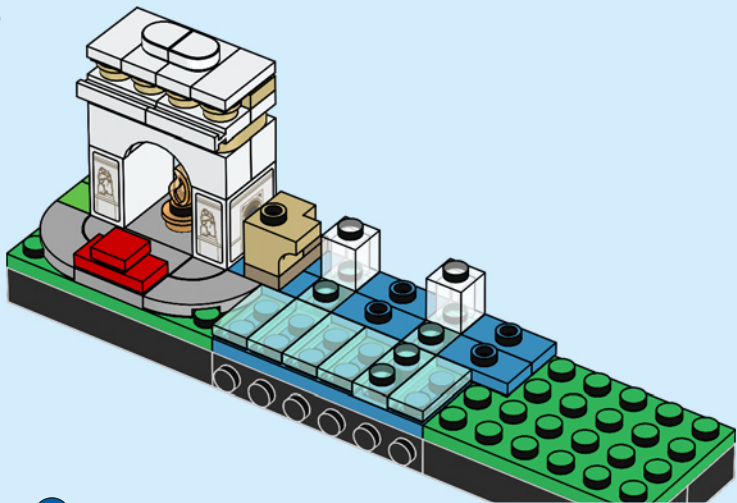



1x



2x

# 46

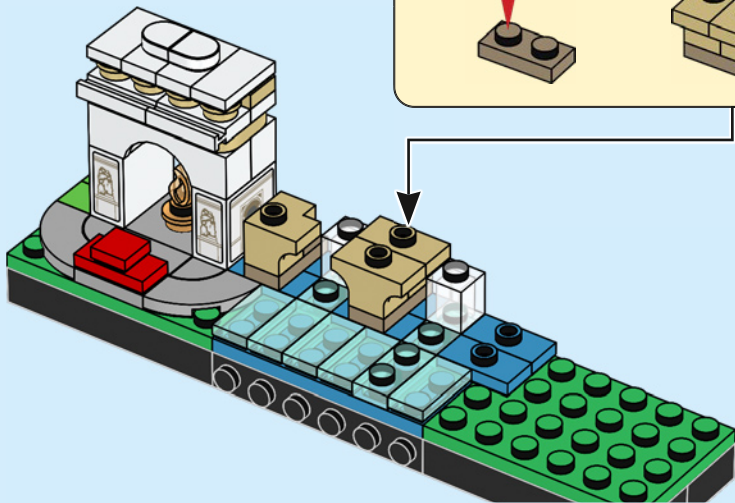

1

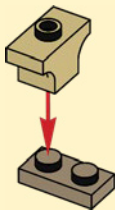

2

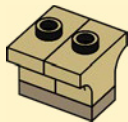



1x



2x

47

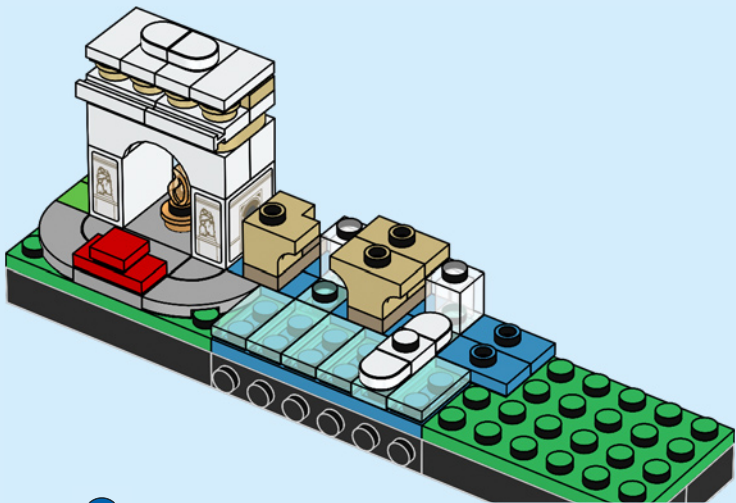

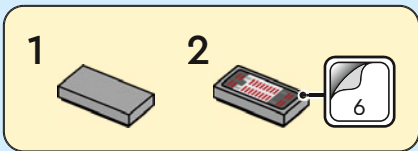
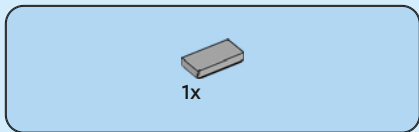

48

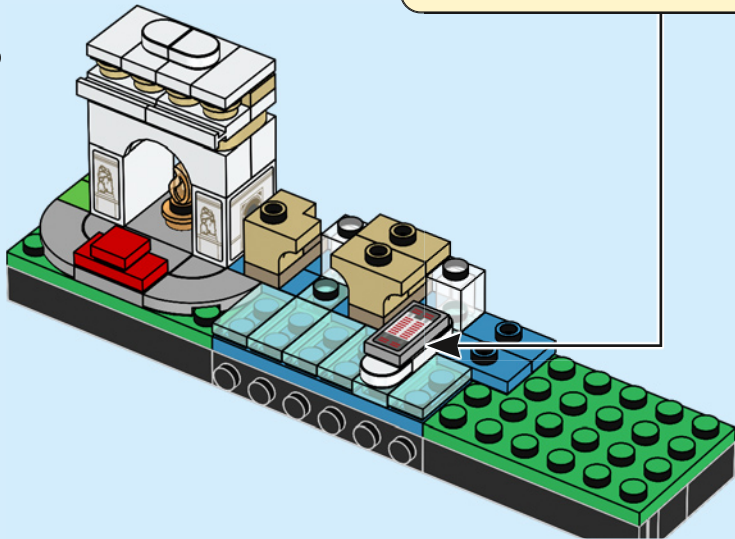

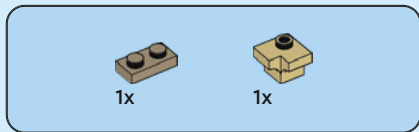

49

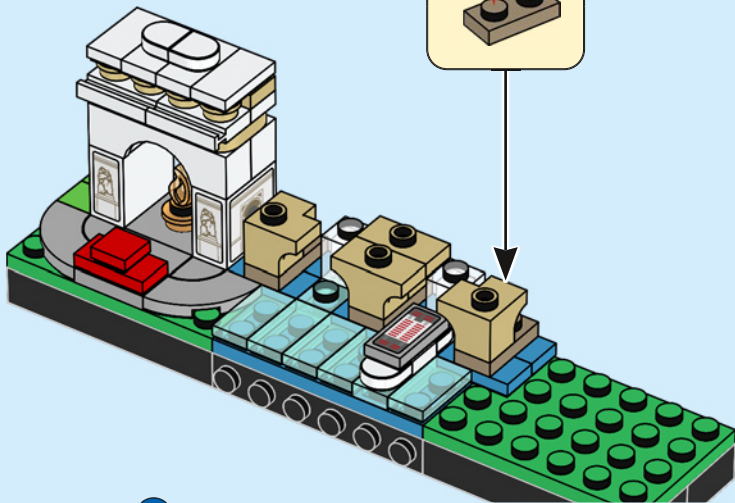
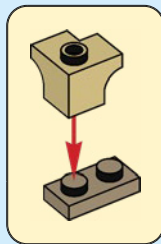



3x



3x

50

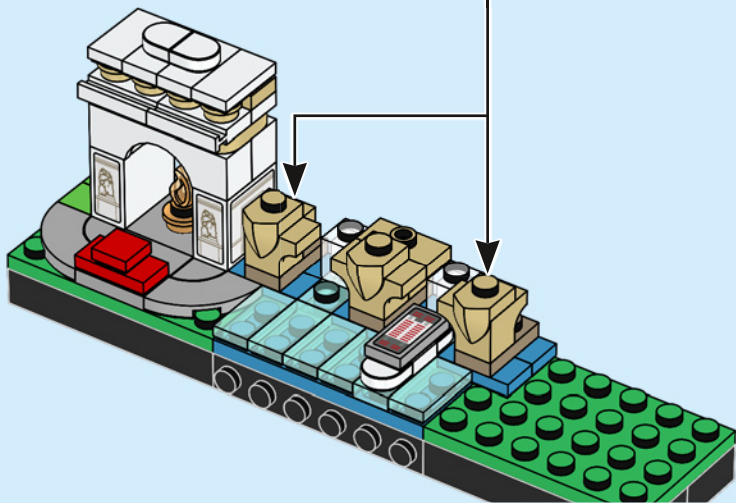





2x



2x

# 51

1



2



2x

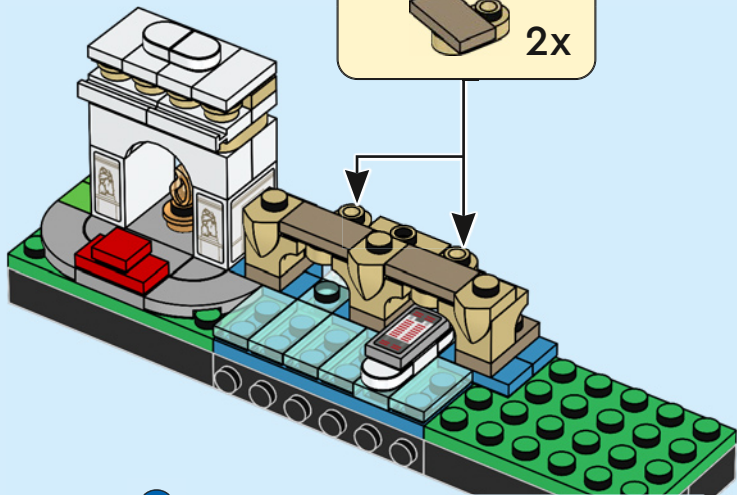

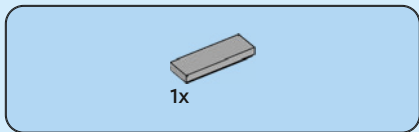

52

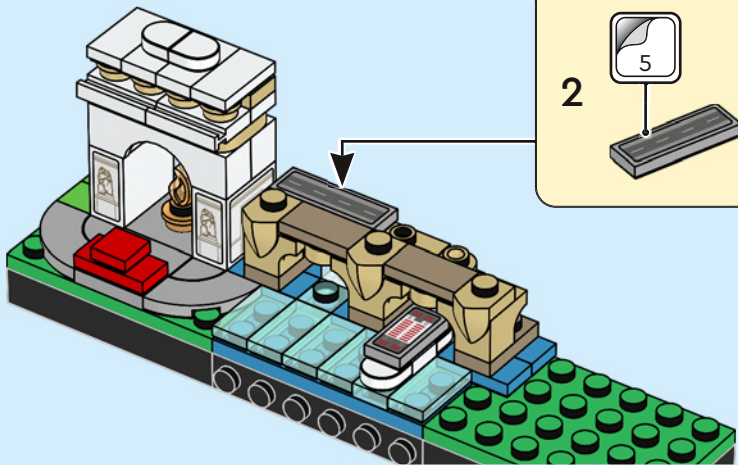

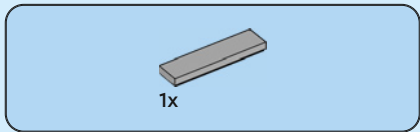

53

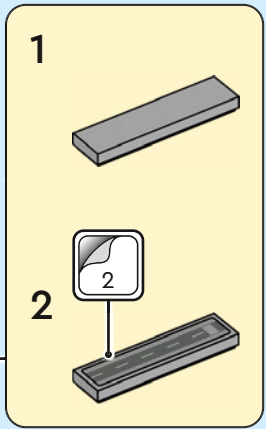
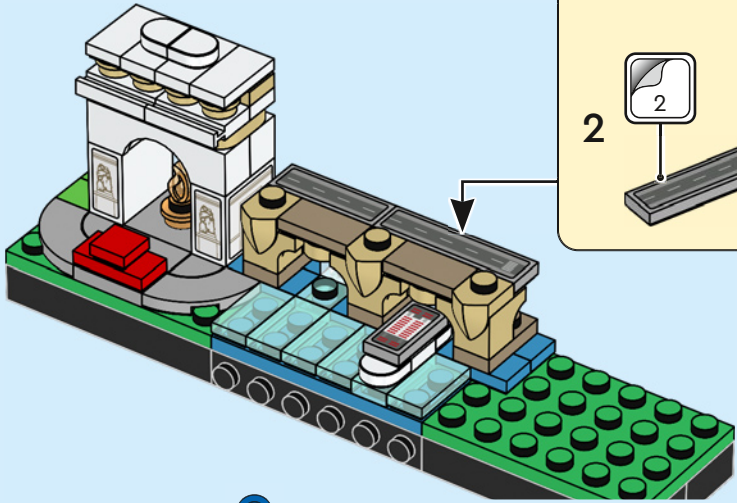



3x

54

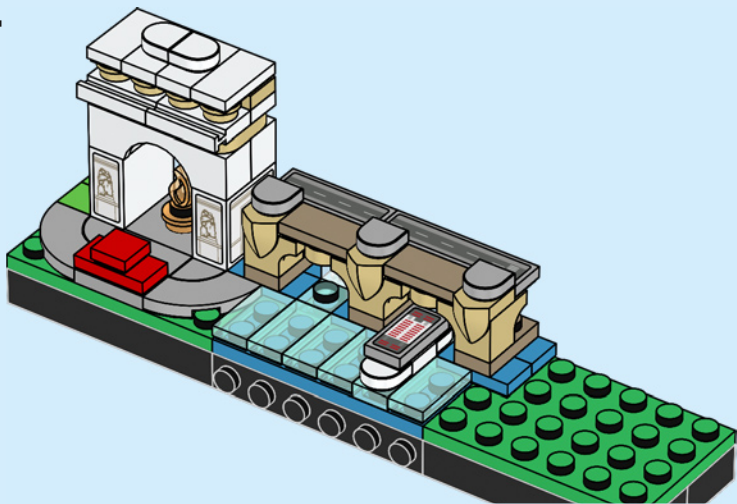



1x



2x



1x



2x

# 55

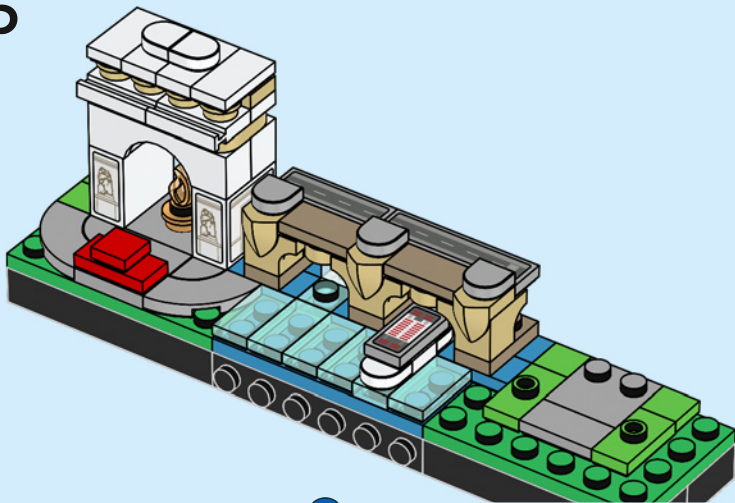



5x

56

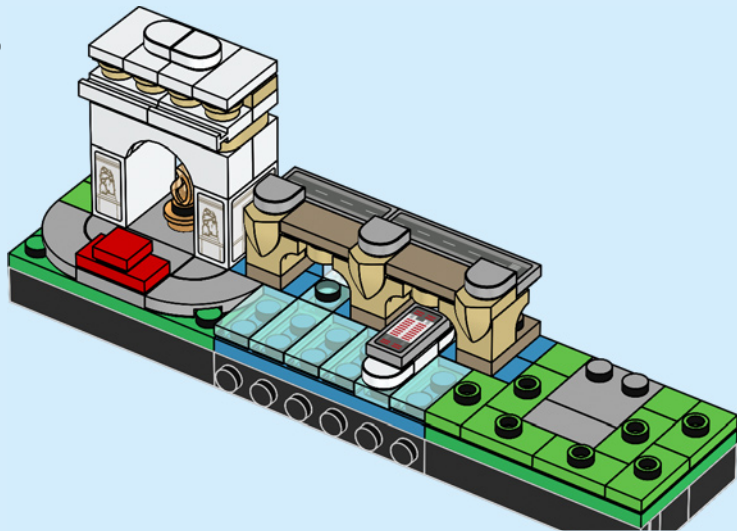



1x



1x

57

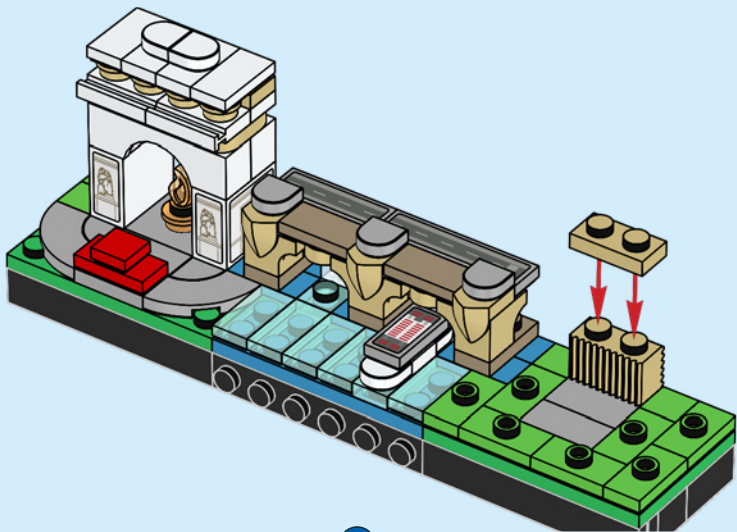



58

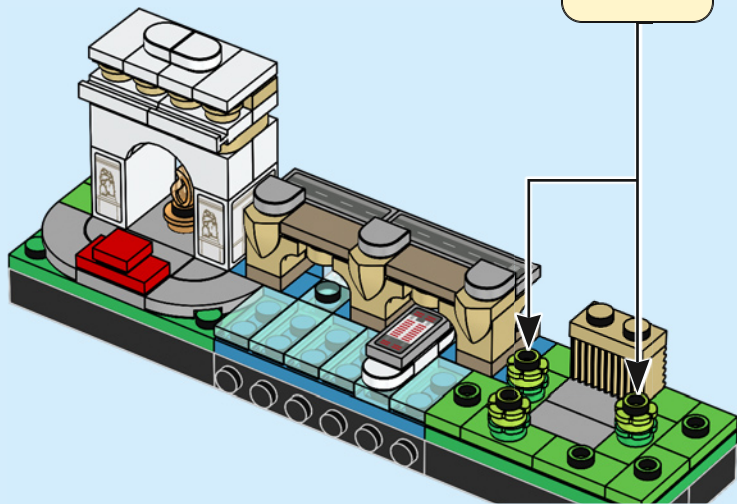







1x



2x

60

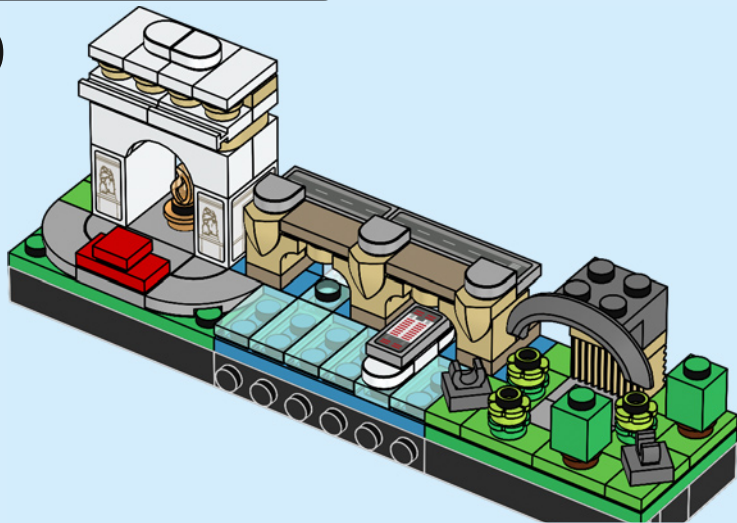



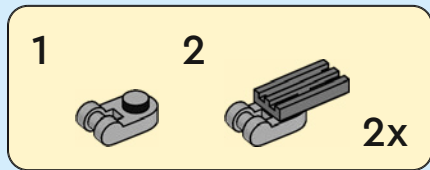
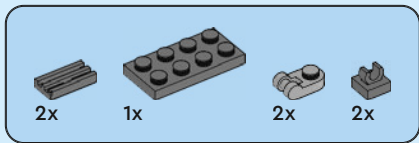

62

1

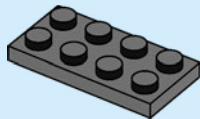

2

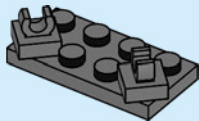

3

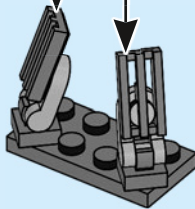

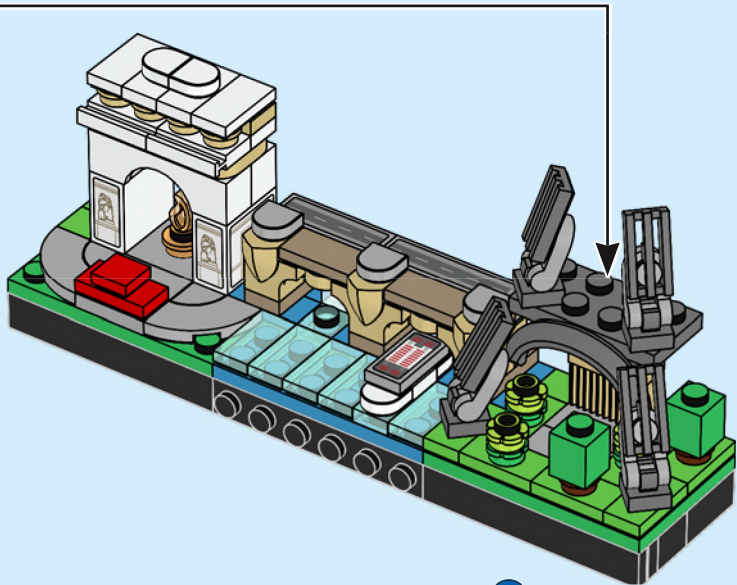

63

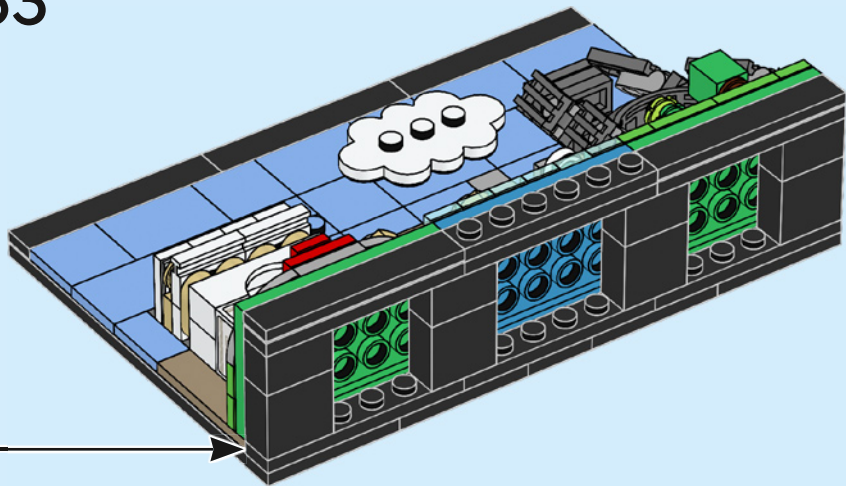



1x



1x

# 64

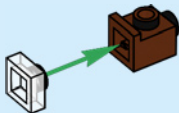

1x



1x

# 65

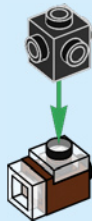



1x



1x

66



1x

67







1x

68



1x



1x

69

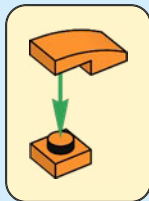



1x



1x

# 70

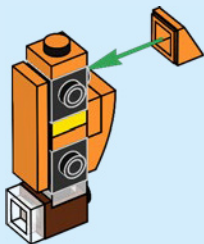

2x



2x

# 71

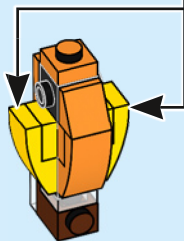
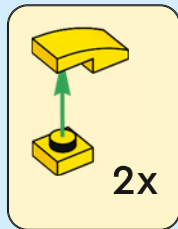



2x

72

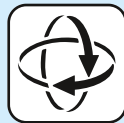
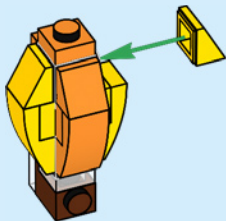

73

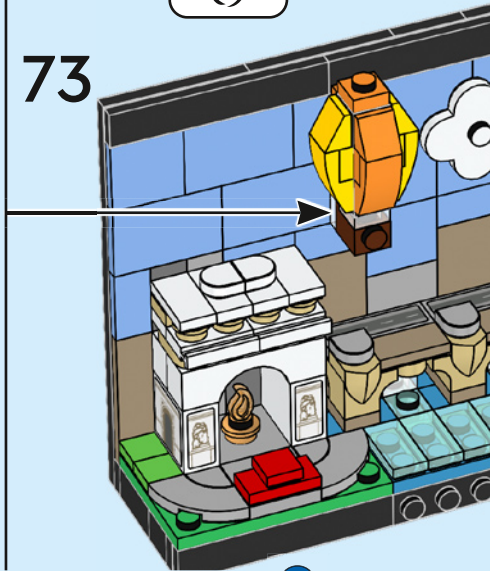

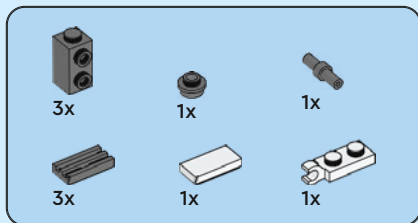

74

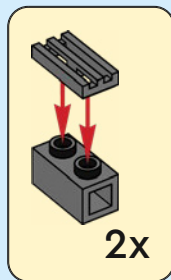

1

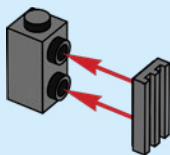

2

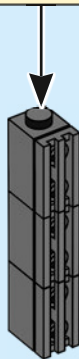

3



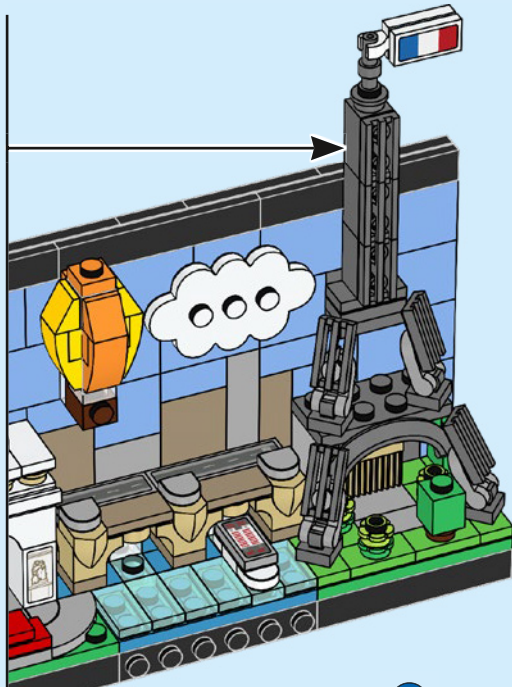
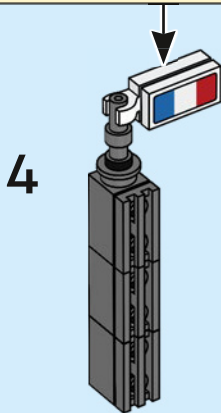
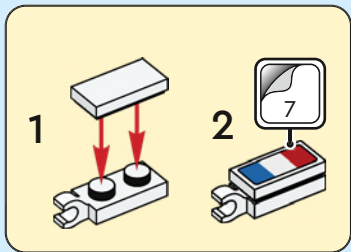

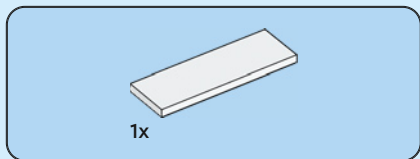

75

1

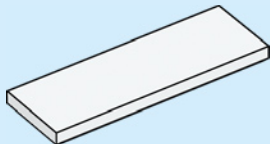

2

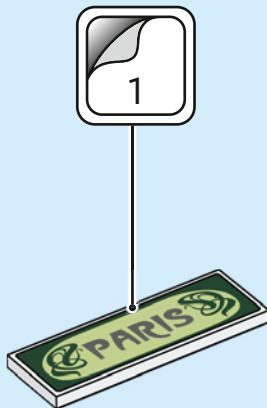

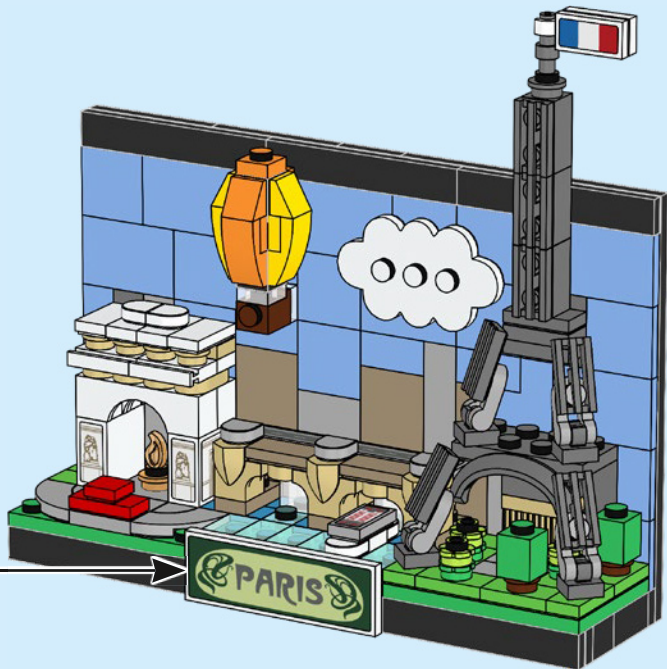



# CREATOR™







# CREATOR™

40519



40654





4x  
6250591



1x  
302401



2x  
4113261



3x  
306901



2x  
6051511



2x  
4249563



1x  
6361170



1x  
371001



2x  
365901



1x  
6223667

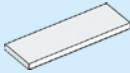

1x  
6332042



1x  
4113233



3x  
6143058



6x  
6212758



2x  
6236425



1x  
4655900



1x  
4113917



2x  
6236423



4x  
4161734



1x  
307021



1x  
6092565



3x  
302424



2x  
4504381



2x  
6029947



5x  
663626



7x  
366626



2x  
473326



4x  
300426



4x  
6275806

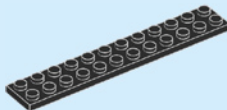

1x  
244526

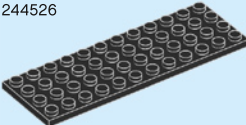

4x  
302926



4x  
6172375



3x  
6135287



2x  
300528



7x  
6314378

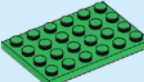

2x  
4116671

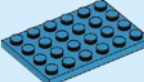

1x  
6343649



6x  
6151671



1x  
6190252



2x  
6220959



2x  
6252041



5x  
6251295



3x  
6240222



1x  
4179826



1x  
4527526



7x  
4168345



7x  
4528357



1x  
6167572



8x  
6211973



3x  
4524929



1x  
4504371



1x  
6055069



1x  
4620693



3x  
6209692



3x  
4528604



2x  
4496699



2x  
6328307



2x  
6175927



1x  
6357747



2x  
4216581



1x  
4225469



3x  
6250597



1x  
4211415



2x  
6176433



4x  
6225246



2x  
4211414



1x  
6126082



2x  
6212077



2x  
6163990



1x  
4558169



1x  
4211356



1x  
4211356



2x  
4211549



2x  
4560183



1x  
6231765



4x  
6344022



3x  
6228923



1x  
6350724



2x  
4211063



1x  
6092572



2x  
4568734



7x  
4210631



1x  
6250018



2x  
4211055



2x  
4560184



1x  
4211065



1x  
6170503

Customer Service  
 Kundenservice  
 Service Client  
 Asistencia clienti  
 Atención al cliente  
 Serviço de Apoio ao Consumidor  
 Ügyfélszolgálat  
 Klientu apkalpošanas dienests  
 Serviciul pentru clienți  
 客户服务  
 コンシューマーサービス  
 고객 서비스

[LEGO.com/service](http://LEGO.com/service)

# WIN

Terms & Conditions apply

Scan this QR code or go to **LEGO.COM/PRODUCTFEEDBACK** and give us your short feedback about this LEGO® set for a chance to win a cool LEGO prize.



## GEWINNE

Scanne diesen QR-Code oder geh auf **LEGO.COM/PRODUCTFEEDBACK**

und gib uns dein kurzes Feedback zu diesem LEGO® Set. Dann hast du die Chance, einen coolen LEGO Preis zu gewinnen.

Es gelten die Teilnahmebedingungen

## GAGNE

Scannez ce code QR ou rendez-vous sur **LEGO.COM/PRODUCTFEEDBACK**

pour donner votre avis sur ce produit LEGO® et avoir une chance de gagner un prix LEGO.

Voir Conditions Générales

## GANAN

Escanea este código QR o visita **LEGO.COM/PRODUCTFEEDBACK**

y comparte con nosotros tu opinión sobre este set LEGO® para tener la oportunidad de ganar un fantástico premio LEGO.

Términos y Condiciones aplicables

## 获取奖品

只需扫描此二维码或访问 **LEGO.COM/PRODUCTFEEDBACK**,

就这款乐高®套装提供简短反馈, 就有机会赢得很酷的乐高奖品。

《条款及条件》适用