



BRICK 'HEADZ

40559

LOONEY TUNES™



 [LEGO.com/brickheadz](https://www.LEGO.com/brickheadz)

WILE E. COYOTE™

162

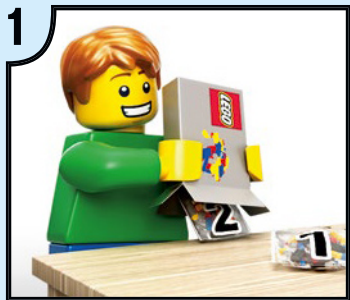

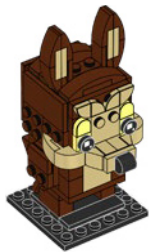
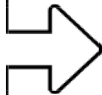

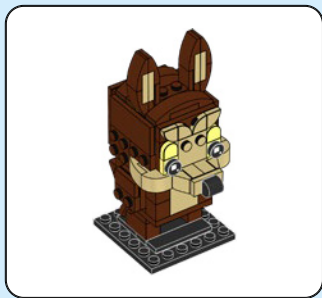

1

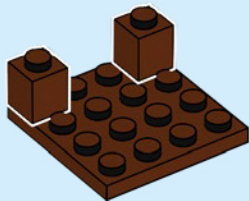

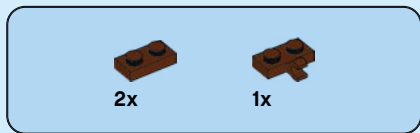

2

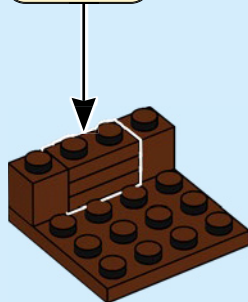
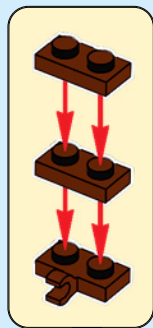



1x



1x

3





2x



1x

4

1

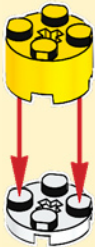

2

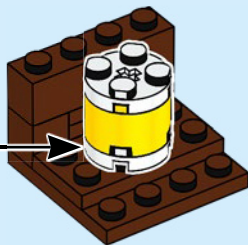



1x



2x

5

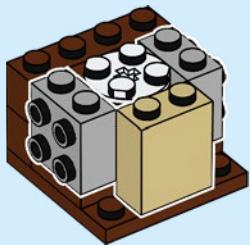



4x

6



2x

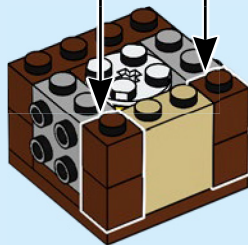



2x



1x



2x

7

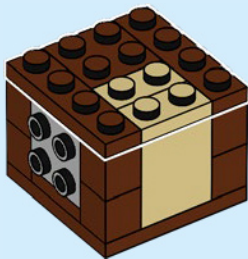



8

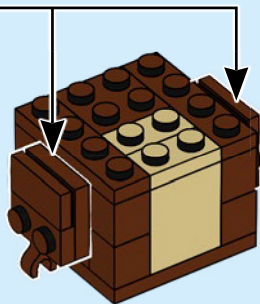
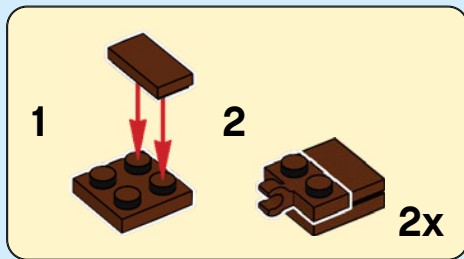



3x

9

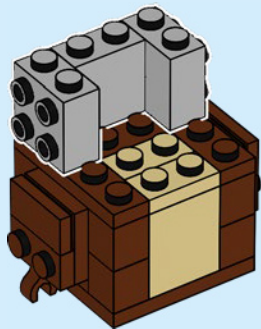



2x



1x

10

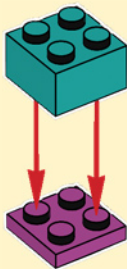

2

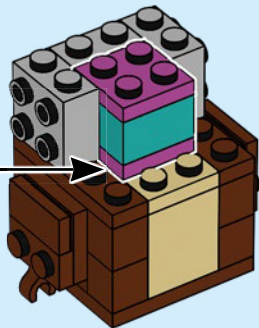

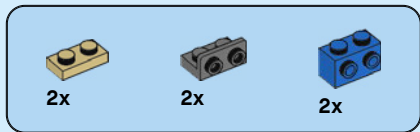

11

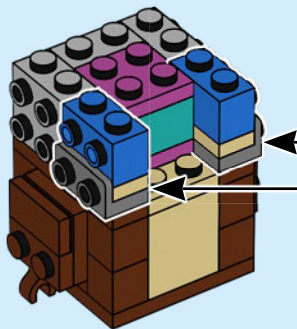
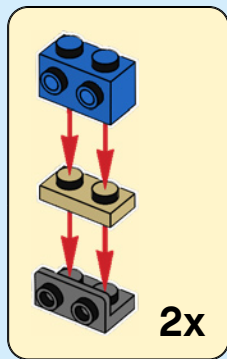



1x

12

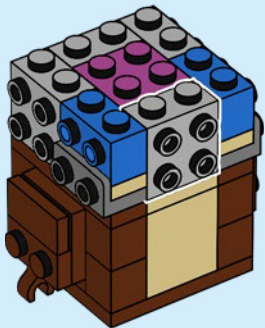

1x



1x

13

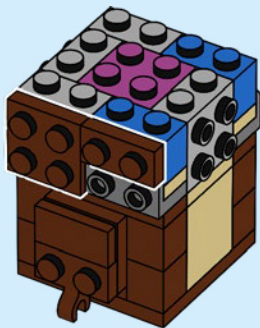



1x



1x

14

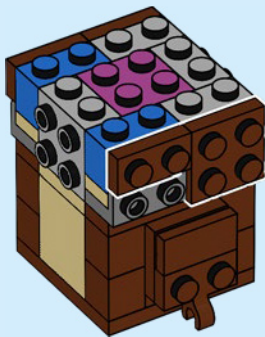



2x

15

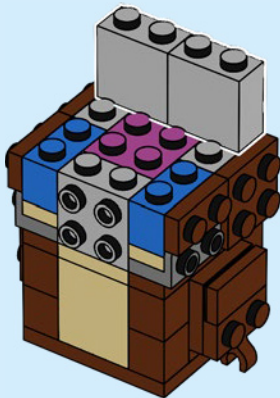

2x

16

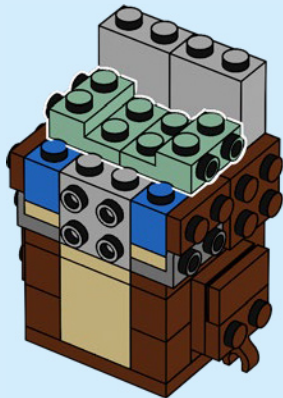



1x



2x



1x

17

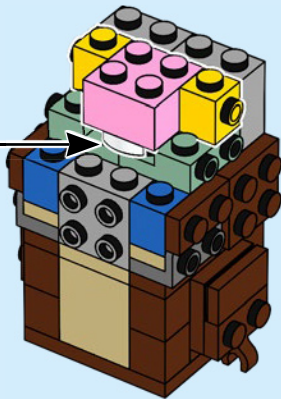
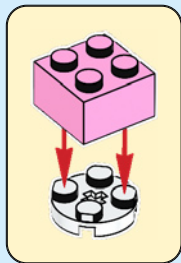



2x

18

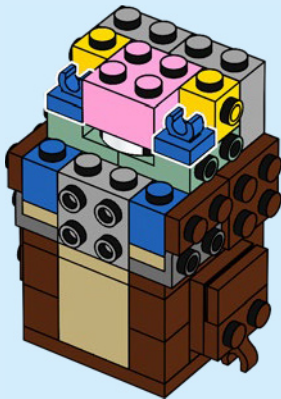

2x

19

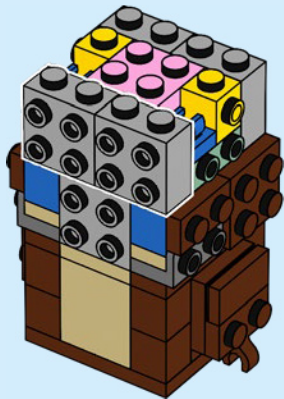

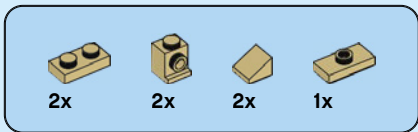

20

1

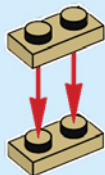

2



3

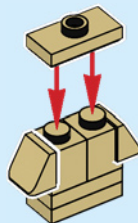

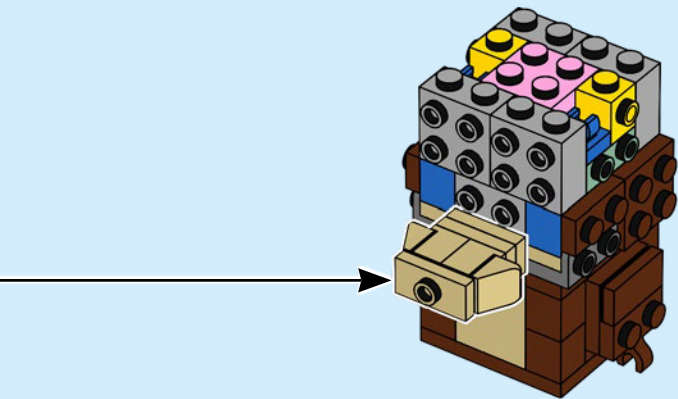



2x



2x

21

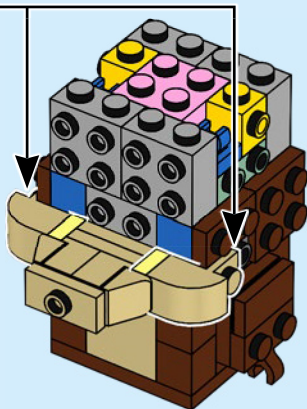
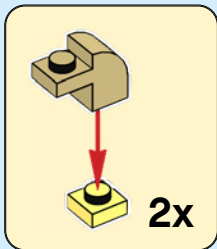



2x

22

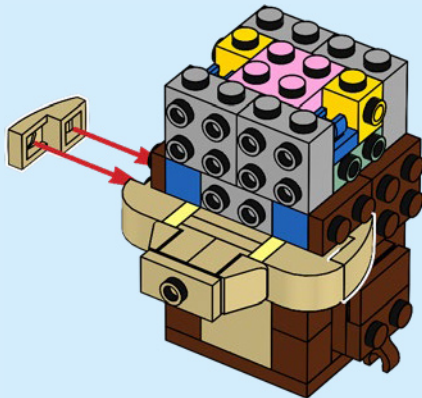

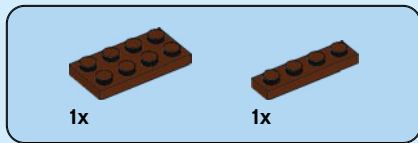

23

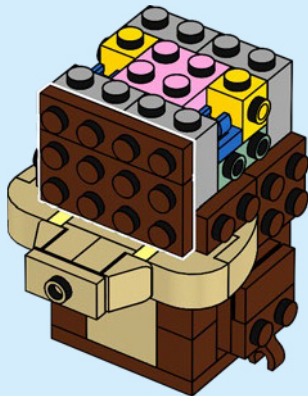



2x

24

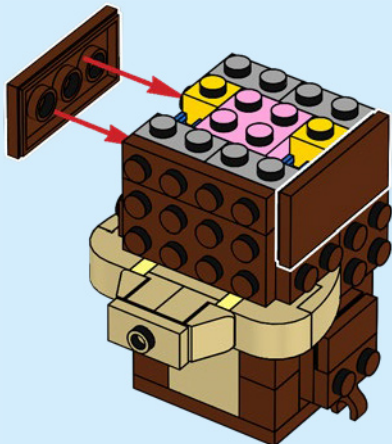

2x



1x



2x

25

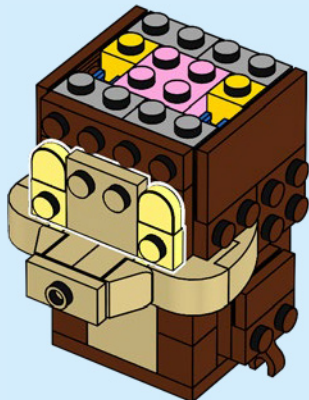



4x

26

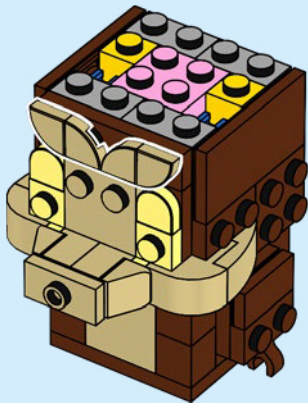



1x



2x

27

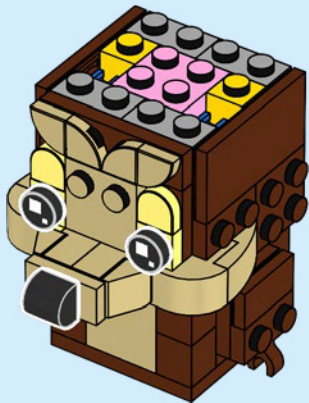

1x

28

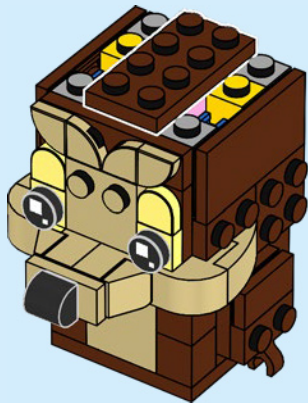



1x



1x

29

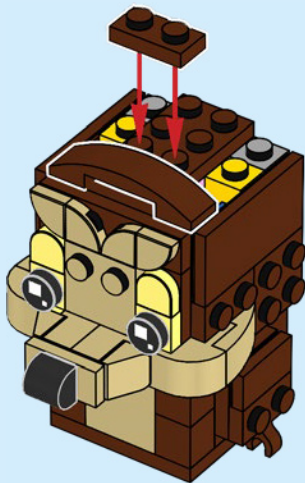



2x

30

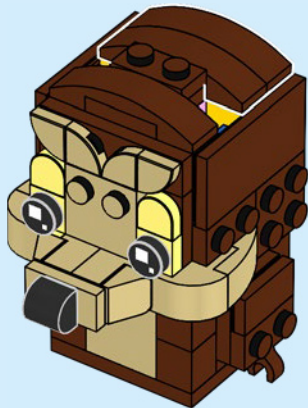

1x

31

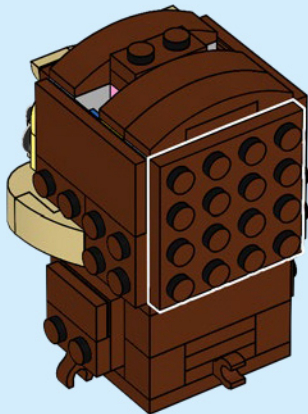



1x



1x

32

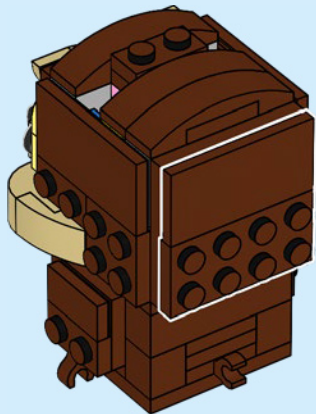



2x



1x

33

1



2

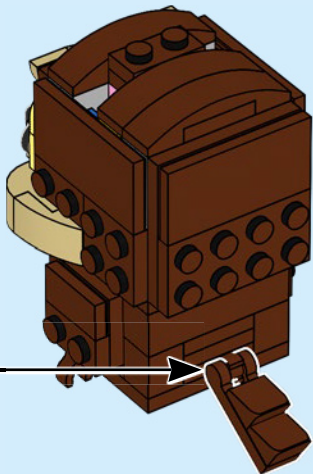



1x



2x

34

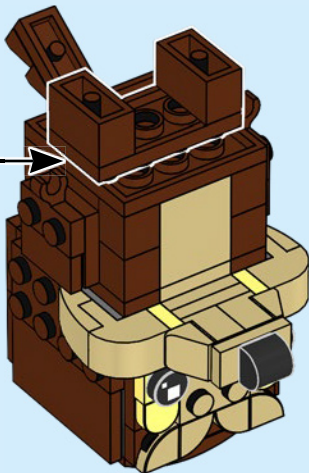
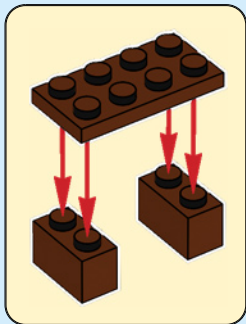



2x



4x



2x



2x



2x



4x

35

1

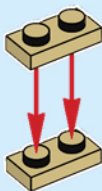

2



3



4



2x

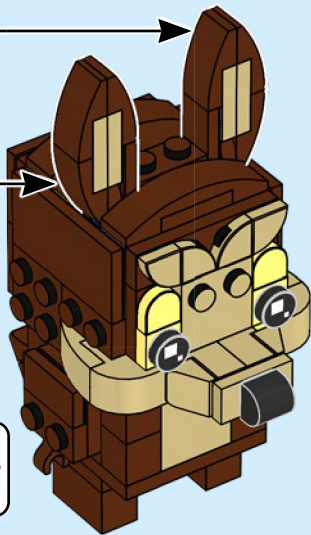

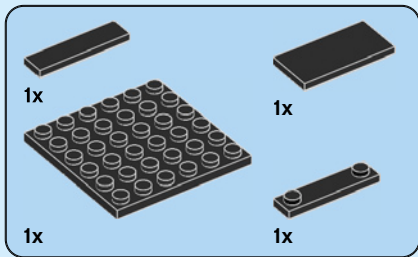

36

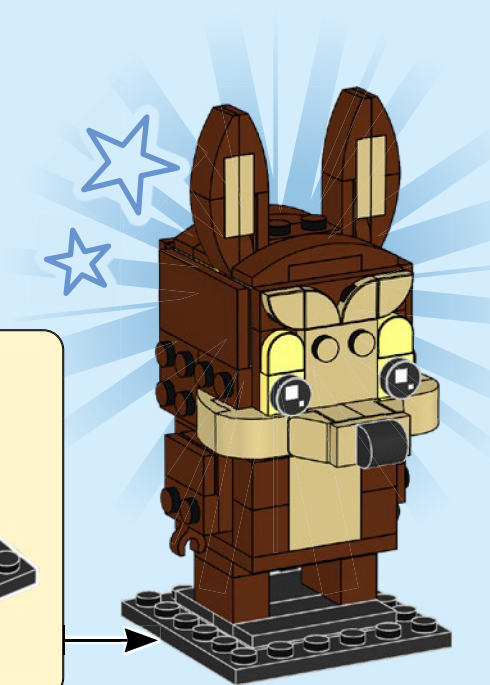
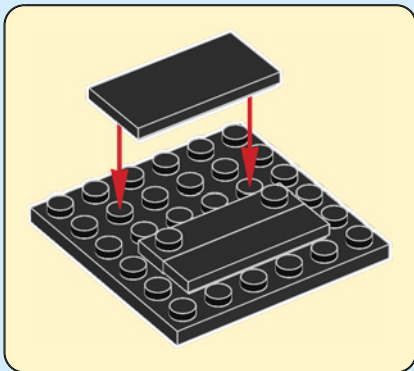

WIN

GO TO WWW.LEGO.COM/PRODUCTFEEDBACK AND
GIVE US YOUR SHORT **FEEDBACK** ABOUT THIS
LEGO® SET FOR A CHANCE TO WIN
A COOL LEGO PRIZE.

Terms & Conditions apply

LEGO.com/productfeedback



GEWINNE

Erzähle uns auf
www.LEGO.com/productfeedback

etwas über die Erfahrungen, die du
mit diesem LEGO® Set gemacht hast,
und sichere dir die Chance auf einen
coolen LEGO Preis!

Es gelten die Teilnahmebedingungen

GAGNE

Rends-toi sur
www.LEGO.com/productfeedback

et donne-nous quelques commen-
taires sur ce produit LEGO® pour
avoir une chance de gagner un
prix LEGO !

Voir Conditions Générales

GANAN

Visita
www.LEGO.com/productfeedback

y envíanos tu opinión acerca de
este set LEGO®. ¡Participarás en el
sorteo de un premio LEGO!

Términos y Condiciones aplicables

获取奖品

登录
www.LEGO.com/productfeedback

给出关于此乐高®套装的简短
反馈，就有机会获得炫酷乐
高奖品

《条款及条件》适用

LEGO and the LEGO logo are trademarks of the/son des marques de commerce du/son
marcas registradas de LEGO Group. ©2022 The LEGO Group.



LOONEY TUNES and all related characters and elements © &™ Warner Bros.
Entertainment Inc. WB SHIELD: © &™ WBEL. (s22)

6404241/6404242



BRICK 'HEADZ

40559

LOONEY TUNES™



 [LEGO.com/brickheadz](https://www.lego.com/brickheadz)

ROAD RUNNER™

161

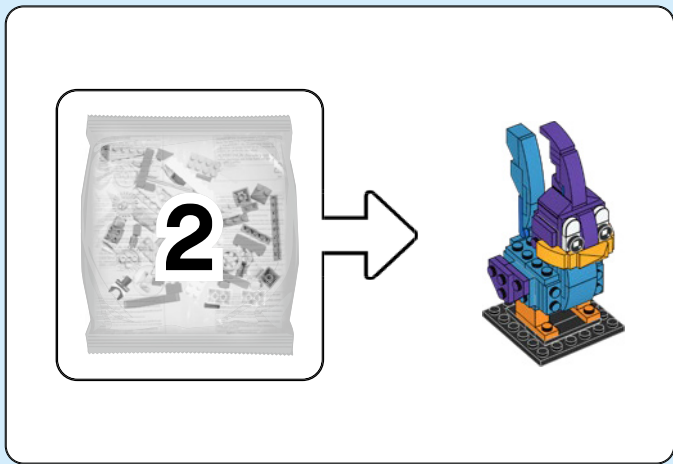

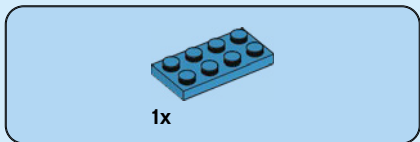
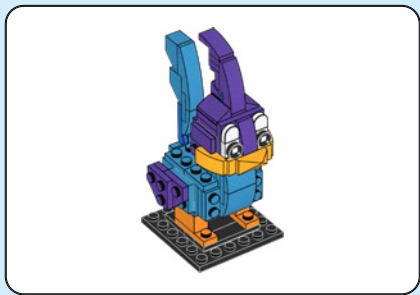

1

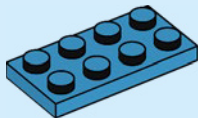



2x

2

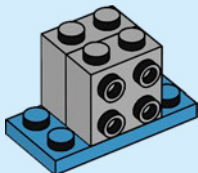

4



2x

3

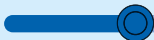
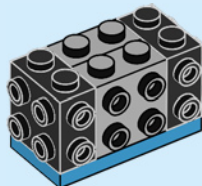



2x



2x

4

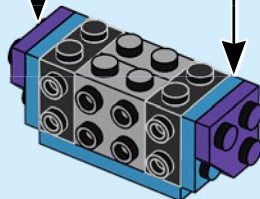
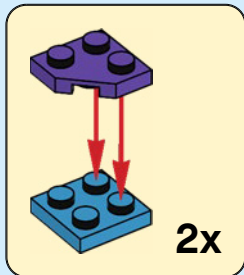

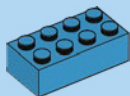

1x

5

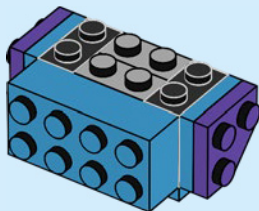

6



1x



1x

6

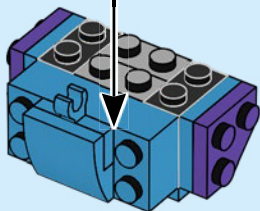
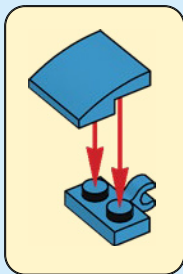

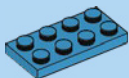

1x

7

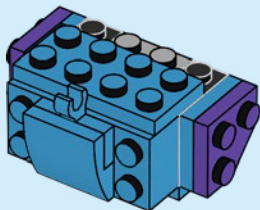

3x

8

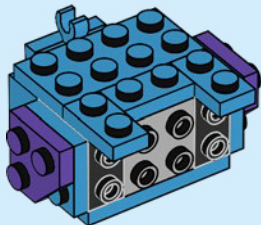



2



1x



1x



4x



2x



2x

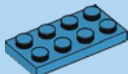

2x

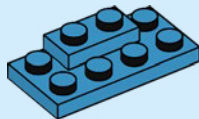

9

1

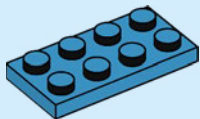

3

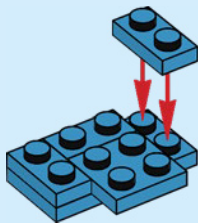

4

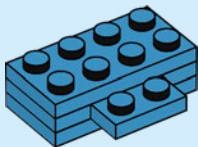

5

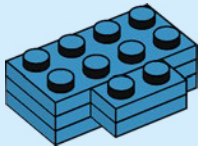

6

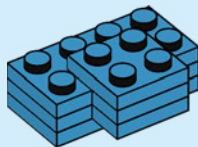

7

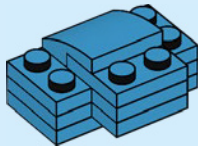

8

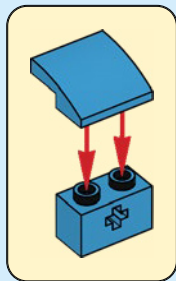
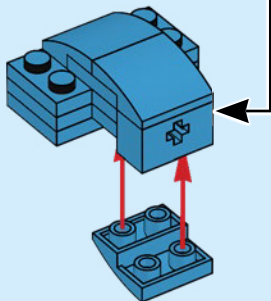

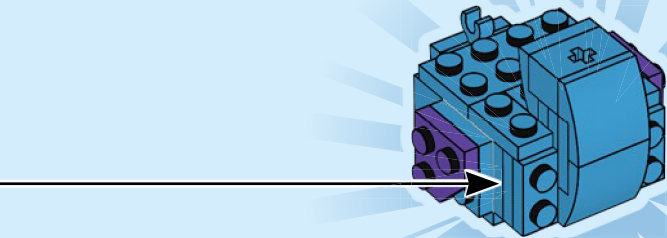



1x



1x

10

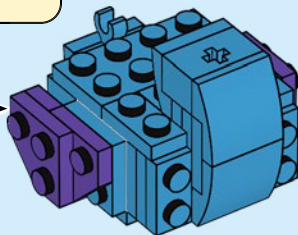
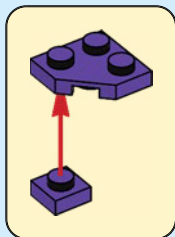



1x



1x

11

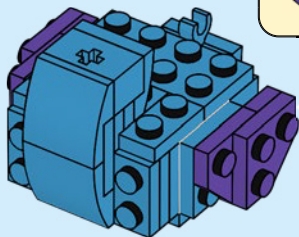
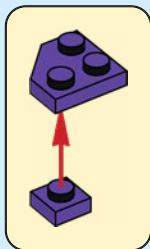

1x

12

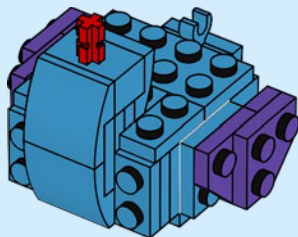

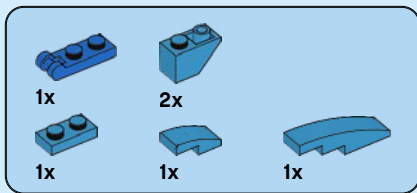

13

1



2

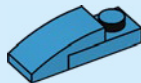

3

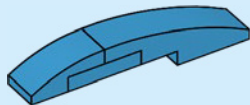

4

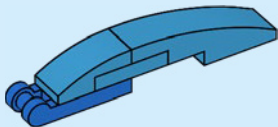

5

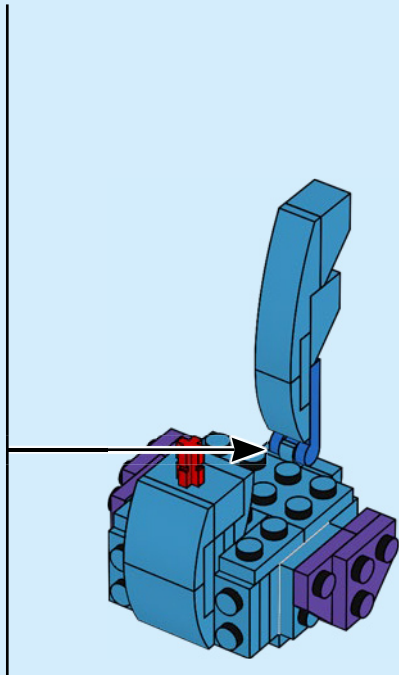
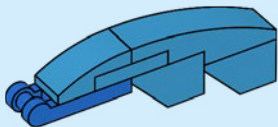



1x



1x

14

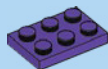
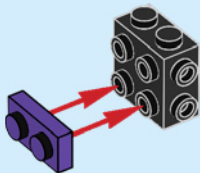

1x

15

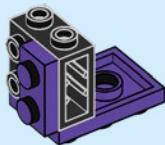



1x



1x

16

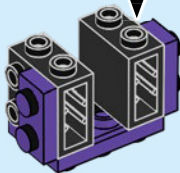
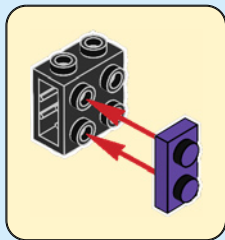

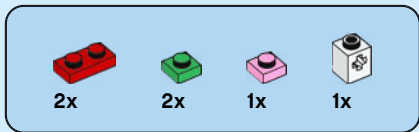

17

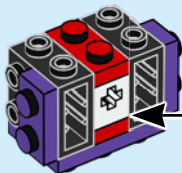
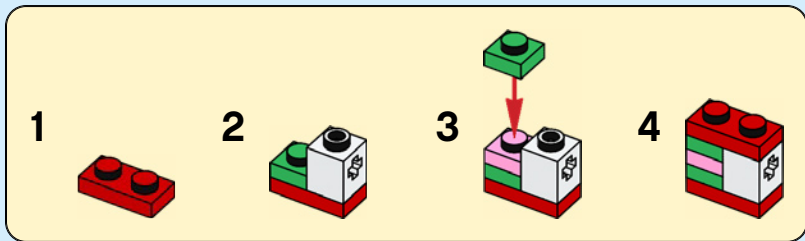



1x

18

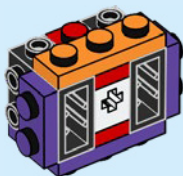

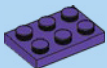

2x

19

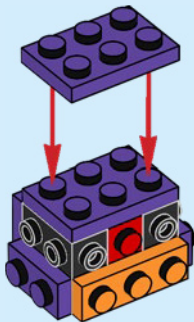



1x



1x



1x

20

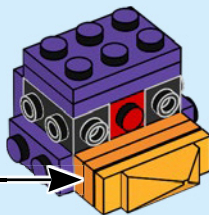
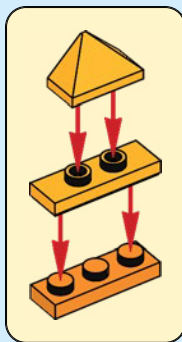



2x

21

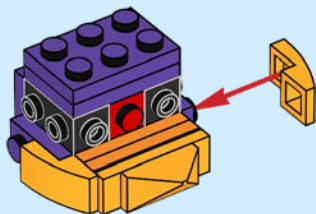

2x

22

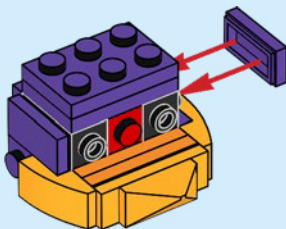

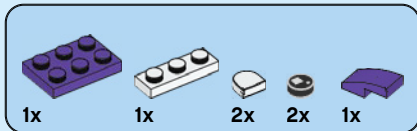
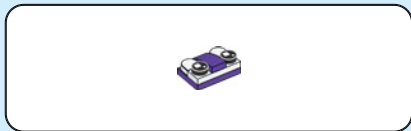

23

1

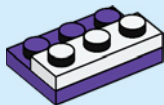

2



3



4

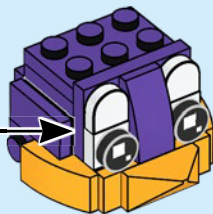



1x



1x



2x

24

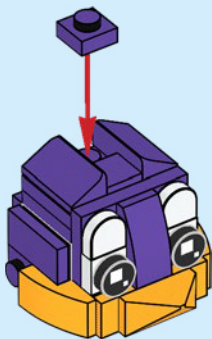

1x



1x

25

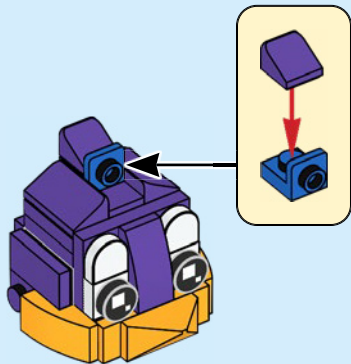

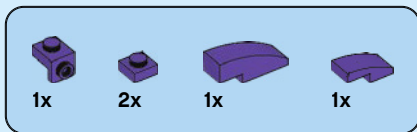

26

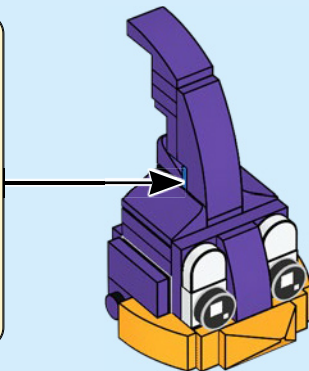
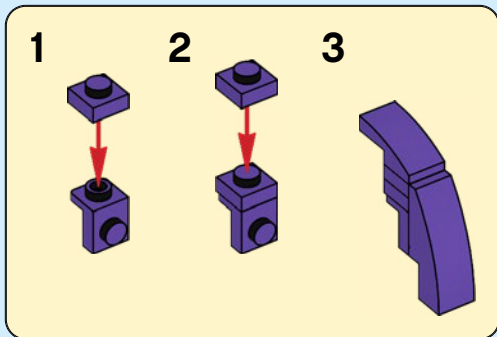

27

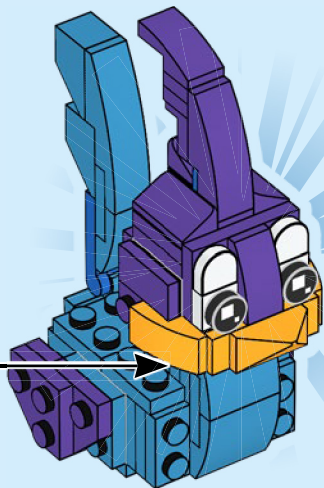



2x



2x

28

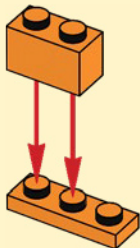

2x

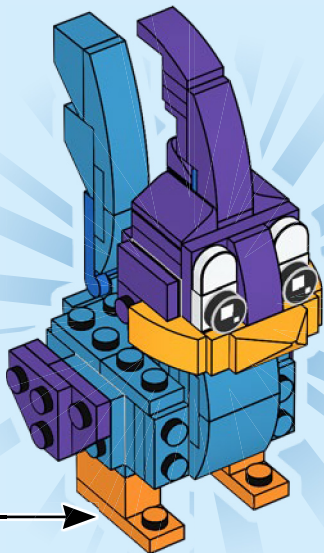

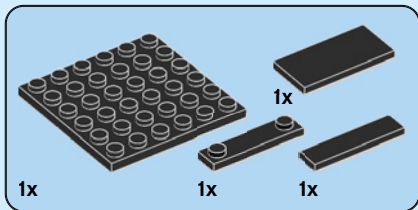

29

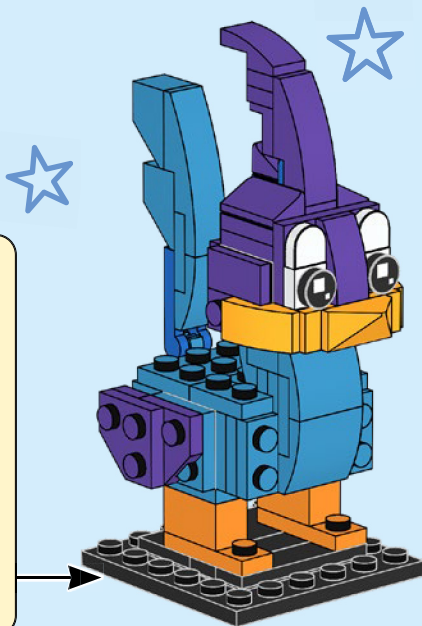
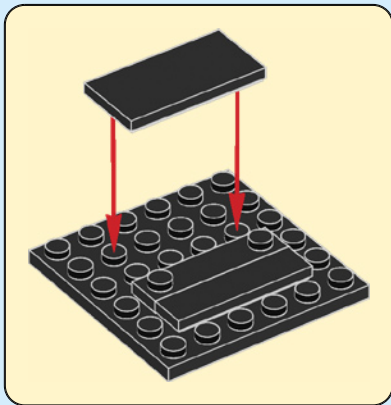



2x
6250591



1x
6345886



3x
403201



1x
362301



4x
6145570



2x
4118793



2x
4516055



2x
6046922



1x
6092587

30



1x
4159279



2x
4273526



10x
4113917



1x
6221467



1x
4142865



2x
302321



2x
6344028



1x
6307926



2x
6189191



1x
6073890



2x
4624985



1x
614324



2x
302428



2x
4121739



4x
6147047



1x
6314091



4x
6284077



1x
6273589



4x
6308883



2x
243126



2x
6254045



2x
4560182

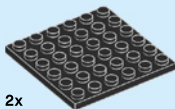

2x
395826



2x
6109930



2x
6223171



1x
6382584



2x
6099728



1x
6307254



2x
6250598



4x
6058014



1x
4550359



1x
6031883



12x
6123809



2x
6000606



2x
6069984



3x
6313124



2x
4211149



5x
4211150



4x
4211151



4x
6172922



5x
4216695



1x
6102975



1x
4211225



3x
4579690



5x
4211186



2x
4243838



2x
4504376



3x
4658005



3x
4211190



6x
4211242



2x
6153863



1x
6167457



5x
6231376



1x
6336391



2x
4566607



2x
4613192



4x
4225142



1x
4567509



2x
6057390



2x
4655695



4x
6382583



1x
6103449



3x
6298471



4x
6206809



8x
4653988



1x
6313118



1x
4655172



2x
6298469



1x
6249815



1x
6137300



1x
6382585



1x
6151667



4x
6210675



Customer Service
Kundenservice
Service Consommateurs
Servicio Al Consumidor

LEGO.com/service or dial



: 00800 5346 5555

: 1-800-422-5346



BRICK HEADZ

40559

LOONEY TUNES

TM



ROAD RUNNER™

161

WILE E. COYOTE™

162



LOONEY TUNES and all related characters and elements © & TM
Warner Bros. Entertainment Inc. WB SHIELD: © & TM WBEL (S22)

LEGO and the LEGO logo are trademarks of the/son des marques de
commerce du/son marcas registradas de LEGO Group.
©2022 The LEGO Group. 6404243 / 6404244