

**LEGO**

**duplo**



**10940**  
LEGO.com/DUPL0

# EXPLORE THE DIGITAL UNIVERSE

ERKUNDE DAS DIGITALE UNIVERSUM/EXPLORER L'UNIVERS DIGITAL/  
ESPLORA L'UNIVERSO DIGITALE/EXPLORA EL UNIVERSO DIGITAL/  
EXPLORA O UNIVERSO DIGITAL/FEDEZD FEL A DIGITÁLIS UNIVERZUMOT/  
IZPĚTI DIGITÁLNO PASAULI/

探索数字世界



LEGO® DUPLO® WORLD  
LEGO.com/apps

DUPLO® NURSERY RHYMES  
DUPLO® KINDERLIEDER  
COMPTINES POUR ENFANTS DUPLO®  
FILASTROCCHES DUPLO®  
CANCIONES INFANTILES DUPLO®  
DUPLO® CANÇÕES INFANTIS  
DUPLO® GYERMEKDALOK  
DUPLO® BĚRNU SKAITĀMPANTI

得宝®儿歌

Customer Service  
Kundenservice  
Service Consommateurs  
Servicio Al Consumidor

LEGO.com/service or dial

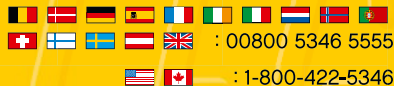

🇧🇪 🇩🇪 🇩🇪 🇪🇸 🇫🇷 🇮🇹 🇮🇹 🇭🇺 🇳🇱 🇹🇷  
🇨🇭 🇩🇰 🇸🇪 🇩🇪 🇬🇧 : 00800 5346 5555

🇺🇸 🇨🇦 : 1-800-422-5346



# duplo



Age

1½

Age

2+





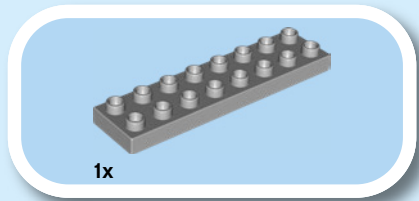

1

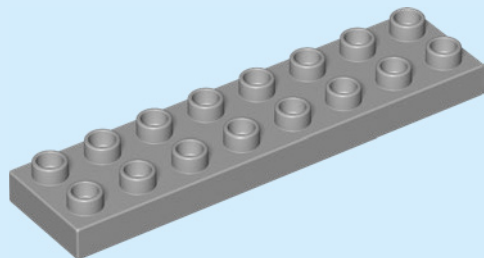

4

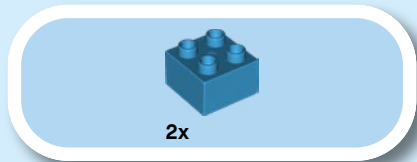

2

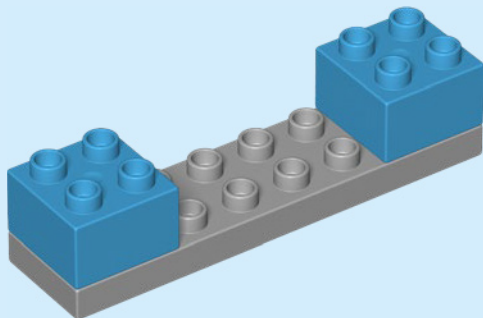



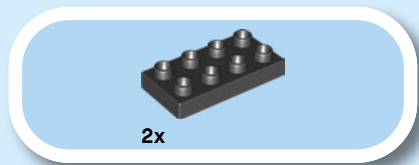

3

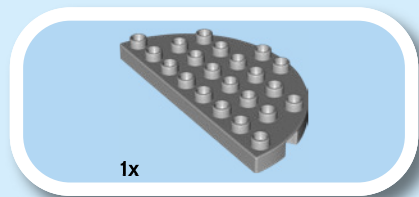
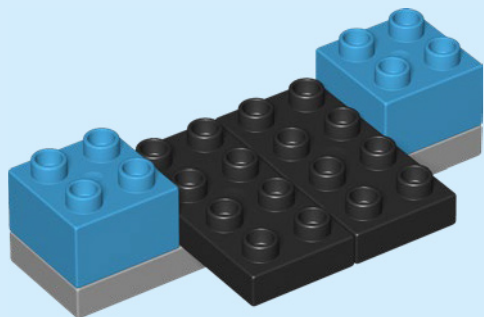

4

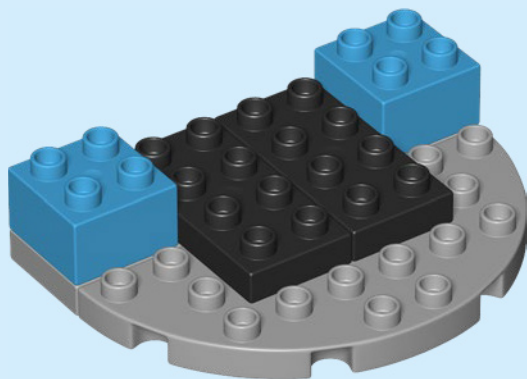

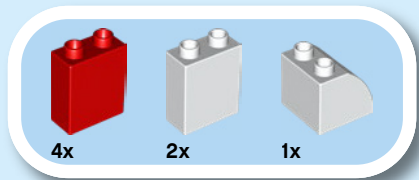

5

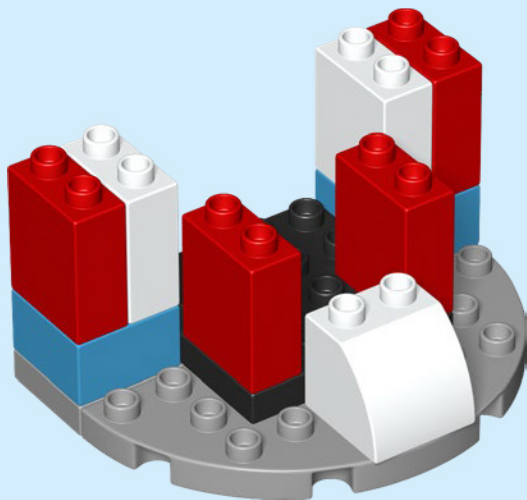

6

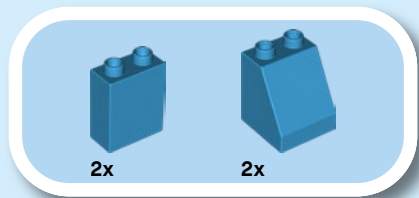

6

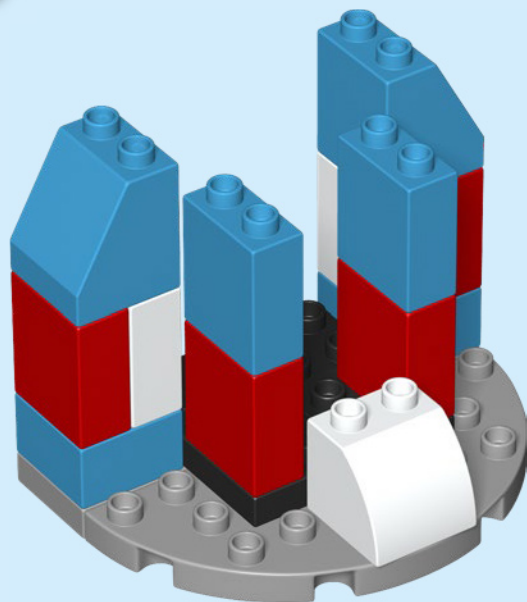



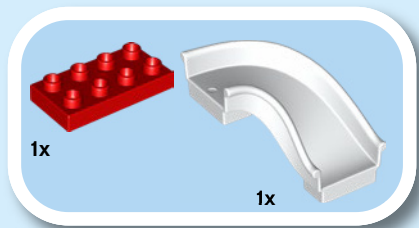

7

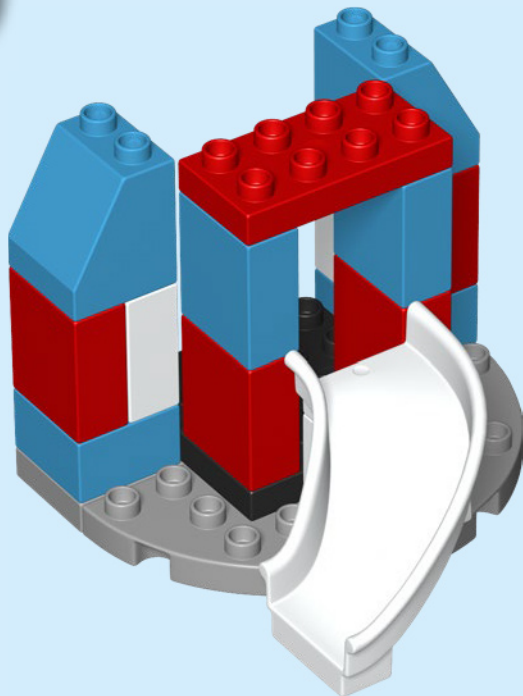

8

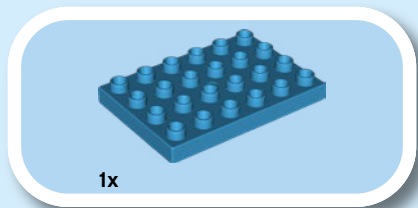

8

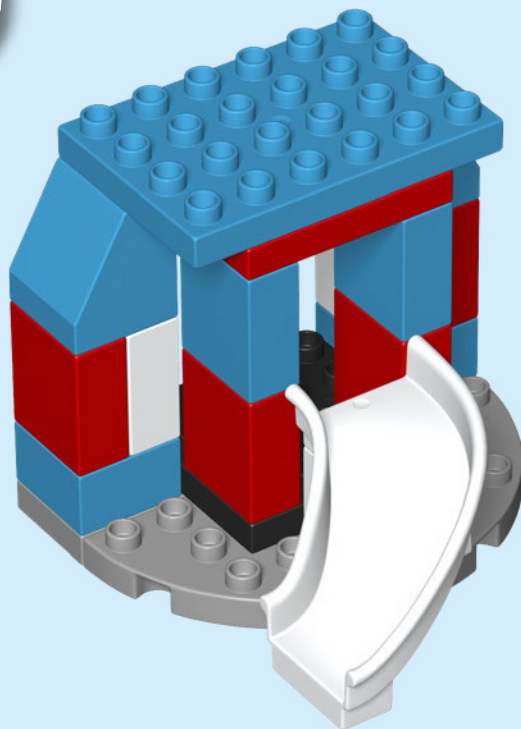

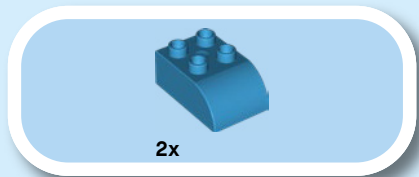

9

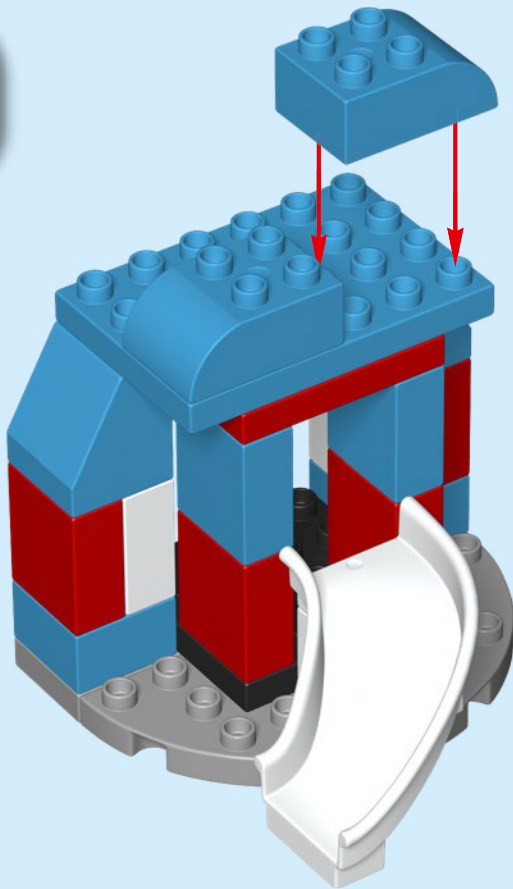

10



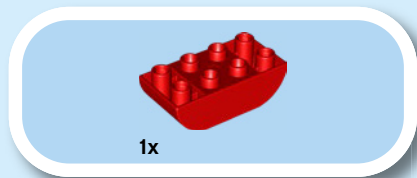

10

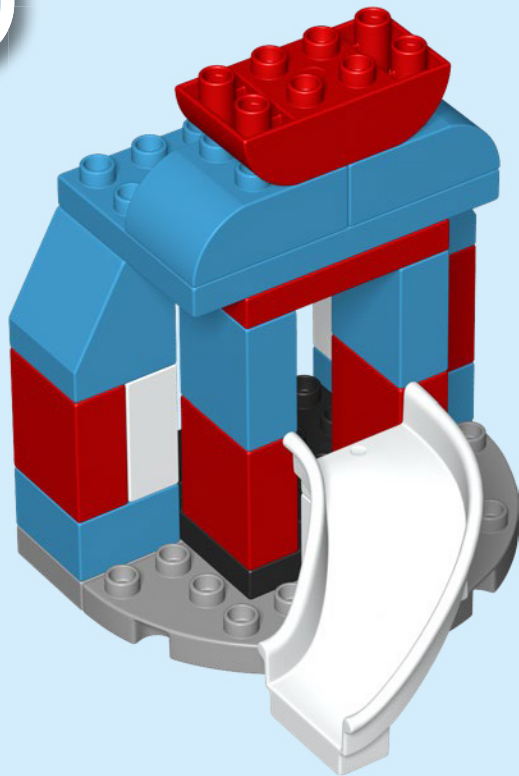

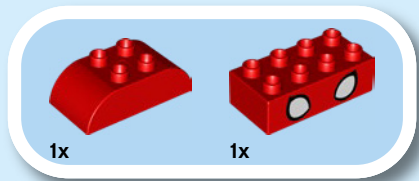

11

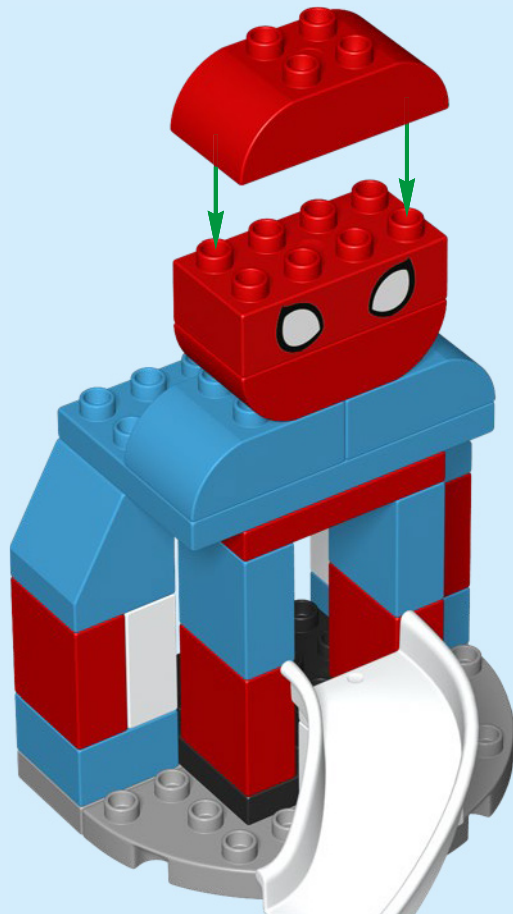

12

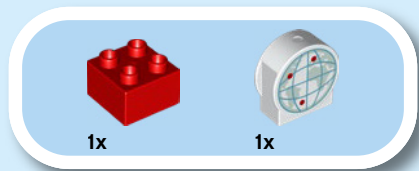

12

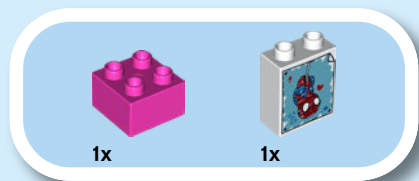
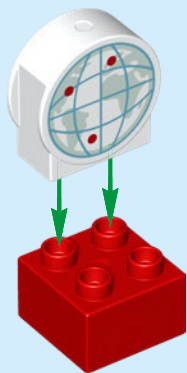

13

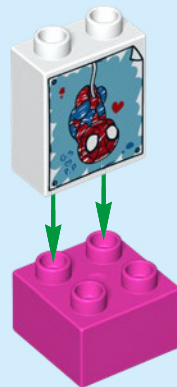



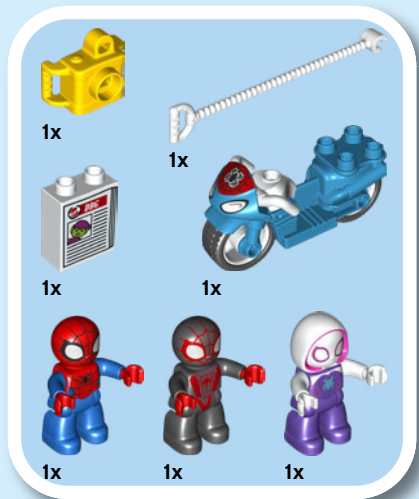

14





Customer Service

Kundenservice

Service Consommateurs

Servicio Al Consumidor

LEGO.com/service or dial

										
					: 00800 5346 5555					
							: 1-800-422-5346			



Go to [www.LEGO.com/productfeedback](http://www.LEGO.com/productfeedback)  
and give us your short  
**win**  
**feedback** about this  
LEGO® DUPLO® set for a chance to win  
a cool LEGO prize

Terms & Conditions apply

[LEGO.com/productfeedback](http://LEGO.com/productfeedback)

## GEWINNE

Erzähle uns auf  
[www.LEGO.com/productfeedback](http://www.LEGO.com/productfeedback)

etwas über die Erfahrungen, die du  
mit diesem LEGO® Set gemacht hast,  
und sichere dir die Chance auf einen  
coolen LEGO Preis!

Es gelten die Teilnahmebedingungen

## GAGNE

Rends-toi sur  
[www.LEGO.com/productfeedback](http://www.LEGO.com/productfeedback)

et donne-nous quelques commen-  
taires sur ce produit LEGO® pour  
avoir une chance de gagner un  
prix LEGO !

Voir Conditions Générales

## GANAN

Visita  
[www.LEGO.com/productfeedback](http://www.LEGO.com/productfeedback)

y envíanos tu opinión acerca de este  
set LEGO®. ¡Participarás en el sorteo  
de un premio LEGO!

Términos y Condiciones aplicables

## 获取奖品

登录  
[www.LEGO.com/productfeedback](http://www.LEGO.com/productfeedback)

给出关于此乐高®套装的简短反  
馈，就有机会获得炫酷乐高奖品

《条款及条件》适用

LEGO, the LEGO logo and DUPLO are trademarks of the LEGO Group. ©2021 The LEGO Group.  
© 2021 MARVEL

6371728