

1

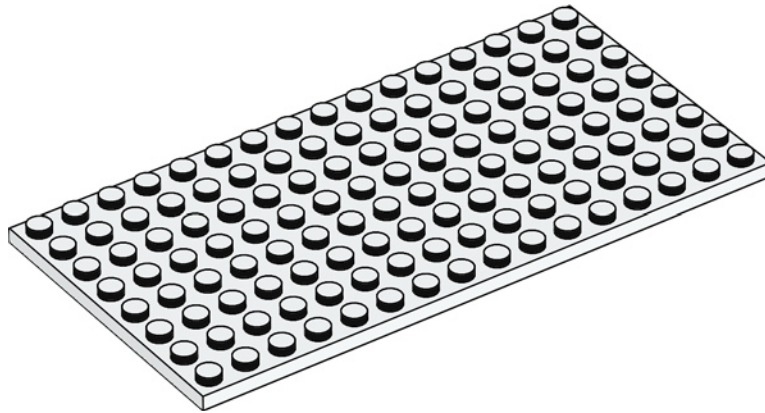

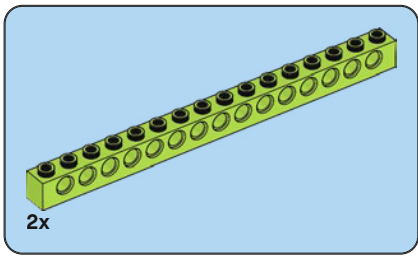

2

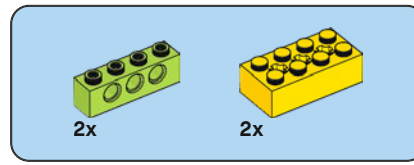
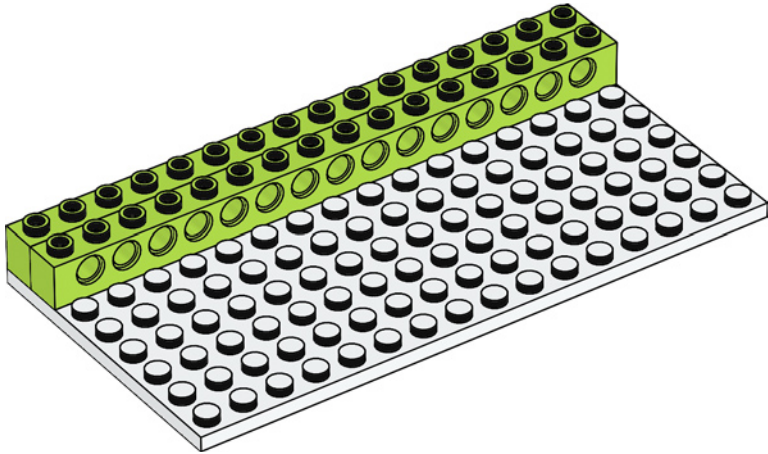

3

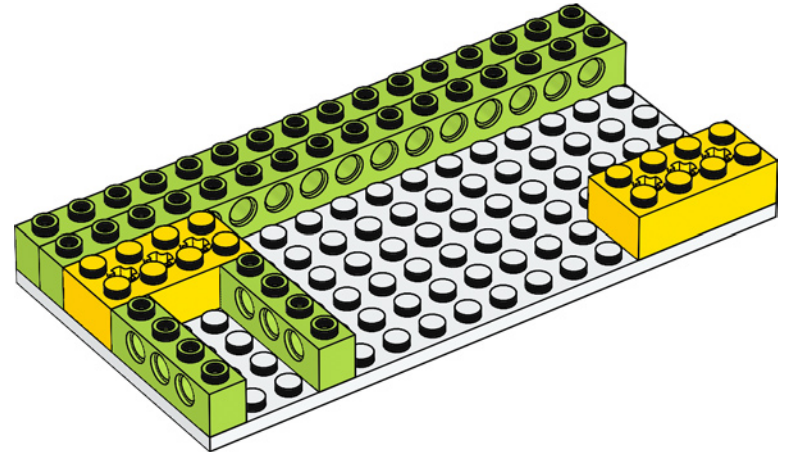

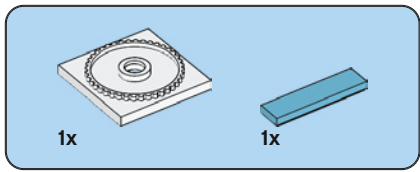

4

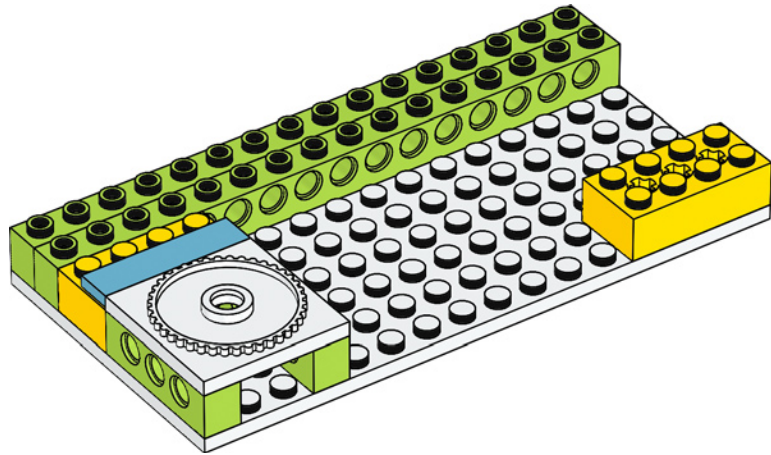

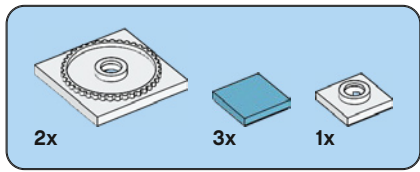

5

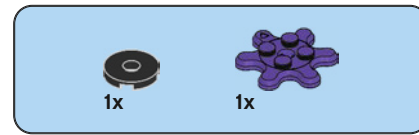
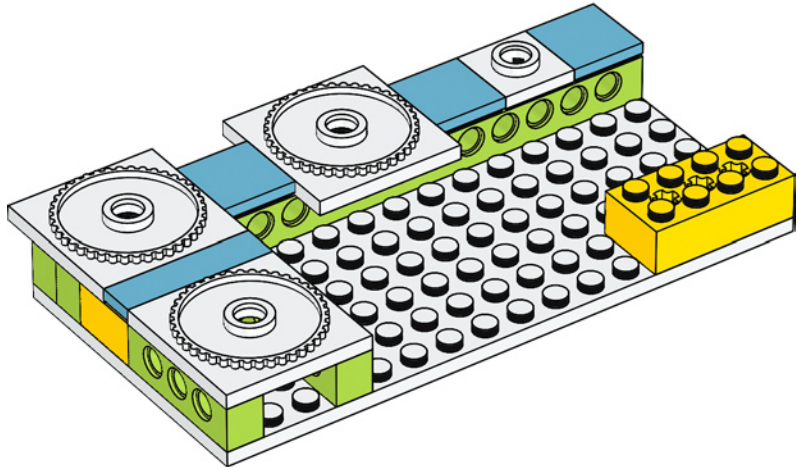

6

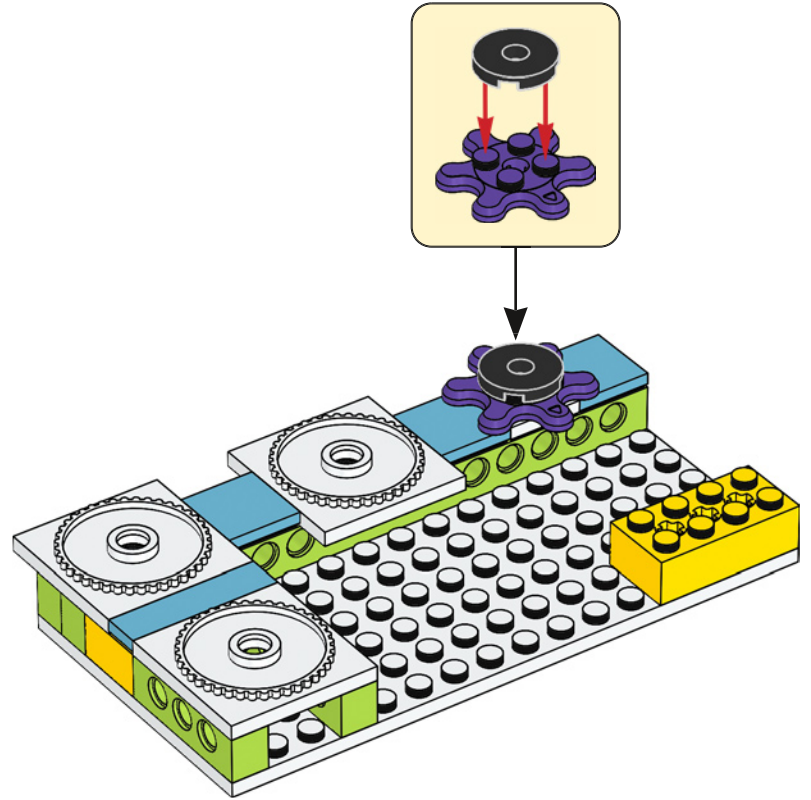

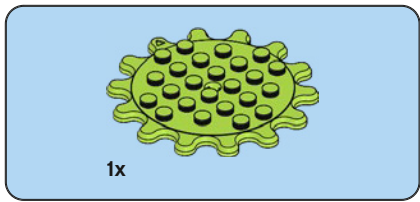

7

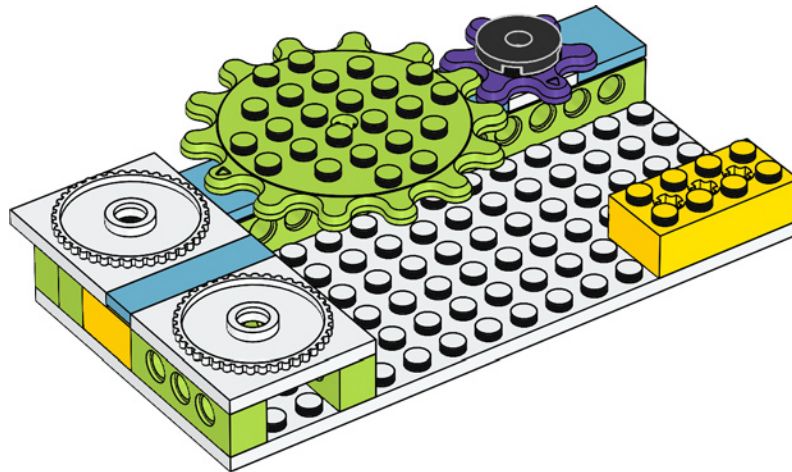

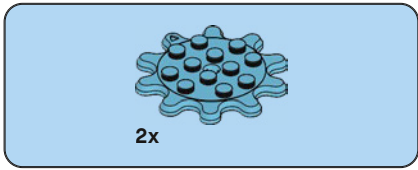

8

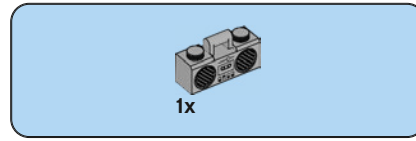
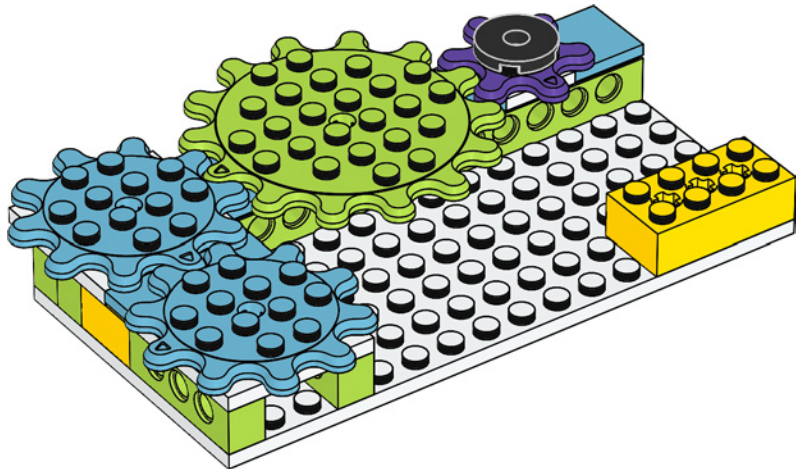

9

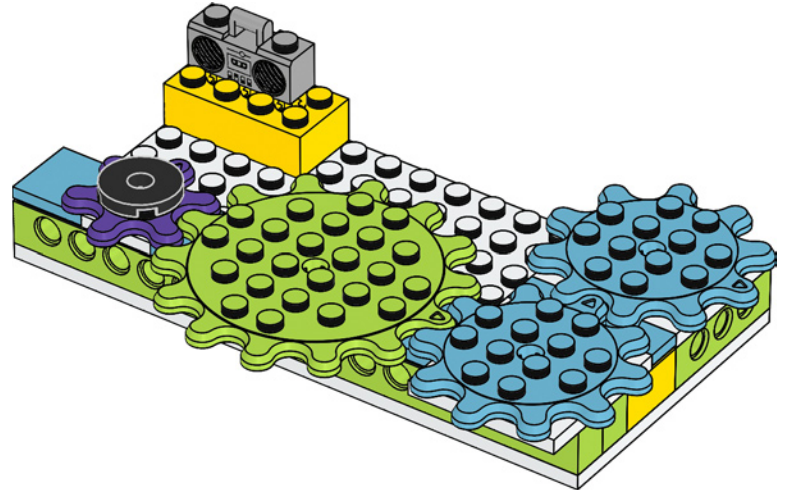

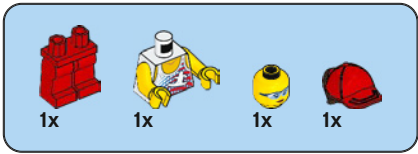

10

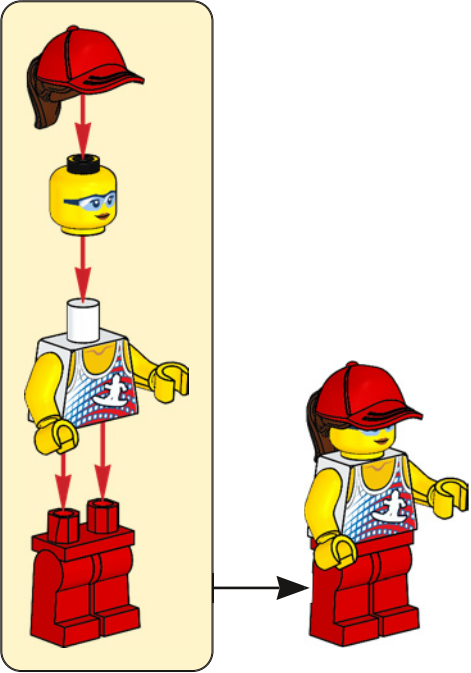



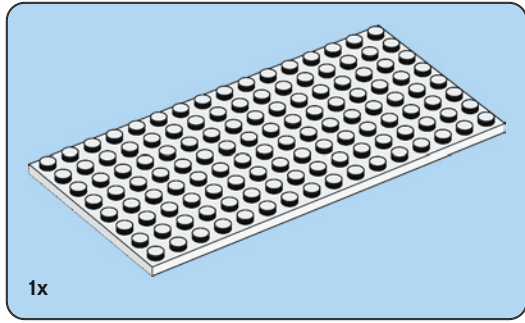
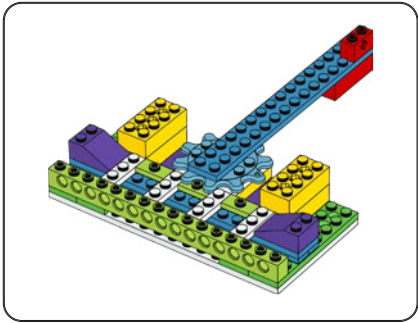
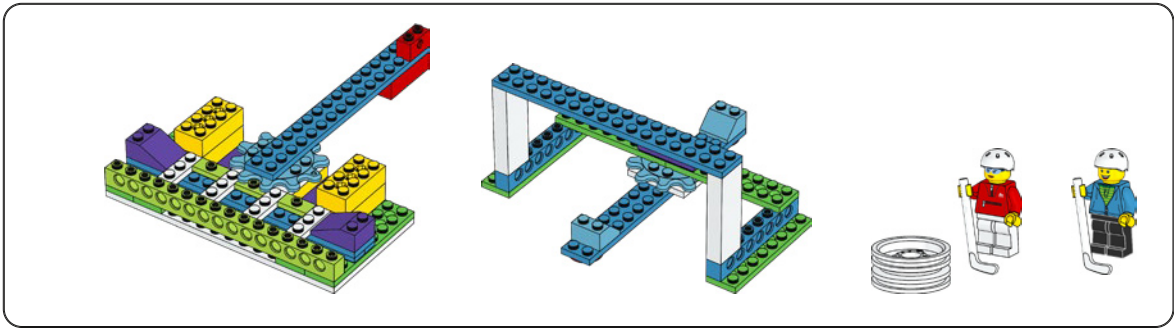

1

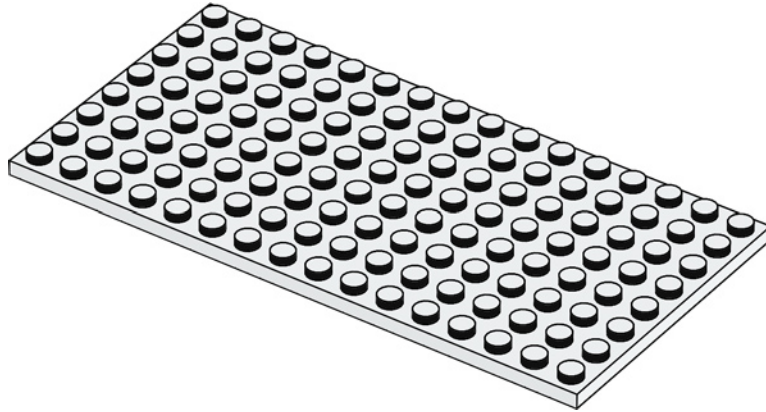

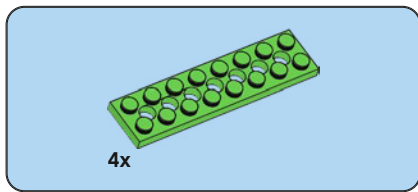

2

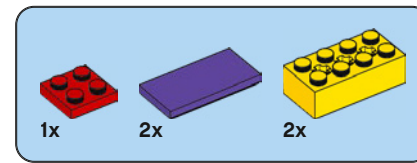
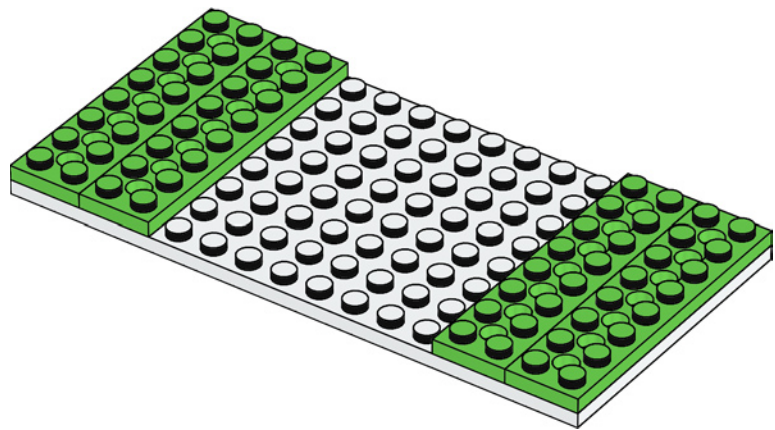

3

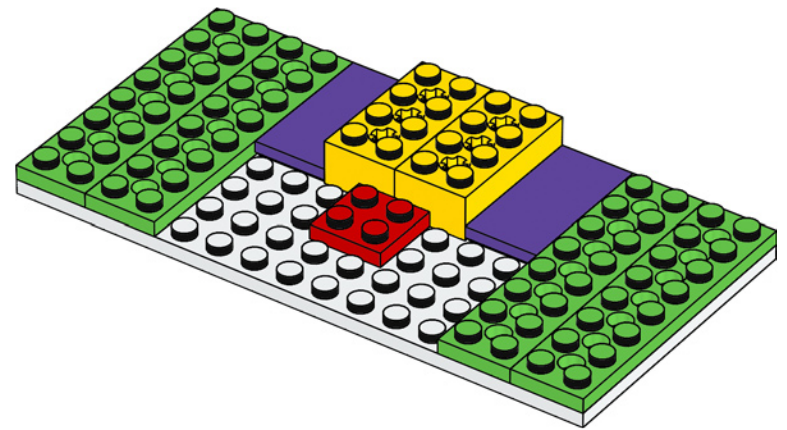

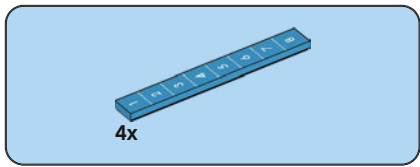

4

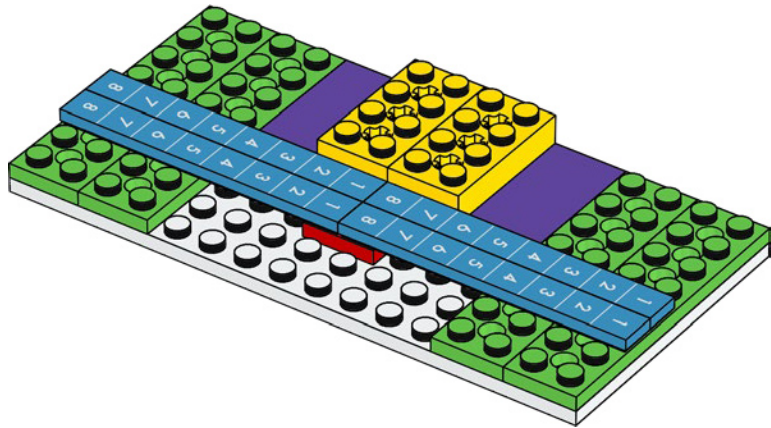

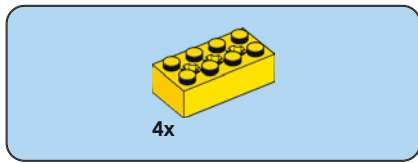

5

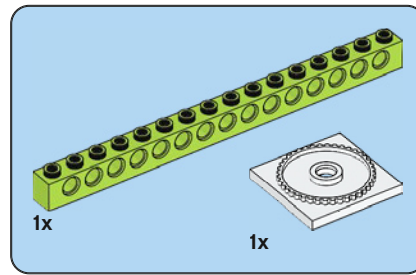
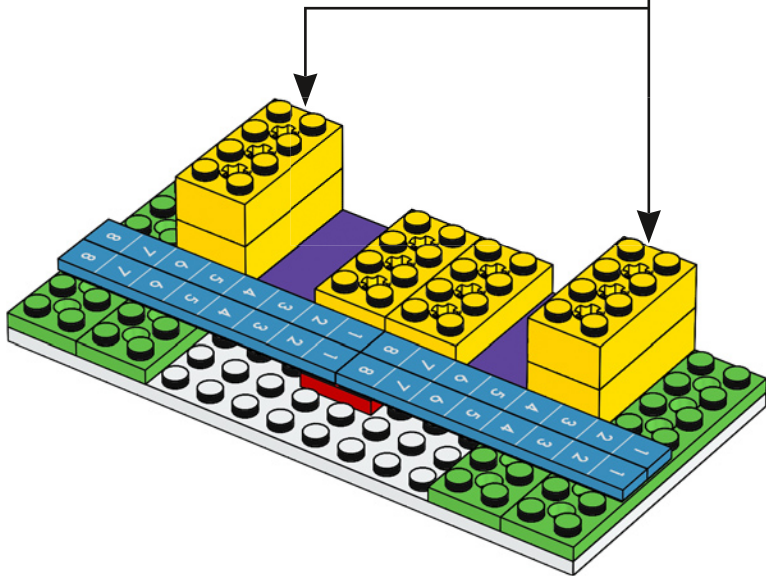
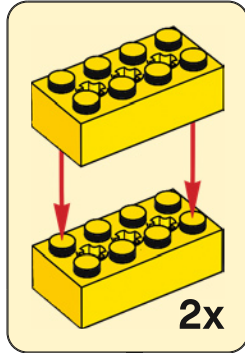

6

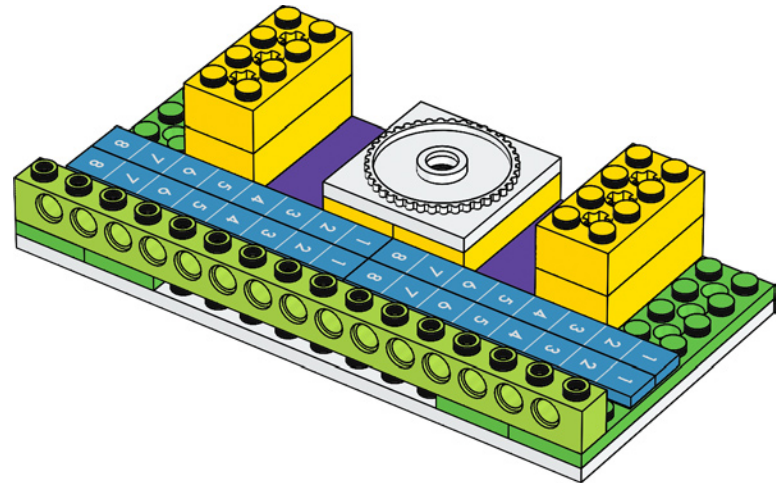

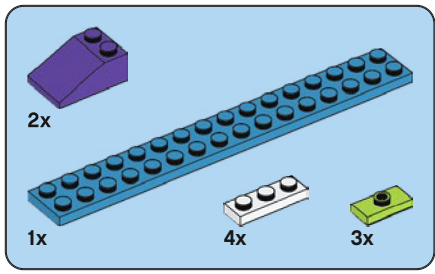

7

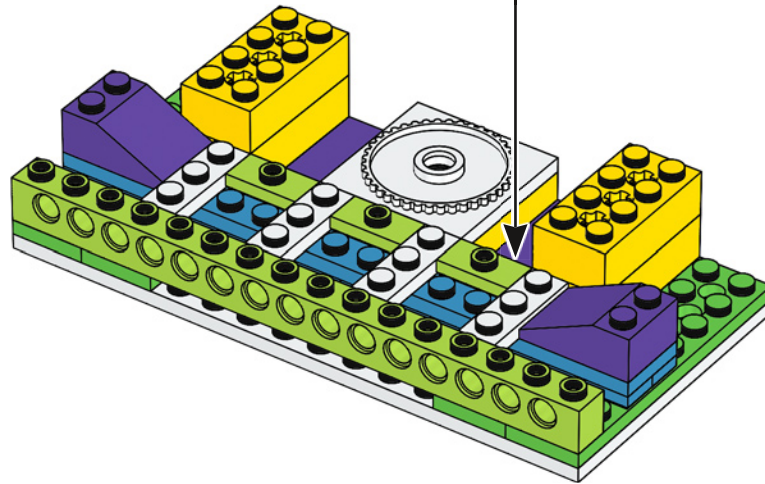
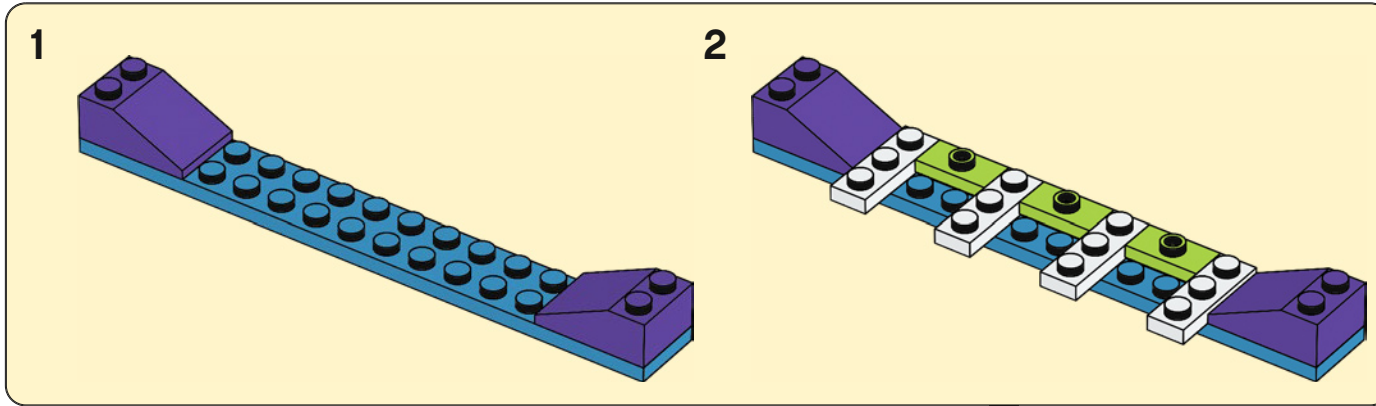

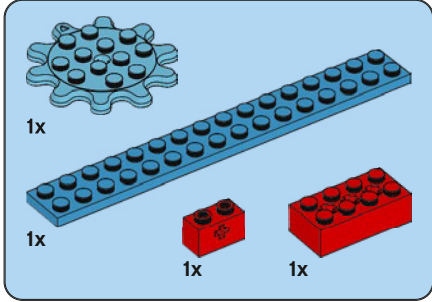
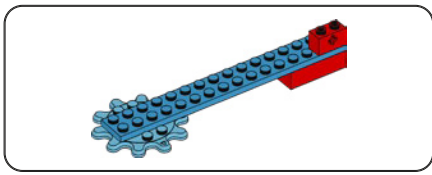

8

1

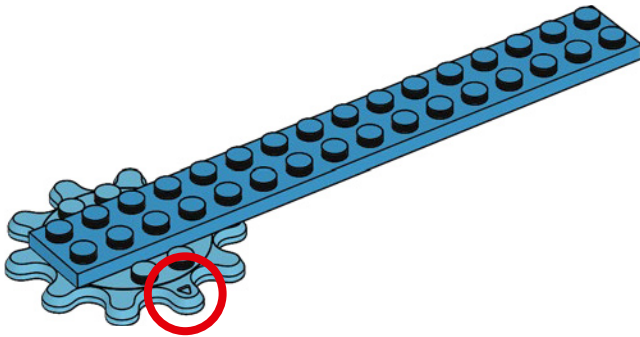

2

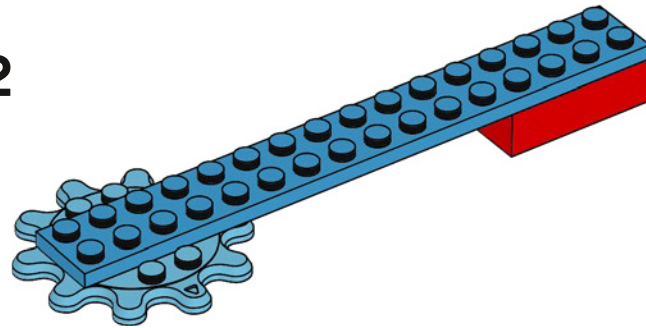

3

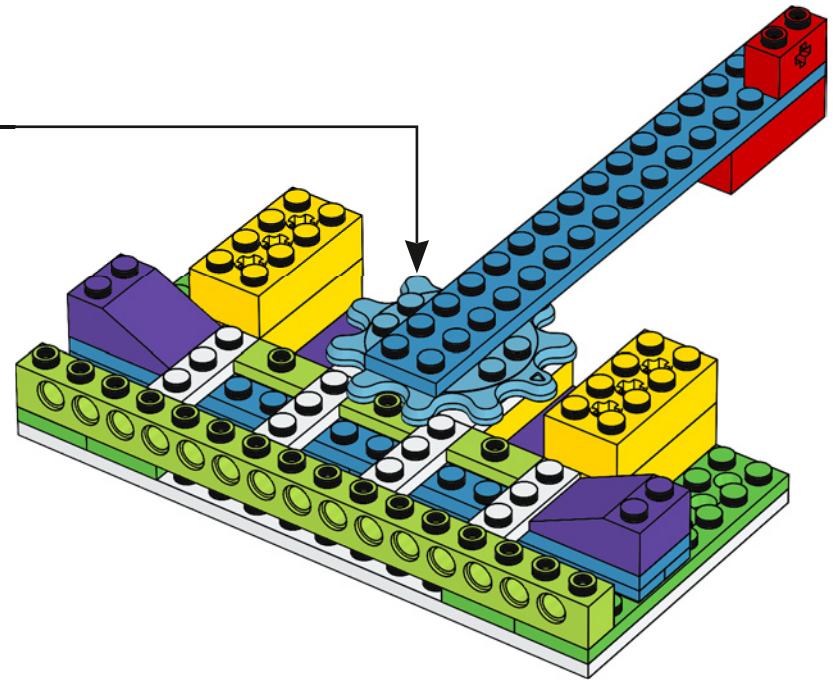
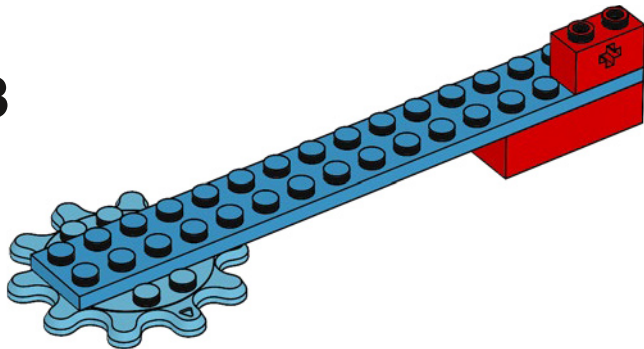

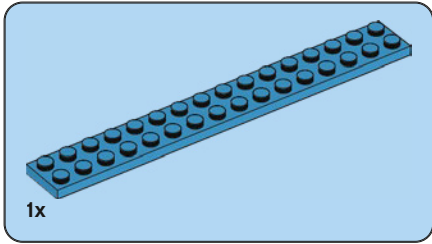
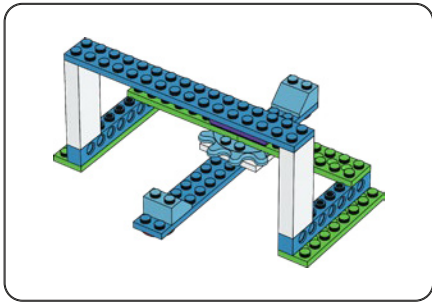

9

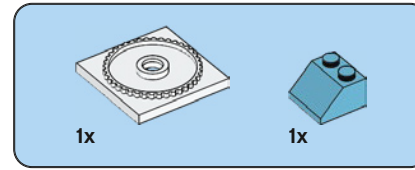
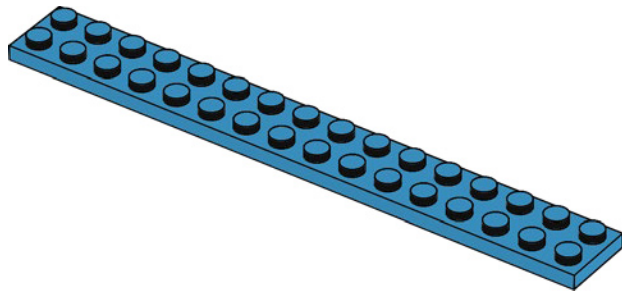

10

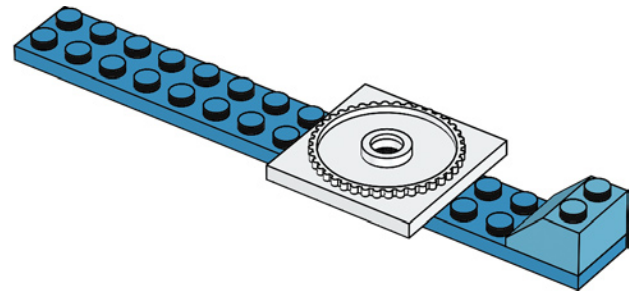

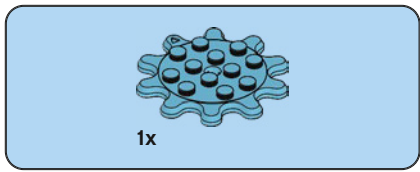

11

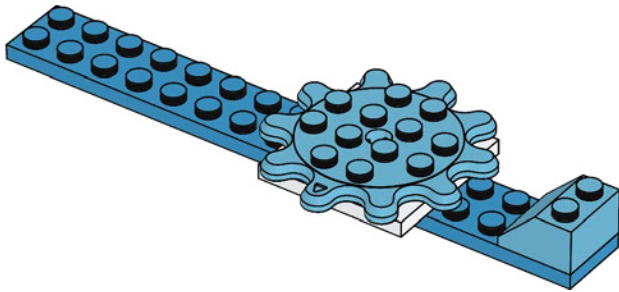

12

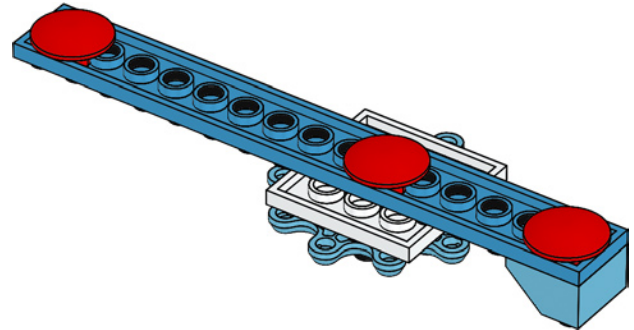

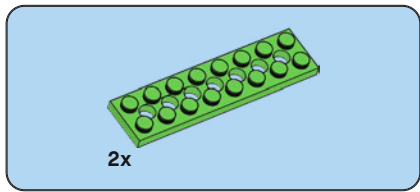

13

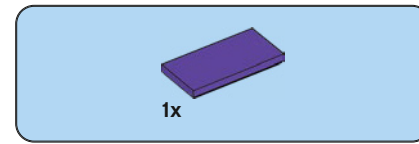
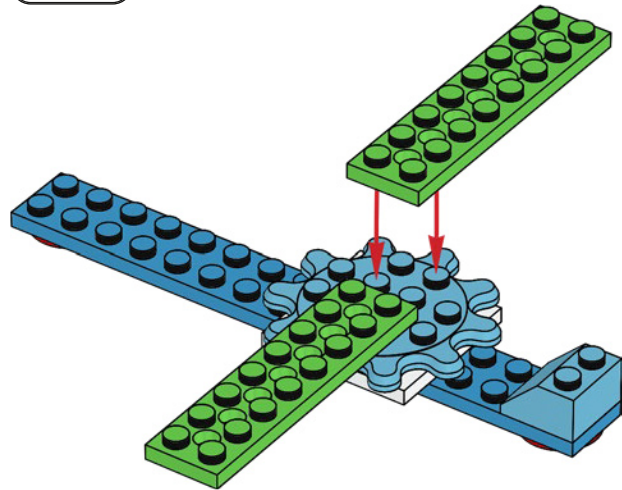

14

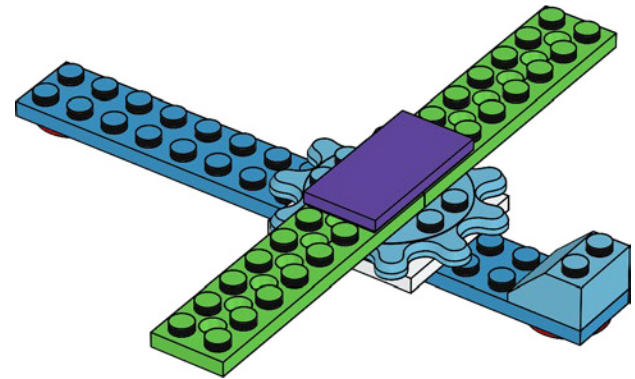

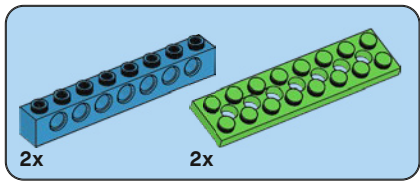

15

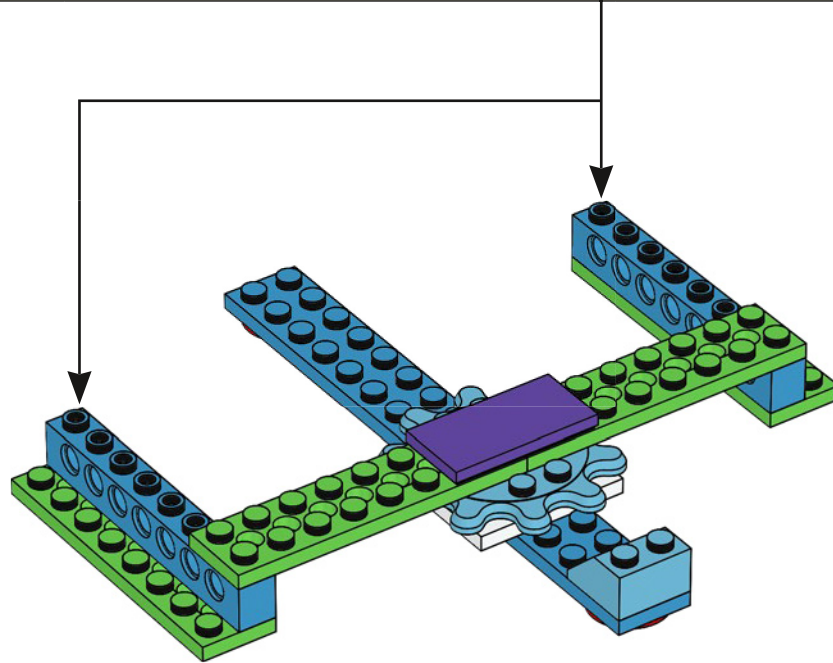
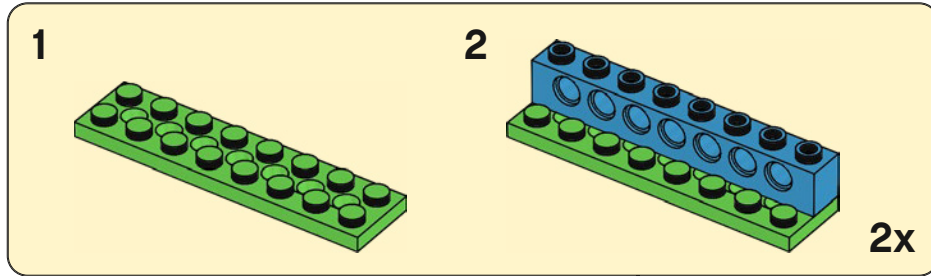

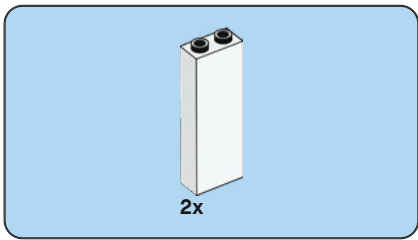

16

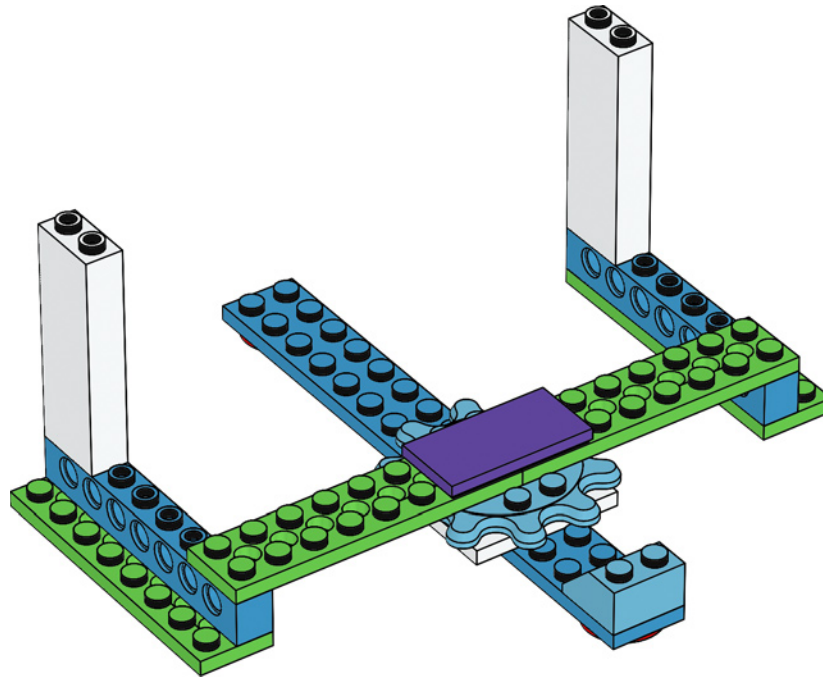

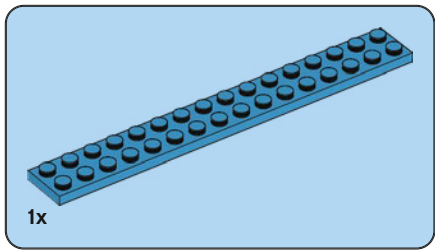

17

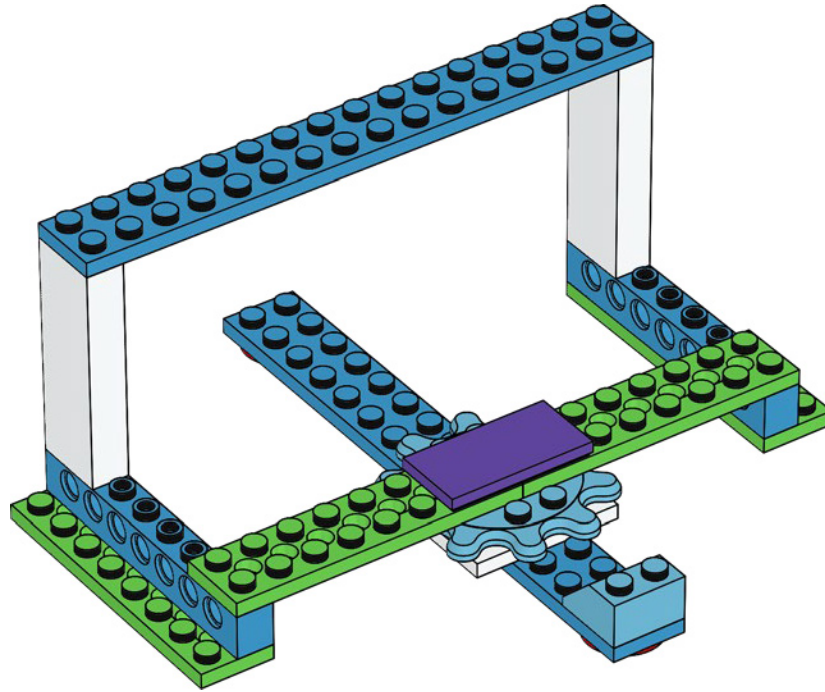

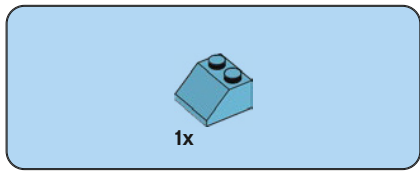

18

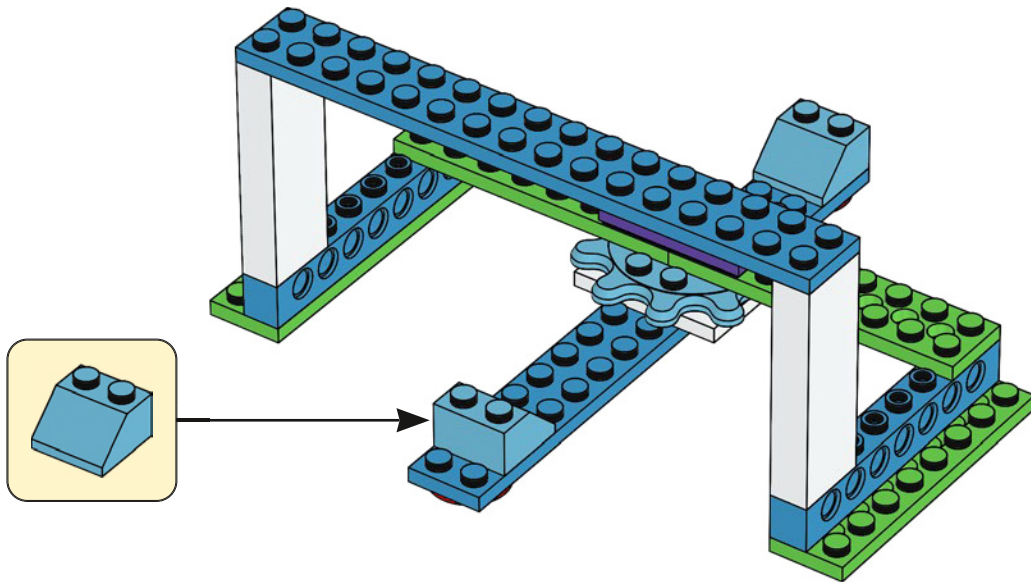

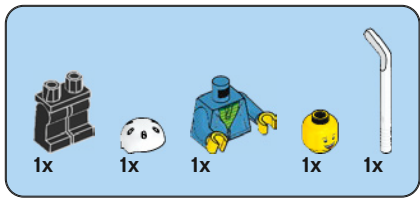

19

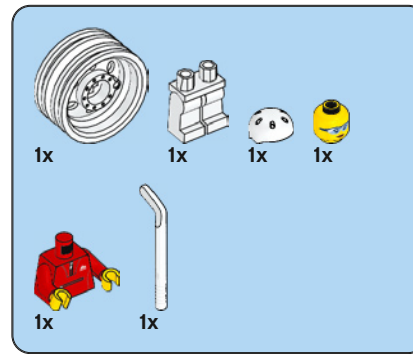
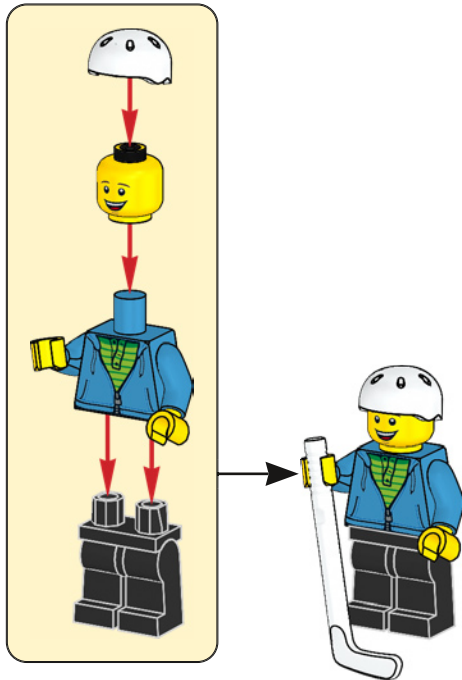

20

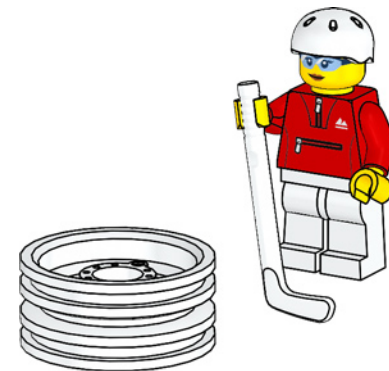

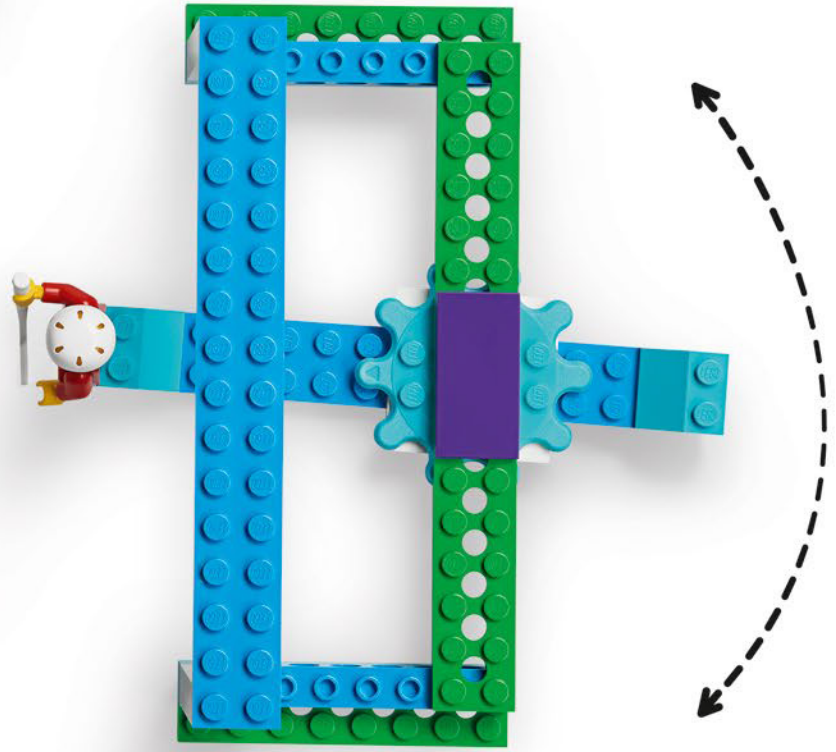
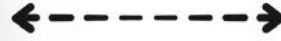
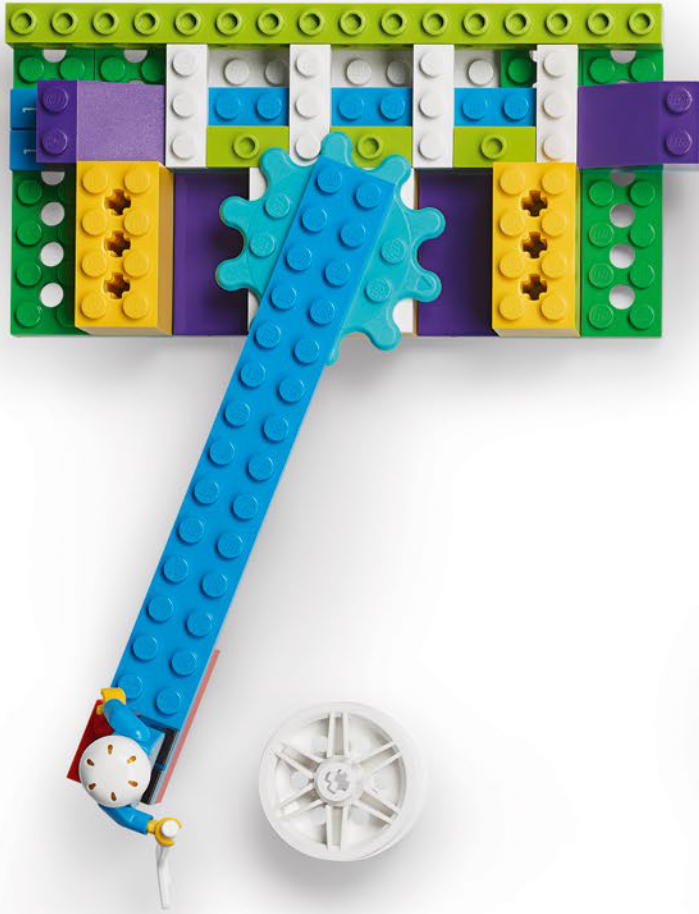

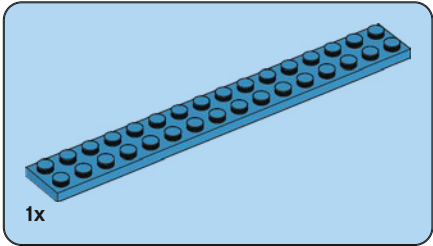
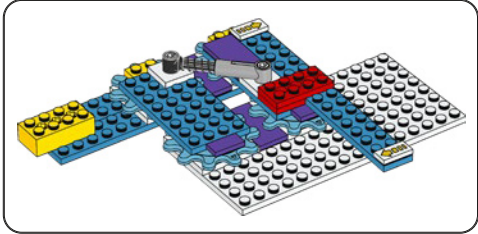
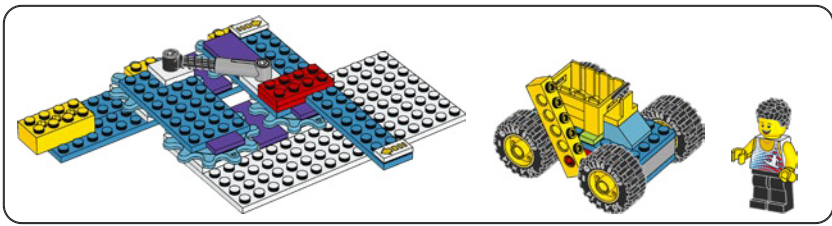

1

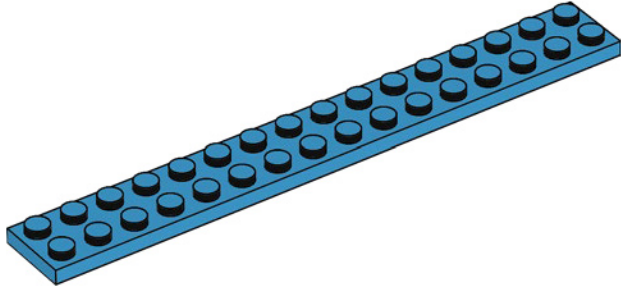

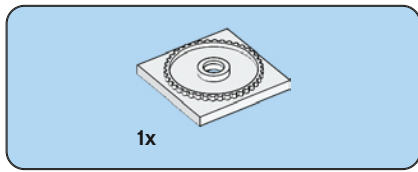

2

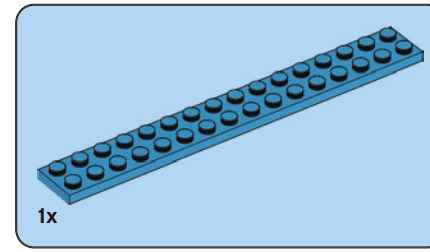
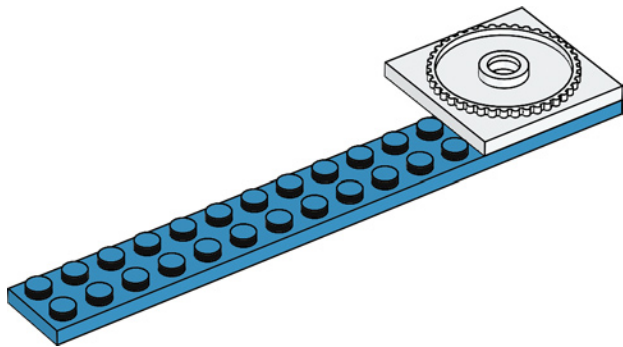

3

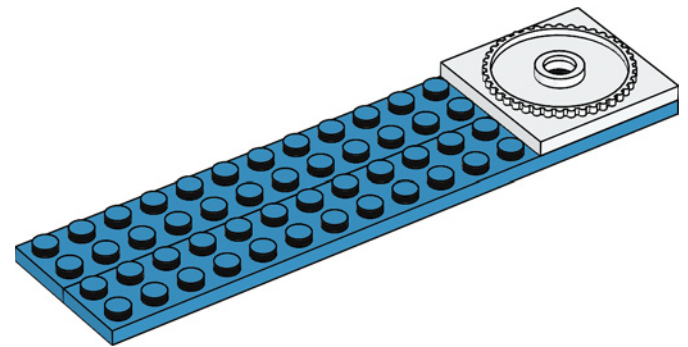

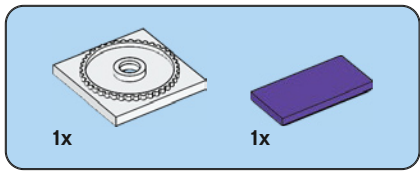

4

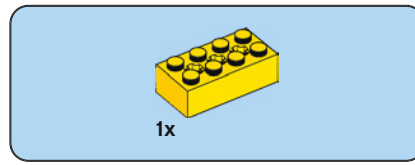
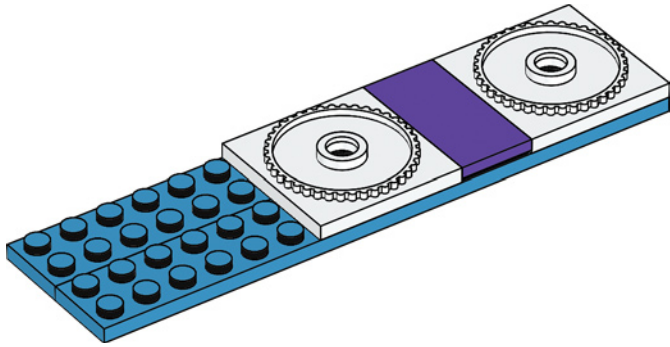

5

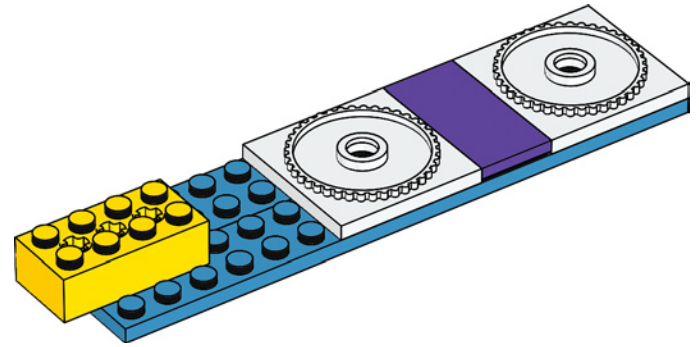

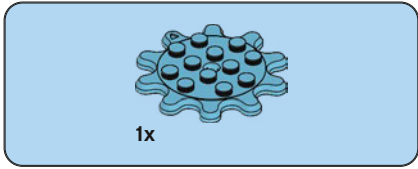
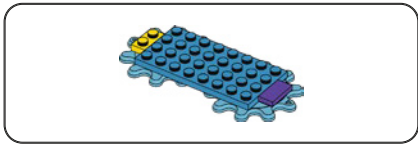

6

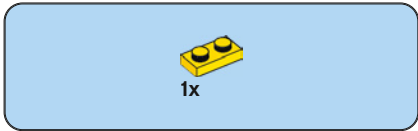
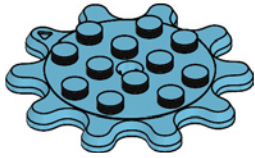

7

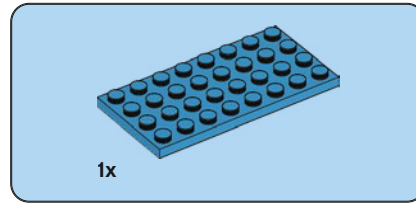

8

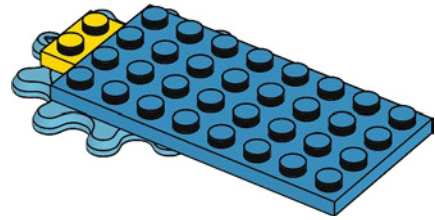

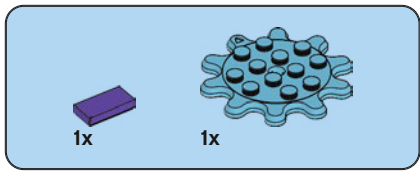

9

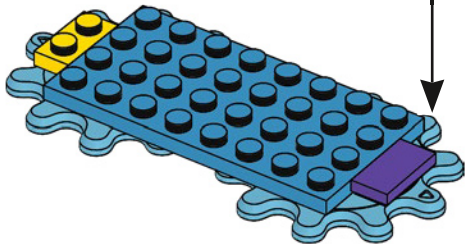
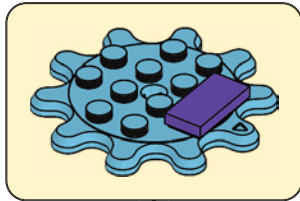

10

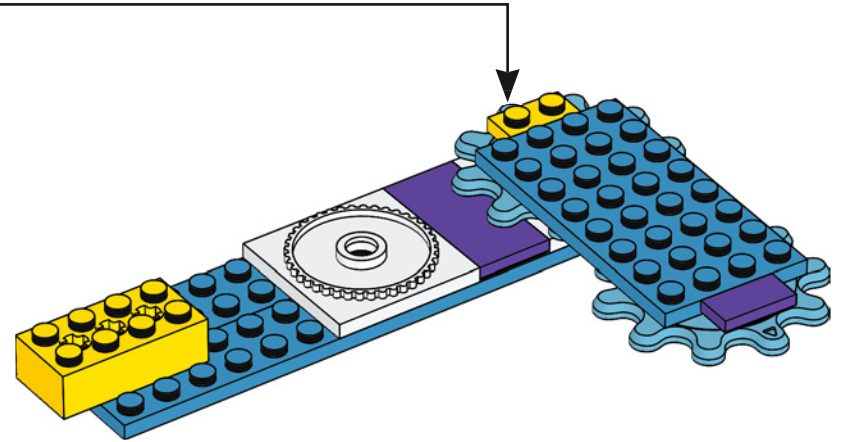

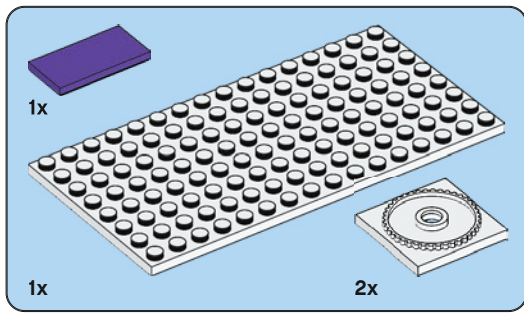

11

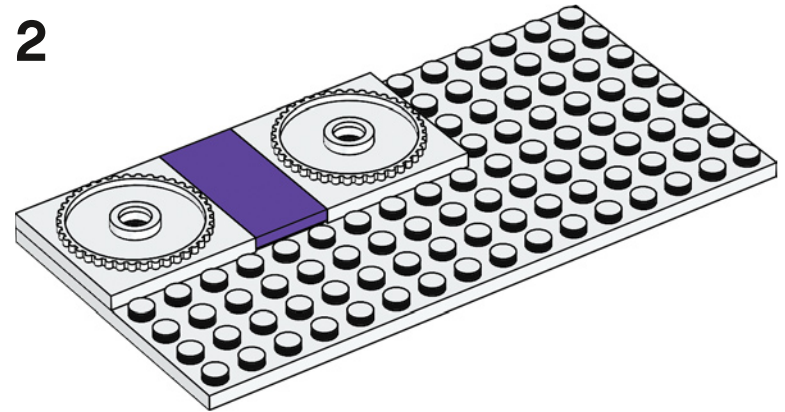
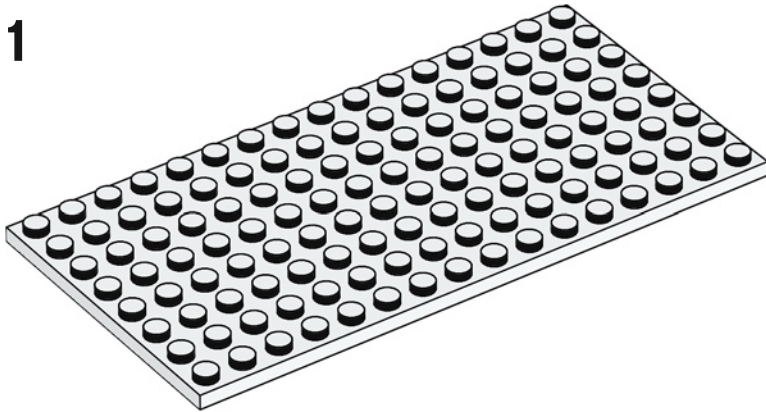

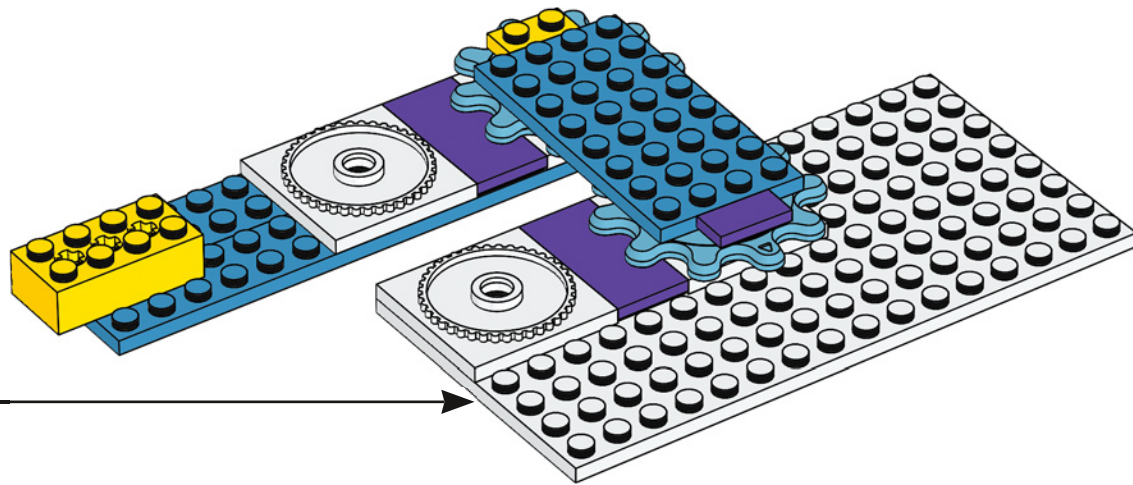

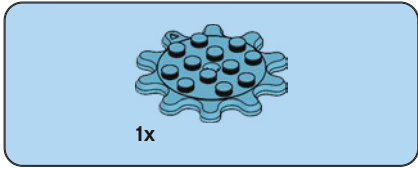
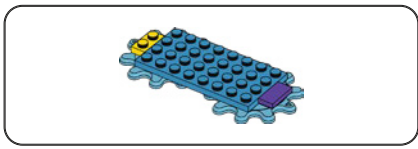

12

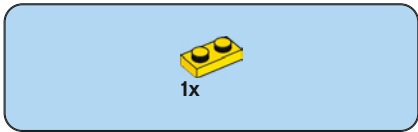

13

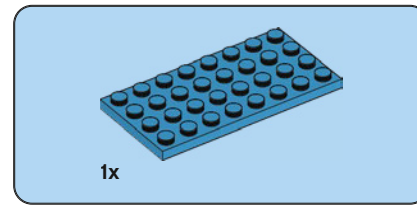

14

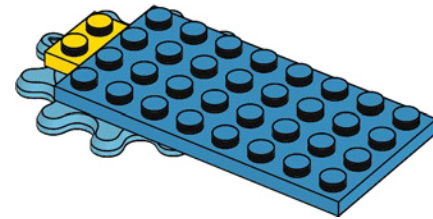

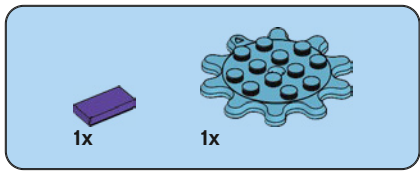

15

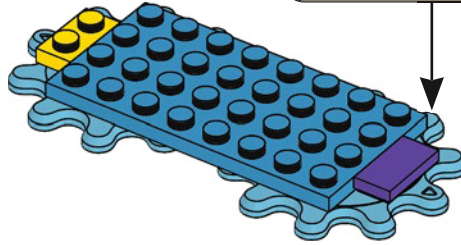
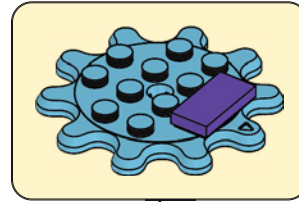

16

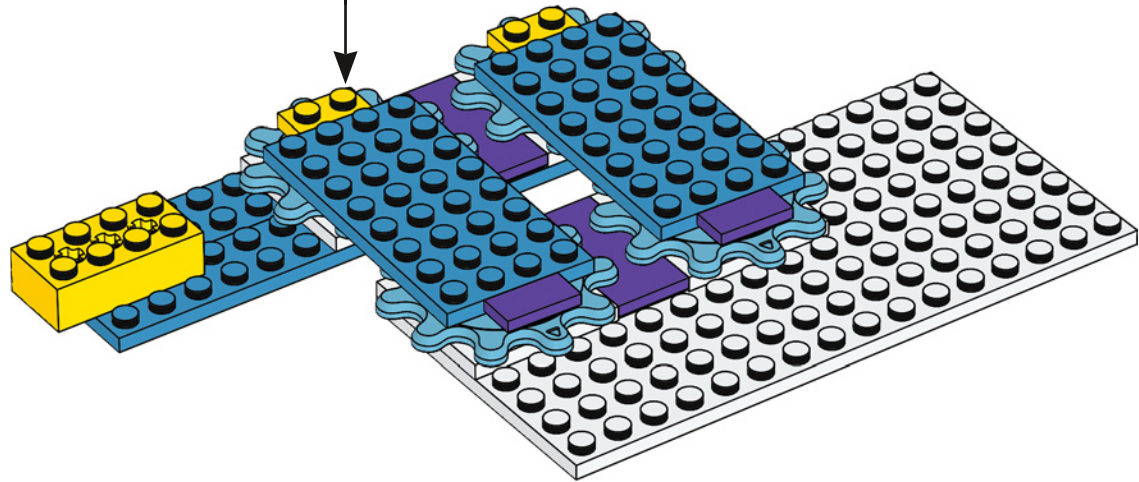

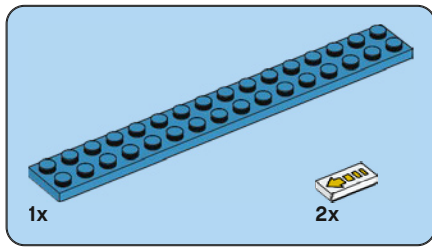

17

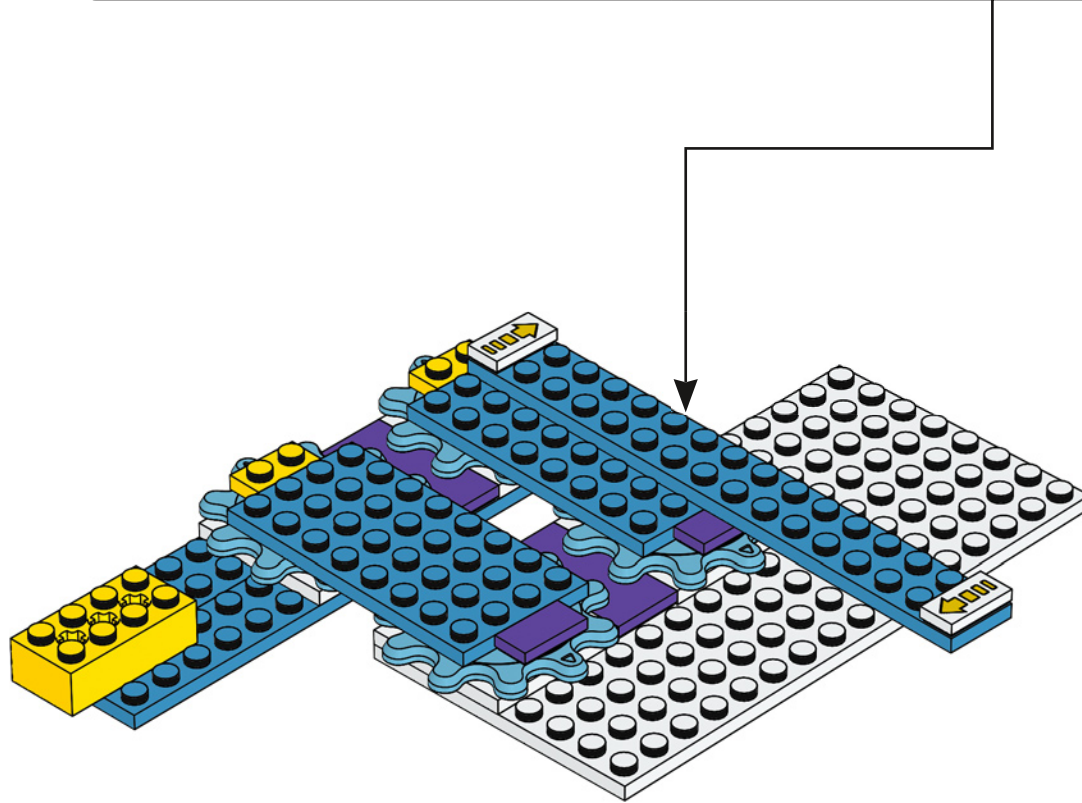
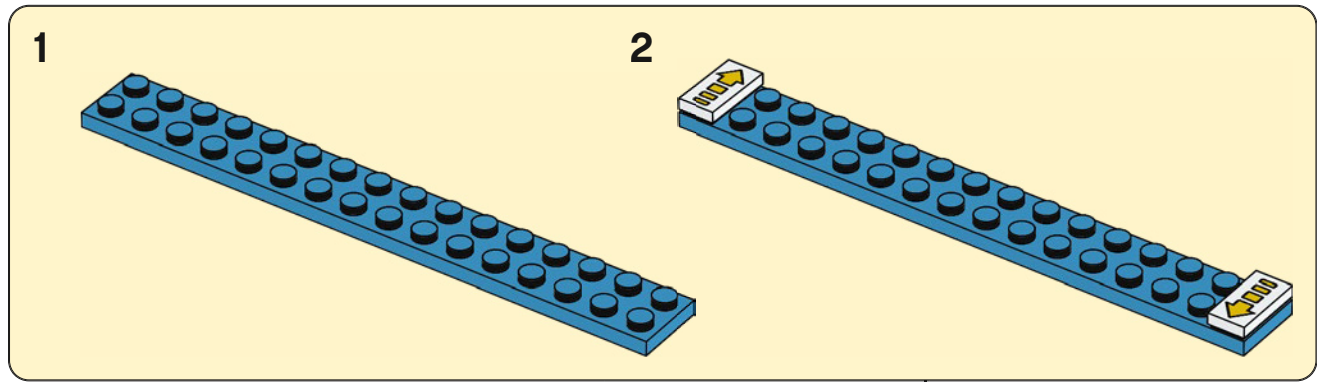

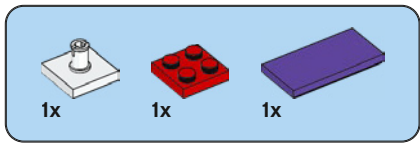

18

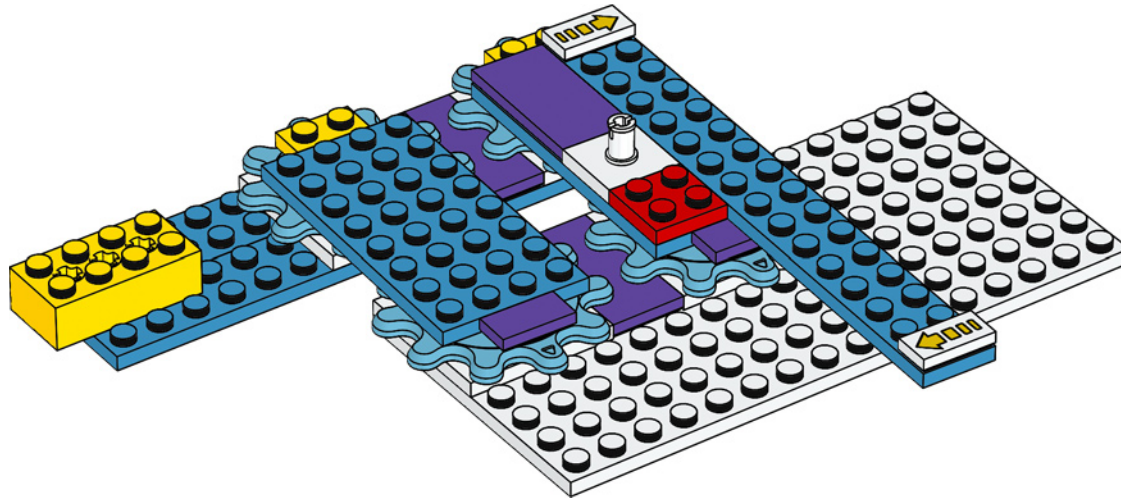

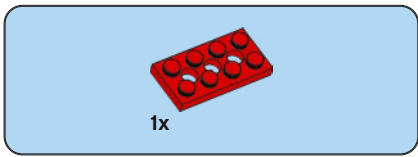

19

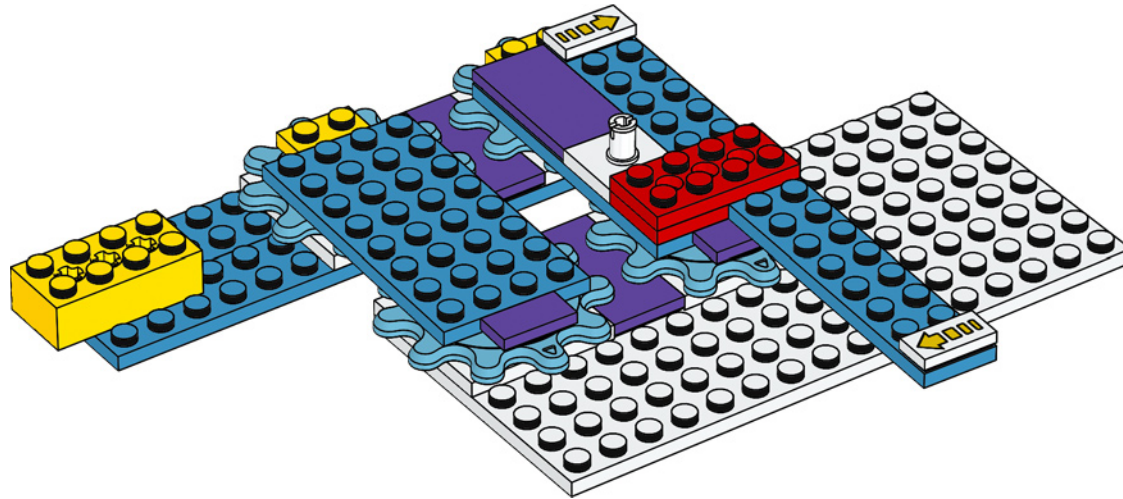



1x

20

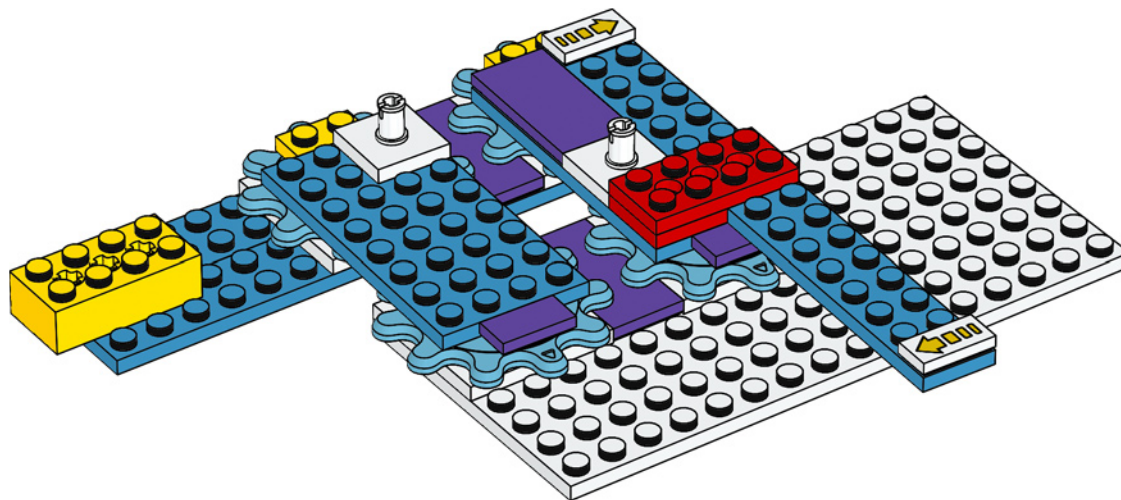

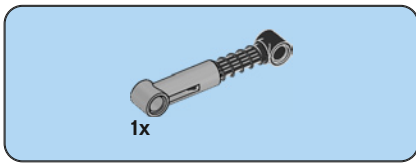

21

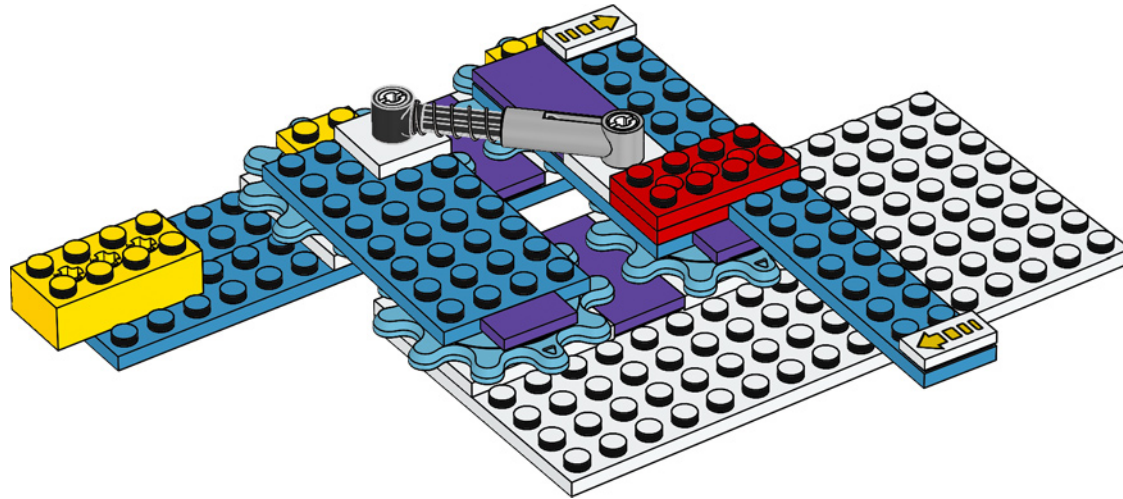

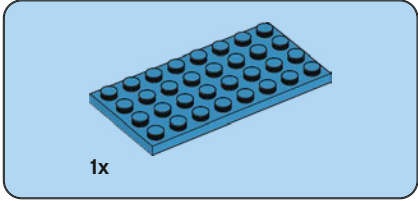
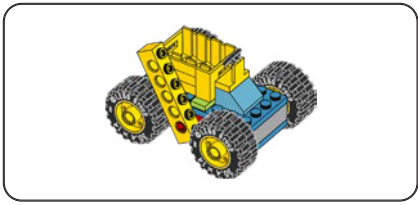

22

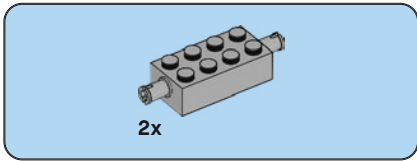
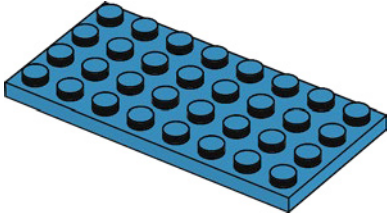

23

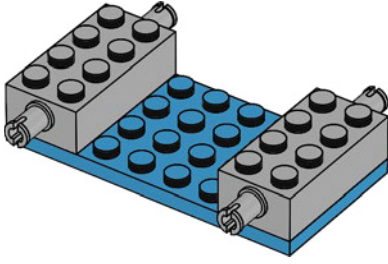

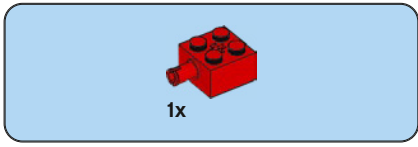

24

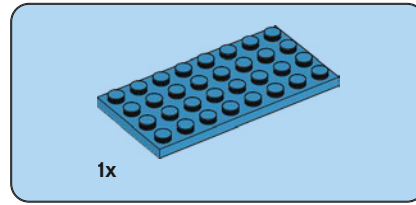
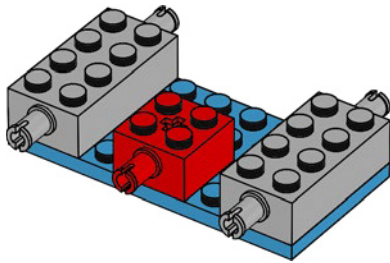

25

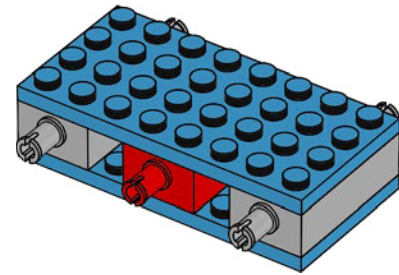



4x

26

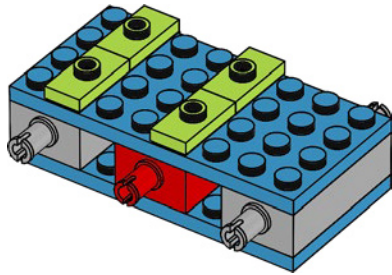

1x

27

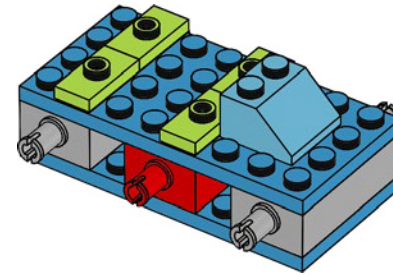

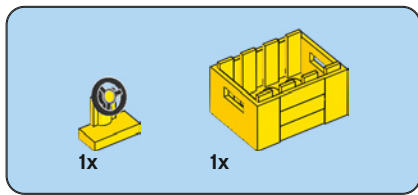

28

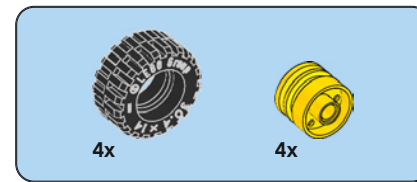
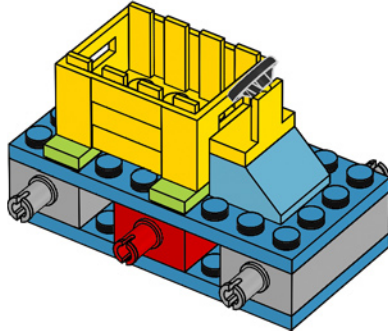

29

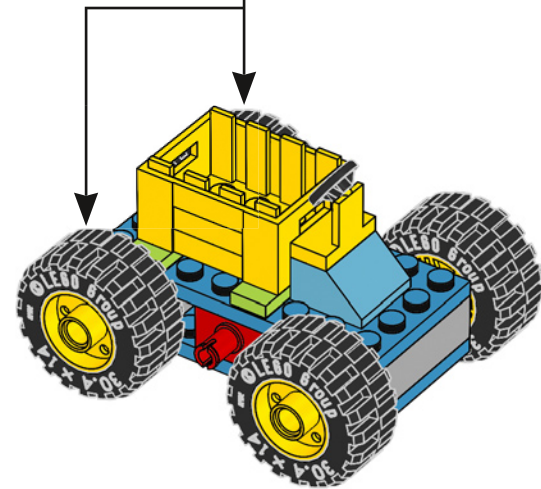
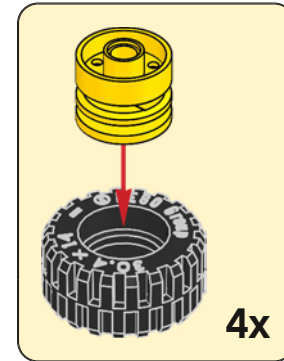

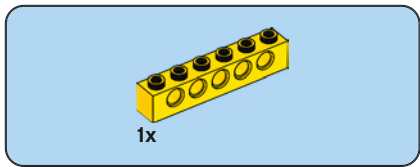

30

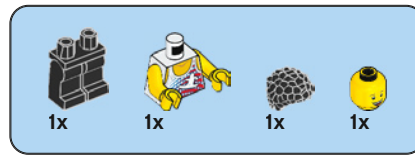
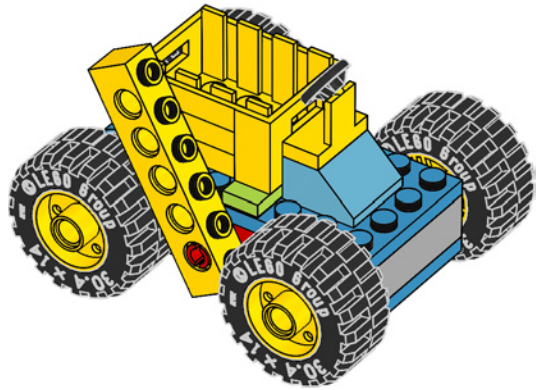

31

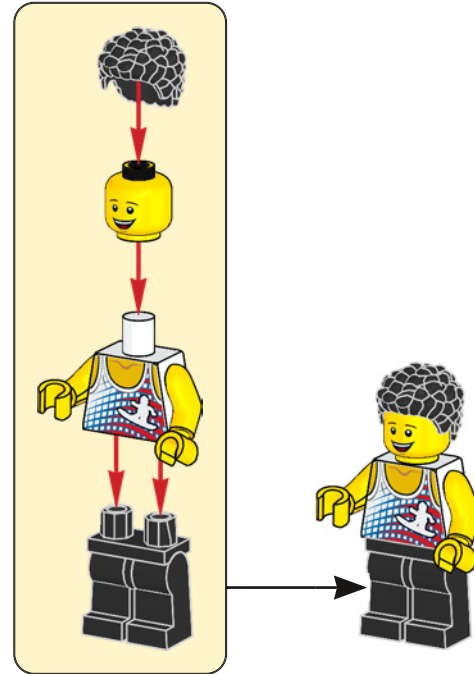

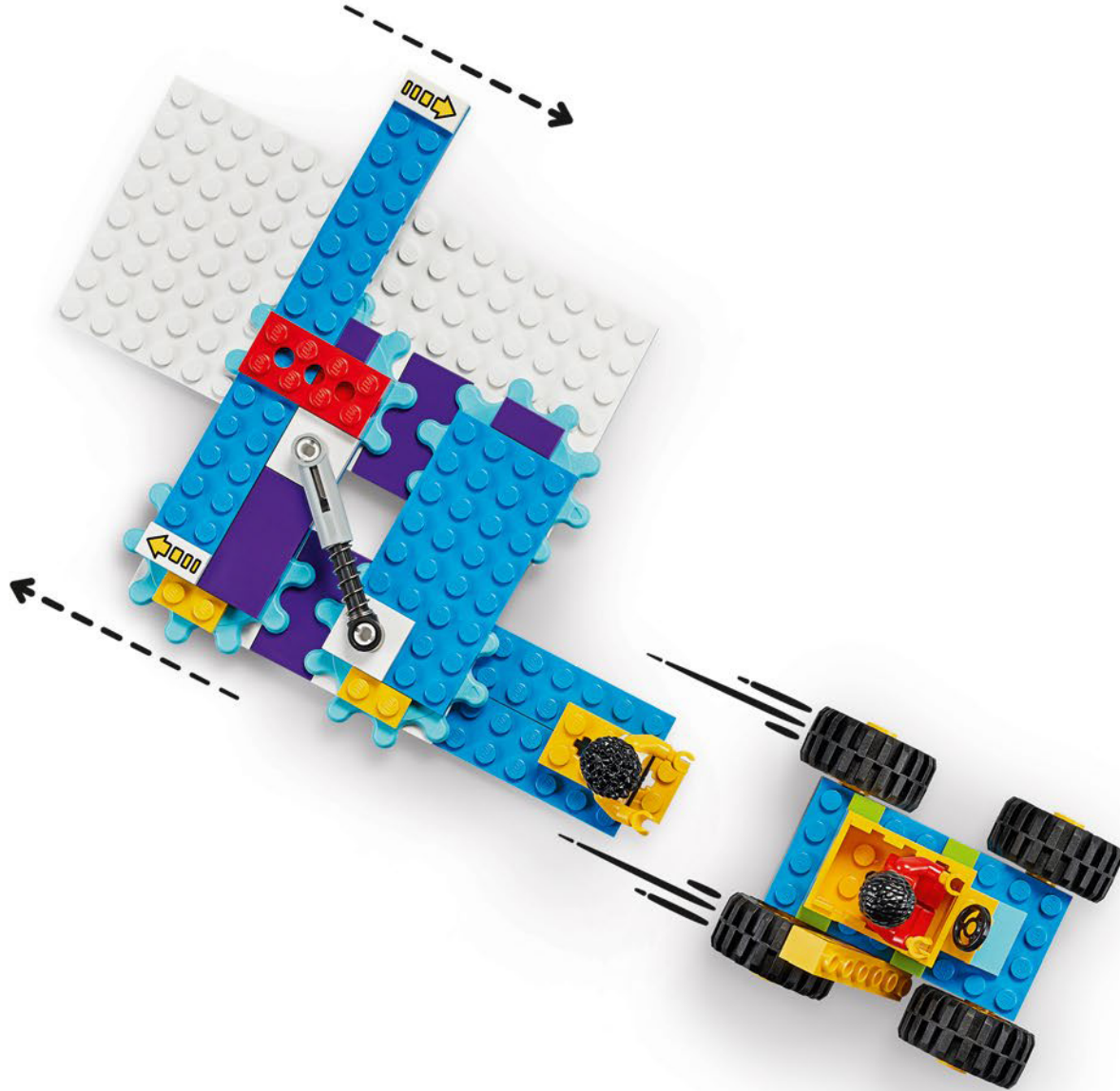

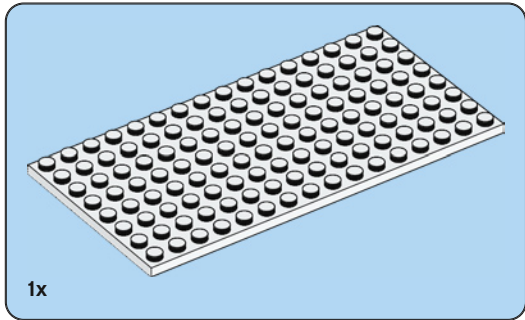
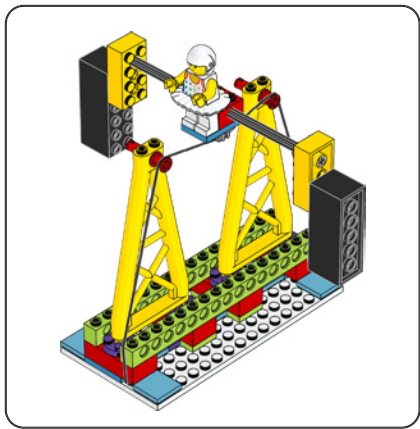

1

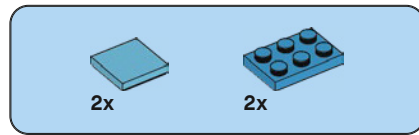
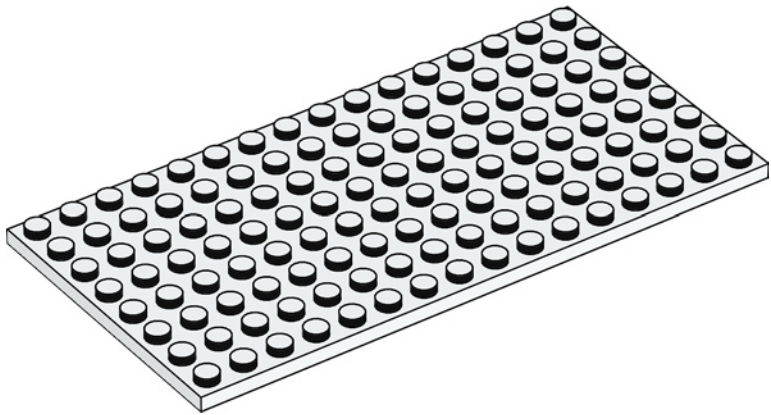

2

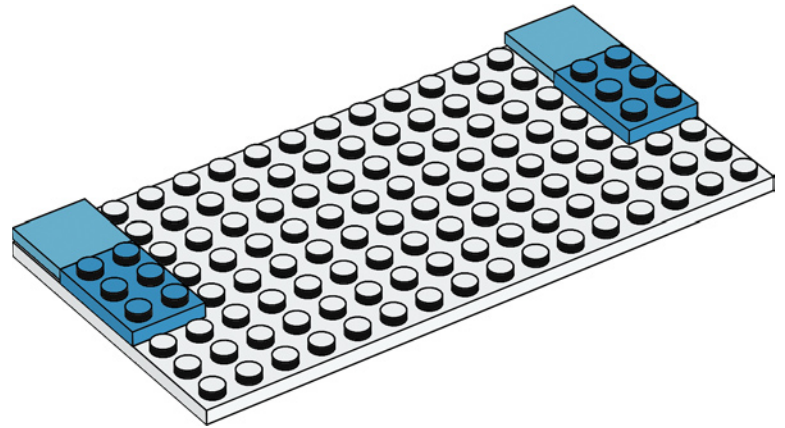

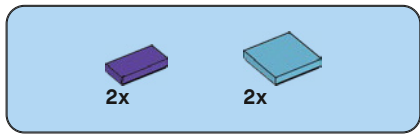

3

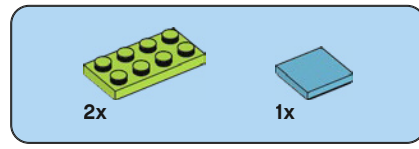
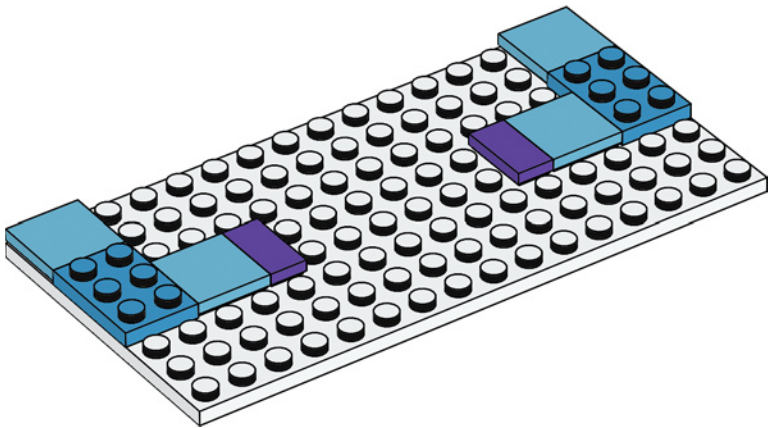

4

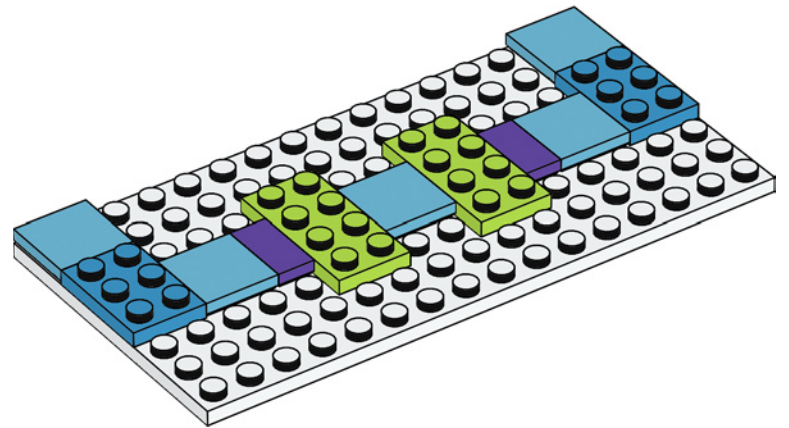

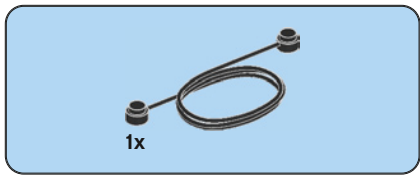

5

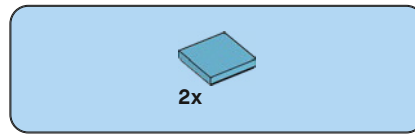
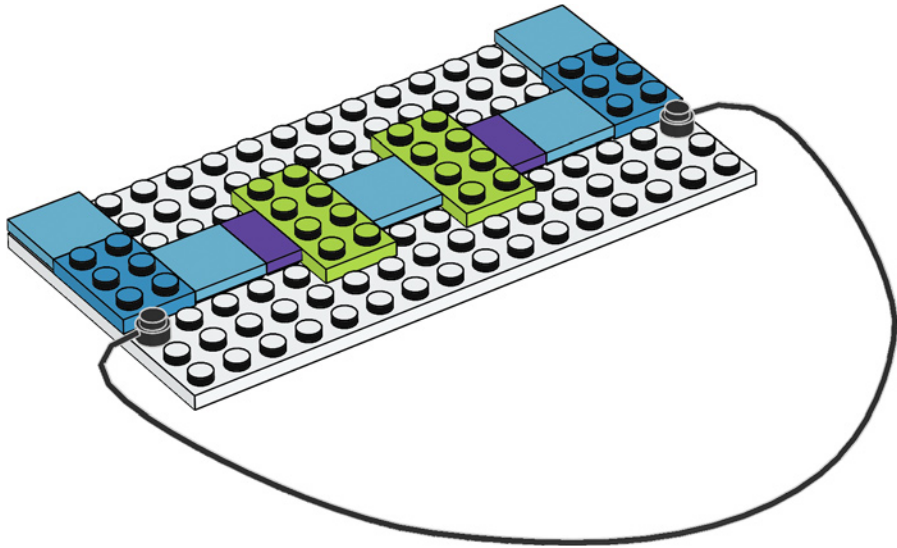

6

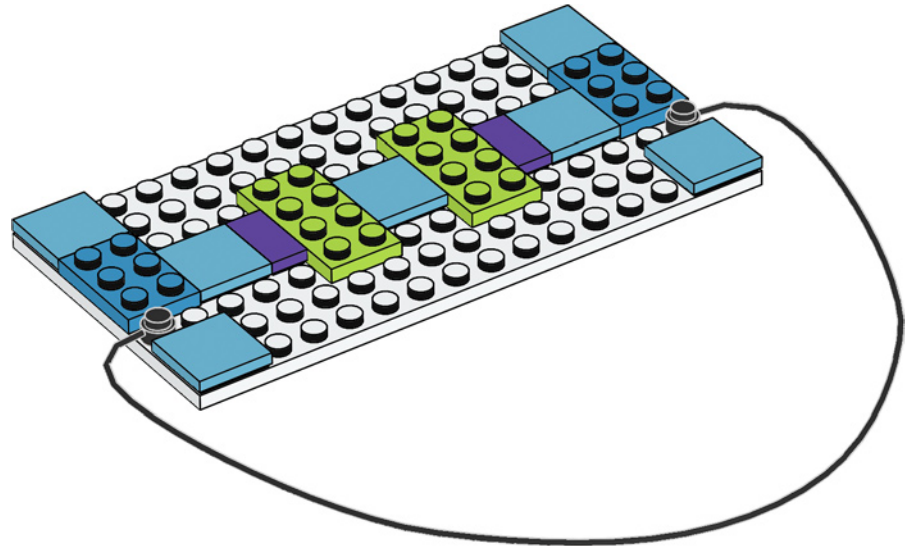

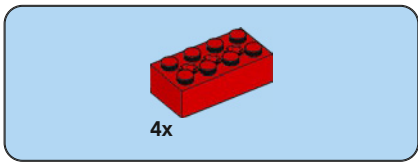

7

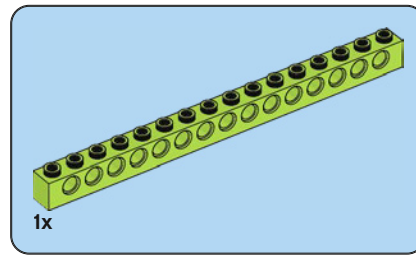
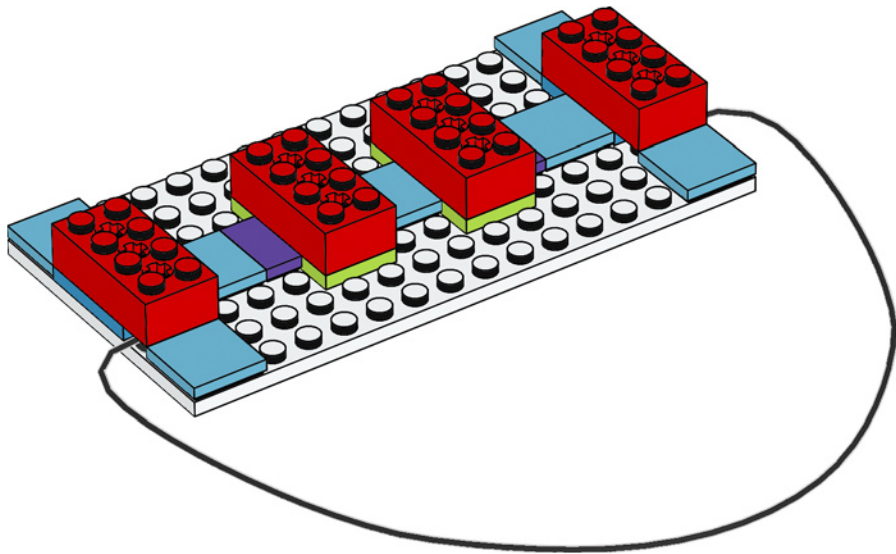

8

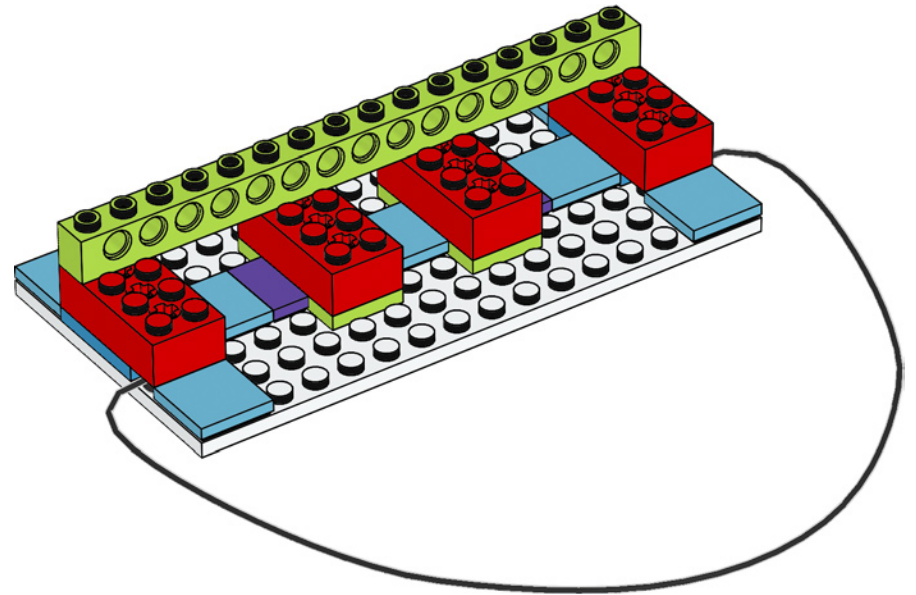



4x

9

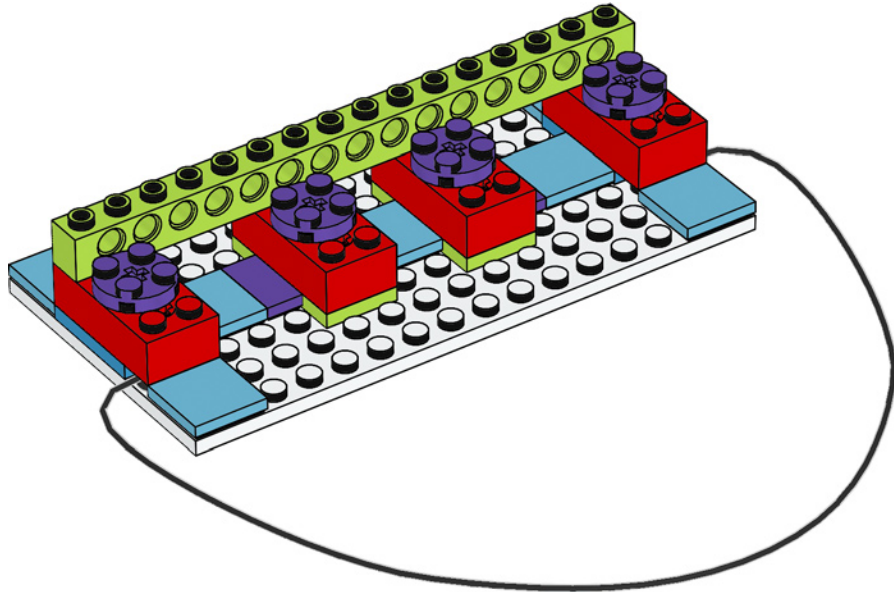

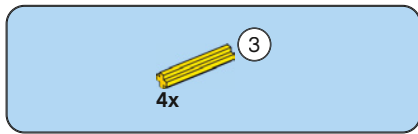

10

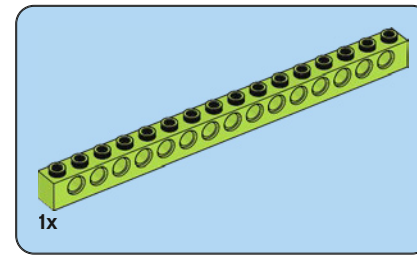
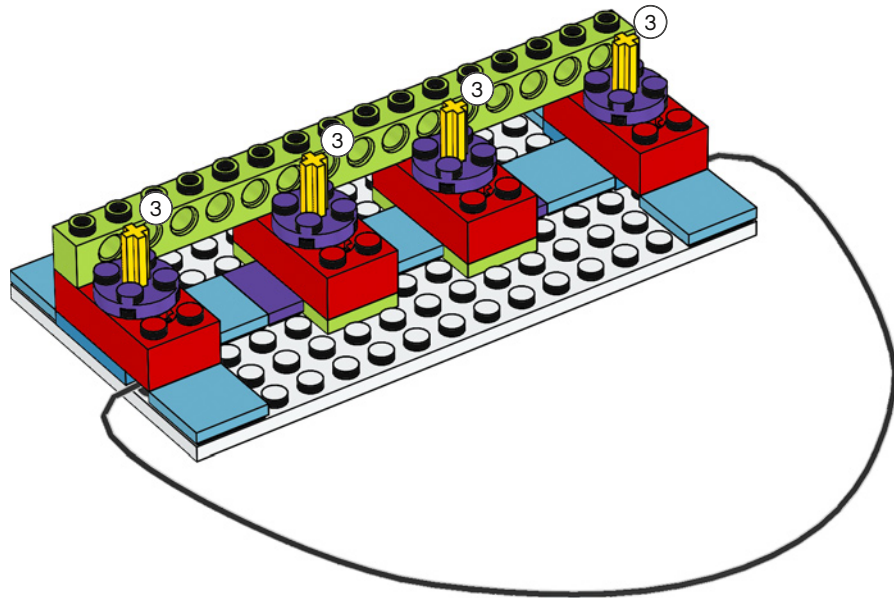

11

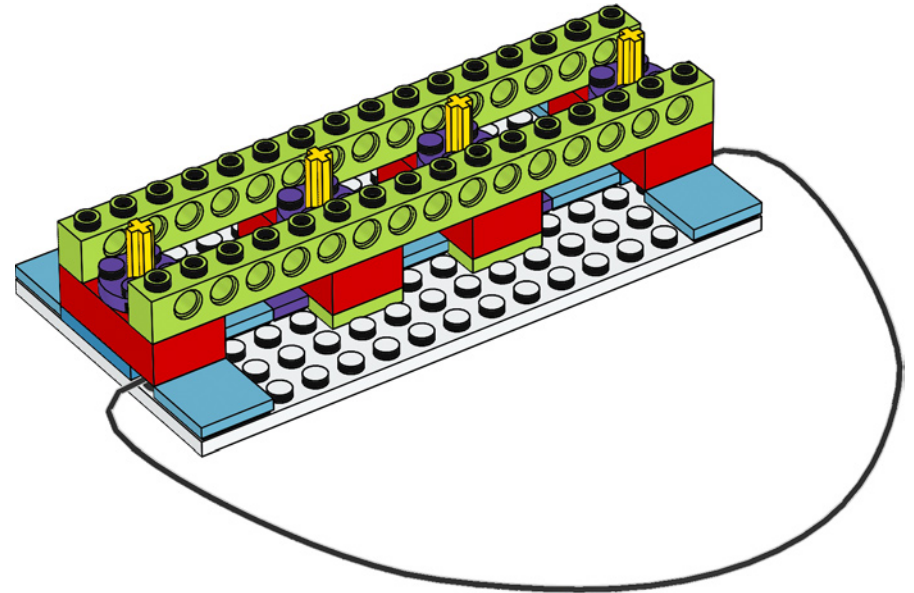

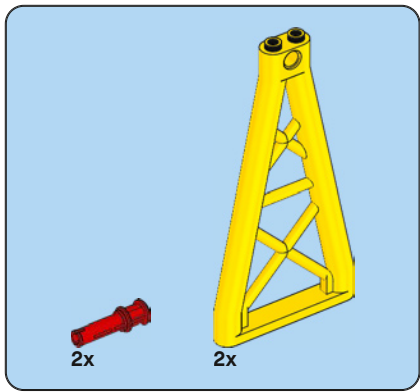

12

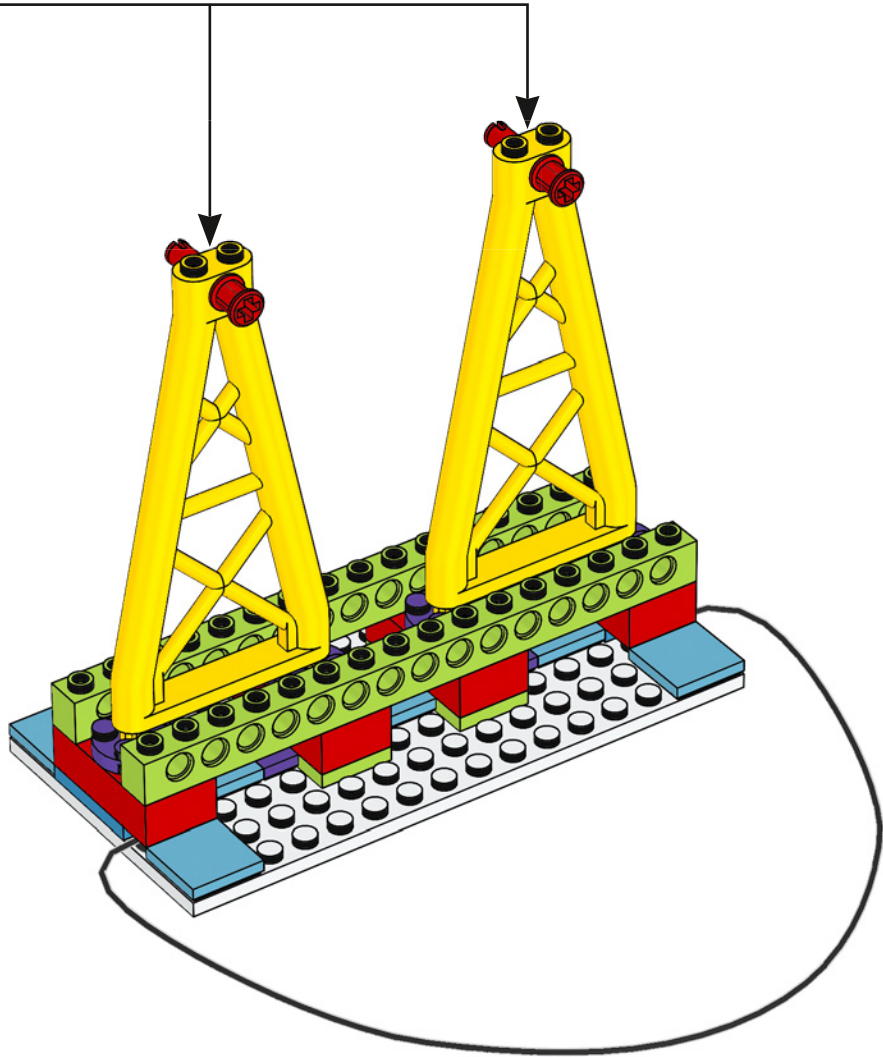
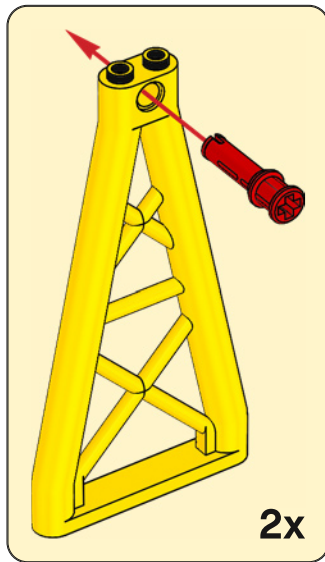

13

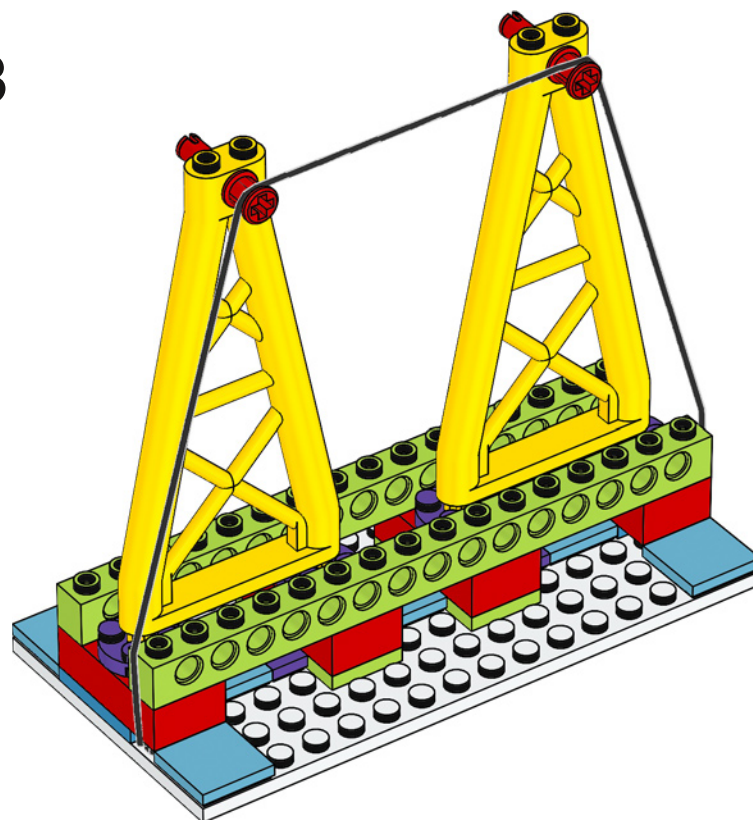

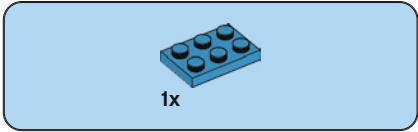
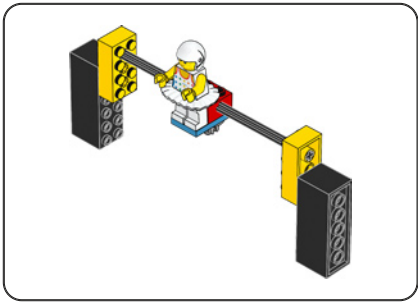

14

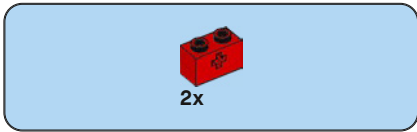
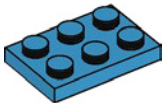

15

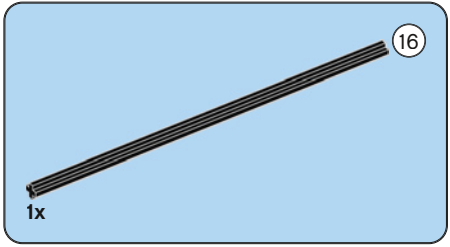
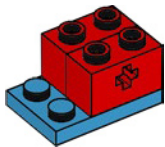

16

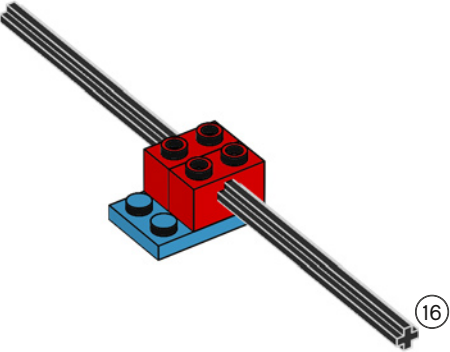

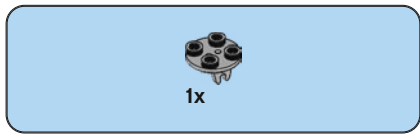

17

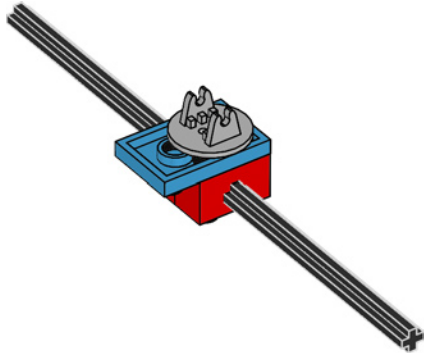

18

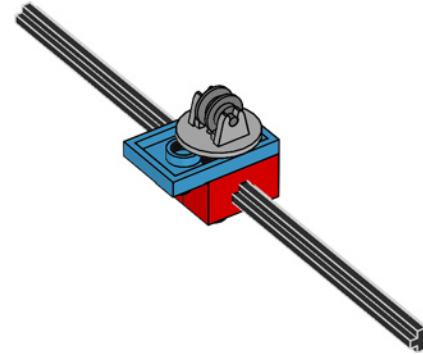

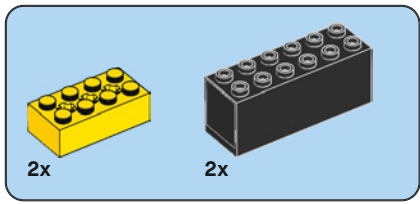

19

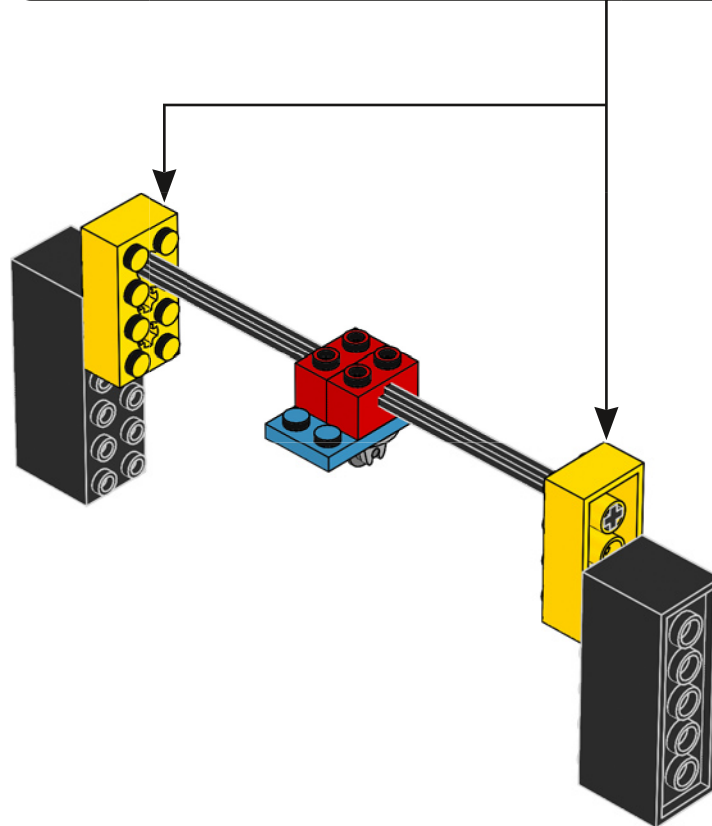
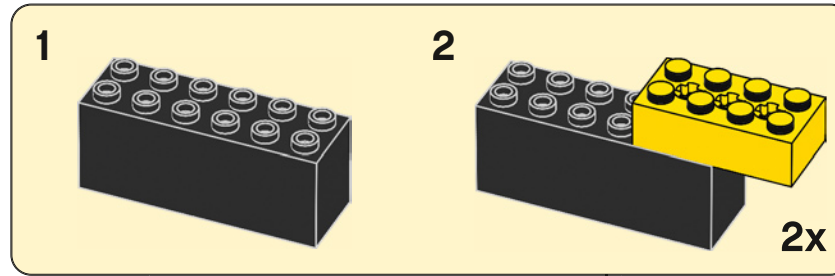

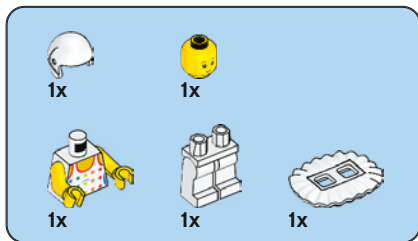

20

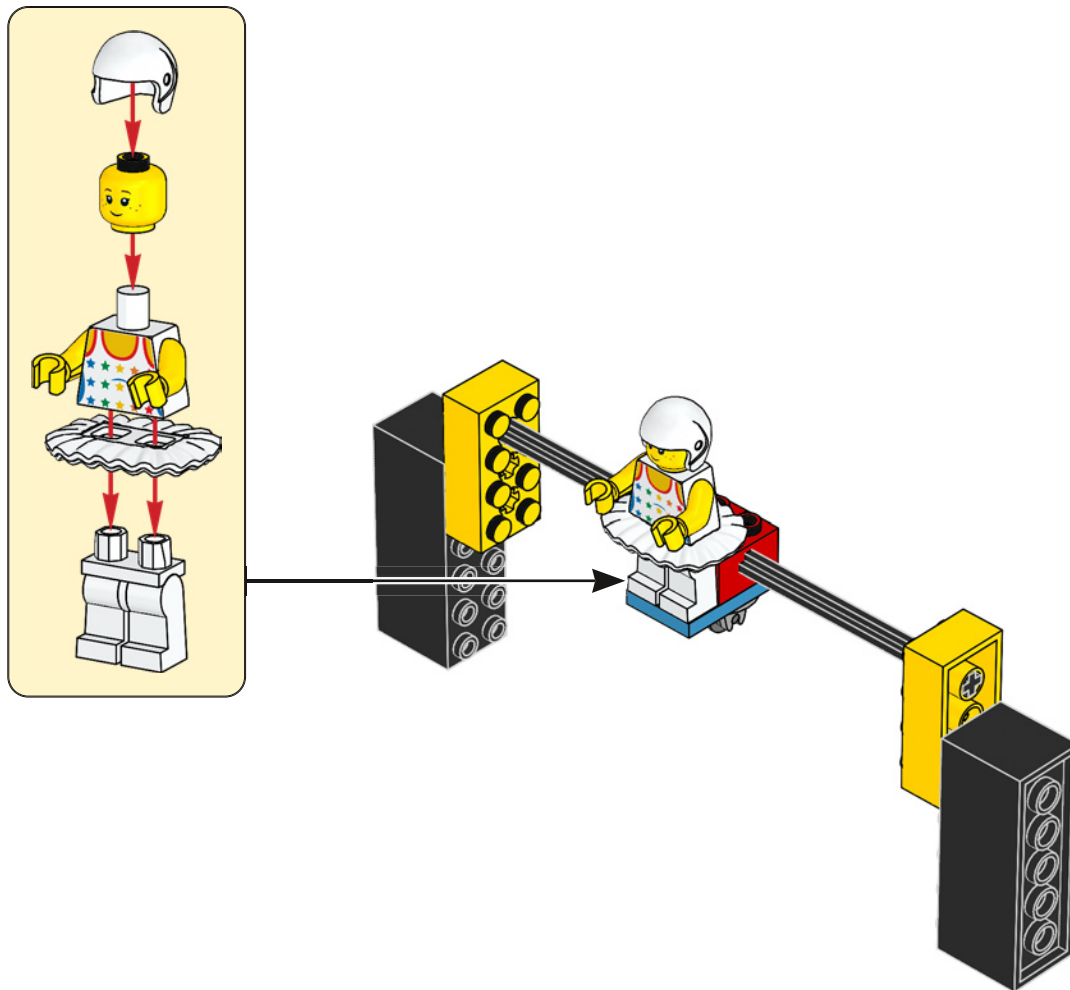

21

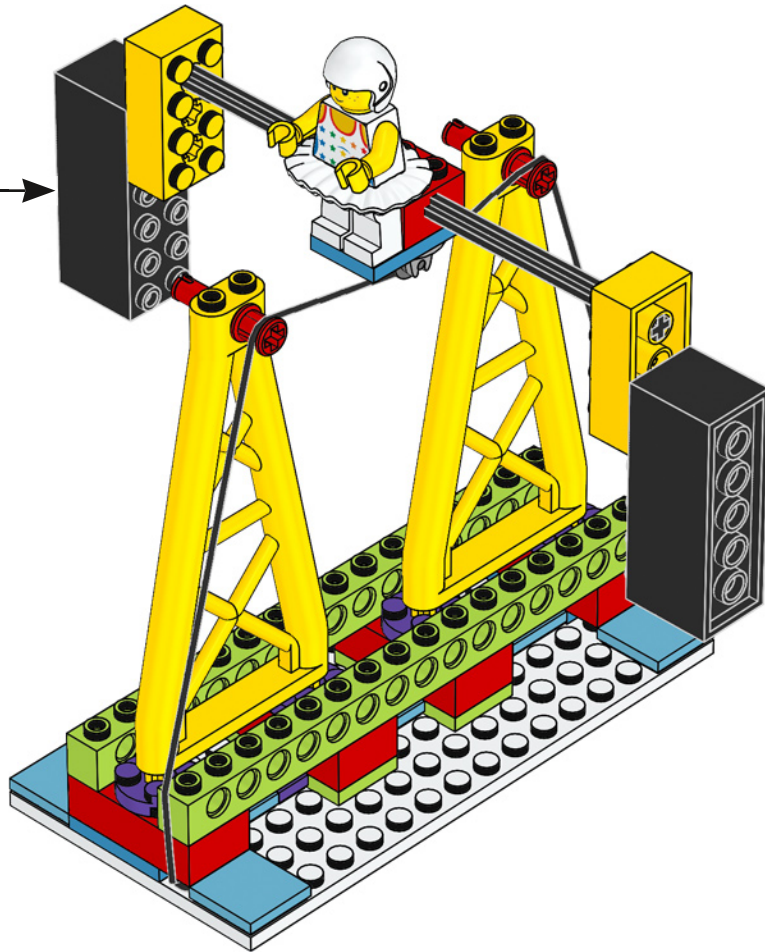



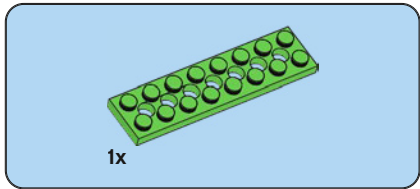
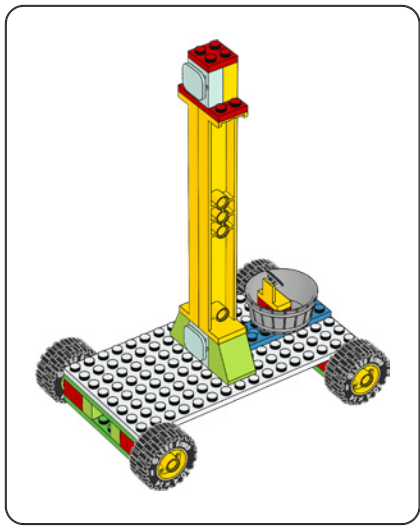

1

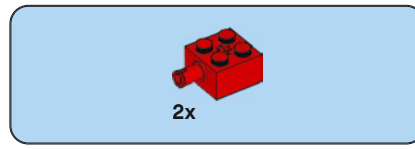
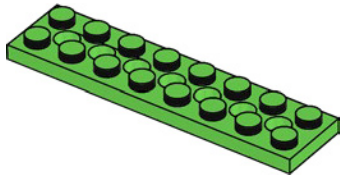

2

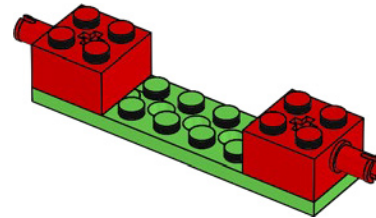

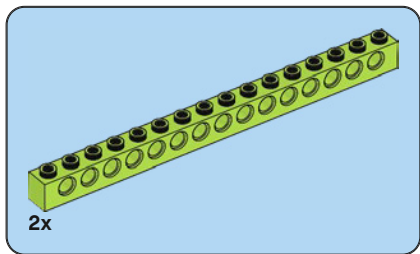

3

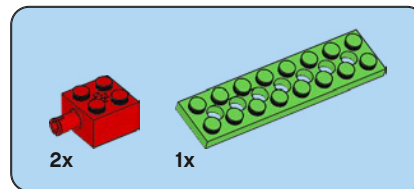
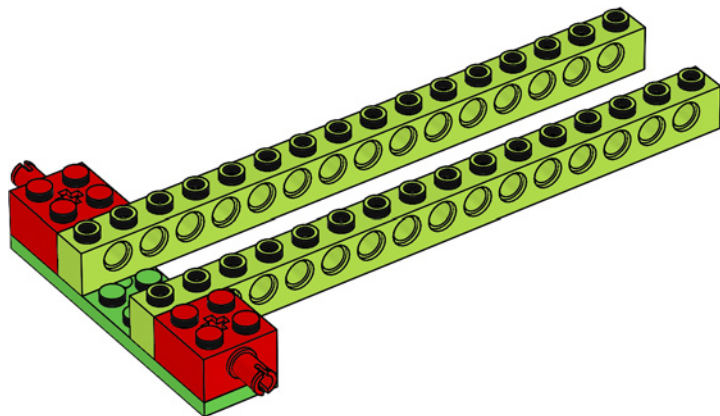

4

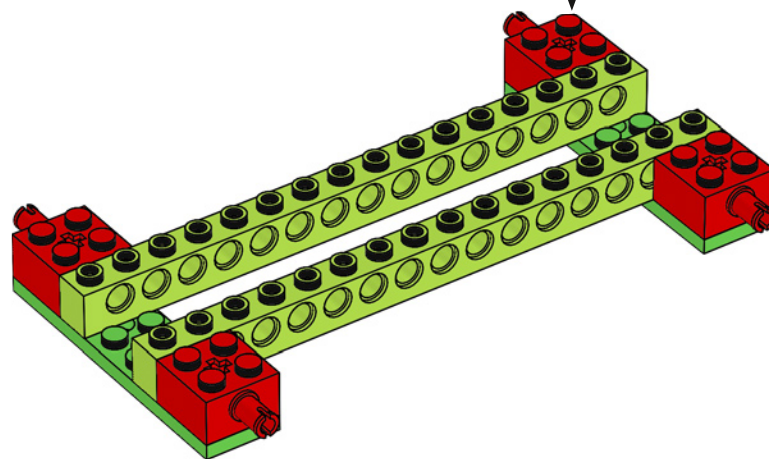
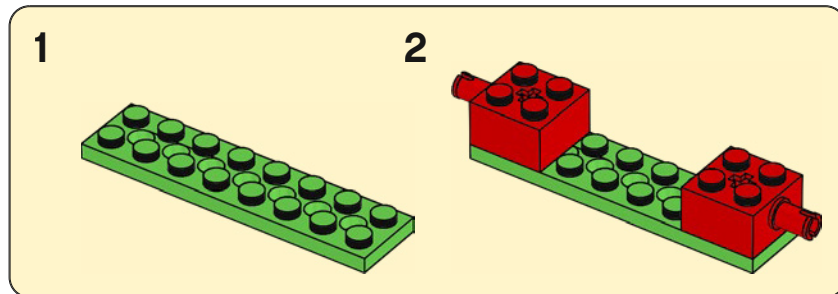

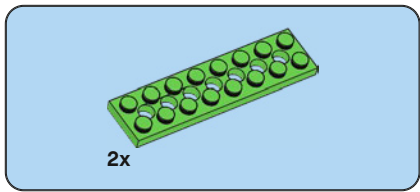

5

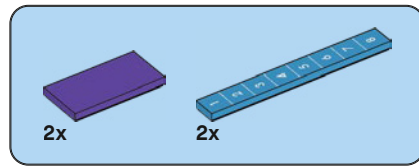
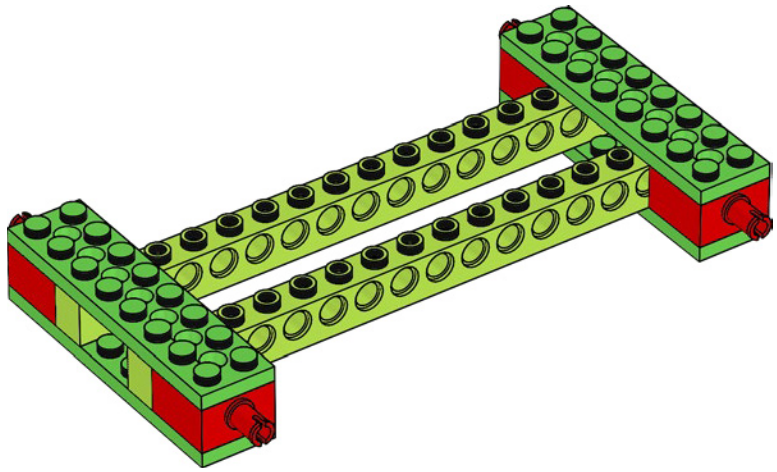

6

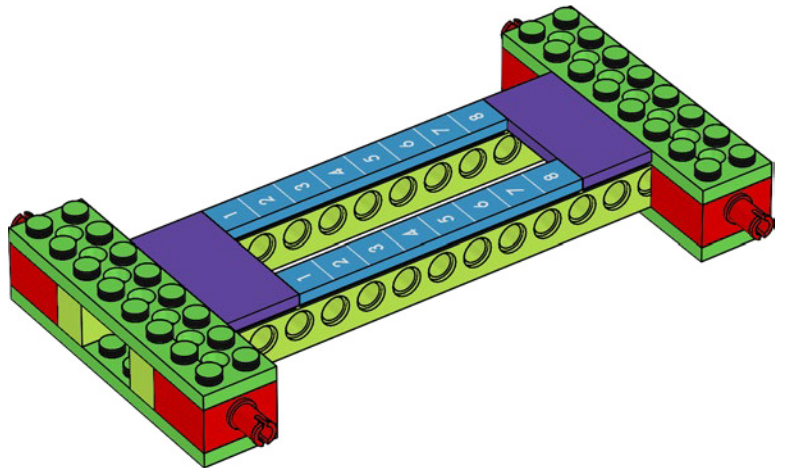

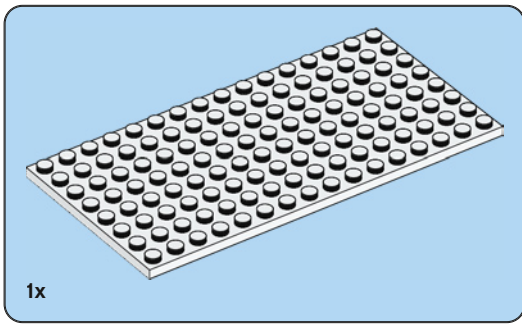

7

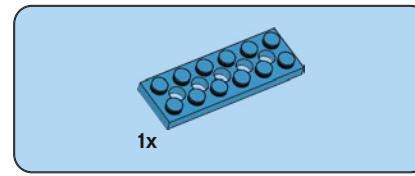
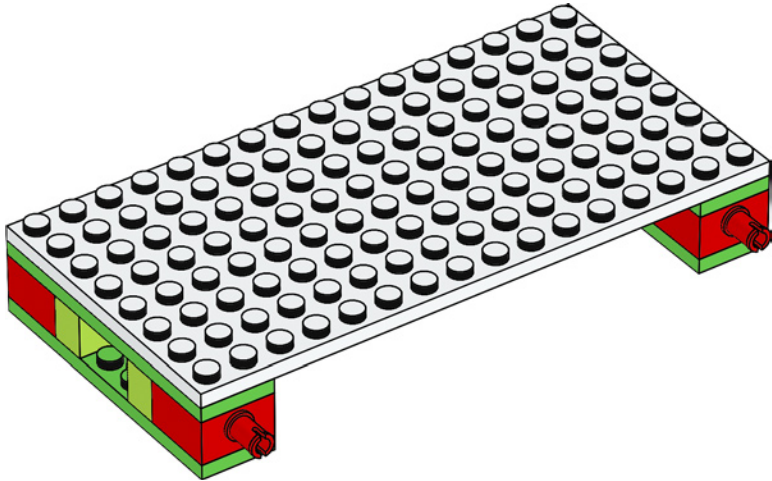

8

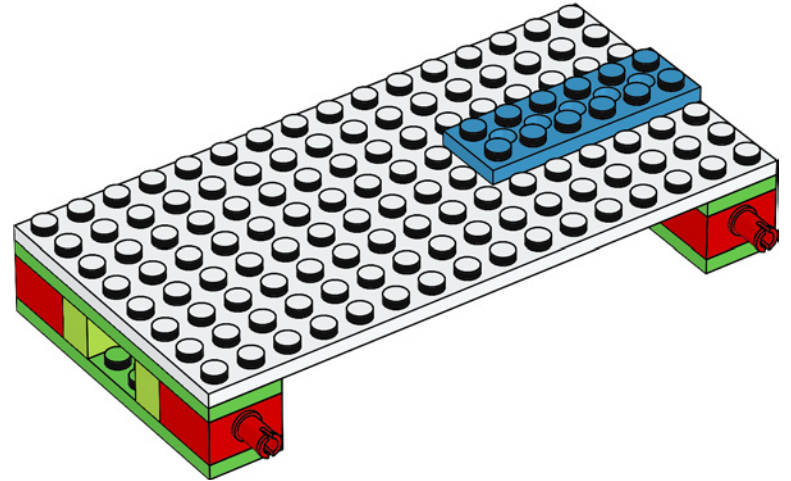

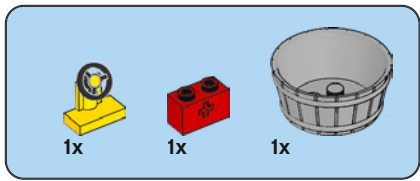

9

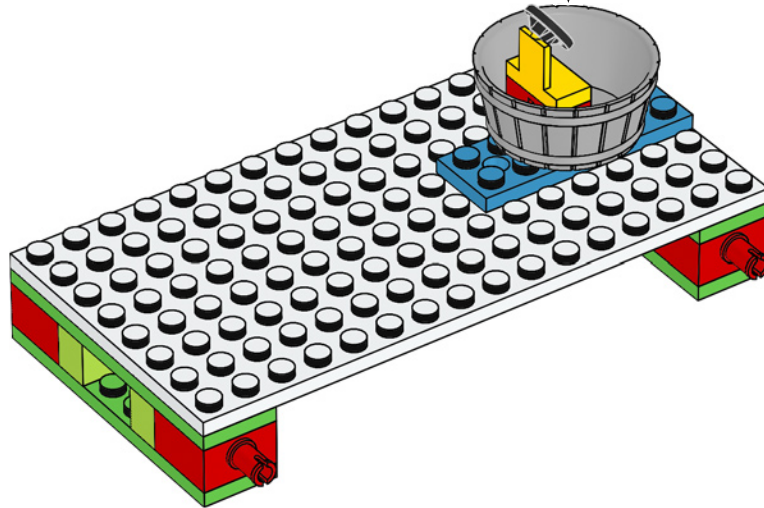
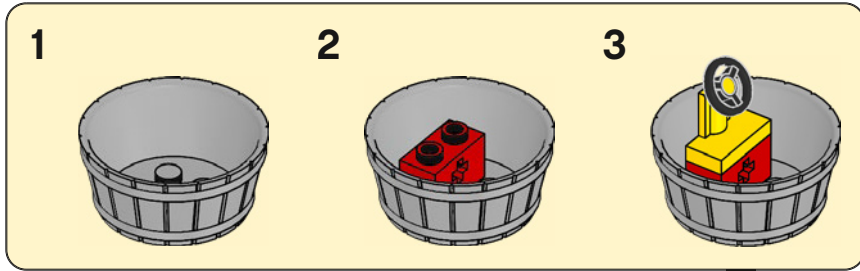

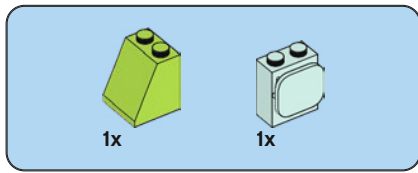

10

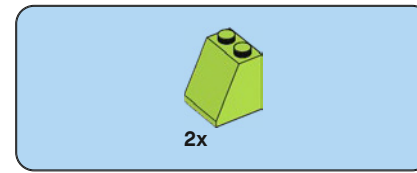
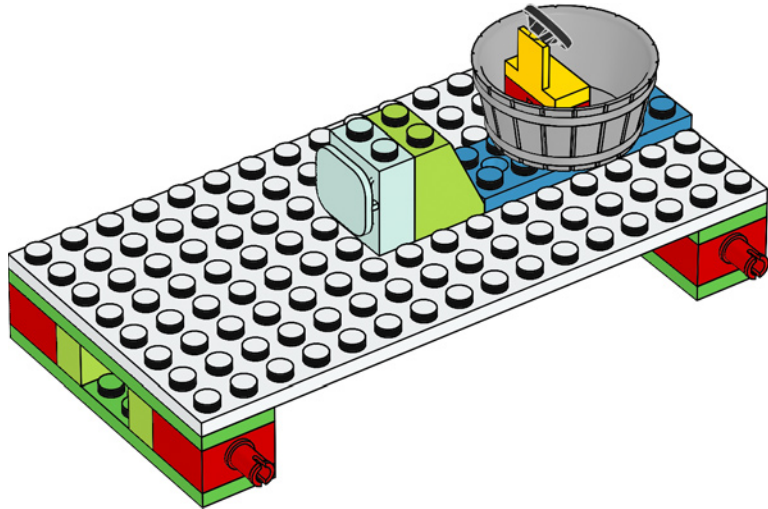

11

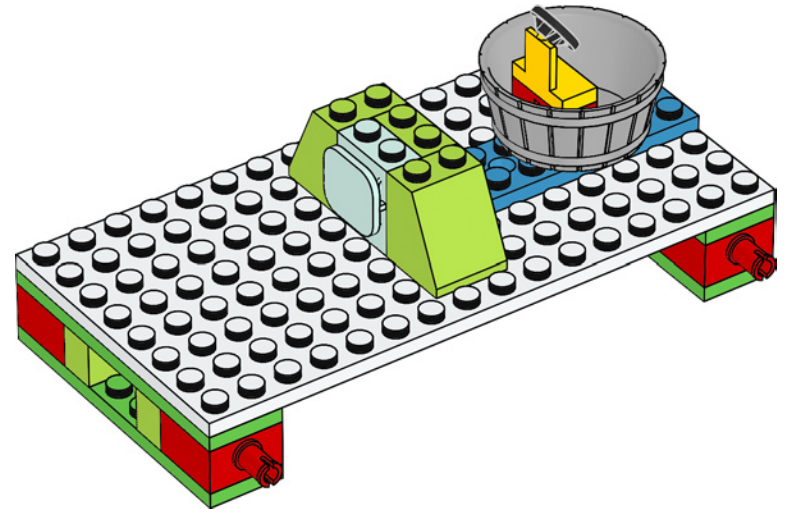

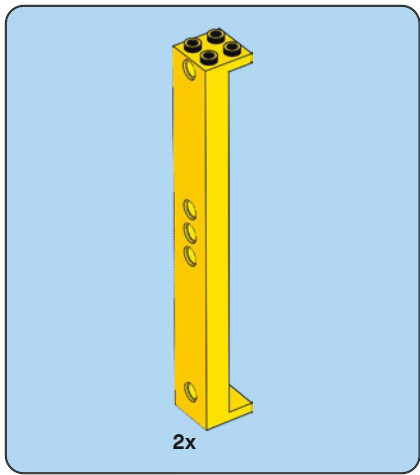

12

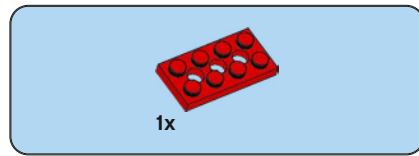
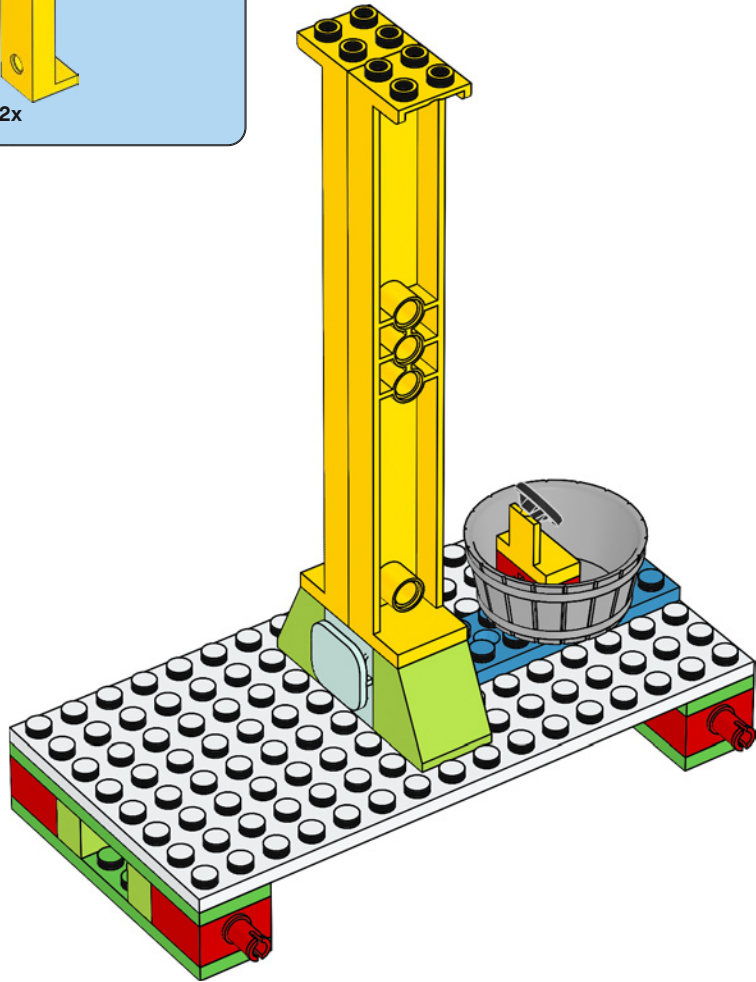

13

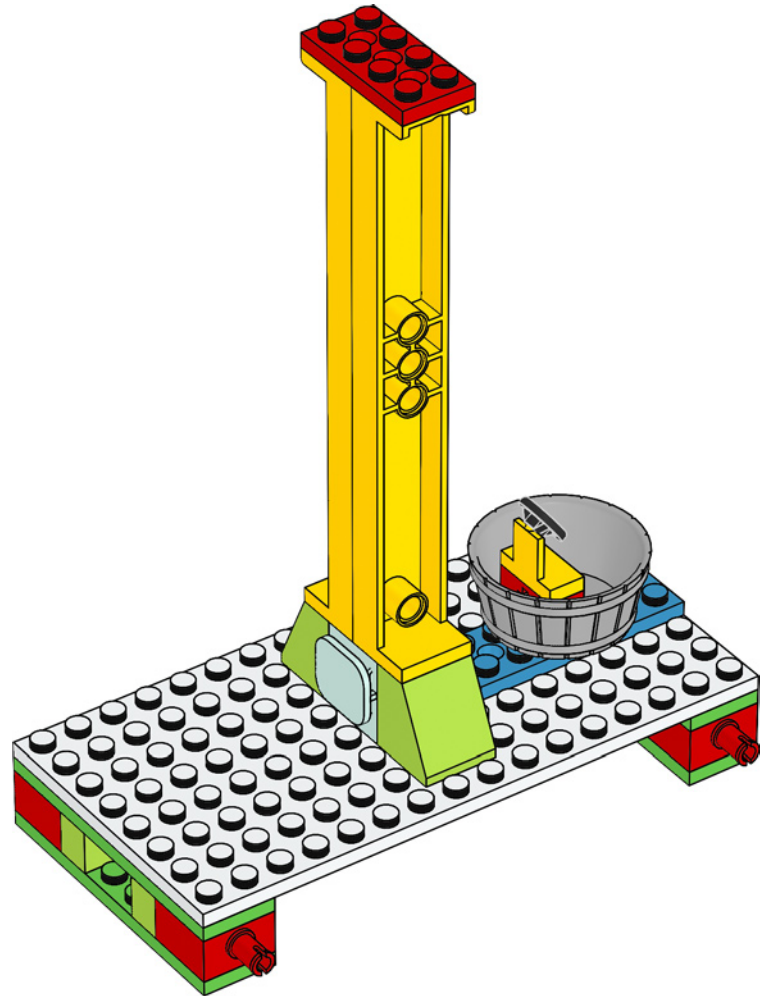

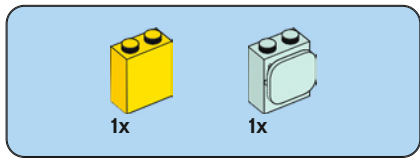

14

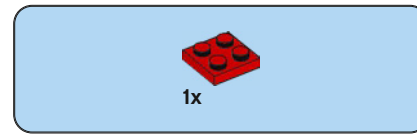
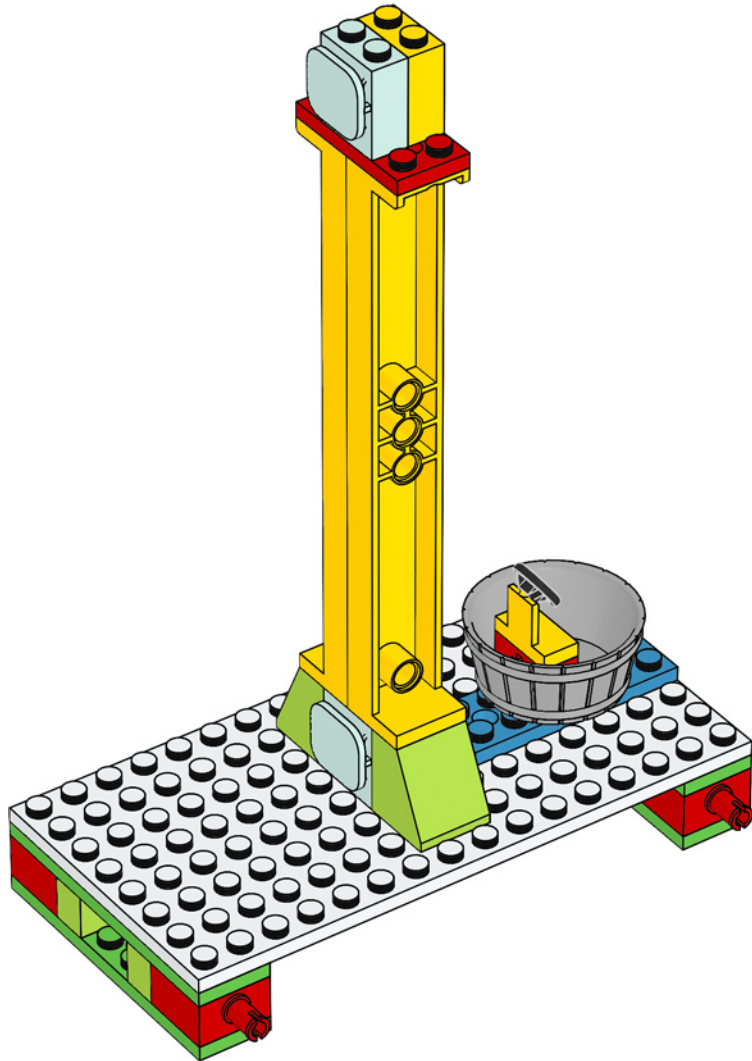

15

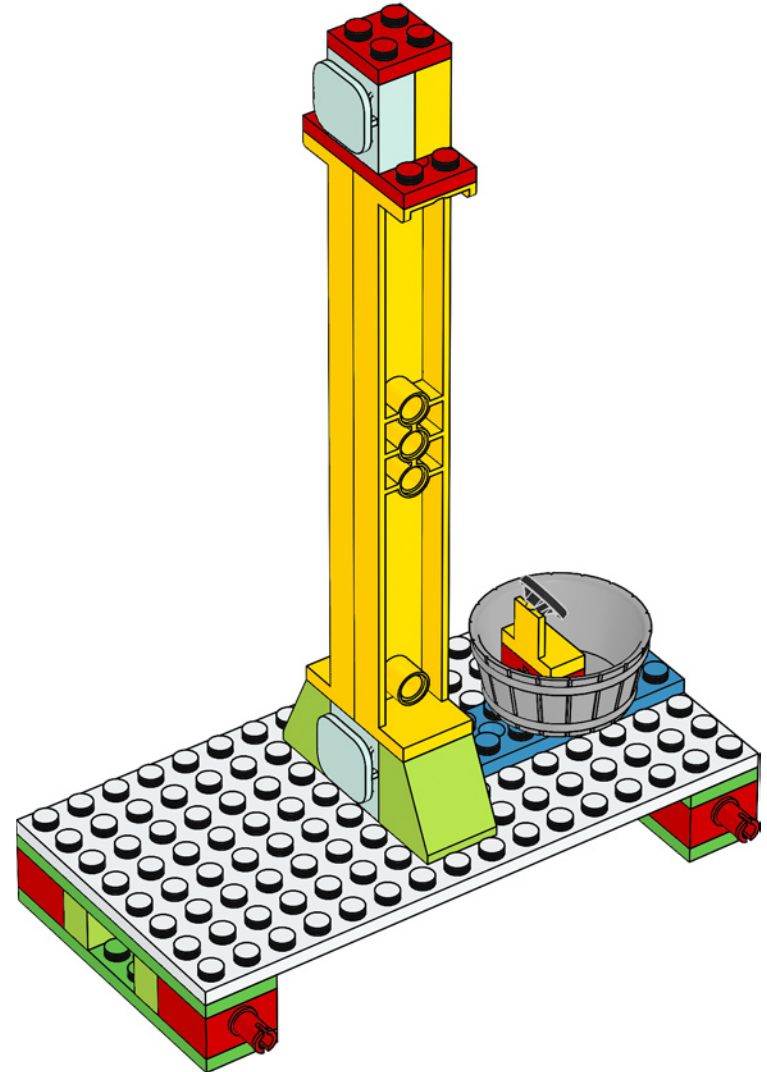

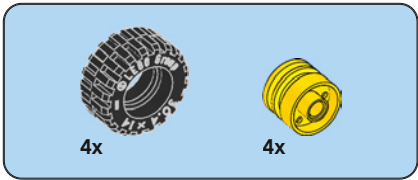

16

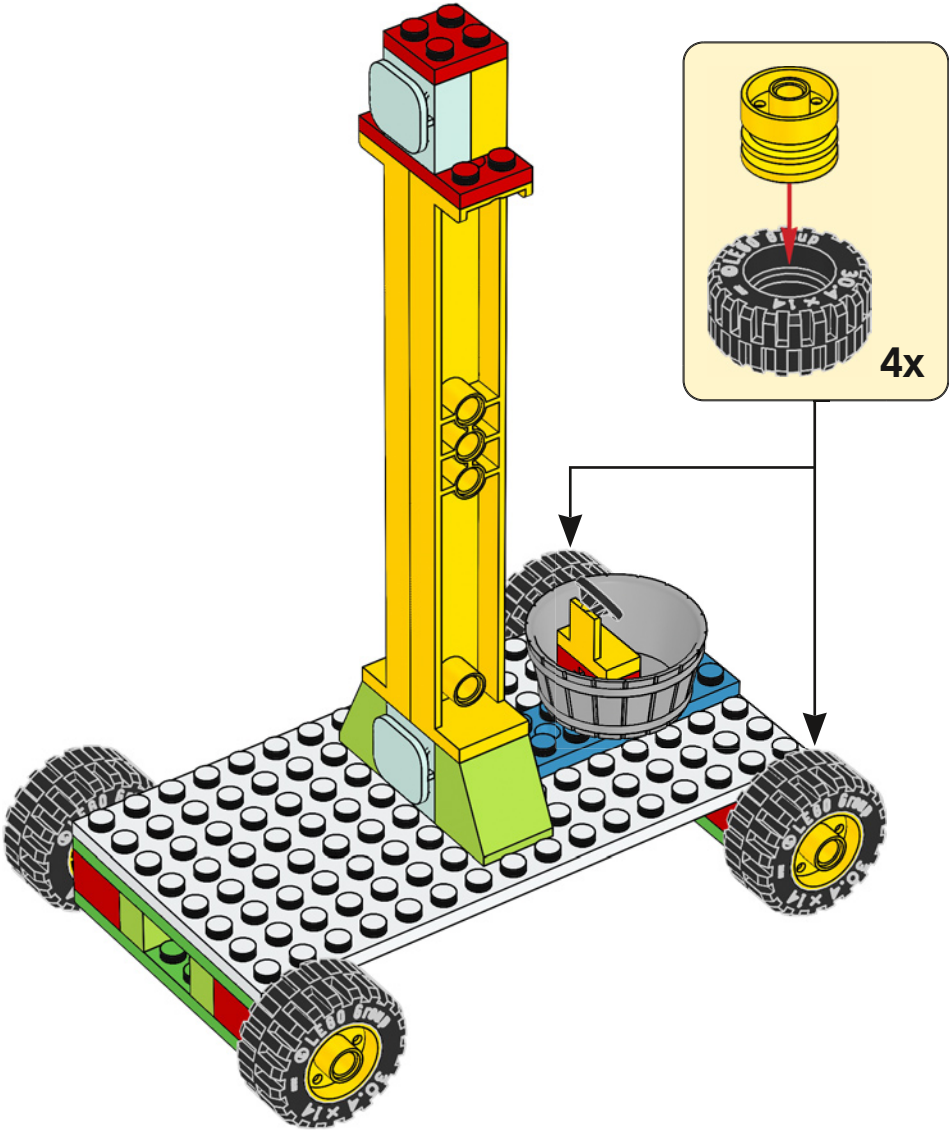

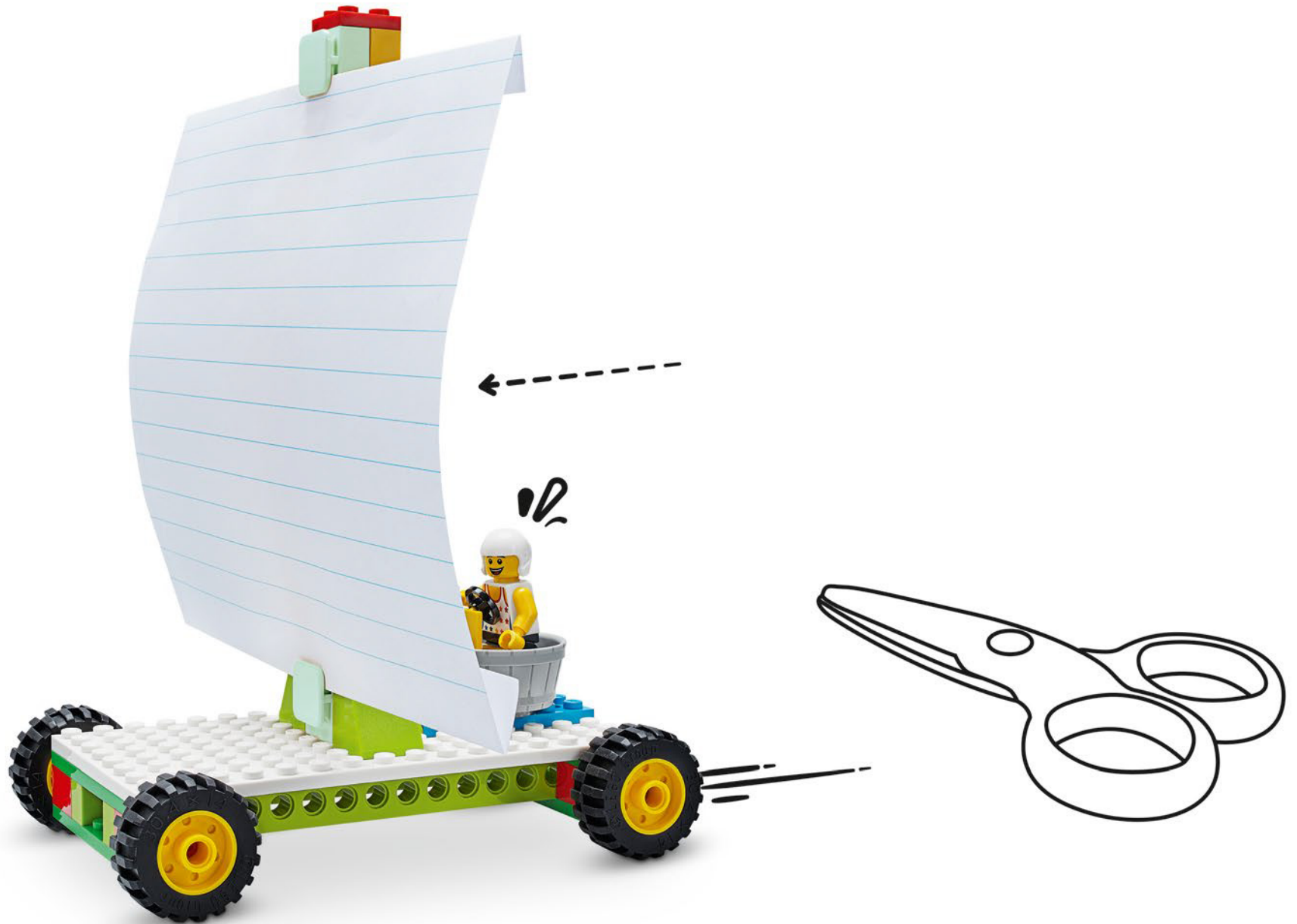

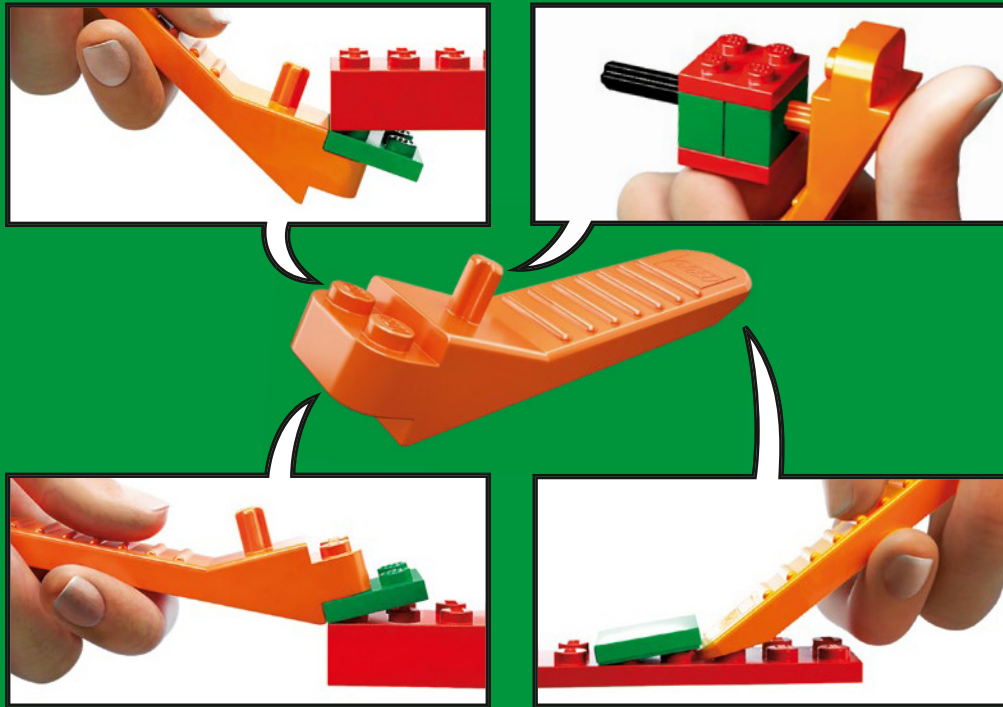

LEGO.com/brickseparator



4



20



40



68



88

45401 - B

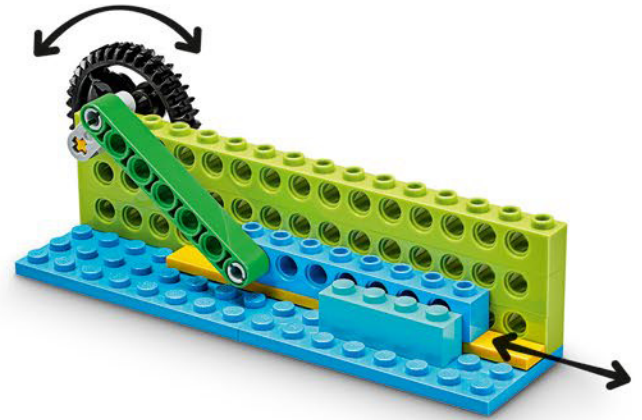
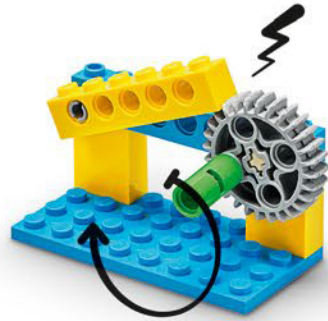
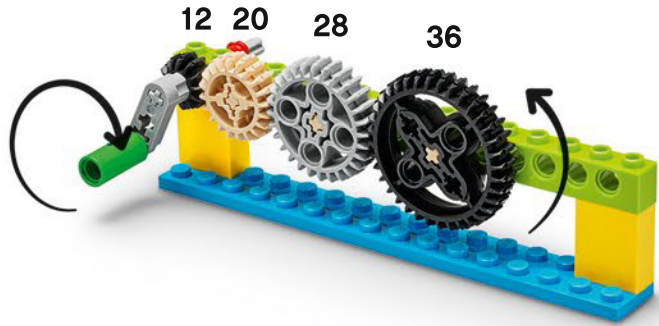

5:9

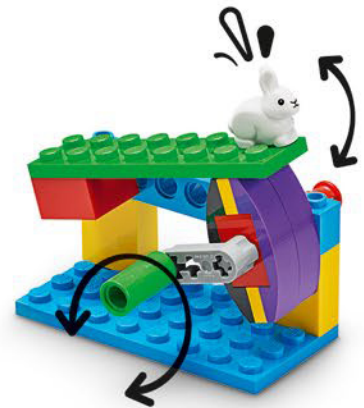
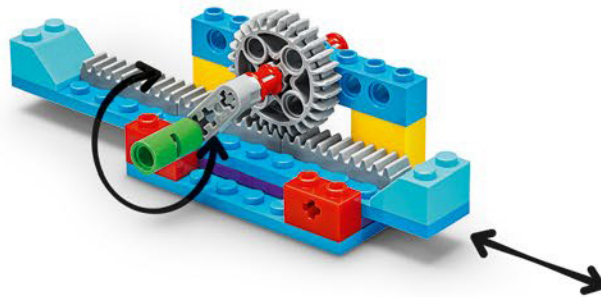

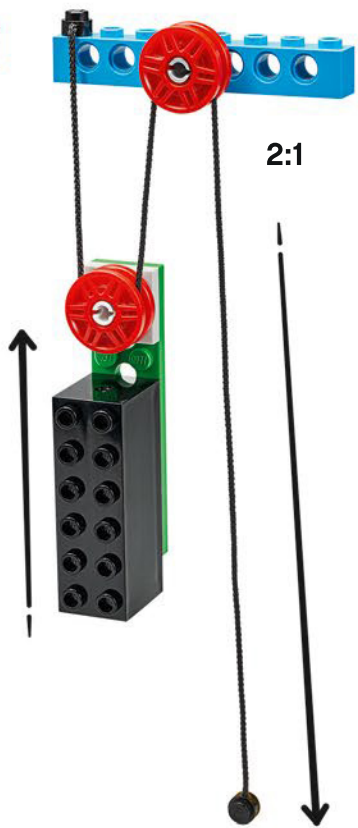
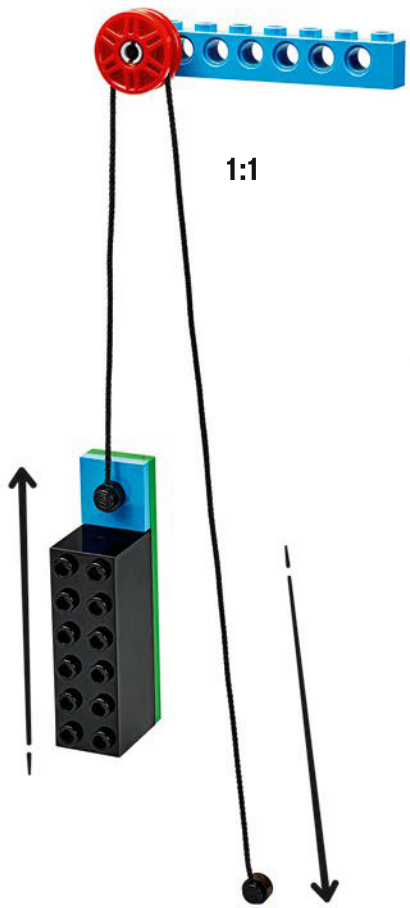
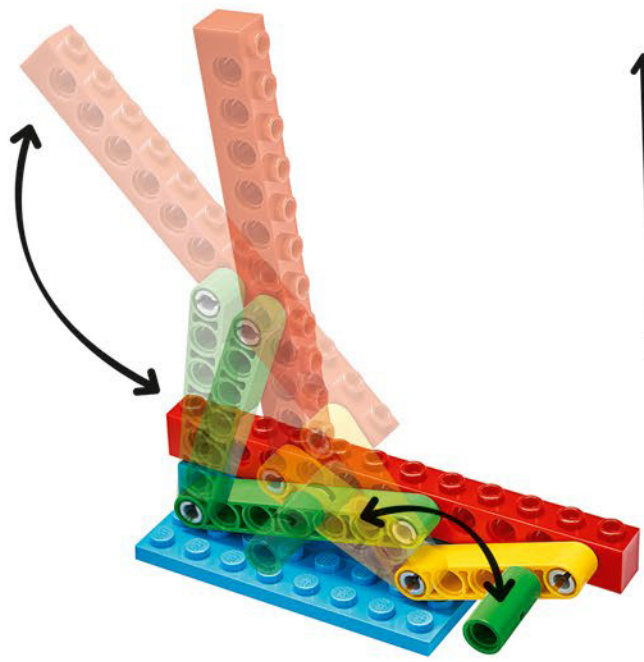
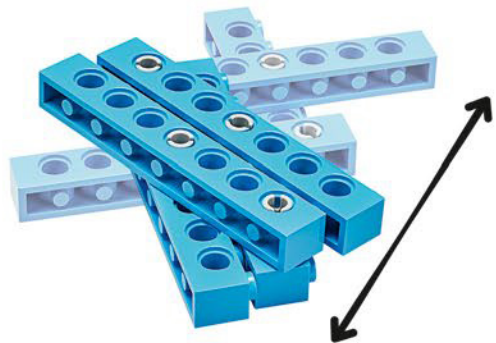

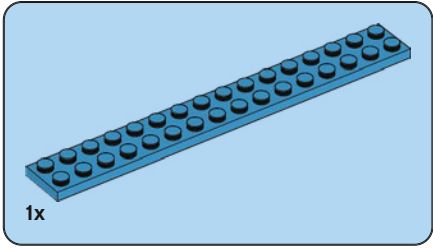
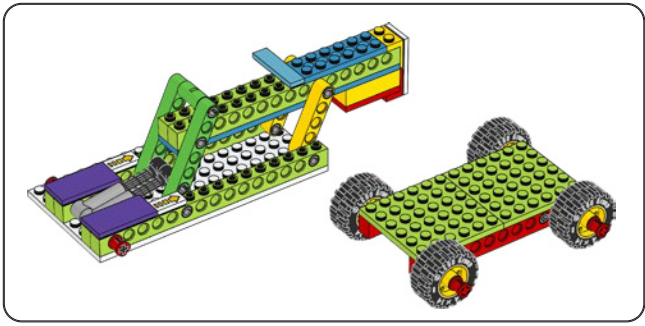

1

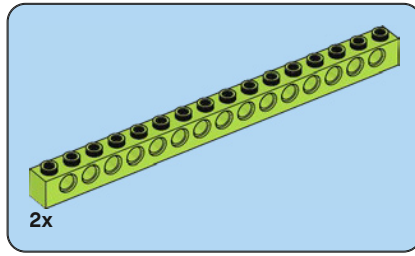
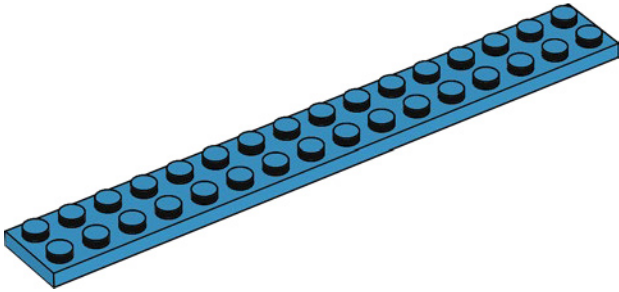

2

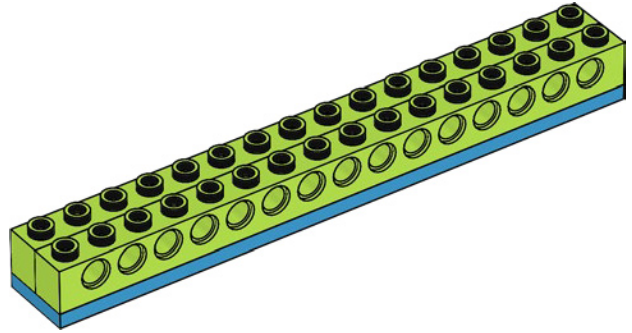

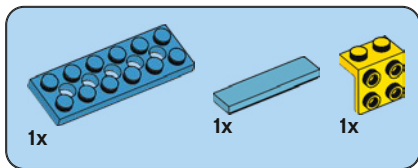

3

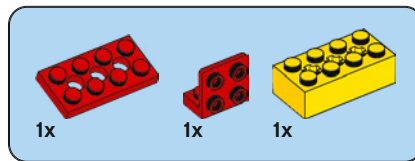
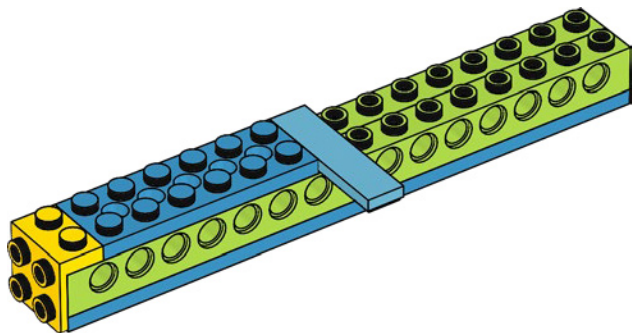

4

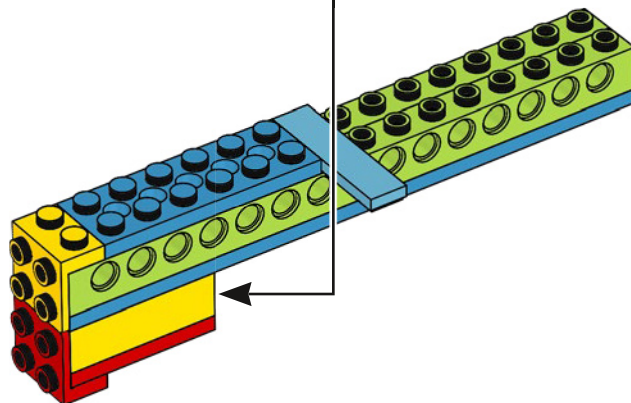
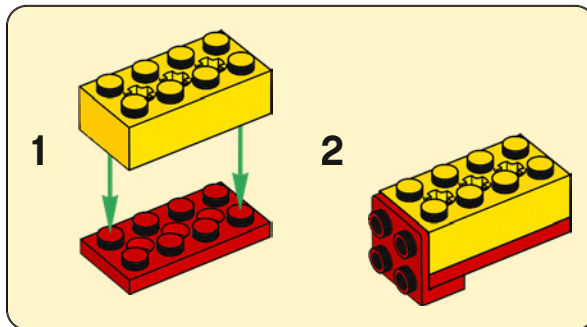

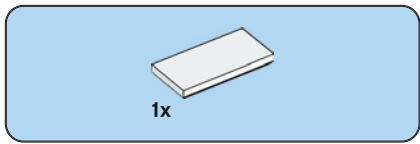

5

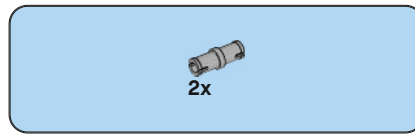
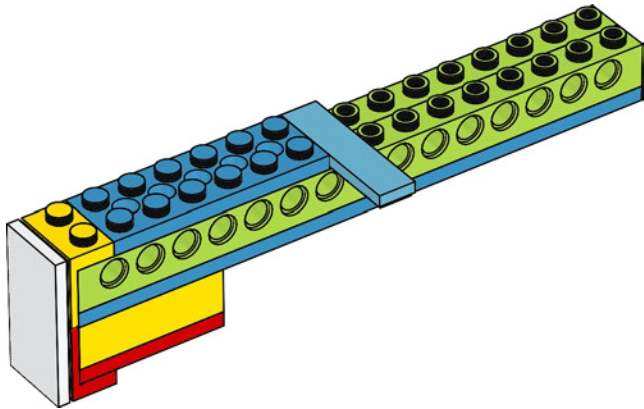

6

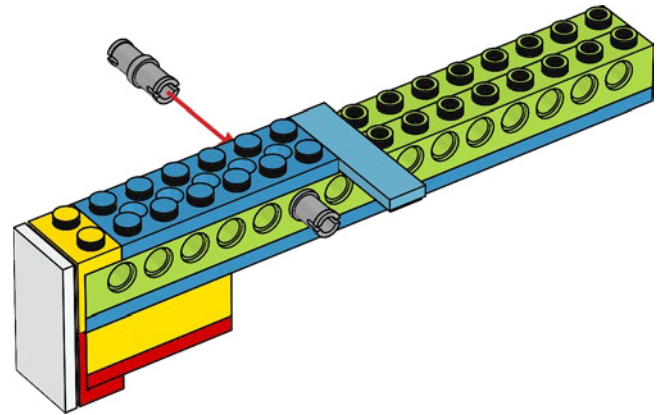

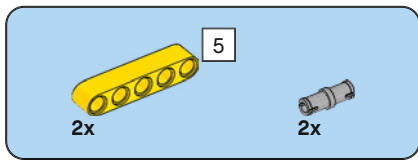

7

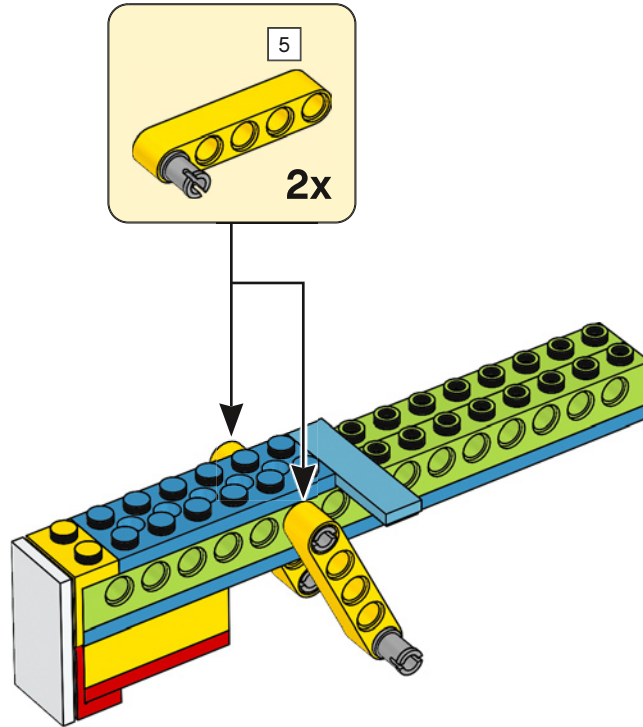

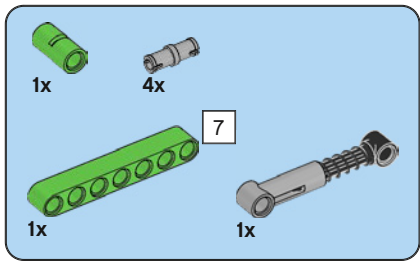

8

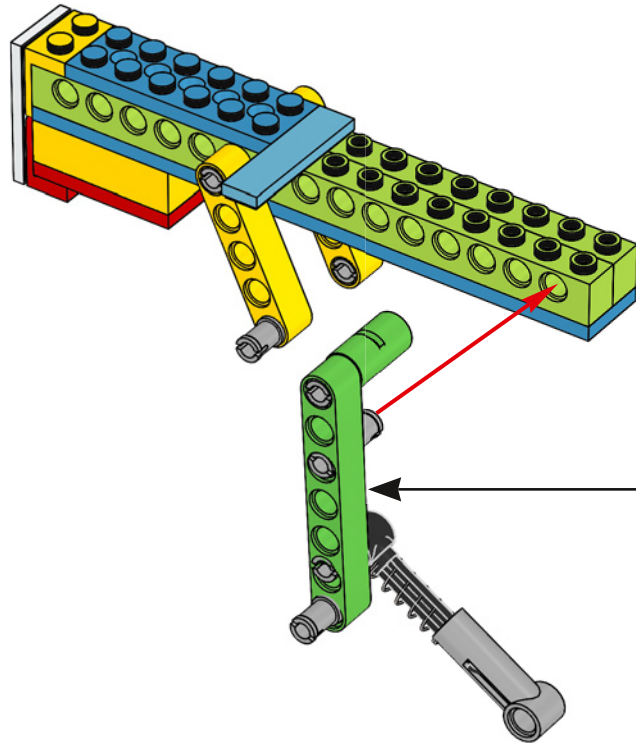
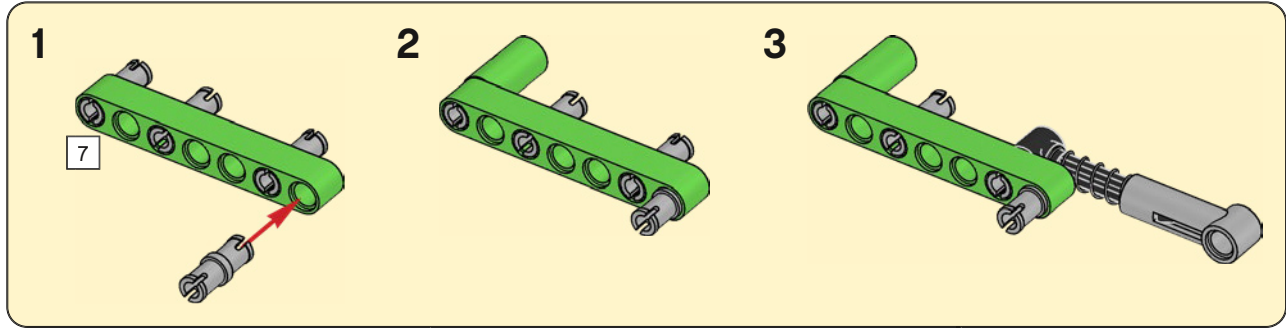

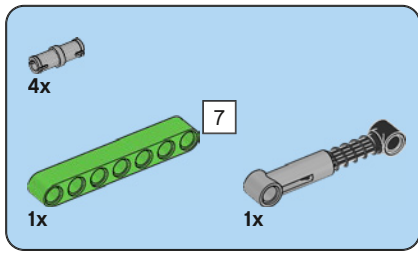

9

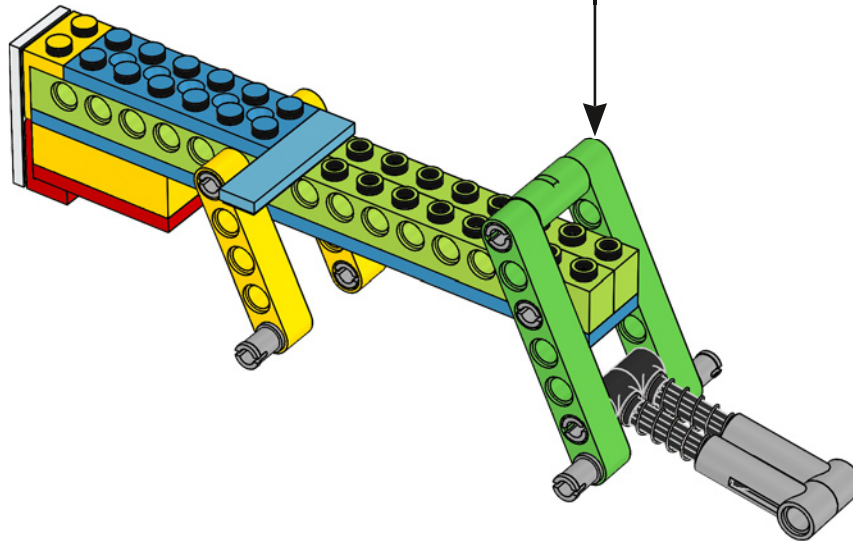
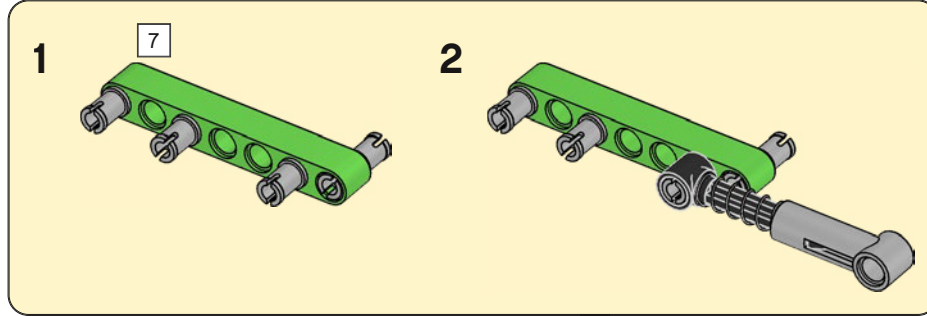

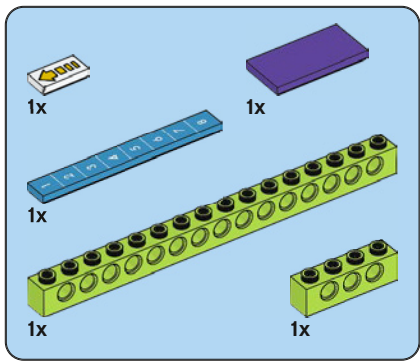

10

1

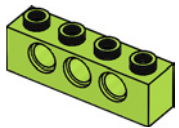

2

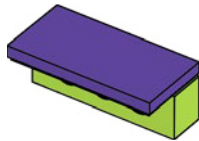

3

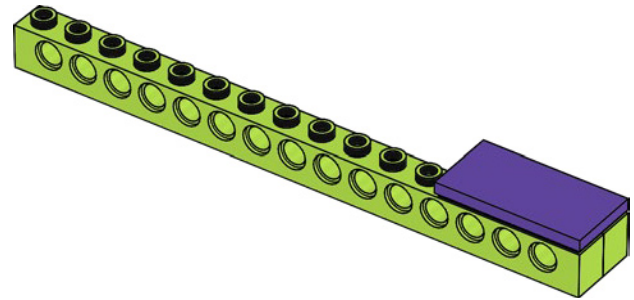

4

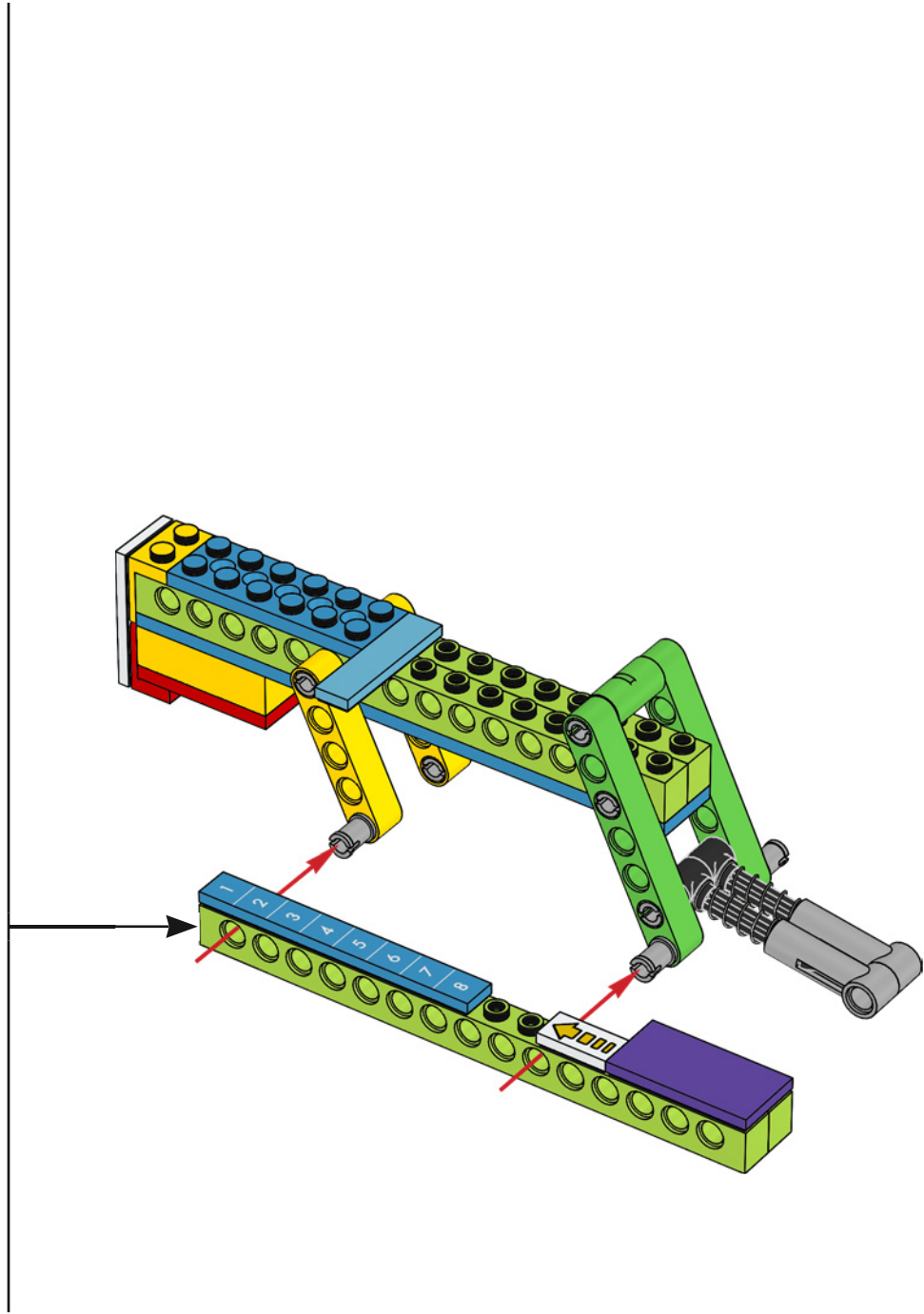
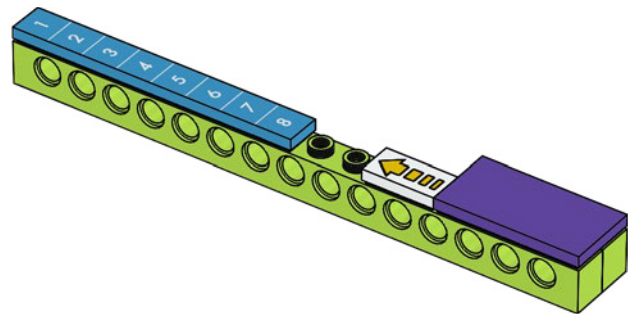

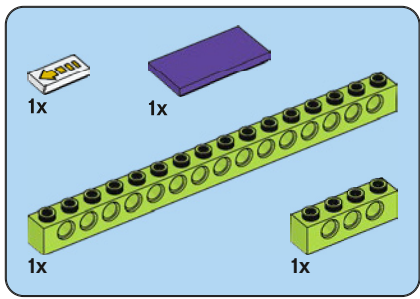

11

1

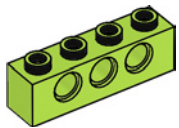

2

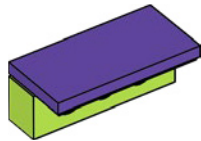

3

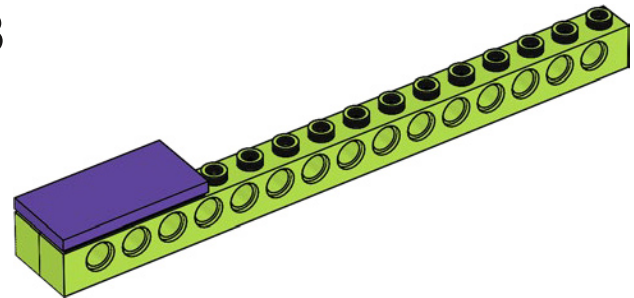

4

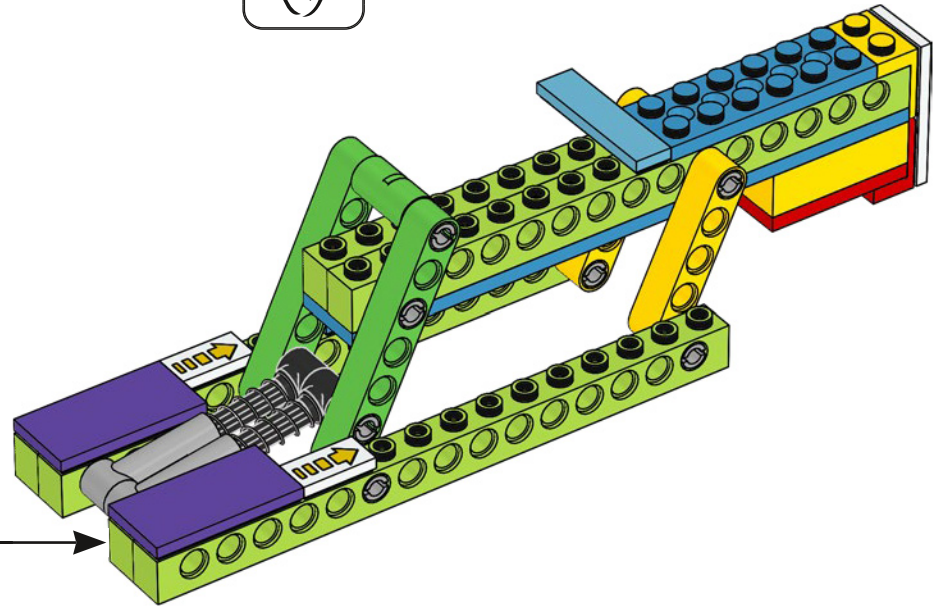
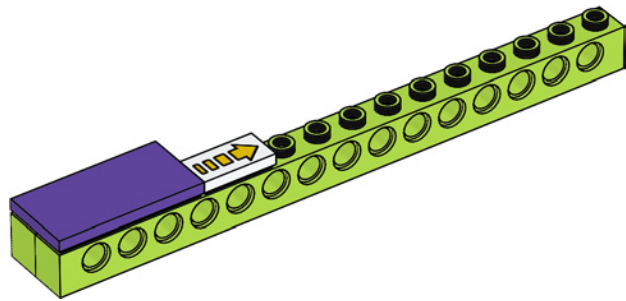

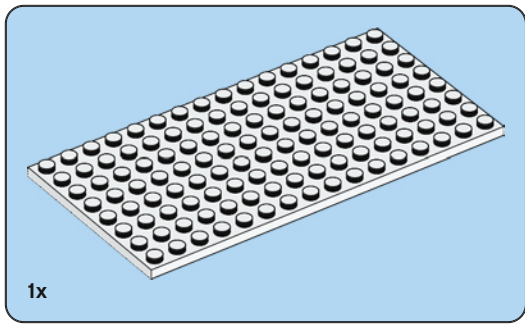

12

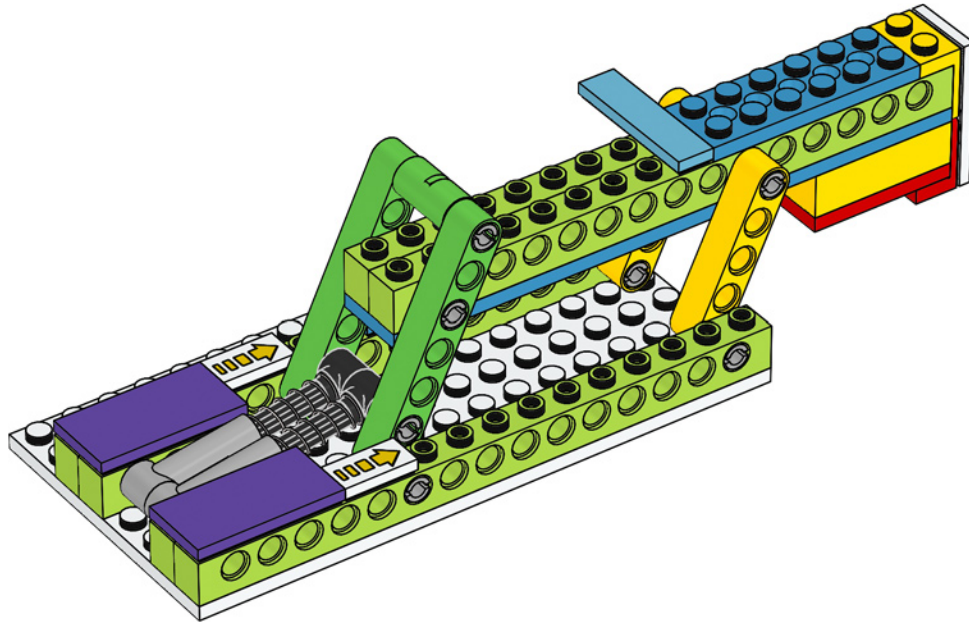

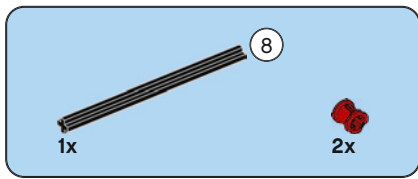

13

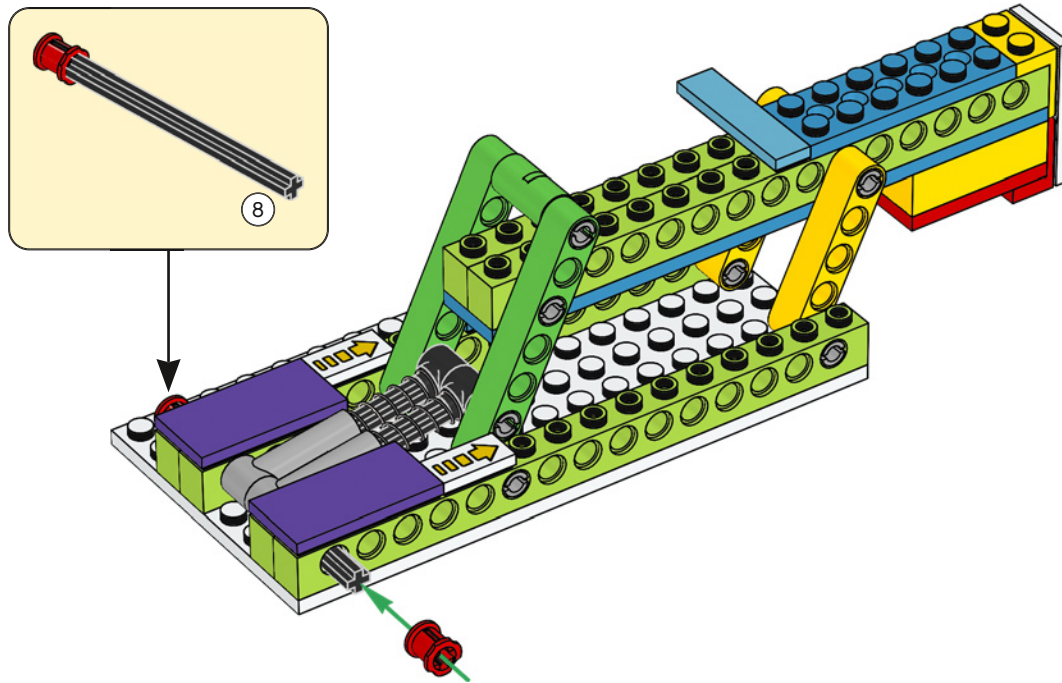

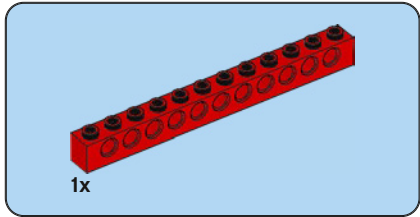
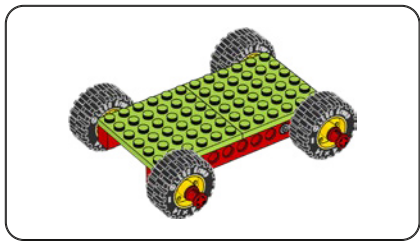

14

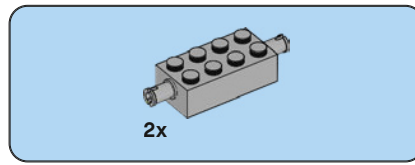
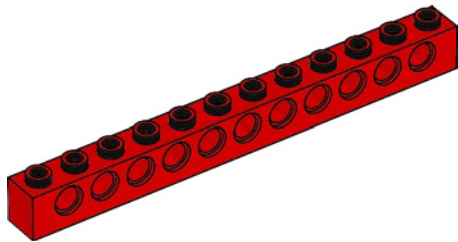

15

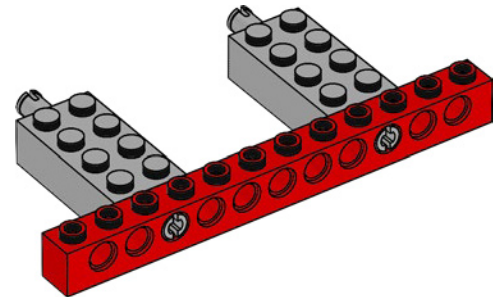

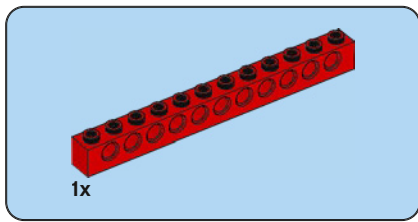

16

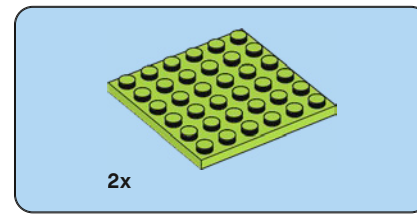
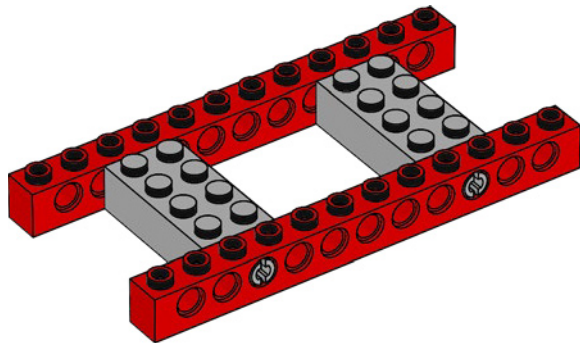

17

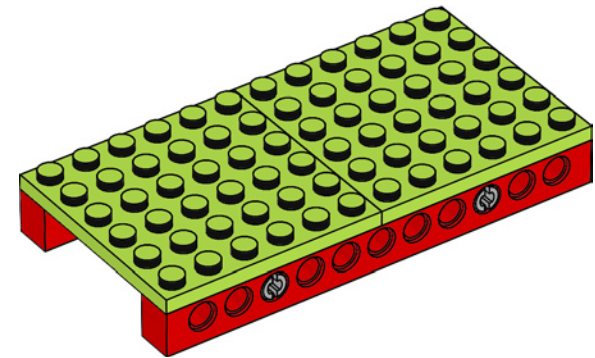

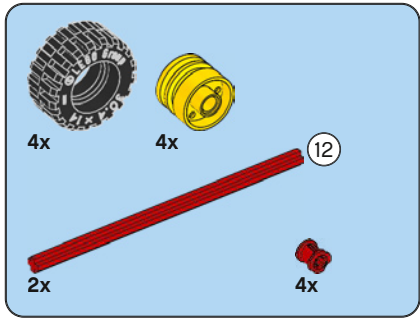

18

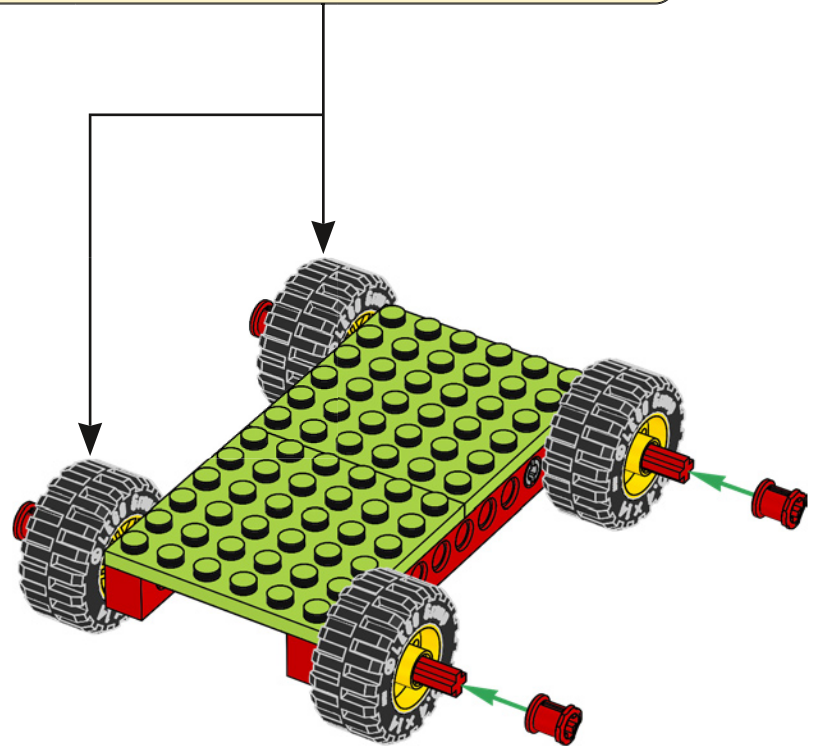
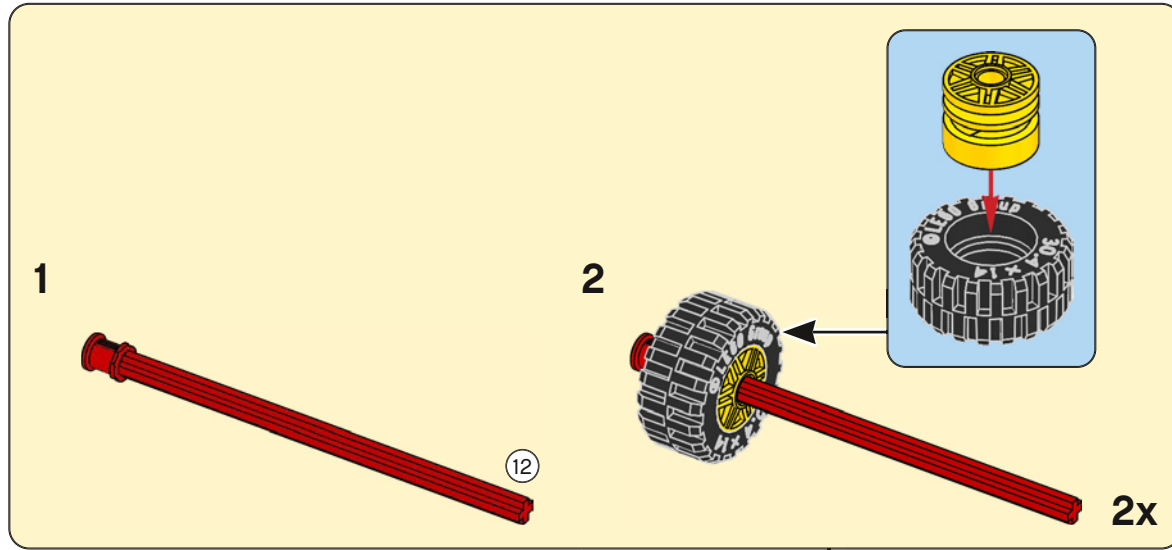

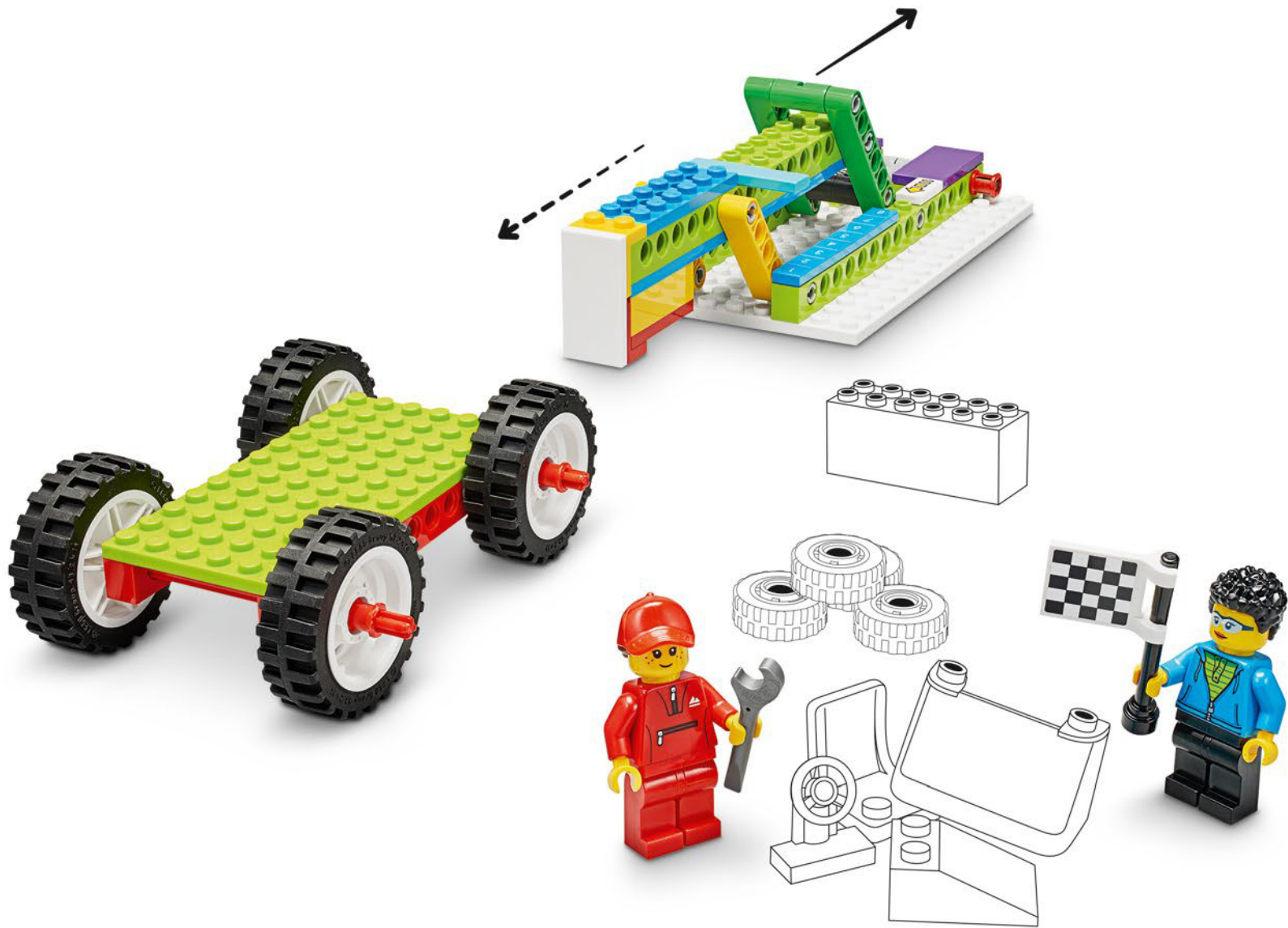

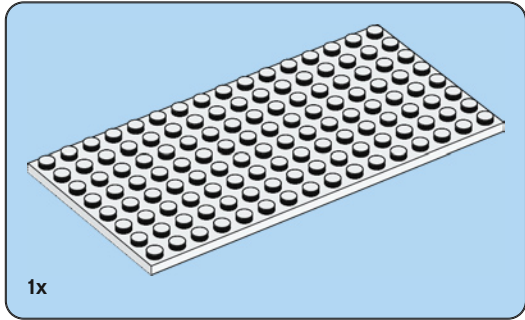
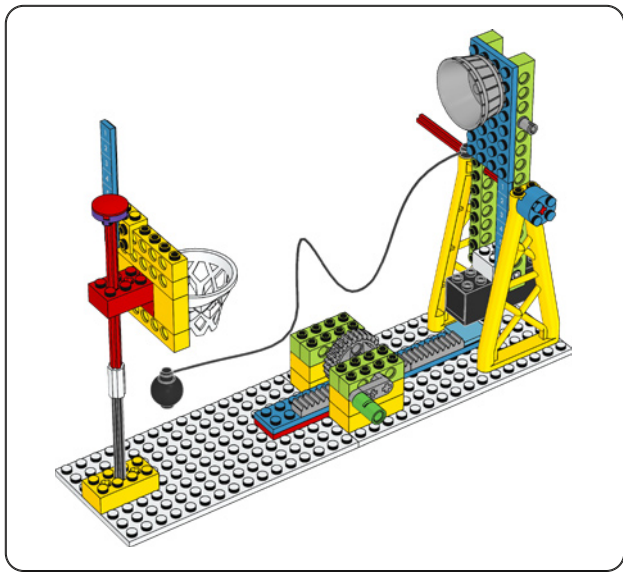

1

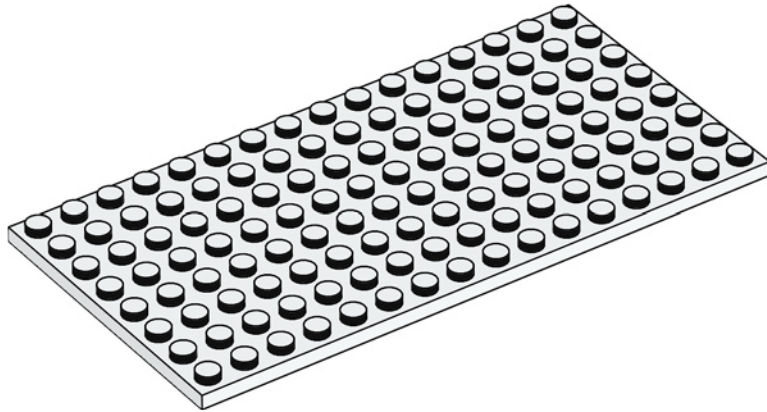

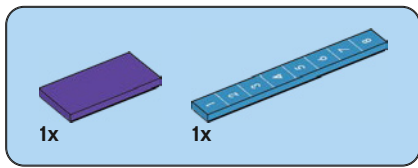

2

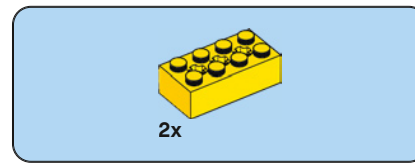
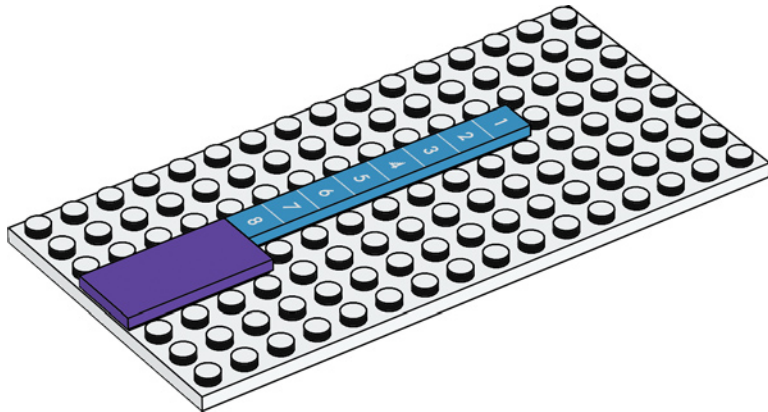

3

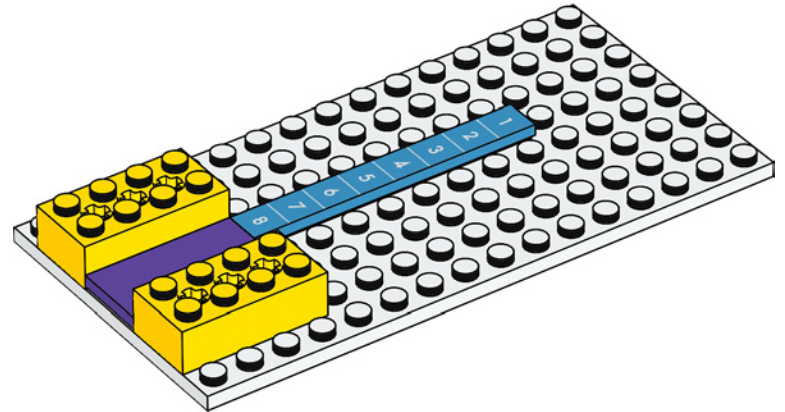

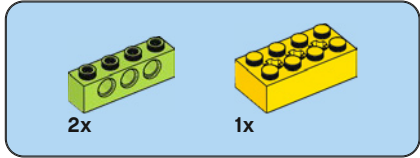
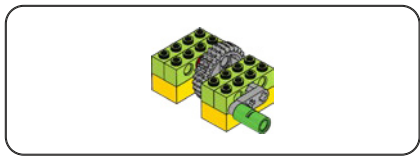

4

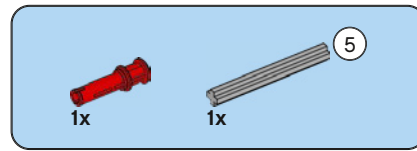
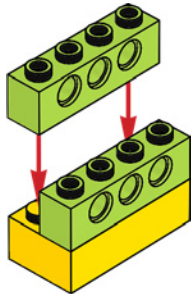

5

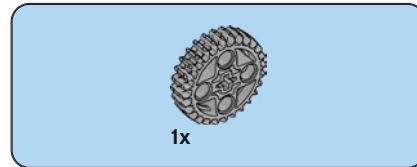
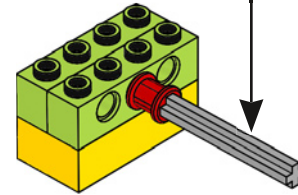
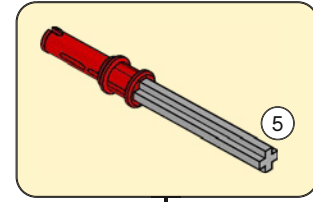

6

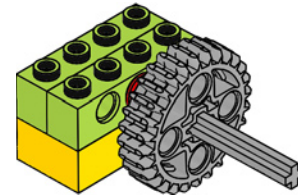

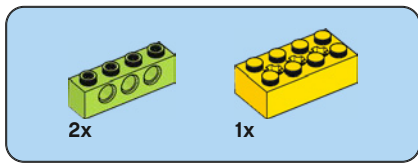

7

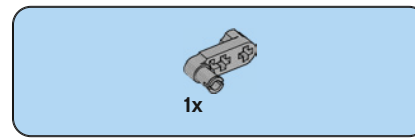
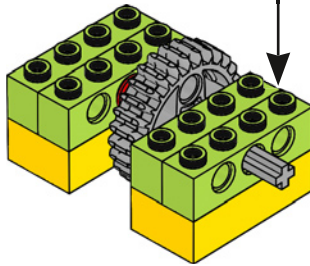
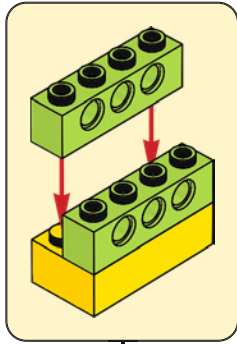

8

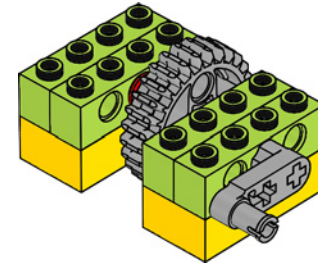

9

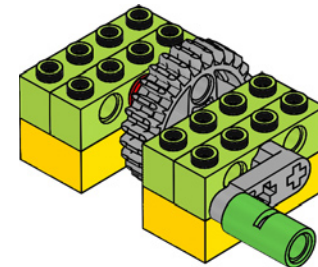

10

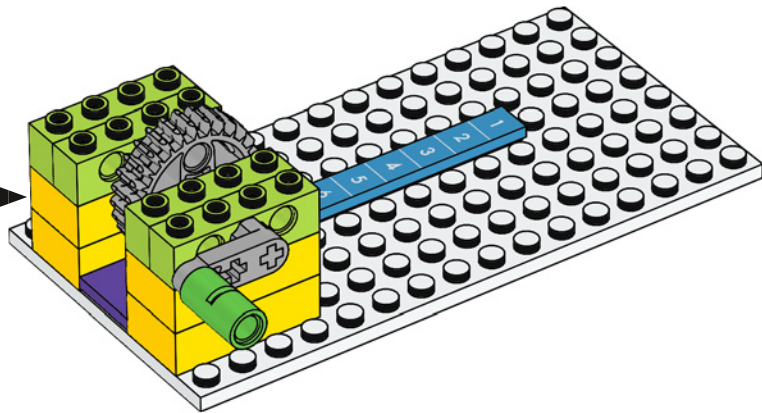

11

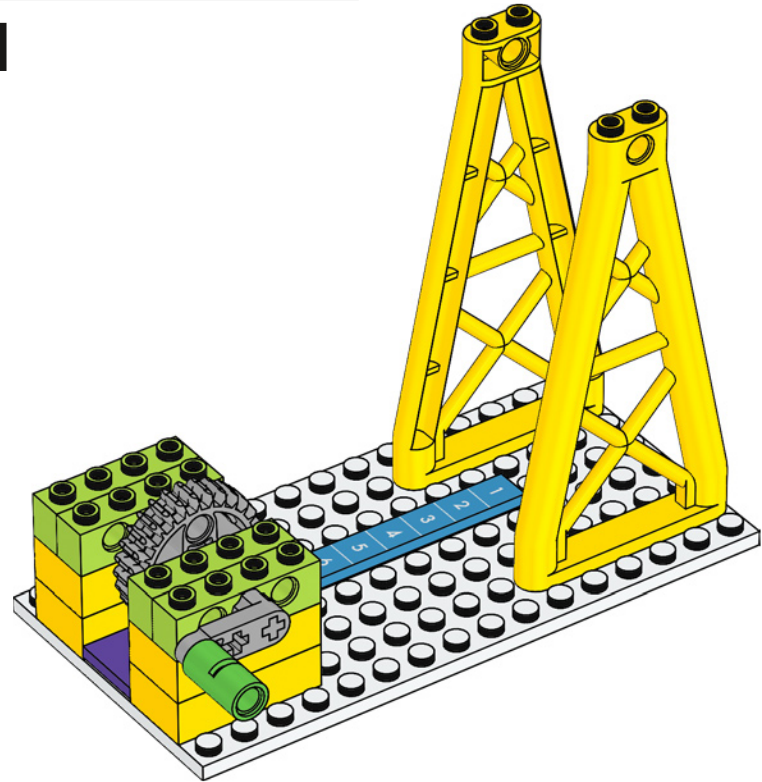
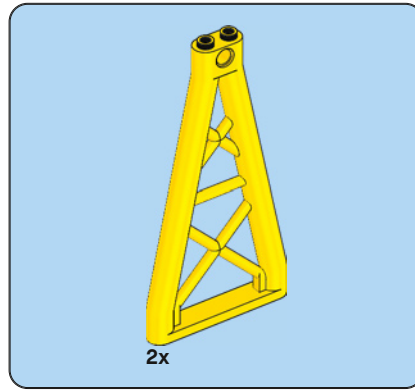

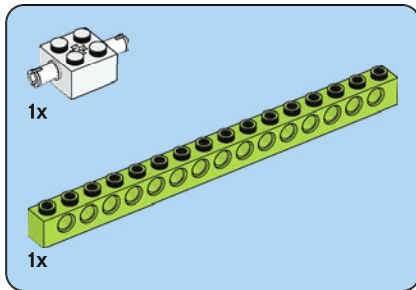
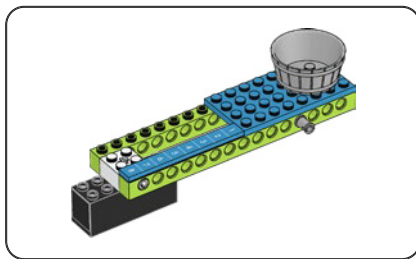

12

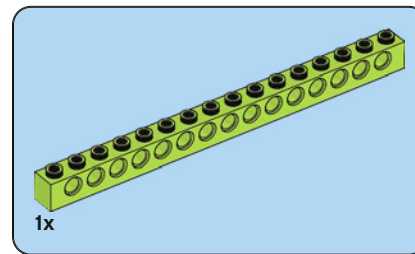
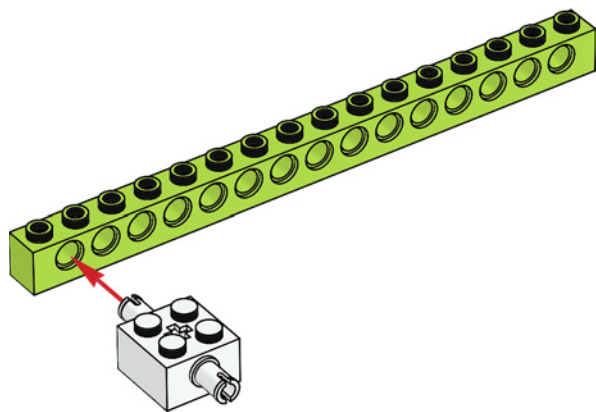

13

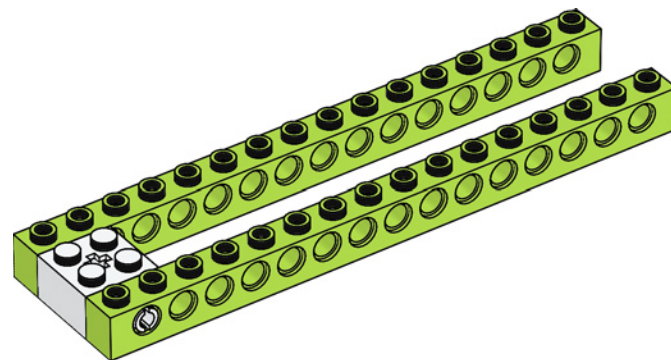

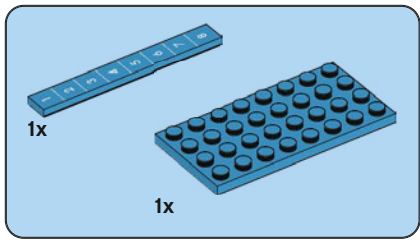

14

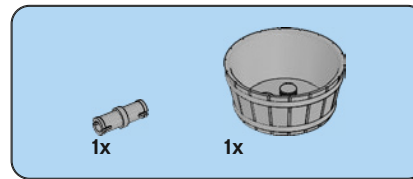
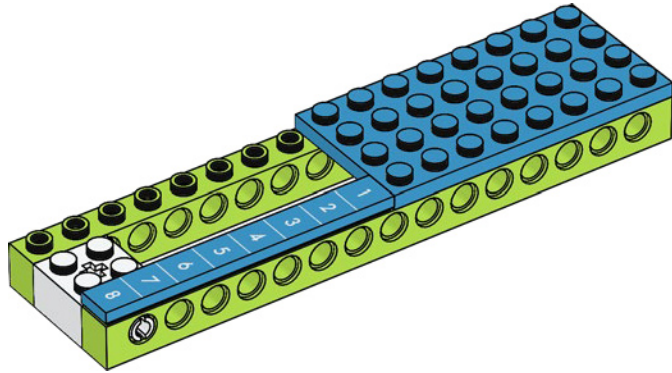

15

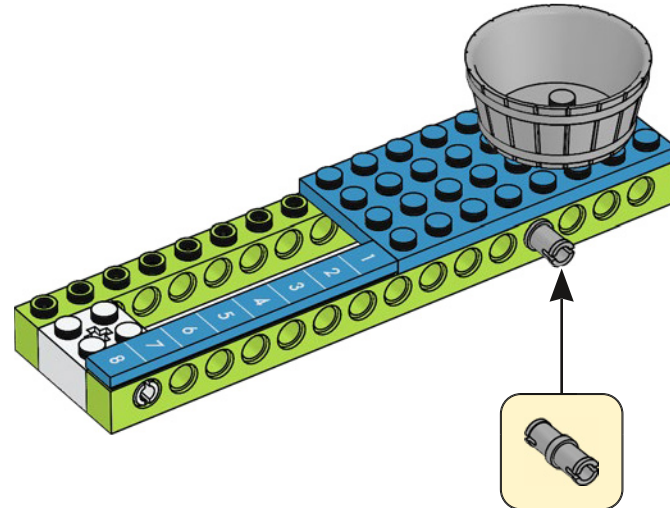

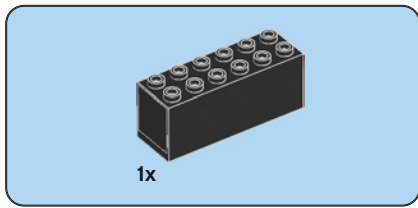

16

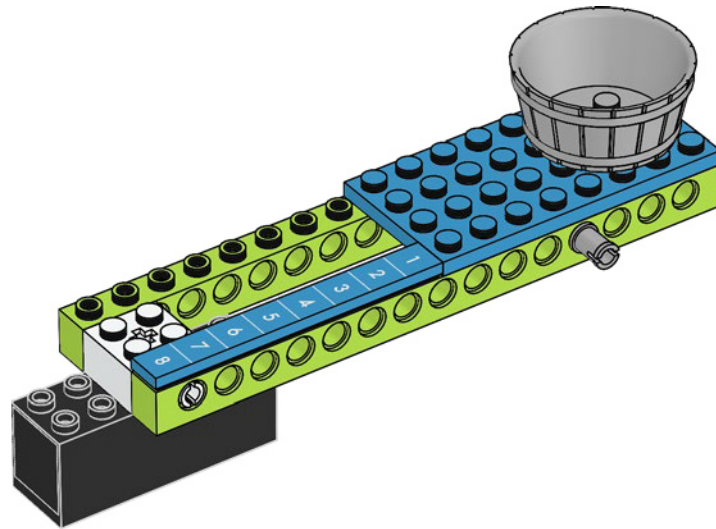

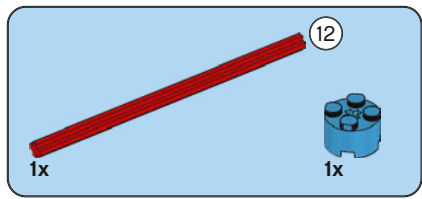

17

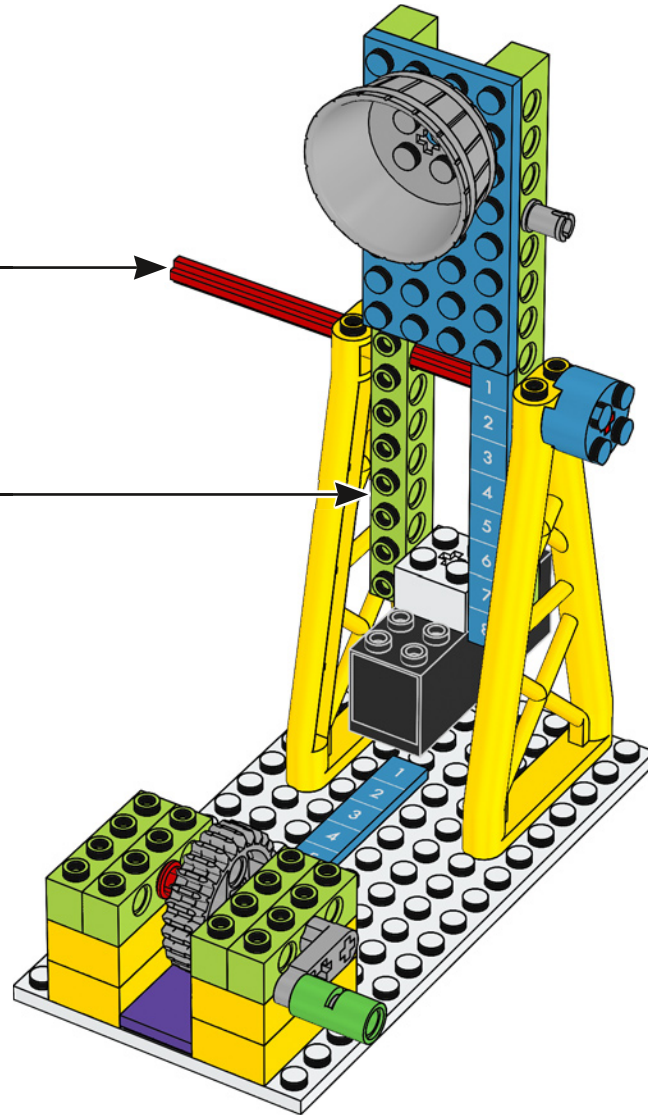
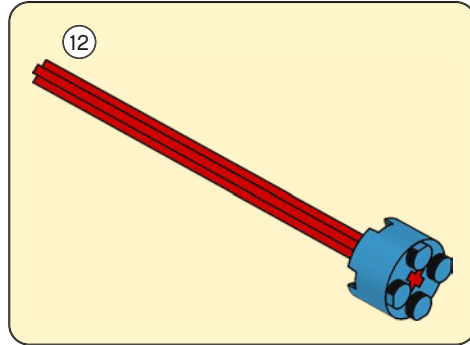

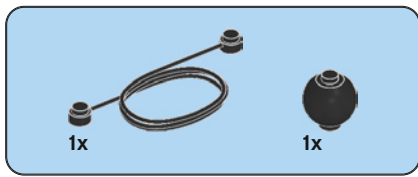

18

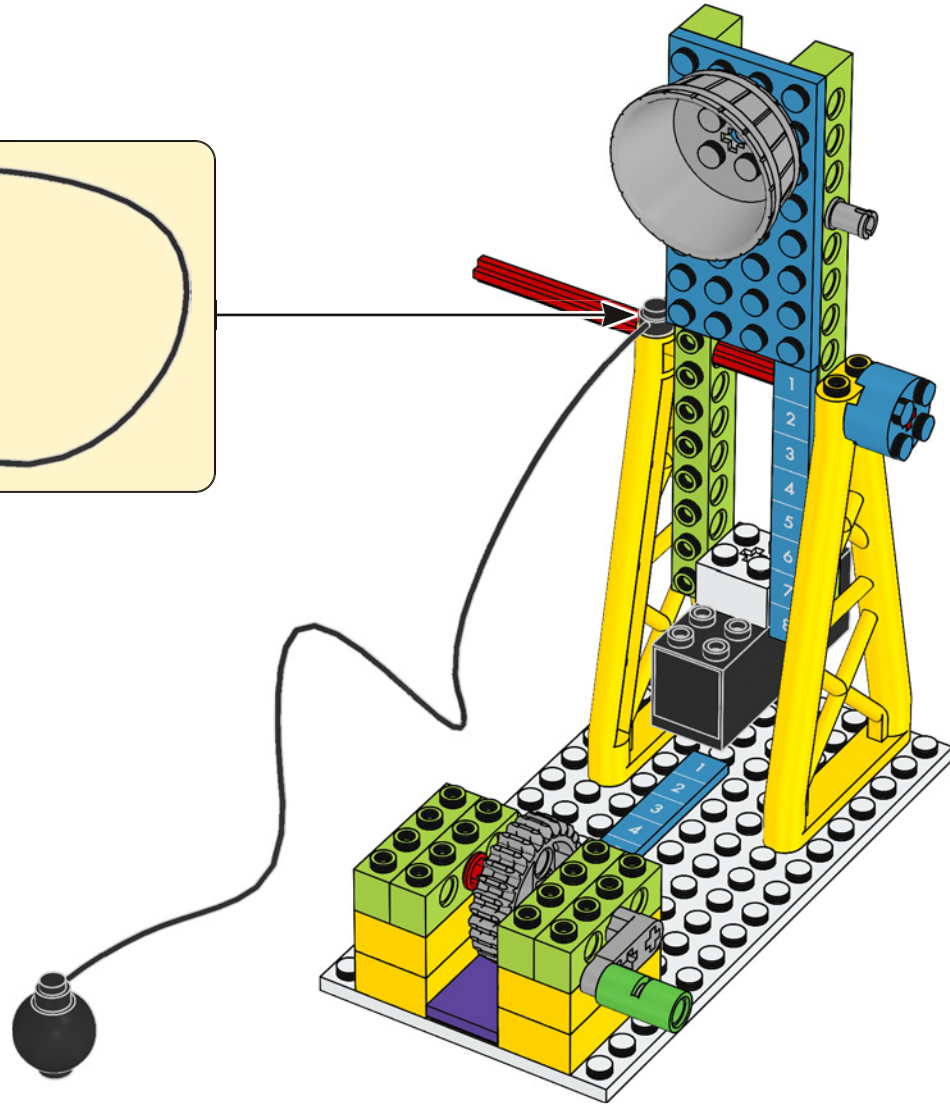
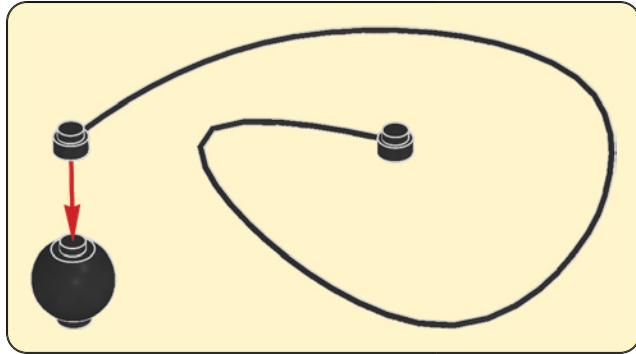

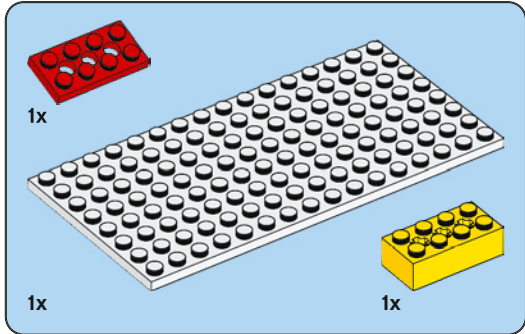
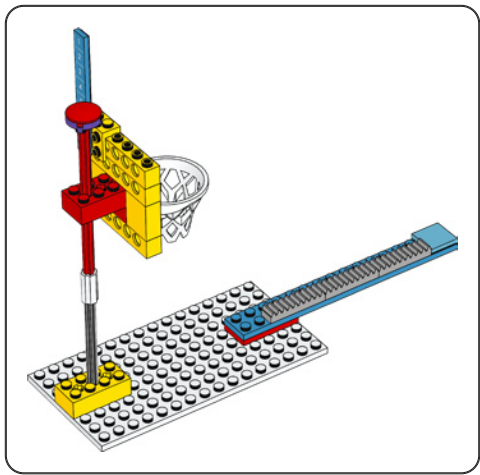

19

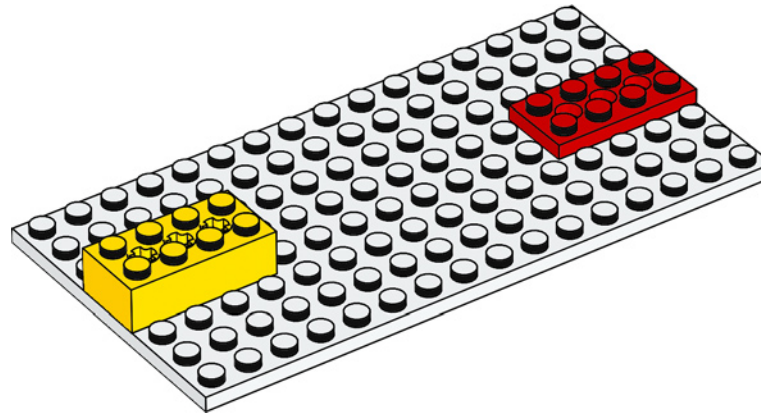

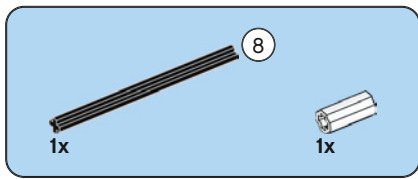

20

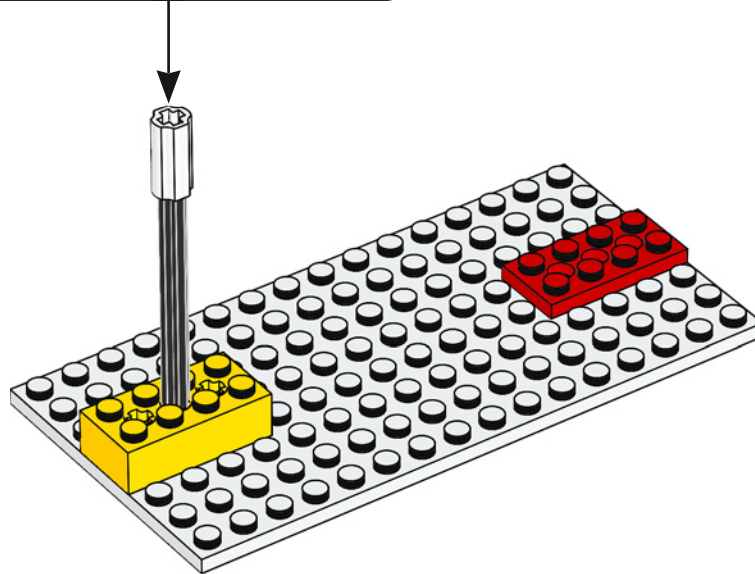
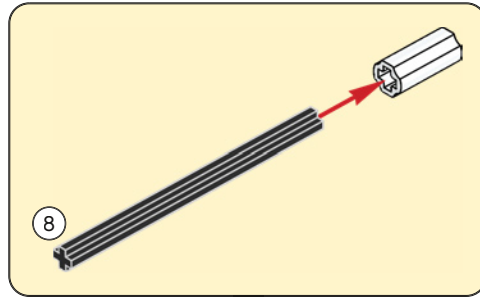

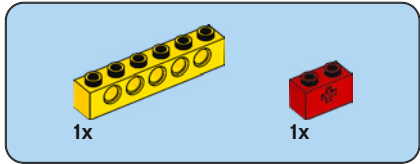
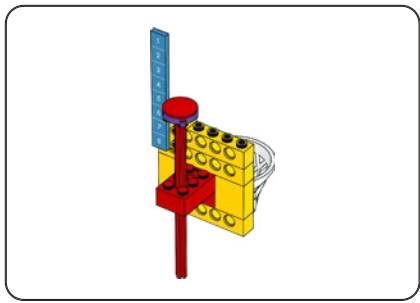

21

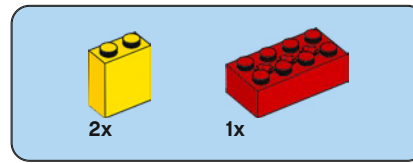
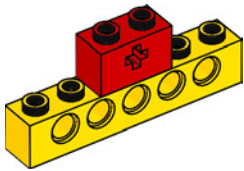

22

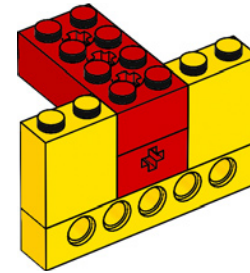

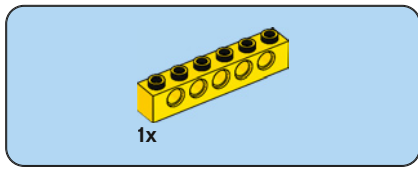

23

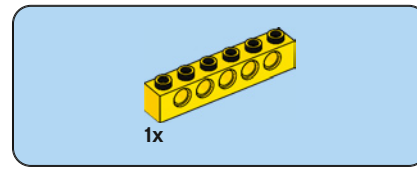
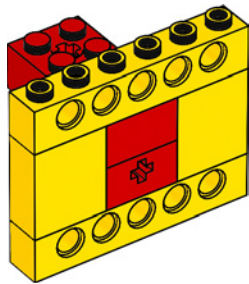

24

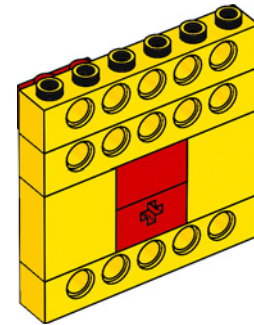



1x

25

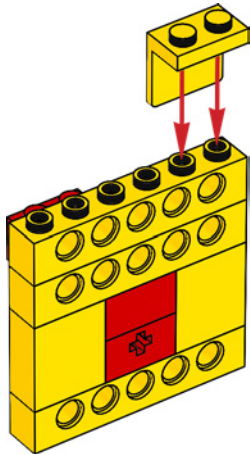

1x

26

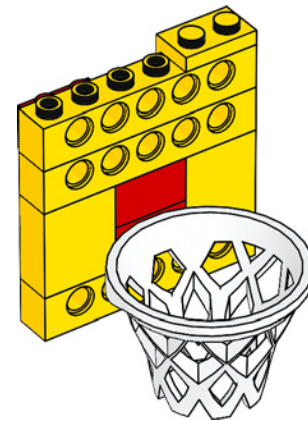

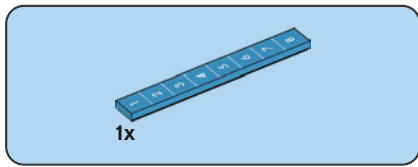

27

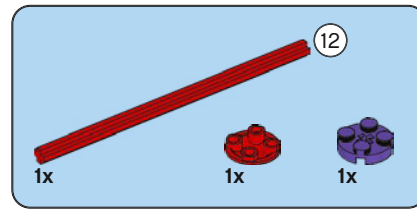
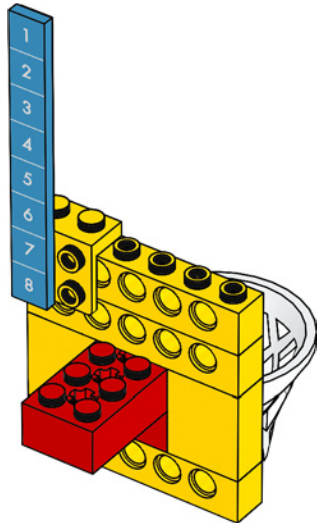

28

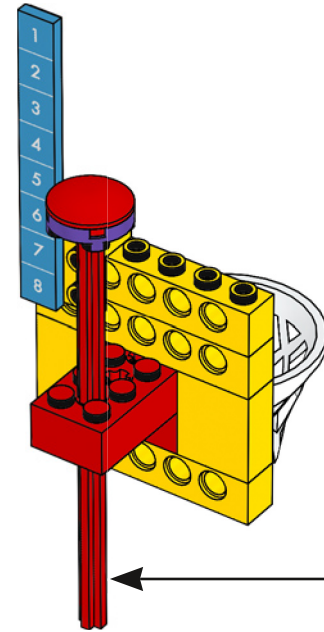
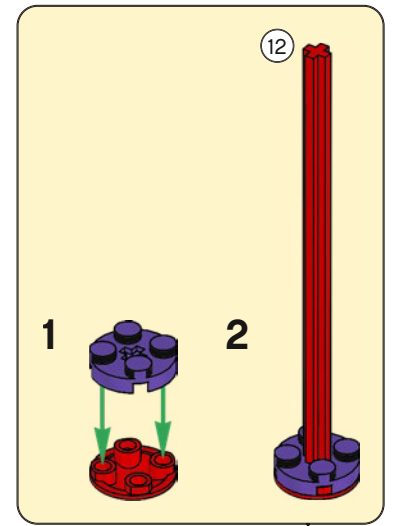

29

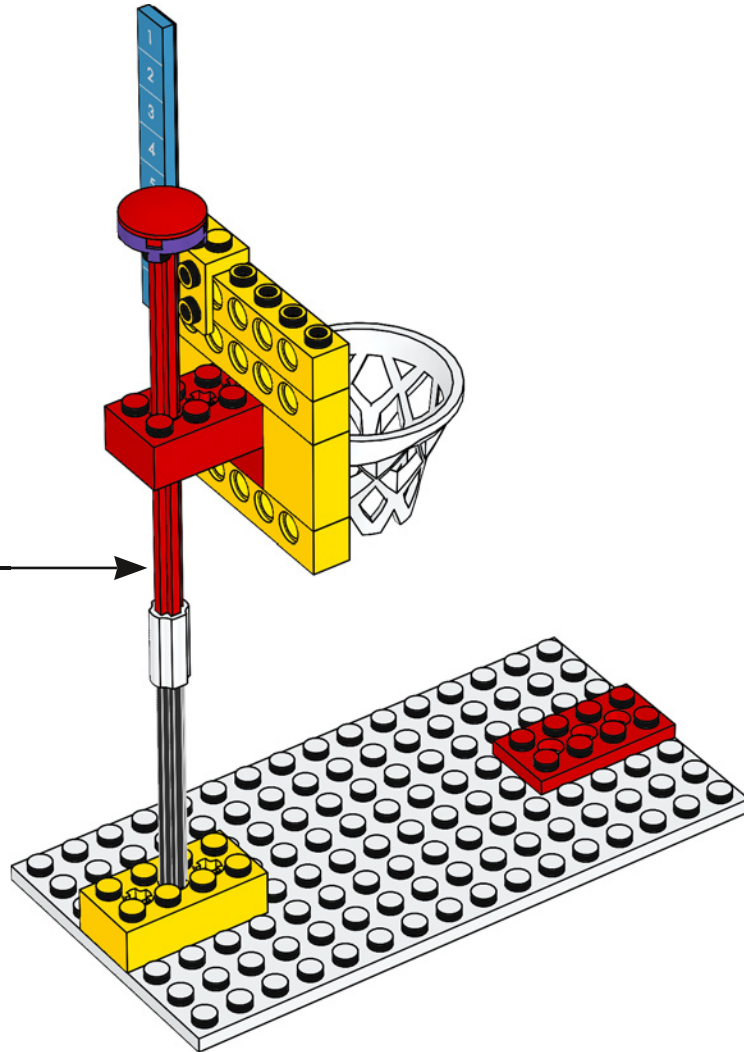

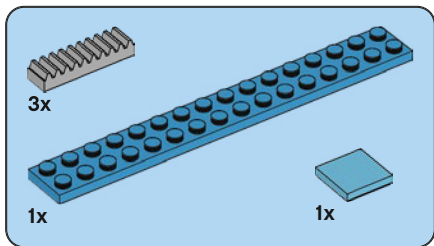

30

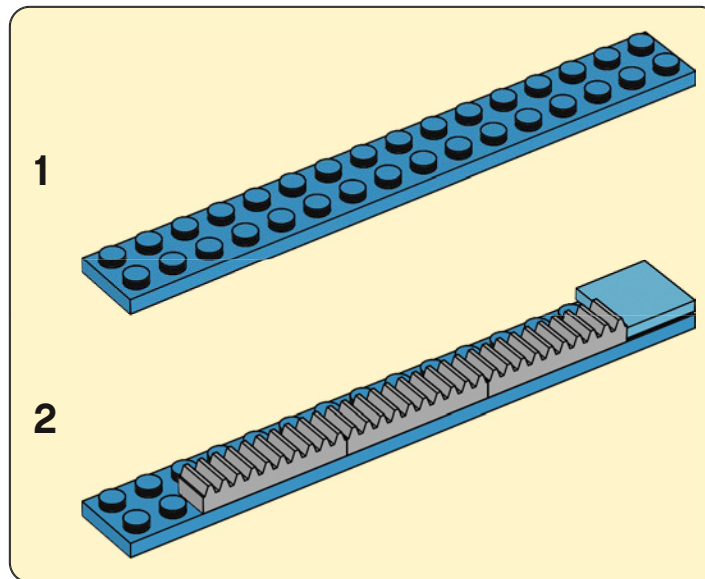
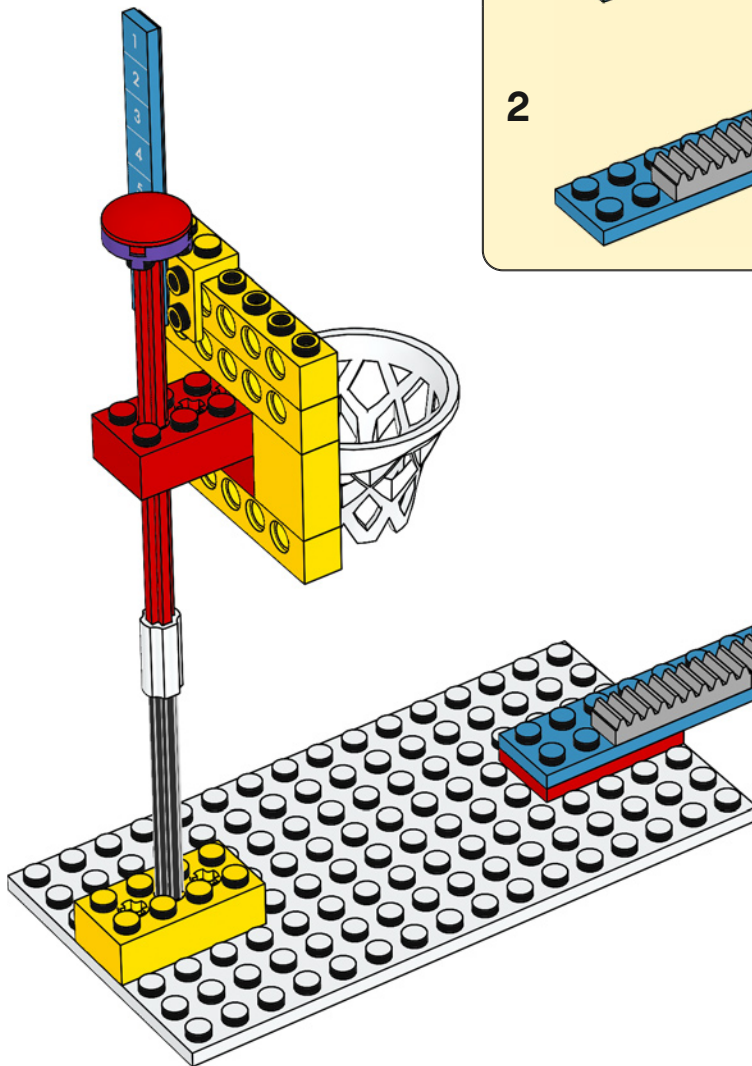

31

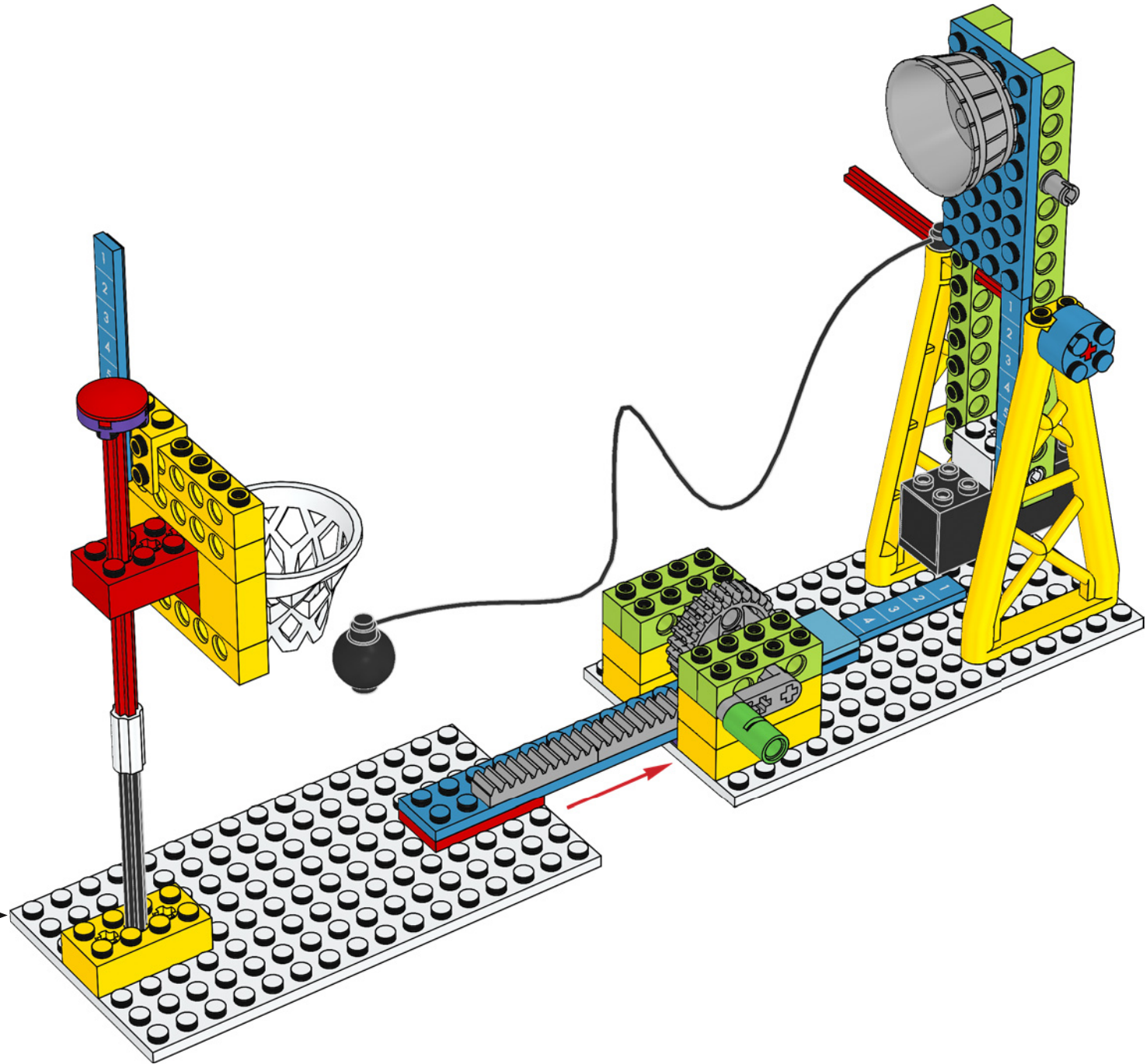

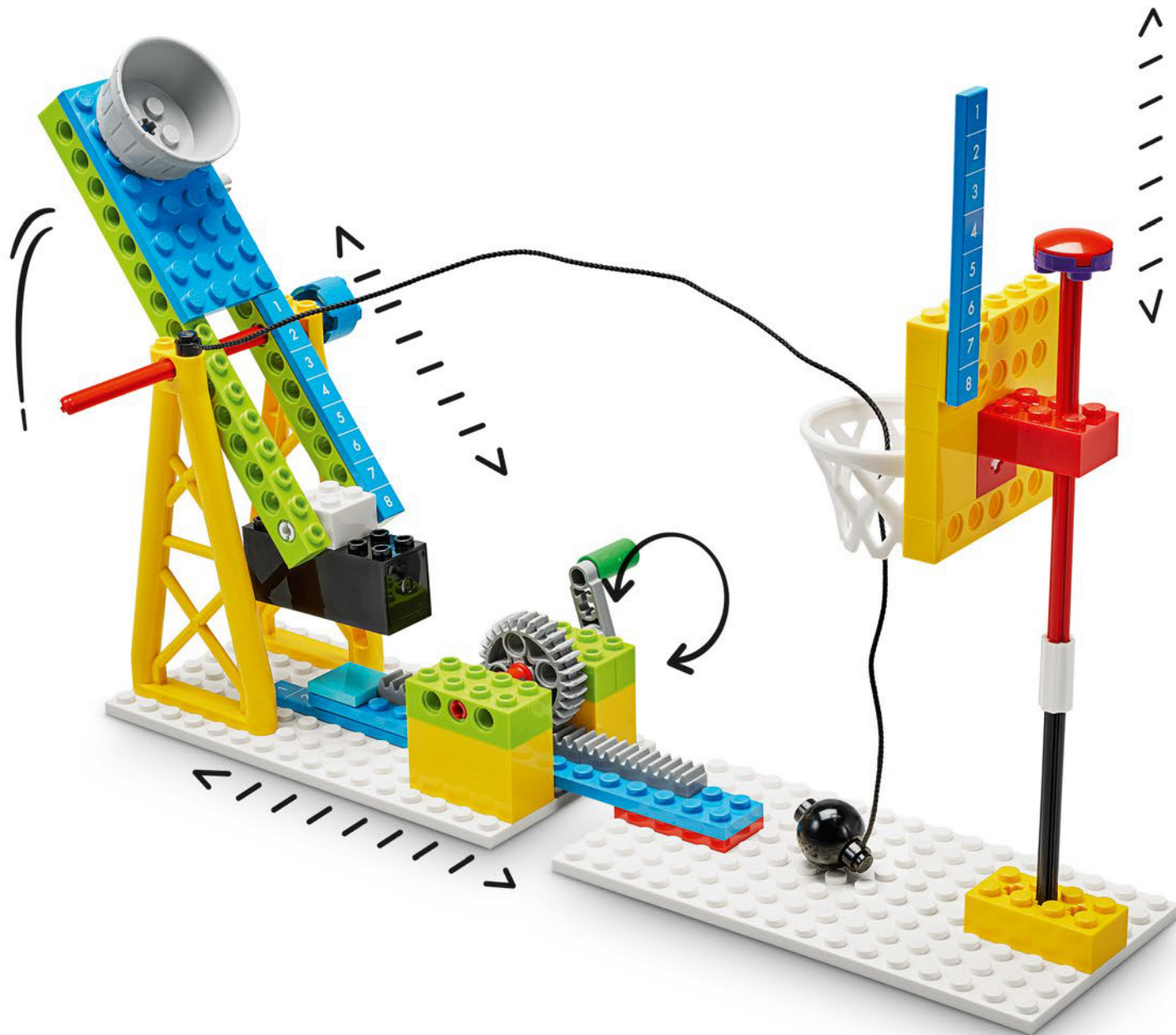

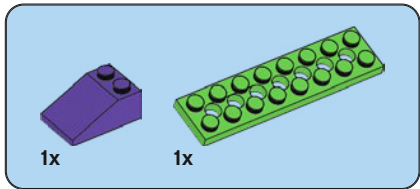
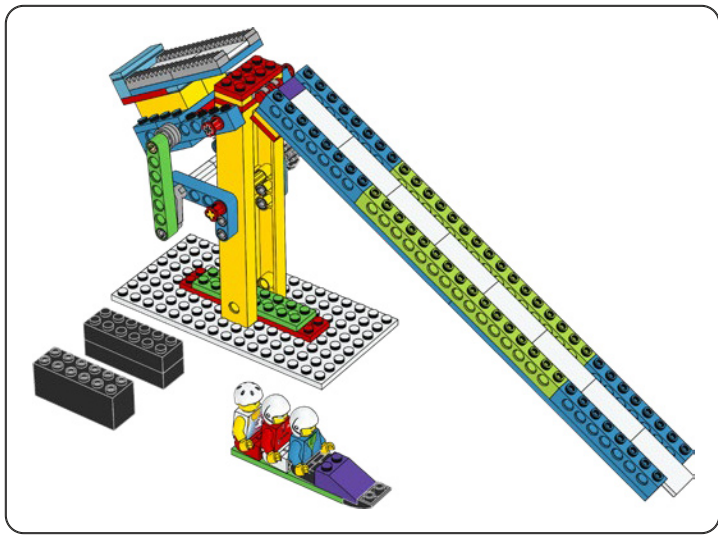

1

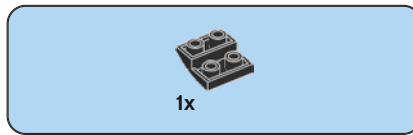
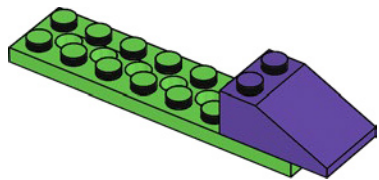

2

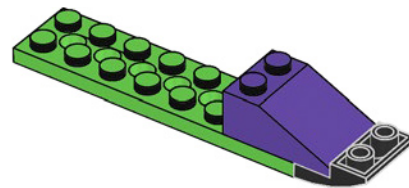

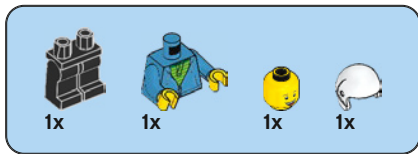

3

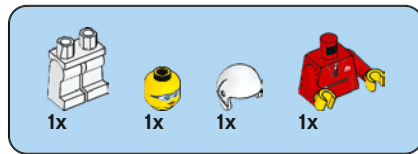
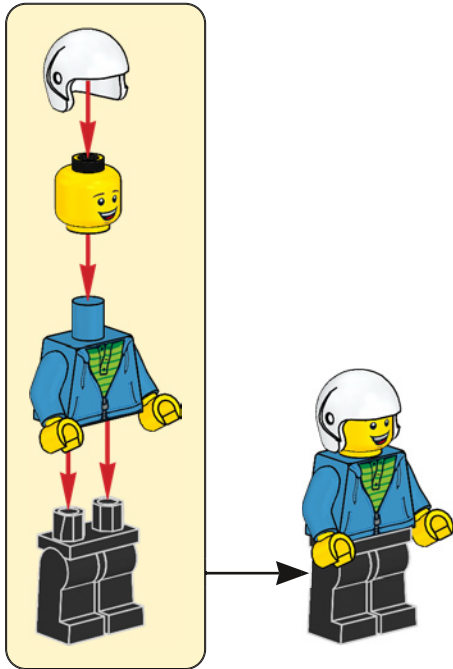

4

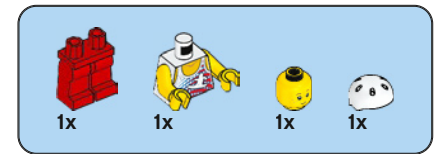

5



6

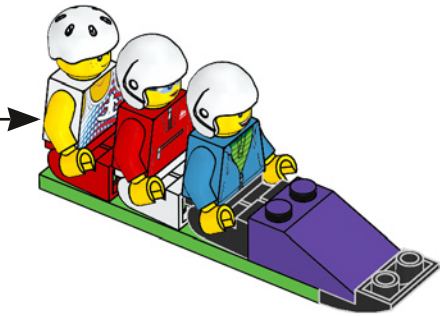

7

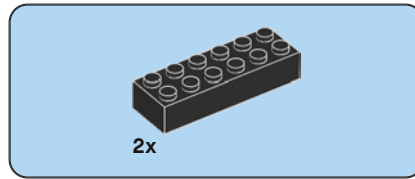
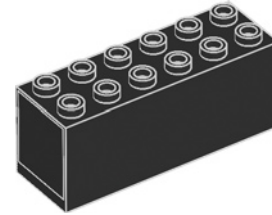
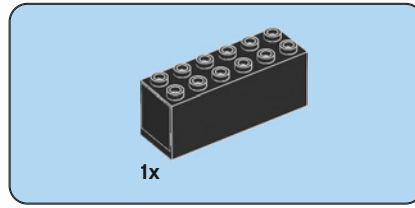

8

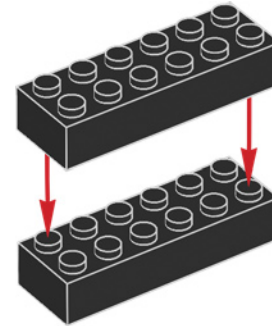

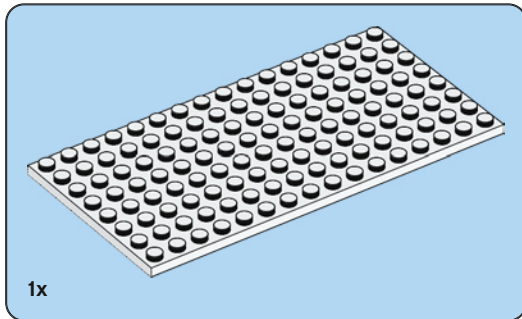
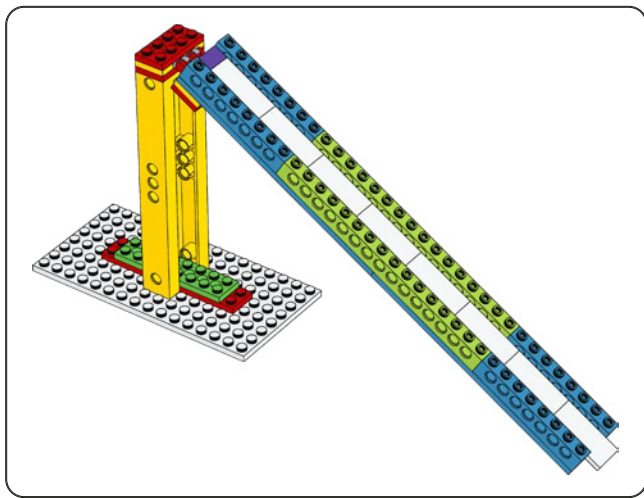

9

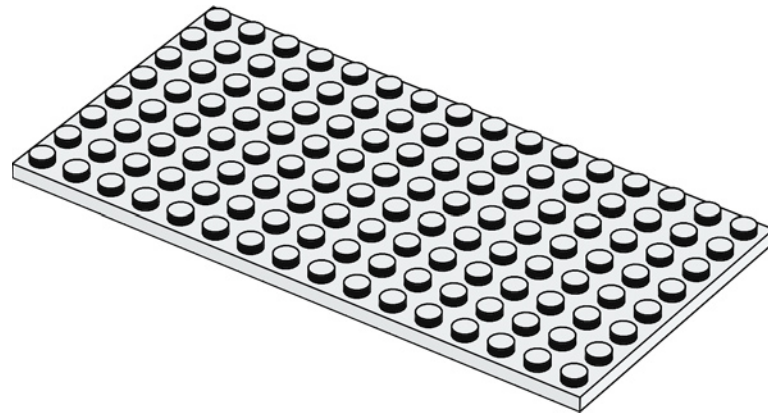

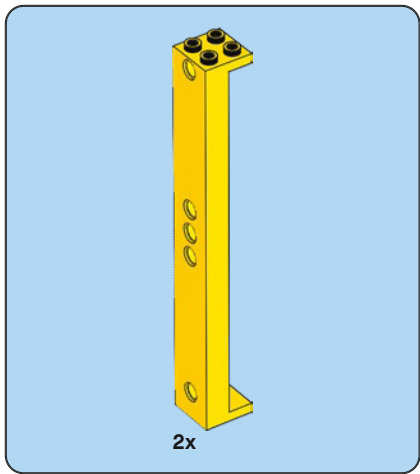

10

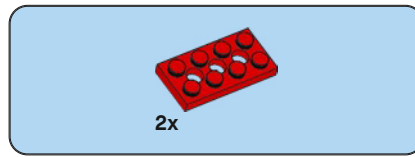
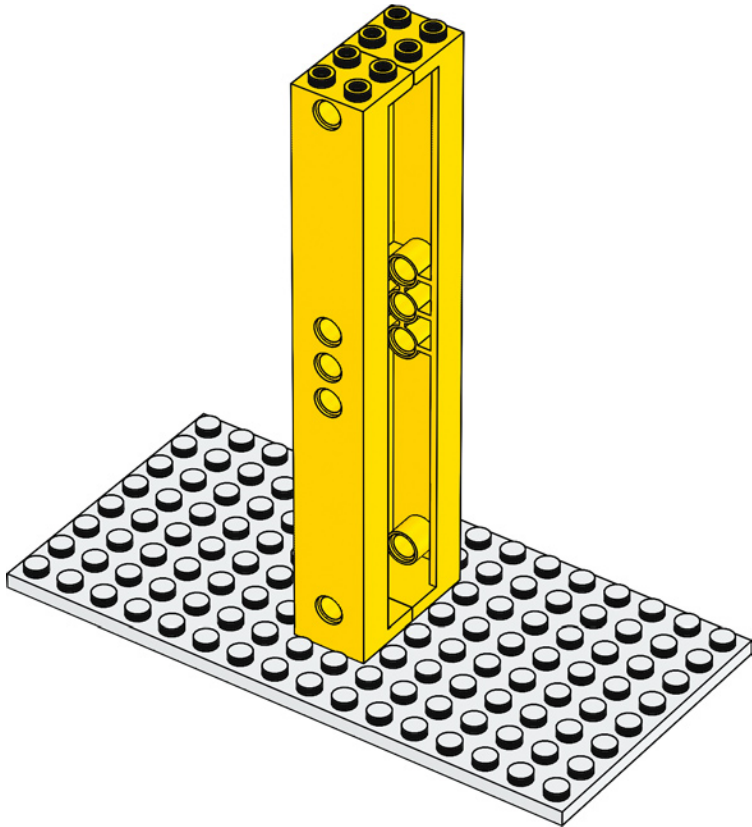

11

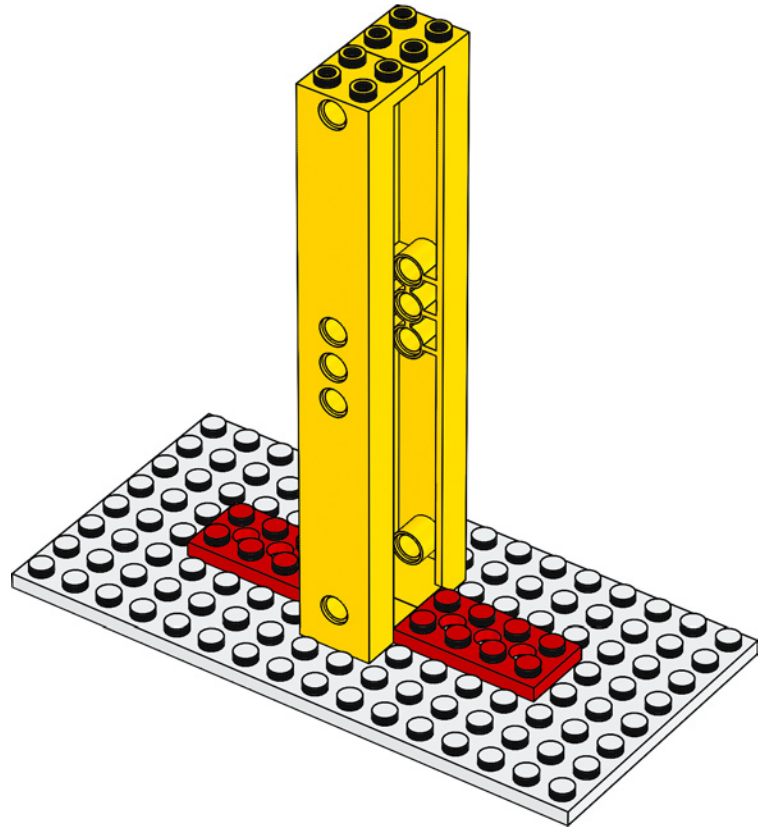

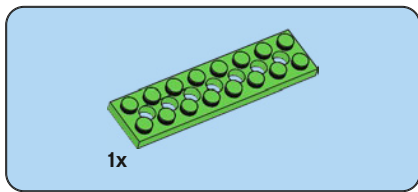

12

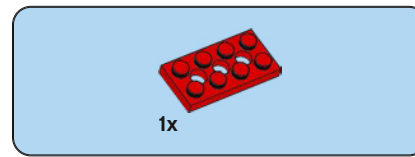
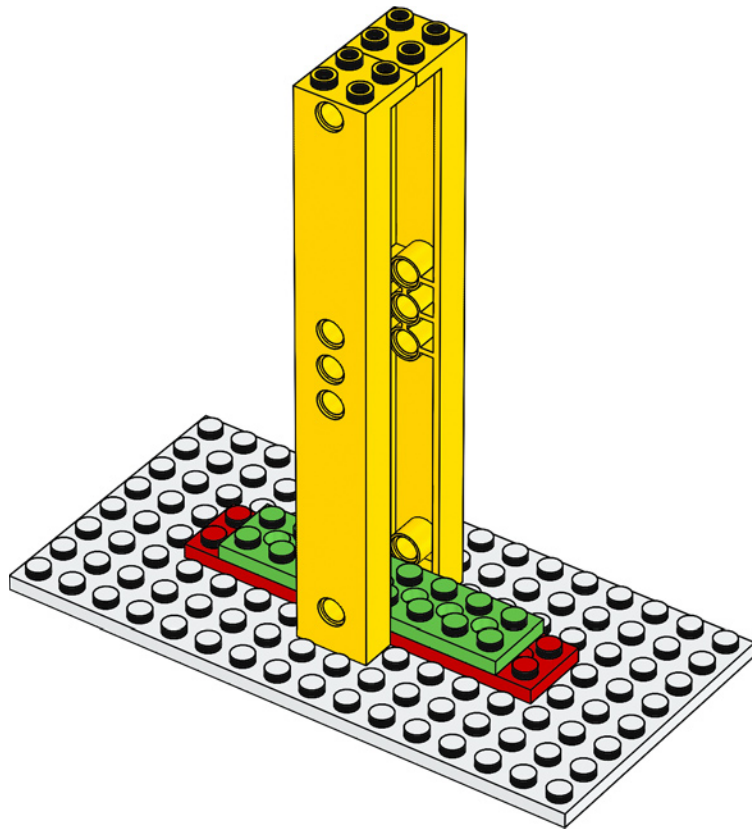

13

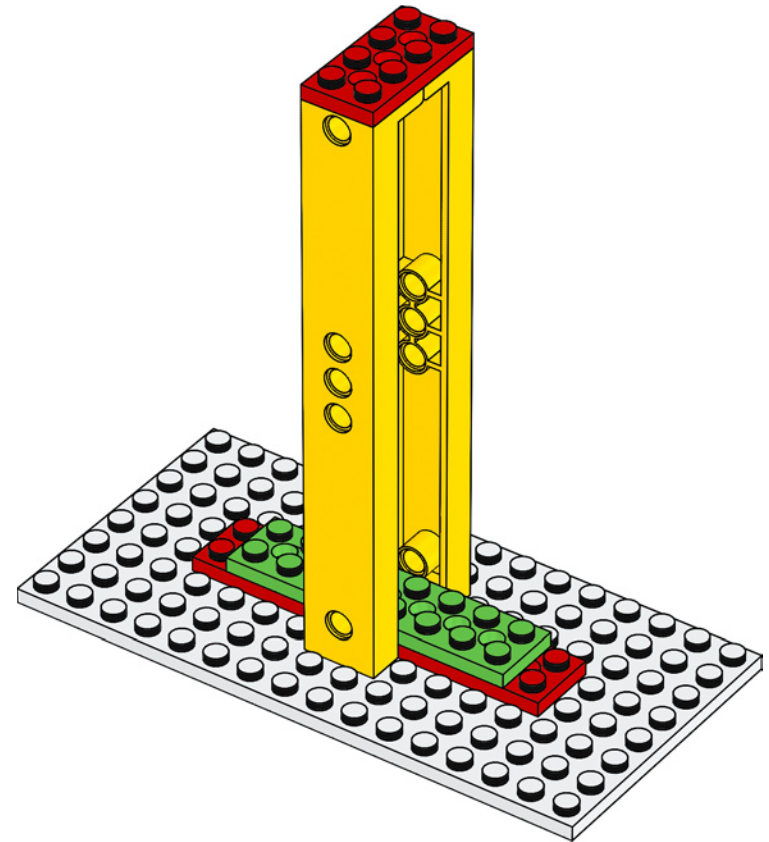



14

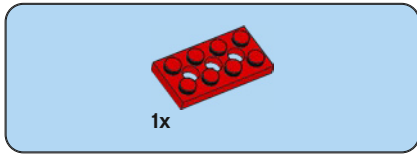
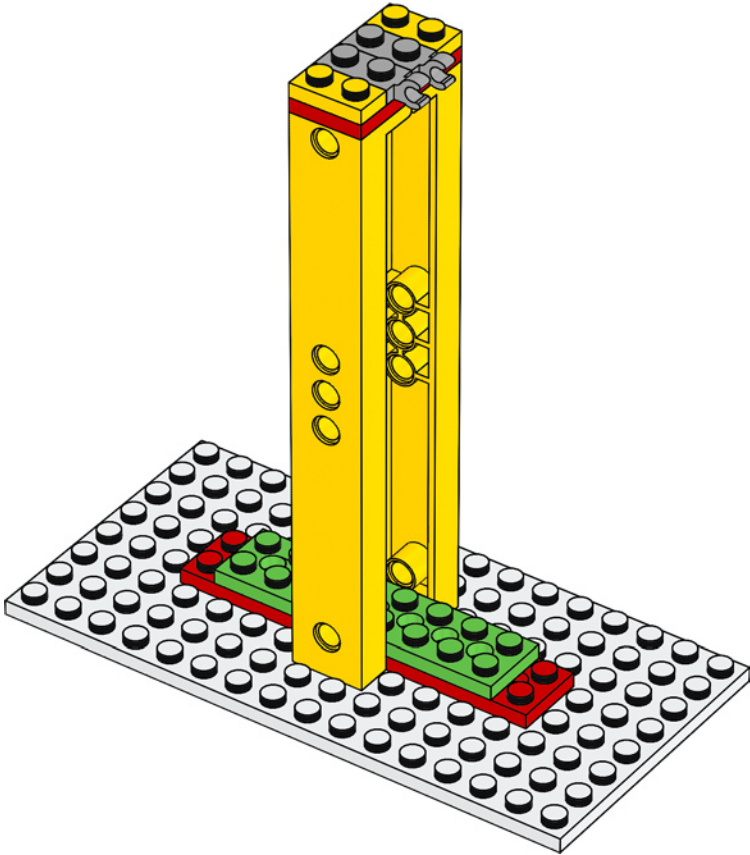

15

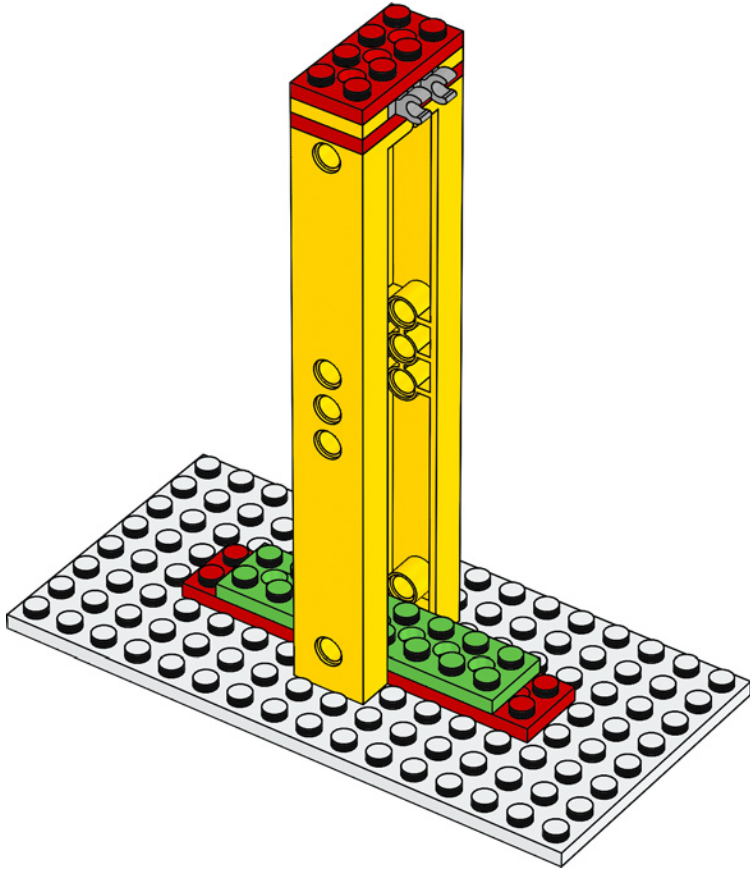

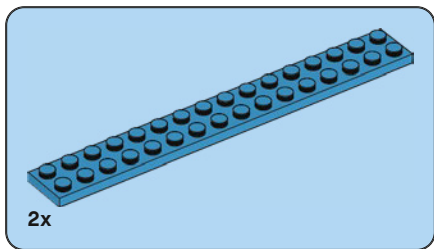
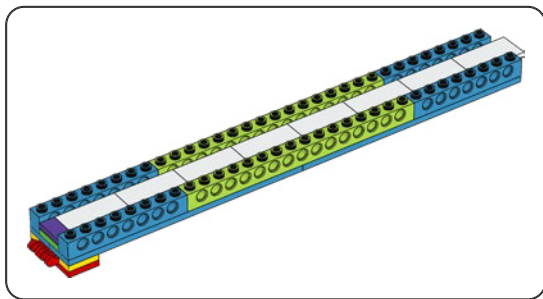

16

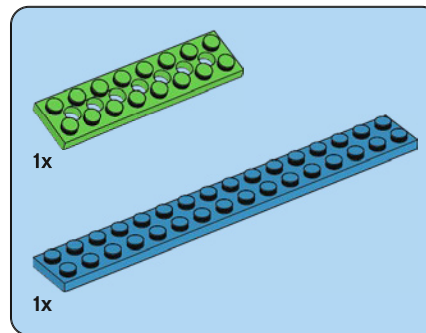
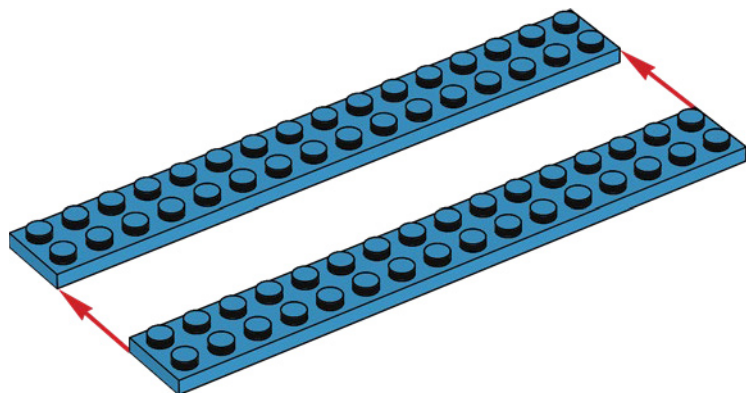

17

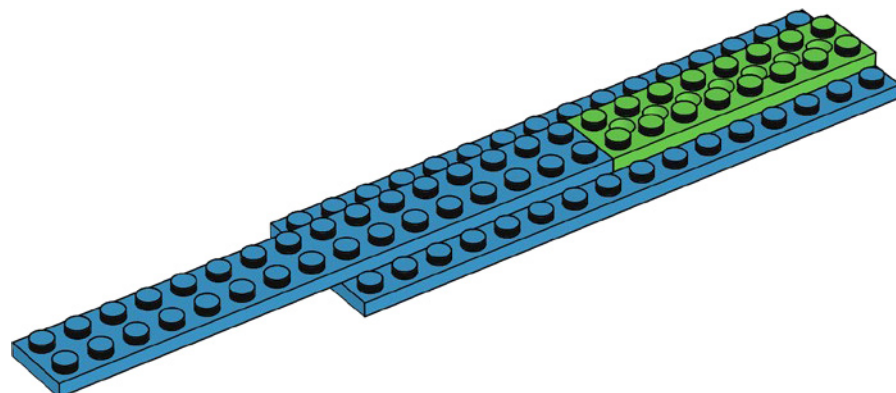

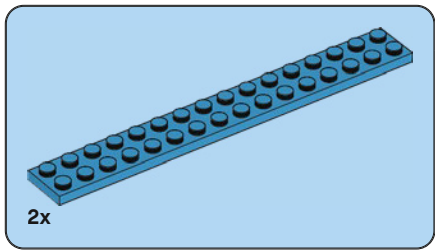

18

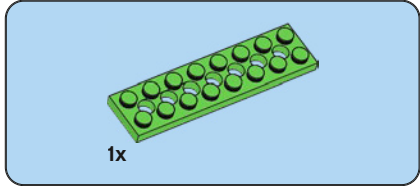
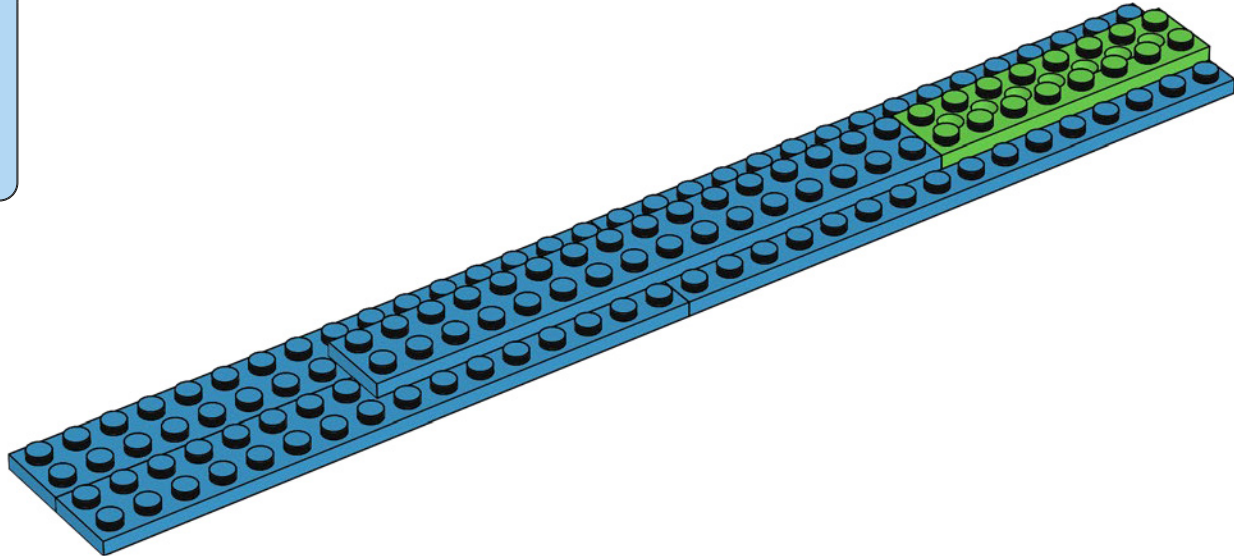

19

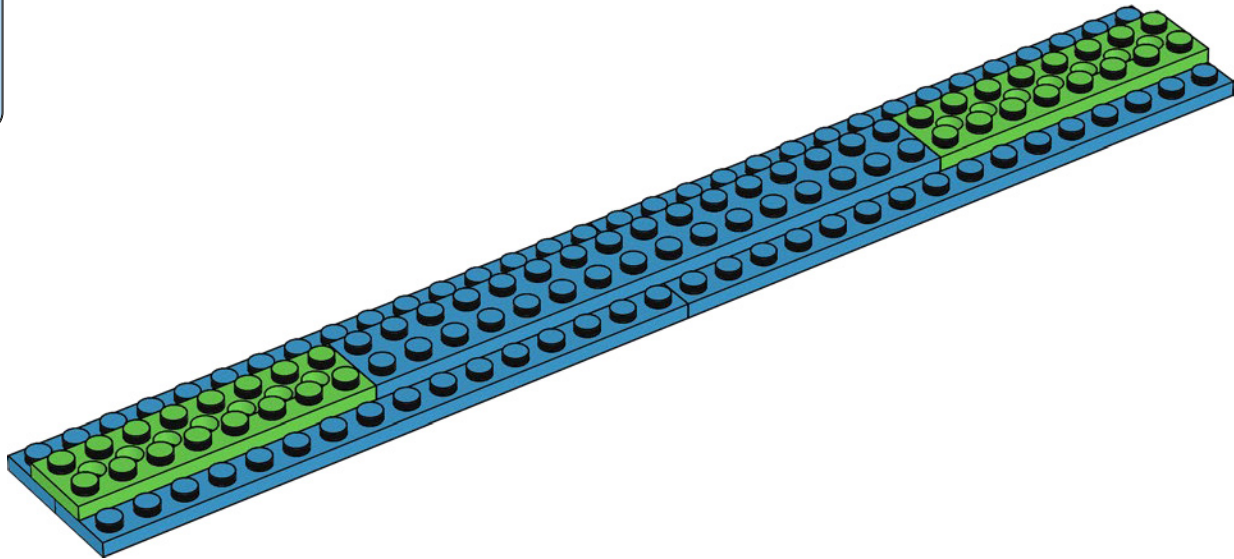

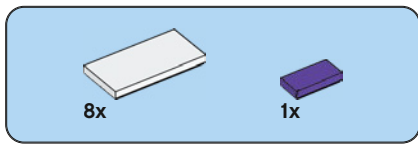

20

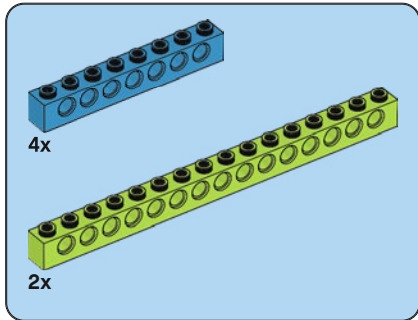
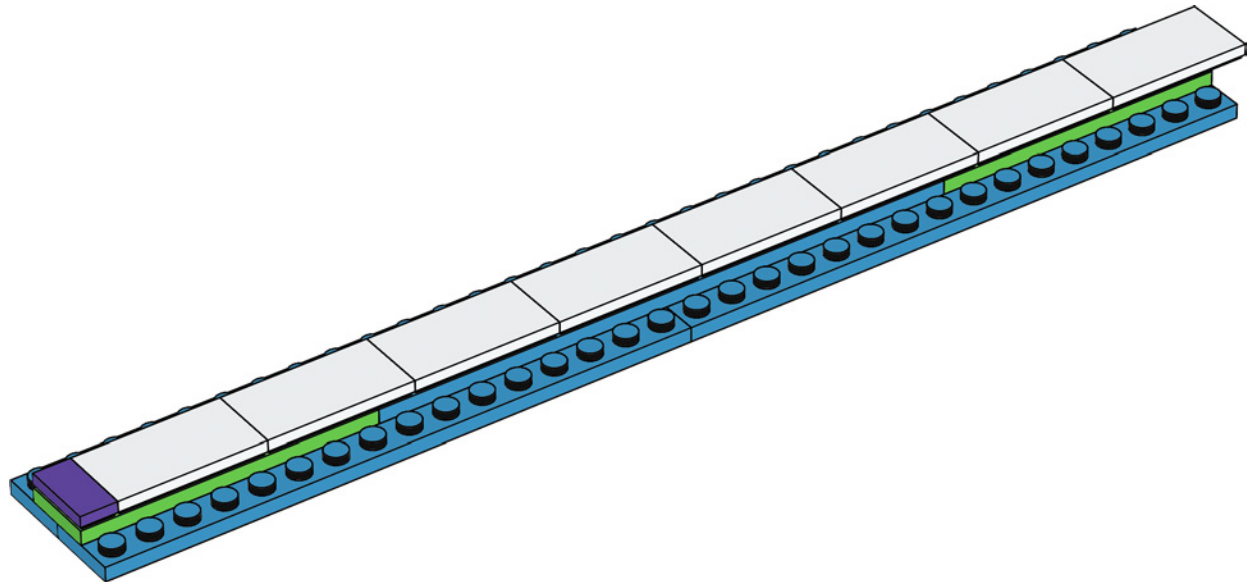

21

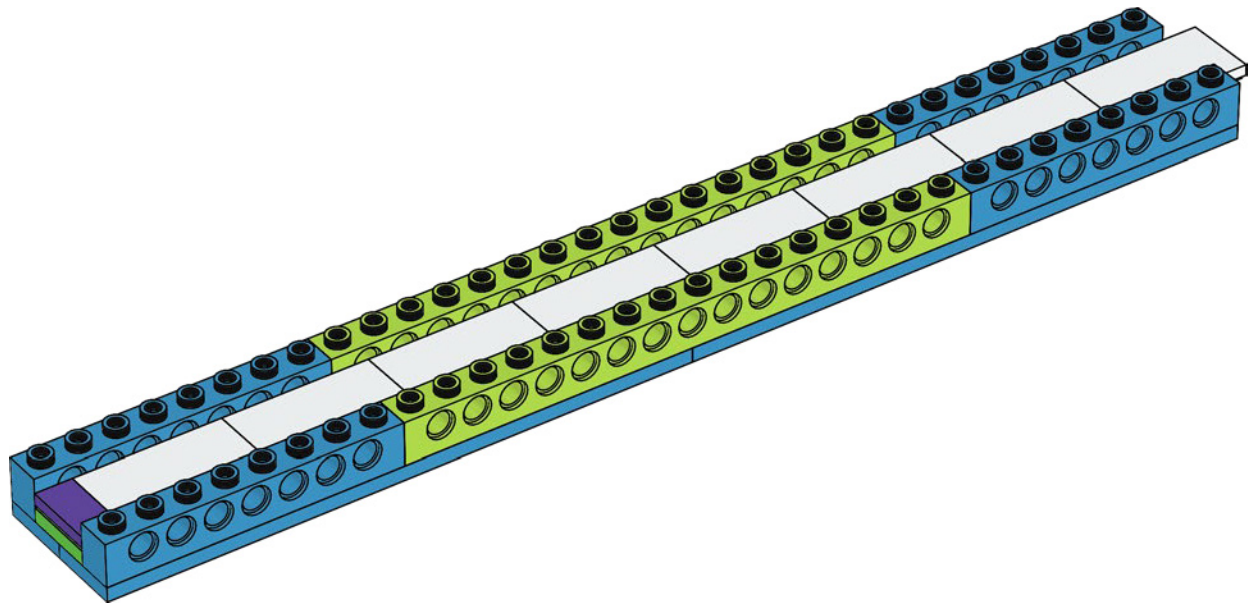

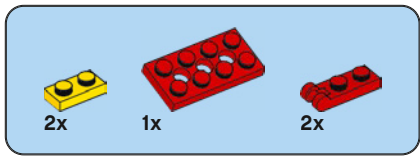

22

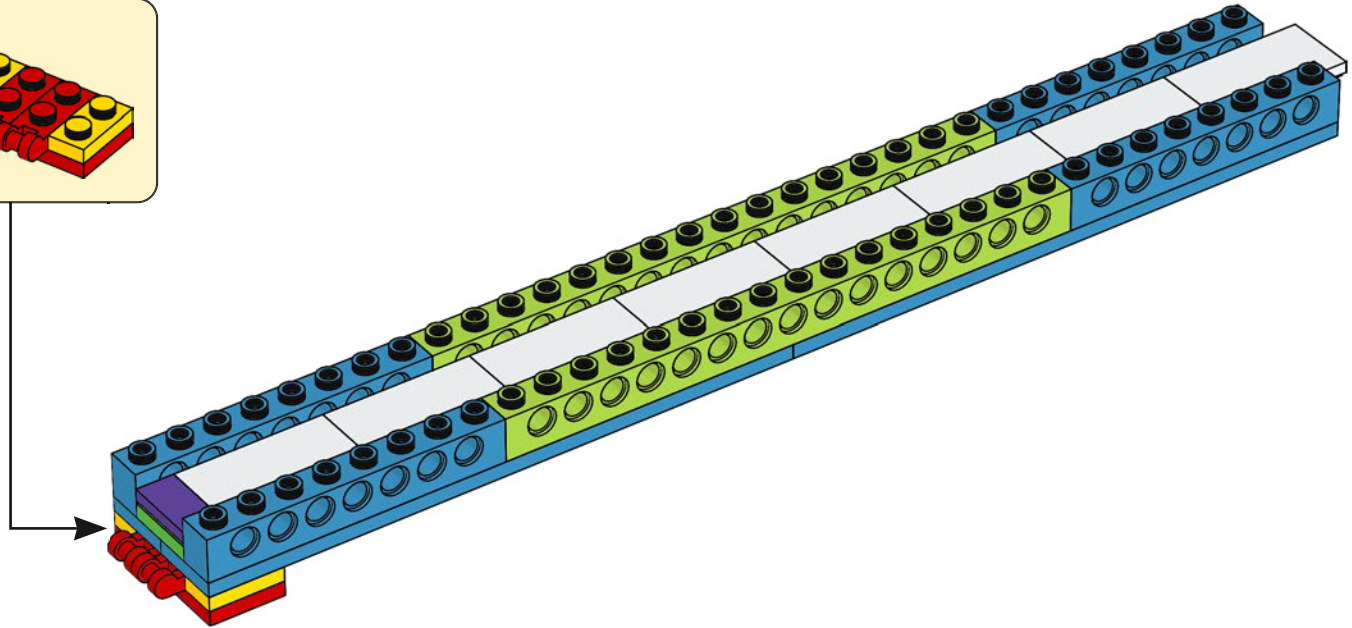
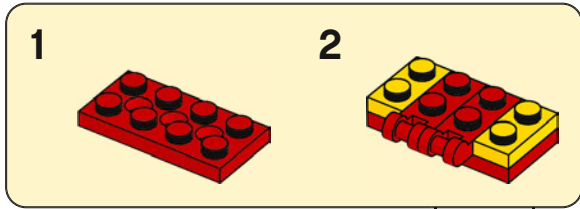

23

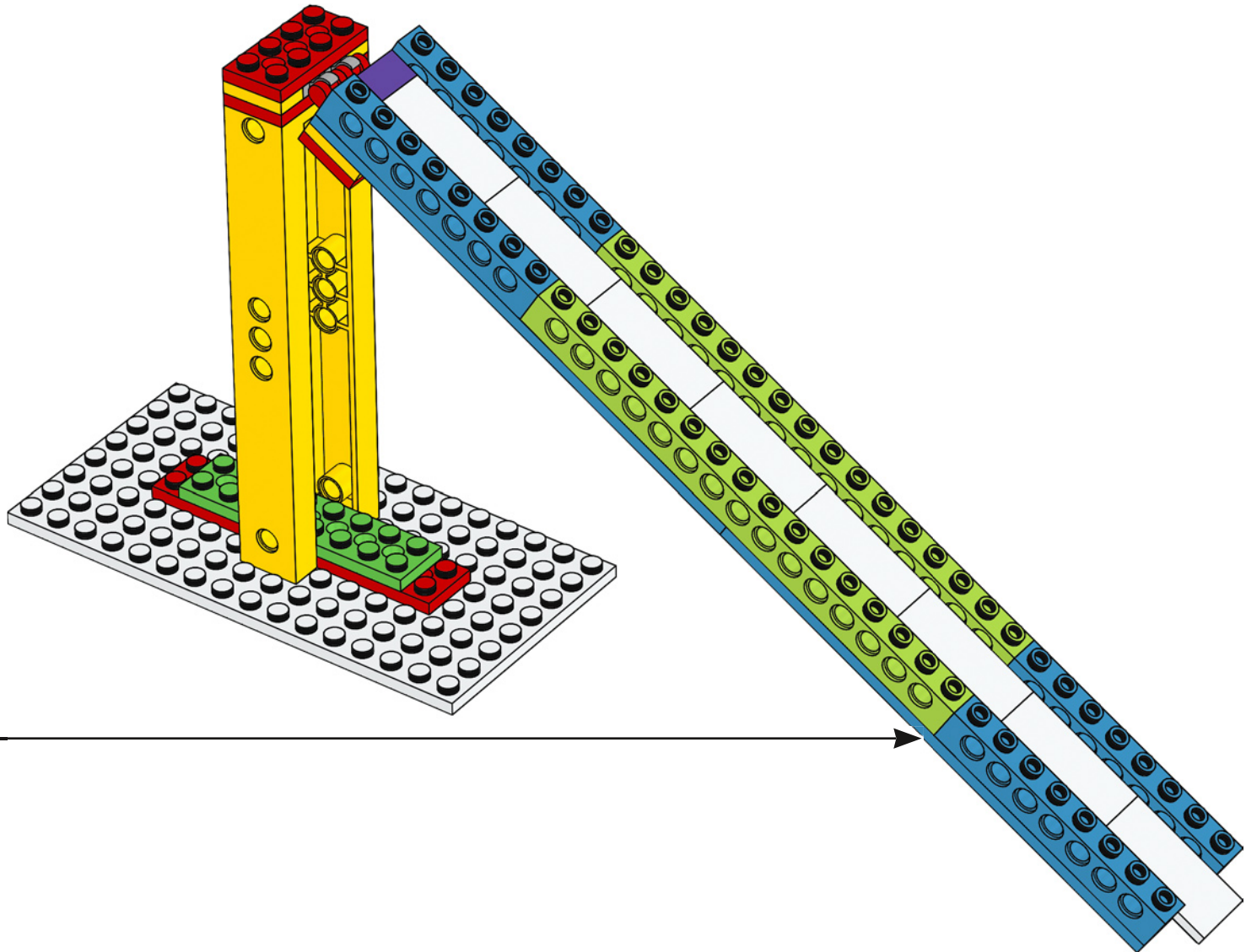



4x

24

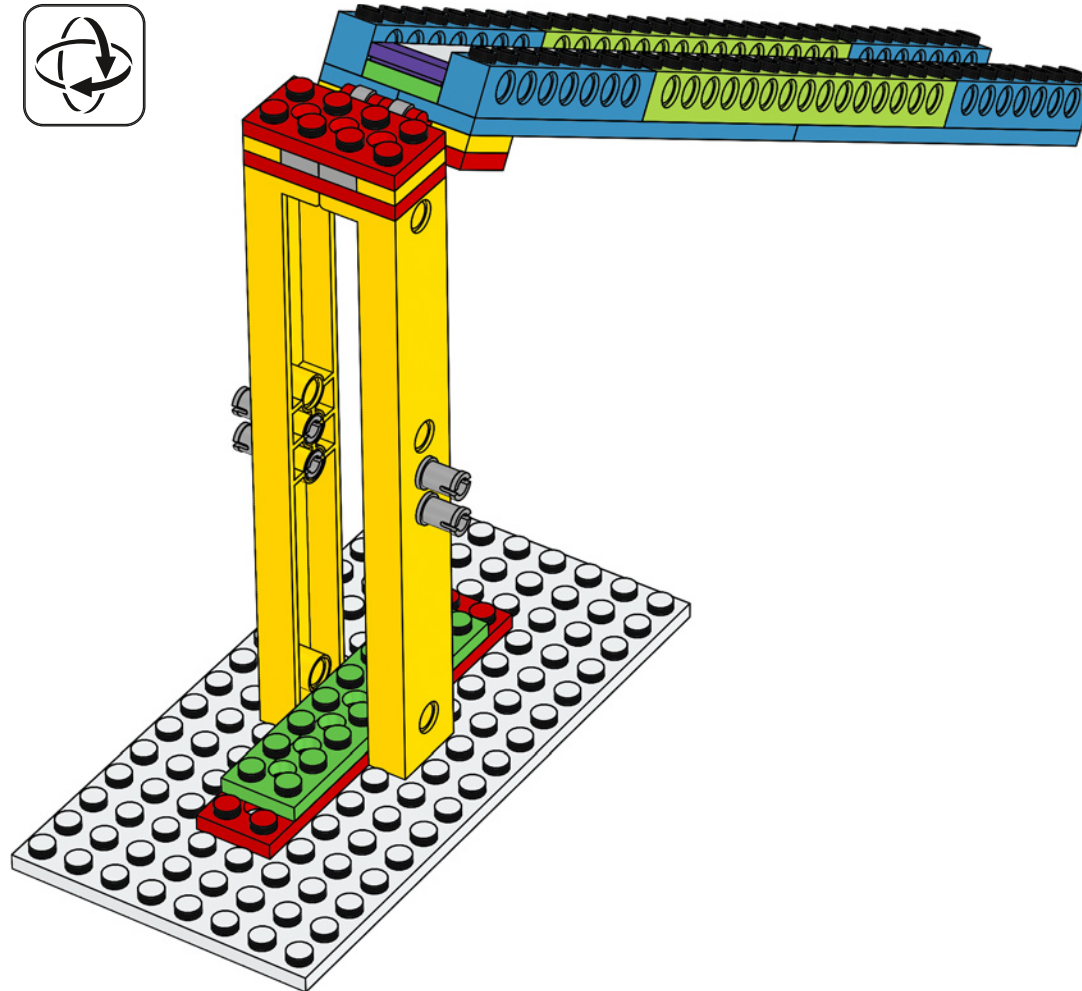

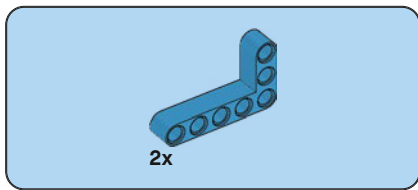

25

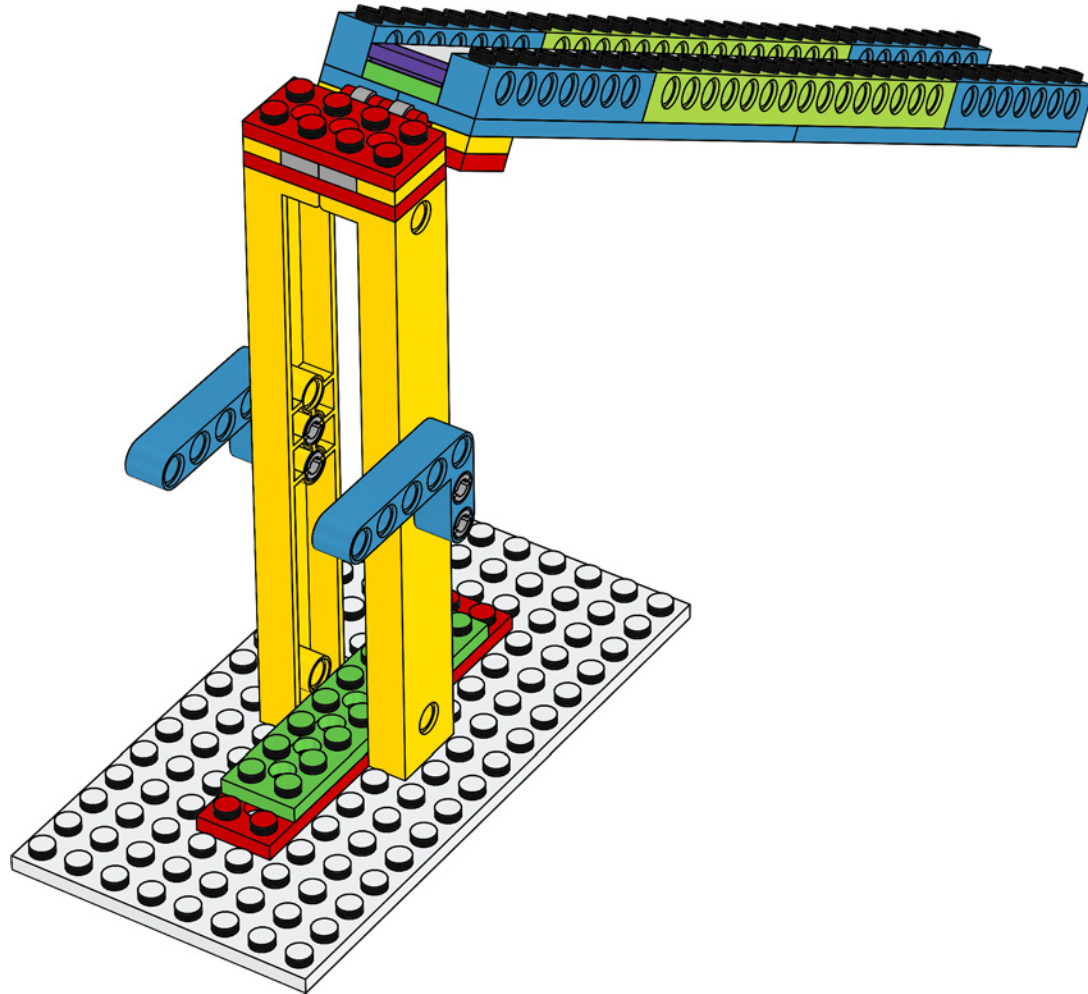

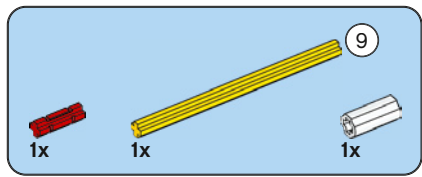

26

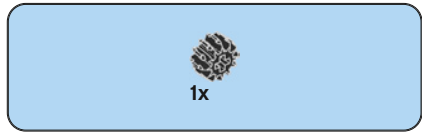
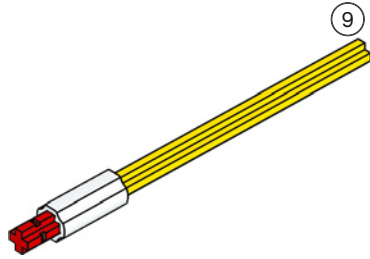

27

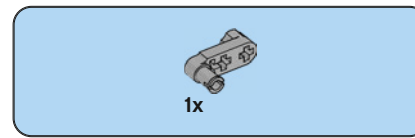
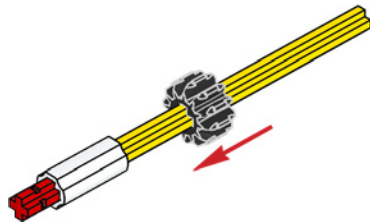

28

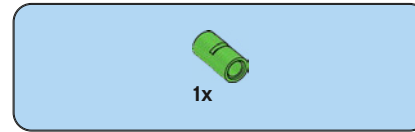
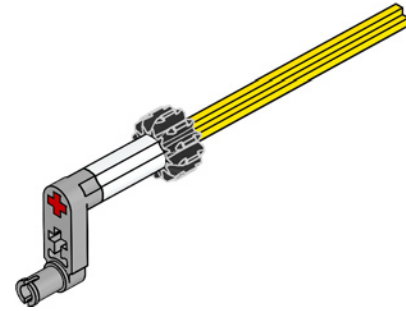

29

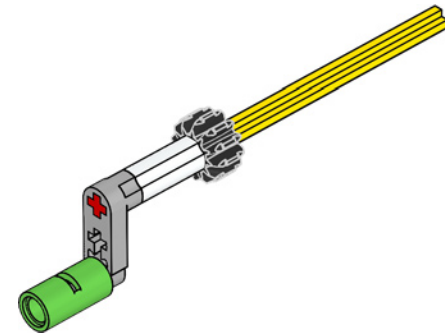



30

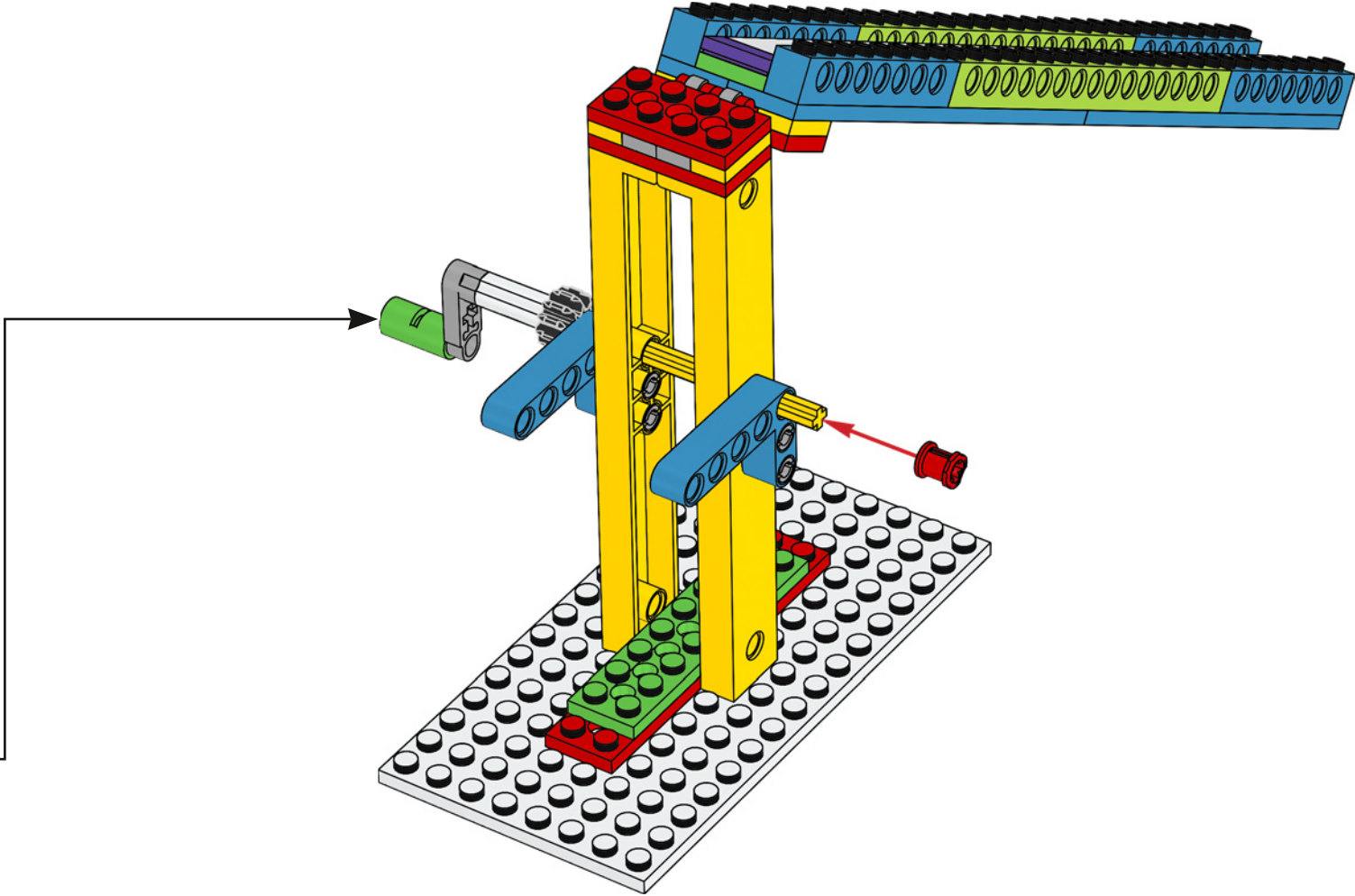

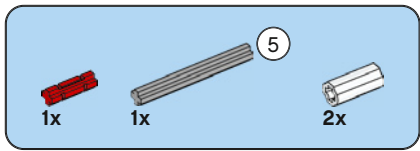

31

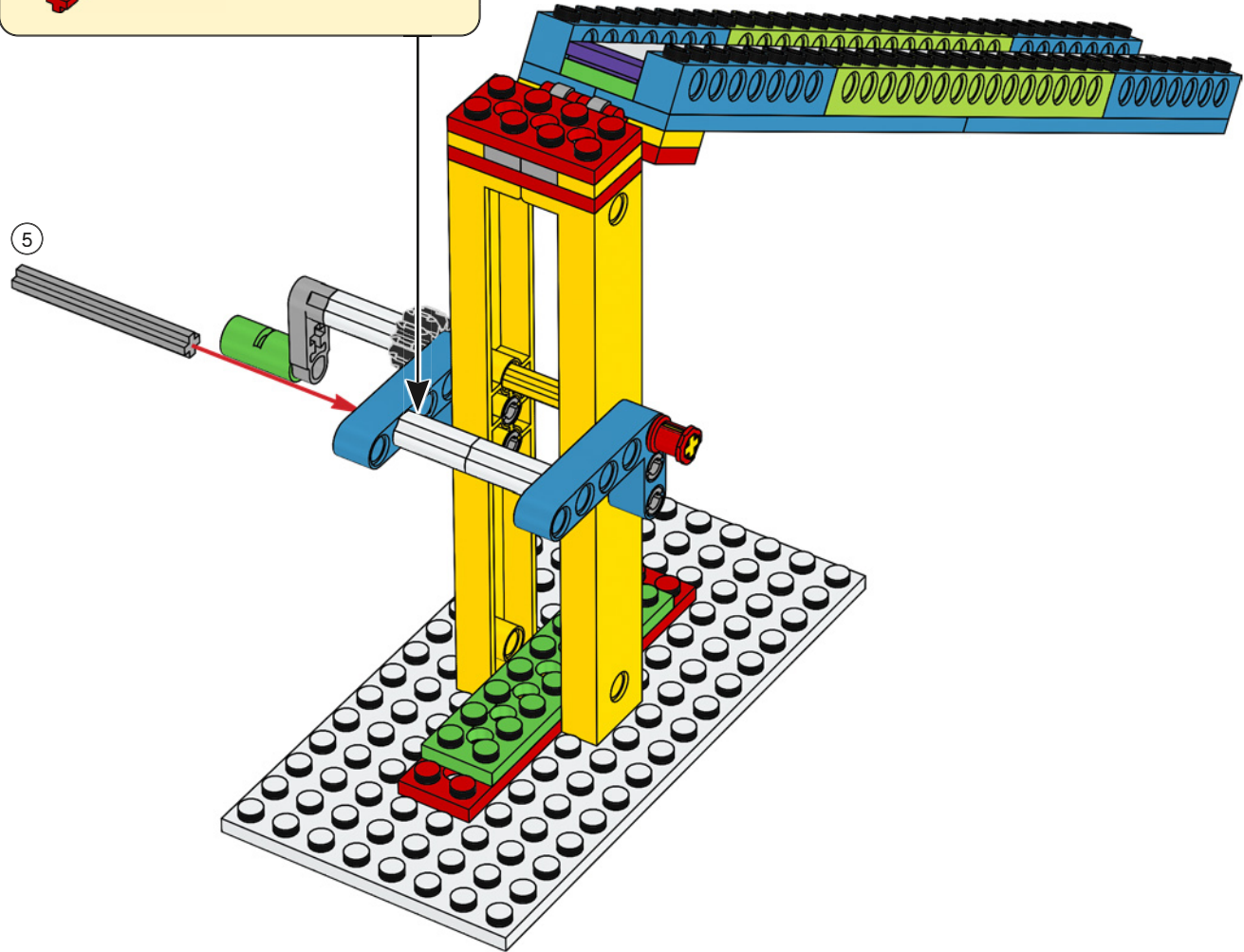
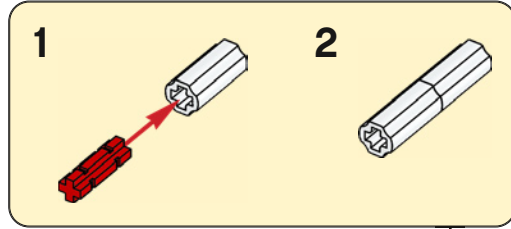

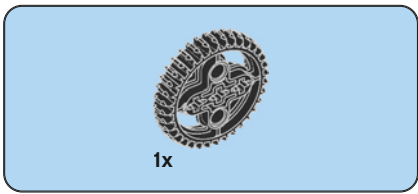

32

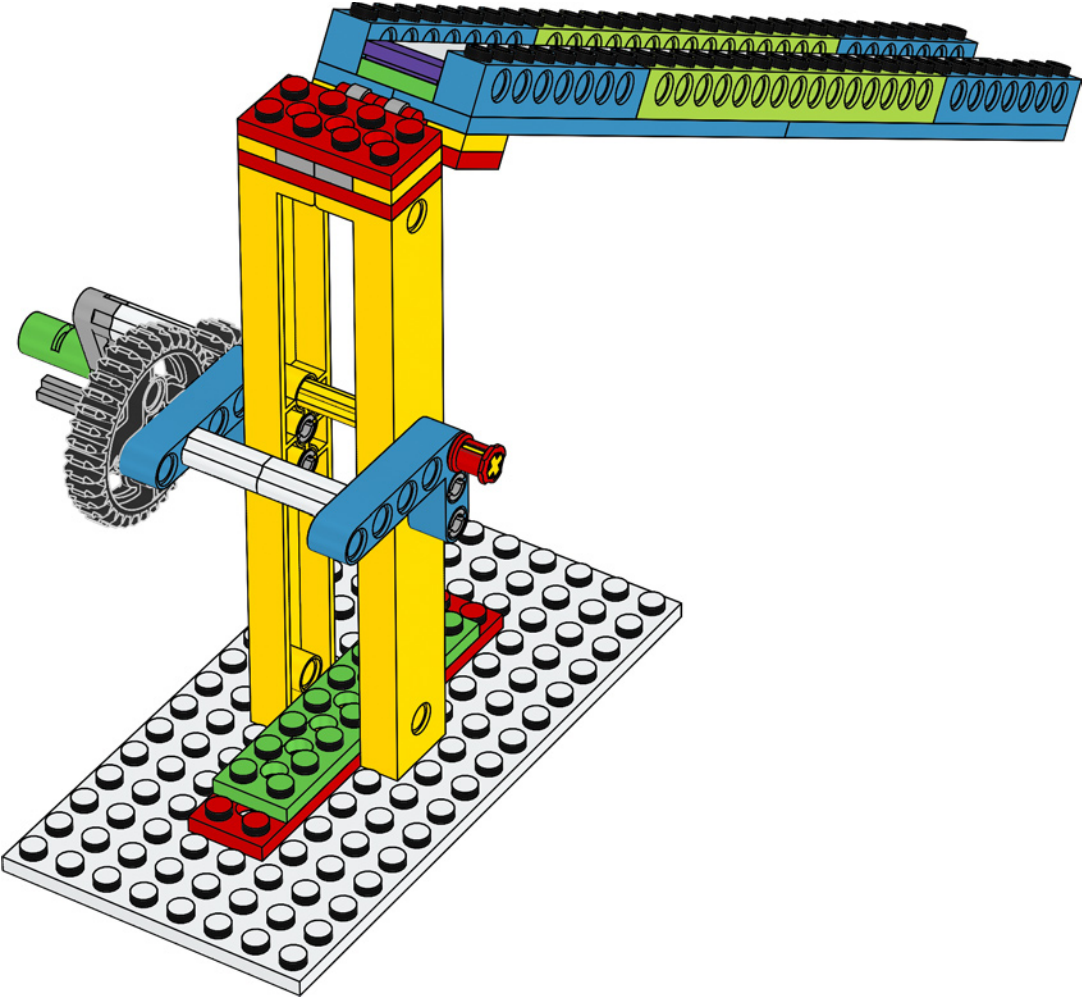



33

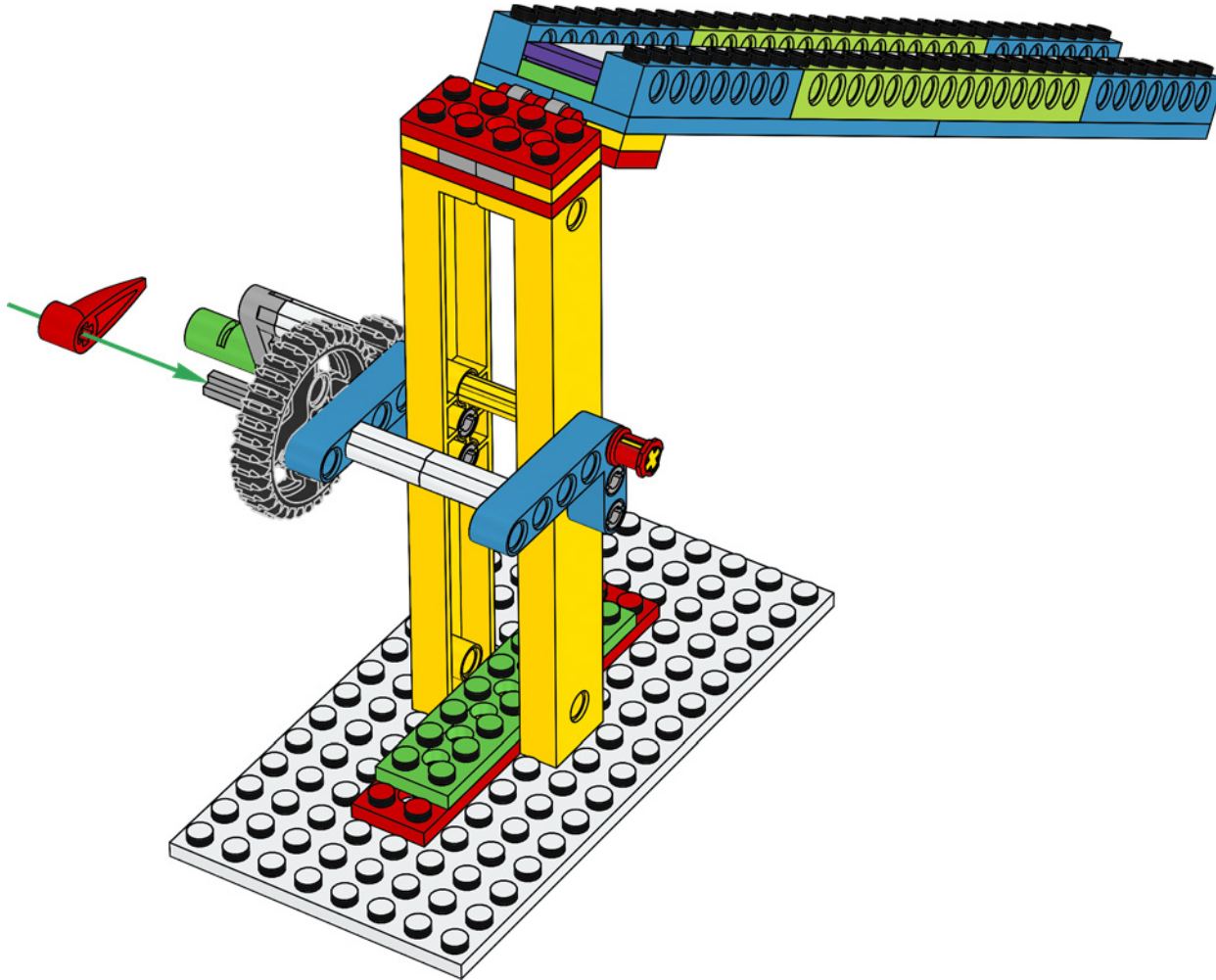

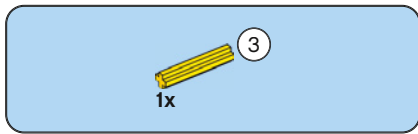

34

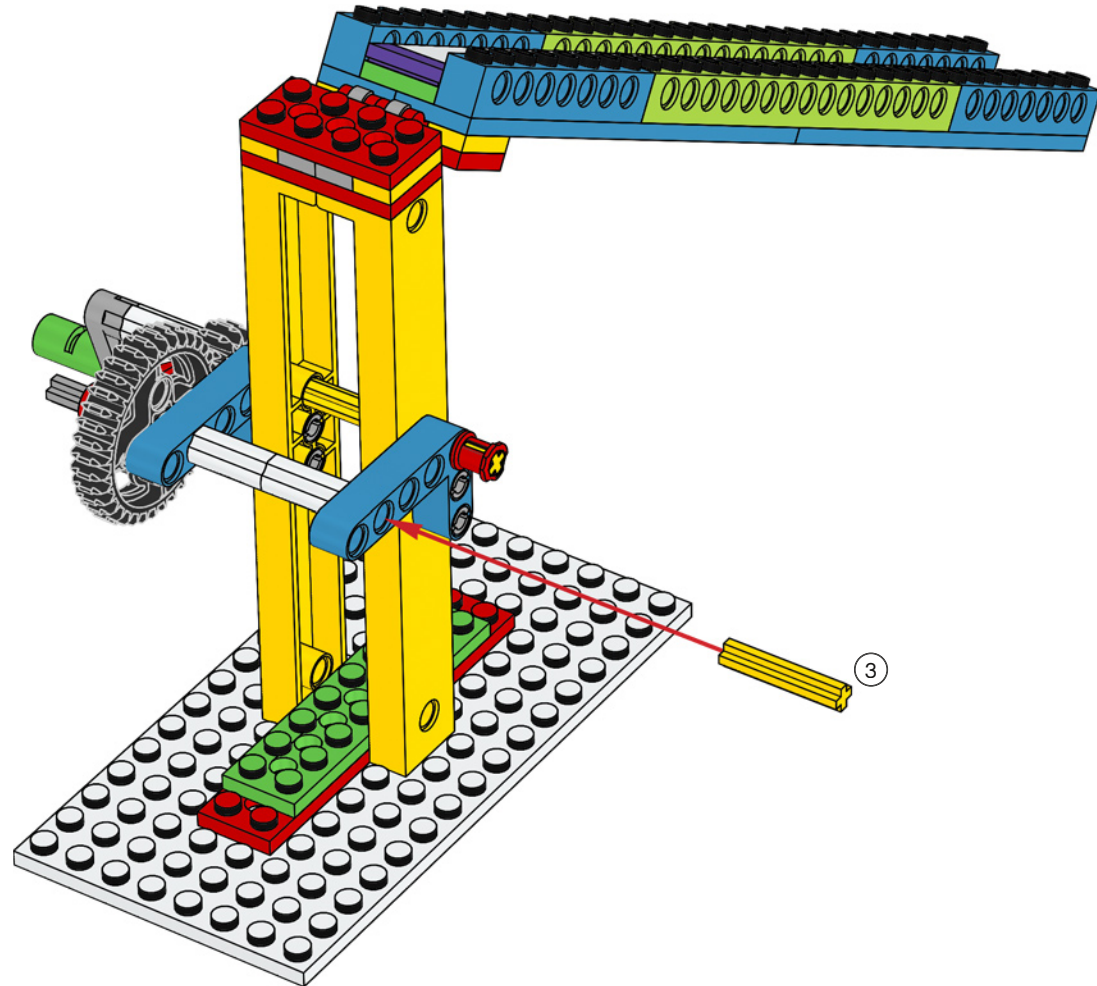



1x

35

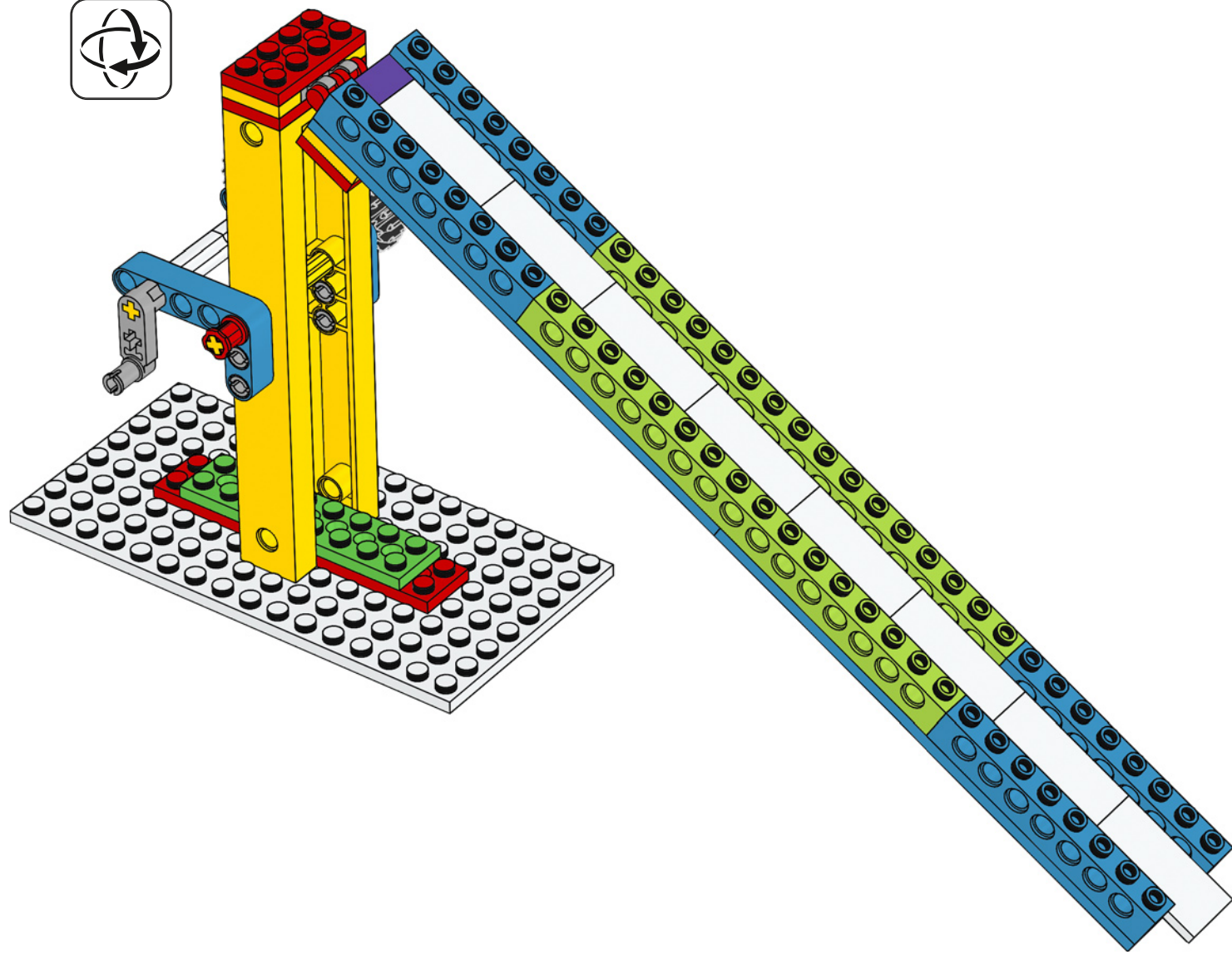

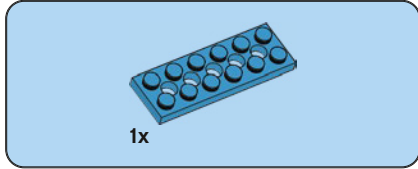
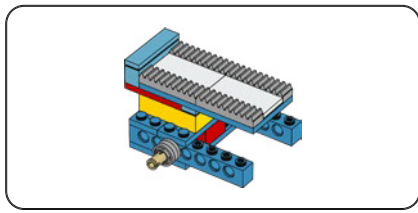

36

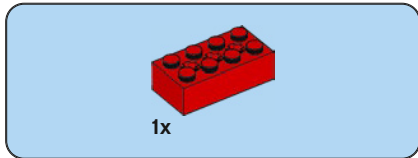
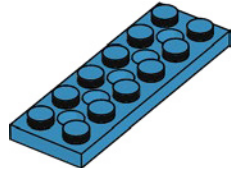

37

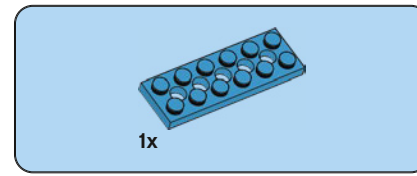
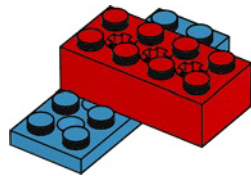

38

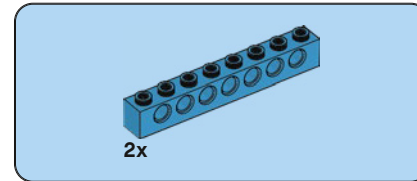
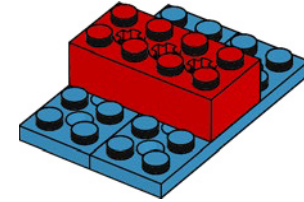

39

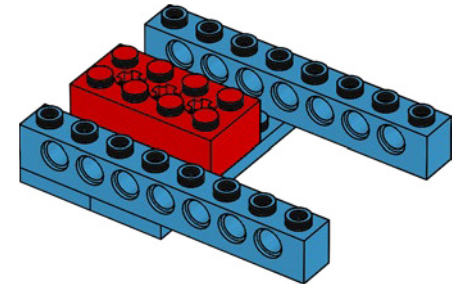

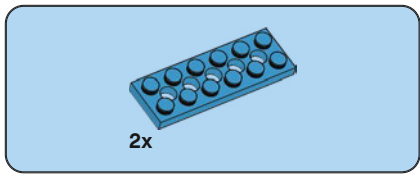

40

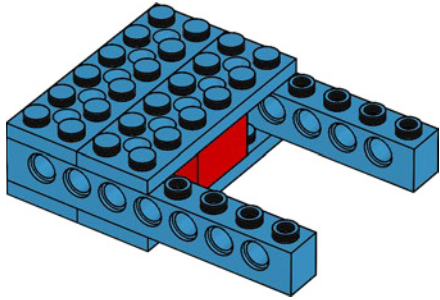

41

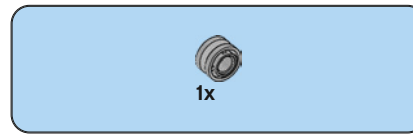
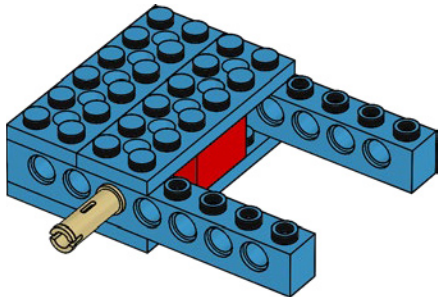

42

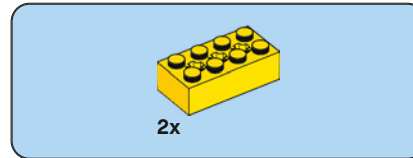
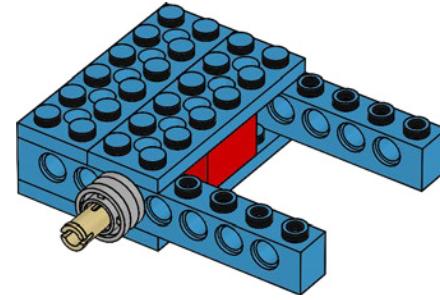

43

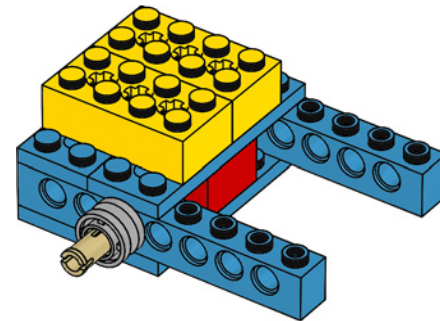

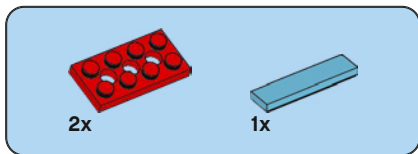

44

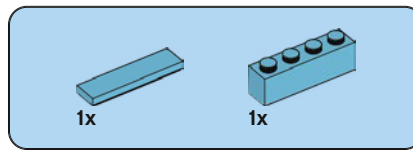
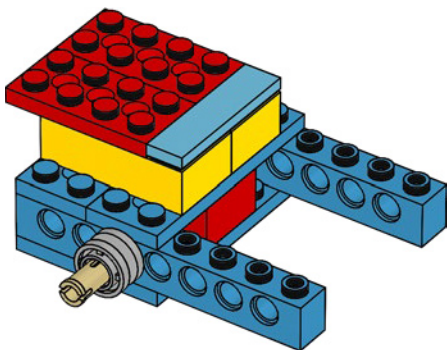

45

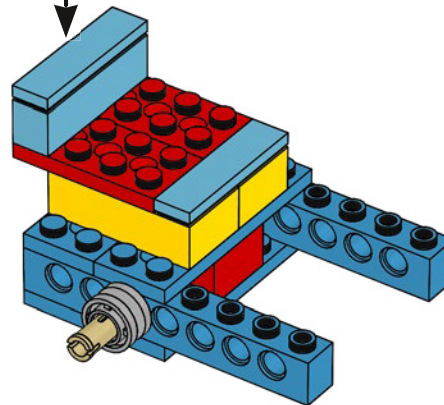
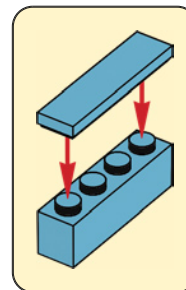

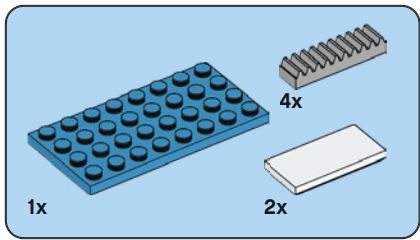

46

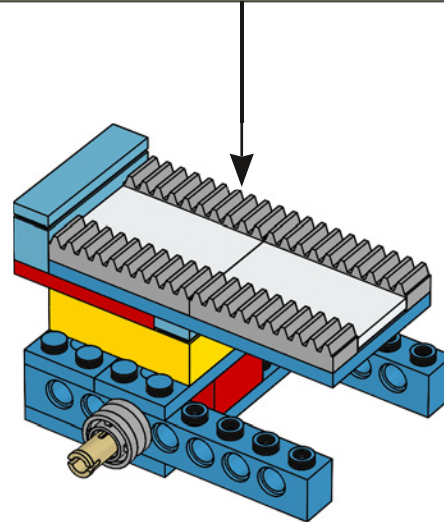
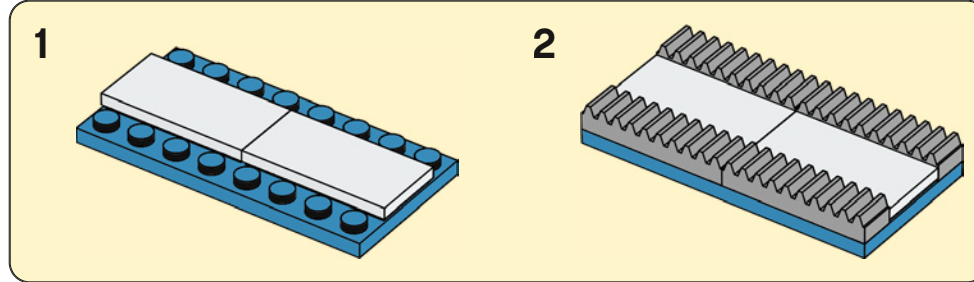

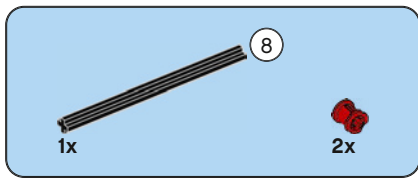

47

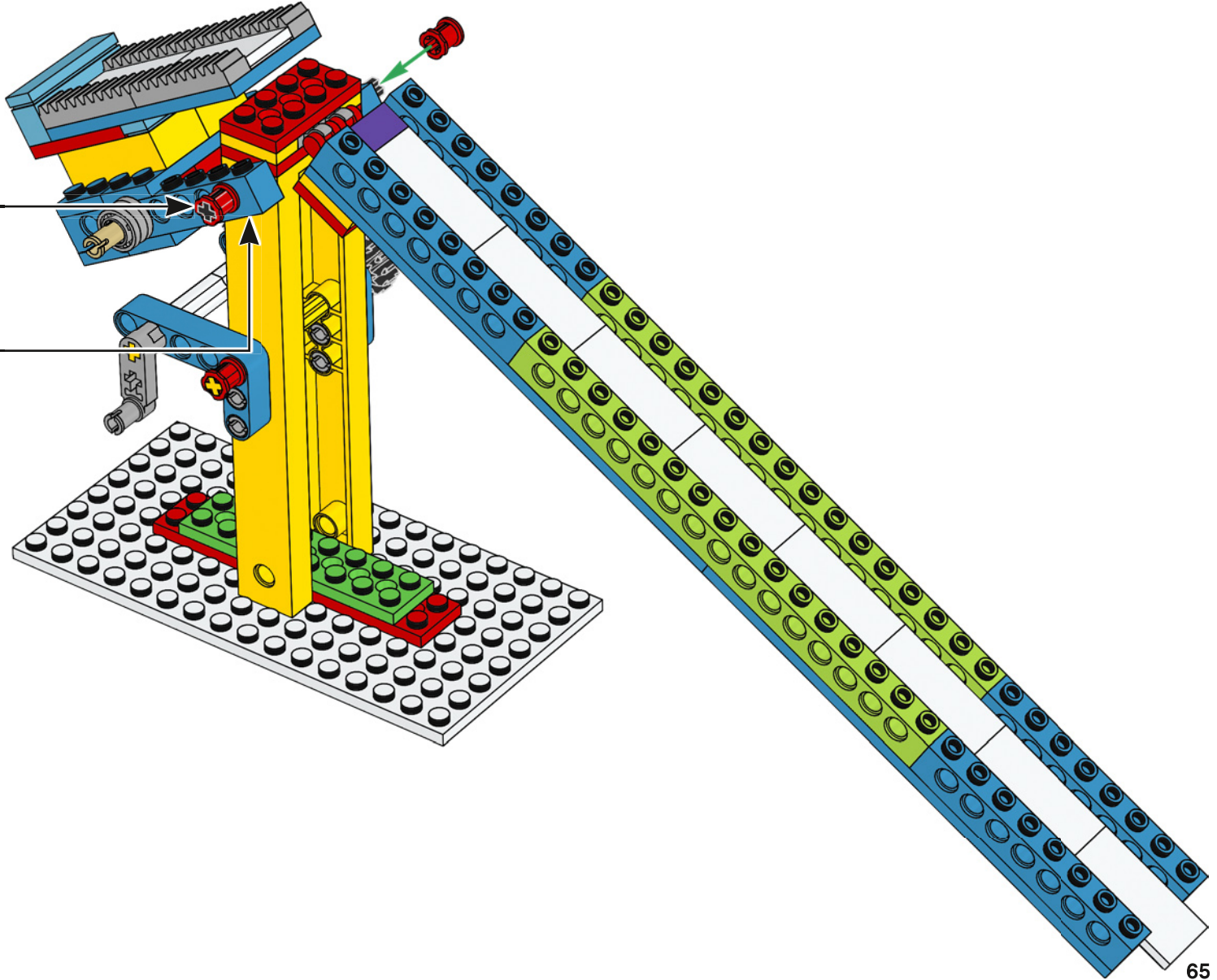
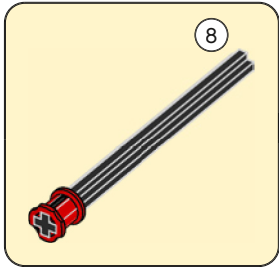

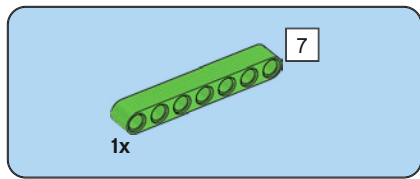

48

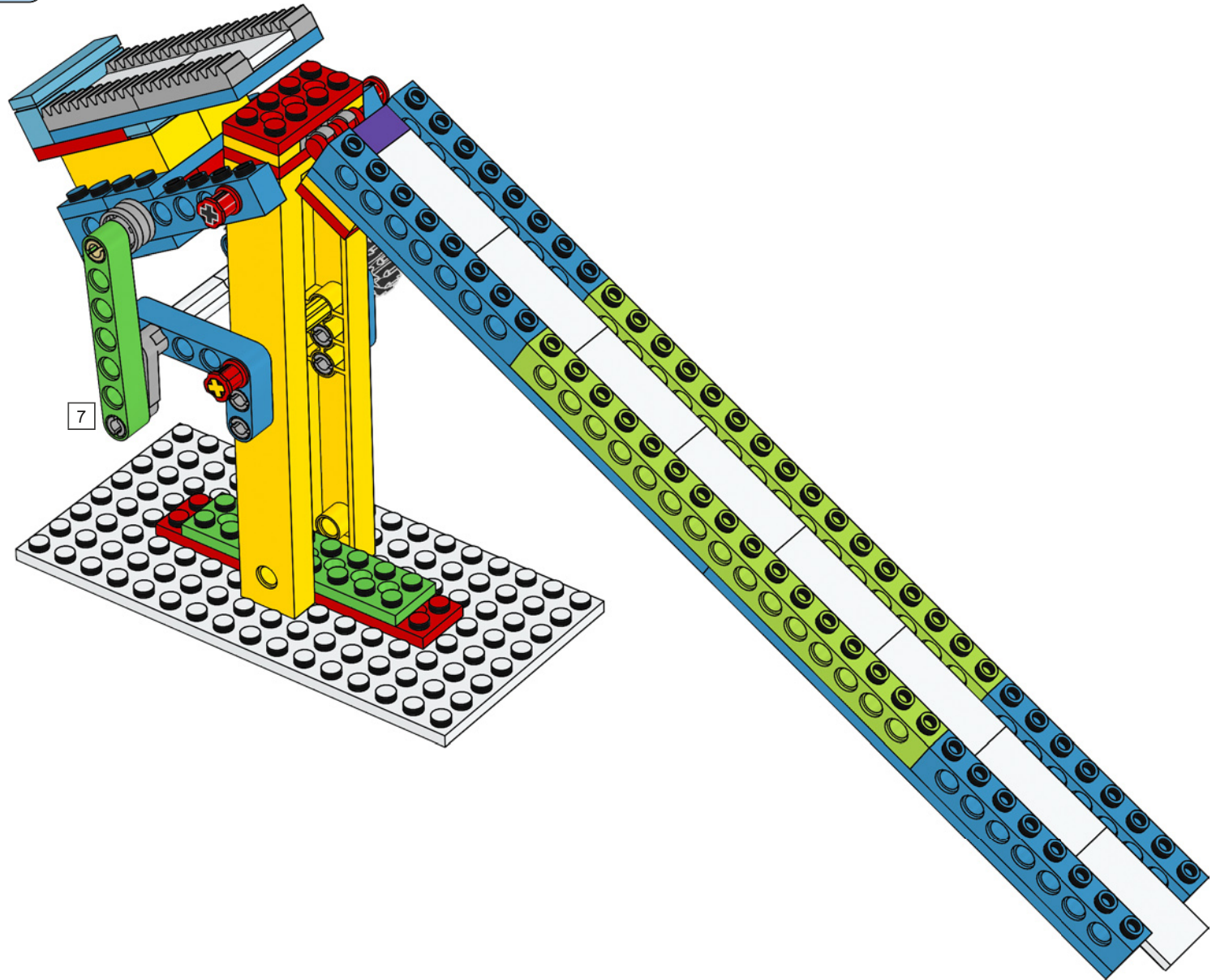

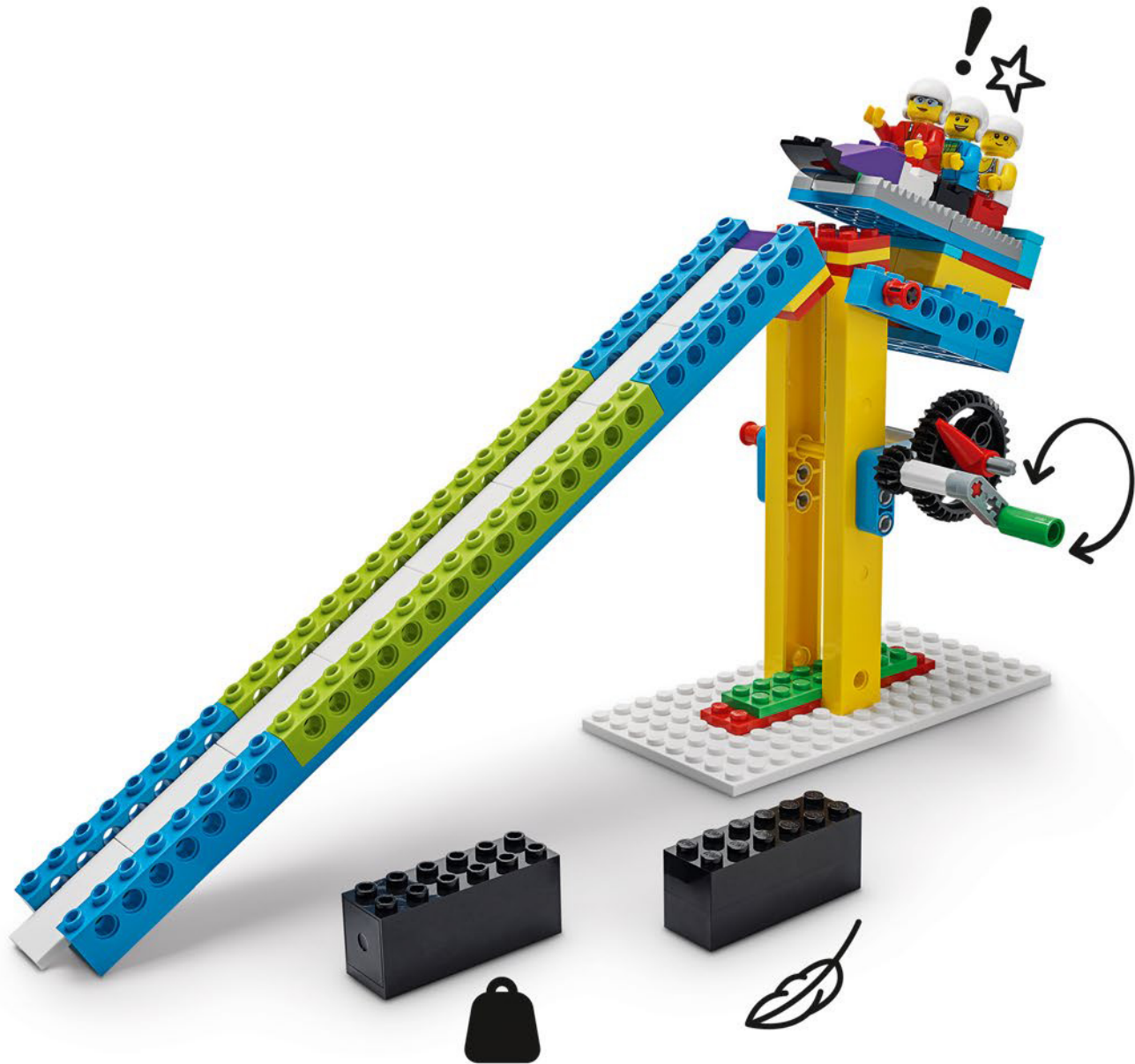

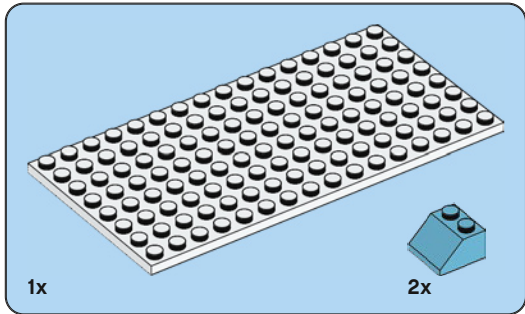
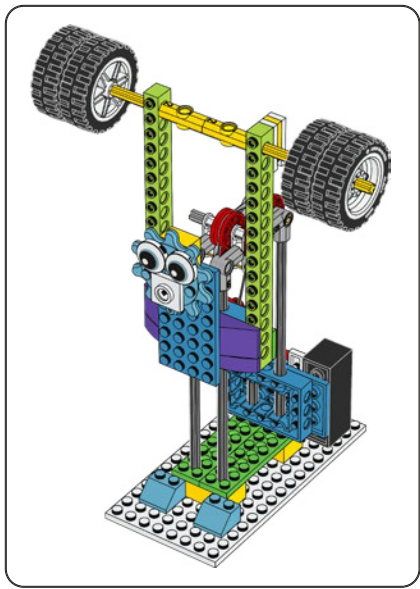

1

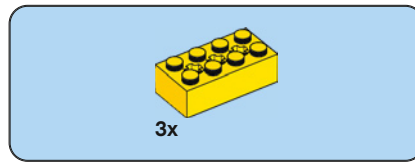
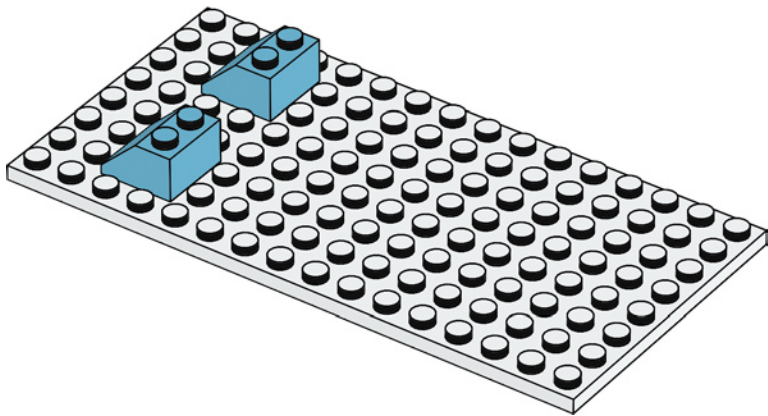

2

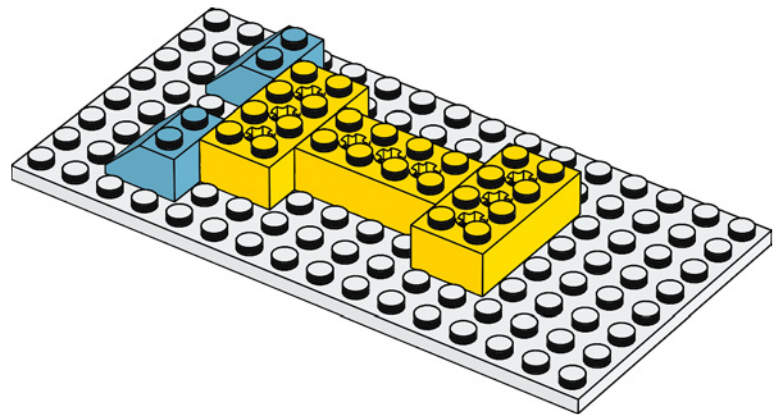

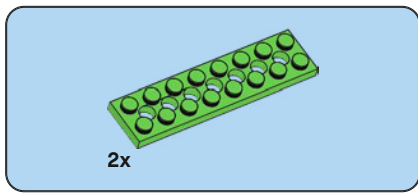

3

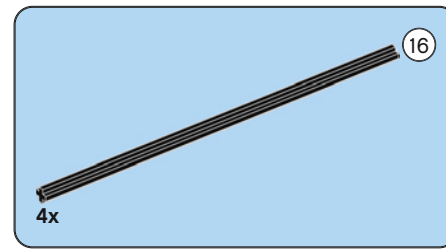
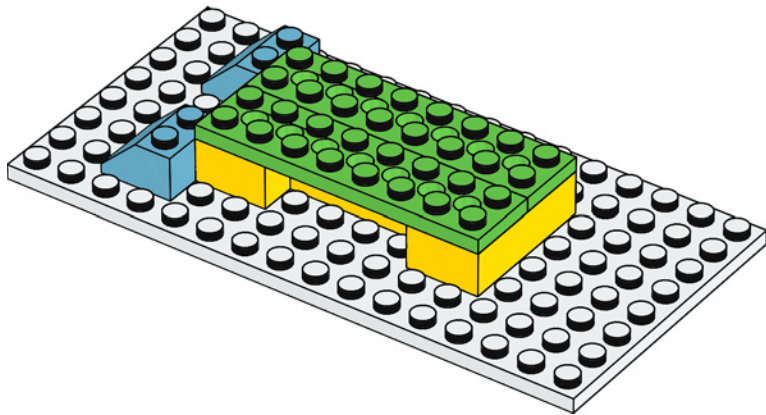

4

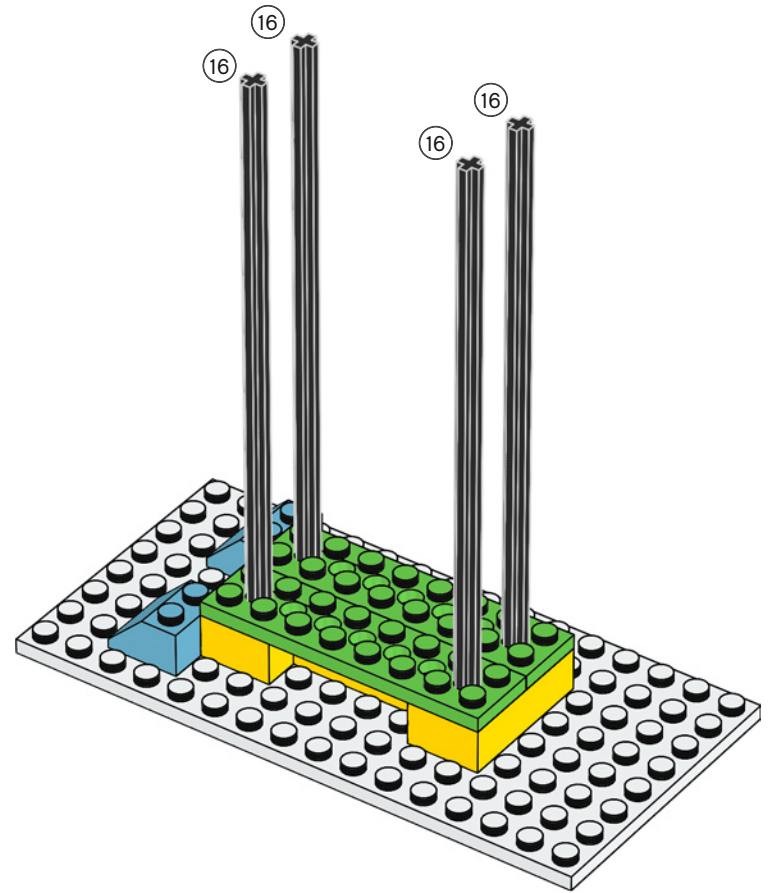

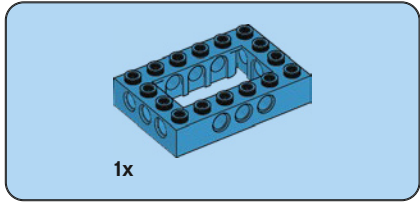
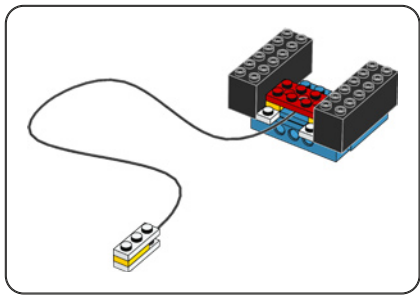

5

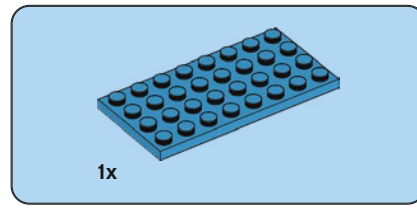
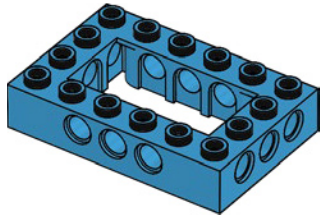

6

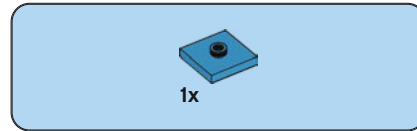
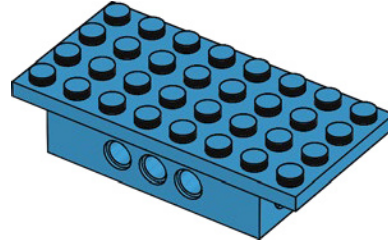

7

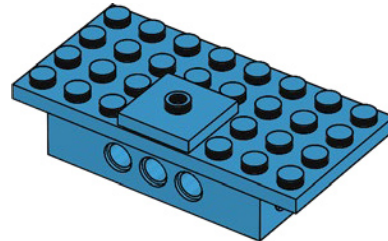

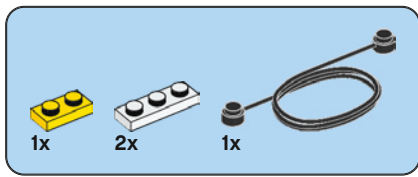

8

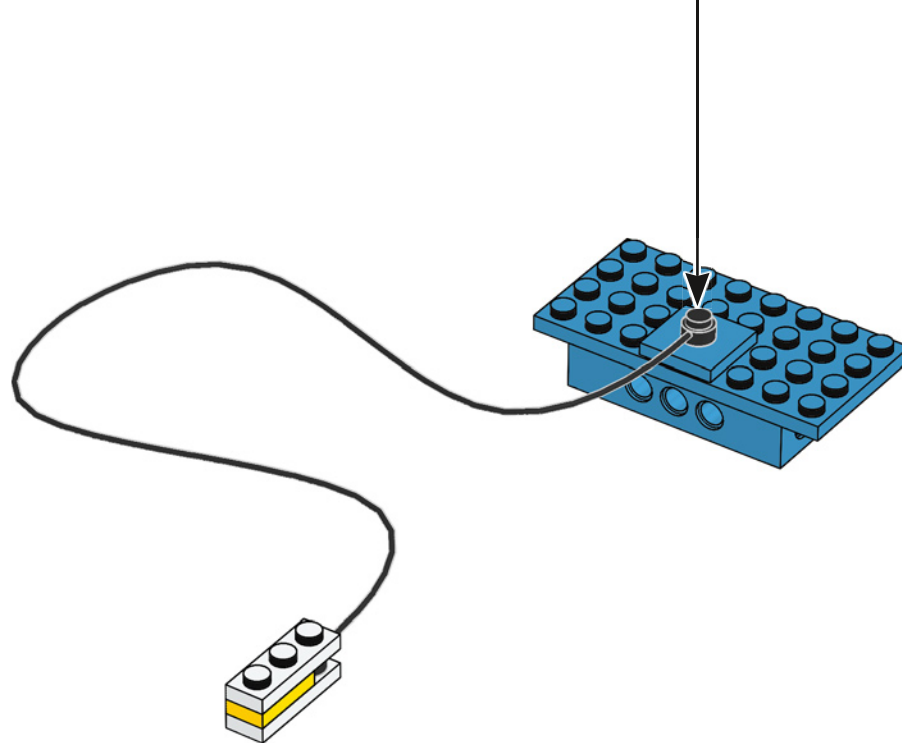
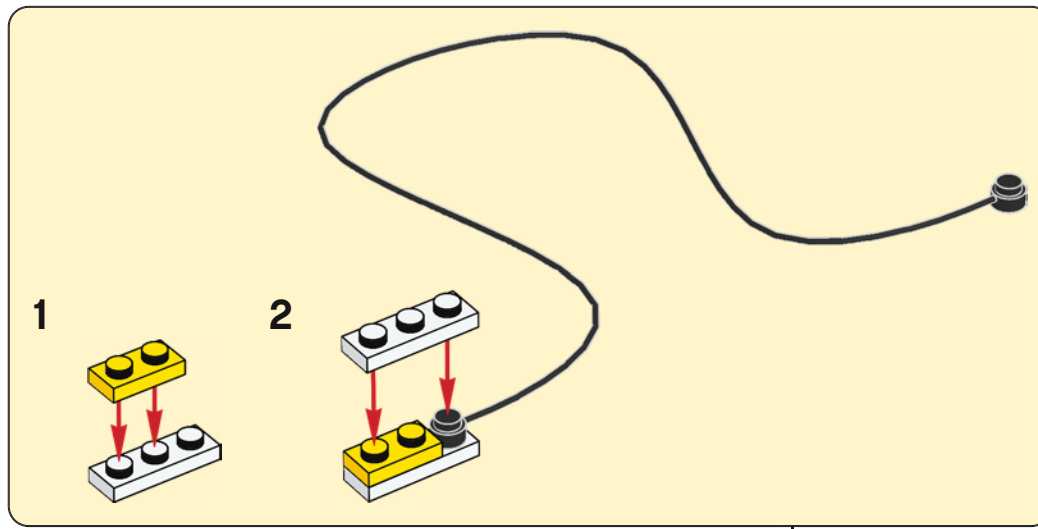

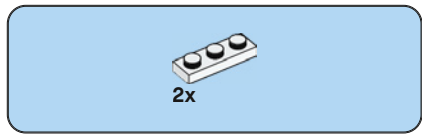

9

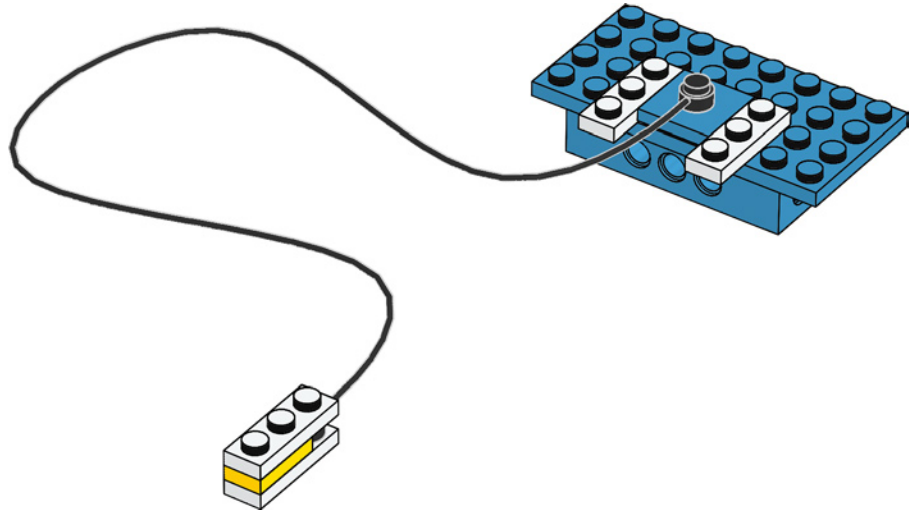

10

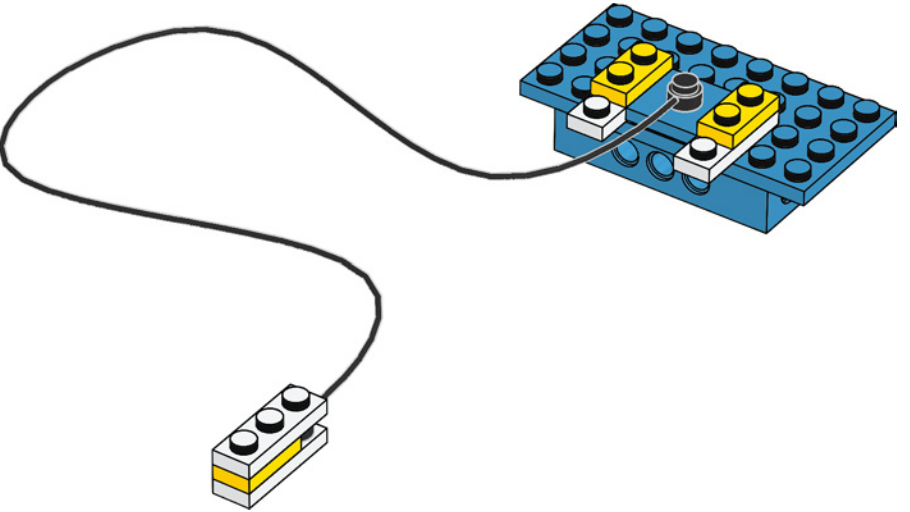

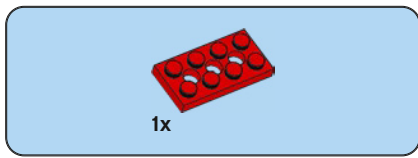

11

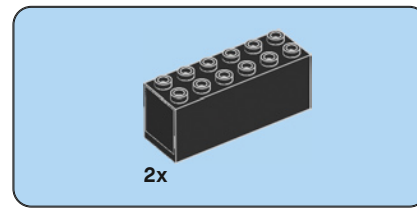
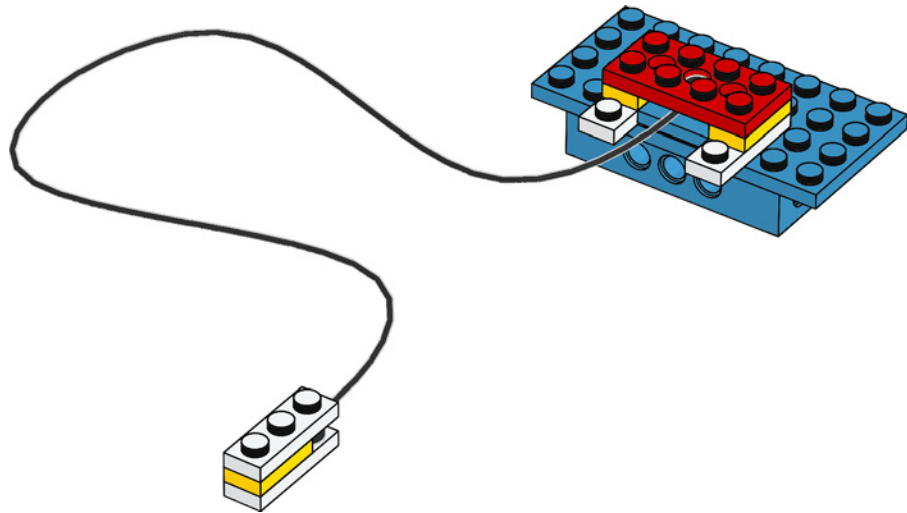

12

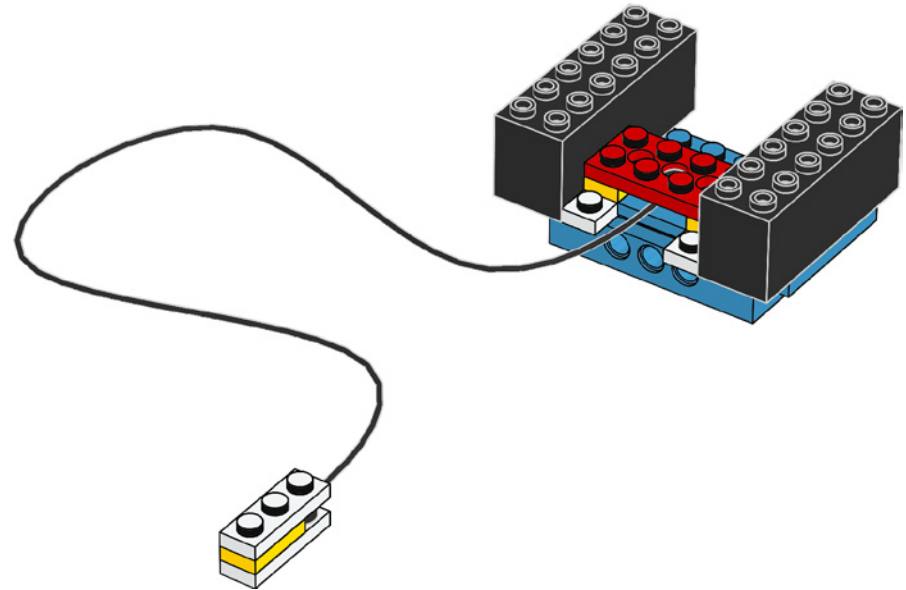

13

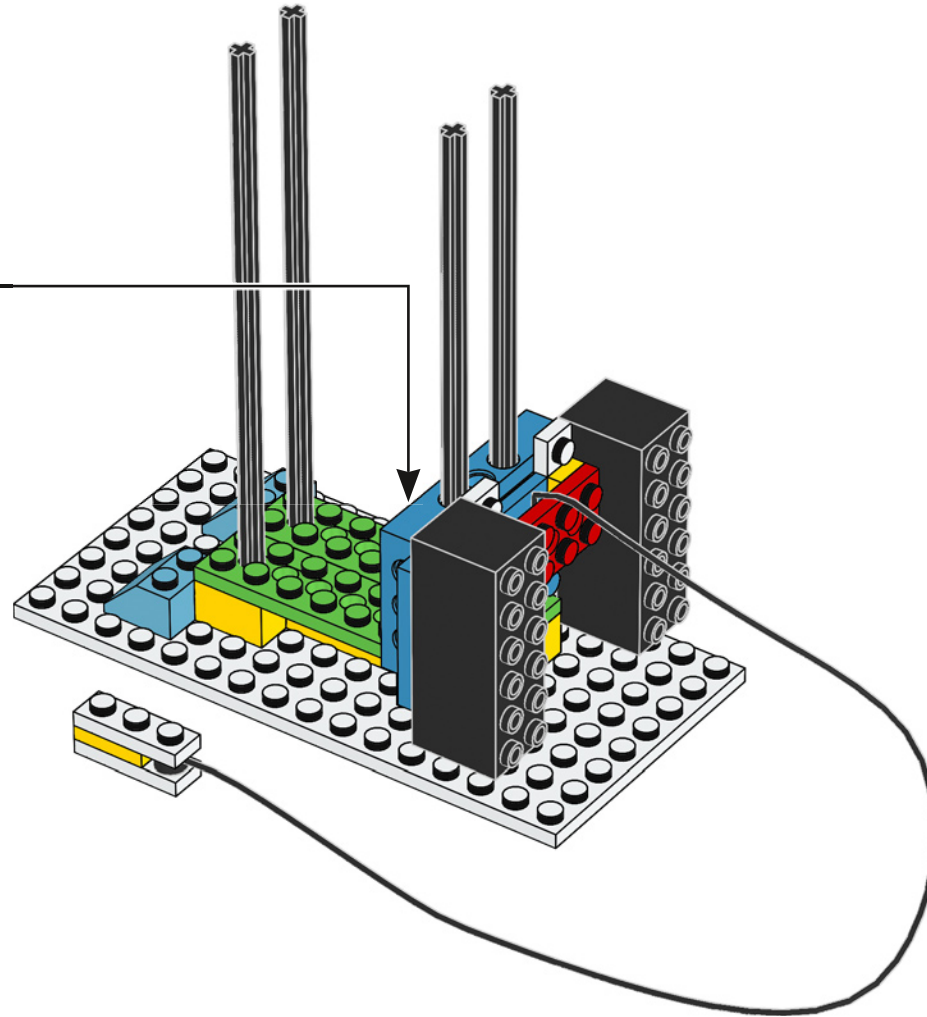

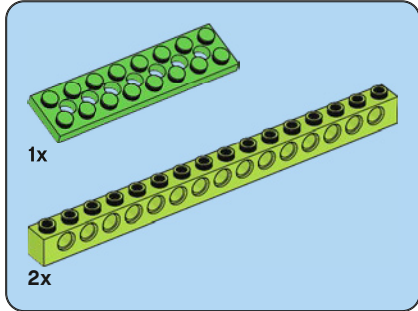
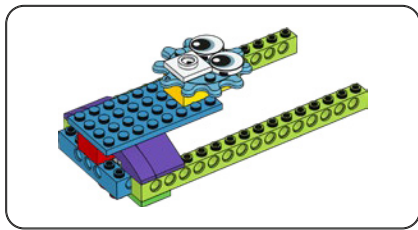

14

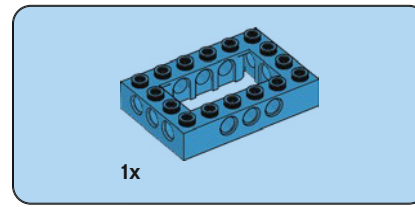
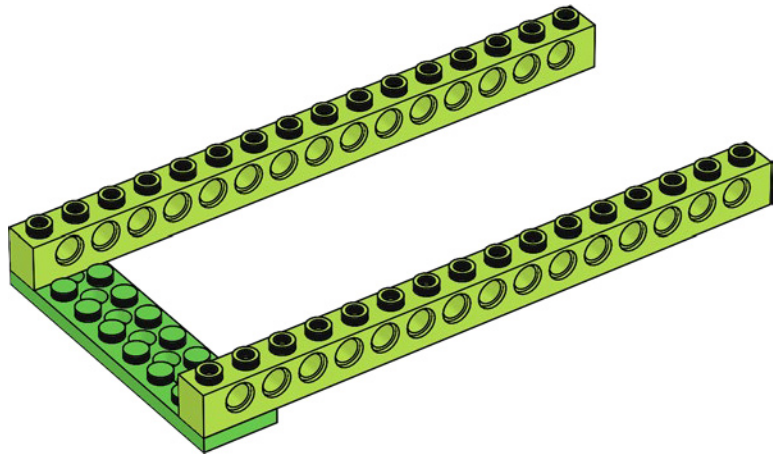

15

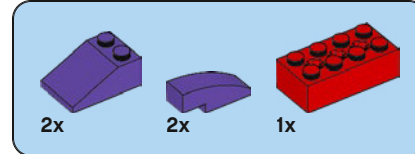
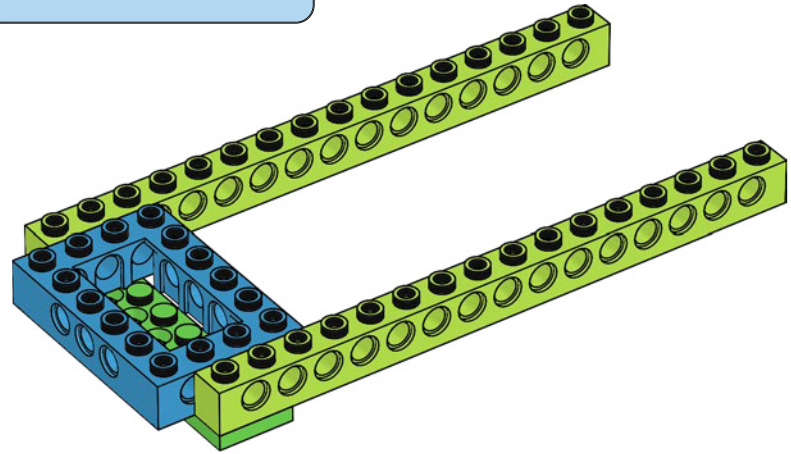

16

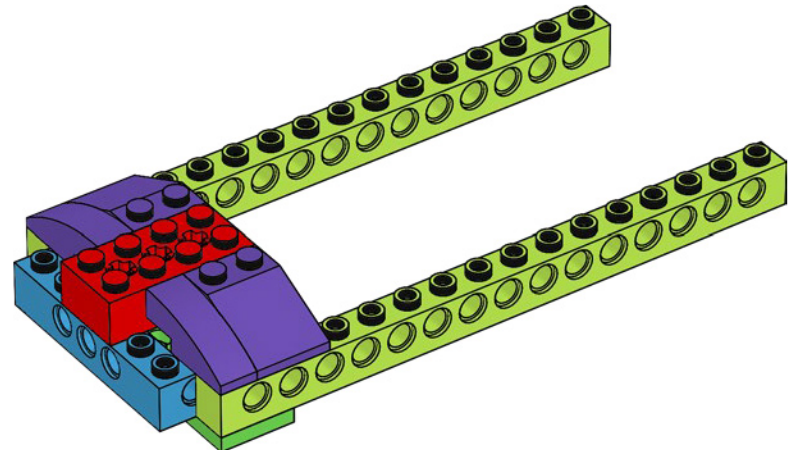

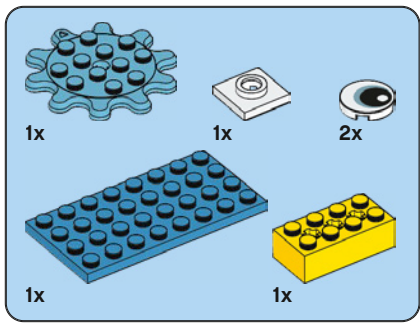

17

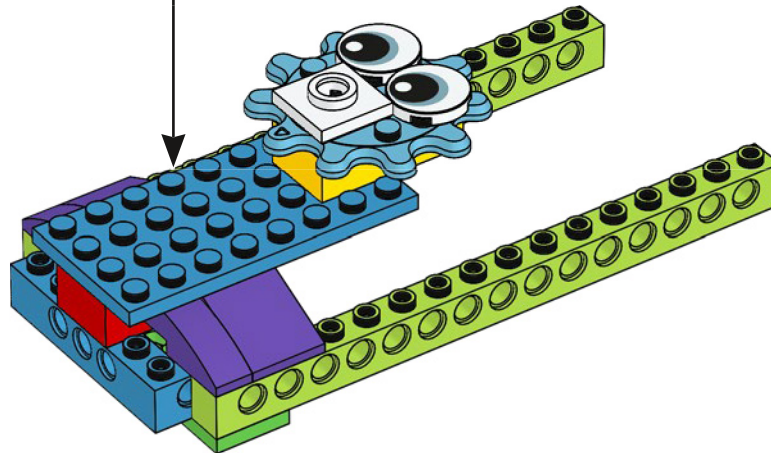
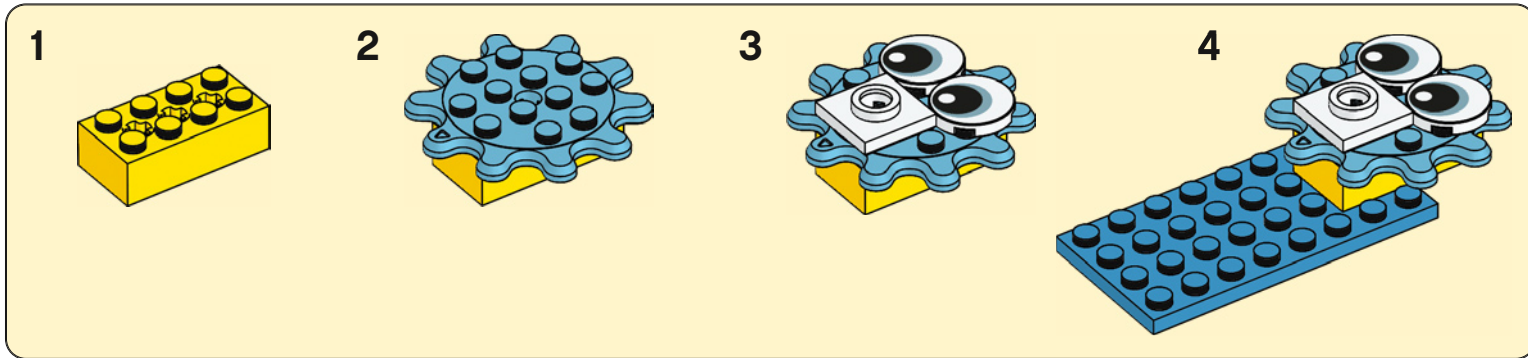

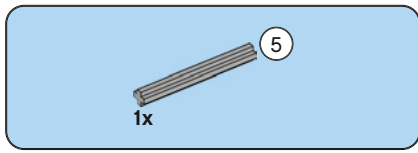

18

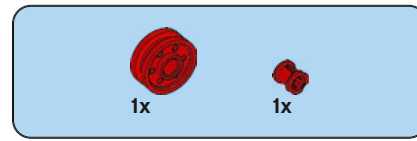
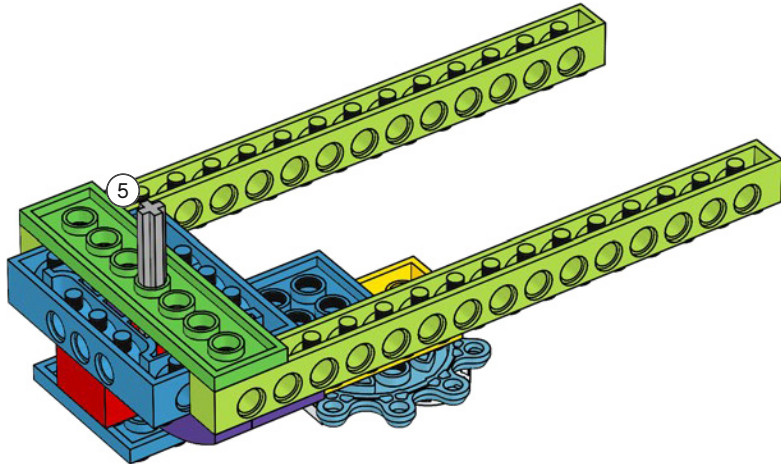

19

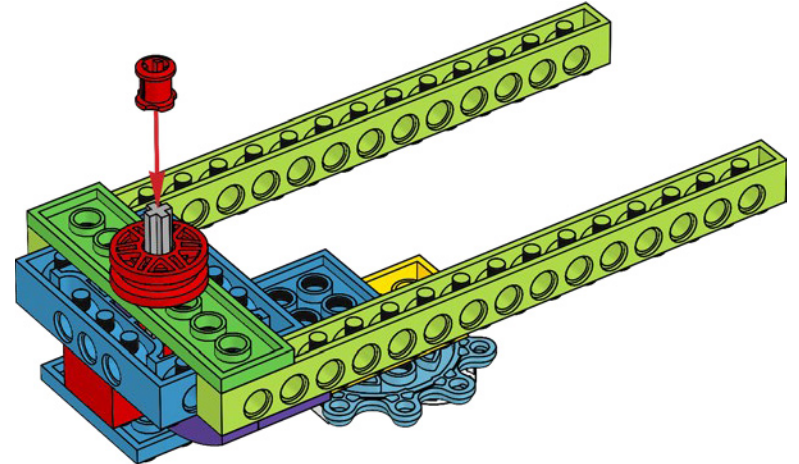

20

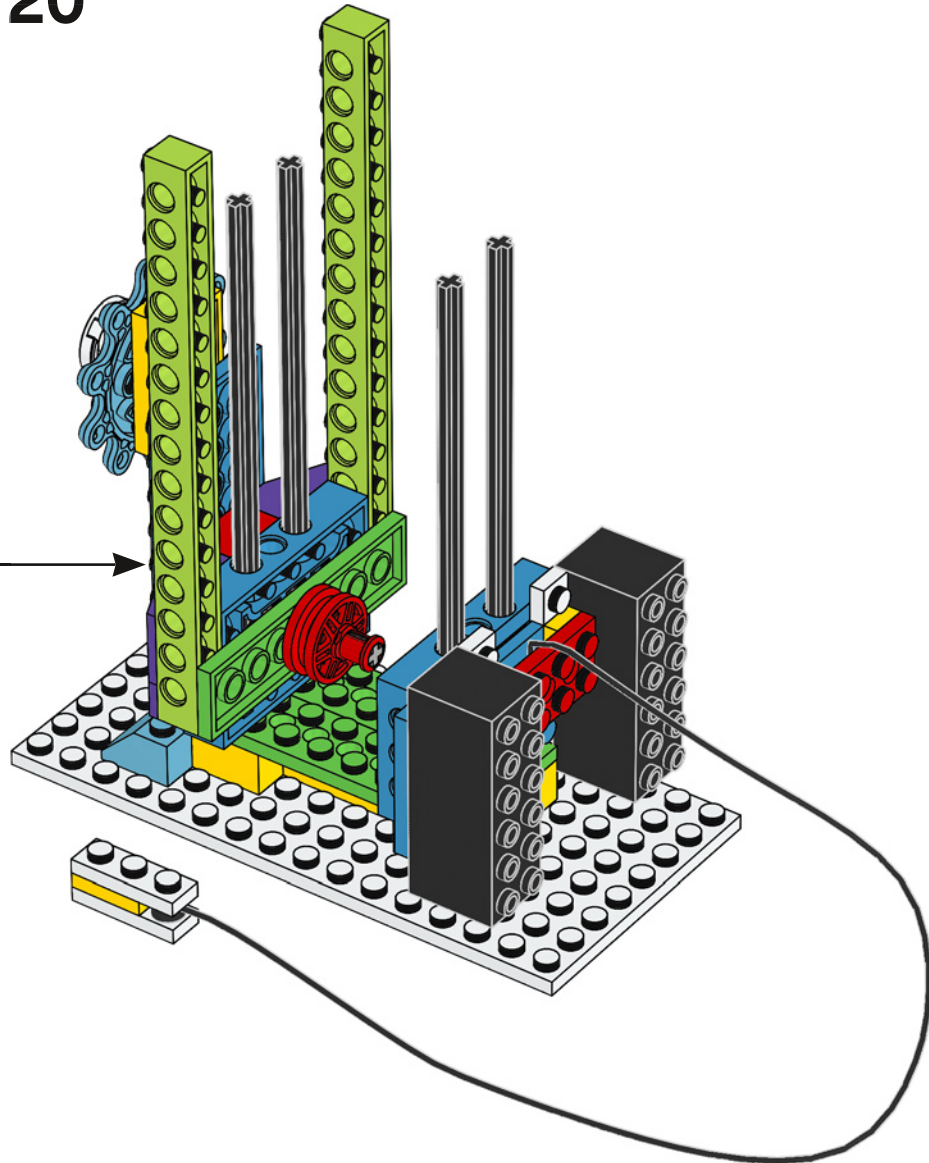

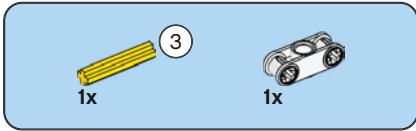
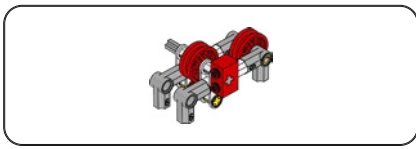

21

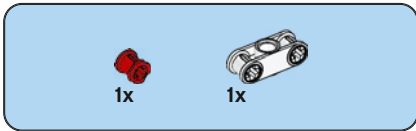
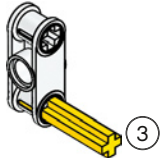

22

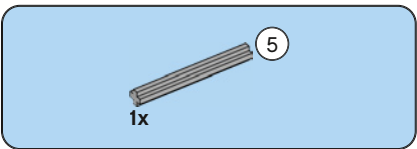
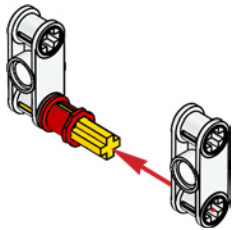

23

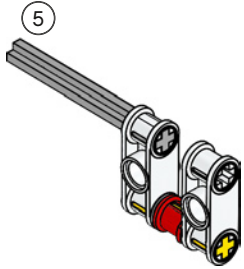

24

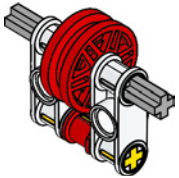

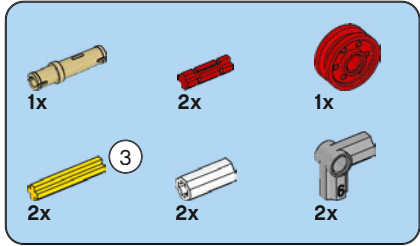
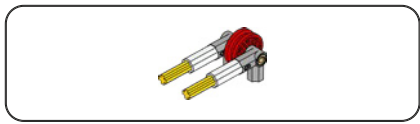

25

1

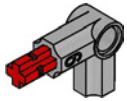

2

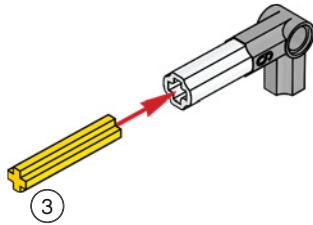

3

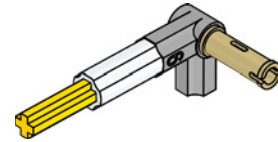

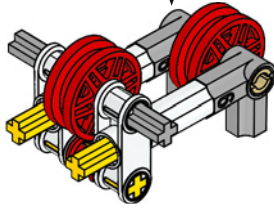
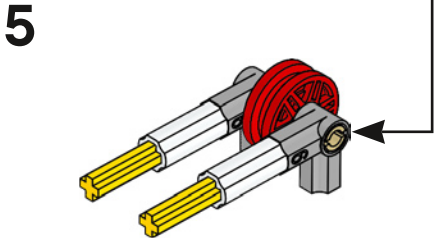
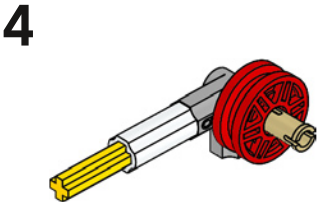
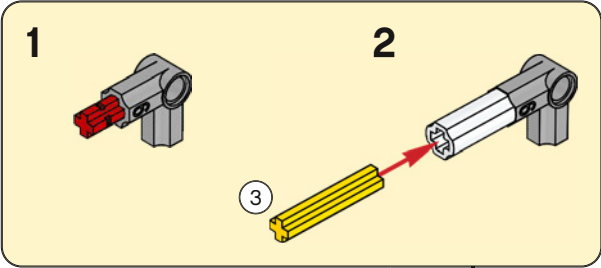



2x

26

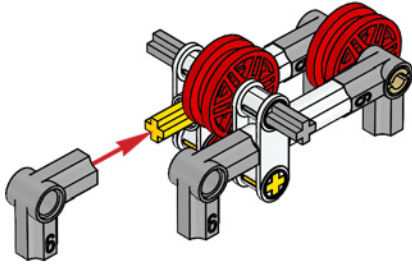

1x

27

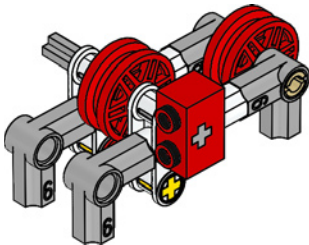

28

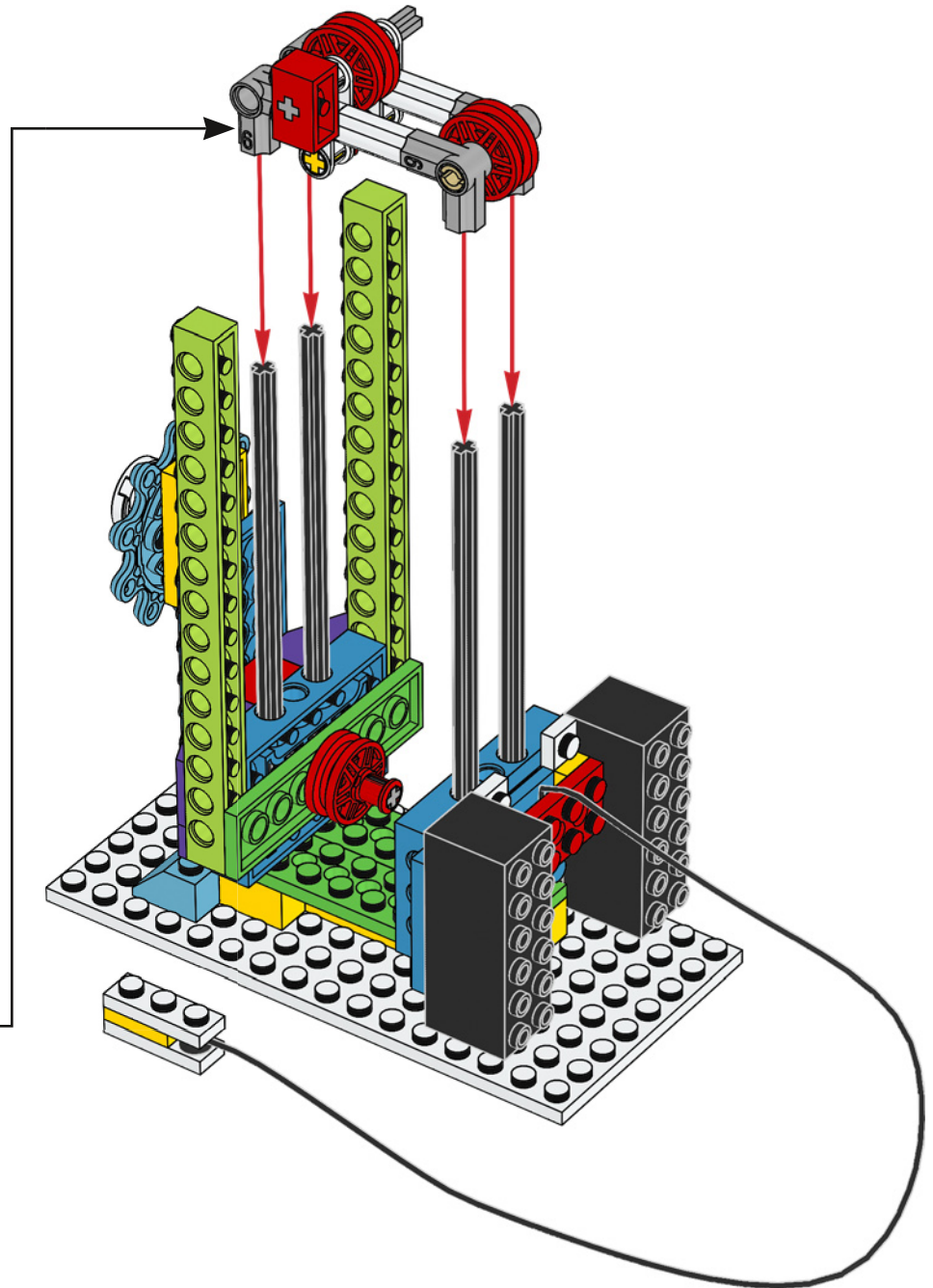

29

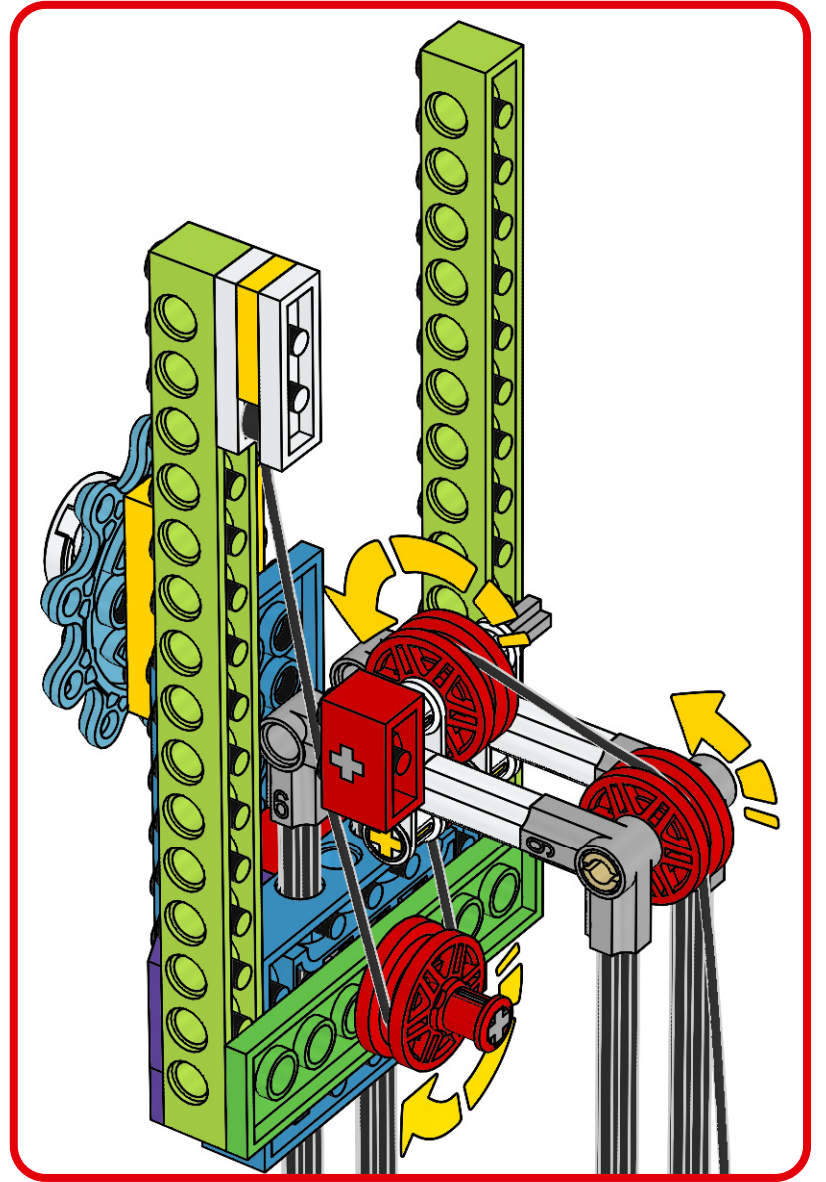
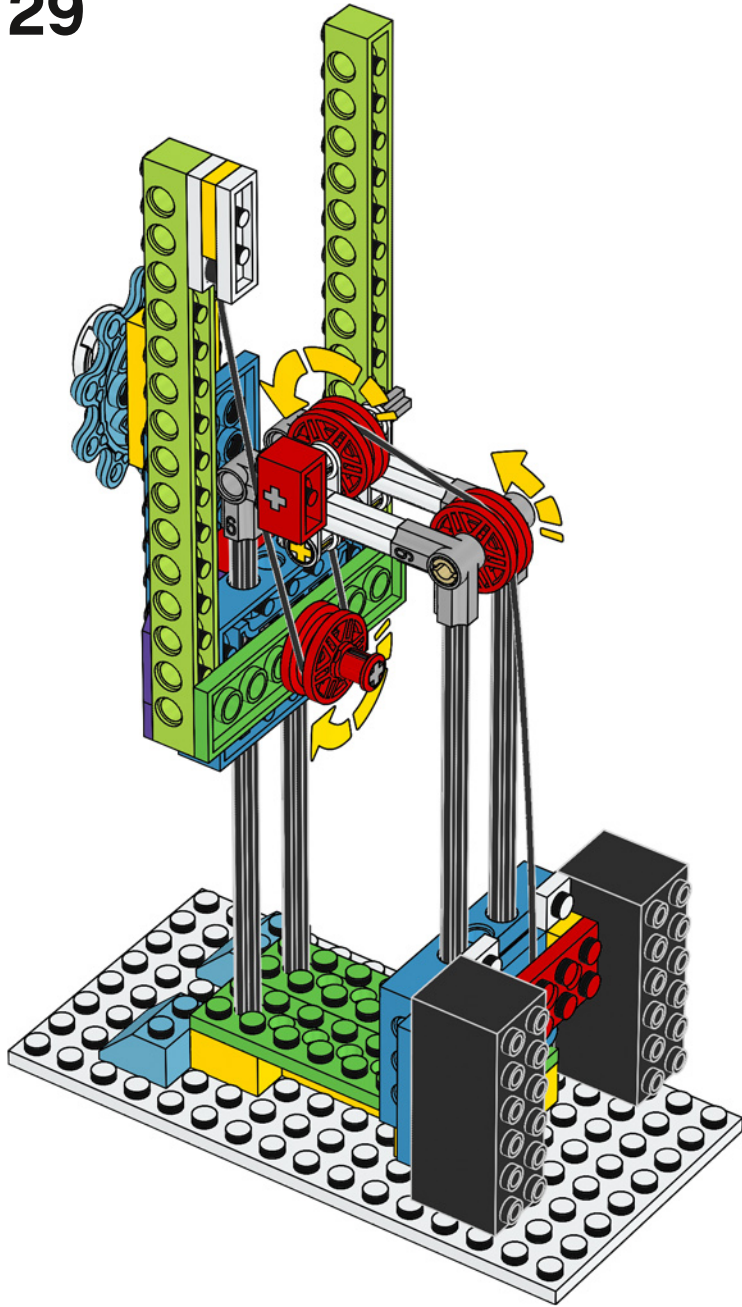

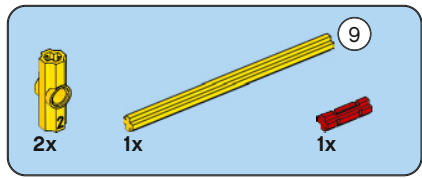

30

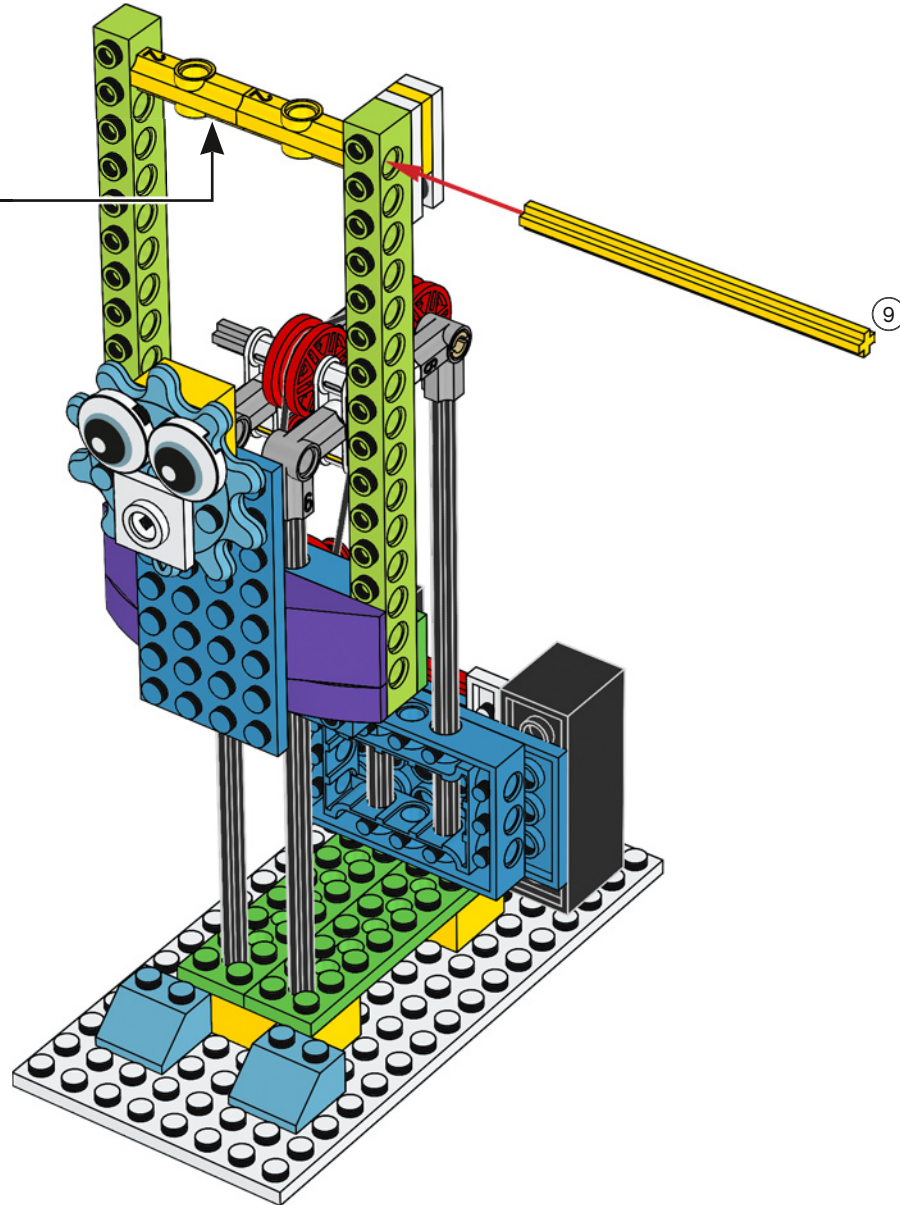
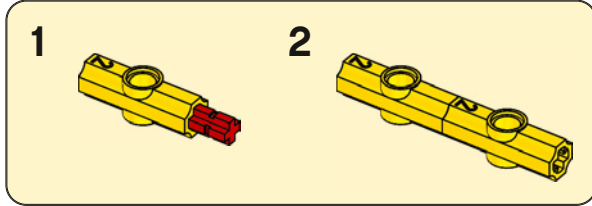

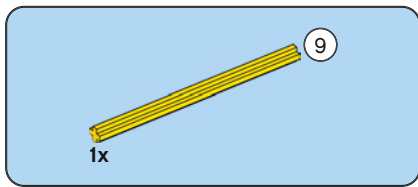

31

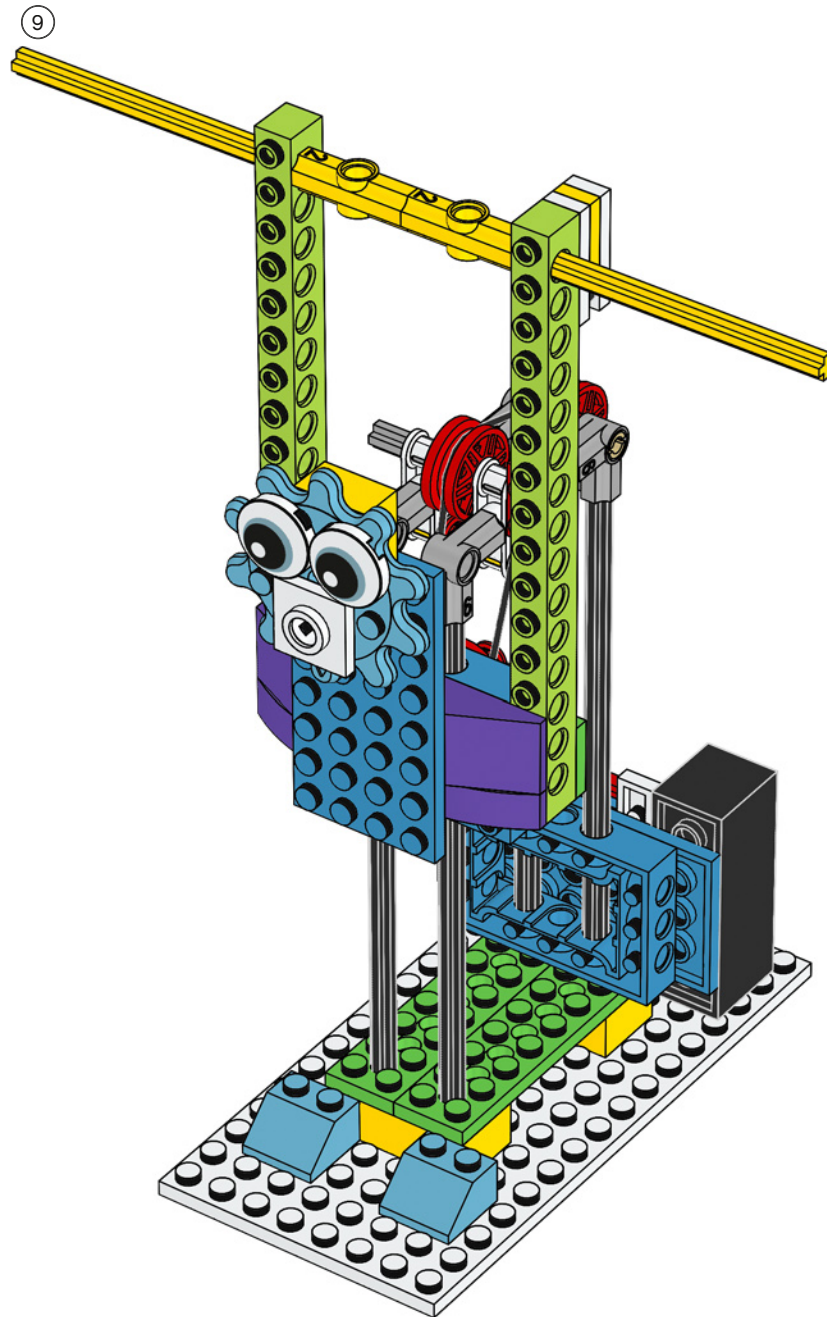

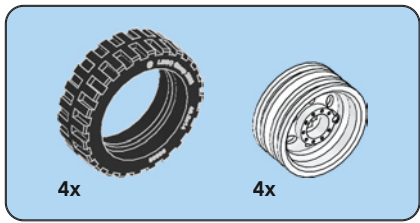

32

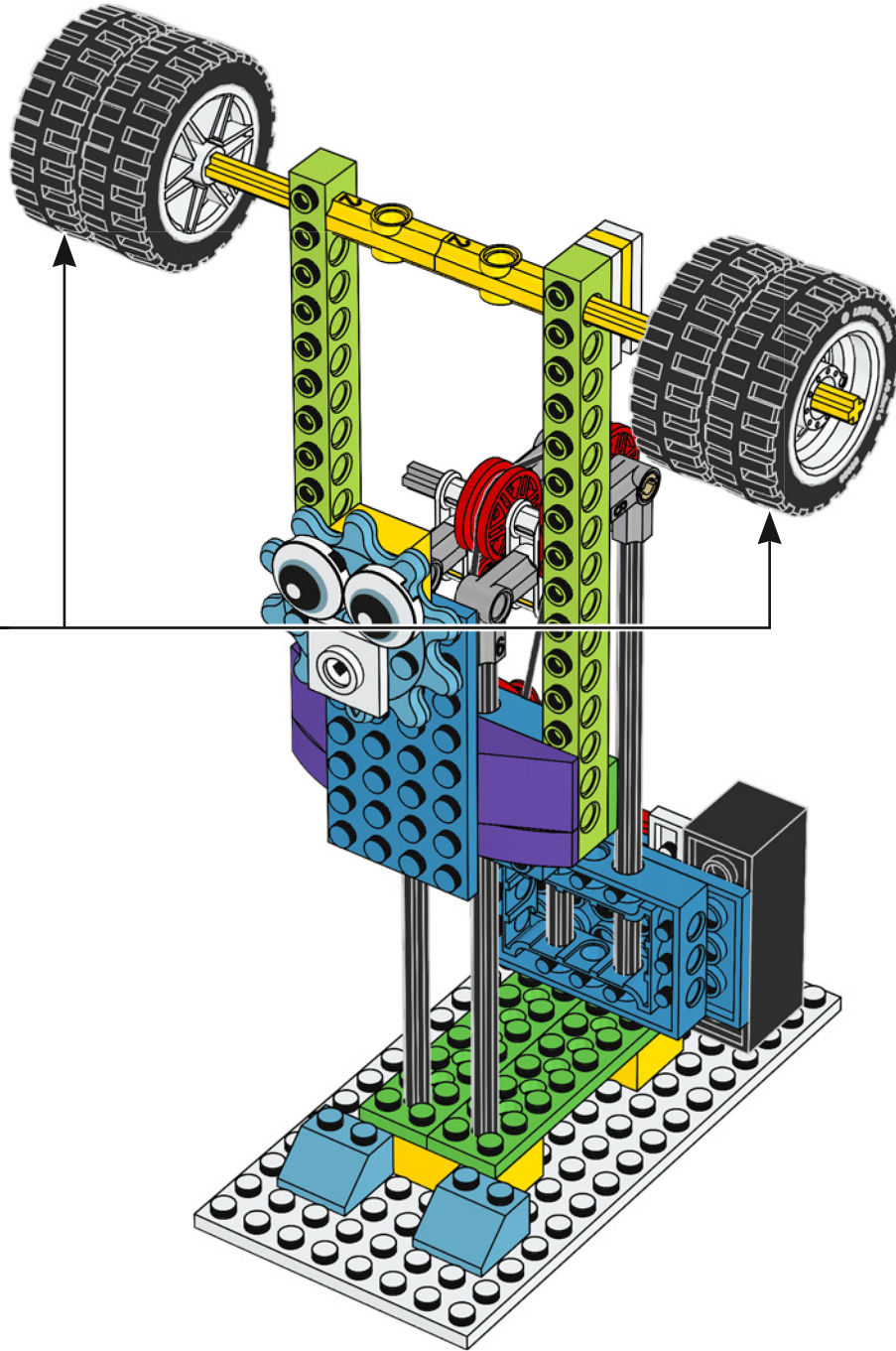
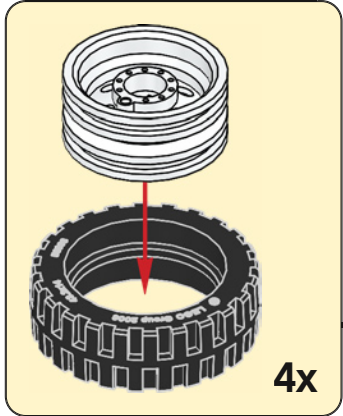

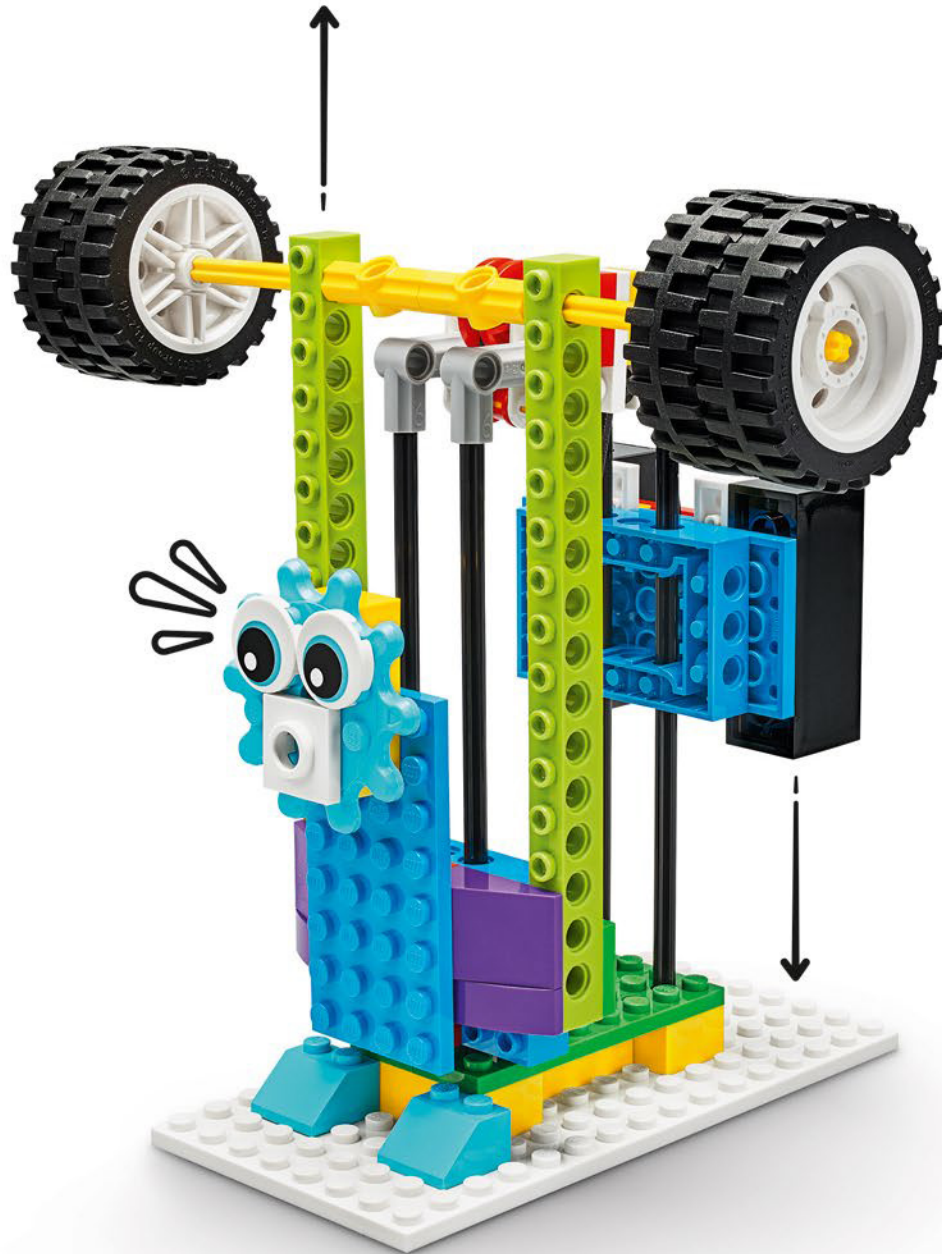

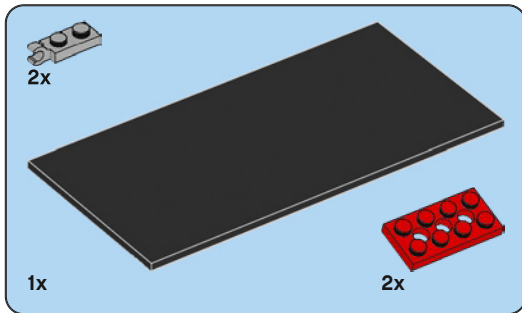
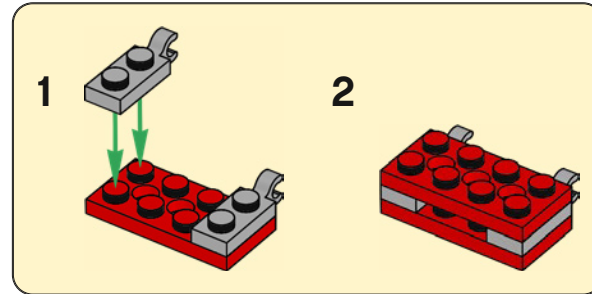
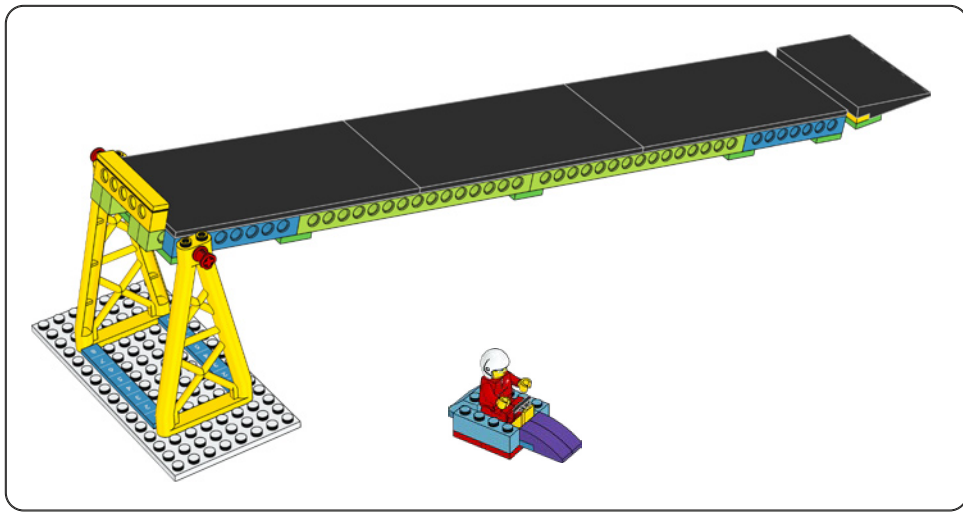

1

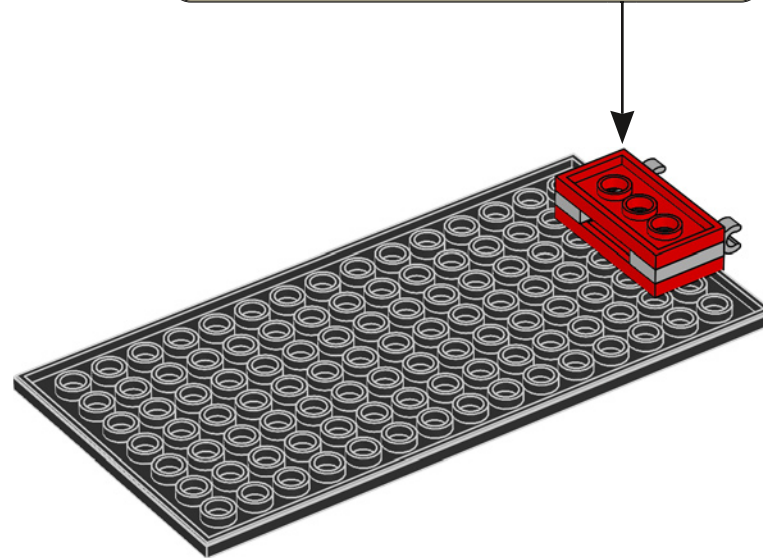

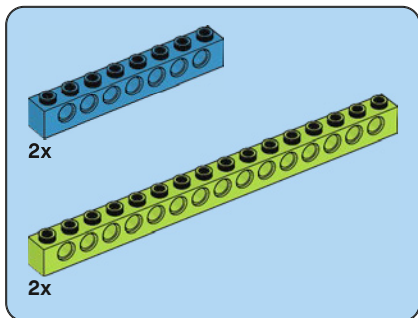

2

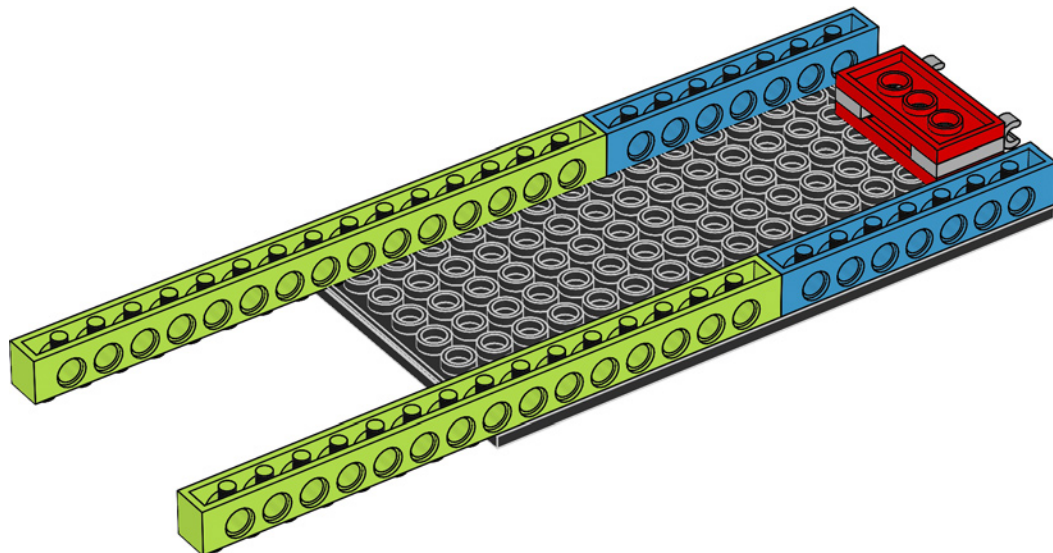

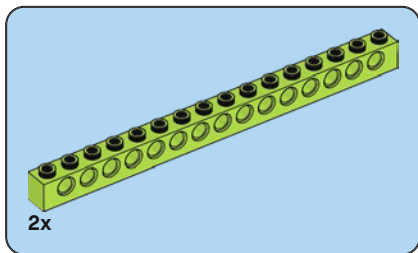

4

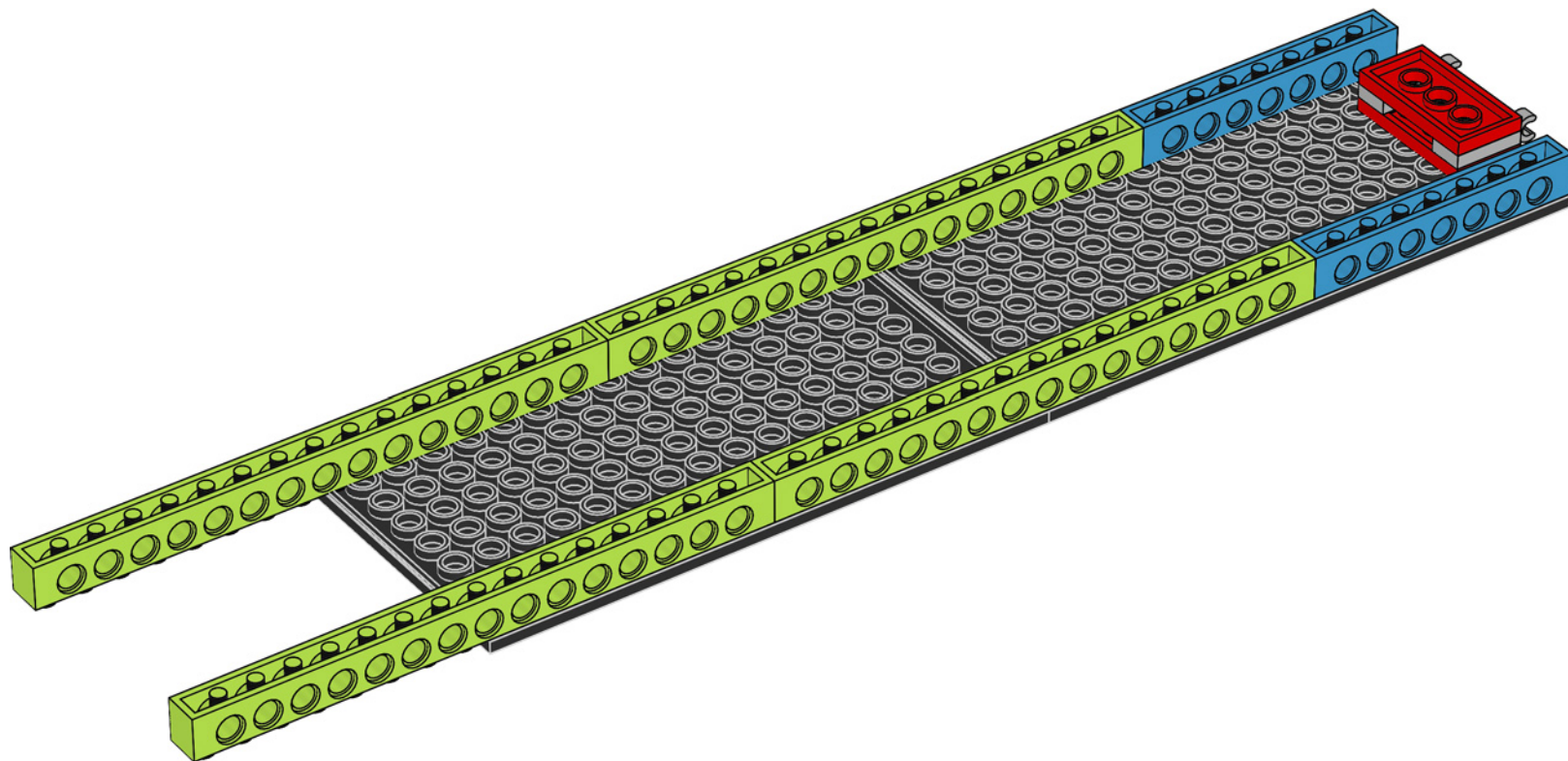

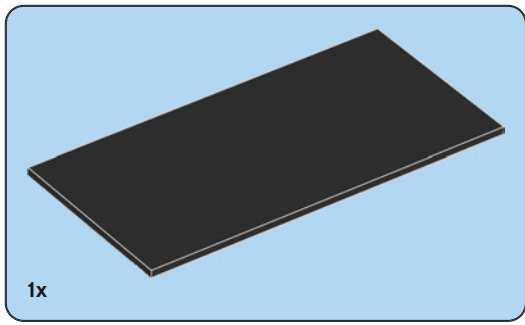

5

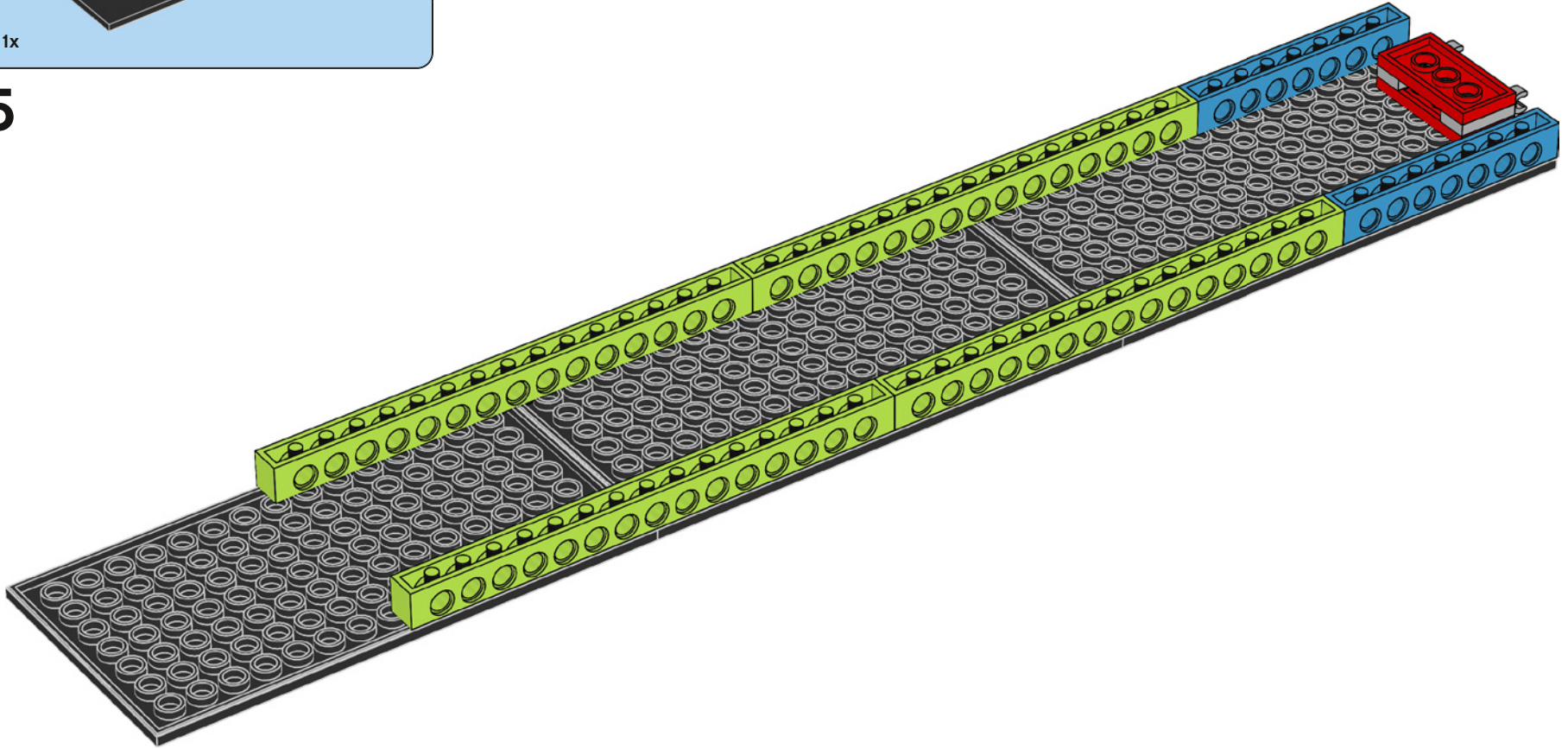

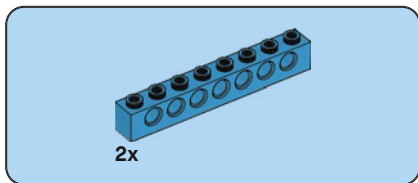

6

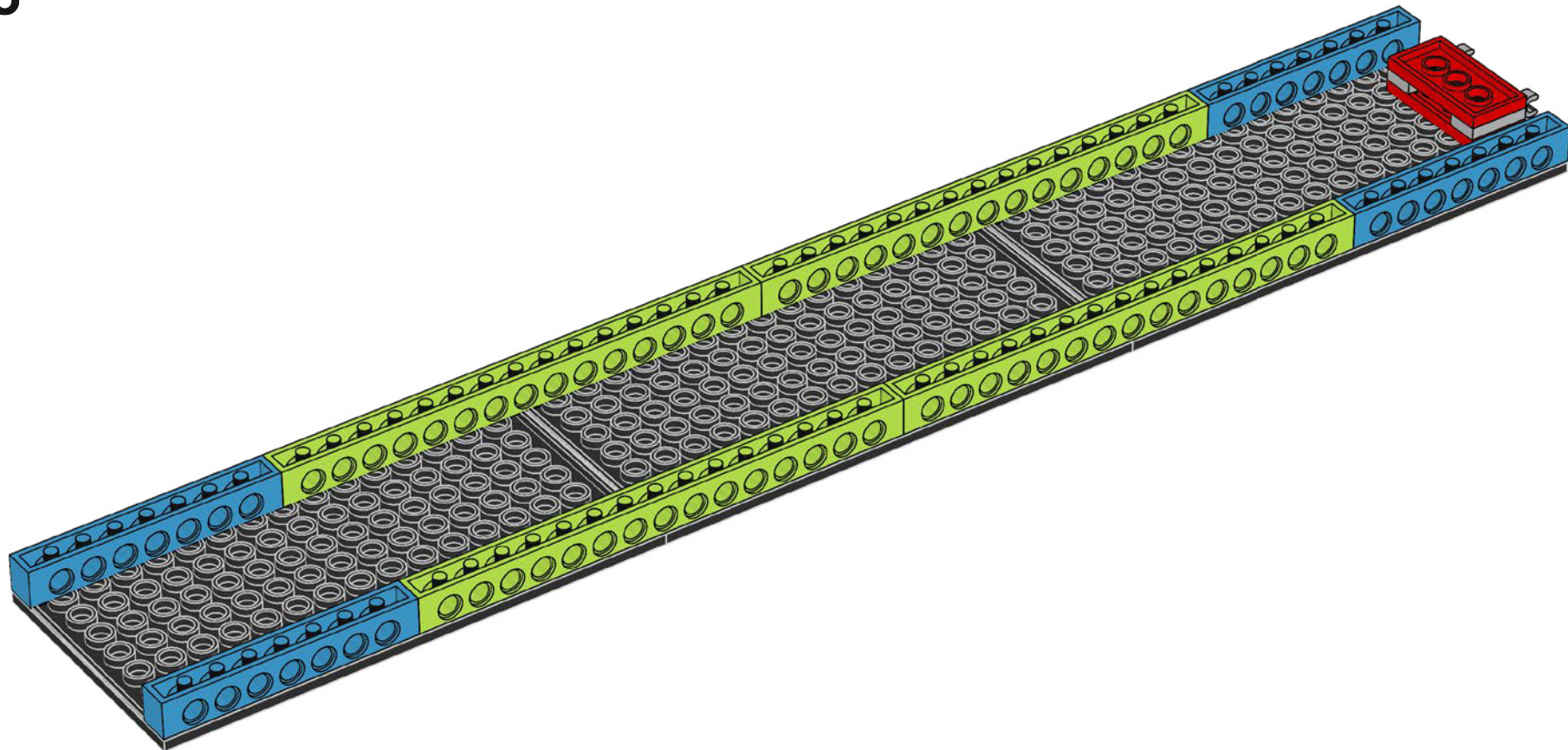

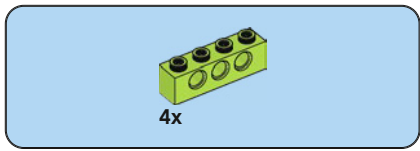

7

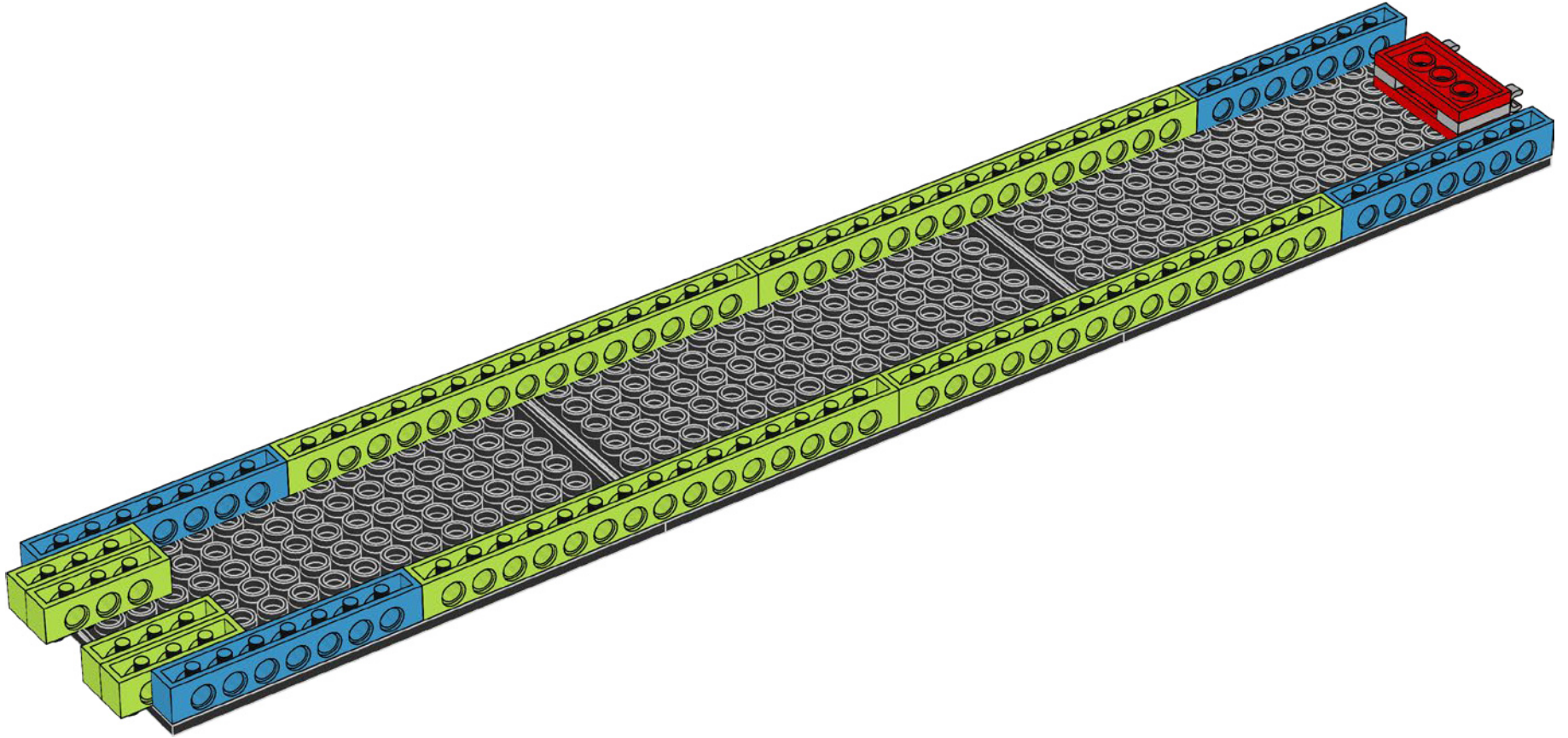

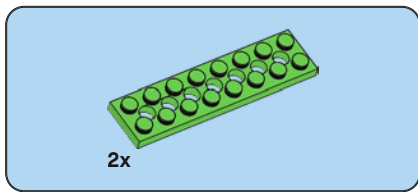

8

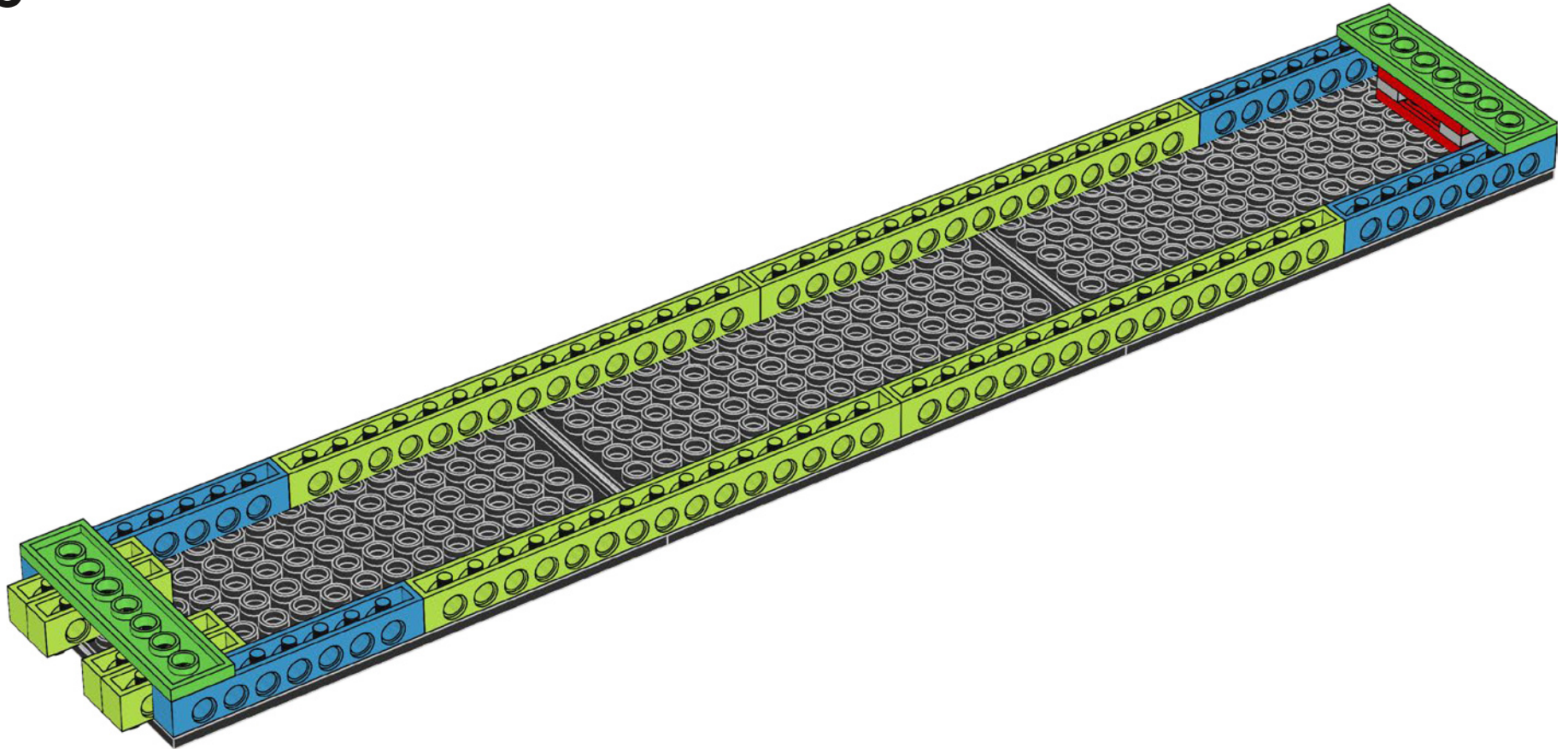

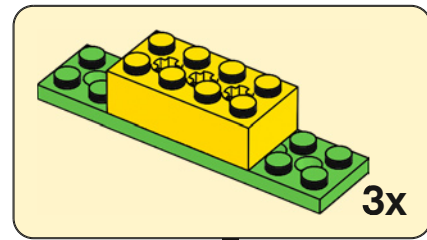
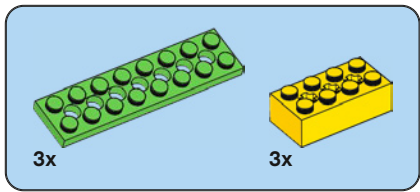

9

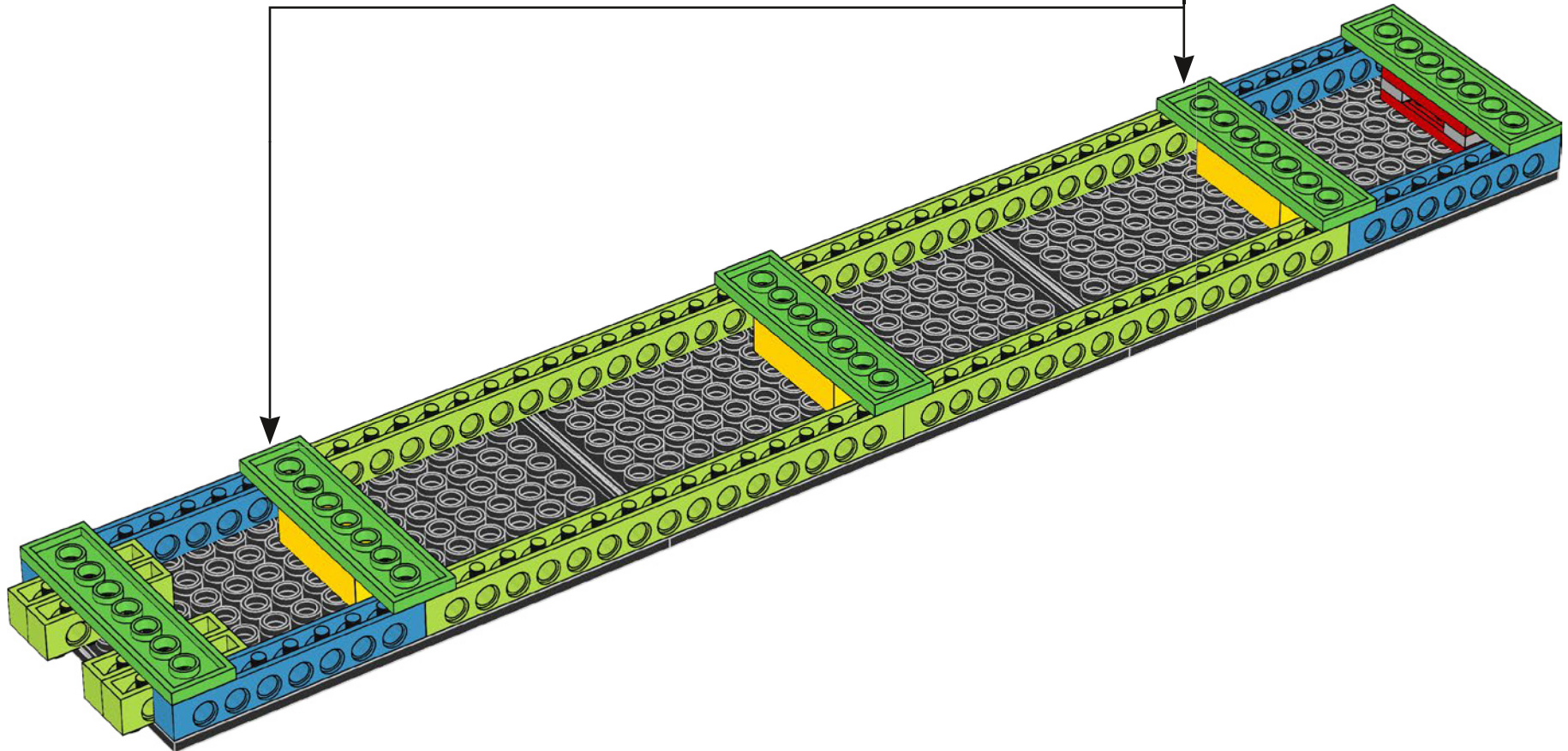

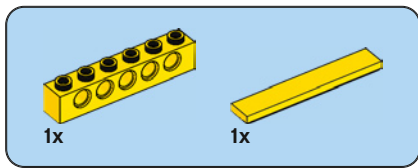

10

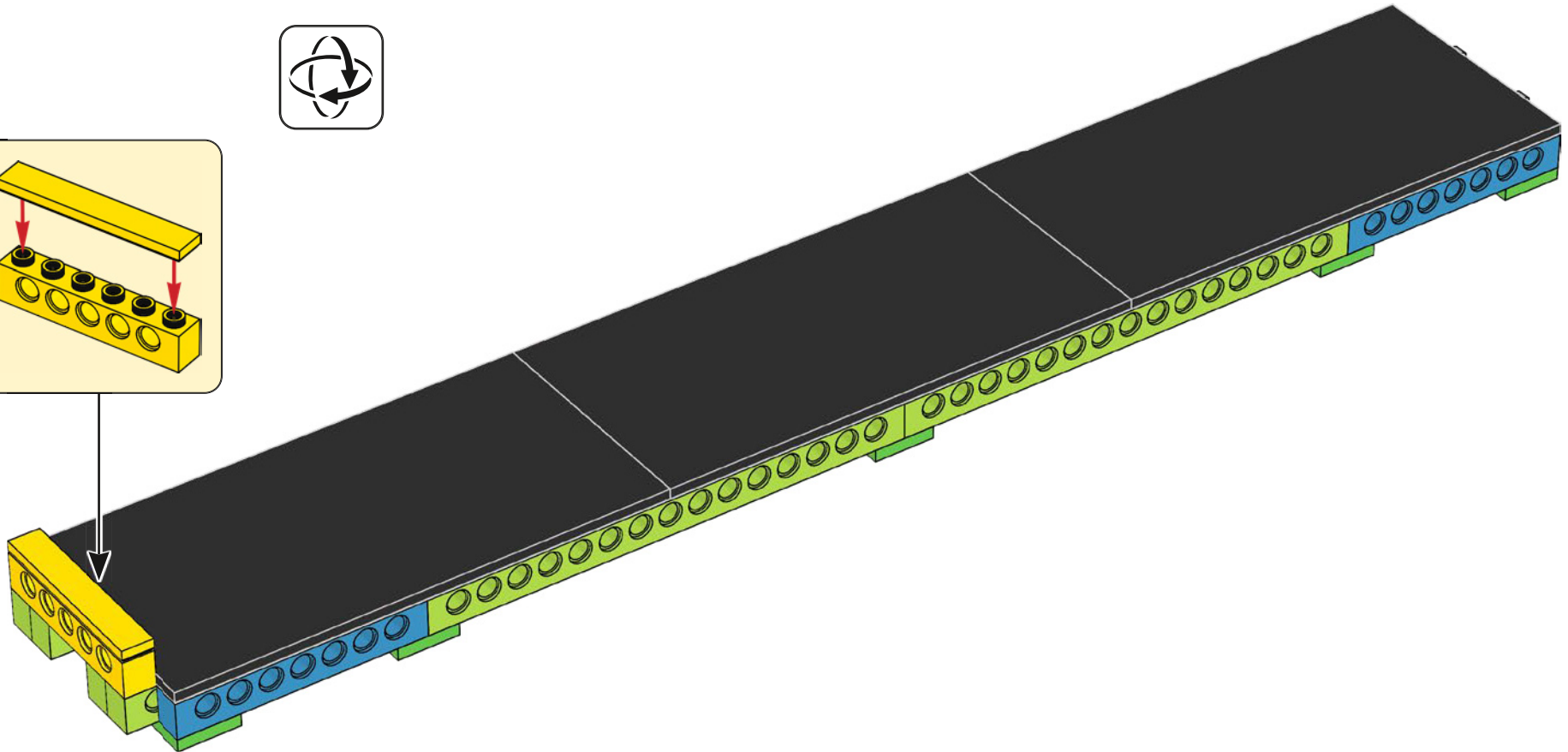
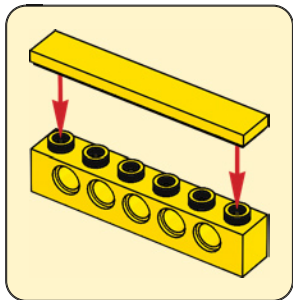

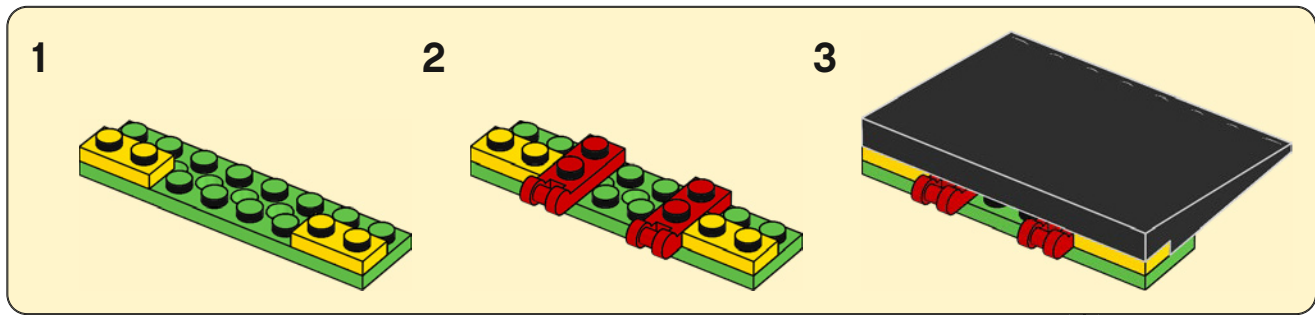
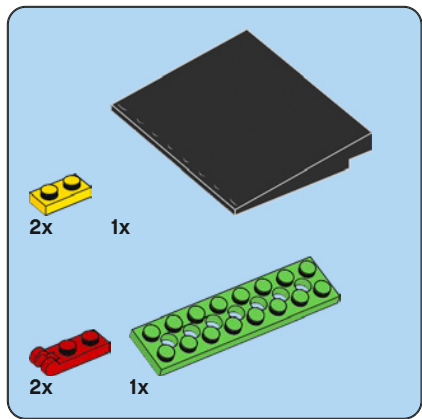

11

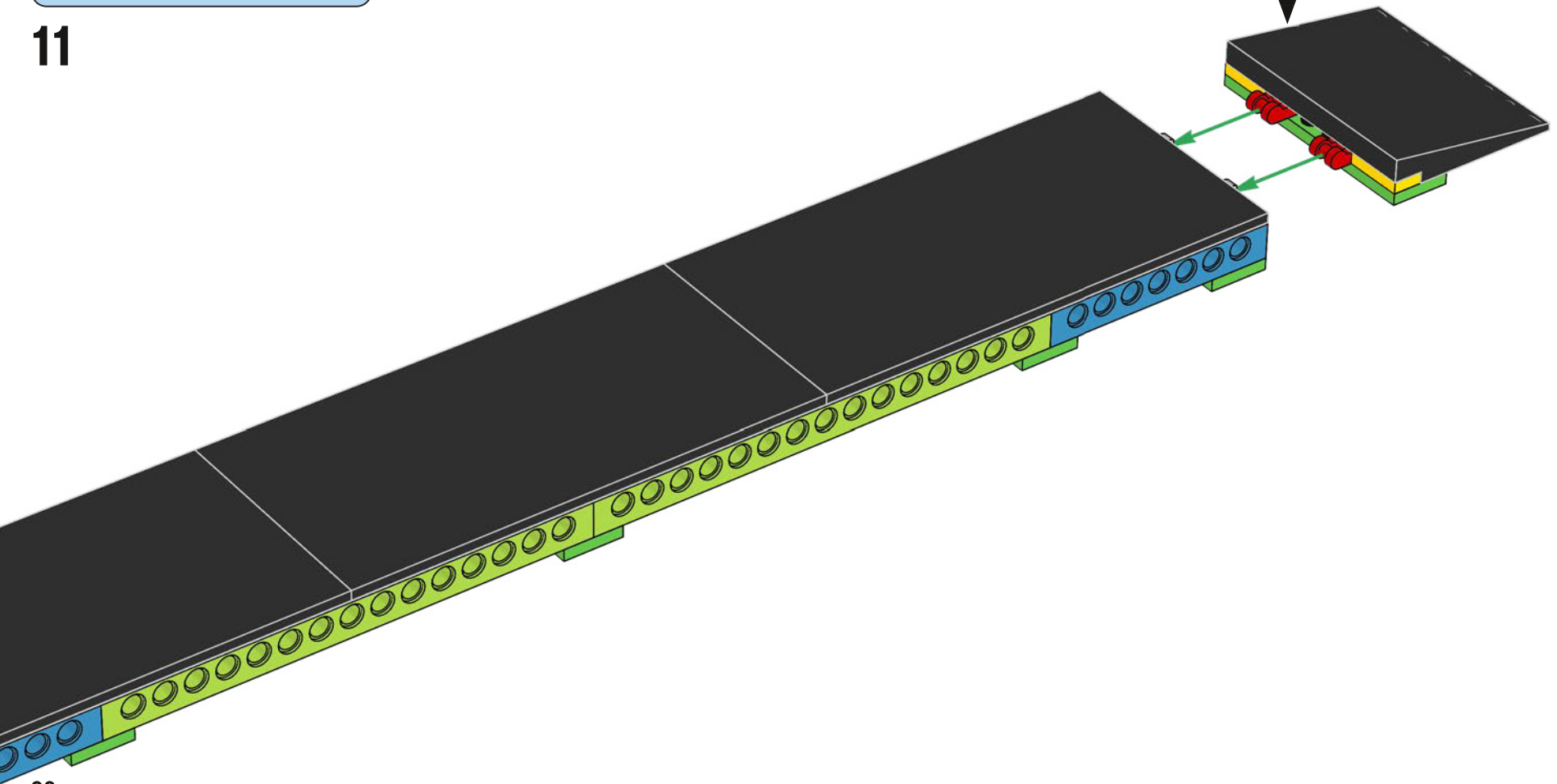

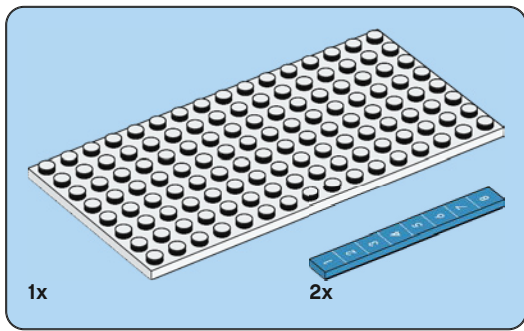

12

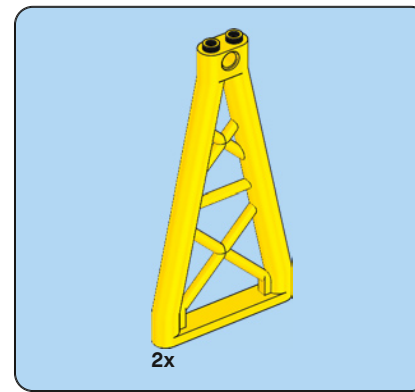
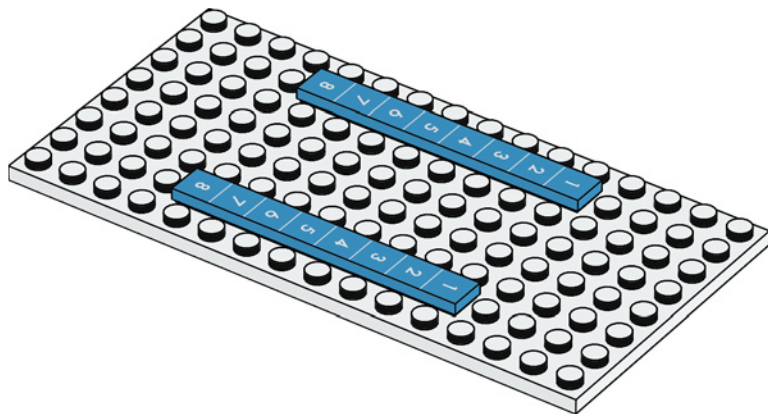

13

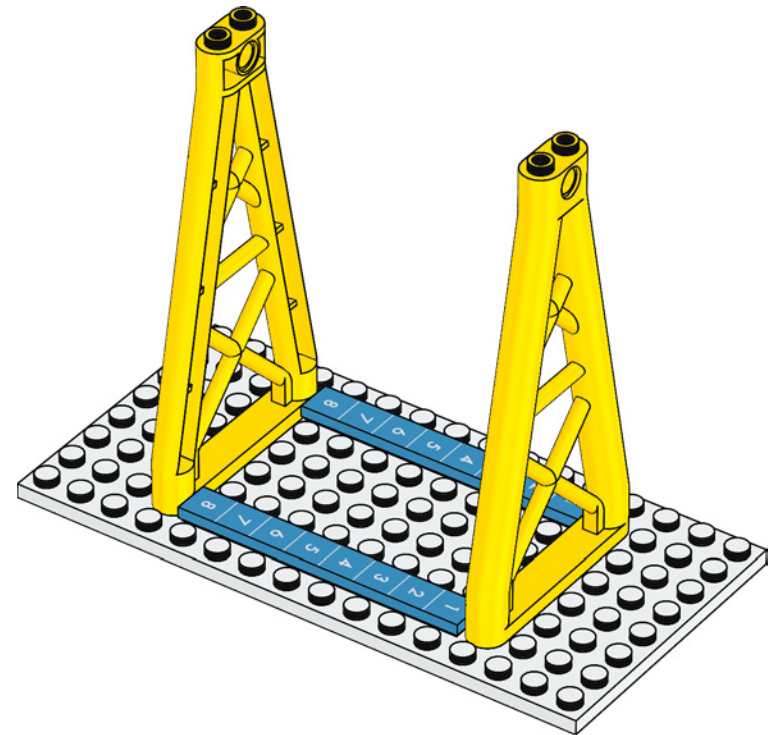

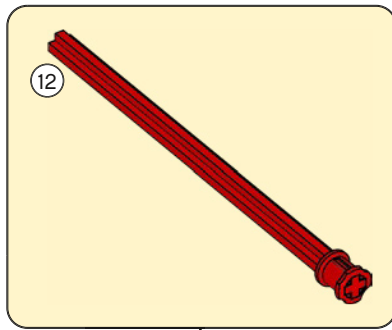
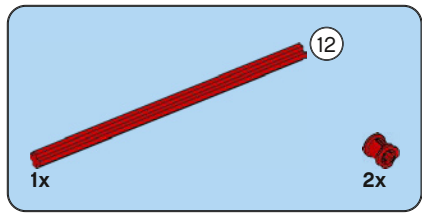

14

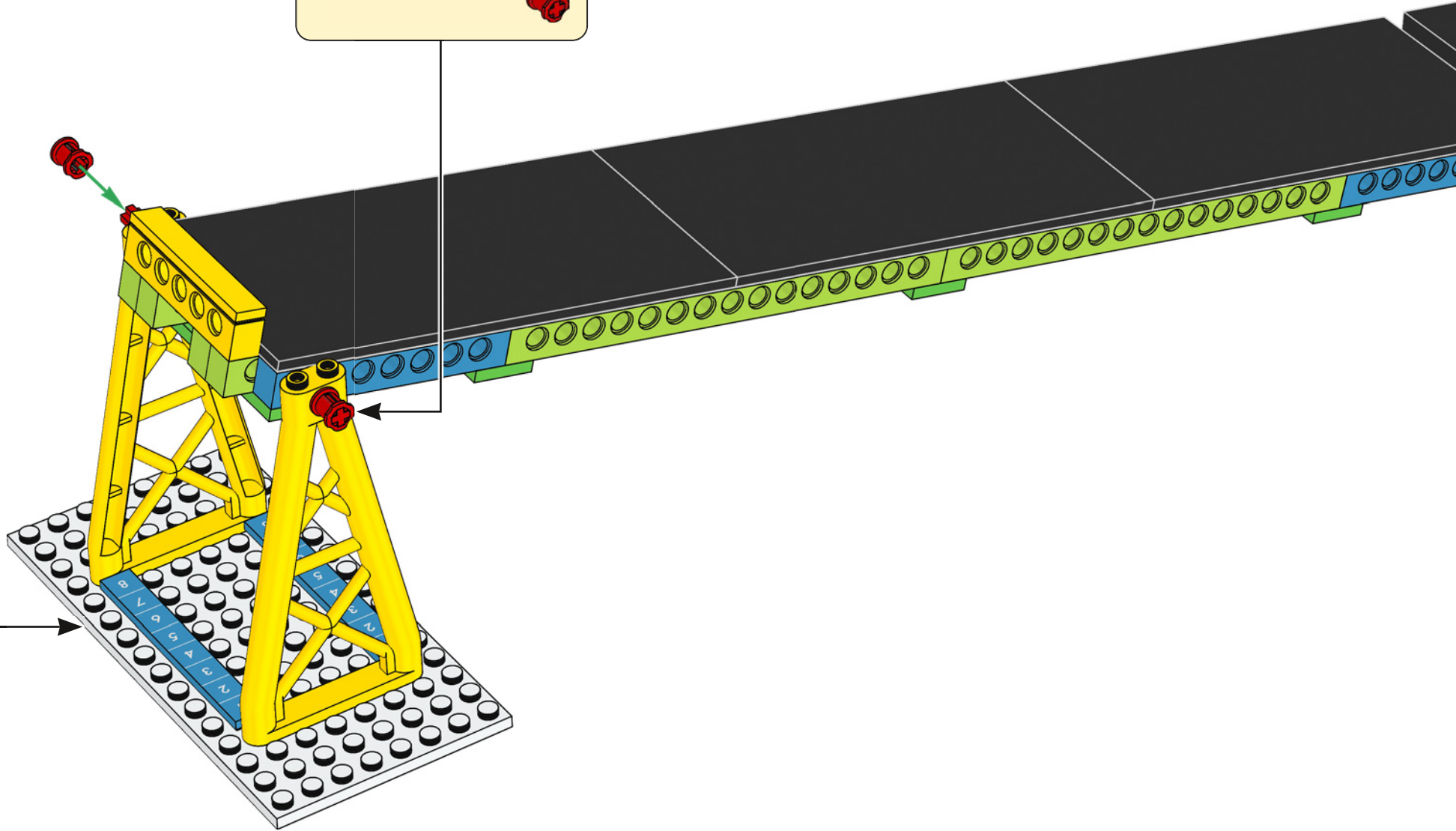

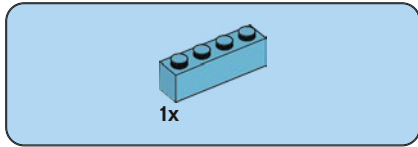
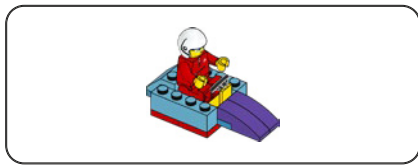

15

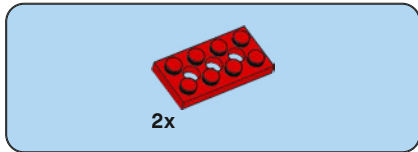
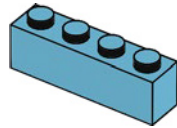

16

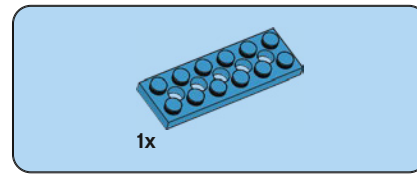
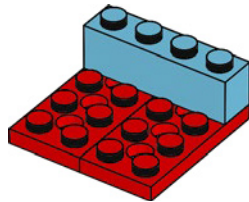

17

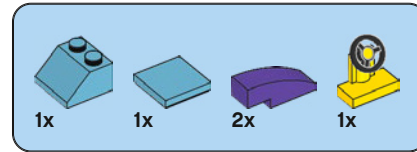
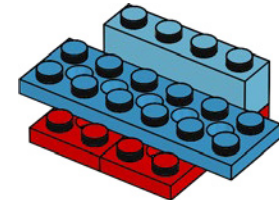

18

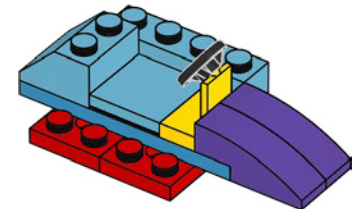

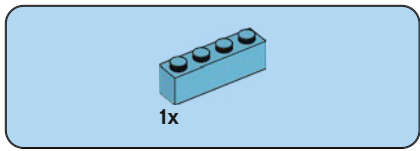

19

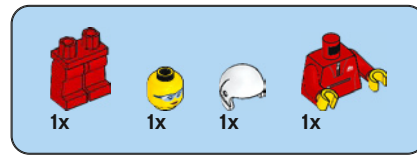
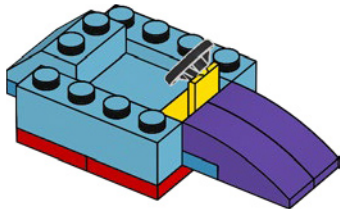

20

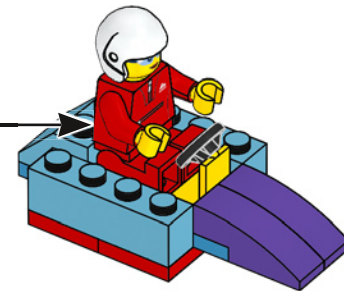
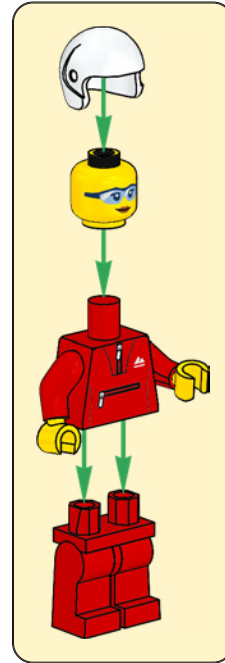

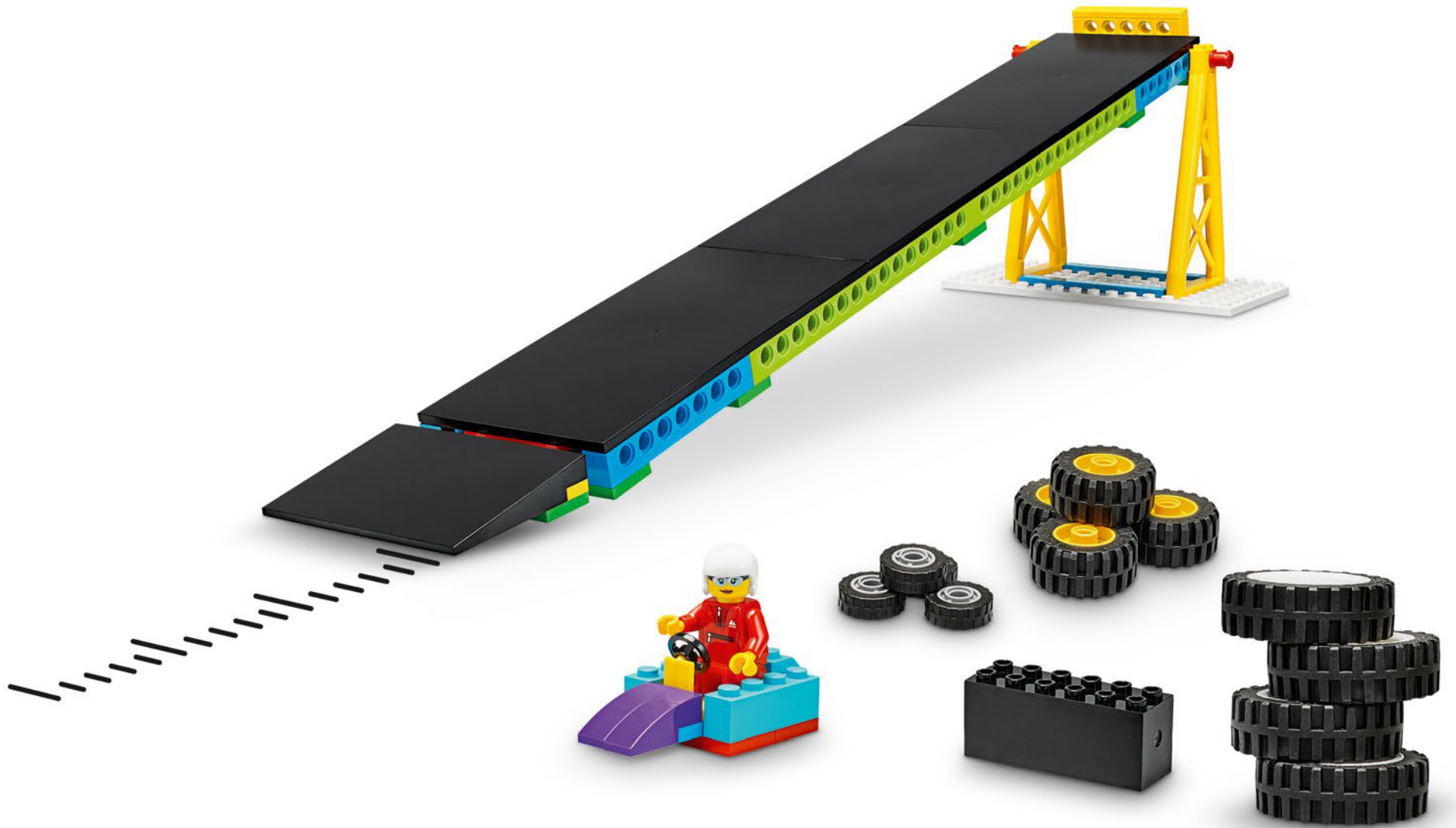

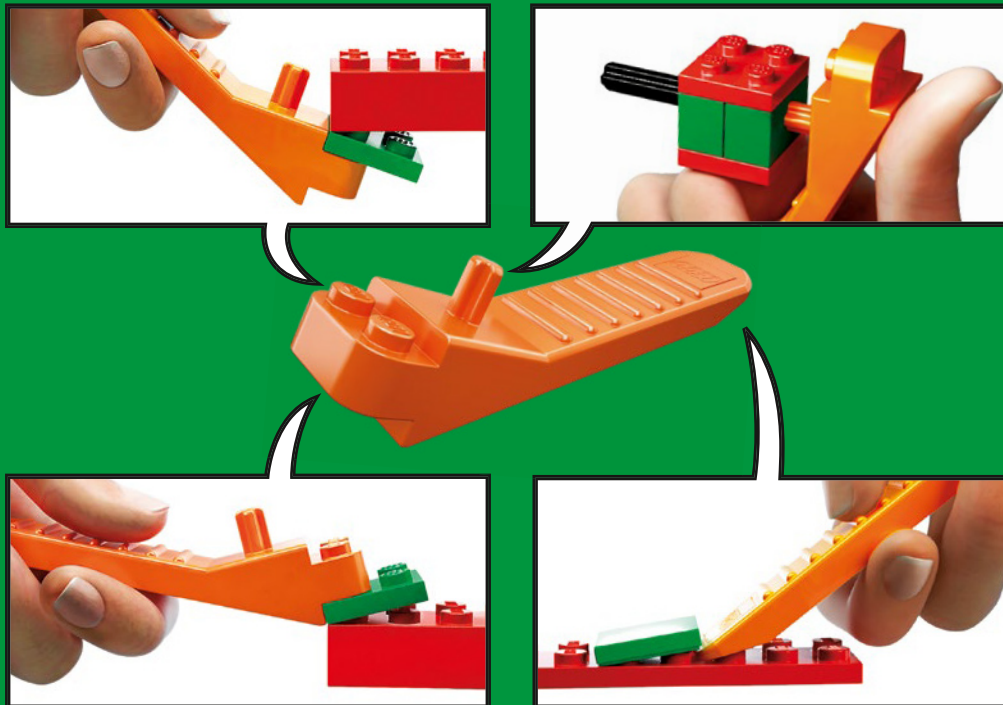

LEGO.com/brickseparator

LEGO.com/service

LEGO and the LEGO logo are trademarks of the LEGO Group. ©2021 The LEGO Group. 6365545