



# BRICK 'HEADZ

41621



Harry Potter

RON WEASLEY™

60



[LEGO.com/brickheadz](https://www.LEGO.com/brickheadz)

1



2



3



4



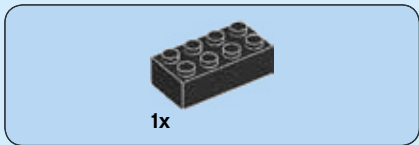

1

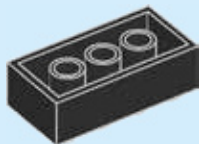



1x



2x

2

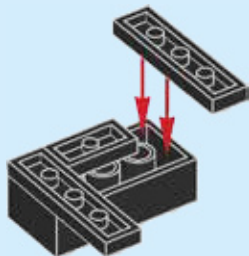

4



2x



1x

3

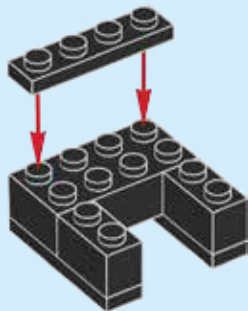
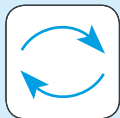



1x



1x

4

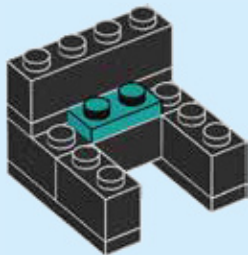

6

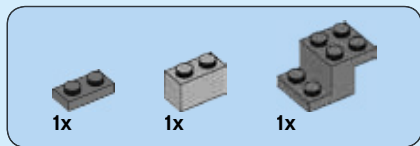

5

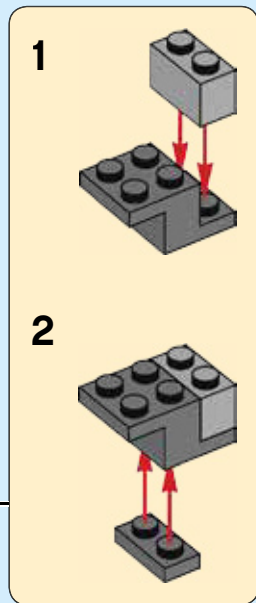
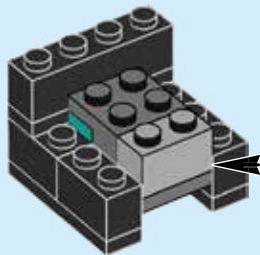



2x

6

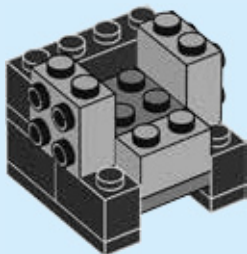

8





7

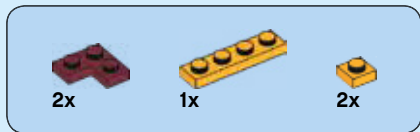
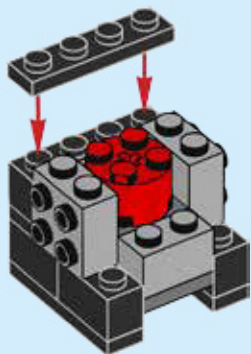

8

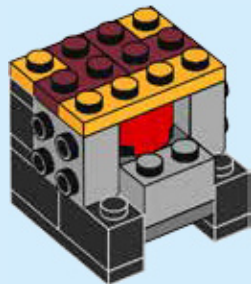



2x



1x

9

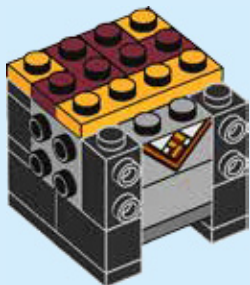

10



1x



2x



2x

# 10



1x



2x

# 11

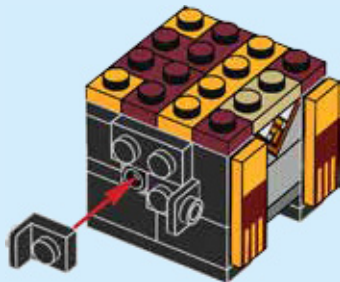



1x



2x

# 12

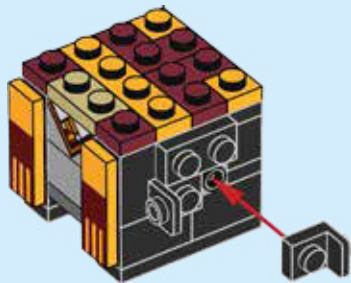
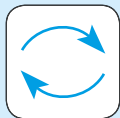

12



13

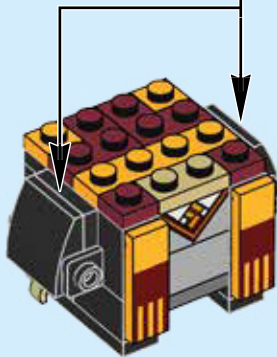
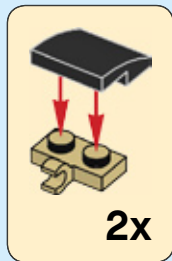
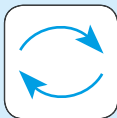



6x

14

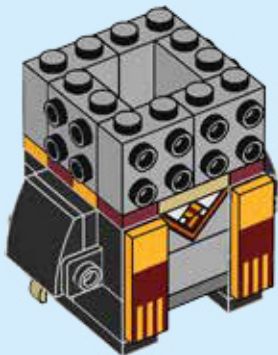

14



# 15

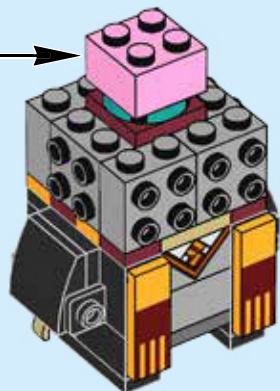
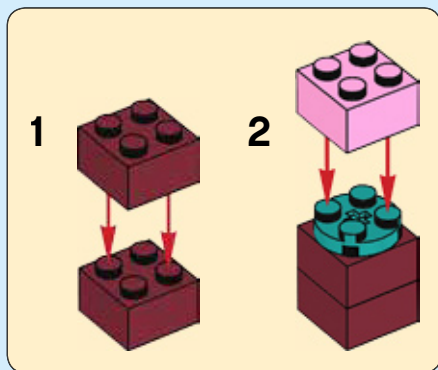



6x

16

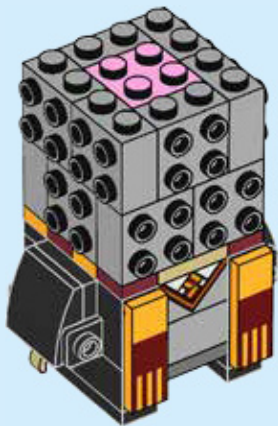

16





1x



2x

# 17

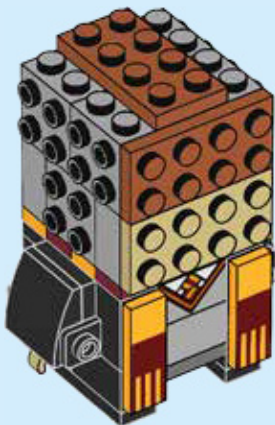



1x



1x

# 18

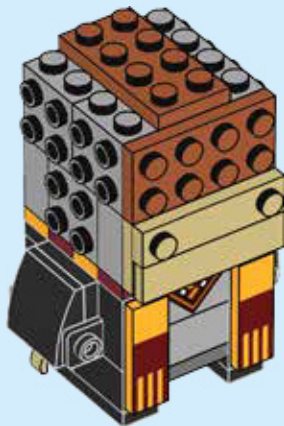



1x



1x



2x

# 19

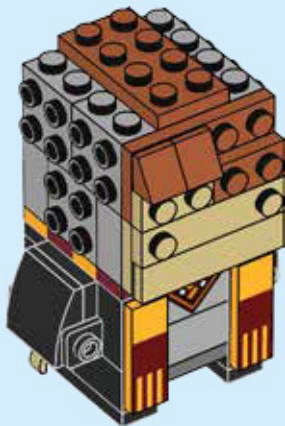



1x



2x



2x

# 20

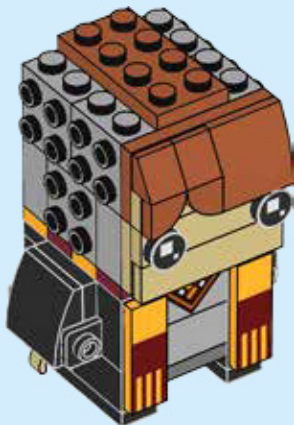

20



1x



1x



2x

# 21

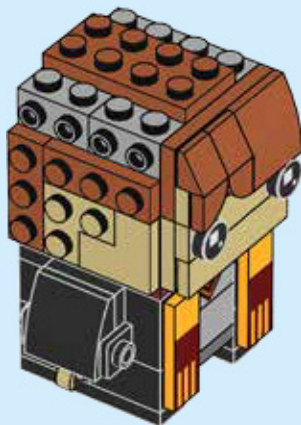



1x



2x



1x



1x

# 22

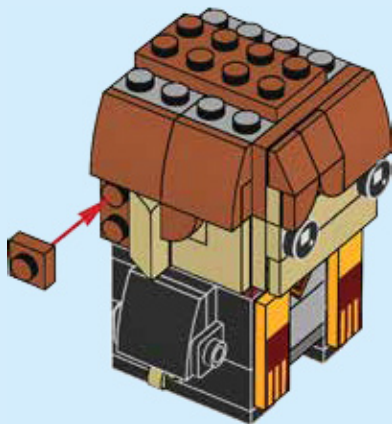

22



1x



1x



2x

# 23

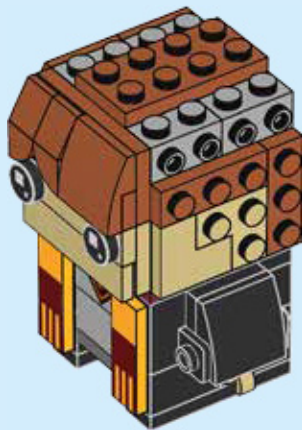
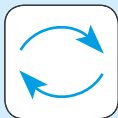



1x



2x



1x



1x

# 24

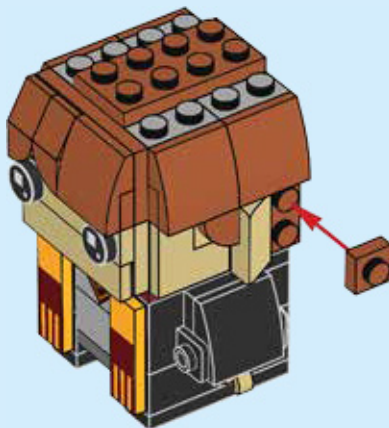





2x

# 25

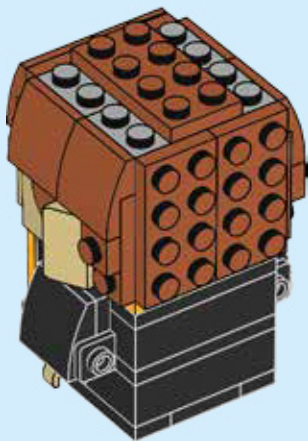
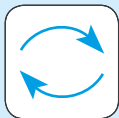



1x

26

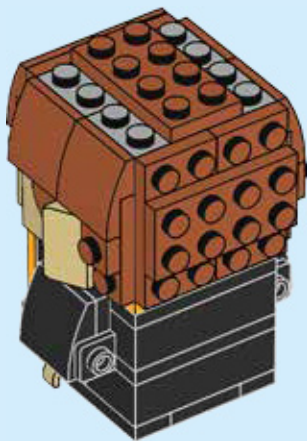

26



4x

27

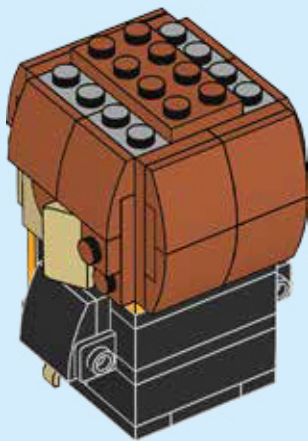



2x



2x

# 28

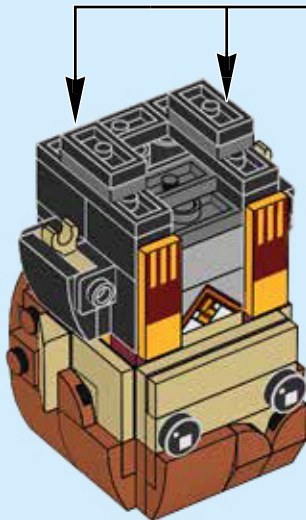
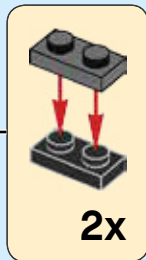
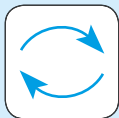



# 29

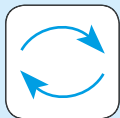

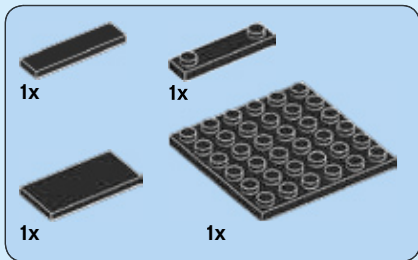

30

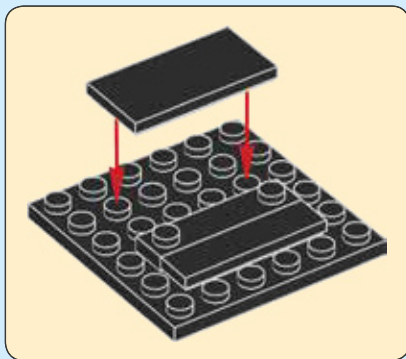

30



# BRICK HEADZ

# Harry Potter

41615

41615

41616

41621

41621



**49** HARRY POTTER™



**50** HEDWIG™



**51** HERMIONE GRANGER™



**60** RON WEASLEY™



**61** ALBUS DUMBLEDORE™



# WIN

GO TO [WWW.LEGO.COM/PRODUCTFEEDBACK](http://WWW.LEGO.COM/PRODUCTFEEDBACK) AND  
GIVE US YOUR SHORT **FEEDBACK** ABOUT THIS  
LEGO® SET FOR A CHANCE TO WIN  
A COOL LEGO PRIZE.

Terms & Conditions apply

## [LEGO.com/productfeedback](http://LEGO.com/productfeedback)

### GEWINNE

Erzähle uns auf  
[www.LEGO.com/productfeedback](http://www.LEGO.com/productfeedback)

etwas über die Erfahrungen, die du  
mit diesem LEGO® Set gemacht hast,  
und sichere dir die Chance auf einen  
coolen LEGO Preis!

Es gelten die Teilnahmebedingungen

### GAGNE

Rends-toi sur  
[www.LEGO.com/productfeedback](http://www.LEGO.com/productfeedback)

et donne-nous quelques commen-  
taires sur ce produit LEGO® pour  
avoir une chance de gagner un  
prix LEGO !

Voir Conditions Générales

### GANANA

Visita  
[www.LEGO.com/productfeedback](http://www.LEGO.com/productfeedback)

y envíanos tu opinión acerca de este  
set LEGO®. ¡Participarás en el sorteo  
de un premio LEGO!

Términos y Condiciones aplicables

### 获取奖品

登录  
[www.LEGO.com/productfeedback](http://www.LEGO.com/productfeedback)

给出关于此乐高®套装的简短反馈，  
就有机会获得炫酷乐高奖品

《条款及条件》适用

LEGO and the LEGO logo are trademarks of the LEGO Group. ©2018 The LEGO Group.

© 2018 WBEI  
Publishing Rights © J.K.R.  
TM J.K.R. & WBEI

6247392





# BRICK 'HEADZ

41621



Harry Potter



[LEGO.com/brickheadz](https://www.LEGO.com/brickheadz)

ALBUS DUMBLEDORE™

61

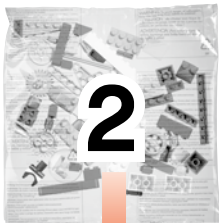

1x



2x

1

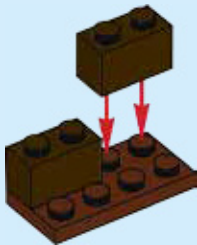



**2**

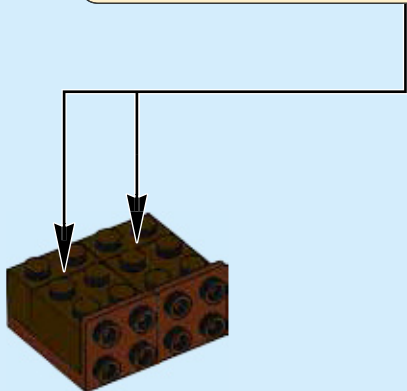
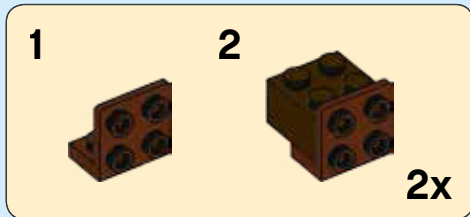



2x



1x

3



2x

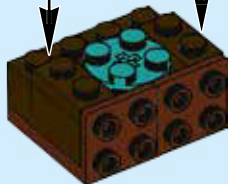

4



4

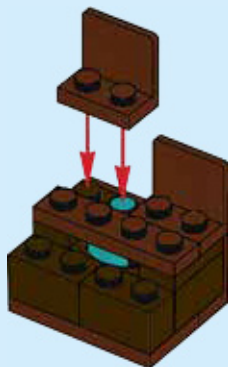
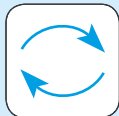



2x

5



6

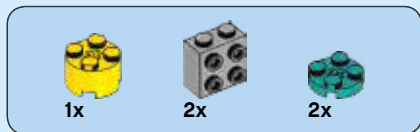

6

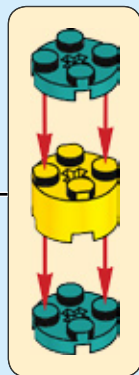



2x

7



8



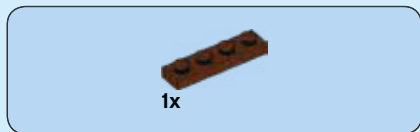

8



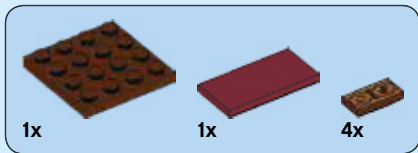

9

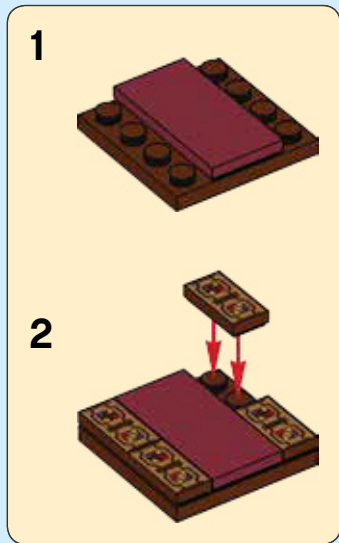
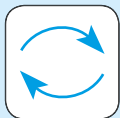

10

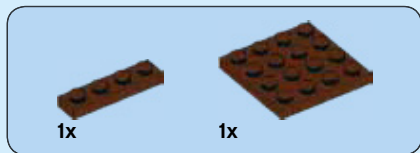

10

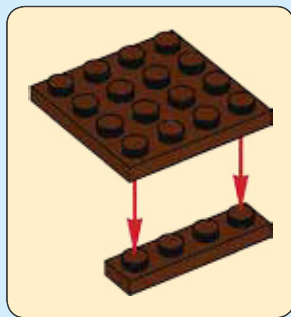



1x



2x

11

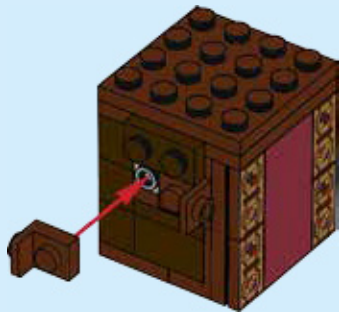

12



1x



1x



1x

# 12





1x



2x

# 13

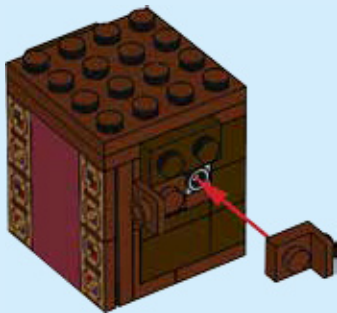
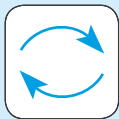

14



1x



1x



1x

# 14

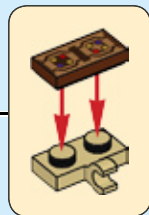



6x

15

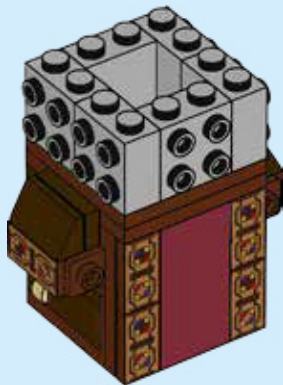
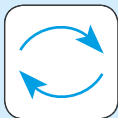

16





# 16

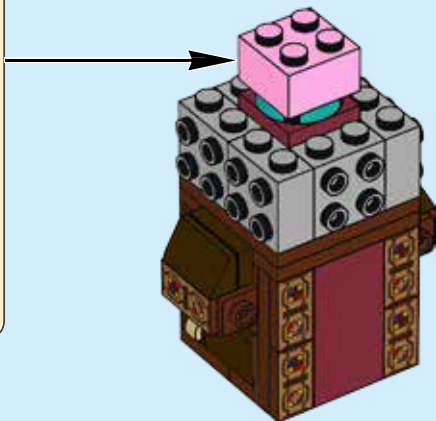
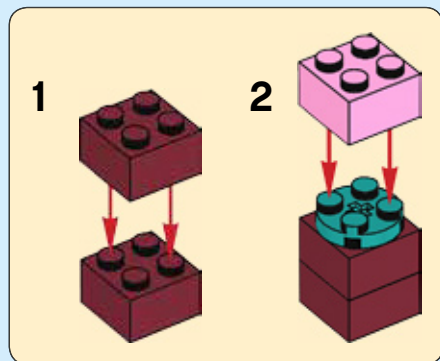



6x

17



18



2x



2x

# 18

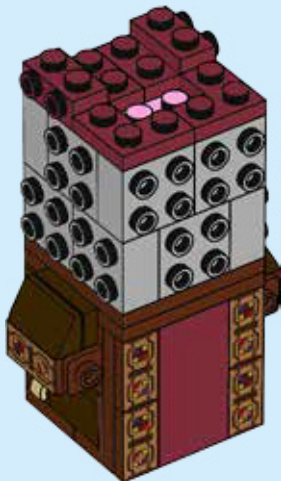

2x



1x



1x

# 19

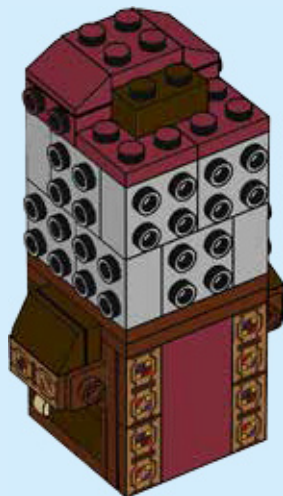



2x



1x

20

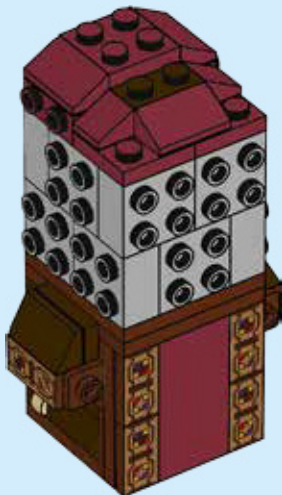

20



21

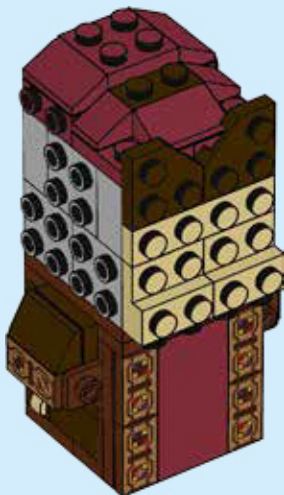

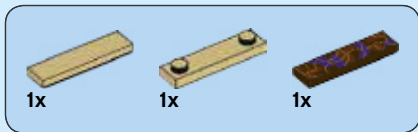

22

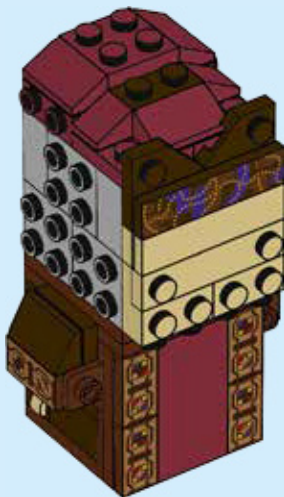

22

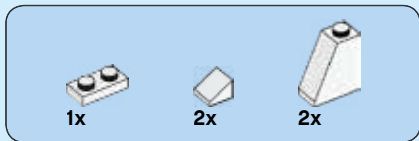

# 23

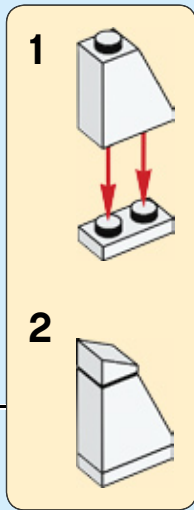
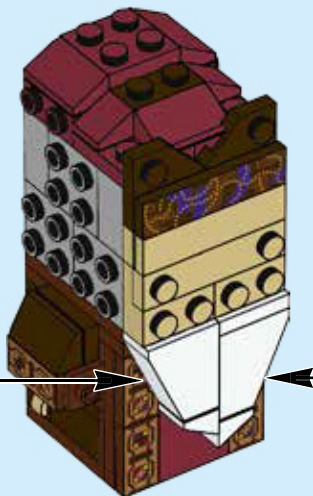
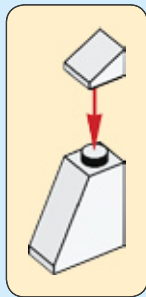



4x

24

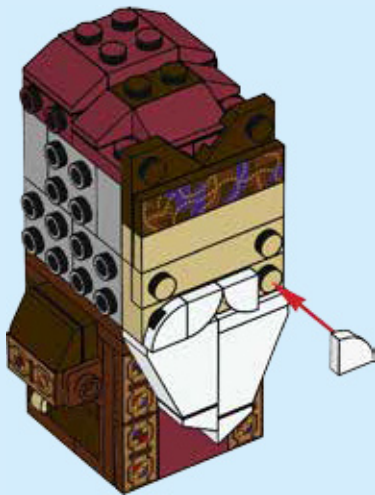

24





2x

# 25

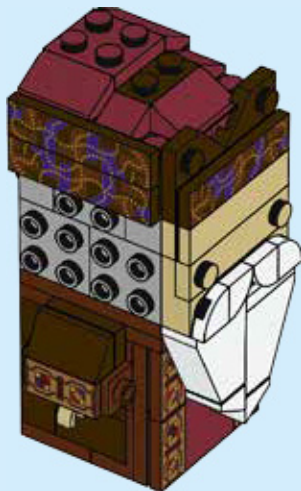



1x



2x

# 26



1



2





2x



2x



2x



2x

# 27

1

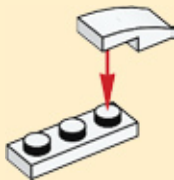

2



2x

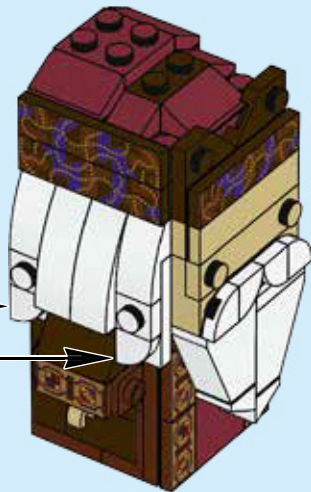



2x

28

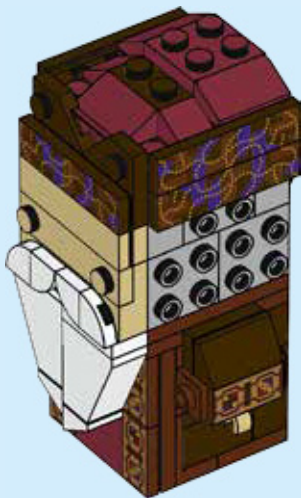
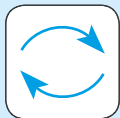

28

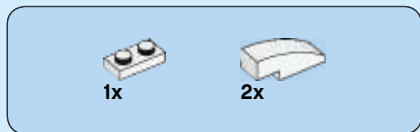

# 29

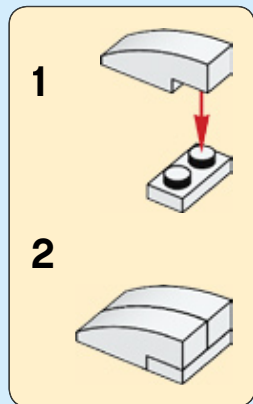
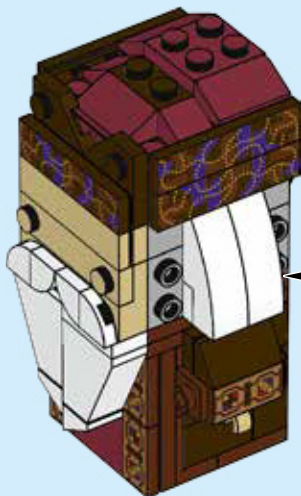



2x



2x



2x



2x

# 30

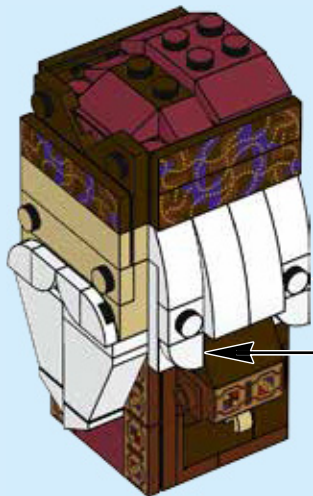

1

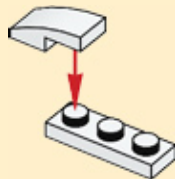

2

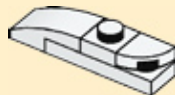

2x



# 31

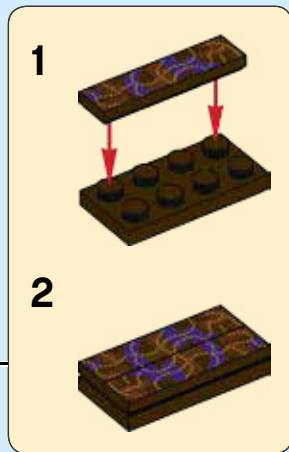
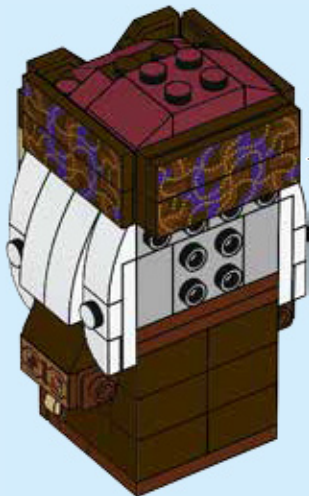
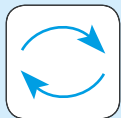

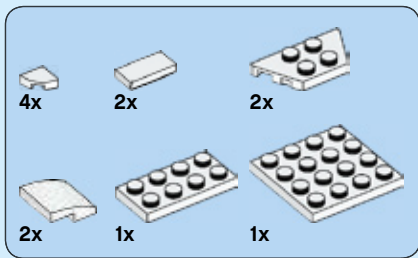

**32**

**1**

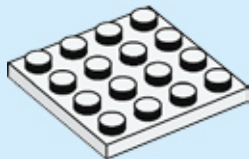

32

**2**

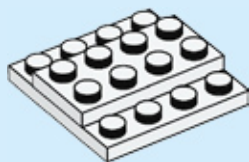

**3**

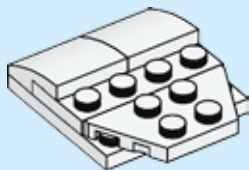



4

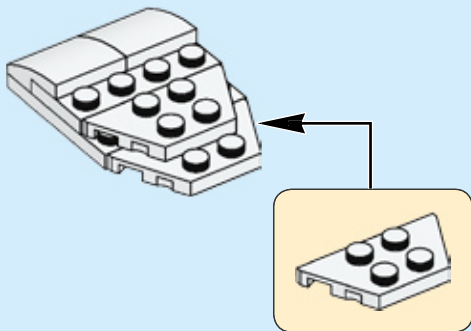

5

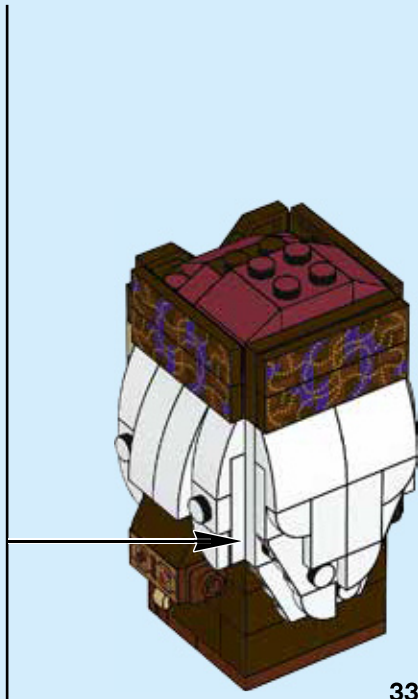
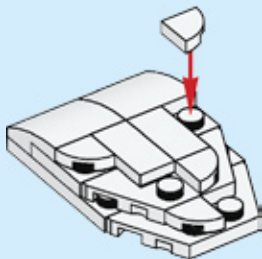



1x



1x



1x

# 33

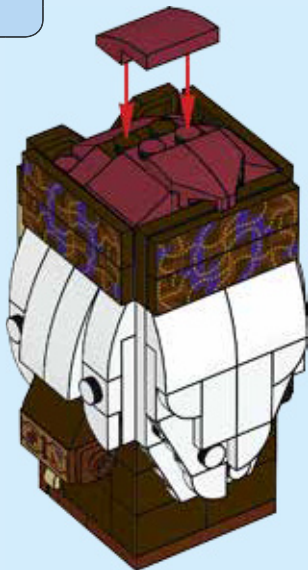

34



2x



1x

# 34

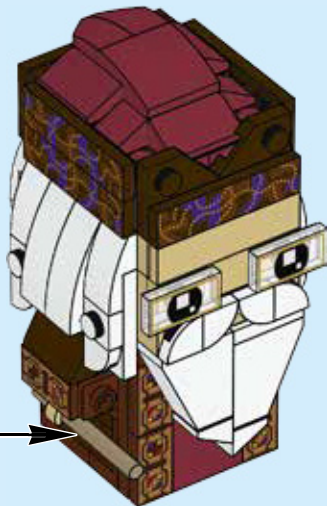
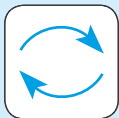

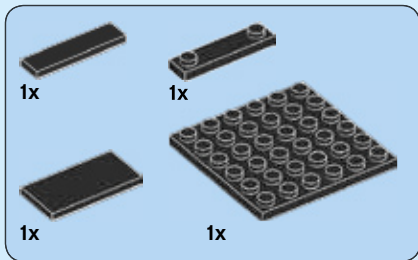

35

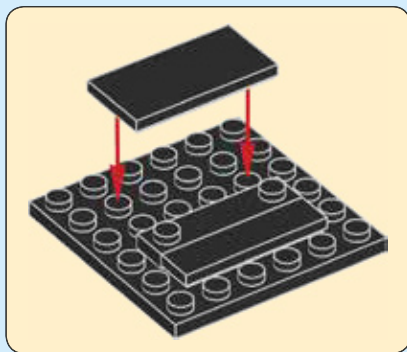

36

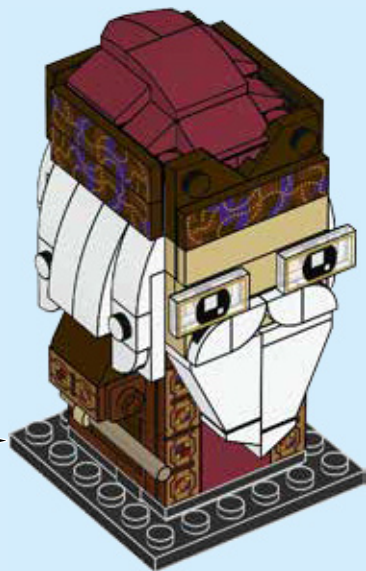

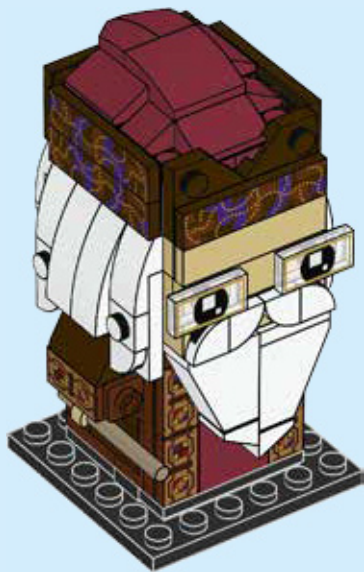
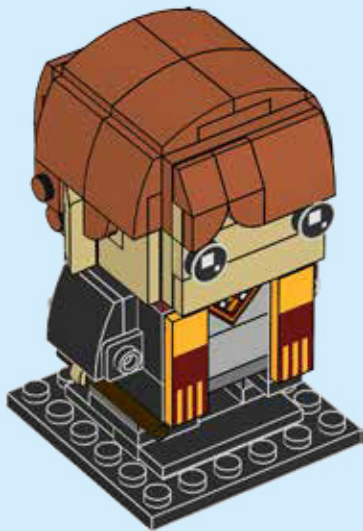





5x  
4535928



5x  
6210400



1x  
6213777



1x  
6238876



1x  
6219658



2x  
4531415



2x  
4539114



1x  
6219657



3x  
6083977



1x  
6107758



4x  
4585751



5x  
4539104



2x  
6188829



1x  
6186003



2x  
6073040



2x  
6237028



1x  
6020073



4x  
6238874



6x  
6239971



4x  
6226436



3x  
4211190



1x  
4211186



2x  
4243838



1x  
6237032



1x  
4211388



28x  
6123809



3x  
4211063



1x  
6099909



2x  
6238276



2x  
6127366



4x  
6058221



7x  
6058257



2x  
6240629



2x  
6092677



1x  
6238014



7x  
6239972



1x  
6226792



**Customer Service**

**Kundenservice**

**Service Consommateurs**

**Servicio Al Consumidor**

**LEGO.com/service or dial**



**: 00800 5346 5555**

**: 1-800-422-5346**

LEGO and the LEGO logo are trademarks of the LEGO Group.

©2018 The LEGO Group. 6247395

© 2018 WBIE, Publishing Rights © J.K.R. TM J.K.R. & WBIE

