



THE LEGO MOVIE

30529



6268296



THE LEGO MOVIE

LEGO.com/movie2

LEGO.com/service

THE LEGO® MOVIE 2™ © & ™ Warner Bros. Entertainment Inc. & The LEGO Group. LEGO, the LEGO logo, DUPLO, the Minifigure and the Brick and Knob configurations are trademarks and/or copyrights of the LEGO Group.

©2019 The LEGO Group. All rights reserved. WB SHIELD: TM & © WBET. (s19) 6268296



www.LEGO.com/buildmoremovie2



1

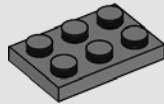

2

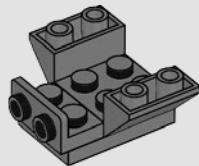

3

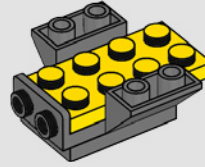

4

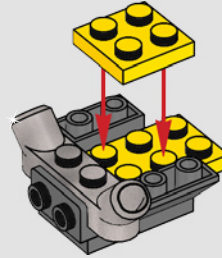

1



2

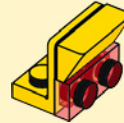

5

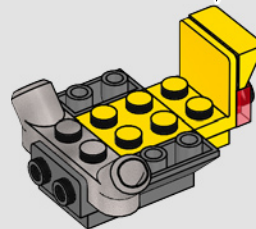

6

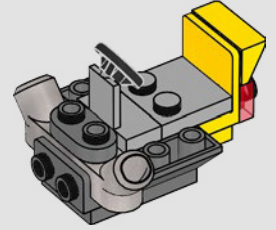

7

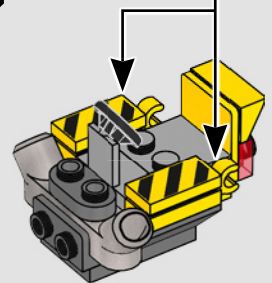

8

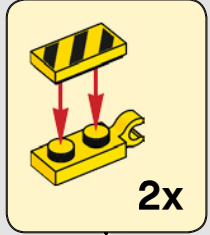
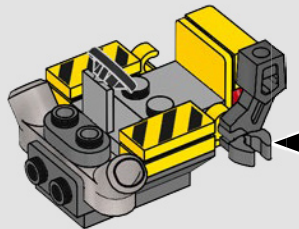
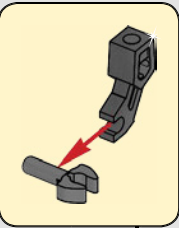

2x

9

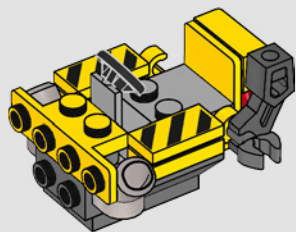

10

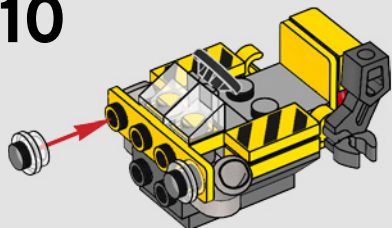

11

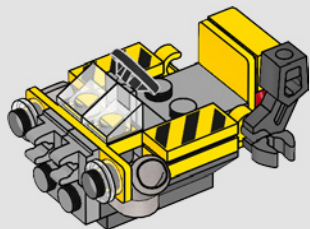

12

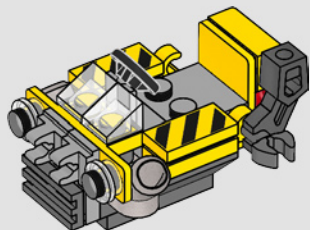

1

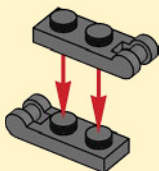

2

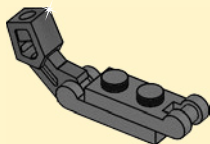

3

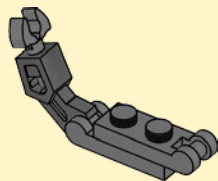

13

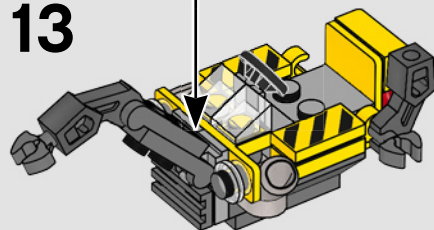

1

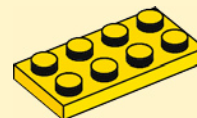

2

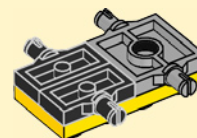

3

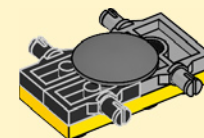

4

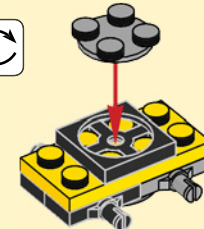

14

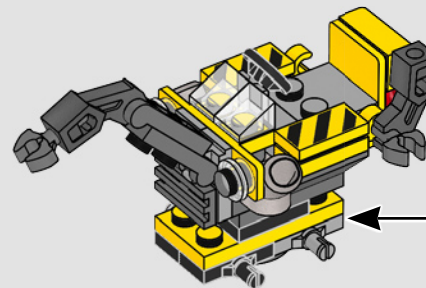

15

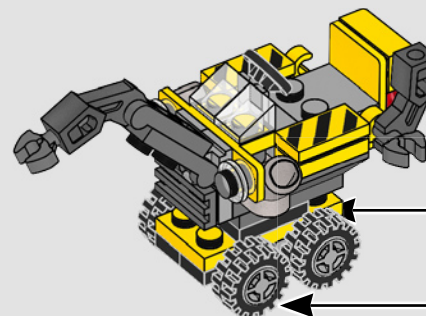

4x