



DC COMICS  
**SUPER  
HEROES**

76070



6187718

1



2

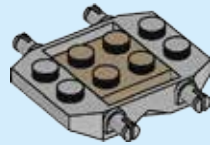

3

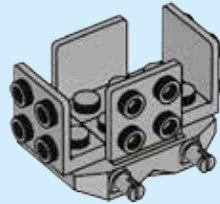

4

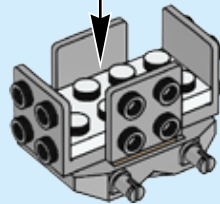

5

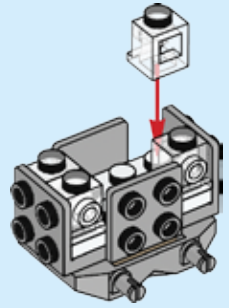

6

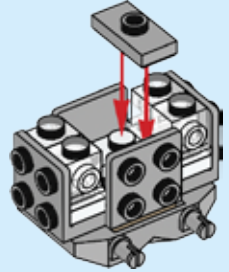

7

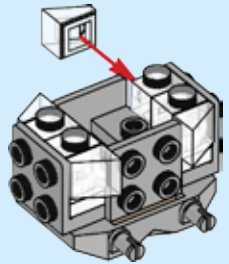

8

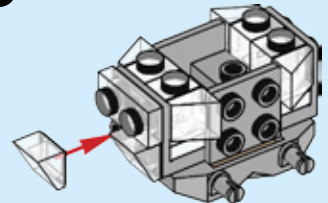

9

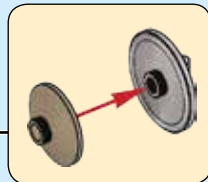
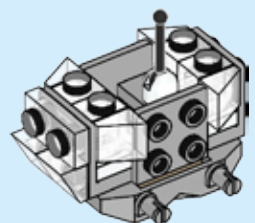

10

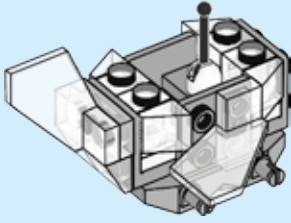

11

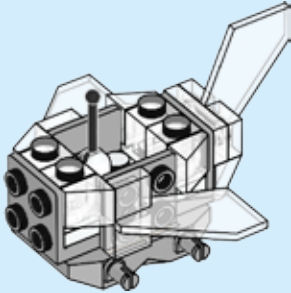
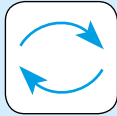

12

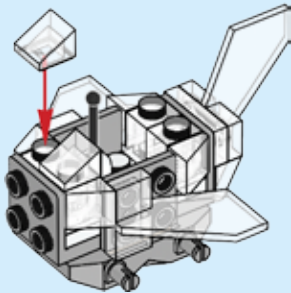

13

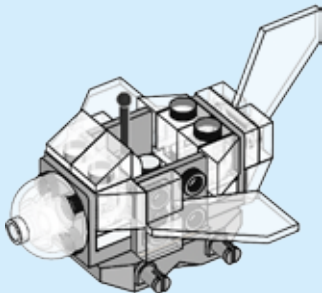

14

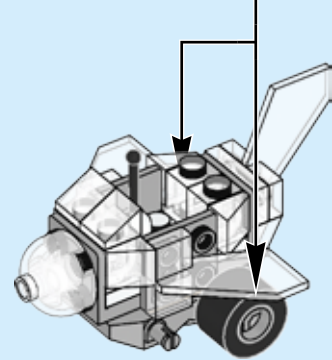
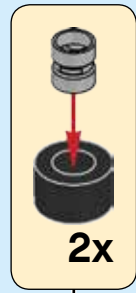

15

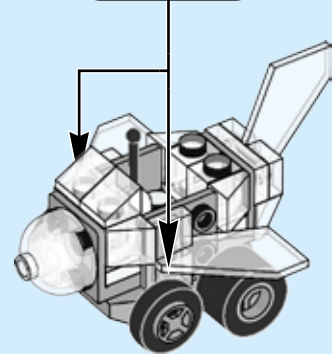
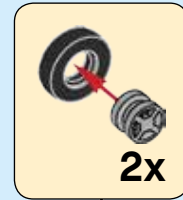

LEGO.com/service

LEGO and the LEGO logo are trademarks of the LEGO Group. ©2017 The LEGO Group. 6187718

DC All DC characters and elements © & TM DC Comics.

WB SHIELD: TM & © WBEI. (s17)

2

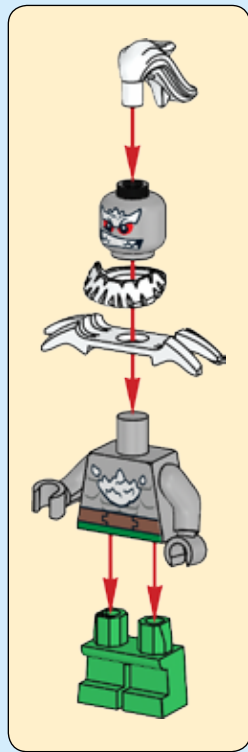

1



2

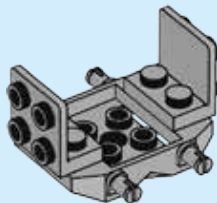

3

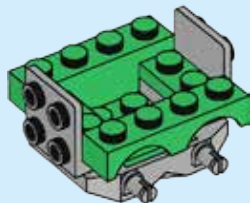

4

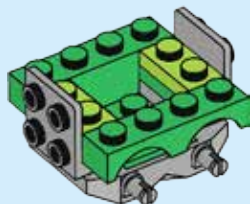

5

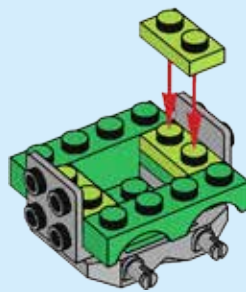

6

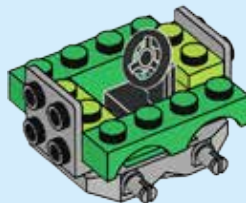

7

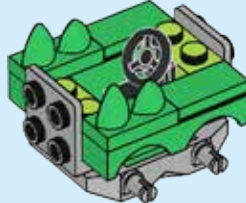

8

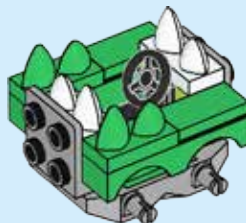

9

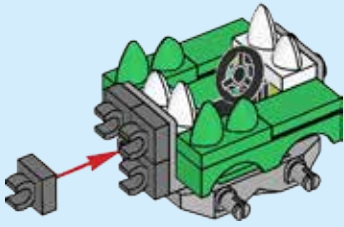

10

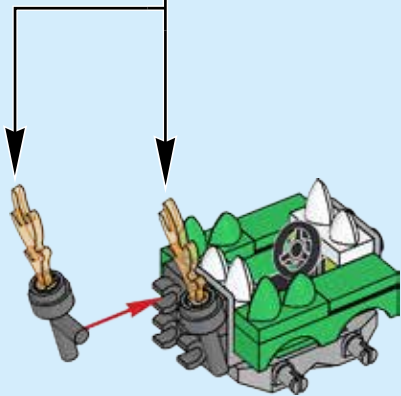
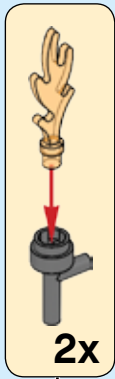

11



12

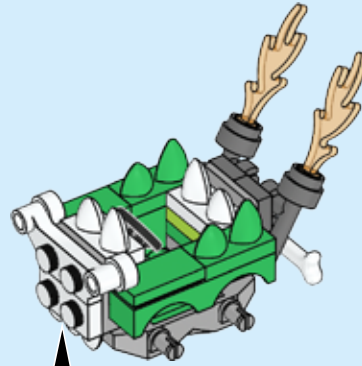
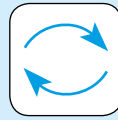

13

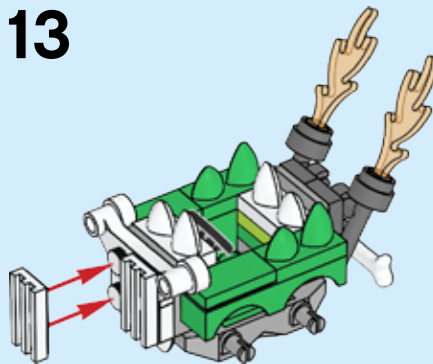

14

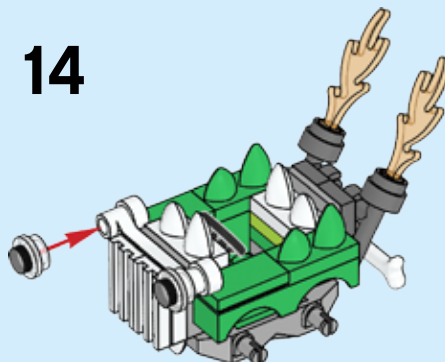

15

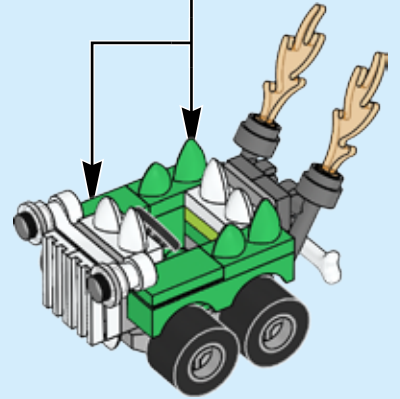
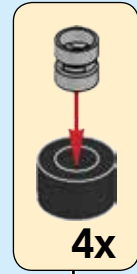



DC COMICS  
**SUPERHEROES**

76070

LEGO and the LEGO logo are trademarks of the LEGO Group. ©2017 The LEGO Group.

DC All DC characters and elements © & ™ DC Comics.

WB SHIELD: TM & © WBEI.  
(s17)

6187724



Terms & Conditions apply

**LEGO.com/productfeedback**

**GEWINNE**



Erzähle uns auf  
[www.LEGO.com/productfeedback](http://www.LEGO.com/productfeedback)

etwas über die Erfahrungen, die du mit diesem LEGO® Set gemacht hast, und sichere dir die Chance auf einen coolen LEGO Preis!

Es gelten die Teilnahmebedingungen

**GAGNE**



Rends-toi sur  
[www.LEGO.com/productfeedback](http://www.LEGO.com/productfeedback)

et donne-nous quelques commentaires sur ce produit LEGO® pour avoir une chance de gagner un prix LEGO !

Voir Conditions Générales

**GANA**



Visita  
[www.LEGO.com/productfeedback](http://www.LEGO.com/productfeedback)

y envíanos tu opinión acerca de este set LEGO®. ¡Participarás en el sorteo de un premio LEGO!

Términos y Condiciones aplicables

**获取奖品**



登录  
[www.LEGO.com/productfeedback](http://www.LEGO.com/productfeedback)

给出关于此乐高®套装的简短反馈，就有机会获得炫酷乐高奖品

《条款及条件》适用

**Customer Service**  
Kundenservice  
Service Consommateurs  
Servicio Al Consumidor

**LEGO.com/service or dial**



LEGO

DC COMICS  
**SUPER  
HEROES**

**MIGHTY  
MICROS**

[LEGO.com/DCSUPERHEROES](http://LEGO.com/DCSUPERHEROES)

DC All DC characters and elements © & ™ DC Comics.

WB SHIELD: TM & © WBEI.  
(s17)

Apple and the Apple logo are trademarks of Apple Inc.,  
registered in the U.S. and other countries.  
App Store is a service mark of Apple Inc.

Google Play is a trademark of Google Inc.

Ask parents' permission first.  
Bitte frage erst deine Eltern um Erlaubnis.  
Demande d'abord l'autorisation d'un parent.  
Pide antes permiso a tus padres.  
Pede primeiro permissão aos teus pais.  
Először kérj engedélyt a szüleidtől!  
先请求家长的许可。



LEGO

DC COMICS  
**SUPER  
HEROES**

76054

76055

76053



76055

76054

76053

DC BATMAN and all related characters and elements  
© & ™ DC Comics and Warner Bros.  
Entertainment Inc.

WB SHIELD: TM & © WBEI.  
(s17)

