



CREATOR

40221



1



2



3



4



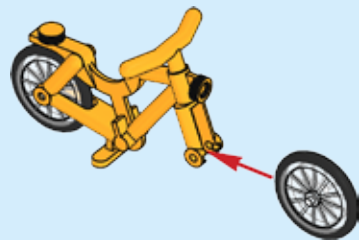
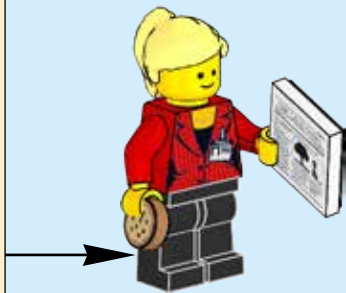
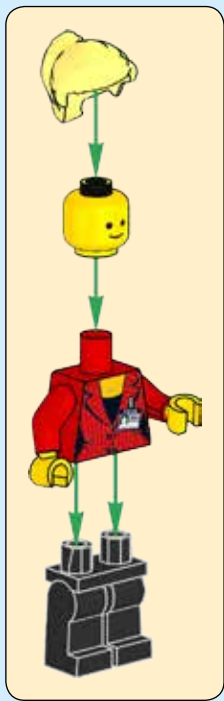

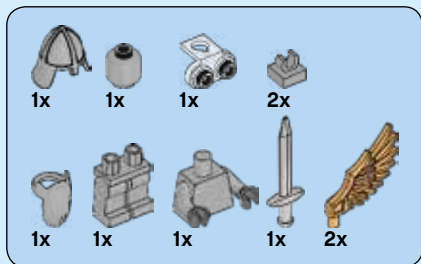

1

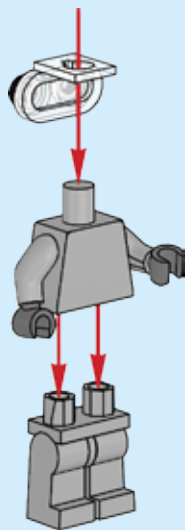

2

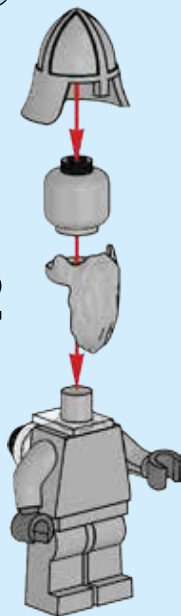

3

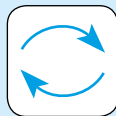

4



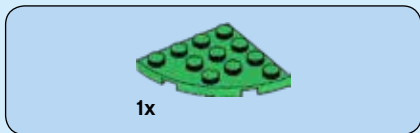
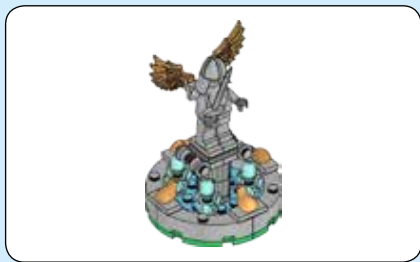

1

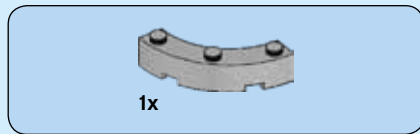

2

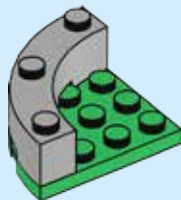

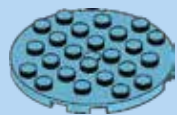

1x

3

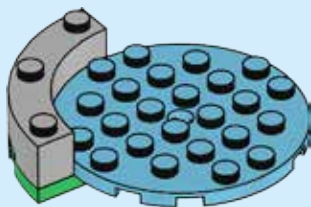

6

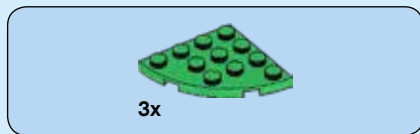

4

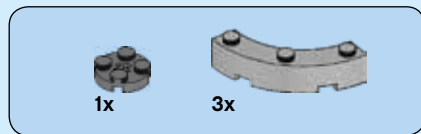
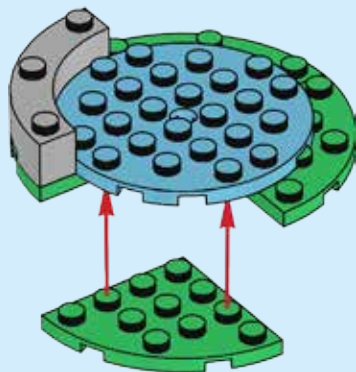

5

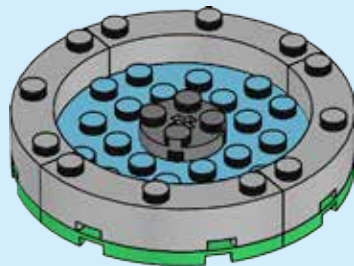



4x

6

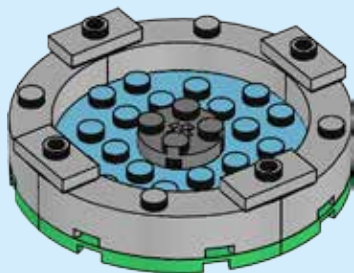

8



4x



4x

7

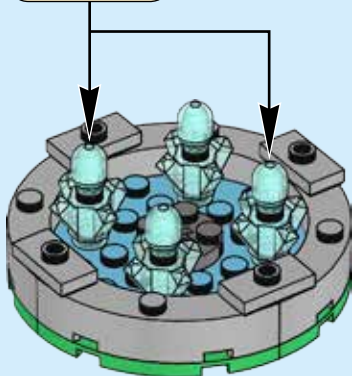
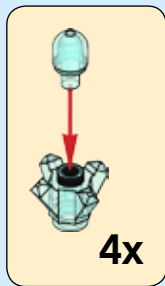

4x

8

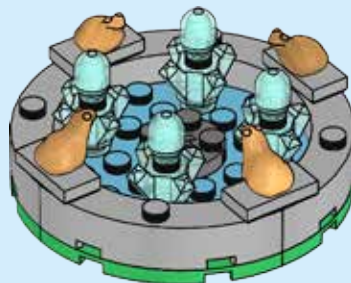



2x

9

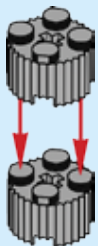

10



4x

10

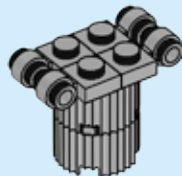



1x

11

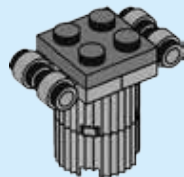

4x

12

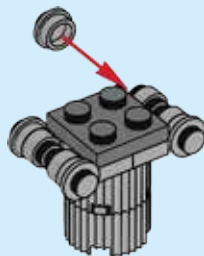



2x

13

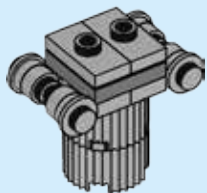

14

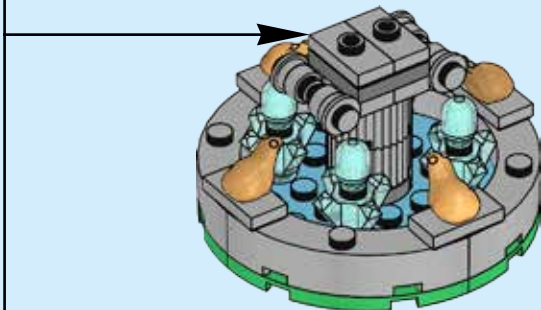

15



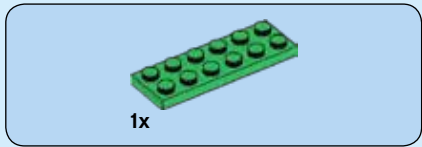

1x

1

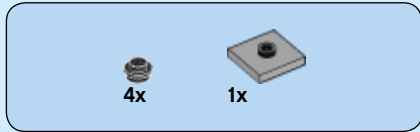
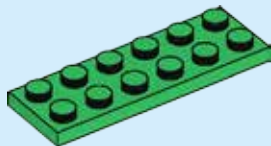

2

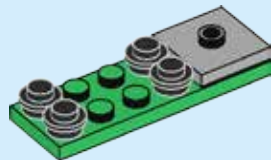



2x



2x

3

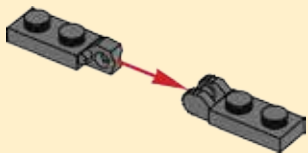

2x

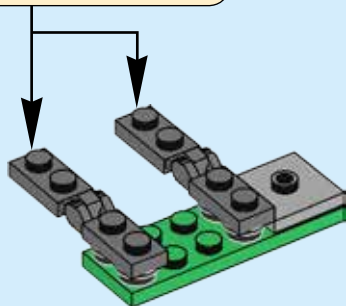

1x

4

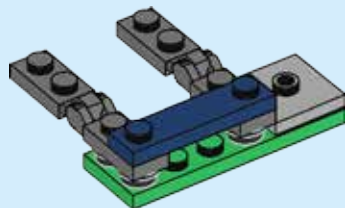



3x

5

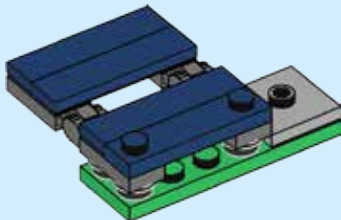

1x



4x

6

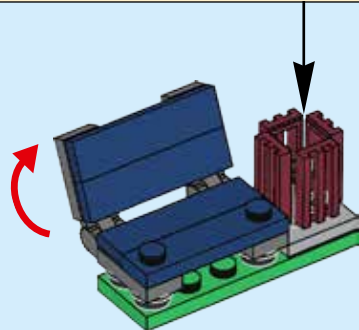
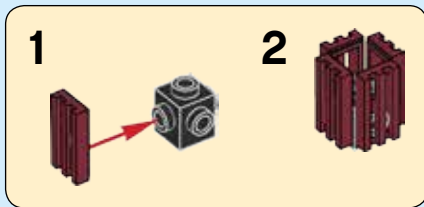

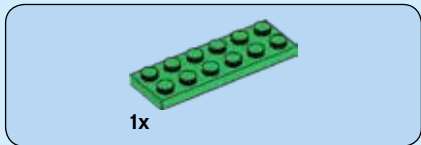

1

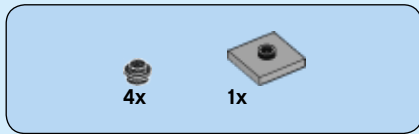
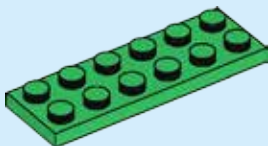

2

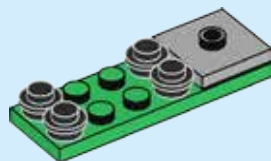



2x



2x

3

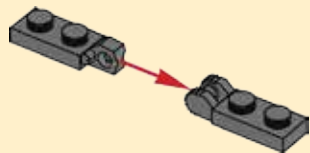

2x

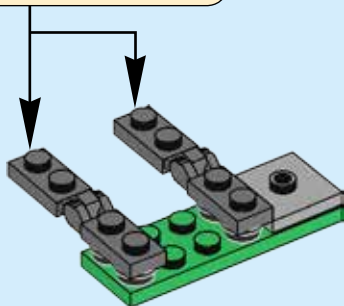

1x

4

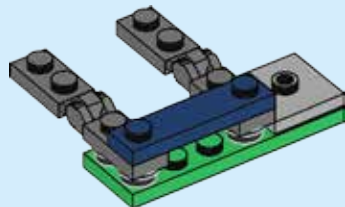



5

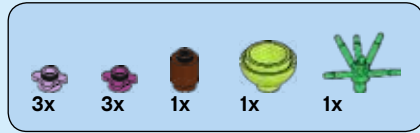
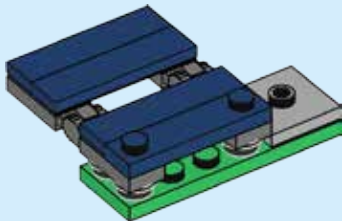

6

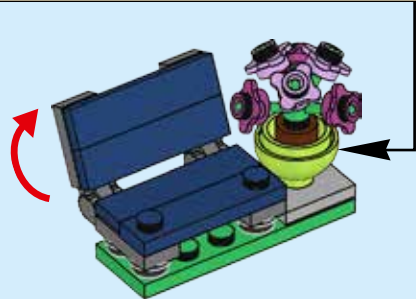
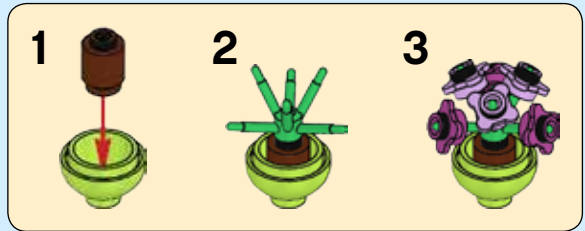



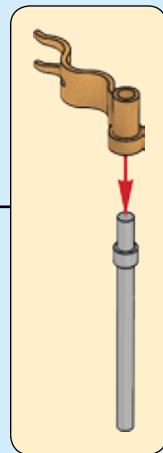
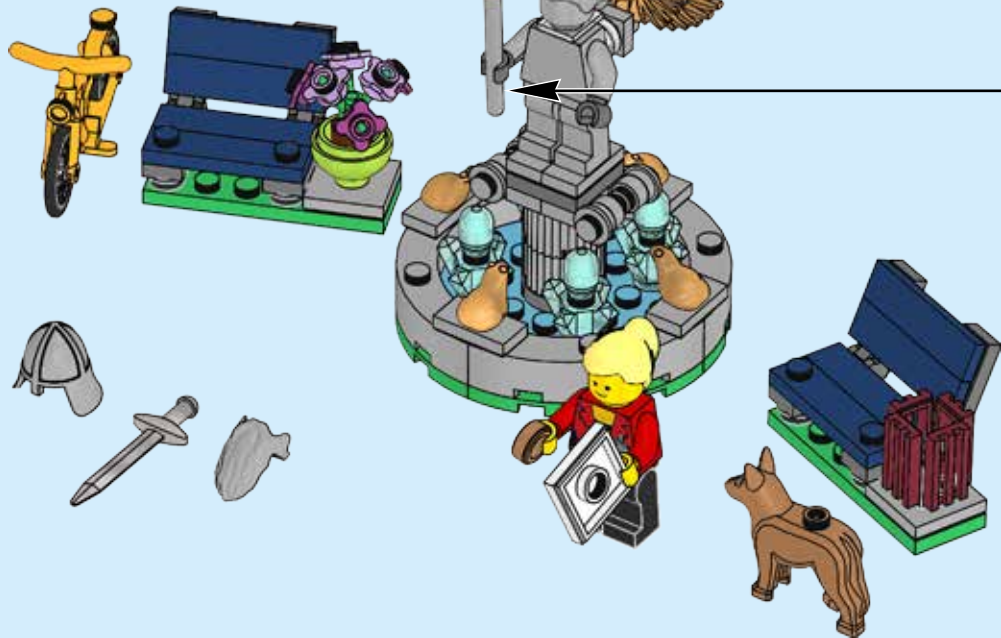
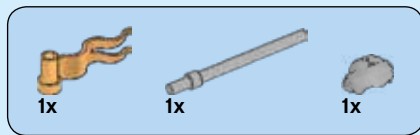



1x
4655208



2x
4622574



3x
6078932



8x
614126



4x
4211525



2x
6071229



4x
6107741



1x
6104128



1x
6100958



3x
6074906



1x
473326



1x
4211585



1x
6002762



2x
6097514



1x
6097232



4x
6081343



1x
4211183



1x
9339



1x
6078442



1x
6134394



1x
4504649



4x
6038682



4x
6019570



4x
4541506



1x
4211042



6x
6066097



2x
4650645



1x
6055384



2x
379528



1x
6132675



1x
9336



4x
4210883



2x
6126082



4x
4632575



1x
4614195



Customer Service

Kundenservice

Service Consommateurs

Servicio Al Consumidor

LEGO.com/service or dial



00800 5346 5555 :



1-800-422-5346 :



1x
6032070



1x
4211094



4x
4210884



1x
4292298



1x
6081975



4x
4215472



1x
4211827



1x
4227657



2x
6036240



6x
6103985



1x
6029690





CREATOR

10251

10246

10243



LEGO and the LEGO logo are trademarks of the/sonnt des marques de commerce du/son marcas registradas de LEGO Group. ©2016 The LEGO Group.

LEGO.com/creator
6150257 / 6150259