



# DIMENSIONS™

71253



FANTASTIC  
BEASTS  
AND WHERE  
TO FIND THEM

LEGO DIMENSIONS Videogame software © 2016 TT Games Ltd. Produced by TT Games under license from the LEGO Group. LEGO, the LEGO logo, NINJAGO, the DIMENSIONS logo, the Brick and Knob configurations and the Minifigure are trademarks and/or copyrights of the LEGO Group. ©2016 The LEGO Group. Ghostbusters™ & © 2016 CPII. All Rights Reserved. A-Team™ & © 2016 Twentieth Century Fox Film Corporation. All Rights Reserved. ADVENTURE TIME and all related characters and elements are trademarks of and © Cartoon Network. (s16). TM, ® & ©2016 Paramount Pictures. All Rights Reserved. ©2016 Warner Bros Entertainment Inc. All Rights Reserved. Harry Potter and Fantastic Beasts Publishing Rights © JKR. (s16). © SEGA. All rights reserved. GREMLINS © &™ WBIEI (s16).™ & © Universal Studios. E.T. THE EXTRA TERRESTRIAL is a trademark and copyright of Universal Studios. Licensed by Universal Studios Licensing LLC. All DC characters and related indicia™ & © DC Comics.™ & © WBIEI. (s16). All other trademarks and copyrights are the property of their respective owners. All rights reserved.



WB GAMES LOGO, WBIE LOGO, WB SHIELD:™ & © Warner Bros. Entertainment Inc.  
(s16)



All DC characters and related indicia™ & © DC Comics.™ & © WBIEI.  
(s16)

© New Line.™ & © SZC lic. to WBIEI.  
(s16)

THE LEGO MOVIE © The LEGO Group & WBIEI.

Play the complete movie  
Spiele den ganzen Film  
Revivez toute l'histoire du film  
Spil hele filmen  
Speel de volledige film  
Juega niveles basados en la película  
Rivivi l'intero film



- EN Protect the environment by not disposing of this product with your household waste (2012/19/EU).  
Check with your local authority for recycling advice and facilities.
- DE Schützen Sie die Umwelt und entsorgen Sie dieses Produkt nicht mit Ihrem Hausmüll (2012/19/EU).  
Informationen zu Recycling-Möglichkeiten erhalten Sie bei den örtlichen Behörden.
- FR Protégez l'environnement : ne jetez pas ce produit avec vos autres déchets ménagers (Directive européenne 2012/19/UE).  
Contactez les autorités locales pour obtenir des informations sur le recyclage et connaître les points de collecte.
- IT Proteggi l'ambiente! Non smaltire questo prodotto con i rifiuti domestici (2012/19/UE).  
Per consulenza sul riciclaggio dei rifiuti e le strutture di riciclaggio, rivolgersi alle proprie autorità locali.
- NL Bescherm het milieu: gooi dit product niet samen met het andere huisvuil weg (2012/19/EU).  
Raadpleeg de plaatselijke instanties voor locaties van milieustations en advies over hergebruik.
- ES Proteja el medio ambiente no deshaciéndose de este producto junto con sus residuos domésticos (2012/19/UE).  
Solicite a su autoridad local consejos e información sobre instalaciones de reciclado.
- DA Beskyt miljøet! Smid ikke dette produkt ud sammen med husholdningsaffaldet (2012/19/EU).  
Få vejledning om genbrug og genbrugsstationer hos din kommune.
- FI Tämä tuote on hävitettävä ympäristönsuojelun vuoksi asianmukaisesti talousjätteistä erillään (2012/19/EU).  
Tietoja keräyspisteiden sijainnista saa kunnan tai kaupungin teknisestä virastosta.
- SV Skydda miljön genom att inte kasta denna produkt bland ditt hushållsavfall (2012/19/EU).  
Kontakta din kommun för frågor om återvinning och miljöstationer.
- NO Beskytt miljøet. Ikke kast dette produktet i husholdningsavfallet (2012/19/EU).  
Kontakt kommunen for veiledning om gjenbruk og miljøstasjoner.





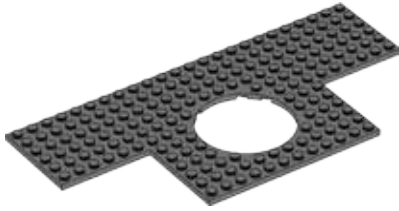

+

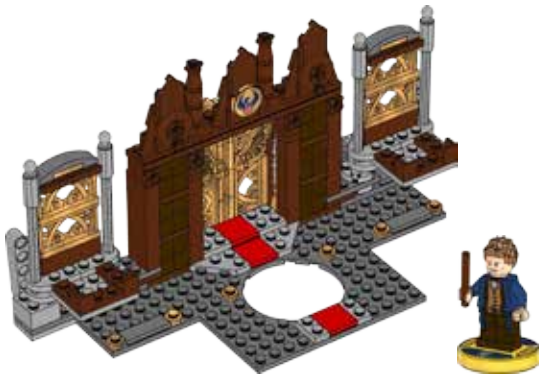

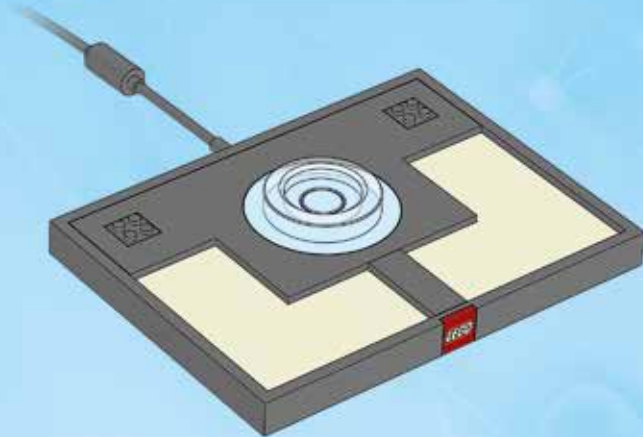

## Download the latest game content to use this character

- Lade dir die neusten Spielinhalte herunter, um diese Figur zu benutzen
- Télécharge le contenu le plus récent du jeu pour utiliser ce personnage
- Download det nyeste spilindhold for at bruge denne figur
- Download de nieuwste game-inhoud om deze figuur te kunnen gebruiken
- Ladda ner det senaste spelinnehållet för att använda den här karaktären
- Last ned det nyeste spillinnholdet for å ta i bruk denne figuren
- Pääset käyttämään tätä hahmoa lataamalla pelin uusimman sisällön
- Descarga la última actualización de contenido para usar este personaje
- Scarica gli ultimi contenuti del gioco per usare questo personaggio

Start game  
Spiel starten  
Commencer à jouer

Start spillet  
Game starten  
Starta spelet

Aloita peli  
Iniciar juego  
Avvia il gioco

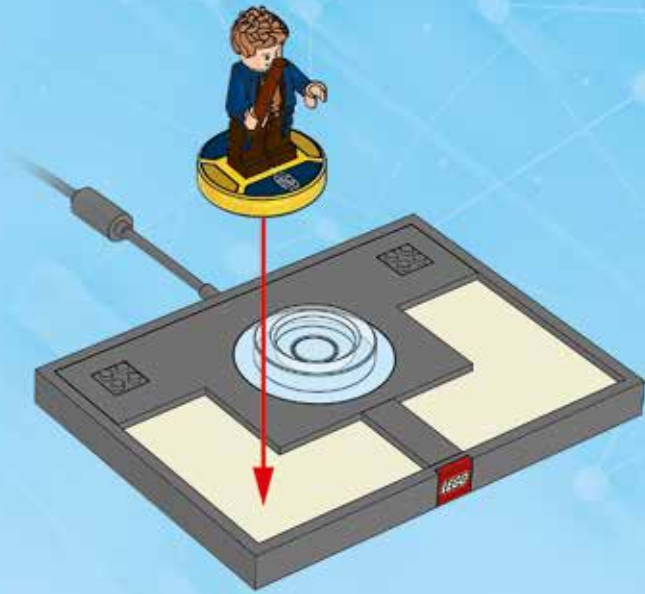



- Building is part of playing the game
- Das Bauen ist Teil des Spiels
- La construction fait partie du jeu
- Byggeri er en del af spillet
- Bouwen is een onderdeel van het spel
- Byggandet är en del av spelet
- Byggingen er en del av spillet
- Peliin kuuluu myös rakennustehtäviä
- Construir forma parte del juego
- La costruzione fa parte del gioco





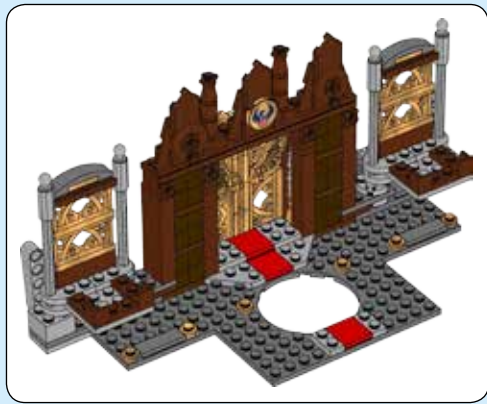

**1**

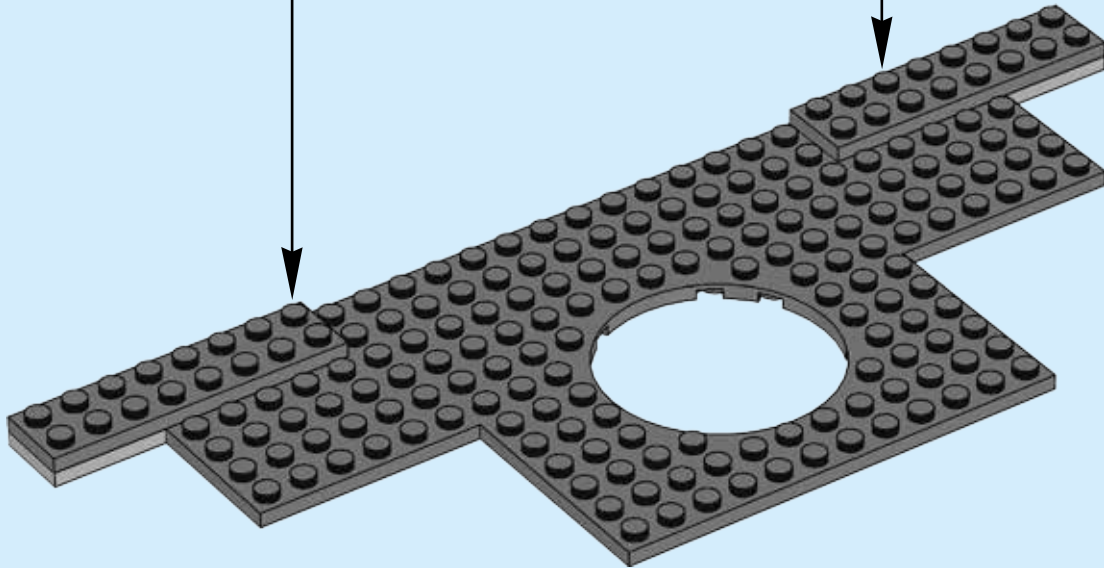
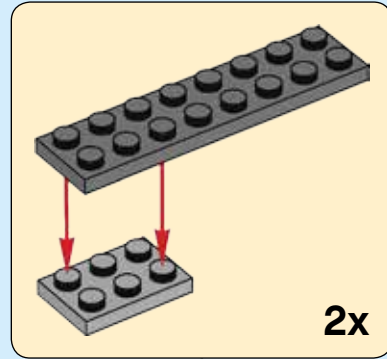

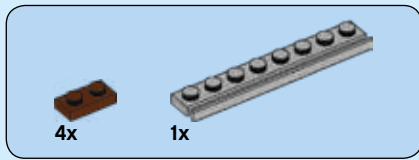

2

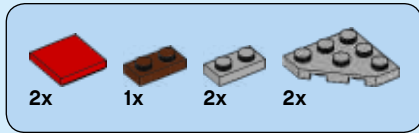
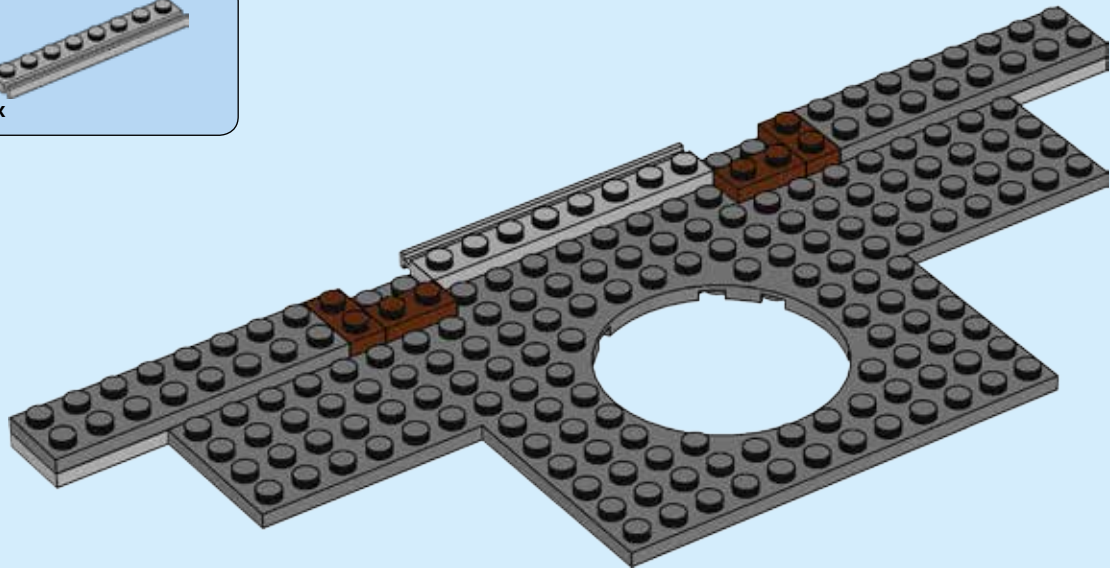

3

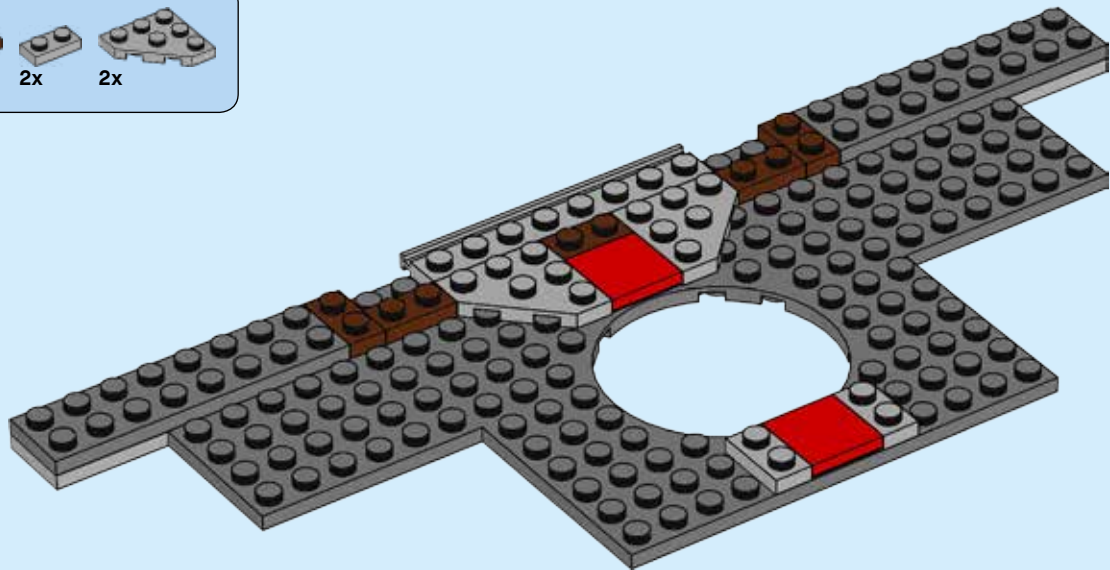



4

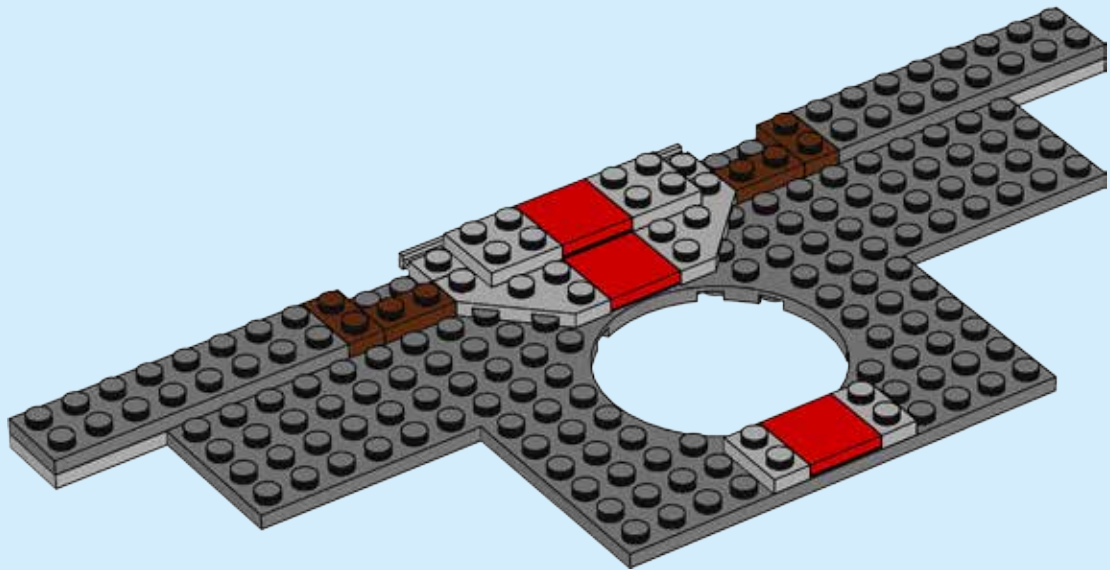





6x



2x

5

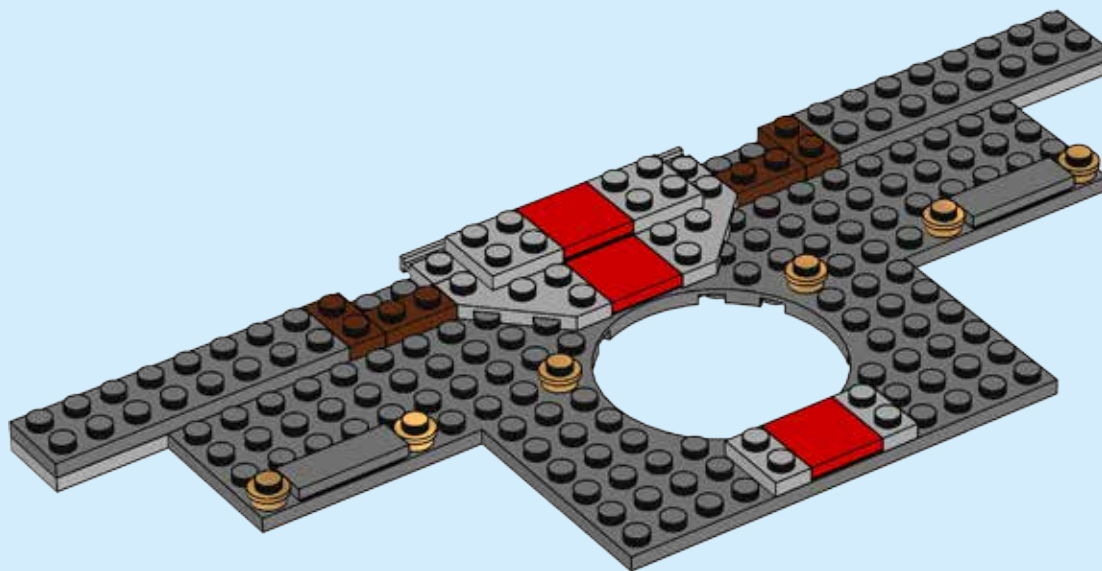

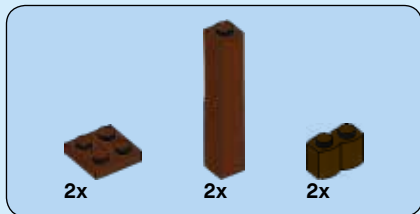

6

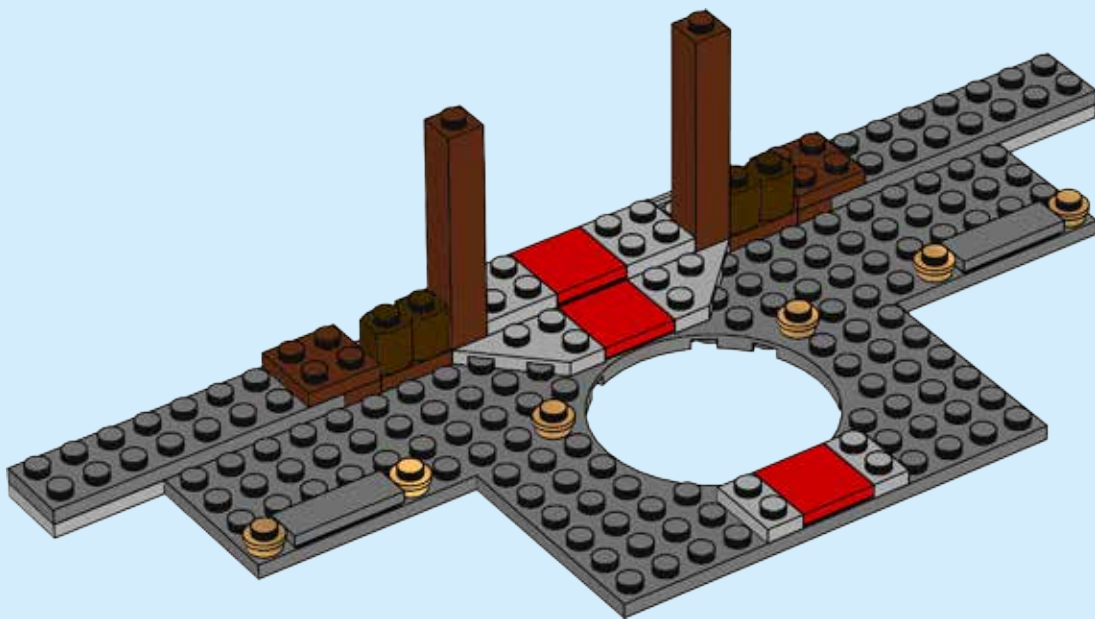

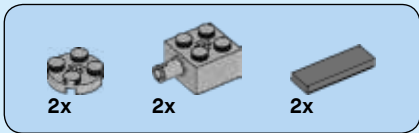

7

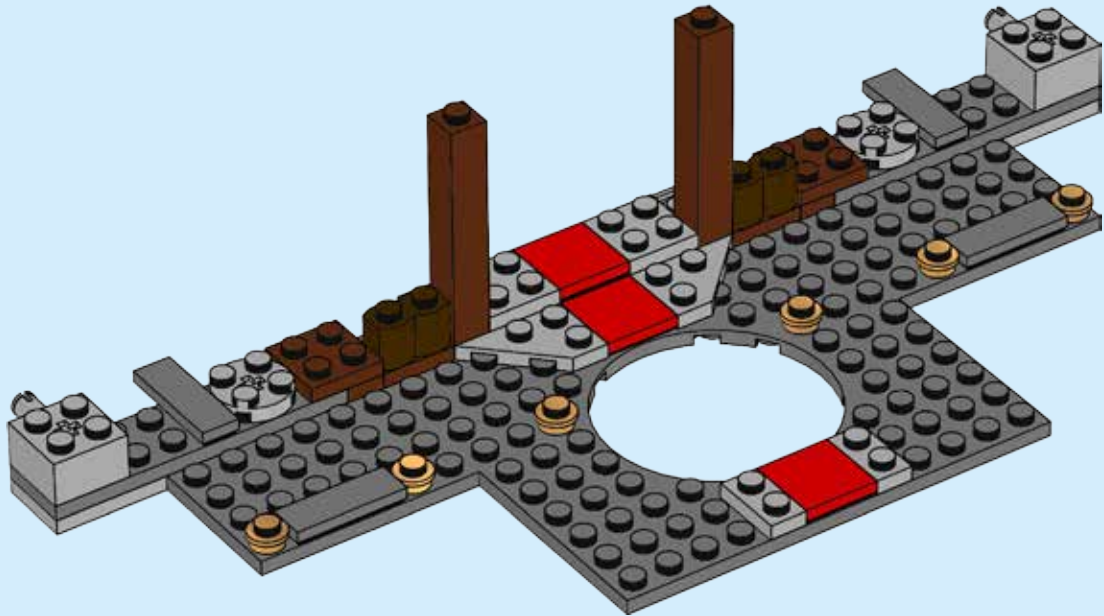

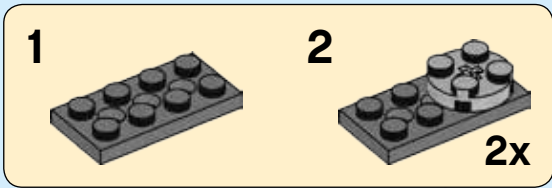
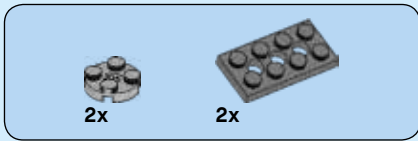

8

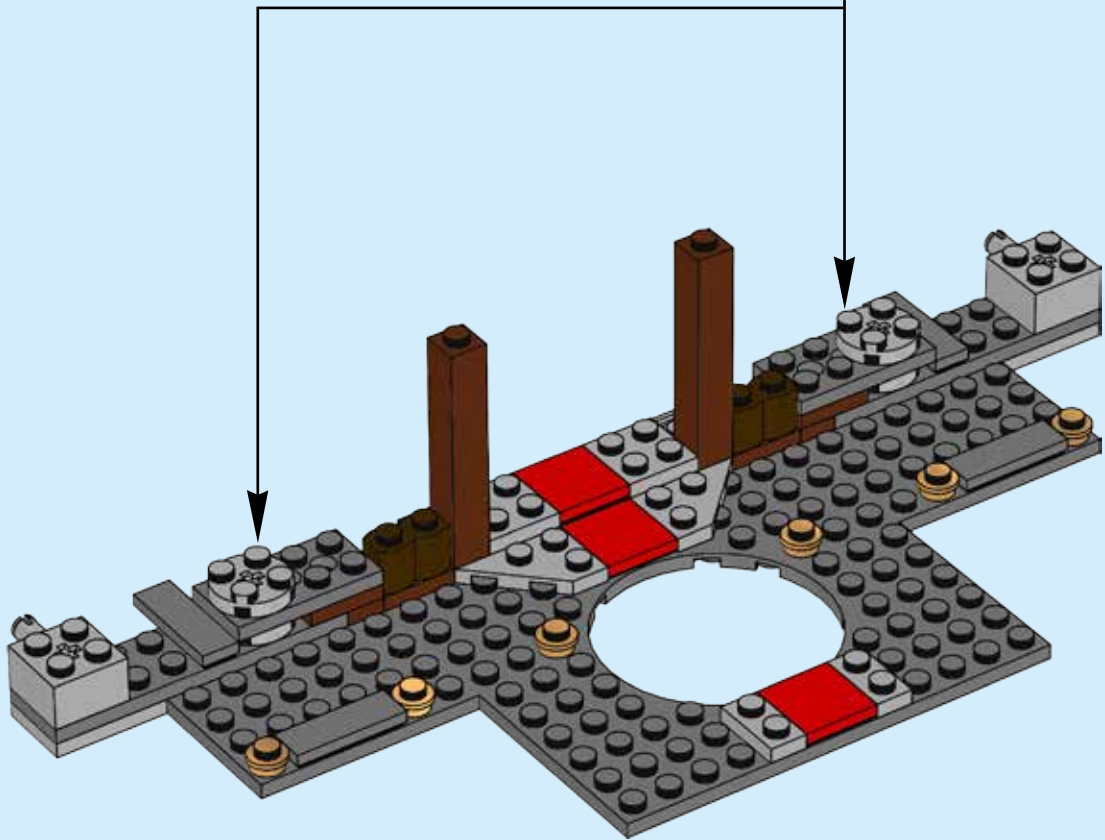





9

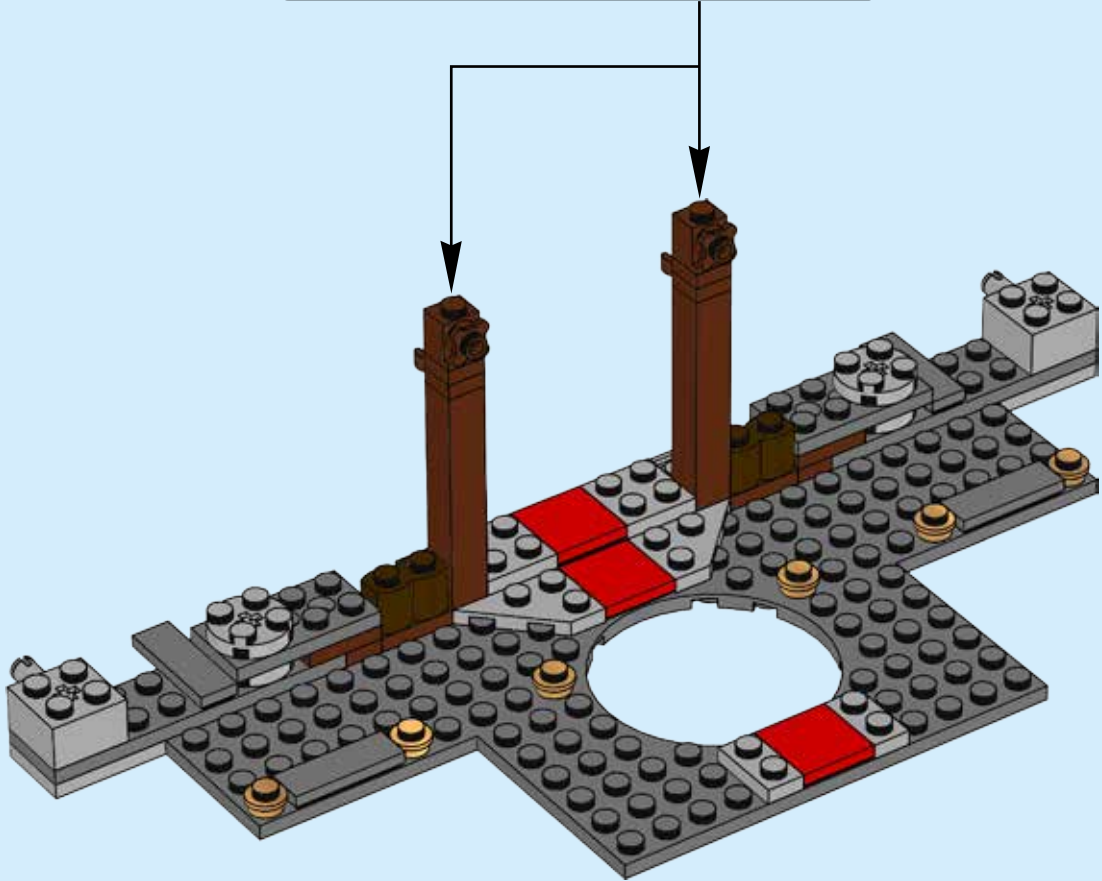
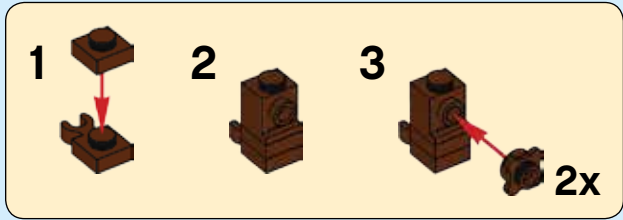



10

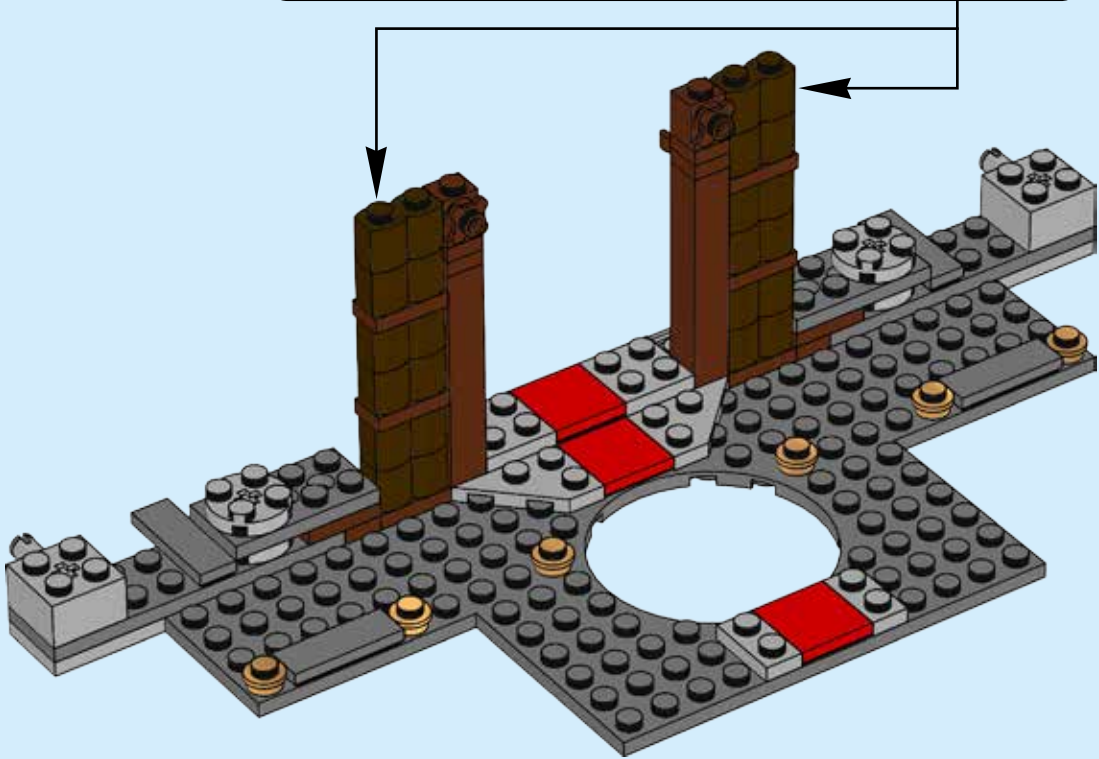
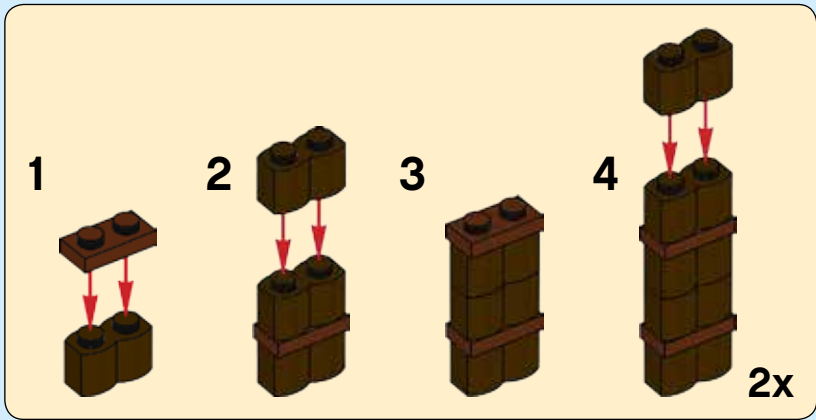

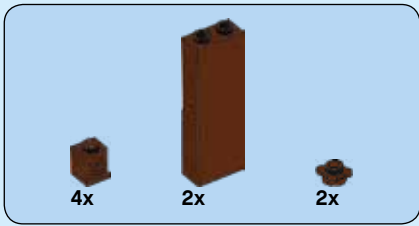

# 11

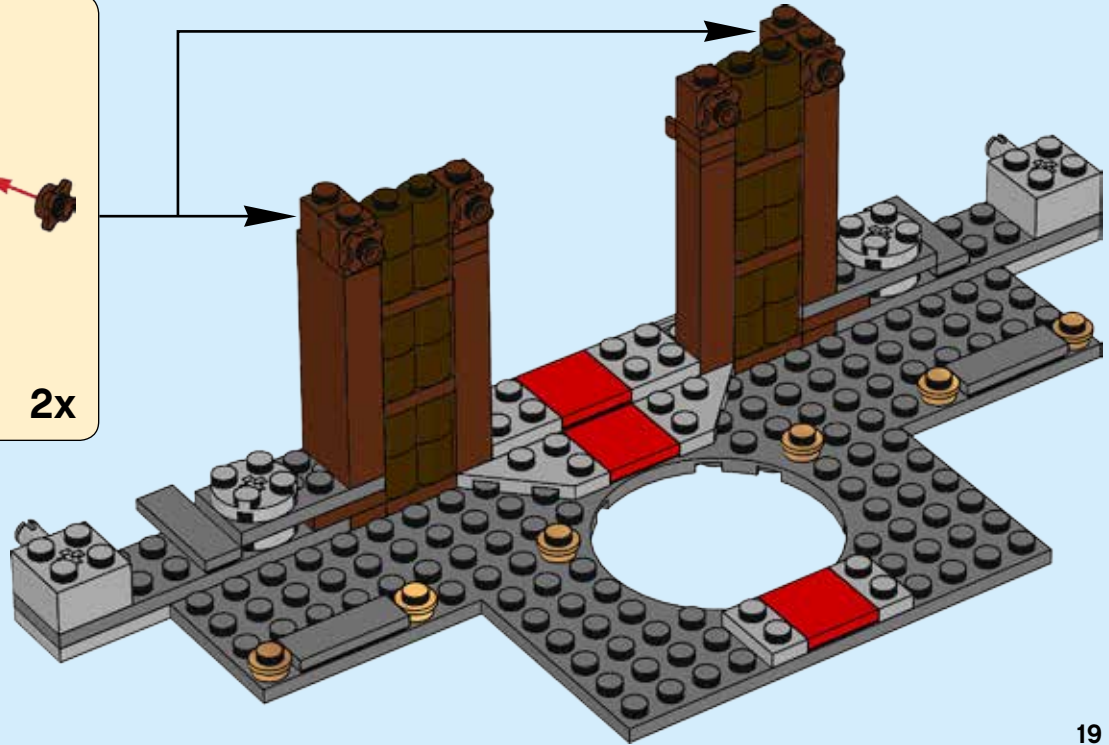
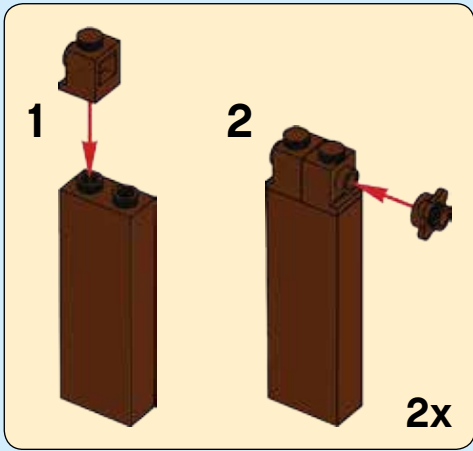

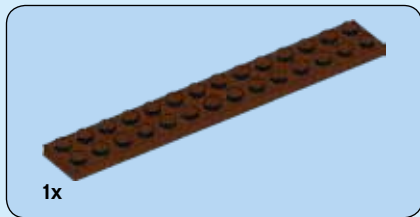

# 12

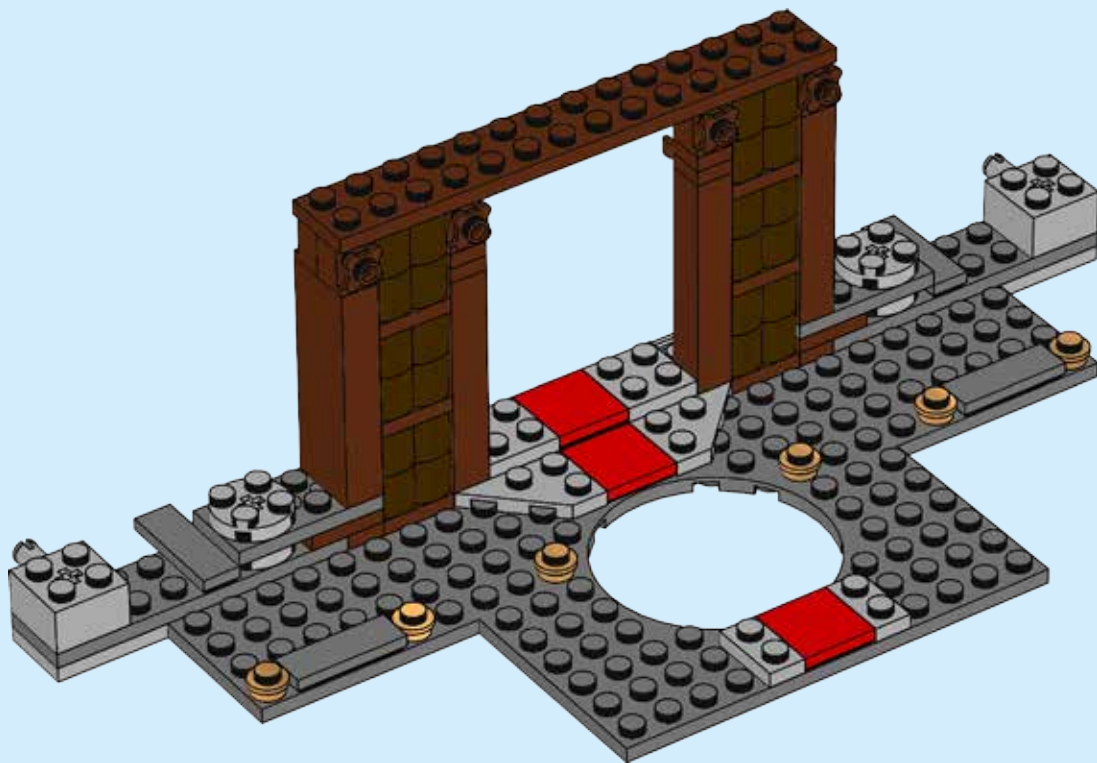



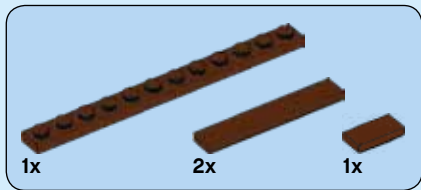

13

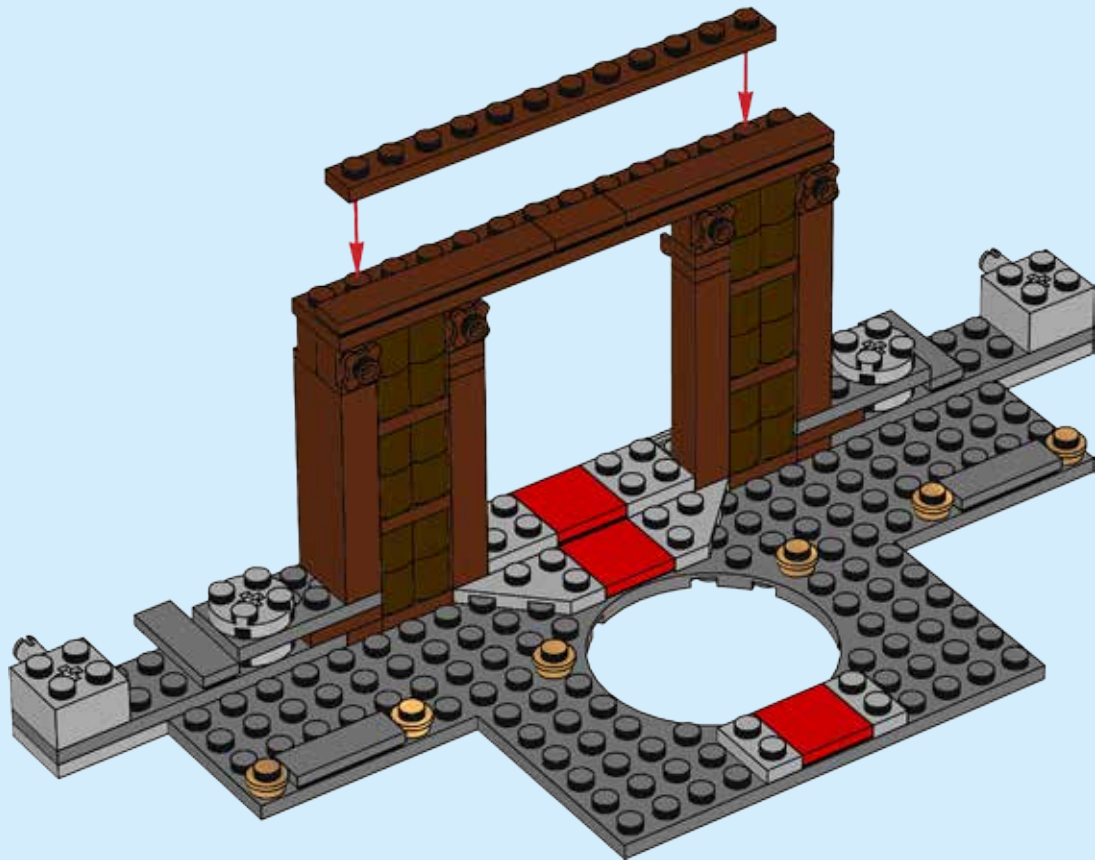

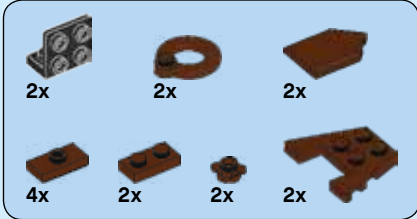

# 14

1

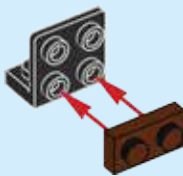

2



3



4



5



2x

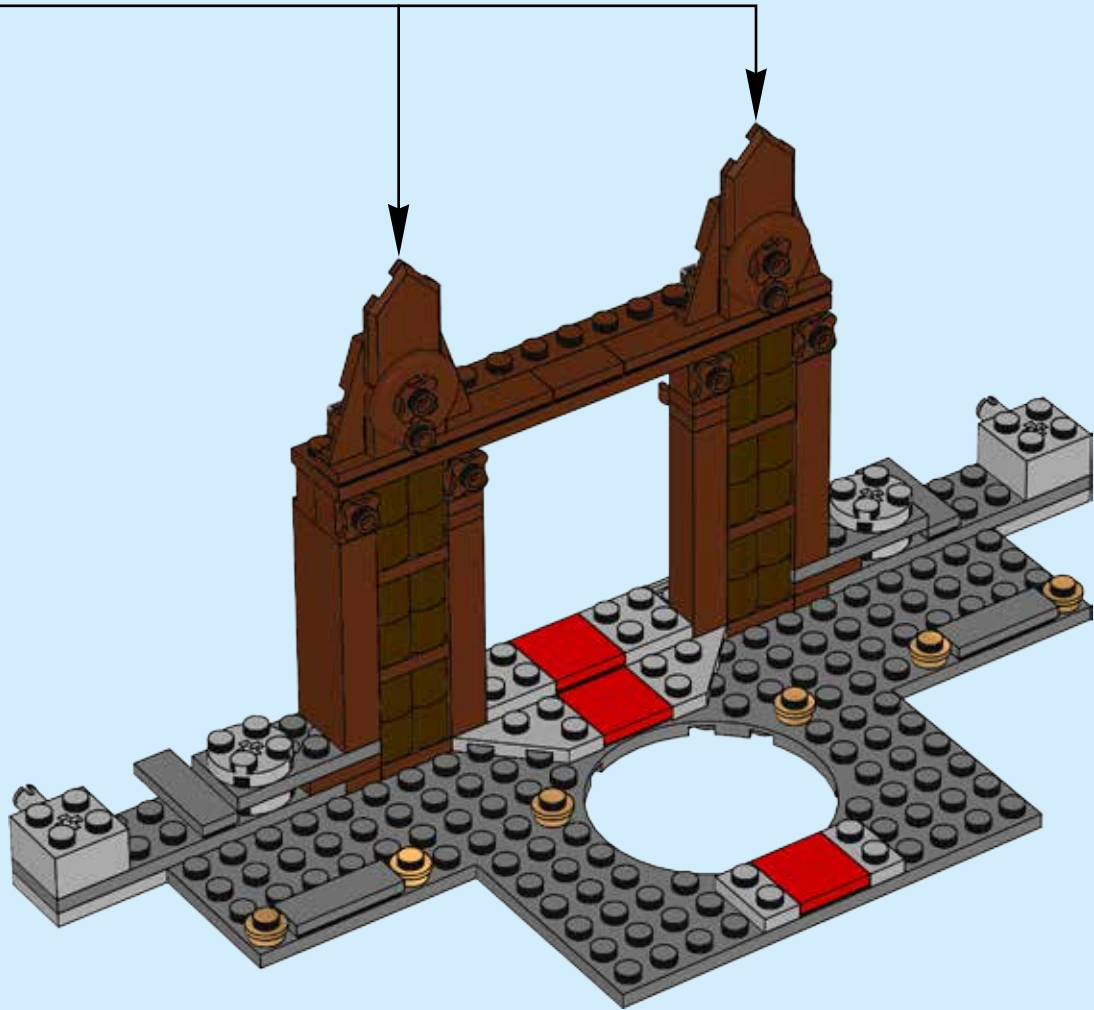



# 15

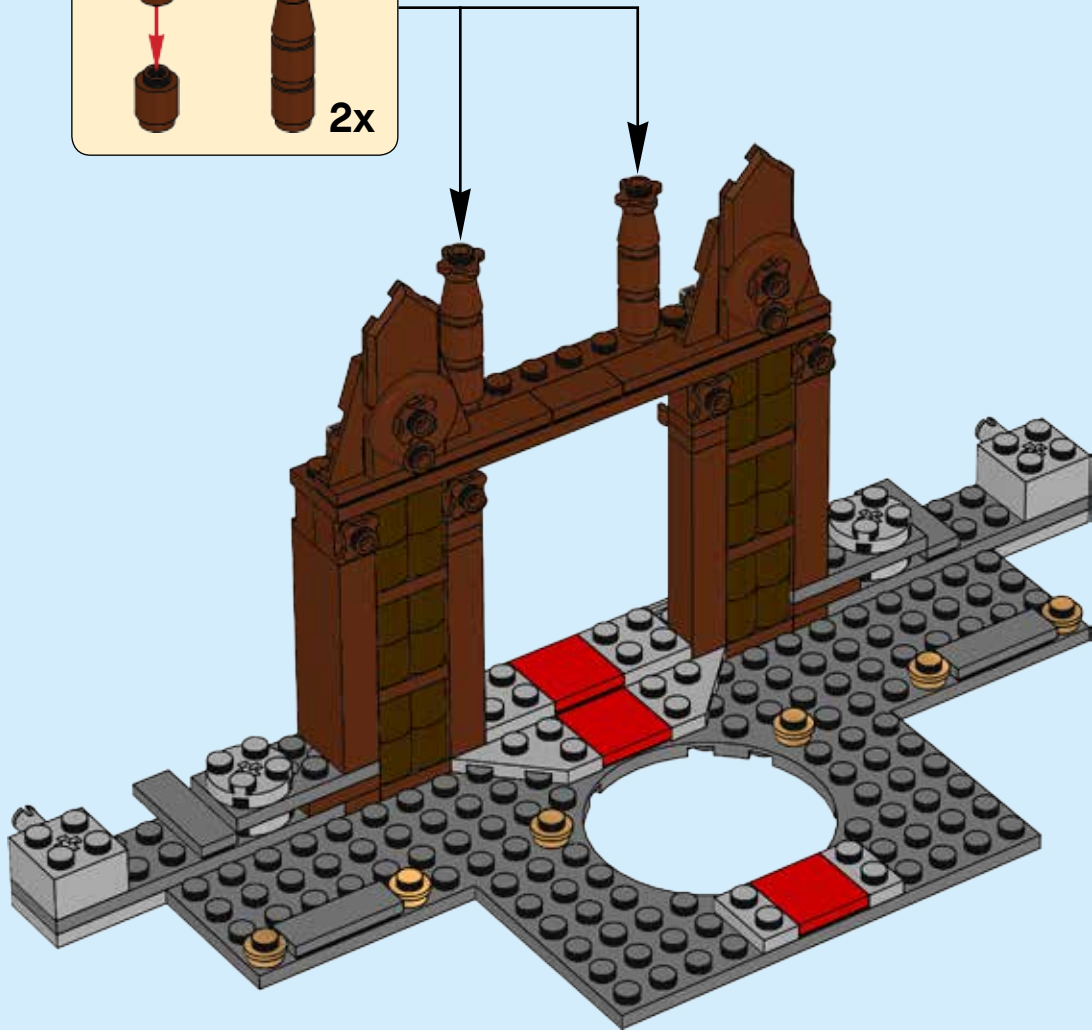
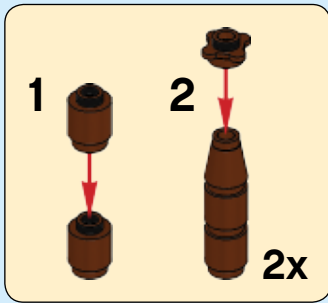



16

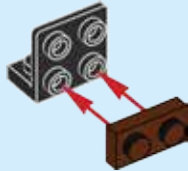

17

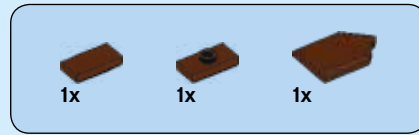

18



19



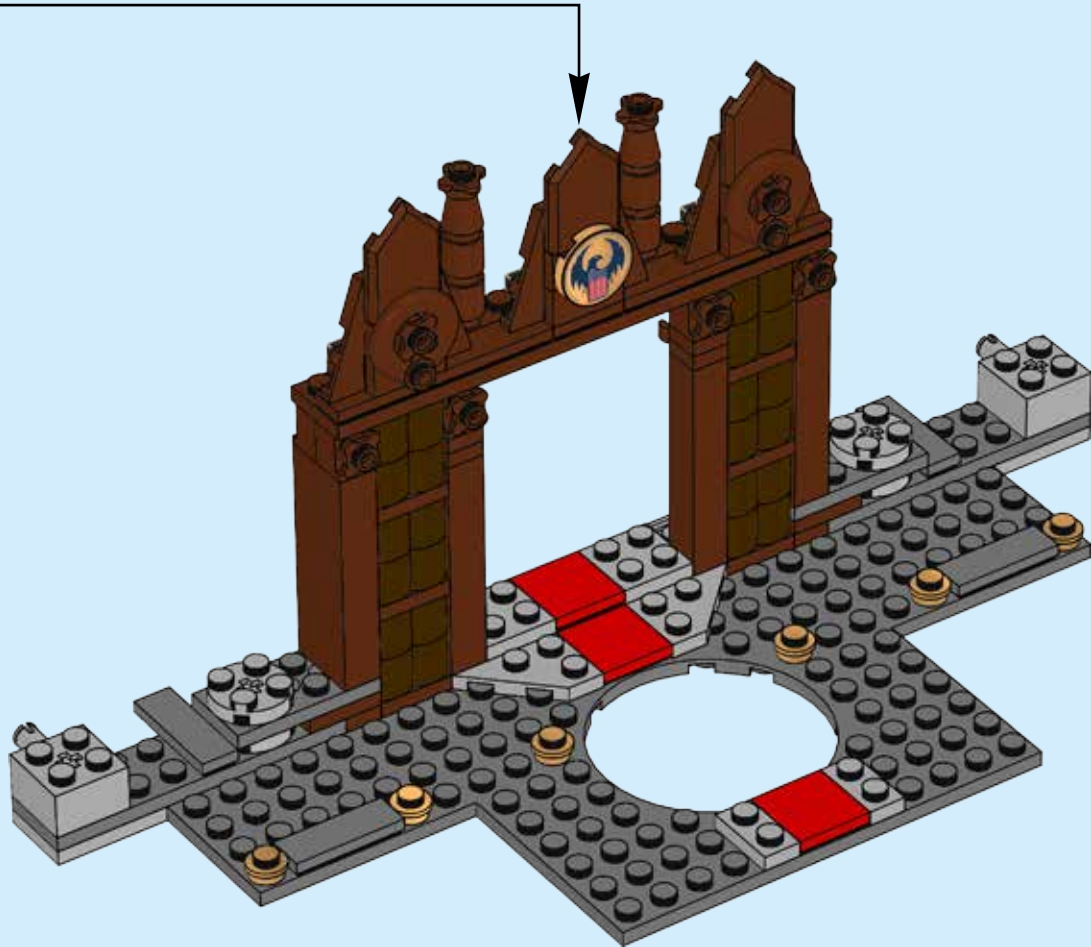



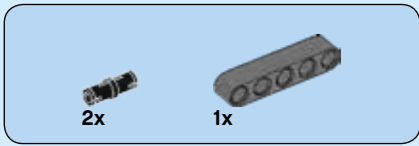

# 21

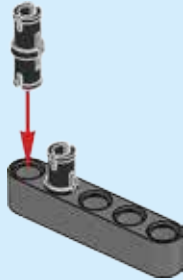

# 22

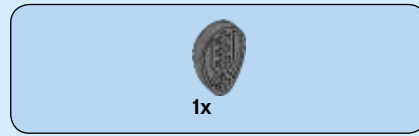
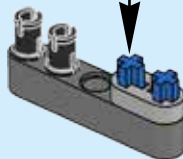
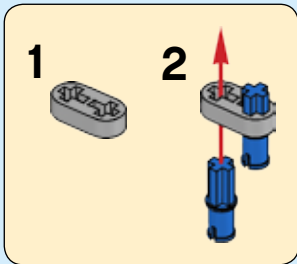

# 23

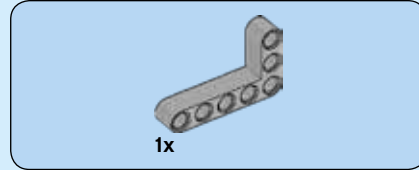
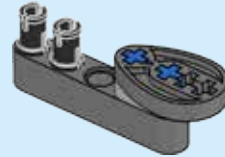

# 24

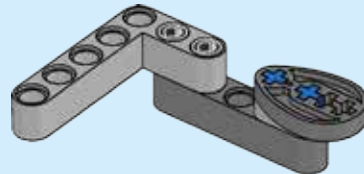

# 25

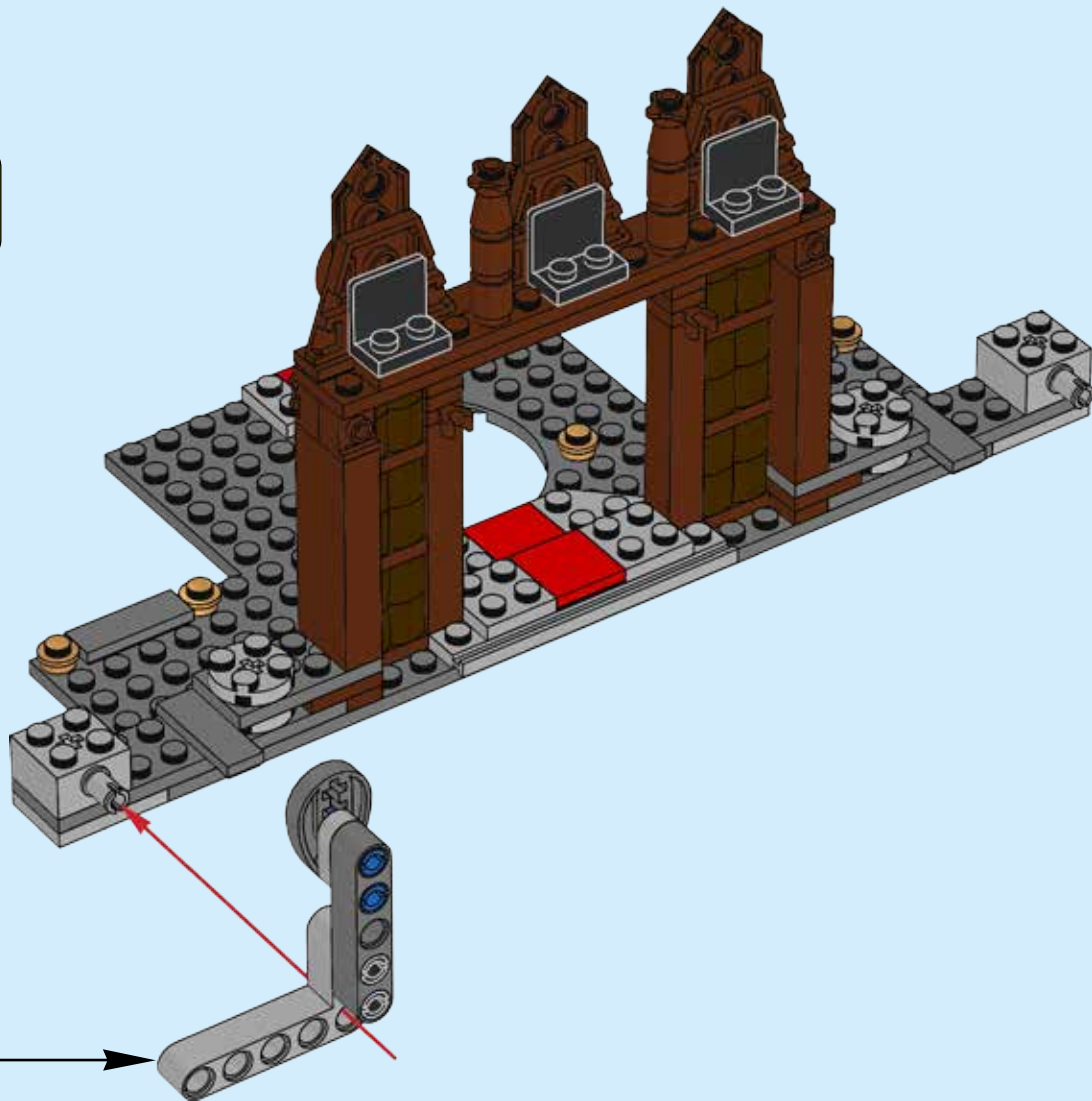
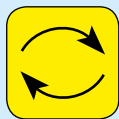

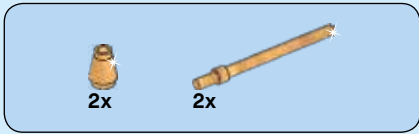

26

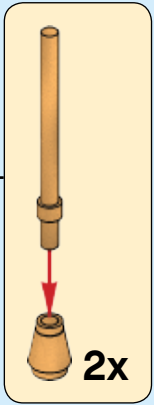
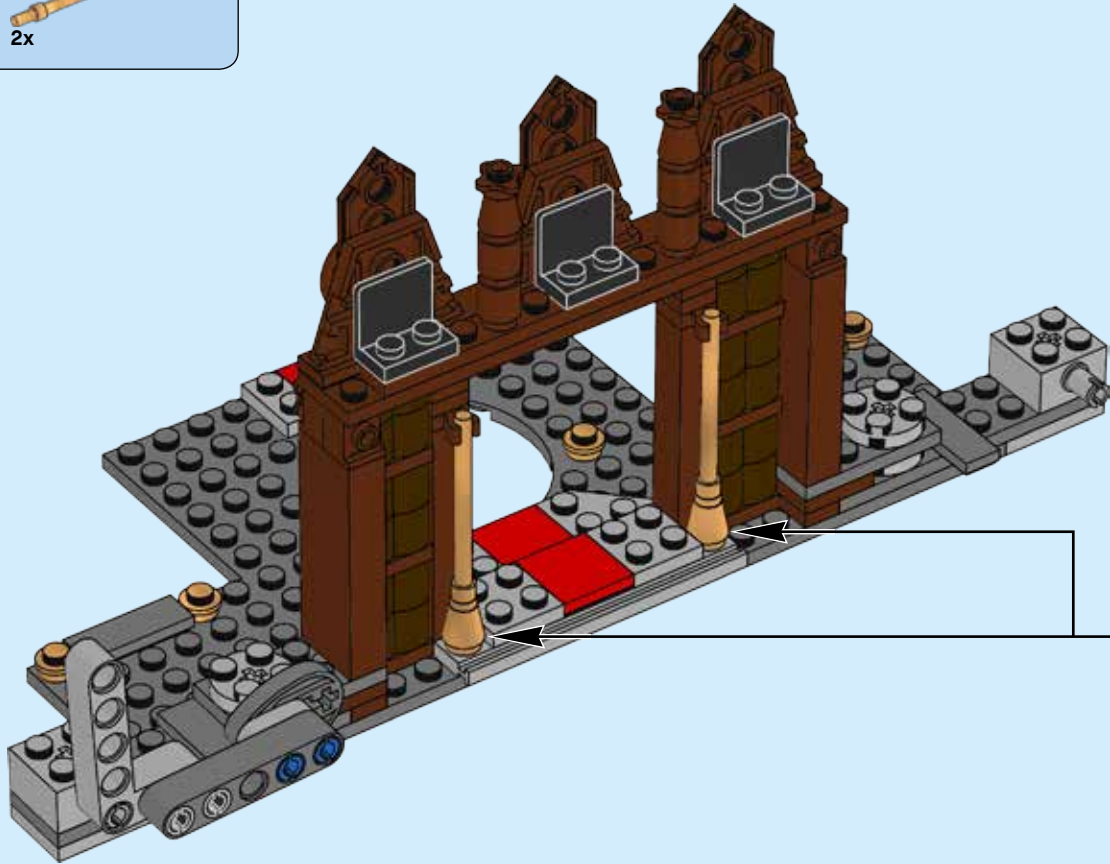



27

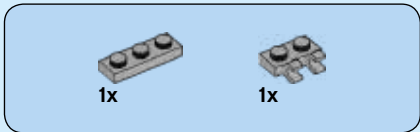

28

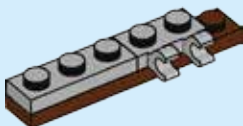

29

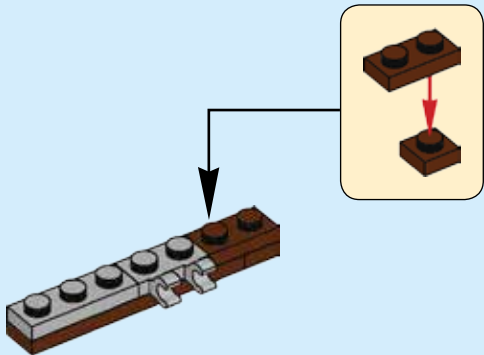

30

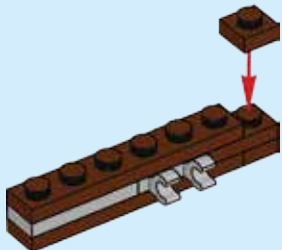

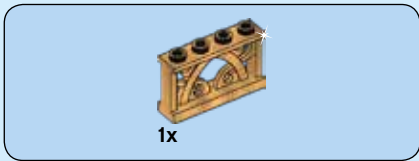

# 31

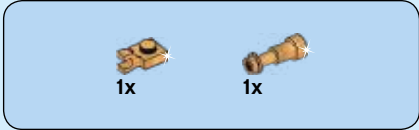
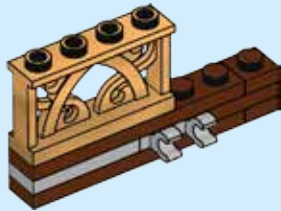

# 32

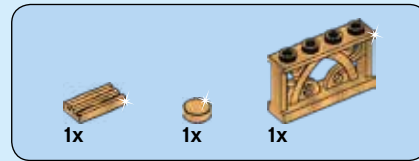
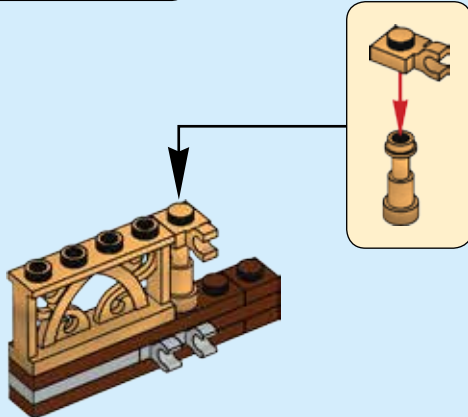

# 33

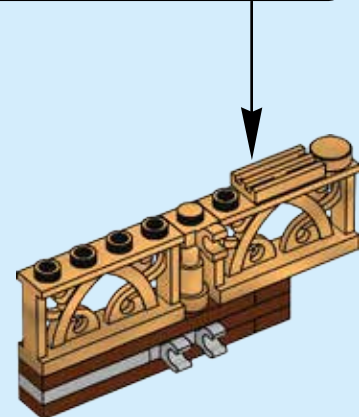
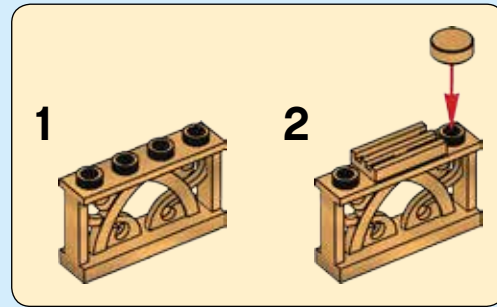



3x

# 34

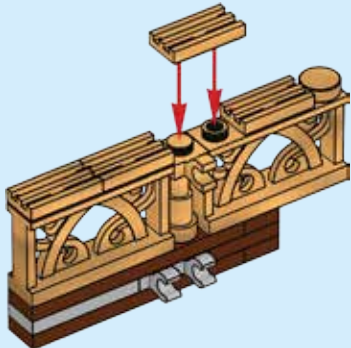

1x

# 35

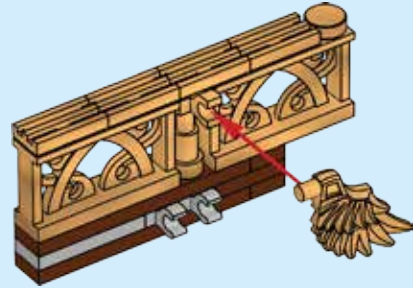

# 36

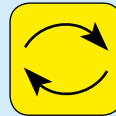



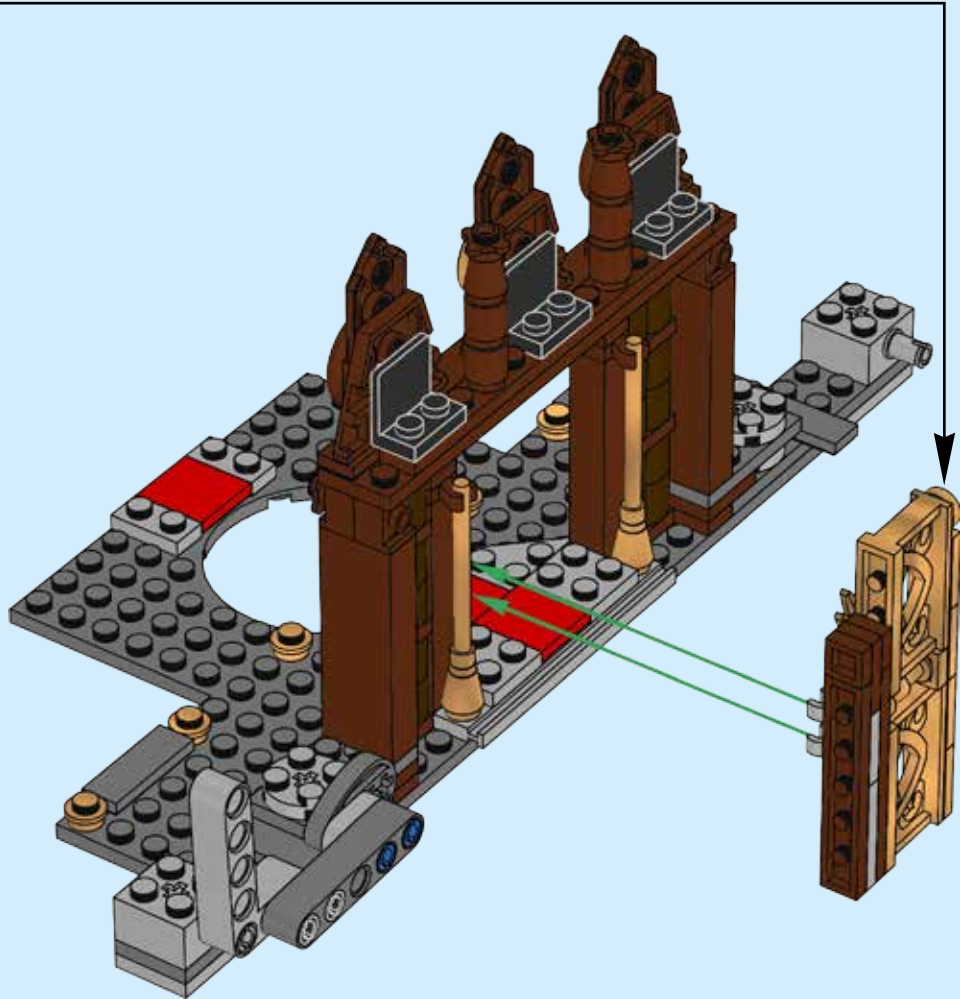

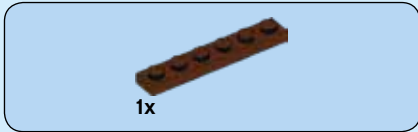

38

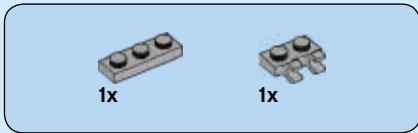

39

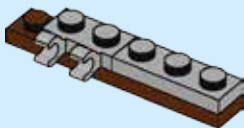

40

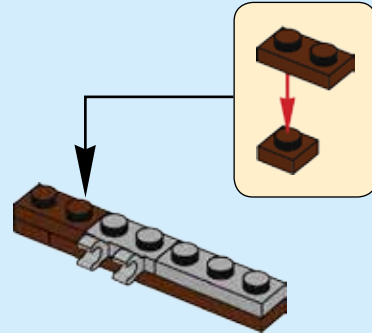

41

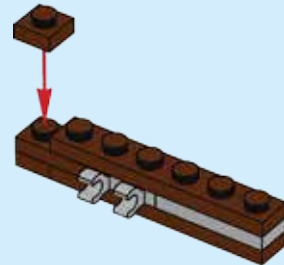

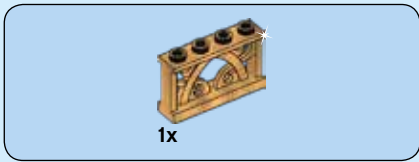

# 42

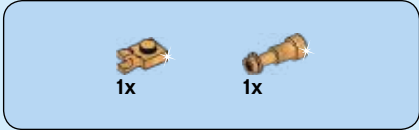
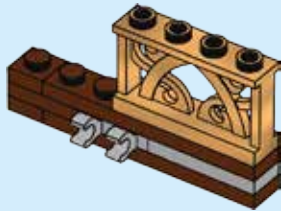

# 43

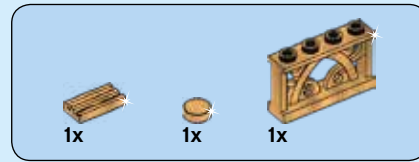
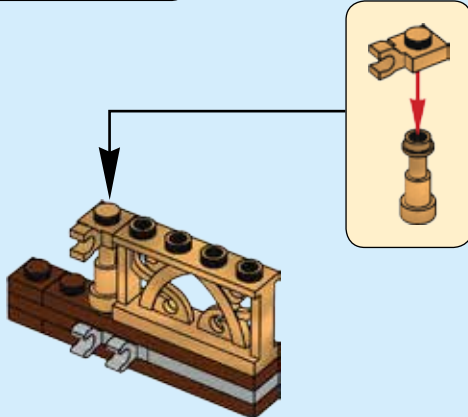

# 44

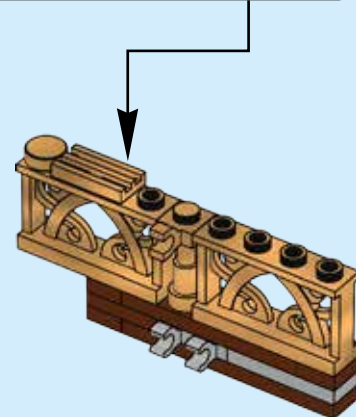
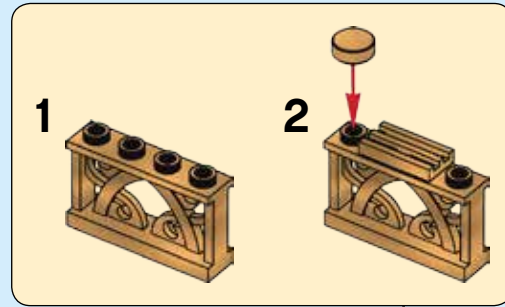



3x

# 45

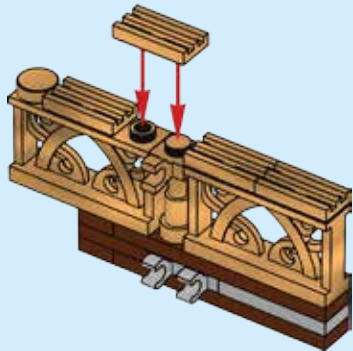

1x

# 46

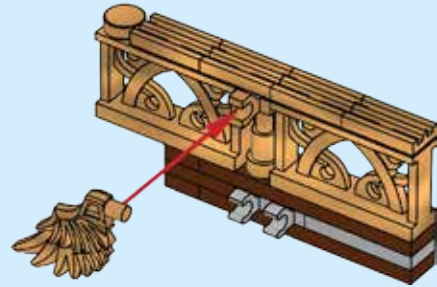

# 47

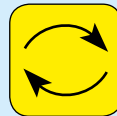

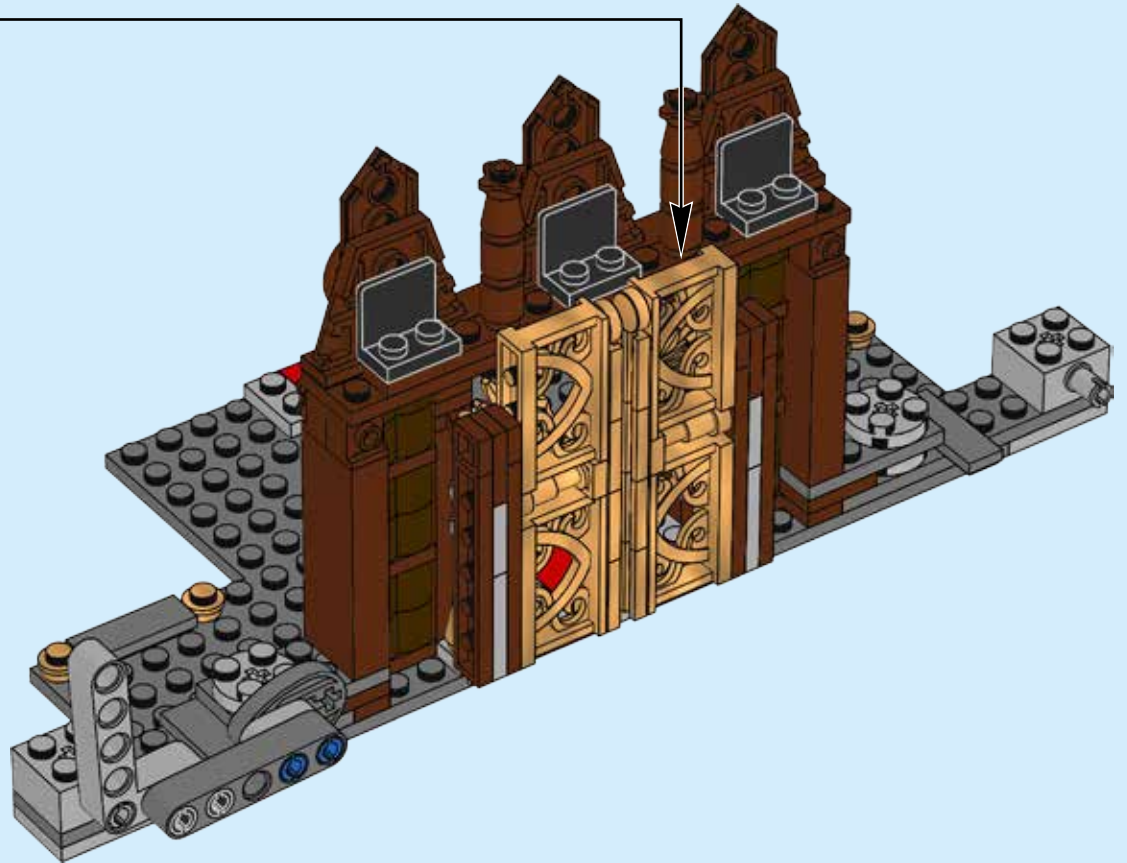

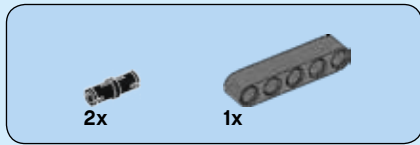

# 49

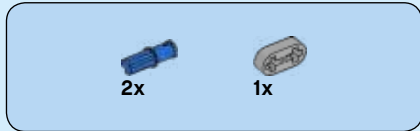
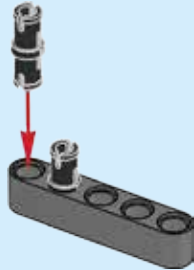

# 50

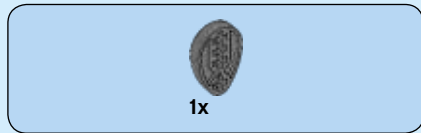
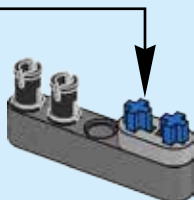
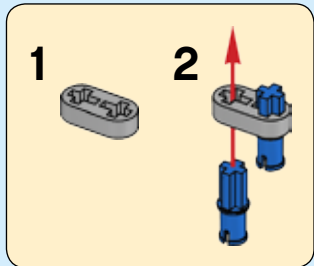

# 51

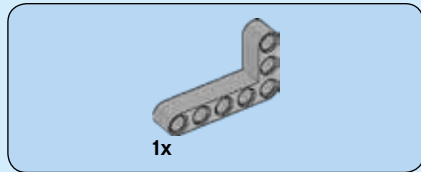
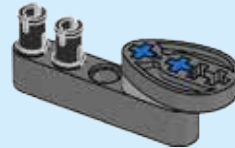

# 52

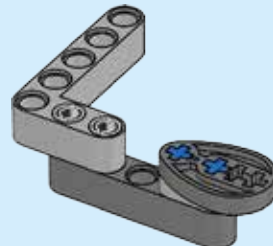



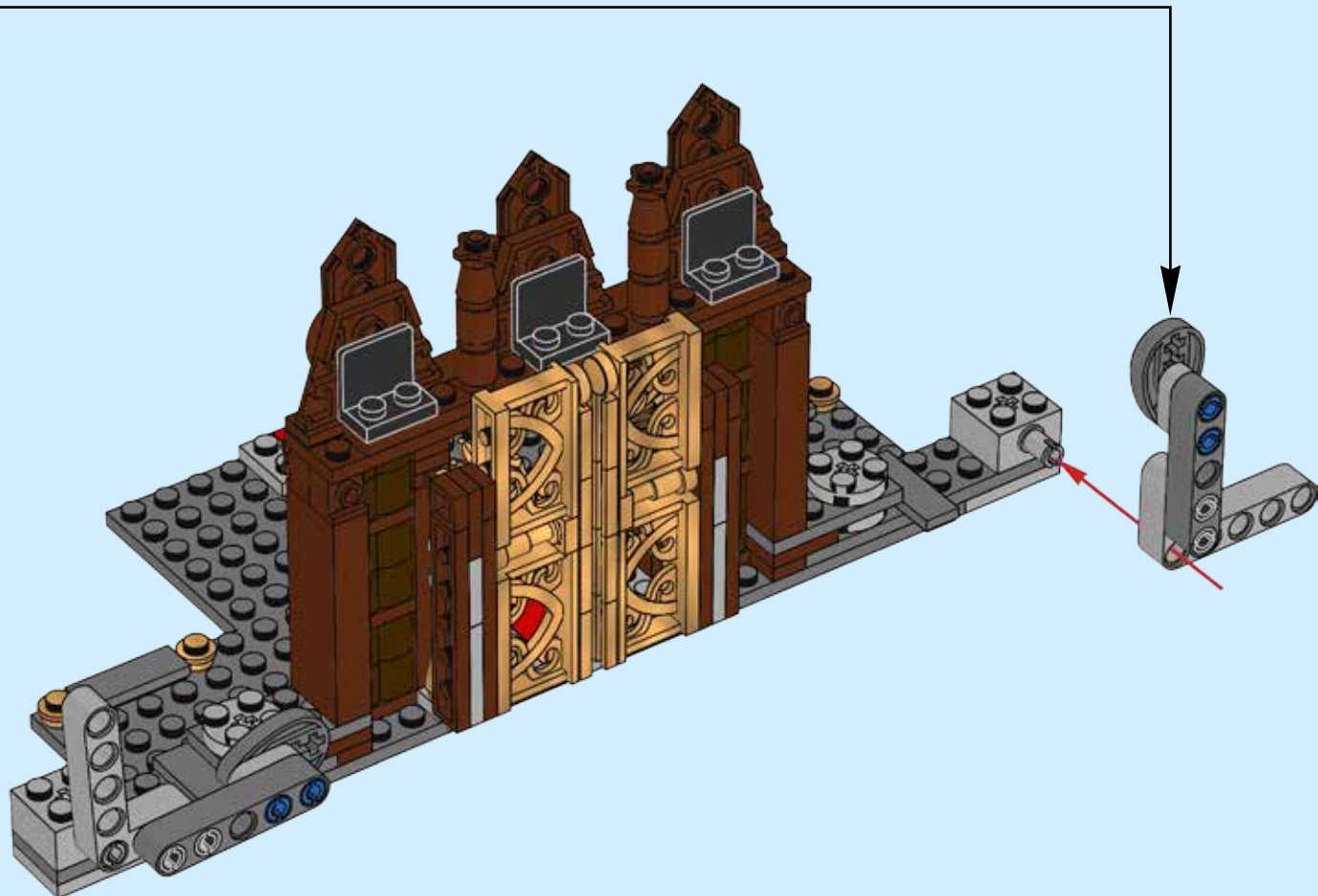

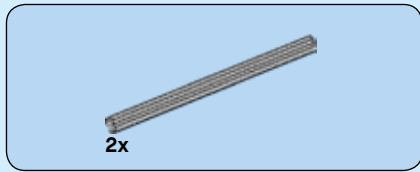

# 54

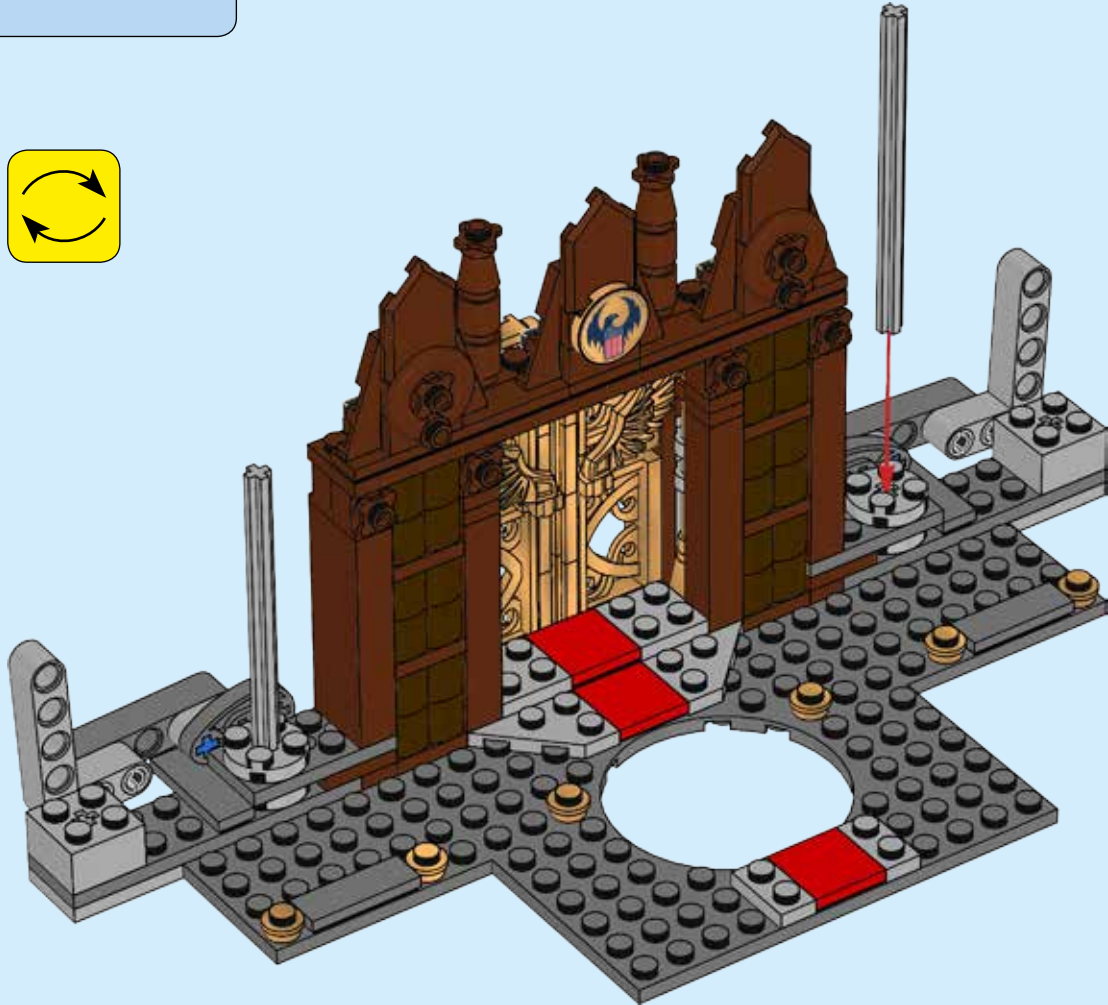
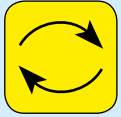

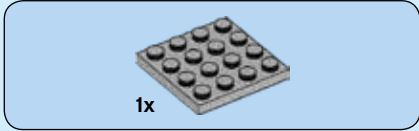

55

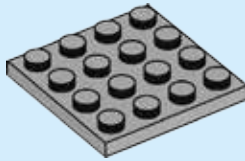

56



57

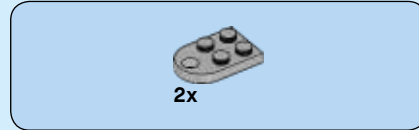

58

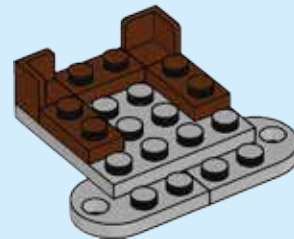



2x

# 59

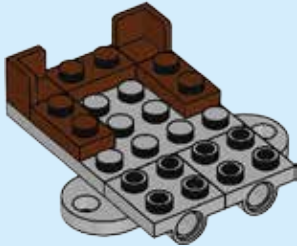

2x

# 60

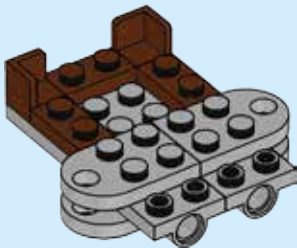

1x

# 61

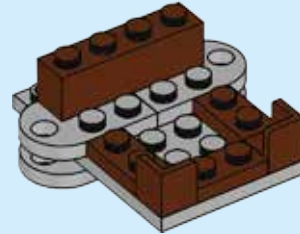
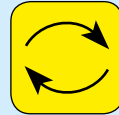

1x

# 62

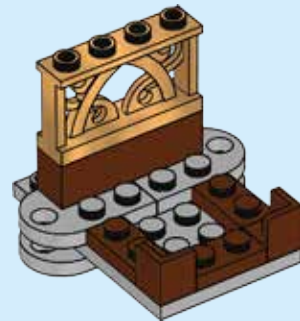

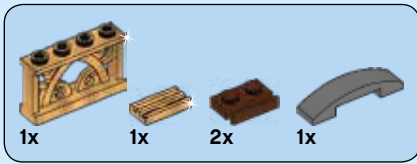

63

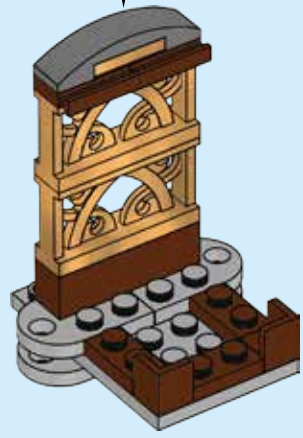
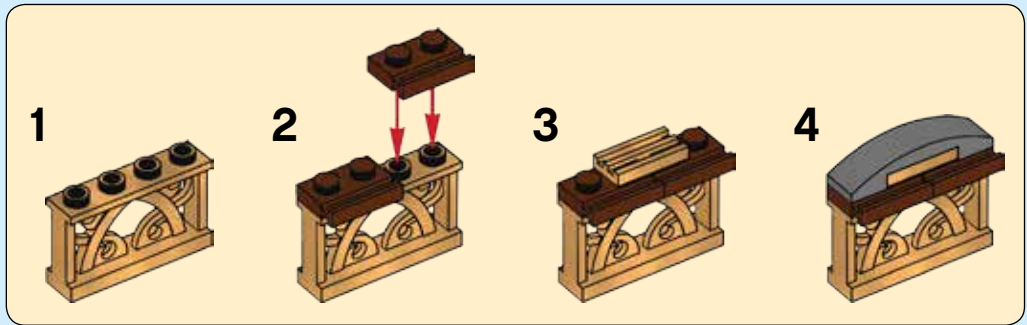

2x

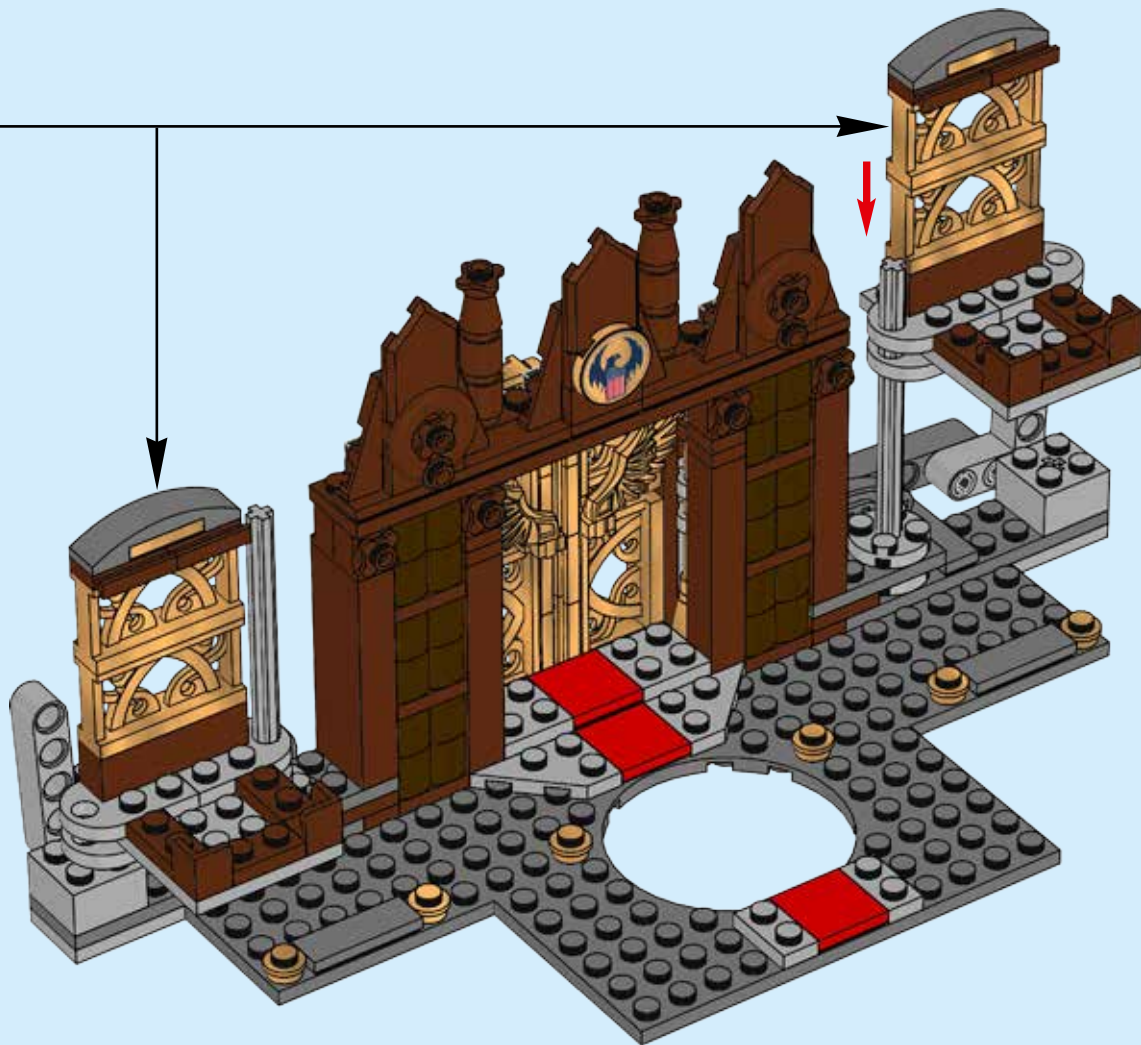



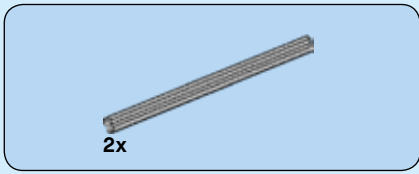

65

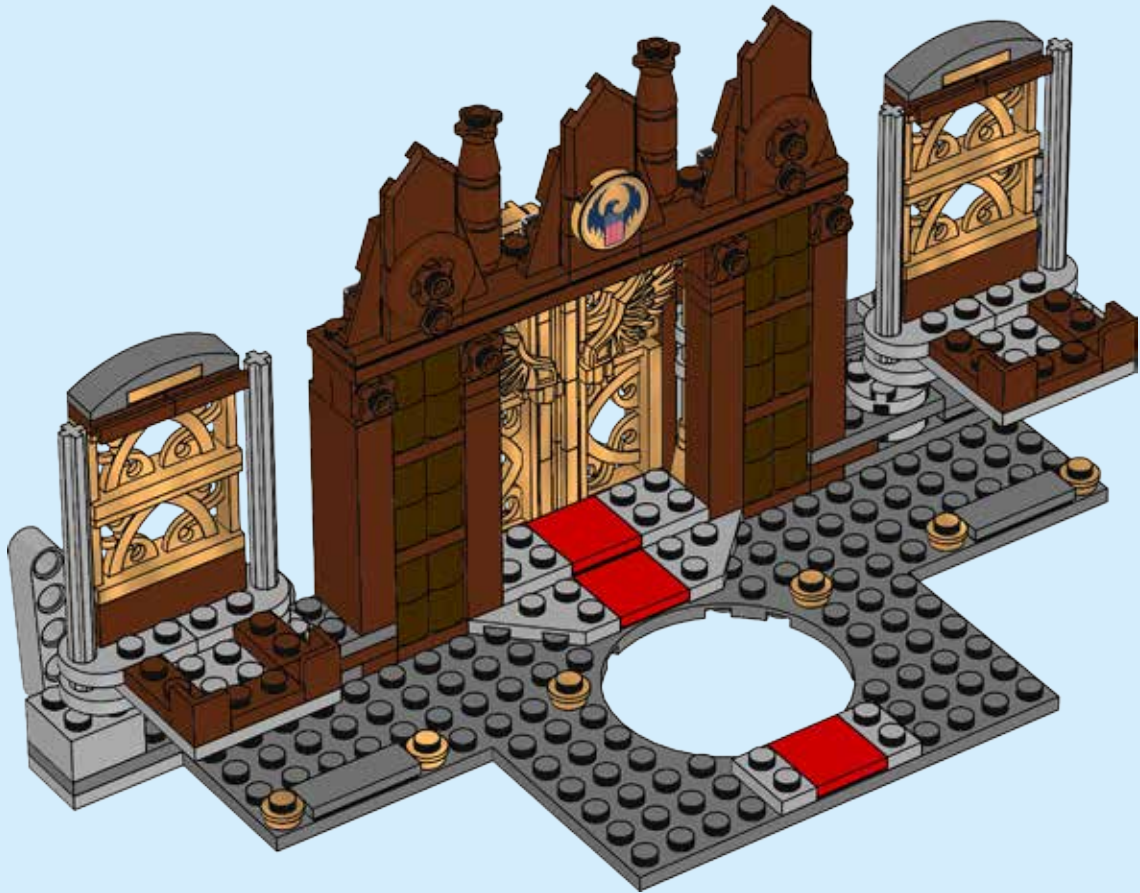

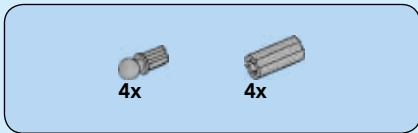

# 66

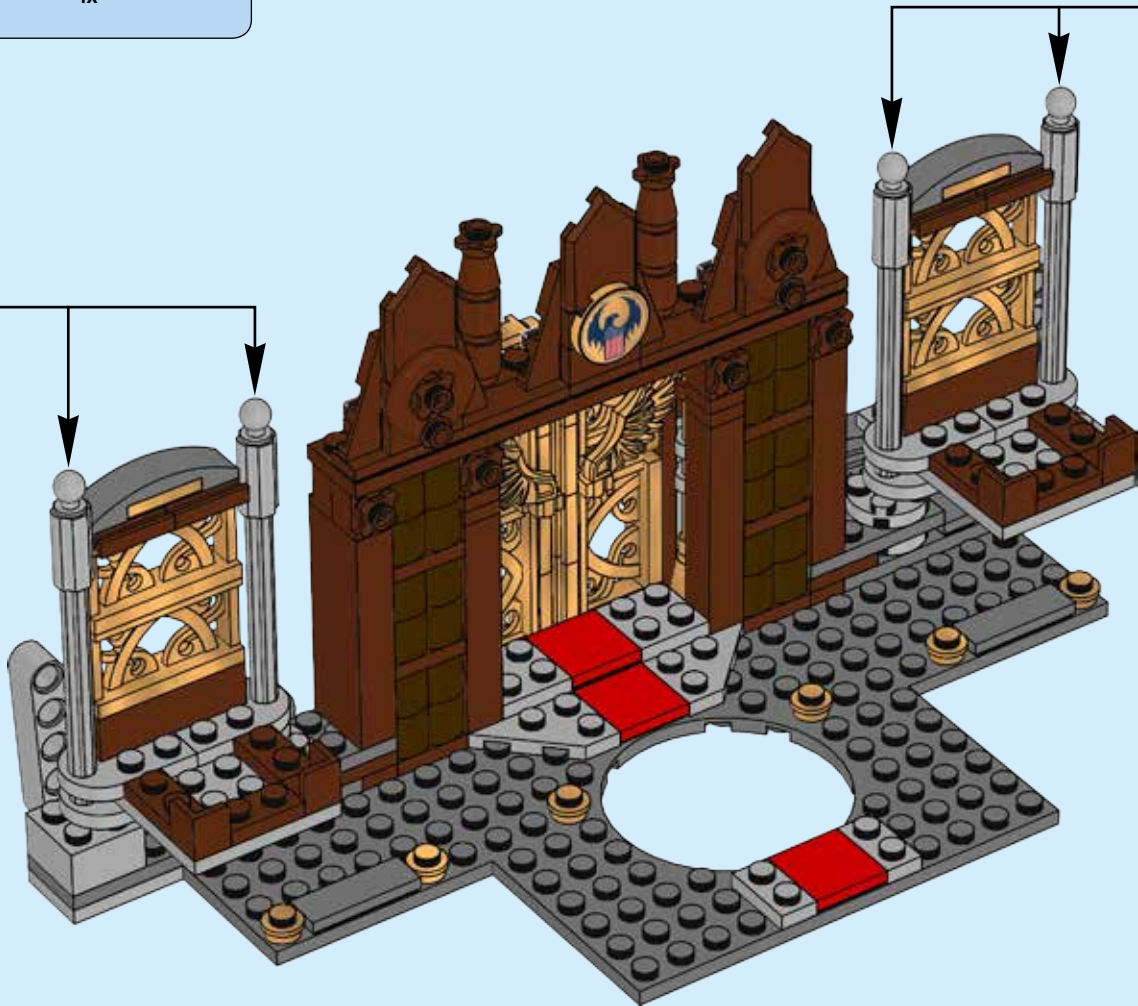
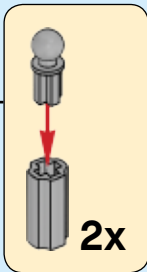
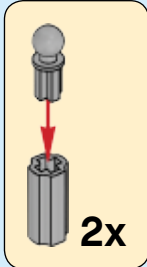

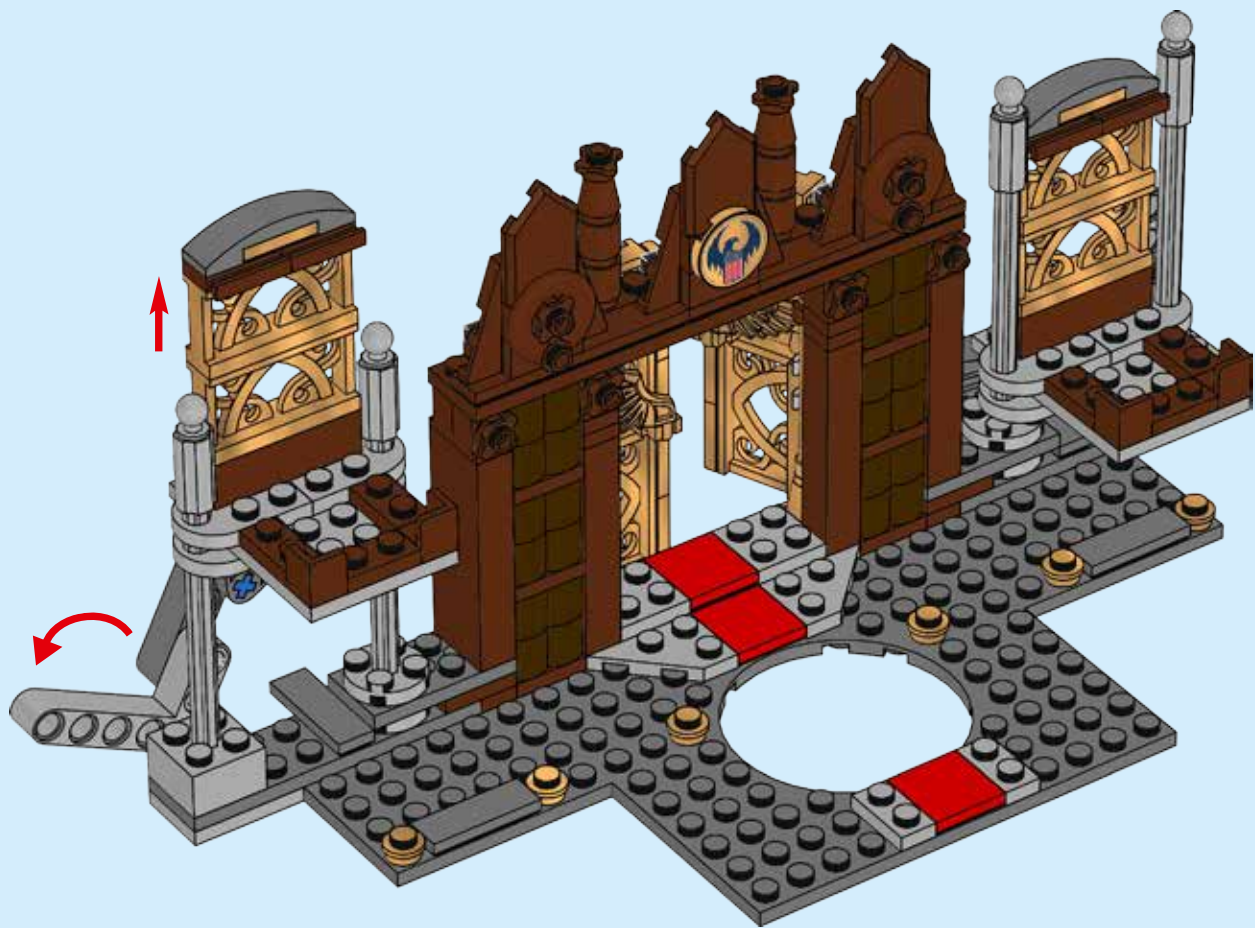

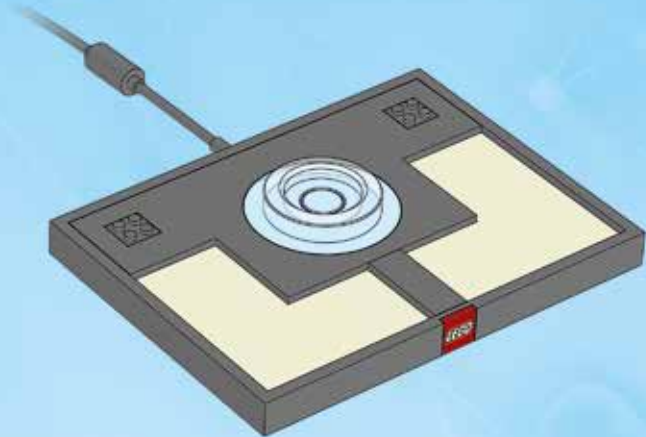

## Download the latest game content to use this character

- Lade dir die neusten Spielinhalte herunter, um diese Figur zu benutzen
- Télécharge le contenu le plus récent du jeu pour utiliser ce personnage
- Download det nyeste spilindhold for at bruge denne figur
- Download de nieuwste game-inhoud om deze figuur te kunnen gebruiken
- Ladda ner det senaste spelinnehållet för att använda den här karaktären
- Last ned det nyeste spillinnholdet for å ta i bruk denne figuren
- Pääset käyttämään tätä hahmoa lataamalla pelin uusimman sisällön
- Descarga la última actualización de contenido para usar este personaje
- Scarica gli ultimi contenuti del gioco per usare questo personaggio

Start game  
Spiel starten  
Commencer à jouer

Start spillet  
Game starten  
Starta spelet

Aloita peli  
Iniciar juego  
Avvia il gioco



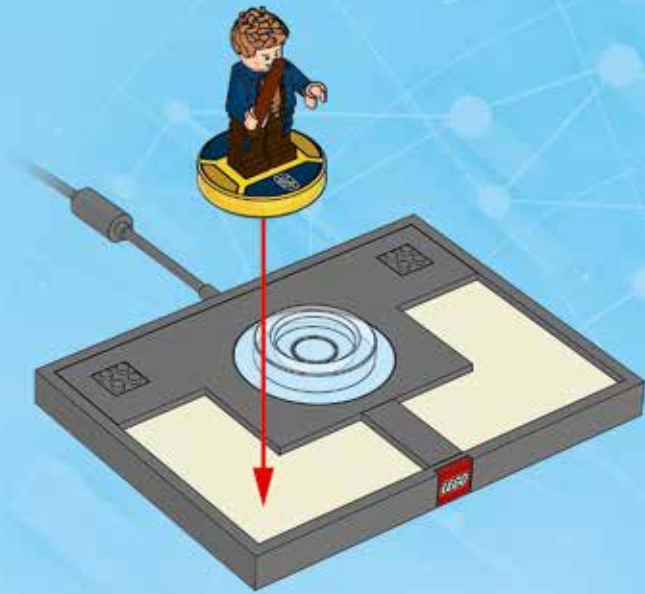



- Building is part of playing the game
- Das Bauen ist Teil des Spiels
- La construction fait partie du jeu
- Byggeri er en del af spillet
- Bouwen is een onderdeel van het spel
- Byggandet är en del av spelet
- Byggingen er en del av spillet
- Peliin kuuluu myös rakennustehtäviä
- Construir forma parte del juego
- La costruzione fa parte del gioco



# DIMENSIONS™

FUN PACKS  
SPAß-PAKETE  
PACK HÉROS  
PRET-PAKKETTEN  
PACCHETTI DIVERTIMENTO



71233



71236



71237



71239



71240



71241



71251



71257



71258





# DIMENSIONS™

LEVEL PACKS  
LEVEL-PAKETE  
PACK AVENTURE  
LEVEL-PAKKETTEN  
PACCHETTI LIVELLO



71245



71244



71248



# DIMENSIONS

TEAM PACKS  
TEAM-PAKETE  
PACK ÉQUIPE  
TEAM-PAKKETTEN  
PACCHETTI SQUADRA

## ADVENTURE TIME



71246



# DIMENSIONS™

TEAM PACKS  
TEAM-PAKETE  
PACK ÉQUIPE  
TEAM-PAKKETTEN  
PACCHETTI SQUADRA

## Harry Potter™



— [ ] — 71247 — [ ] —



# DIMENSIONS

TEAM PACKS  
TEAM-PAKETE  
PACK ÉQUIPE  
TEAM-PAKKETTEN  
PACCHETTI SQUADRA

## GREMLINS



71256





# DIMENSIONS™

STORY PACKS  
STORY-PAKETE  
PACKS HISTOIRE  
PACCHETTI STORIA

## GHOSTBUSTERS™



71242



# DIMENSIONS™

STORY PACKS  
STORY-PAKETE  
PACKS HISTOIRE  
PACCHETTI STORIA

FROM J.K. ROWLING'S  
WIZARDING WORLD  
**FANTASTIC  
BEASTS**  
AND WHERE  
TO FIND THEM



71253



4x  
6053077



2x  
6020193



4x  
6045988



4x  
4211375



2x  
6163332



1x  
614126



3x  
6000650



2x  
4211429



2x  
4211741



3x  
6163191



2x  
4558954



3x  
306821



2x  
4211529



4x  
4211475



1x  
611644



2x  
307026



3x  
306821



8x  
4211419



1x  
4657459



1x  
6157593



2x  
4517925



4x  
4206482



2x  
4211396



2x  
4210759



2x  
6079000



4x  
4121715



4x  
4512360



2x  
4211361



4x  
4568734



1x  
6170143



2x  
609126



2x  
4211398



2x  
4211713



2x  
4648256



12x  
4519970



2x  
6047276



2x  
4556157



1x  
4211498



2x  
4227398



1x  
6163633



6x  
302326



2x  
4211397



1x  
4211498



2x  
4210686



1x  
6162768



1x  
6132731



2x  
4243797



4x  
4535768



2x  
4210997



1x  
6163938



1x  
6163945





2x  
4523160



1x  
6164126



10x  
4490599



2x  
6092594



2x  
4538126



2x  
6097514



8x  
6097234



2x  
6081992



11x  
4523159



2x  
4529247



2x  
4649422



4x  
4211183



2x  
4529242



8x  
4623429



6x  
4225469



4x  
4645400



6x  
4221744



2x  
6066142



2x  
4226966



2x  
4277016



2x  
4277016



5x  
6092590



20x  
4211150



2x  
4211151



2x  
6132812



4x  
4645103



1x  
6075208



2x  
4216695



3x  
6163184



2x  
4211225



3x  
4649052



2x  
4211204

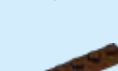

4x  
4221590

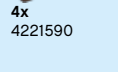

1x  
6055145



1x  
6004996

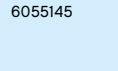

1x  
6117642

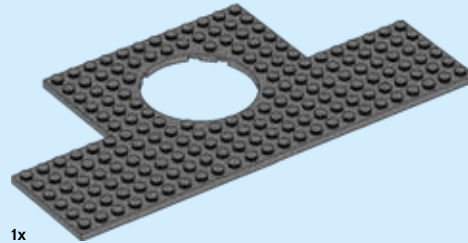

1x  
6117642



Customer Service  
Kundenservice  
Service Consommateurs  
Kundeservice  
Klantservice  
Kundtjänst  
Asiakaspalvelu  
Atención al cliente  
Assistenza clienti  
[LEGO.com/DIMENSIONS/service](http://LEGO.com/DIMENSIONS/service)

# CHEAT CODES

GO TO [LEGO.COM/DIMENSIONSfeedback](https://LEGO.COM/DIMENSIONSfeedback) AND  
GIVE US YOUR SHORT **FEEDBACK** ABOUT THIS  
LEGO® VIDEO GAME TO UNLOCK  
AWESOME CHEAT CODES.



Terms & Conditions apply

## [LEGO.com/DIMENSIONSfeedback](https://LEGO.com/DIMENSIONSfeedback)

### GEHEIM-CODES

Geh auf [LEGO.com/DIMENSIONSfeedback](https://LEGO.com/DIMENSIONSfeedback) und verrate uns deine Meinung zu diesem LEGO® Videospiel, um tolle Geheim-Codes freizuschalten.

*Es gelten die Nutzungsbedingungen.*

### COUPS DE POUCE

Rendez-vous sur [LEGO.com/DIMENSIONSfeedback](https://LEGO.com/DIMENSIONSfeedback) pour évaluer ce jeu vidéo LEGO® et débloquent de super coups de pouce !

*Offre soumise à conditions.*

### CHEATCODES

Ga naar [LEGO.com/DIMENSIONSfeedback](https://LEGO.com/DIMENSIONSfeedback), schrijf een kort commentaar op deze LEGO® video game en ontvang coole cheatcodes.

*Er zijn algemene voorwaarden van toepassing.*

### CÓDIGOS DE TRUCOS

Visita [LEGO.com/DIMENSIONSfeedback](https://LEGO.com/DIMENSIONSfeedback) y envíanos una breve opinión sobre este videojuego LEGO® para desbloquear asombrosos códigos de trucos.

*Sujeto a términos y condiciones.*