

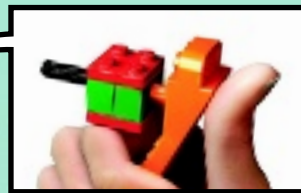

ULTRA AGENTS

70169





LEGO.com/brickseparator



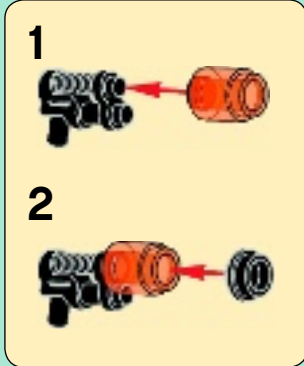
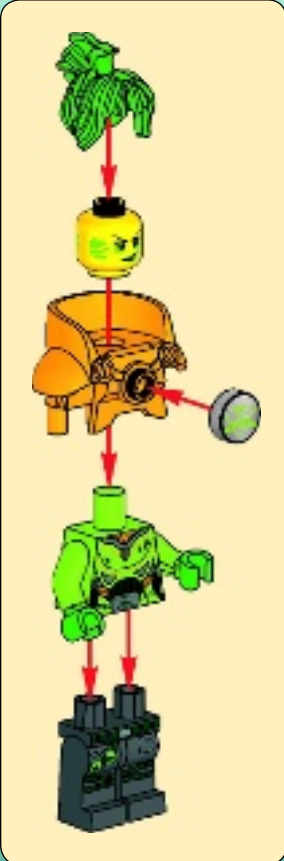

- EN IMPORTANT: Never modify the elements or use other projectiles than provided with this toy.
 DE WICHTIG: Die Elemente dürfen nicht verändert werden. Es dürfen ausschließlich die mit dem Spielzeug mitgelieferten Geschosse verwendet werden.
 FR IMPORTANT : Ne jamais modifier les éléments ni utiliser d'autres projectiles que ceux fournis avec ce jouet.
 IT IMPORTANTE: non modificare gli elementi o utilizzare proiettili non forniti con questo prodotto.
 NL BELANGRIJK! Verander niets aan de elementen en gebruik geen andere projectielen dan de bij het speelgoed geleverde.
 ES IMPORTANTE: No modifique los elementos ni utilice otros proyectiles diferentes a los suministrados junto con este juguete.
 DA VIGTIGT: Elementerne må ikke ændres, og der må ikke bruges andre projektiler end dem, der følger med legetøjet.
 FI TÄRKEÄÄ: Älä koskaan tee osiin muutoksia tai käytä lelussa muita kuin sen sisältyviä ammuksia.
 SV VIKTIGT: Modifiera aldrig delarna och använd aldrig andra projektiler än de som medföljer denna leksak.
 PT IMPORTANTE: Nunca modifique os elementos nem utilize projecteis que não tenham sido fornecidos com este brinquedo.
 EL ΣΗΜΑΝΤΙΚΟ: Ποτέ μην τροποποιείτε τα στοιχεία του παιχνιδιού και μην χρησιμοποιείτε άλλα βλήματα εκτός από αυτά που συνοδεύουν αυτό το παιχνίδι.
 JA 重要：部品を改造したり、本製品に付属の発射体以外のものを使用しないでください。
 ZH 重要提示：切勿更改组件或使用并非由本玩具附带的弹丸。
 KO 중요함: 이틀 부품을 수정하거나 이 완구와 함께 제공된 것이 아닌 발사체는 결코 사용하지 마십시오.
 RU ВАЖНО: запрещается вносить изменения в элементы или использовать другие снаряды, отличные от тех, которые поставляются с данной игрушкой.
 PL WAŻNE: Nigdy nie modyfikować elementów zabawki ani nie używać pocisków innych niż dostarczone z zabawką.
 CZ UPOZORNĚNÍ: Nikdy neupravujte součástky a nepoužívejte jiné projektily než ty, které jsou dodávány s touto hračkou.
 SK UPOZORNENIE: Nikdy neupravujte súčiastky a nepoužívajte iné projektily než tie, ktoré sú dodávané s touto hračkou.
 HU FONTOS: Az elemeket nem szabad módosítani, és a játékhöz adott lövedékek helyett sem szabad mást használni.
 UA ВАЖЛИВО: забороняється вносити зміни до елементів або використовувати інші снаряди на відміну від тих, що поставляються з цією іграшкою.
 HR VAŽNO: Nemojte nikad mijenjati elemente ili koristiti druge projektile osim onih koji su bili priloženi uz ovu igračku prilikom kupnje.
 SR Важно: Немојте да модификујете елементе и не користите друге пројектиле осим оних који долазе уз ову играчку.
 SL POMEMBNO: Nikoli ne spreminjajte elementov in uporabljajte le izstrelke, ki so bili priloženi tej igrači.
 RO IMPORTANT: Nu modificați niciodată elementele și nu utilizați alte proiectile decât cele furnizate cu această jucărie.
 BG ВАЖНО: Не видоизменяйте елементите и не използвайте други снаряди освен приложените към тази играчка.
 LV SVARĪGĪ! Nekad nepārveidojiet rotālietas elementus, vienmēr izmantojiet tikai tās komplektā iekļautās lodītes.
 ET OLULINE: Mänguasja osi ei tohi teistega asendada, kasutada võib ainult kaasasolevat heitkeha.
 LT DĖMESIO! Niekuomet nekeiskite elementų ir naudokite tik tuos šovinius, kurie yra pridėti prie šio žaislo.
 TR ÖNEMLİ: Hiçbir zaman parçalarda değişiklik yapmayın veya bu oyuncakla sağlananlar dışında mermiler kullanmayın.

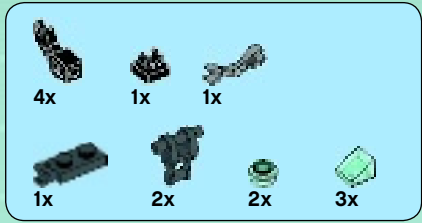

1



2



3



4



5

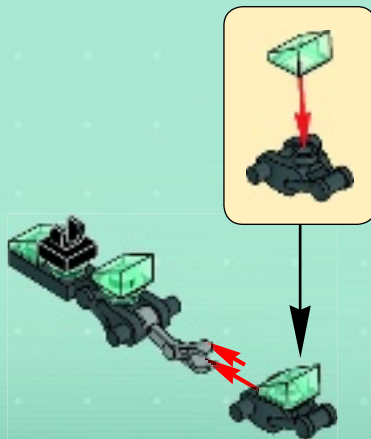

6



7

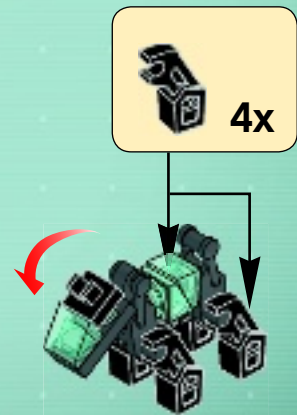



1x

1



2x

2

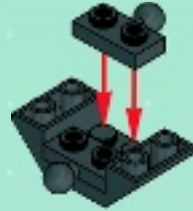

1x

3





2x

4



2x



1x

5



1x



2x

6



1



2





1x

7



2x

8





9

1



2



3



4

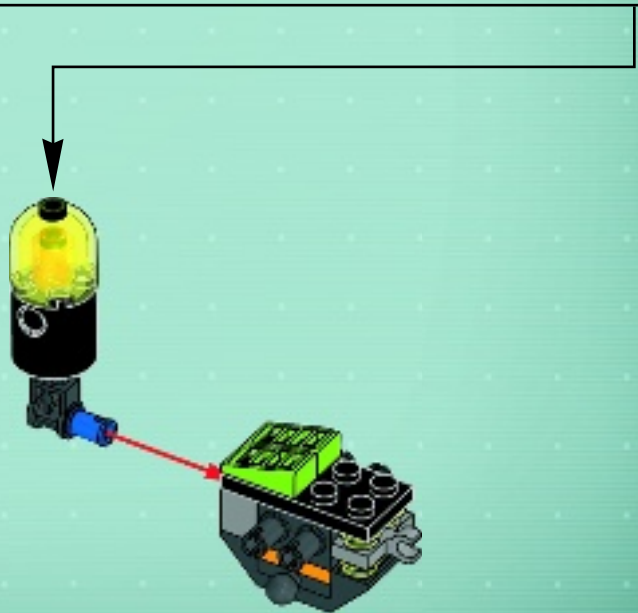



2x

10

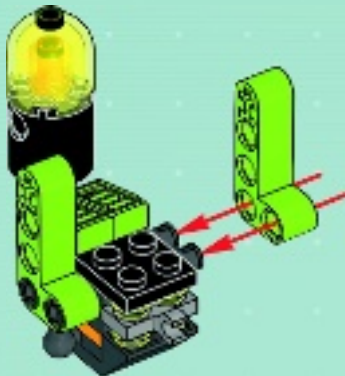

2x

11

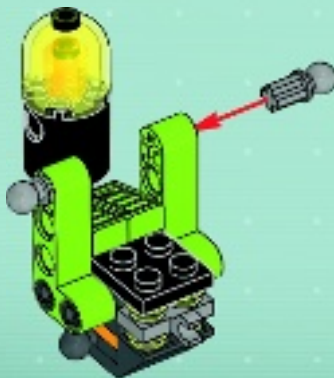

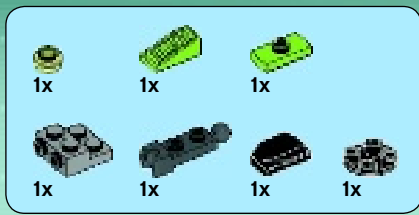

12



1

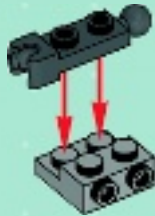

2

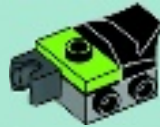

3



4

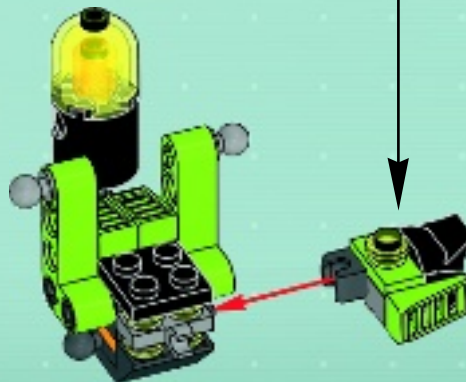

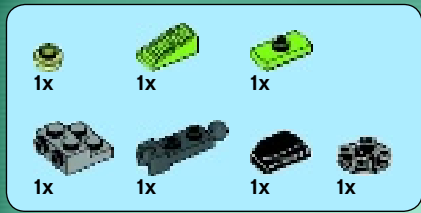

13

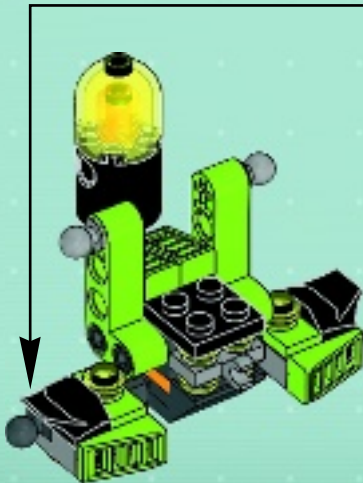
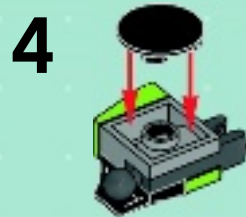



2x



1x

1



2x

2



1x

3



2x

4



2x

5



1x

2x

6



2x

14

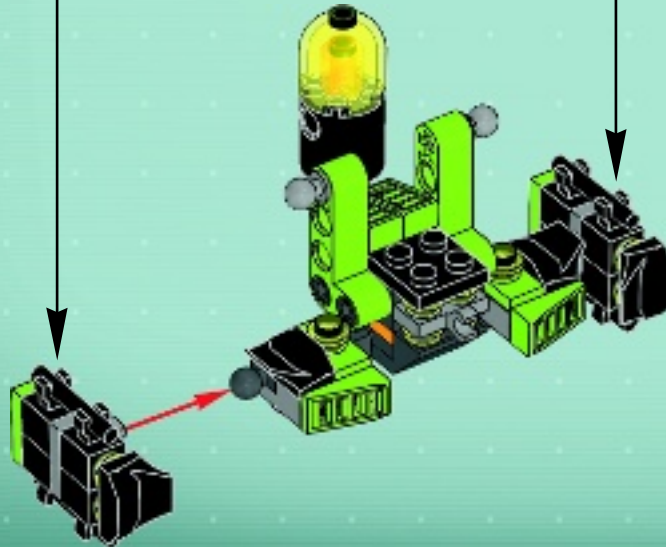



1x



1x

1



1x

2



1x



1x

3



1x

4



5



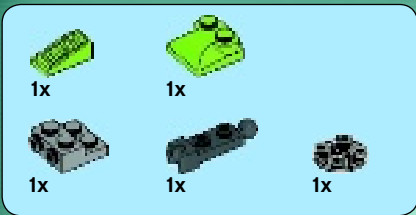

6

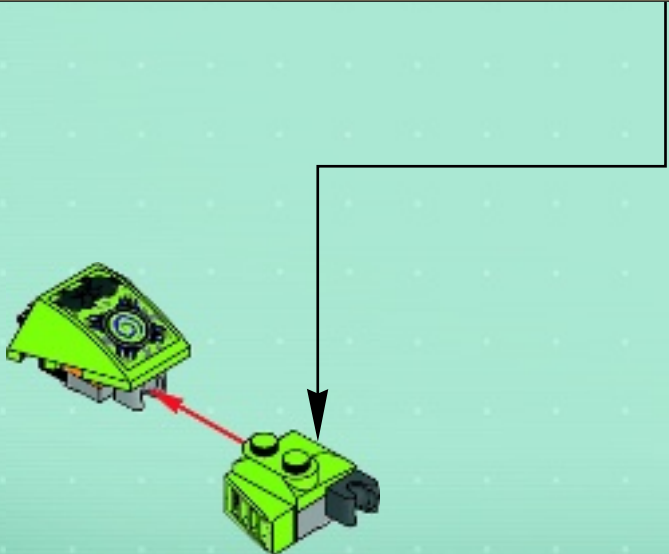
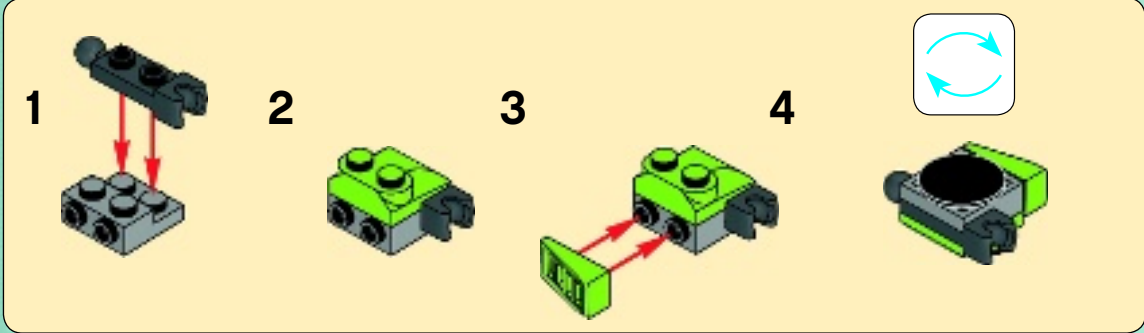



1x

7



2x

8



15

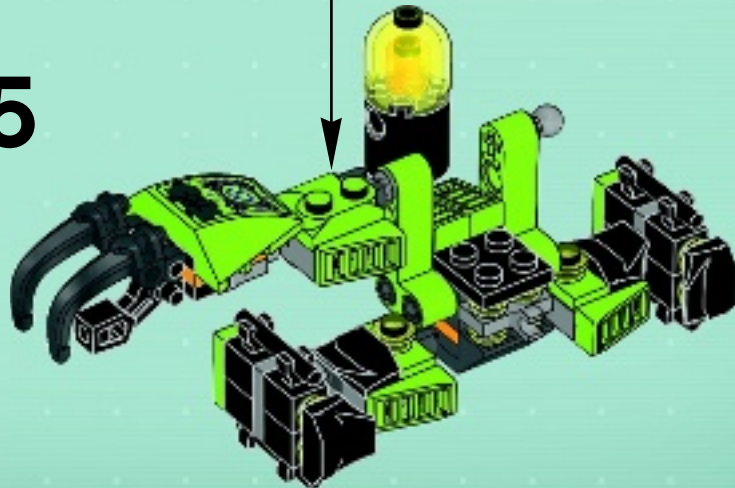



1



2

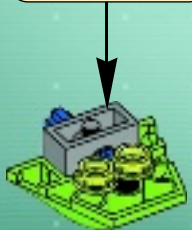
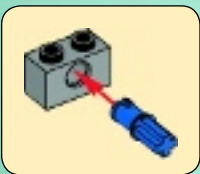

3

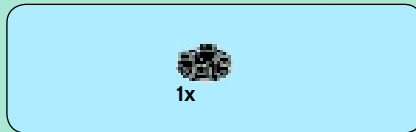
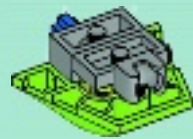

4



5

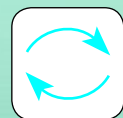

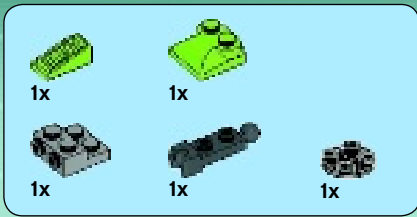

6

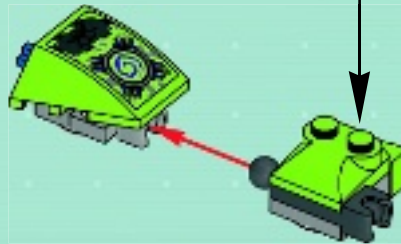
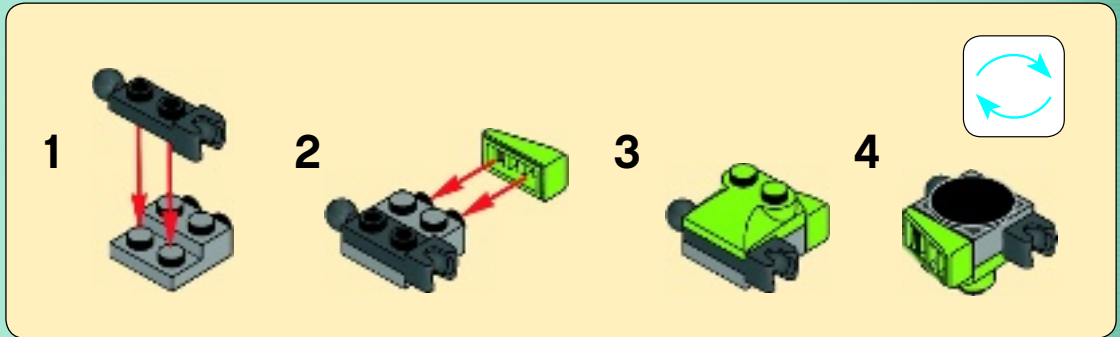



7

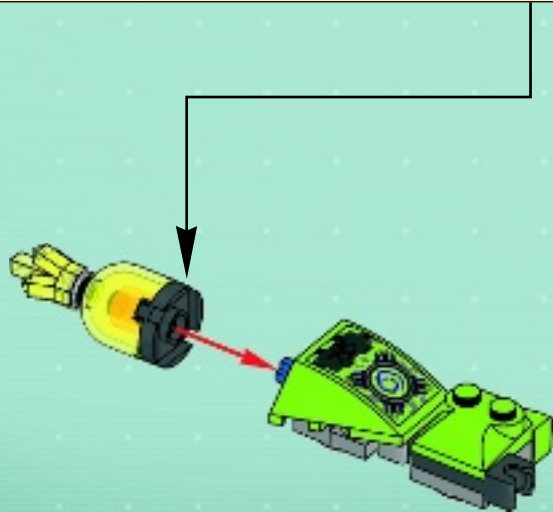

16

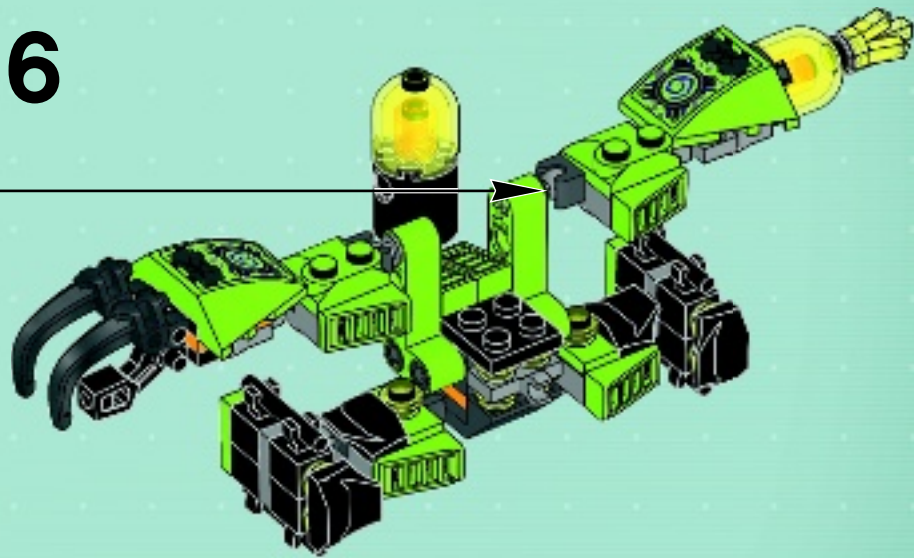



2x



1x

17

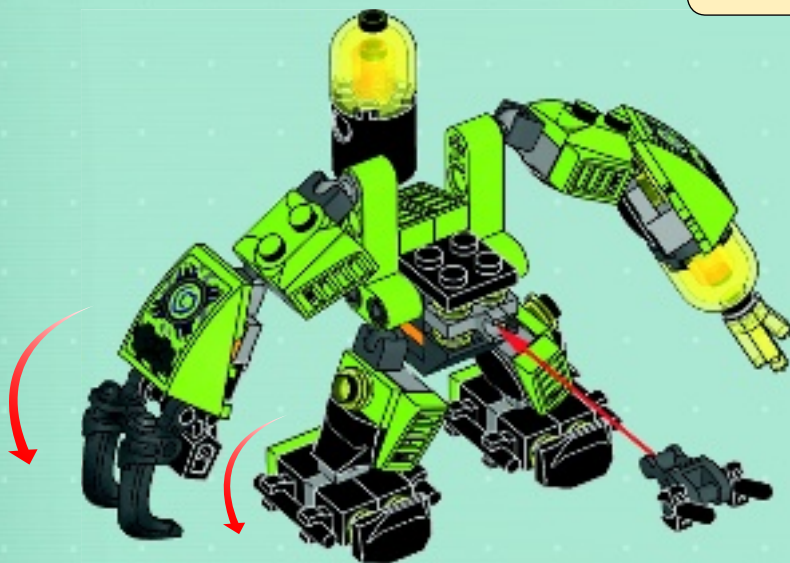



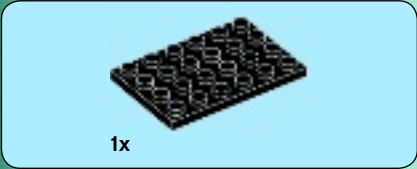

1x

1



2x

2

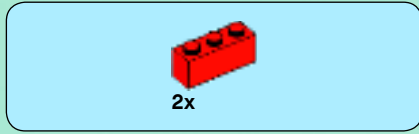

2x

3





1x

4



2x

5





6

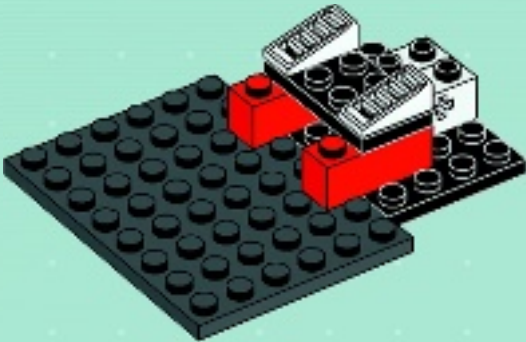

7

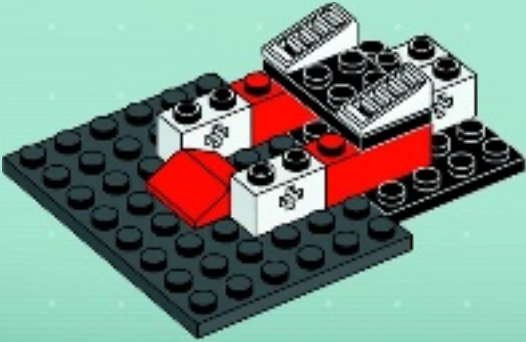



2x



2x

8



2x

9





1x

10

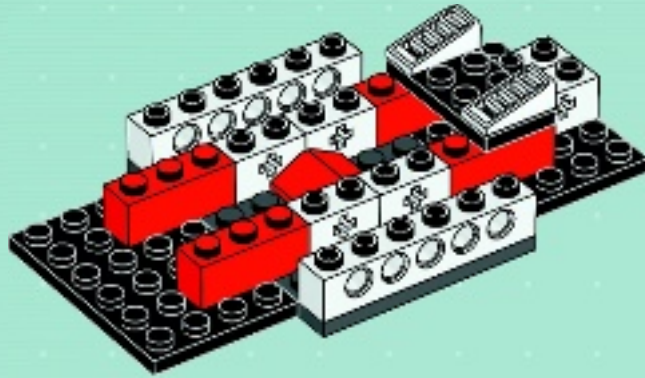

4x

11

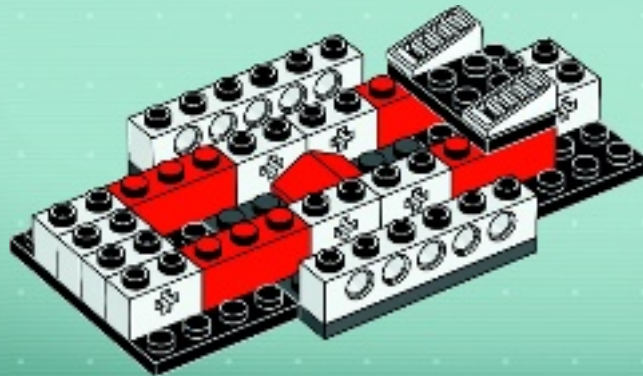



1



2





1



2



3

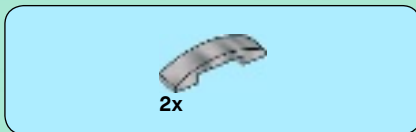

4



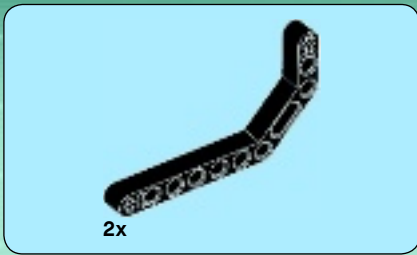

5

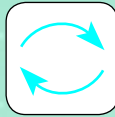

6





7

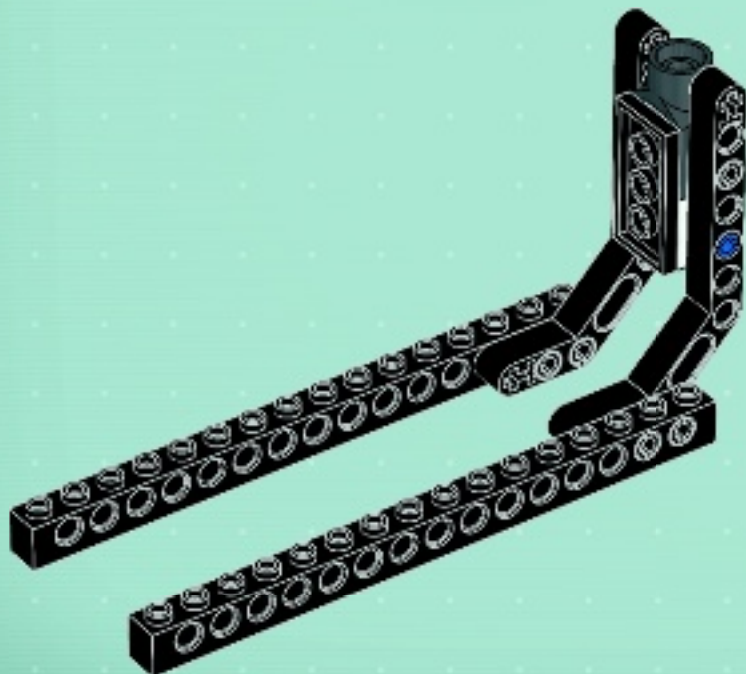



2x

8

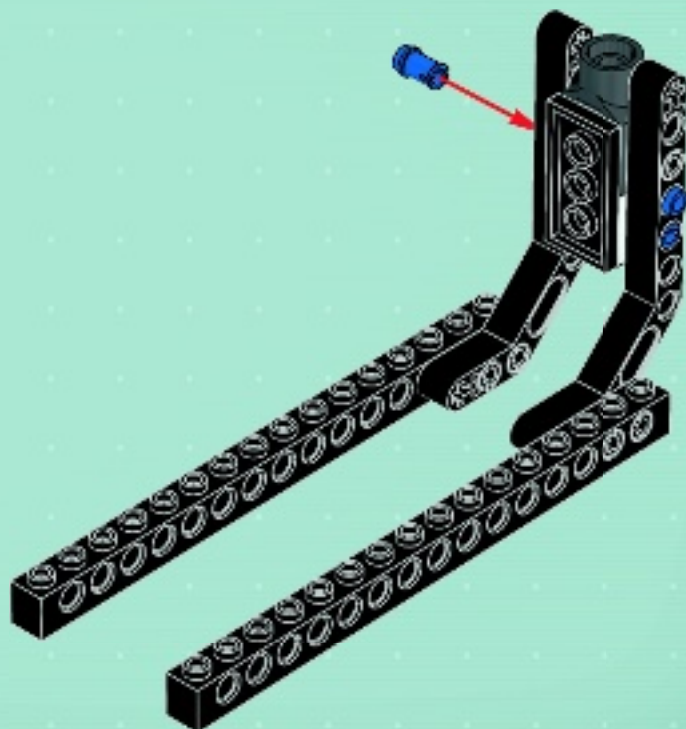



9

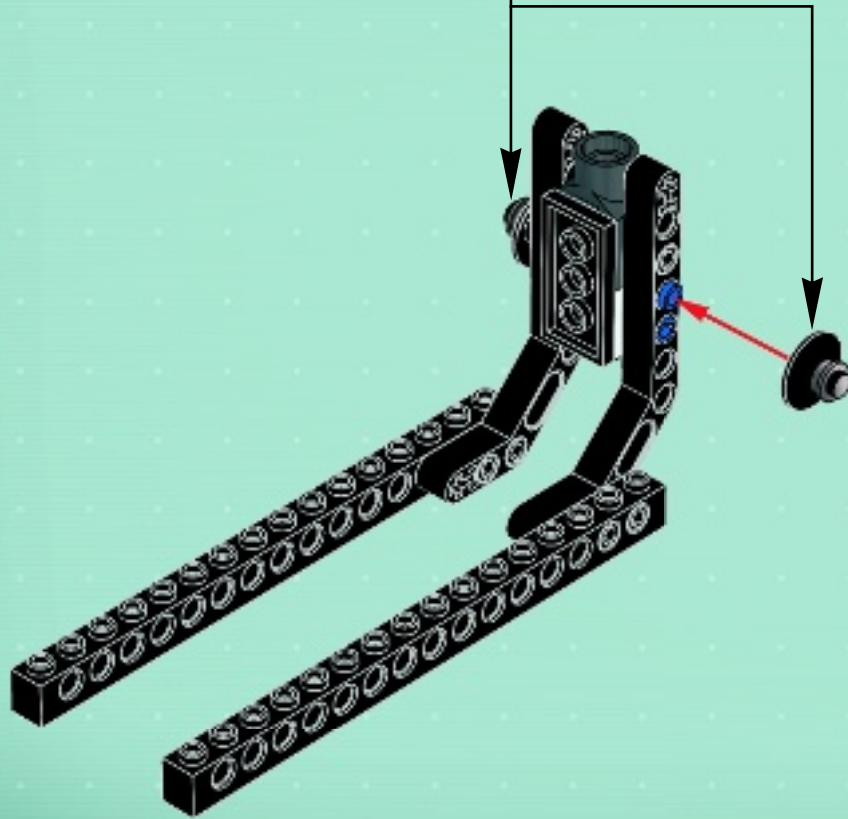

12



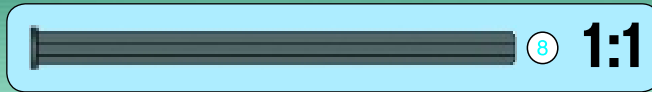
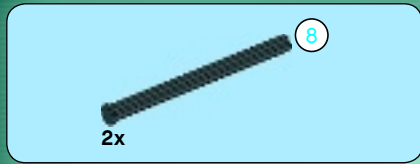

13

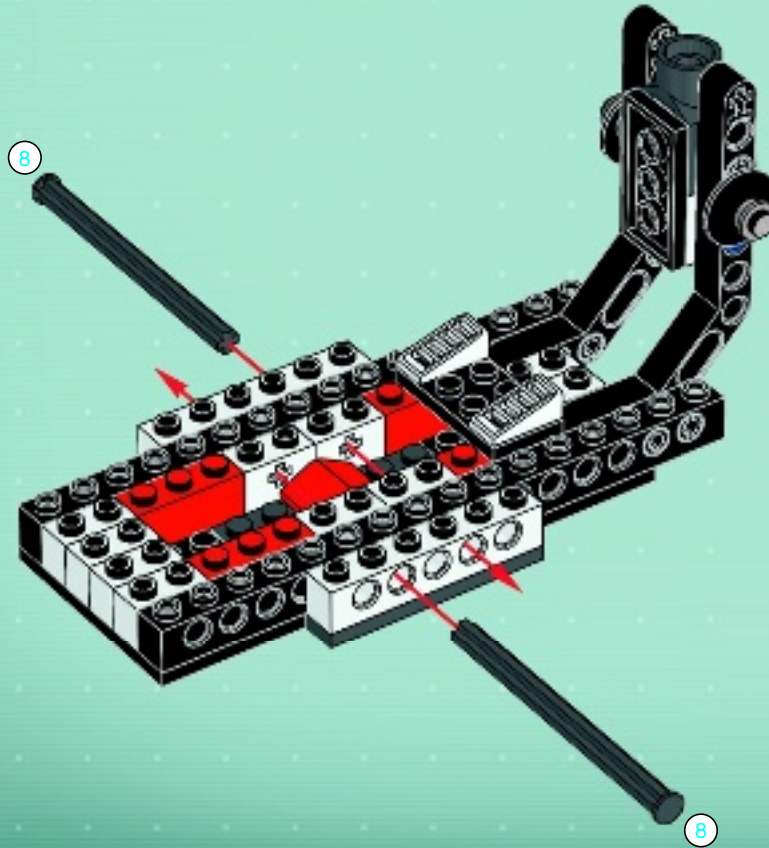

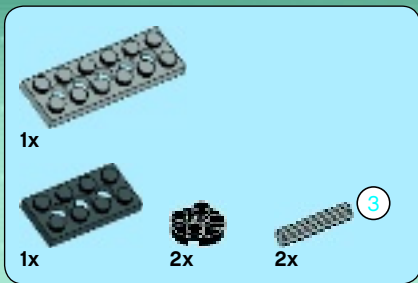

14

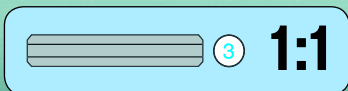
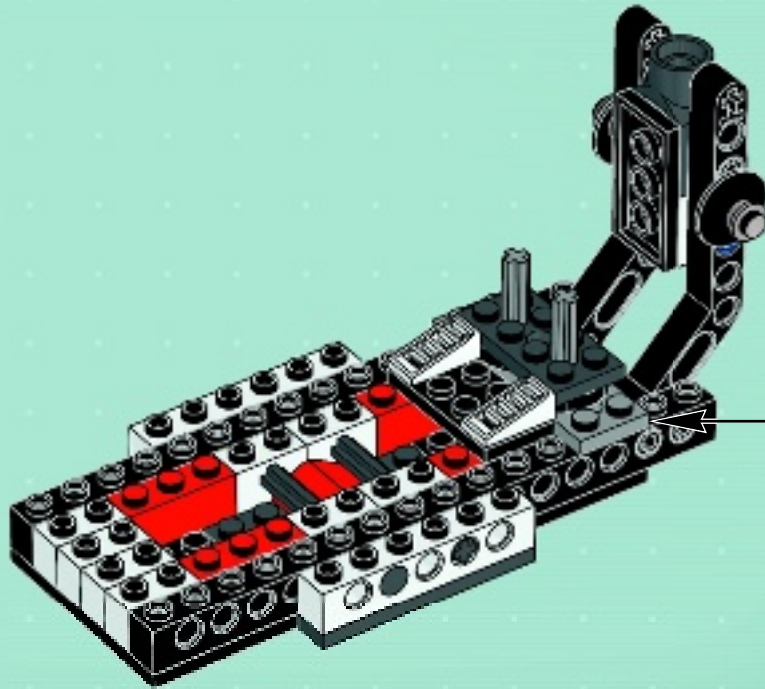



4x

15

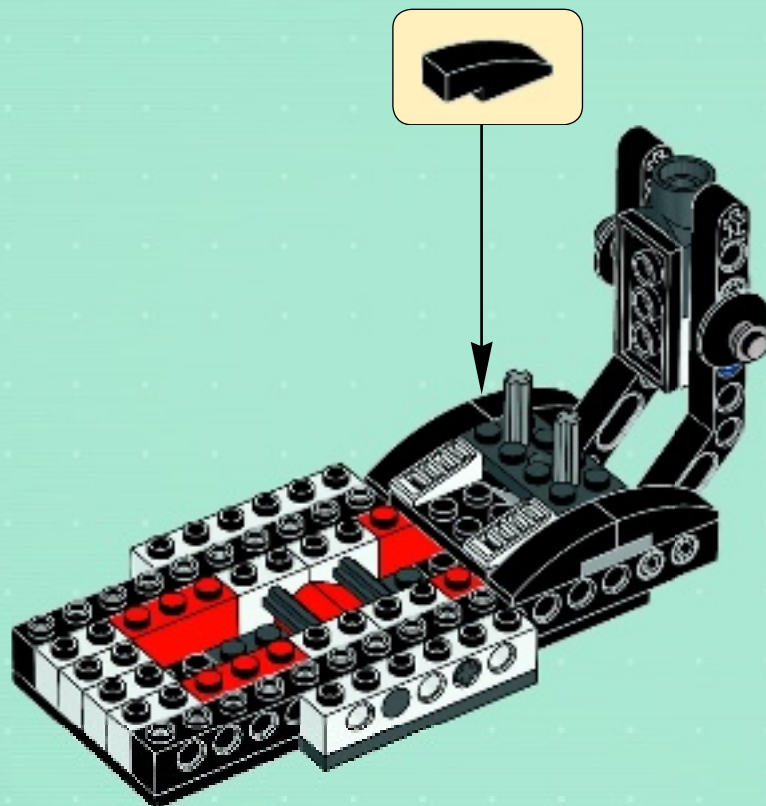



10x

16

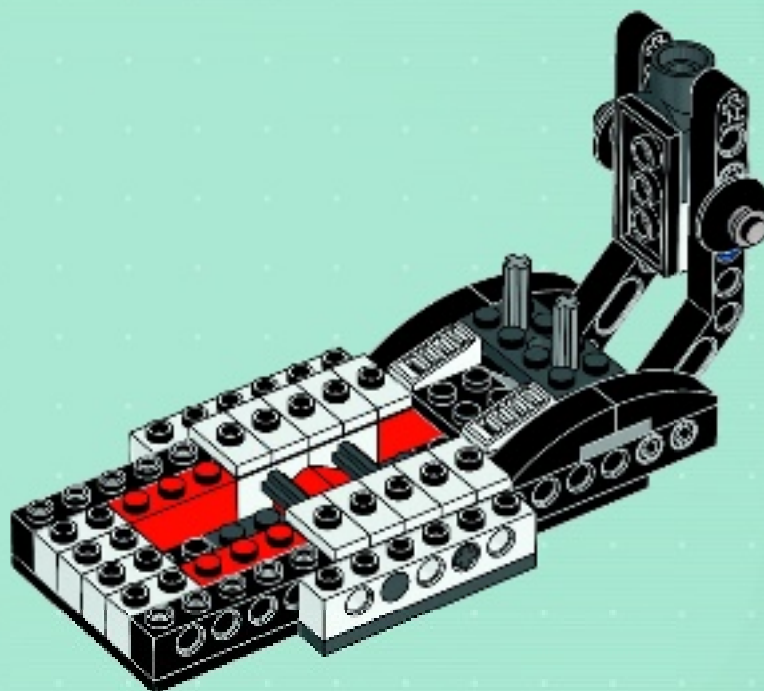



5x

17

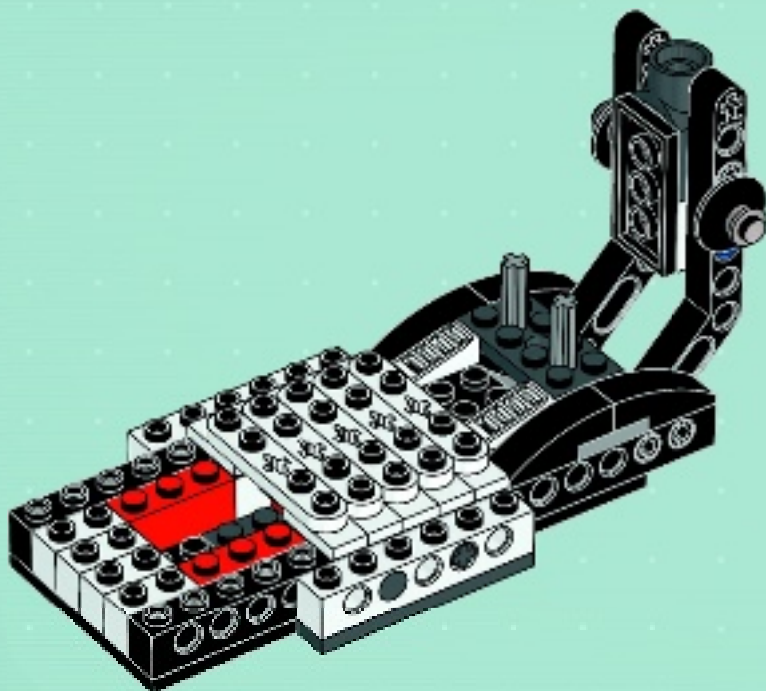



2x



1x

18

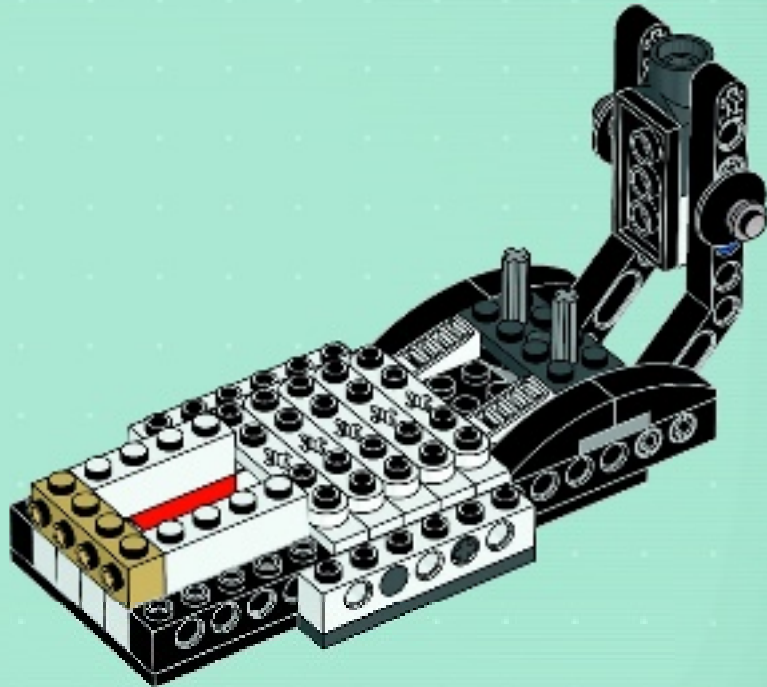



2x



6x

19

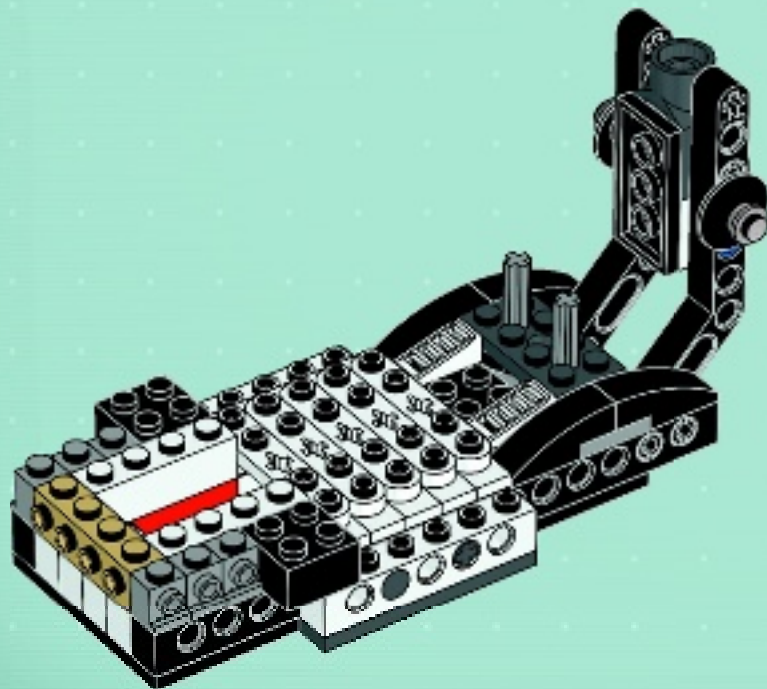



2x



2x

20

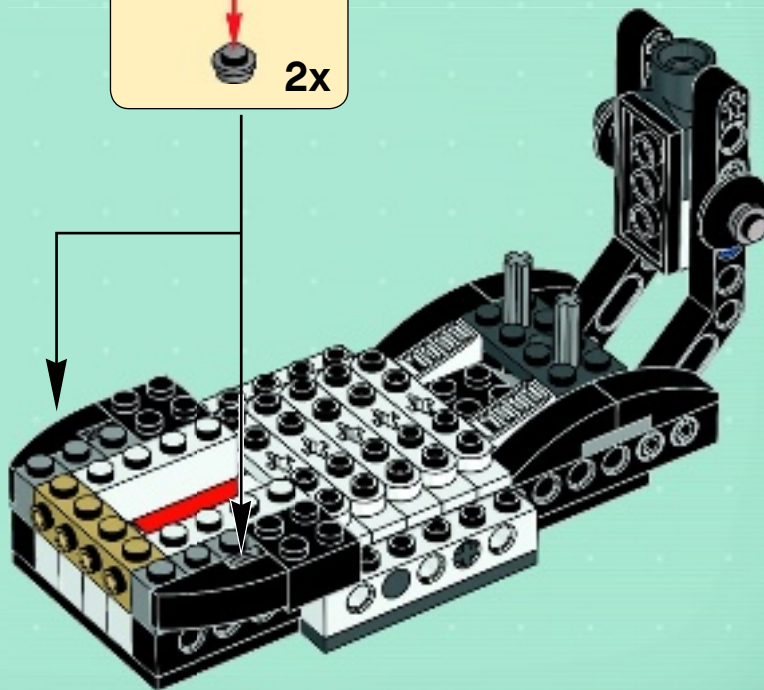

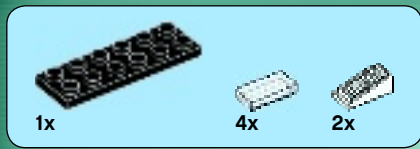

21

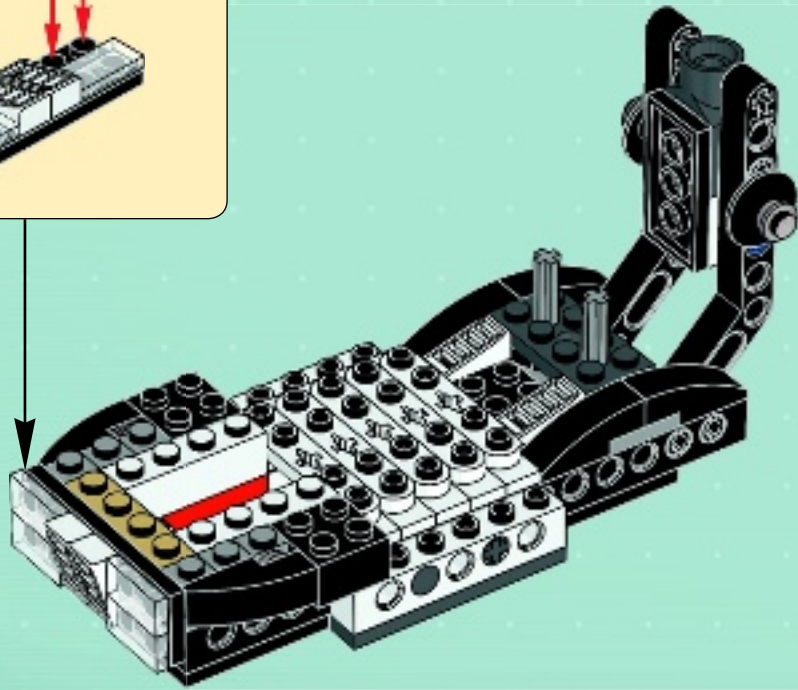
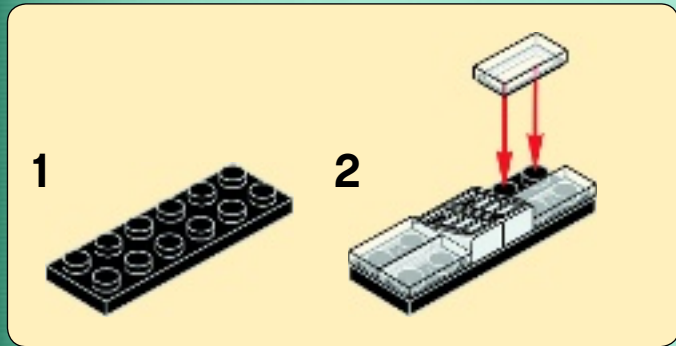



2x

22



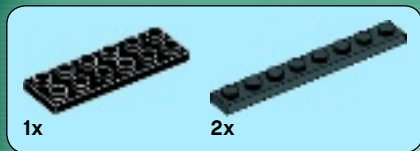

23

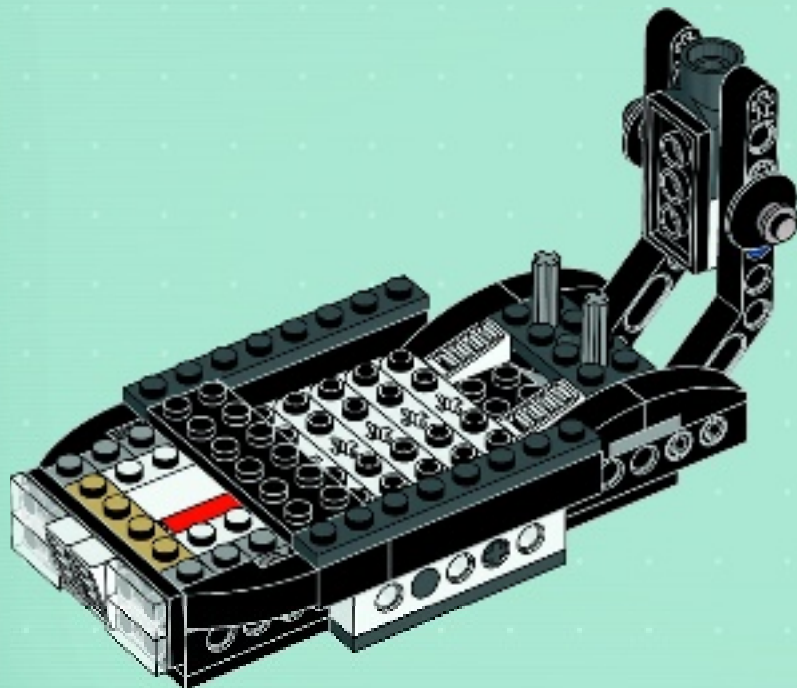

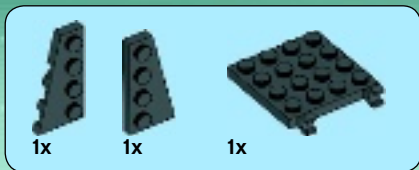

24

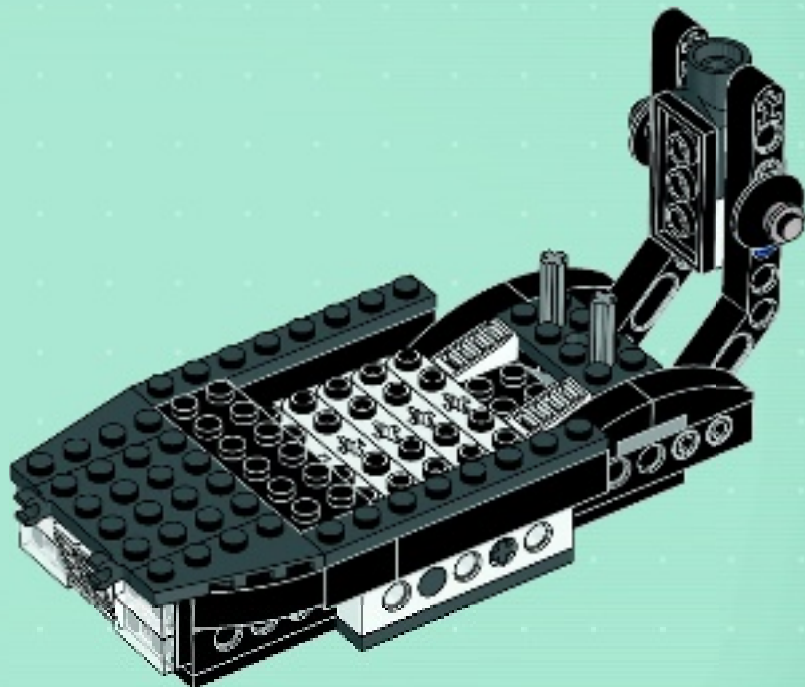



3x

25

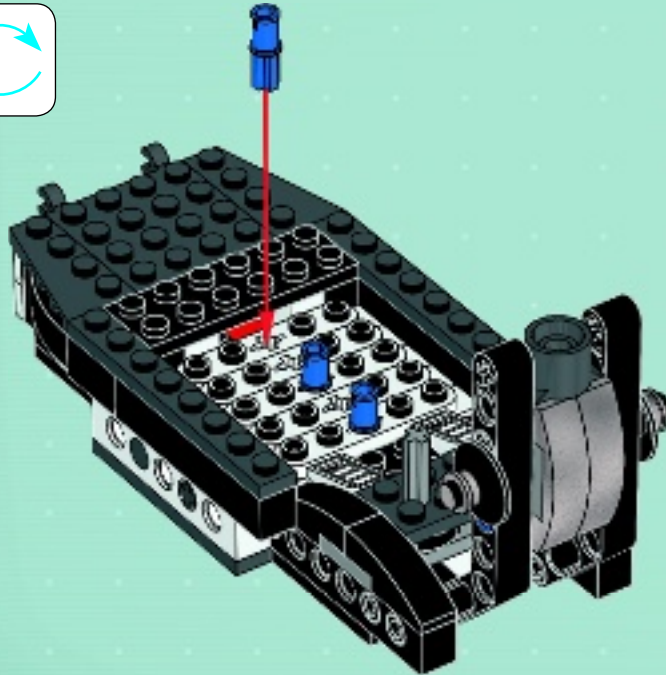
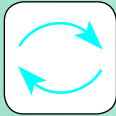



1x

26

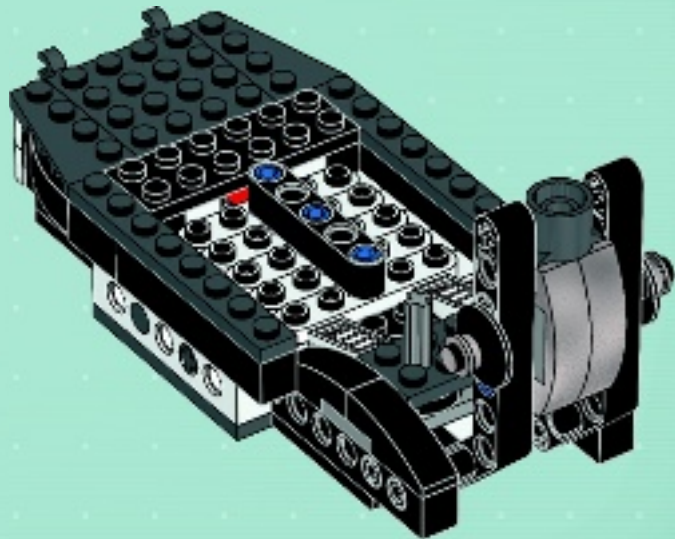



2x



1x



1x

27

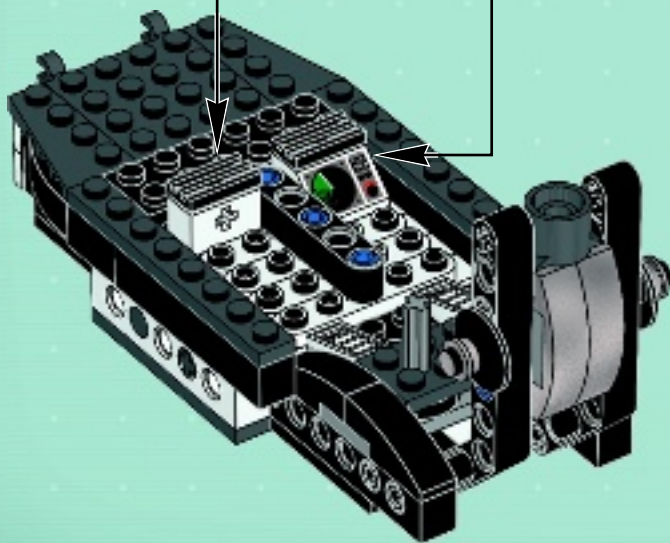
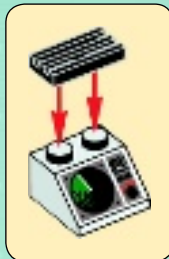
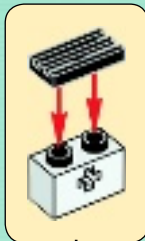



1x



1x

28

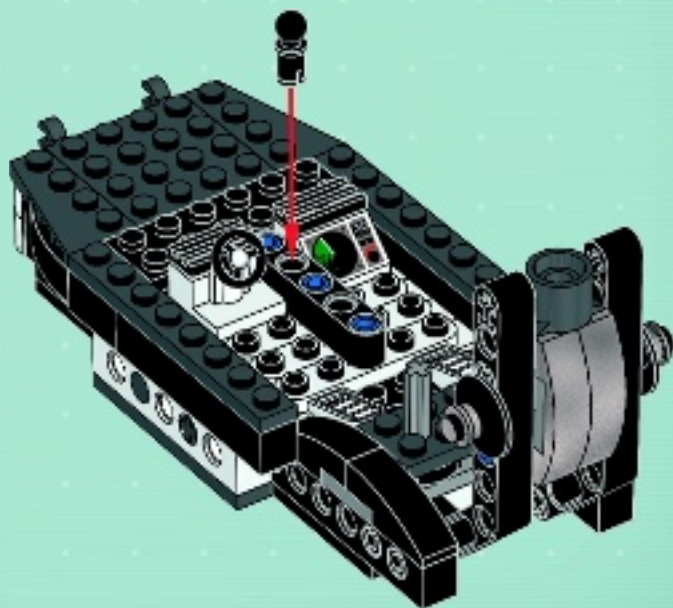



2x

29

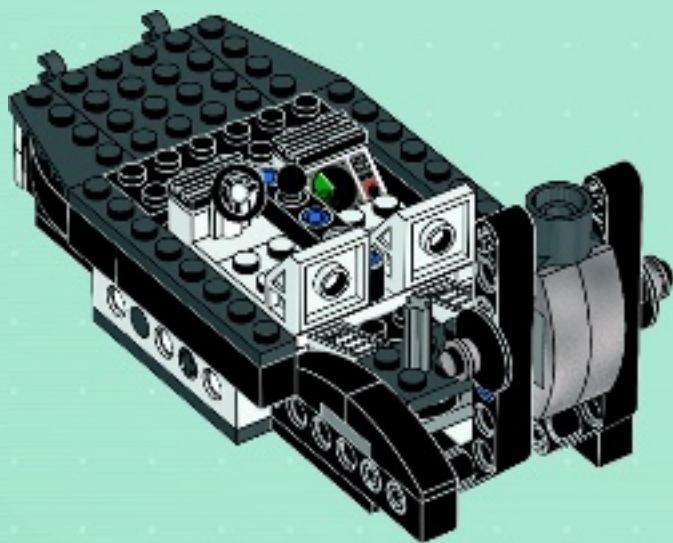



2x



2x

30

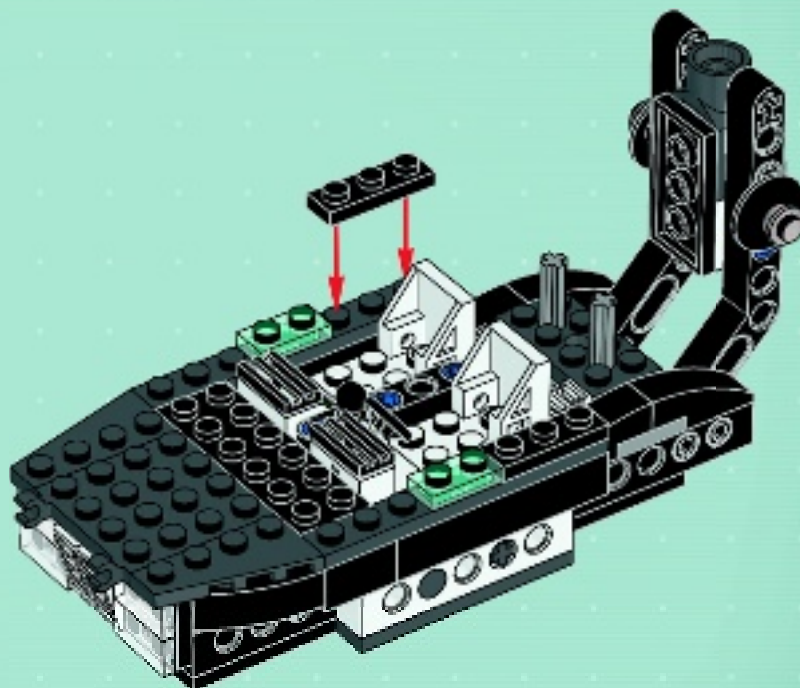

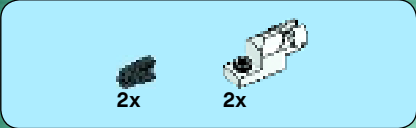

31

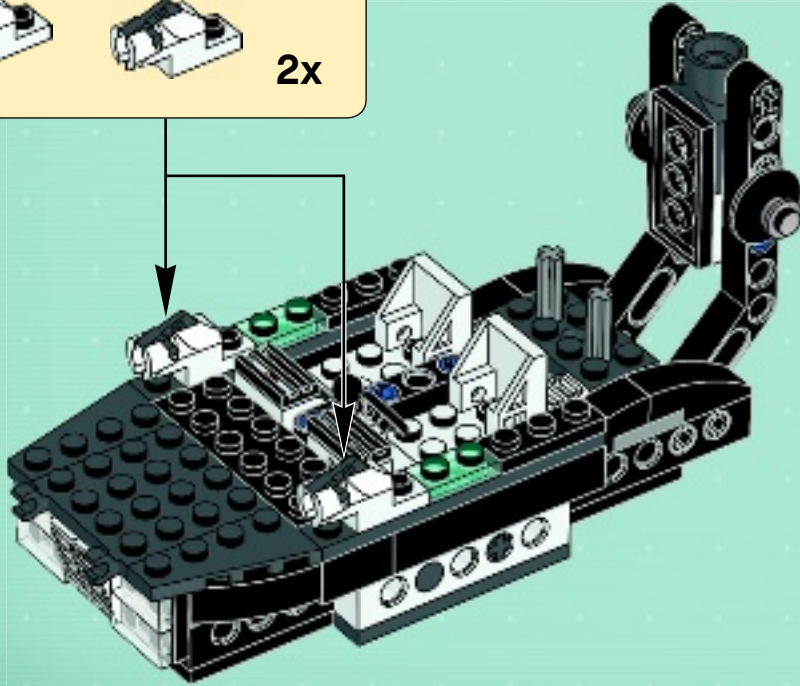
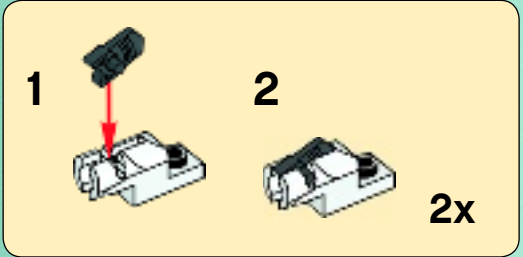



2x

32

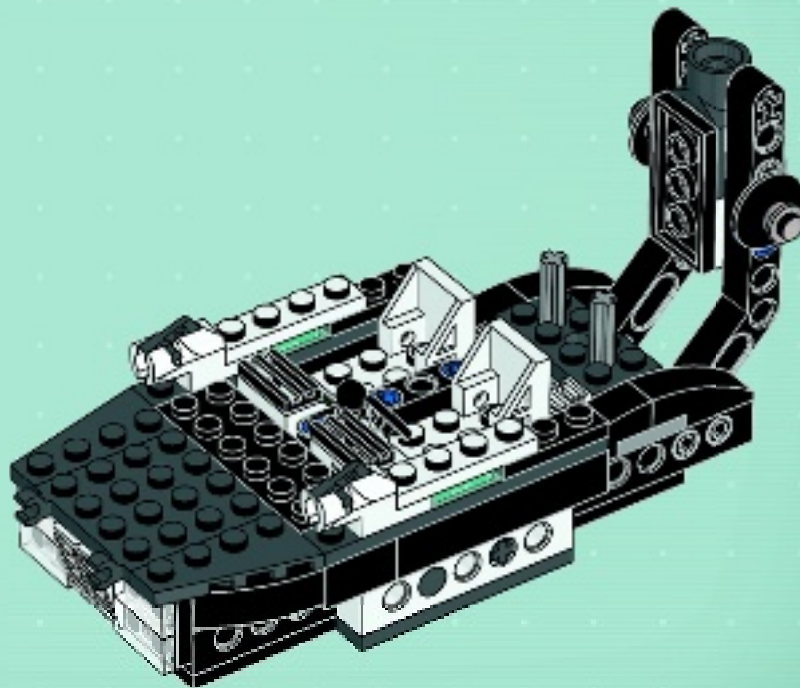



4x



2x

33

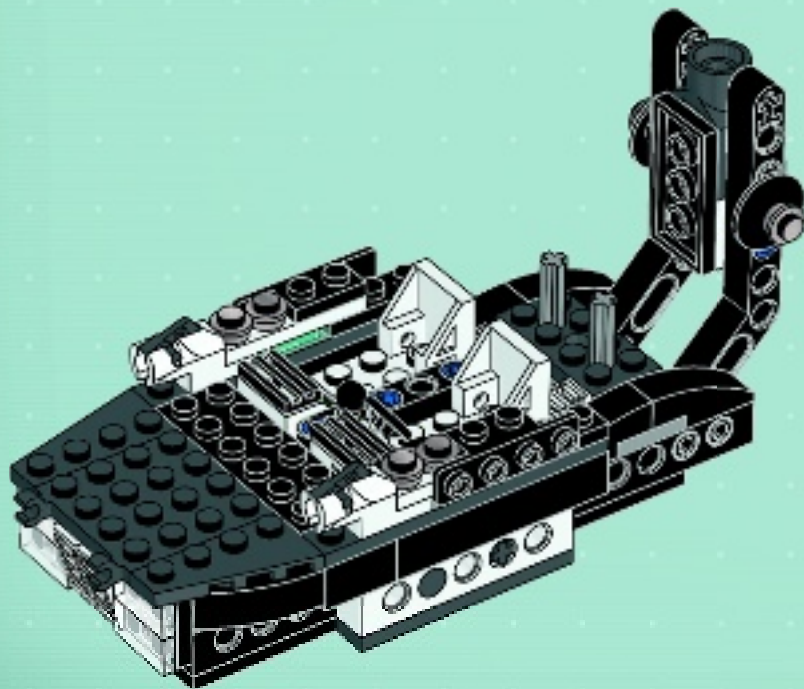



1x



2x



2x

34

1



2



3

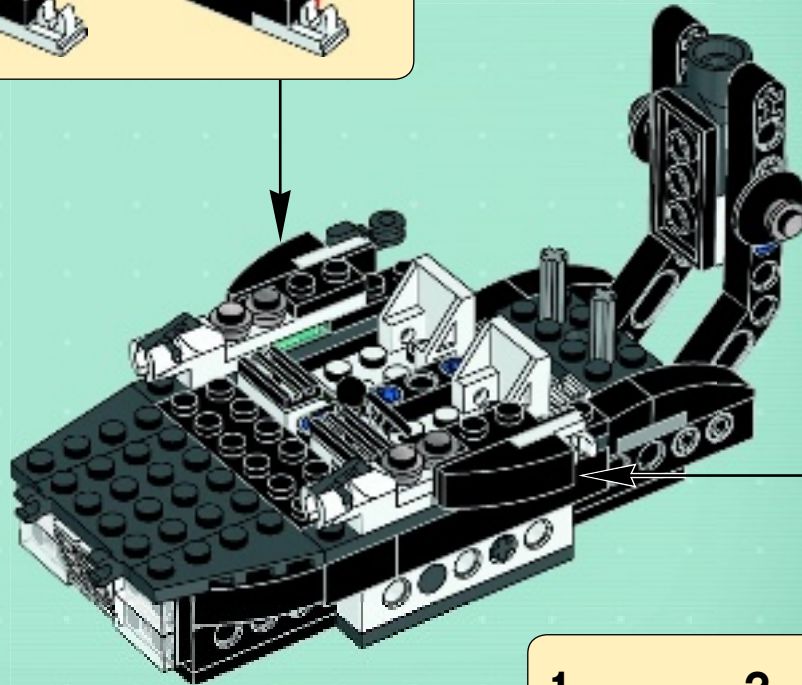

1



2





1x



2x

35

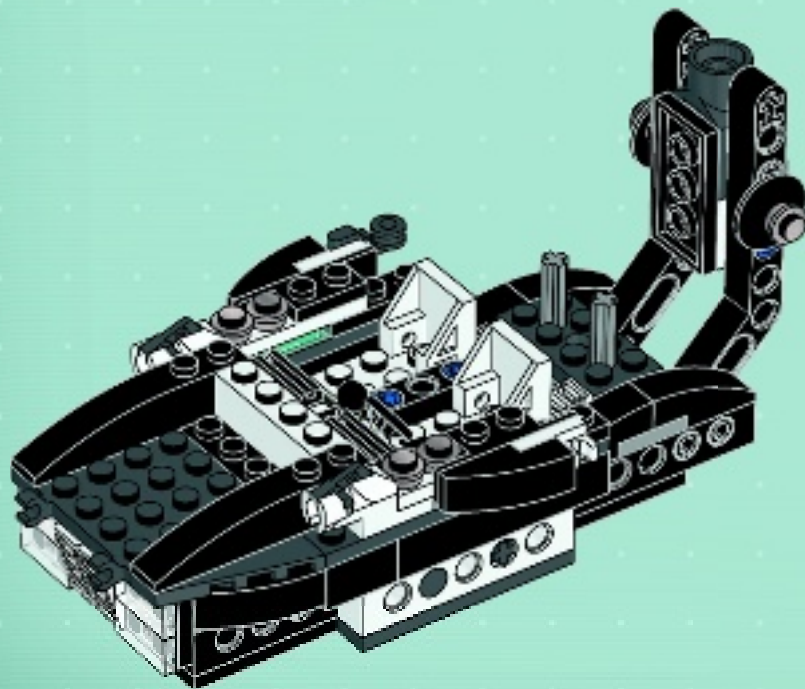



1x



1x

36

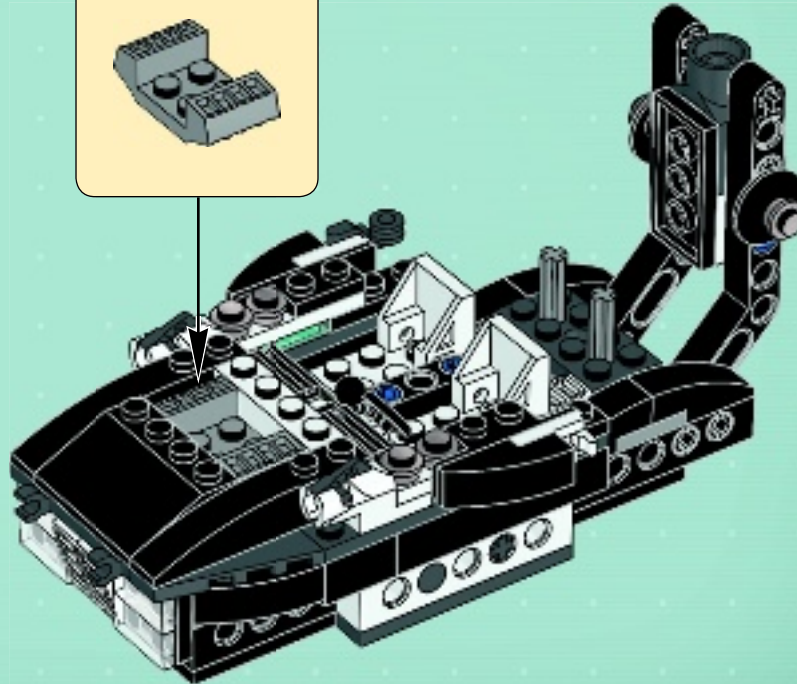
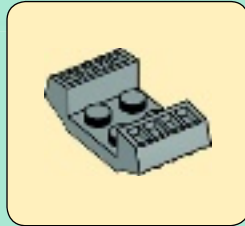



1x

37

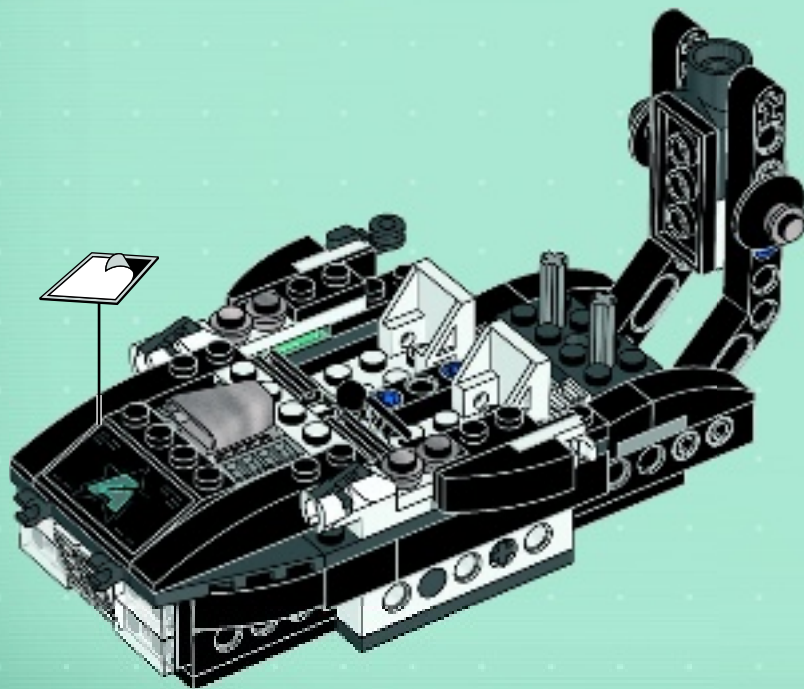



2x

38

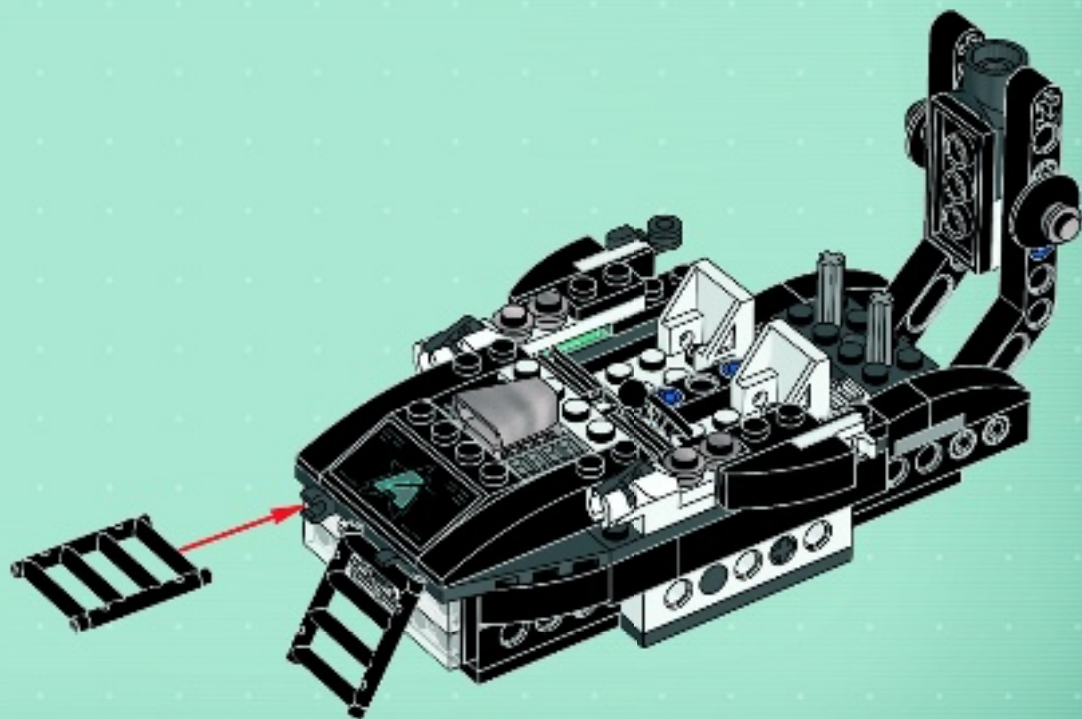



2x



2x



2x



2x

39

1



2



3



2x

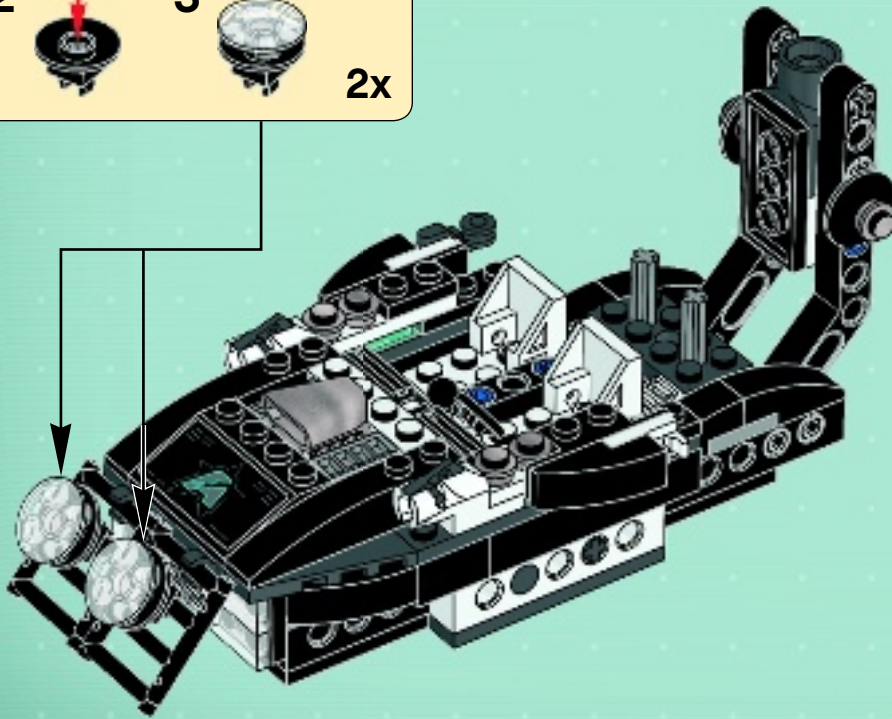



2x

40

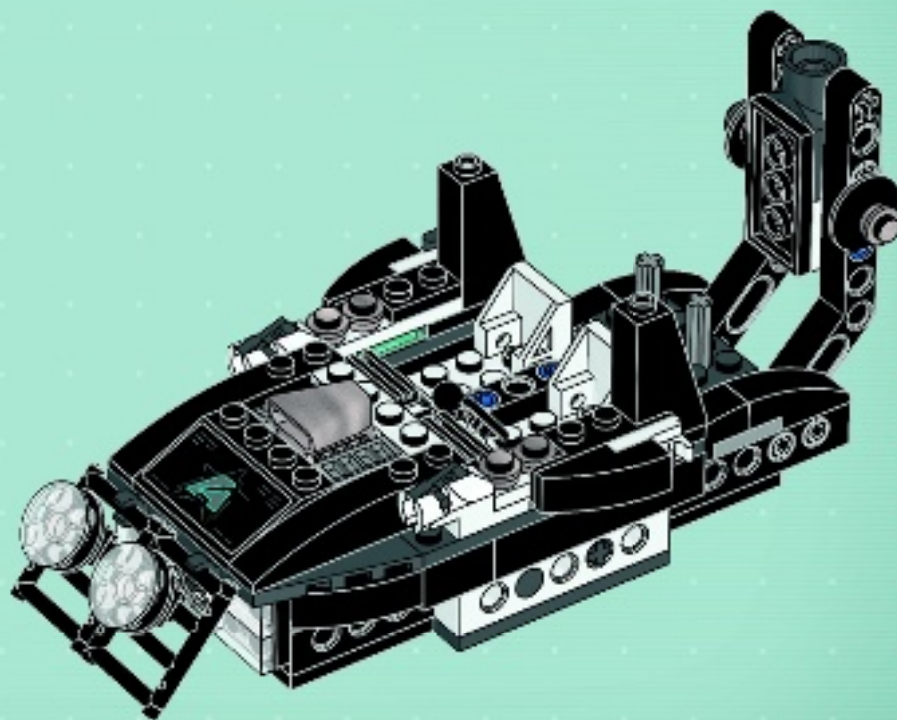



1x

41

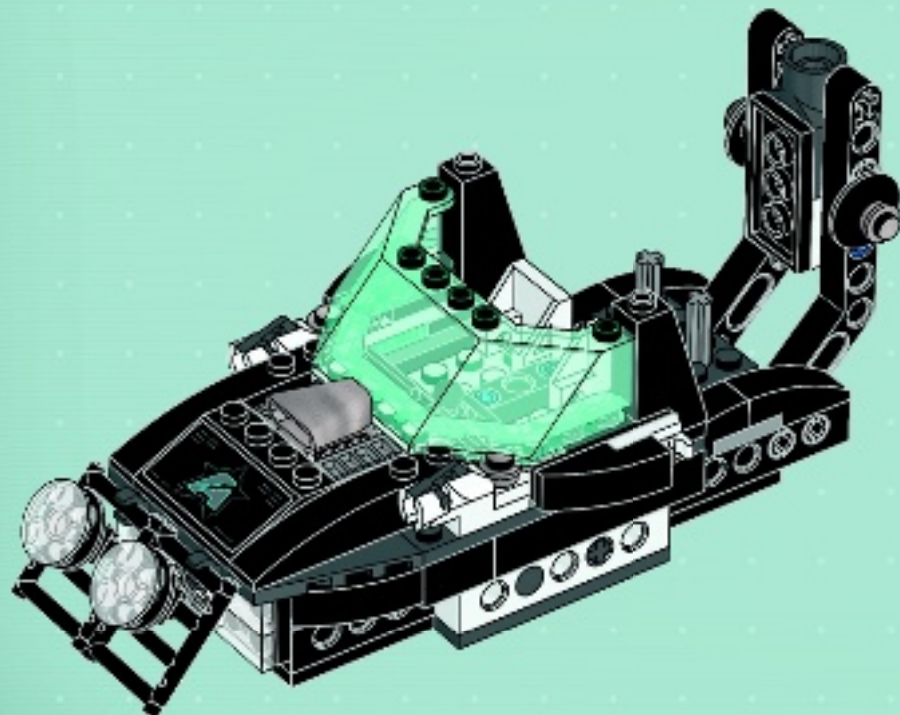

2x

2x

42

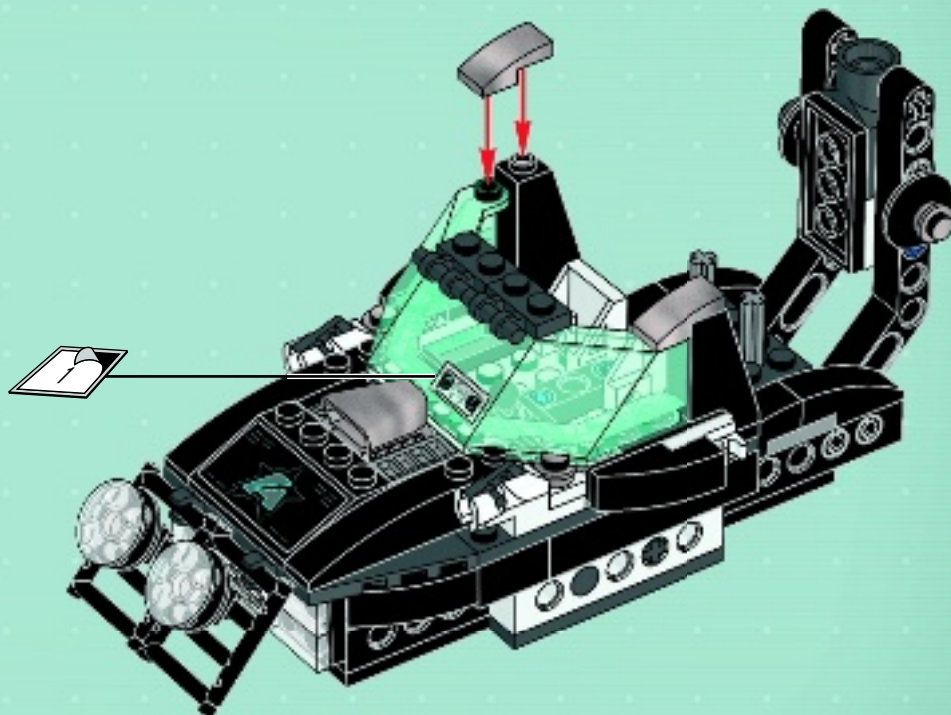



2x



2x



2x



43

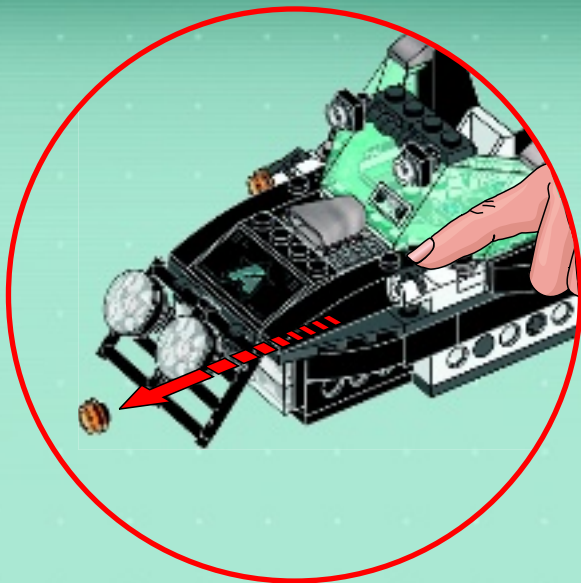

2x



2x

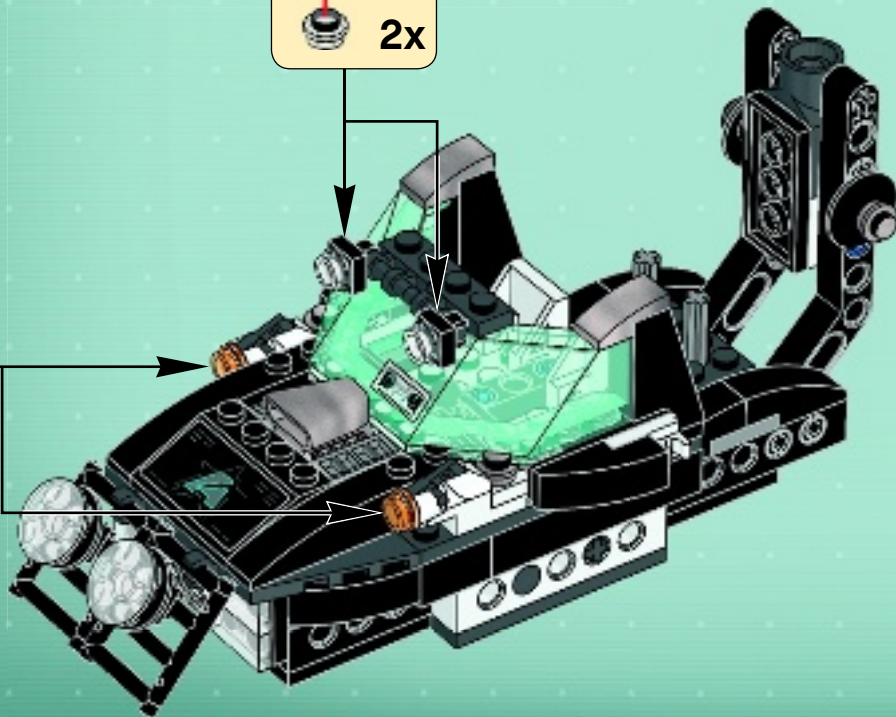

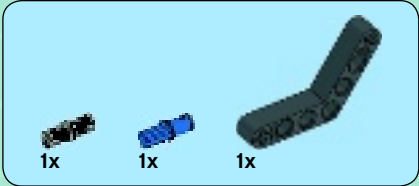
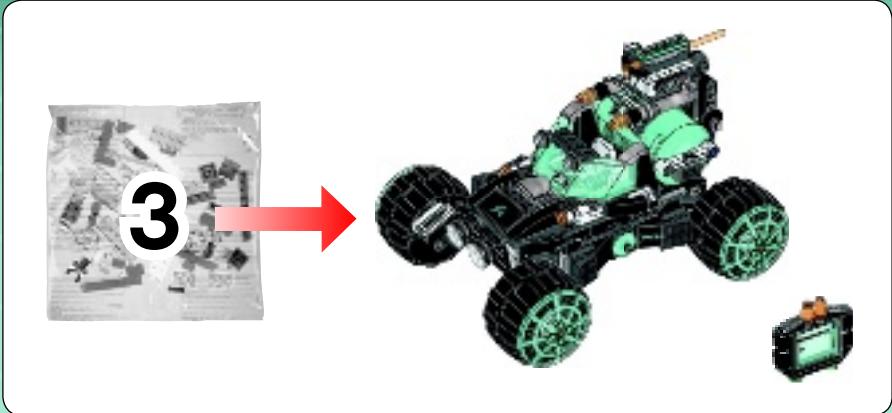

1



2



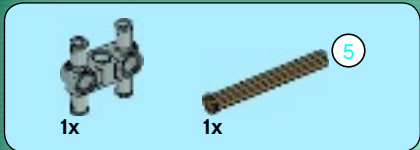

3

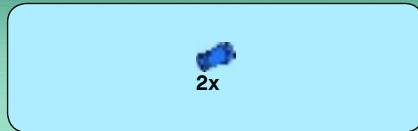
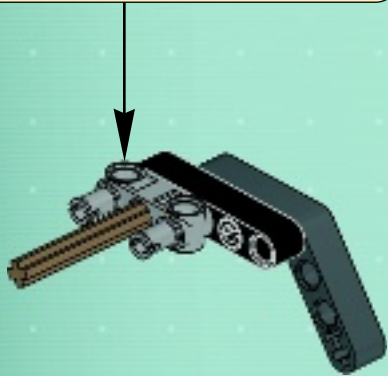
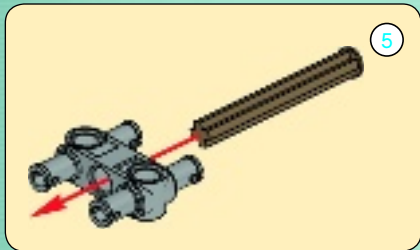

4

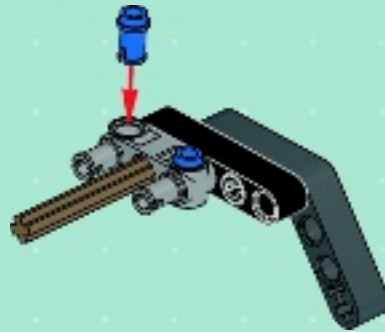

5

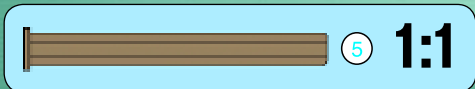

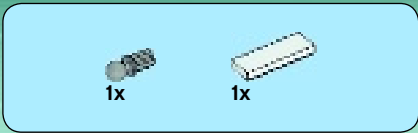

6

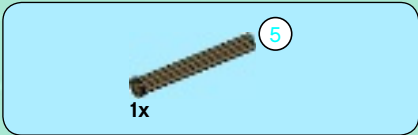
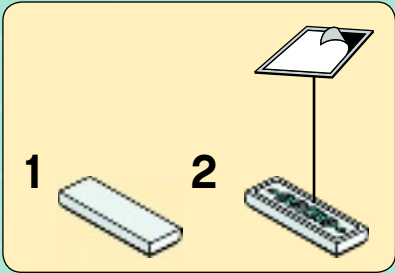

7

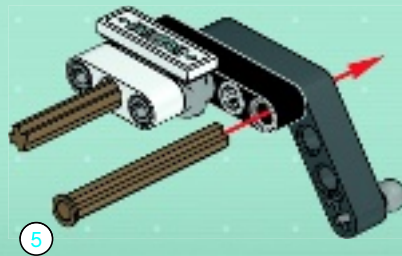

2x

44

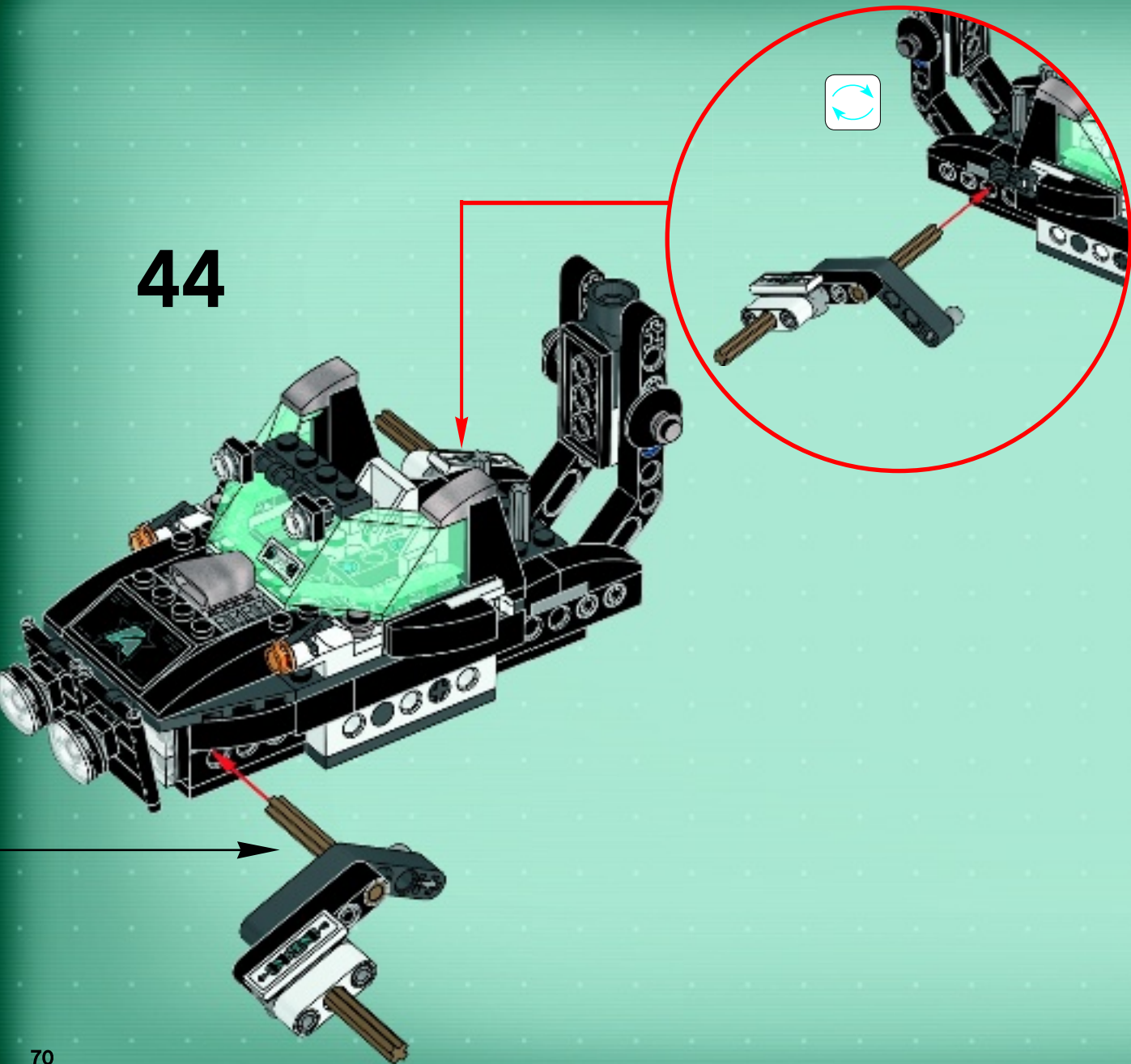



2x



1x



1x



1x

1



1x

2



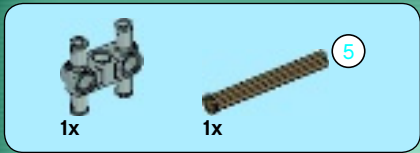

3

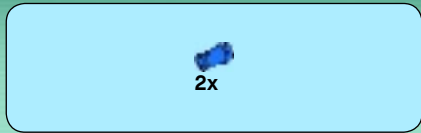
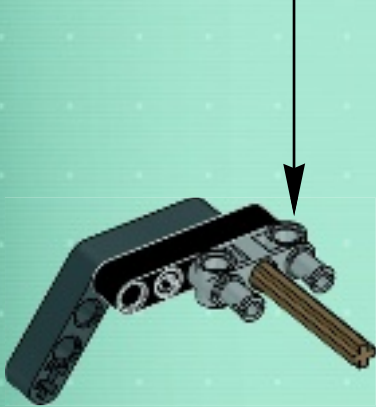
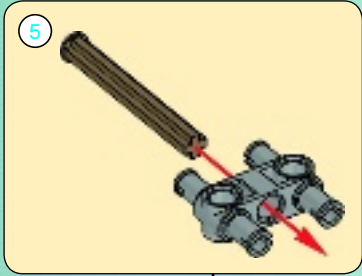

4

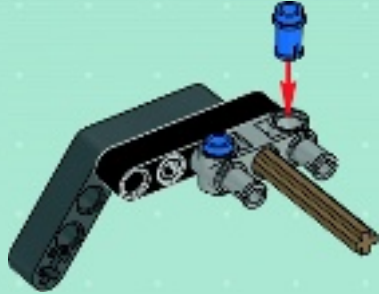

5

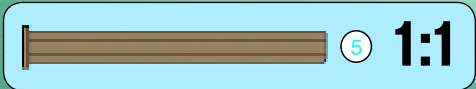

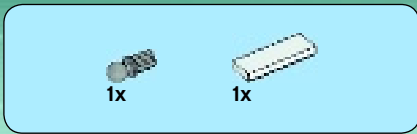

6

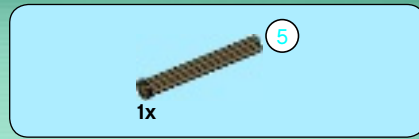
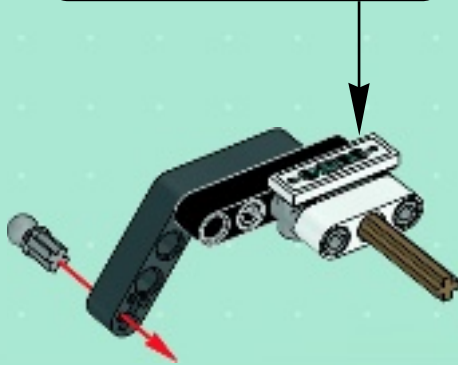
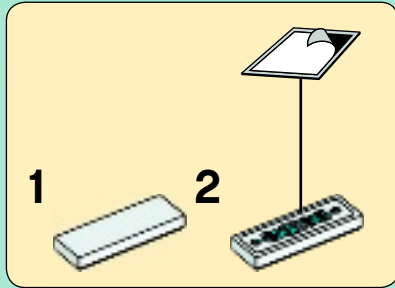

7

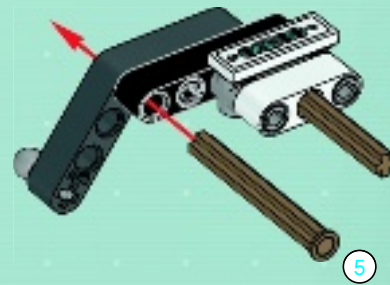

2x



45

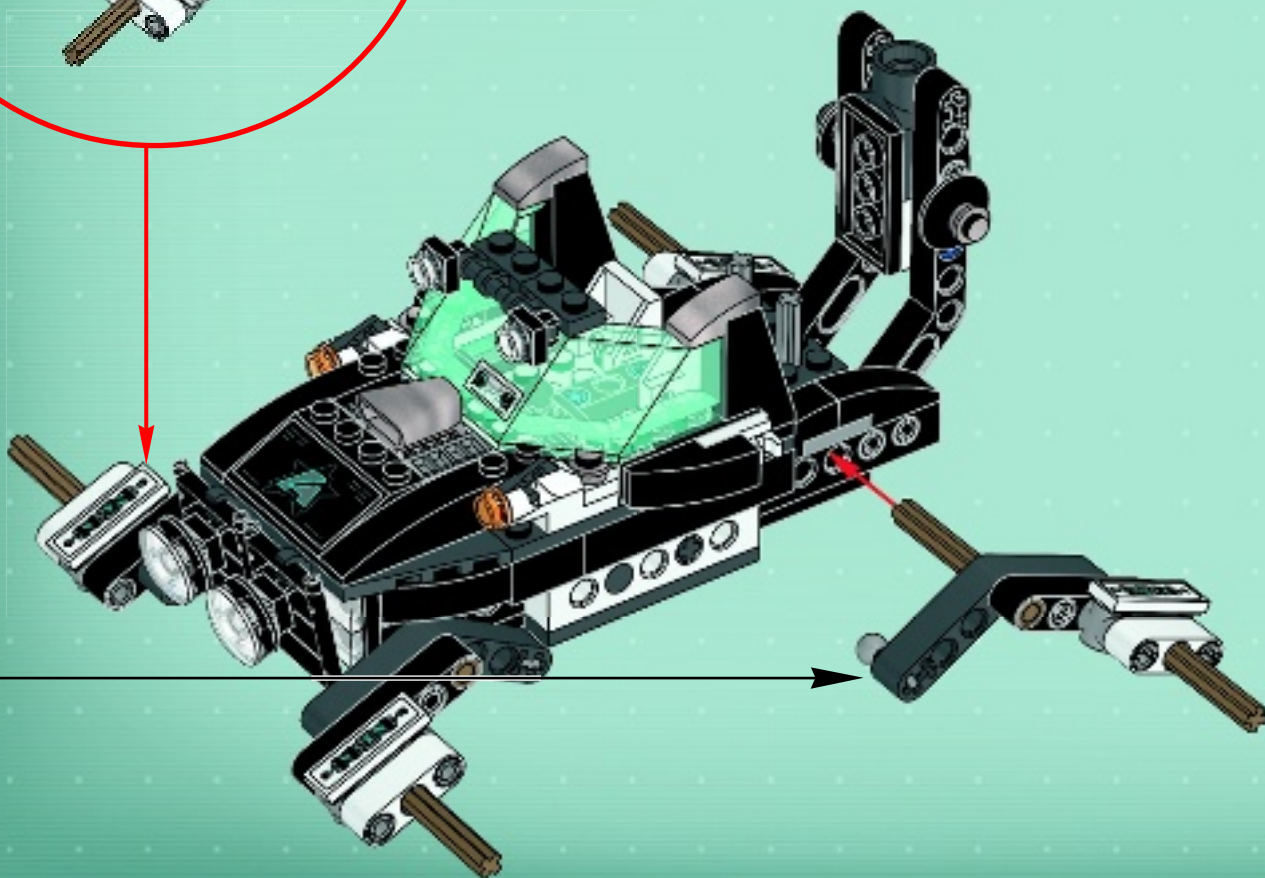



2x

46

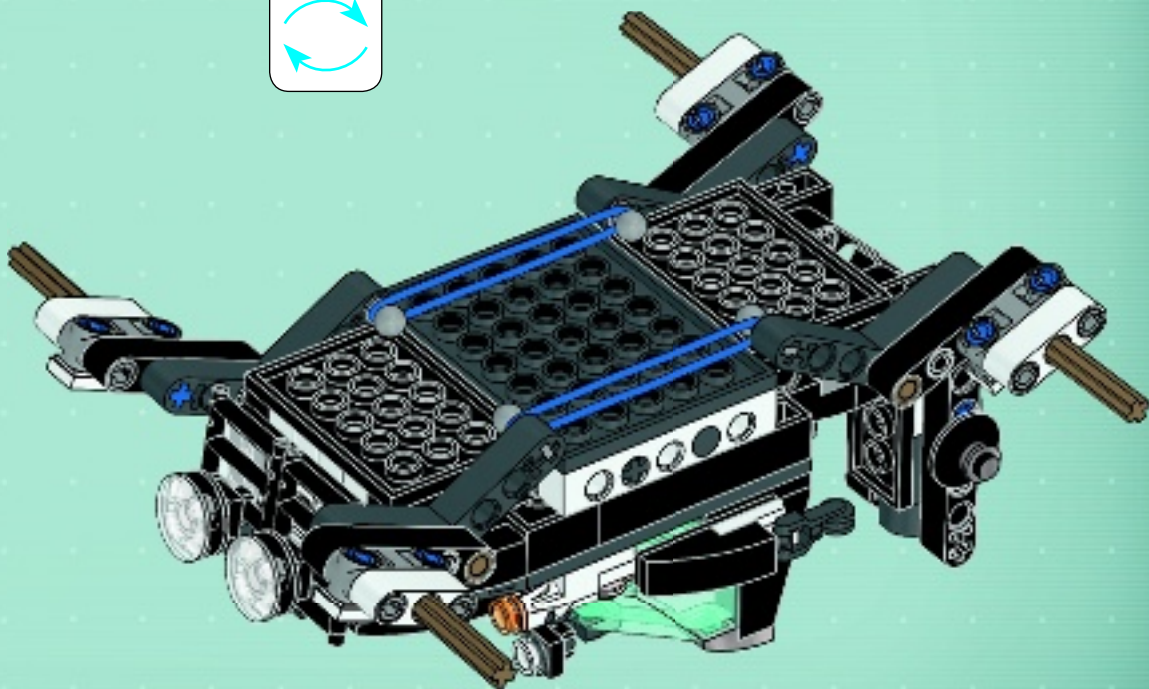
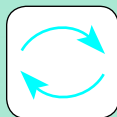



2x



1x

1



2x

2



3





1x



1x

4



2x

5



4x

6

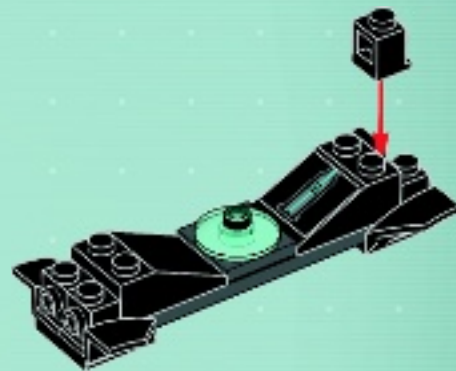



2x

7



2x

8



3x

9

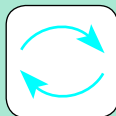



3x

10



4x

11

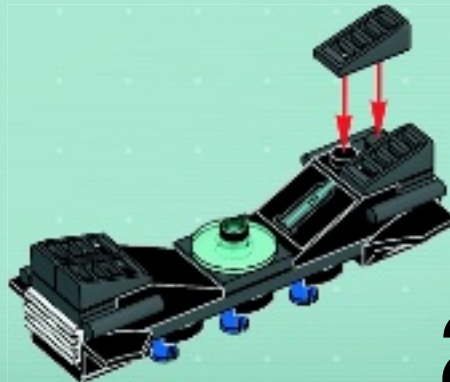
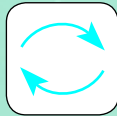

2x

47

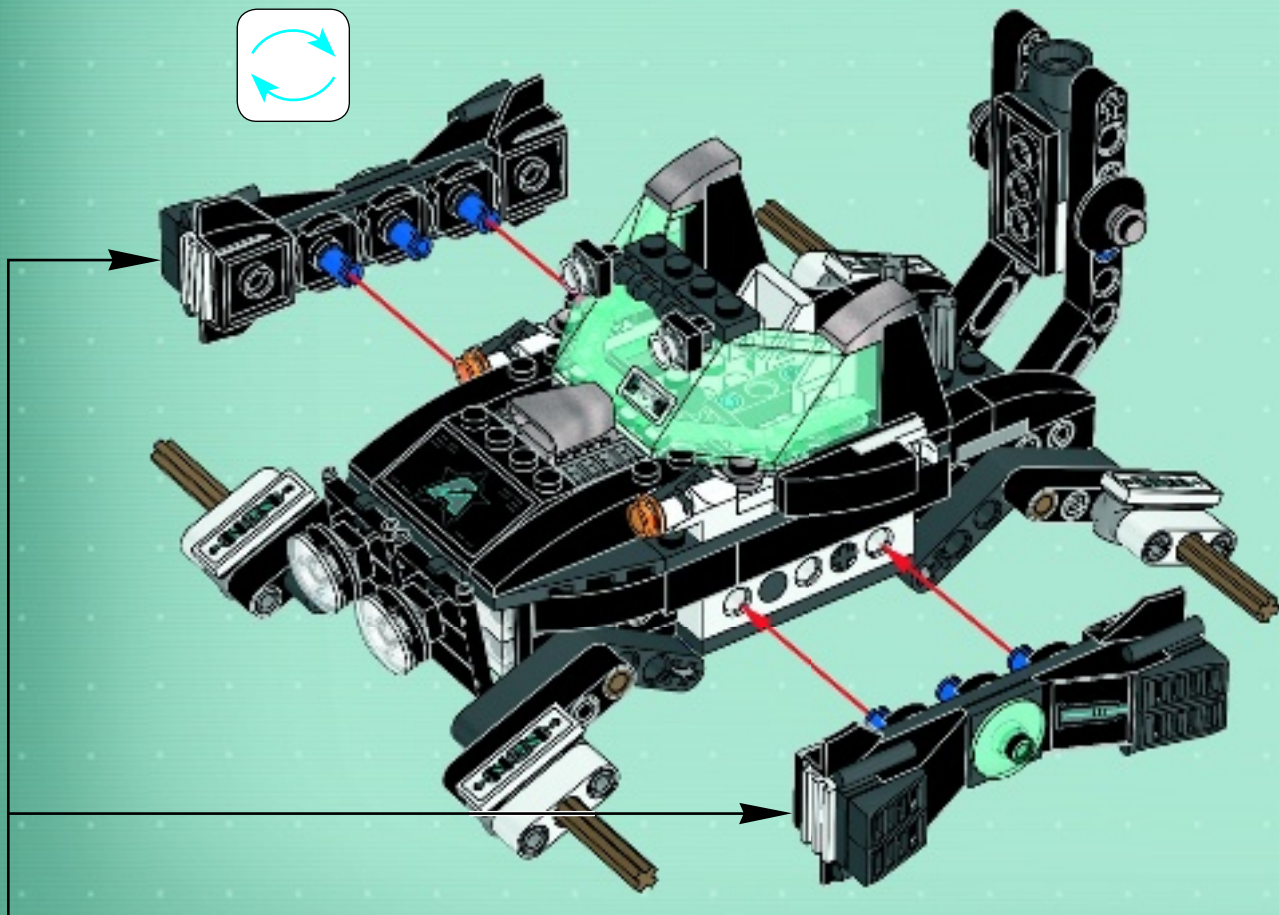
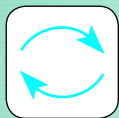

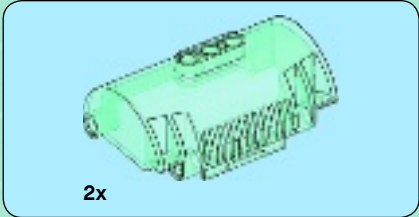

1

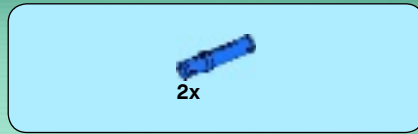
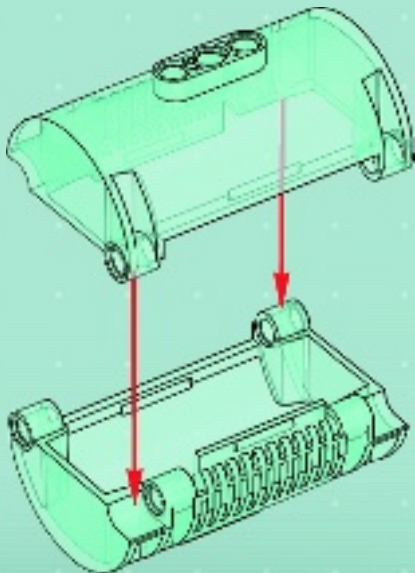

2

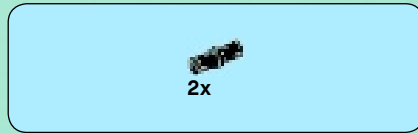
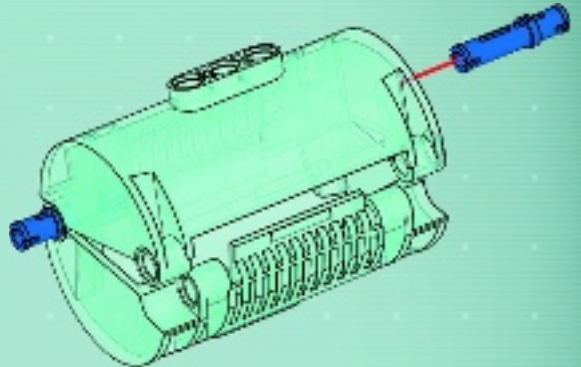

3

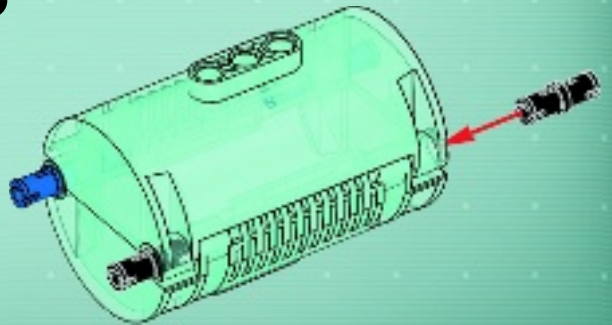



4x



2x

4

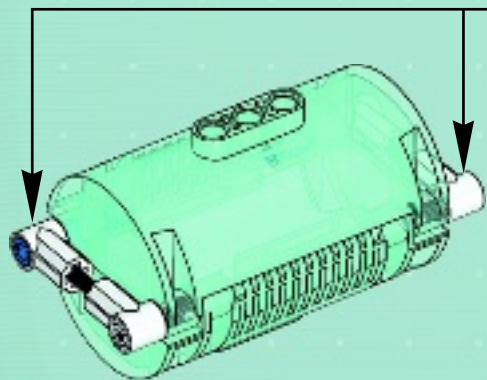
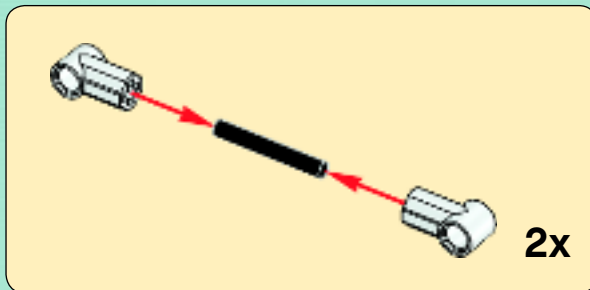



5

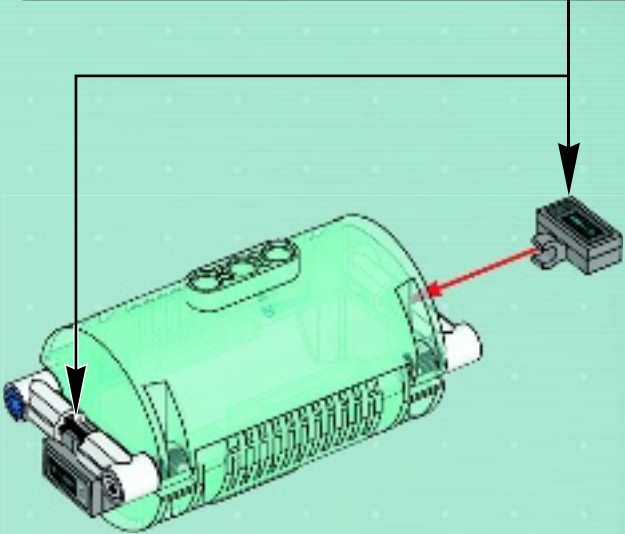

6

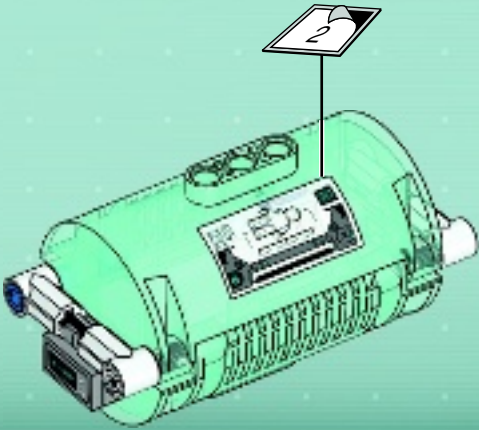

48

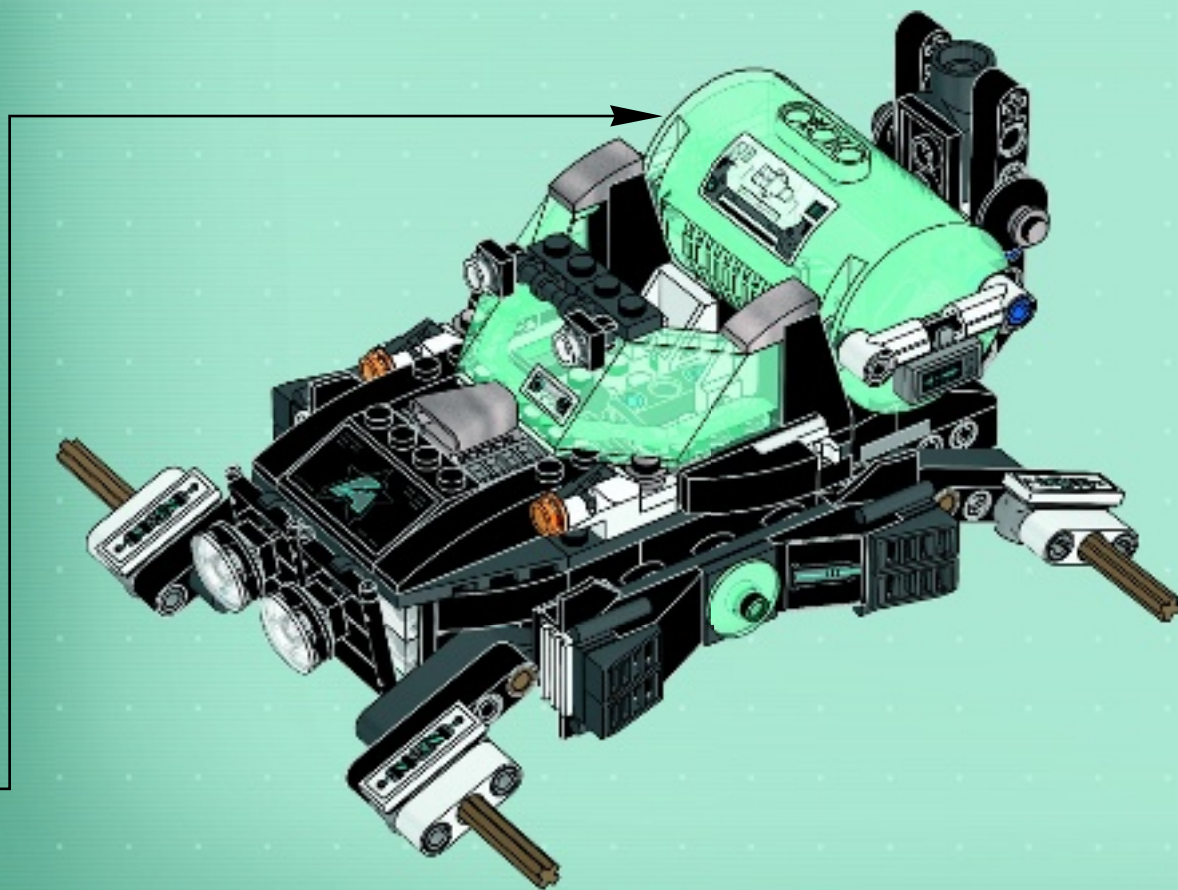

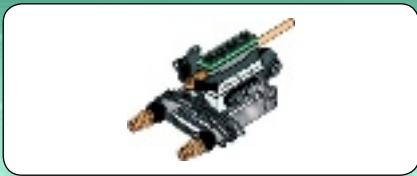

1

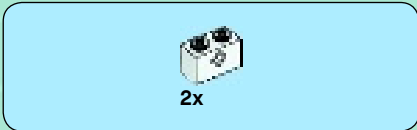

2

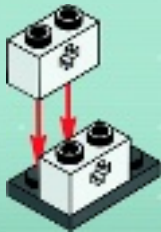

3

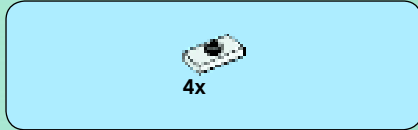
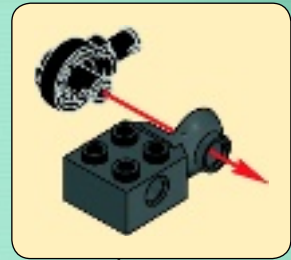

4



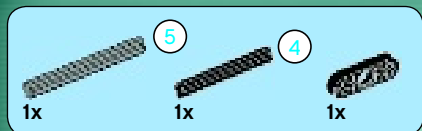

5

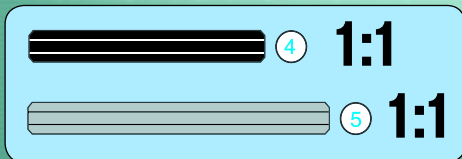
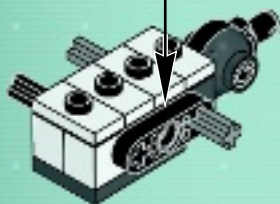
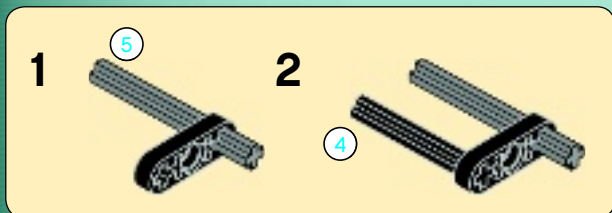

6

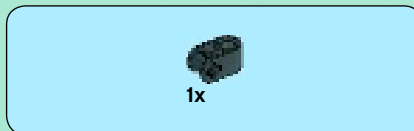
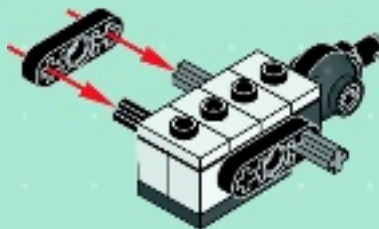

7

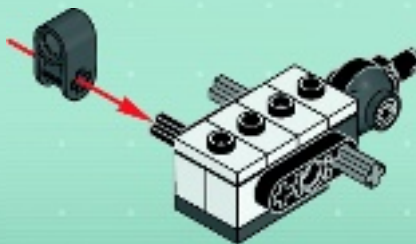

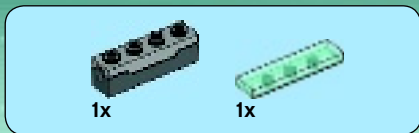

8

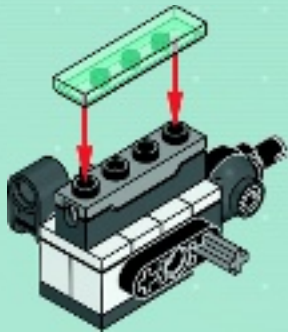

9

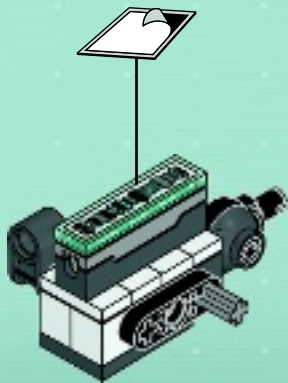

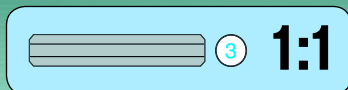
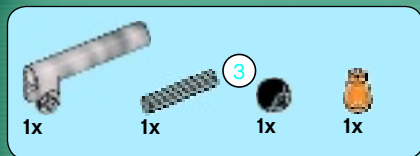

10

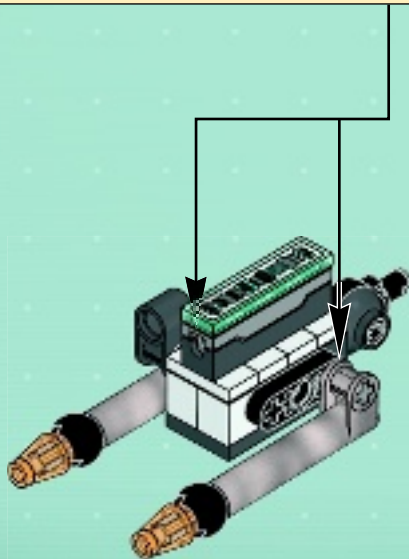
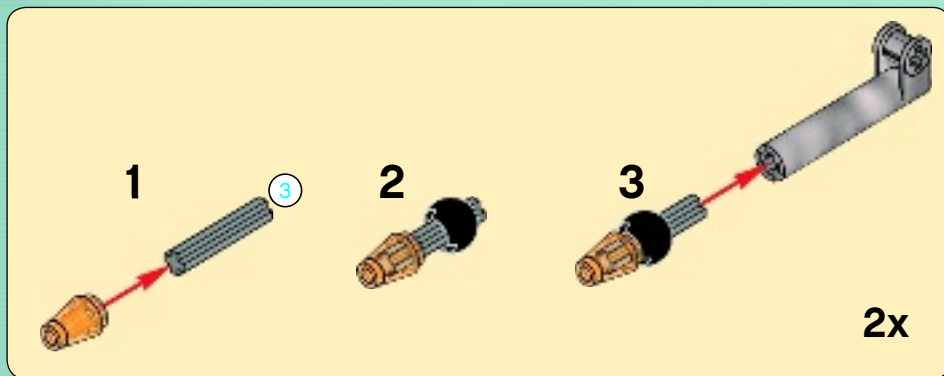

49

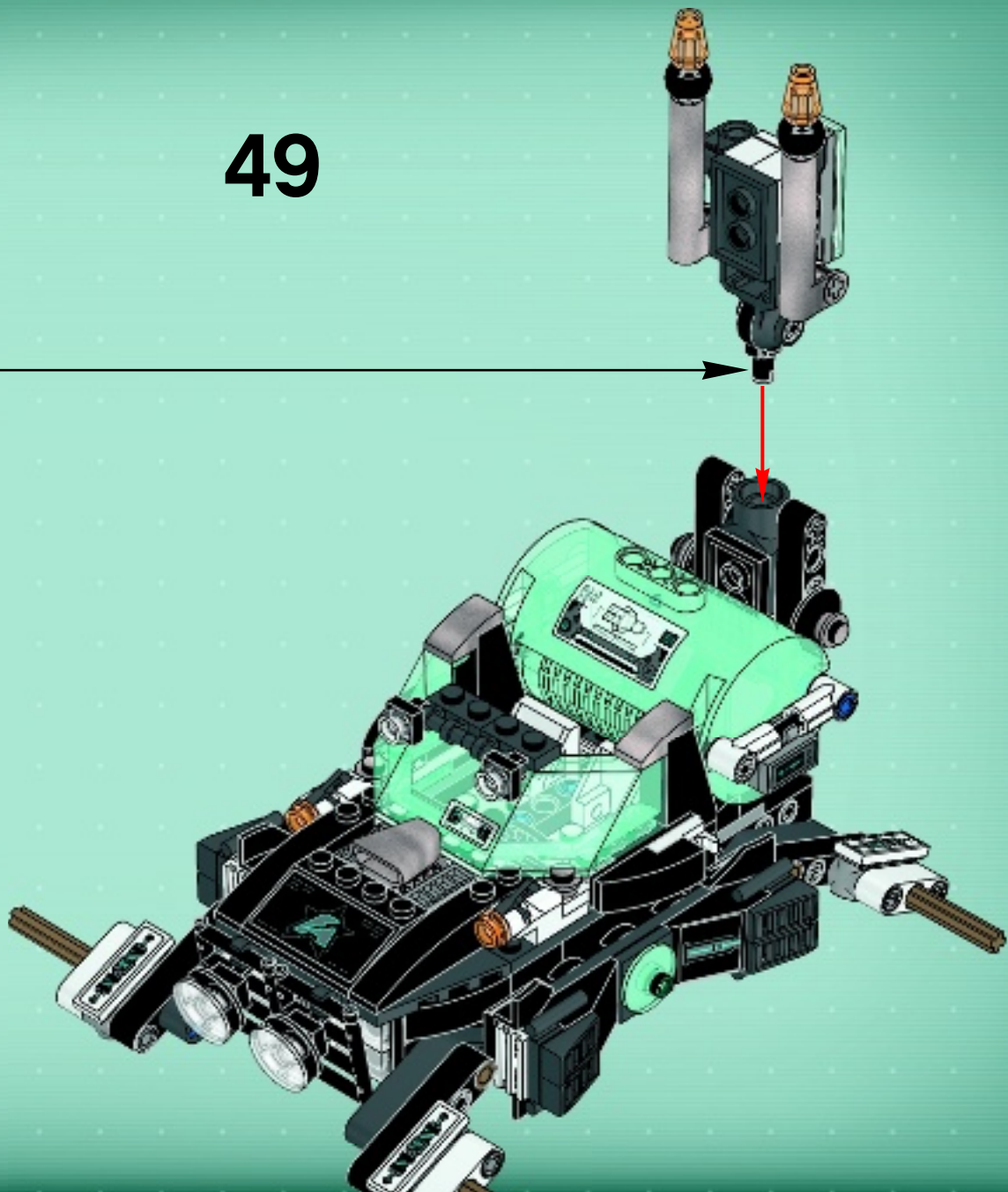



4x



4x



4x



4x

50

1



2



4x

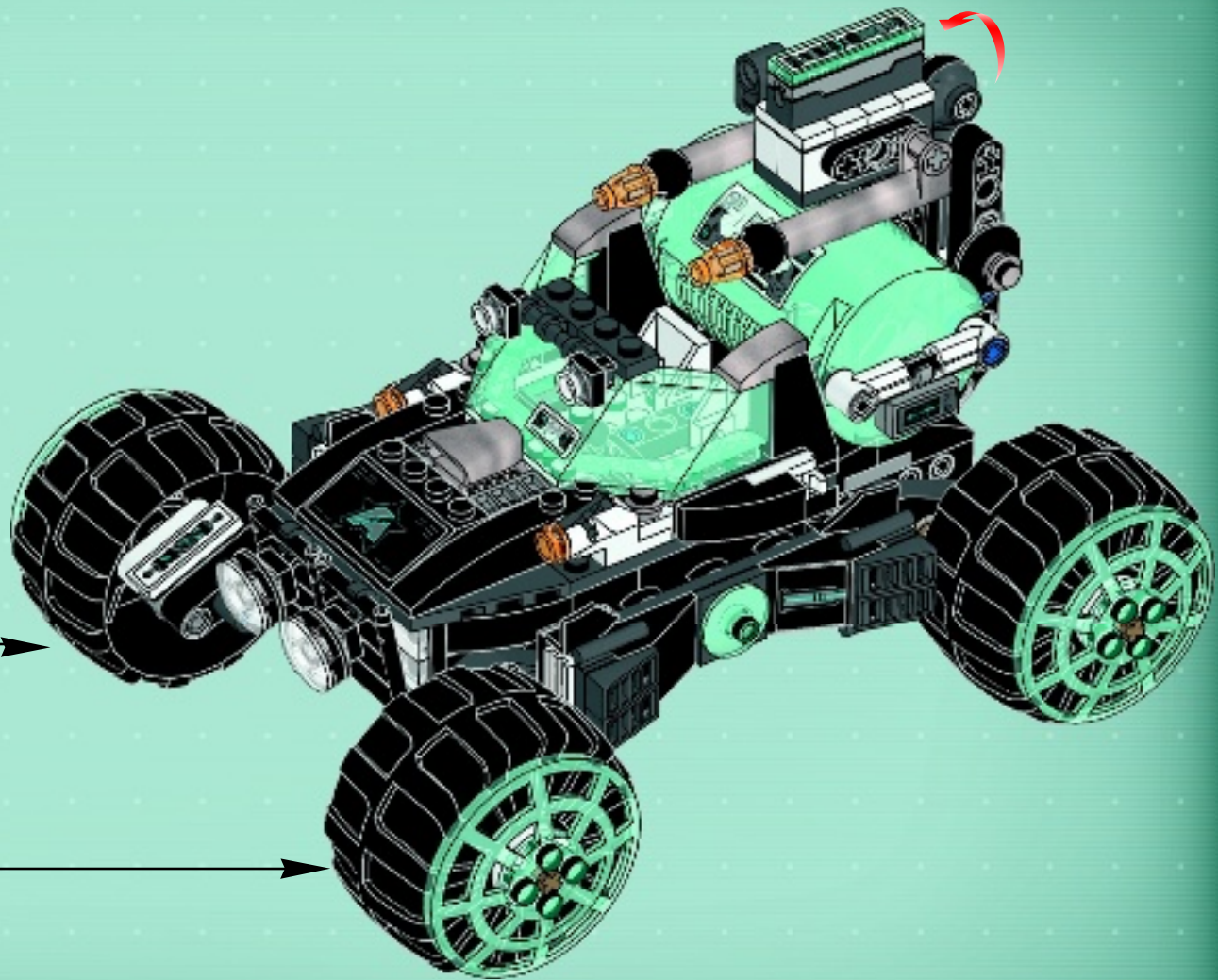



51

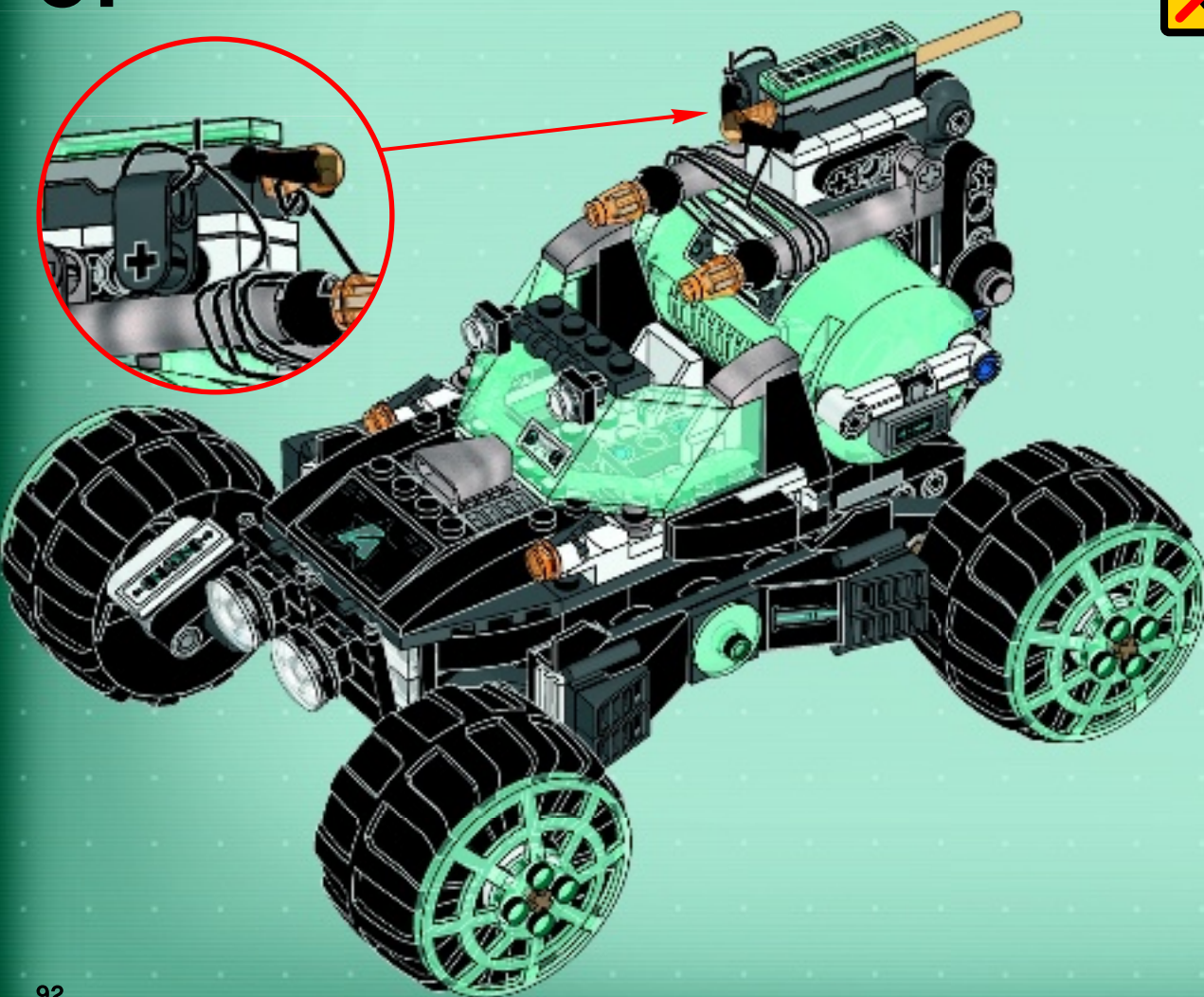

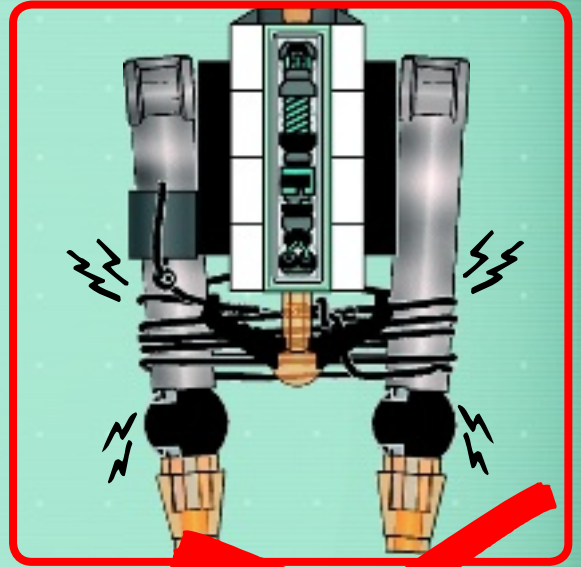
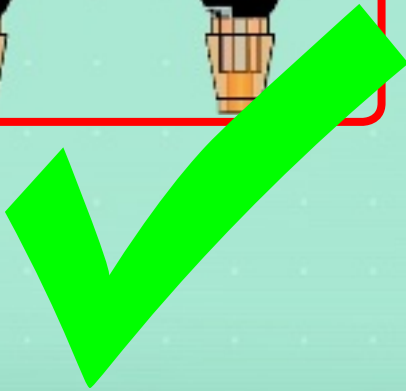
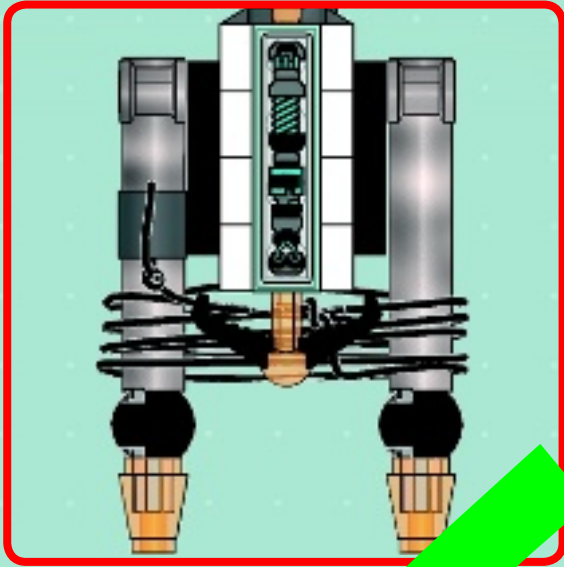

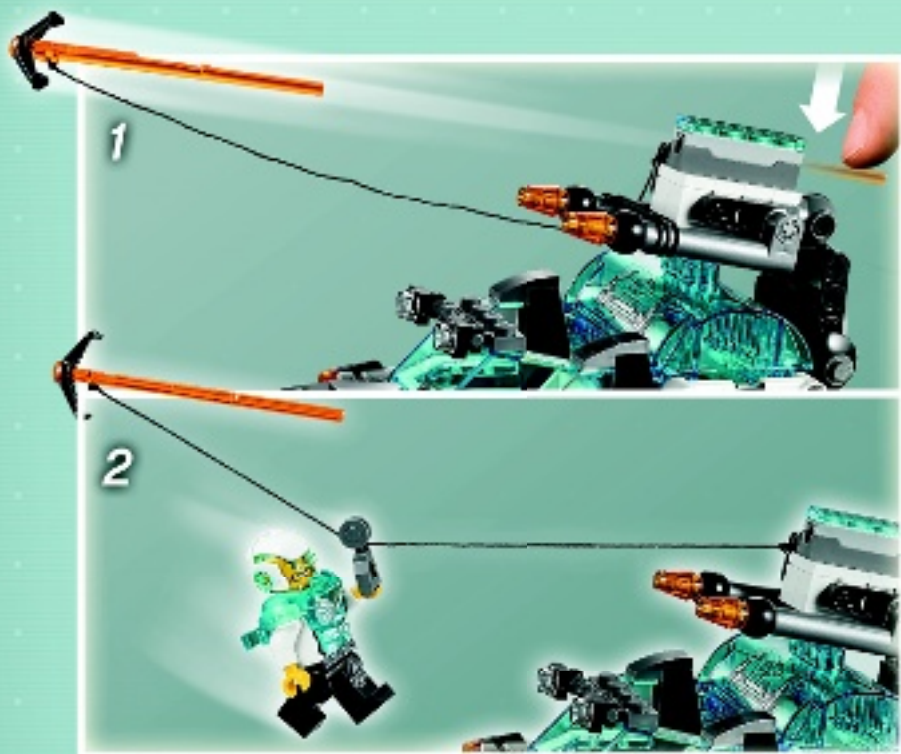



1x



1x



1x



2x



4x



2x



4x



2x

1



2



3



4



5



7



6



8



Download the app and use the AppBrick Gadget to complete the mission!



**Lade die App herunter und beende die Mission mithilfe des AppBrick-!
Télécharge l'application et utilise l'AppBrick pour réussir ta mission!
¡Descarga la app y usa el AppBrick para completar la misión!
Descarrega a app e usa o Gadget AppBrick para completares a tua missão!
Töltsd le az appot és az AppBrick eszközzel teljesítsd a küldetés!**

下載应用程序并使用 AppBrick 工具来完成任務!



Unlock the secrets with the new AppBrick Gadgets



Schalte geheime Inhalte mit den neuen AppBricks frei!

Découvre de nombreux secrets avec l'AppBrick

Descubre los secretos con los nuevos AppBricks

Desbloqueia os segredos com os novos Gadgets AppBrick

Tárd fel a titkokat az új AppBrick eszközökkel!

使用新的 AppBrick 工具来解锁秘密



ULTRA AGENTS



70168



70166



70169



70167



70170

LEGO *TECHNIC*



42037



42036



42033



42034



1x
4297719



3x
301001



4x
614301



15x
4233486



2x
389401



1x
4261941



4x
241201



14x
6051511



1x
6104200



4x
4558168



2x
371001



2x
4598527



2x
6101992



5x
4527839



1x
9327



1x
6105986



1x
6079760



1x
9551



4x
6023804



1x
6076599



2x
6102732



4x
4208160



4x
4118981



1x
4201062



1x
6057027



4x
362221



2x
4651524



2x
4544147



10x
4143005



17x
4206482



2x
4514553



1x
6102544



1x
6081298



1x
6105990



1x
6057831



2x
300326



2x
300926



8x
407026



8x
4533771



1x
4213374



1x
4194008



2x
446026



4x
329826



1x
329726



1x
6064228



8x
4251161



2x
4160393



2x
241226



2x
362326



3x
302026



2x
379526



2x
303226



5x
6066102



2x
4140588



2x
6089577



2x
614126



8x
403226



4x
474026



6x
4278359



2x
4521681



1x
4530589



6x
6093525



1x
6104618



5x
6006739



1x
4659662



4x
6097664



4x
4184813



2x
4541191



4x
4218581



2x
4289538



5x
4142135



2x
4286267



2x
4107828



1x
4184169



2x
370326



2x
4111998



12x
4121715



1x
370526



1x
6081972



4x
4569297



2x
3005740



2x
4278412



4x
6081809



3x
6073445



2x
6051918



1x
4586557



2x
4163917



2x
4581214



1x
6106471



1x
6097145



1x
6103865



1x
4525032



2x
6056370



3x
4153989



2x
3005748



2x
6021751



12x
3005749



1x
4540417



1x
4654448



2x
6023954



2x
4164037



2x
6092592



1x
6104156



6x
4540385



2x
6025028



2x
4140345



8x
6055631



1x
6102608



1x
6102607



4x
4567338



3x
4222960



1x
6097148



2x
6003033



1x
6104663



6x
4211476



2x
4211440



2x
4211414



1x
4211397



4x
6043656



1x
6028812



4x
4654577



1x
4211542



1x
6106496



1x
4211658



1x
4211748



4x
4225033



6x
4211375



4x
4211815



1x
4211639



1x
4225973



1x
4225975



2x
4210697



1x
4211076



2x
4565322



1x
4211043



2x
4210998



1x
4210794



2x
6039479



2x
4210660



1x
4581225



4x
6039482



4x
4263176



1x
4227398



1x
6039699



2x
4260707



1x
4210782



1x
4210788



1x
4211042



1x
6081302



3x
4521512



1x
4211081



1x
6048898



4x
4210656



1x
4210851



1x
4210665



2x
4499858



2x
6047418



8x
4540386



3x
6051334



2x
6092500



14x
4633691



1x
6104158



1x
6076604



2x
4609612



2x
4625376



4x
6103777

Customer Service

Kundenservice

Service Consommateurs

Servicio Al Consumidor

LEGO.com/service or dial



: 00800 5346 5555

: 1-800-422-5346