



CLASSIC

7 [LEGO.com](https://www.lego.com)

10698





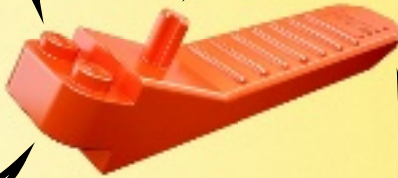

LEGO.com/brickseparator



Easy building
Einfach zu bauen
Construction facile
Construcción fácil
Kezdő építőknek
简单拼砌



Medium building
Mittelschwer
Construction intermédiaire
Construcción intermedia
Construção intermédia
Gyakorló építőknek
中级拼砌



Advanced building
Fortgeschritten
Construction avancée
Construcción avanzada
Construção avançada
Tapasztalt építőknek
高级拼砌



LEGO.com/classic

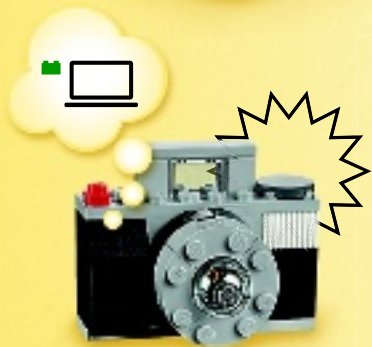

Page/ 页码

12

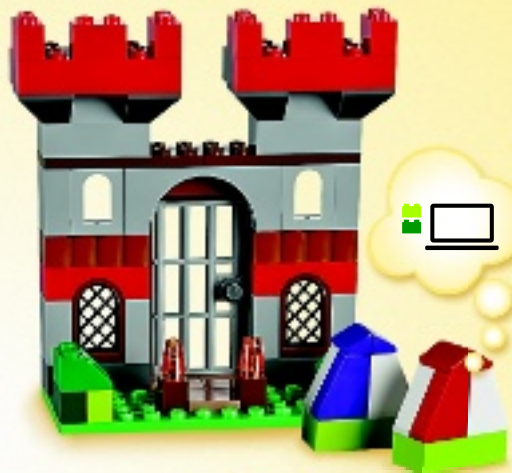

Page/页码

6



Page/页码

36

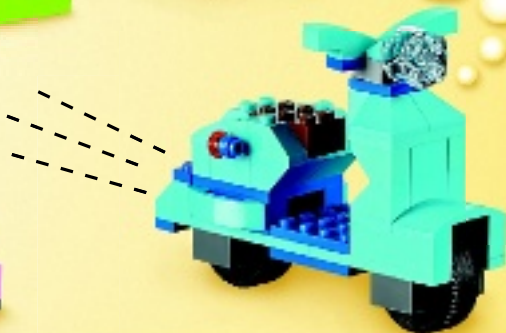



1





1x



1x

2



2x

3





1x

4



1x



1x

1

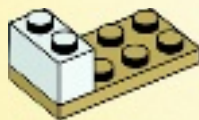



1x

2

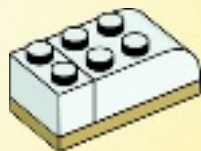

2x

3

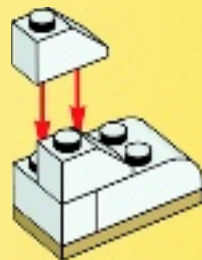



2x

4

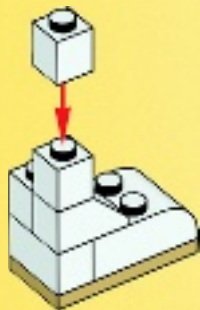

5

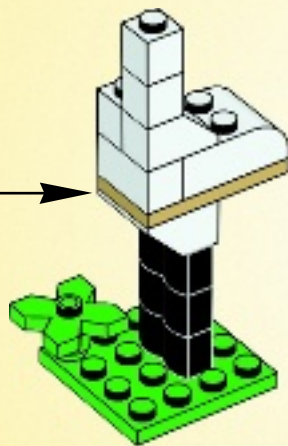

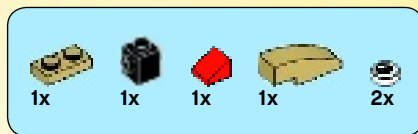

6

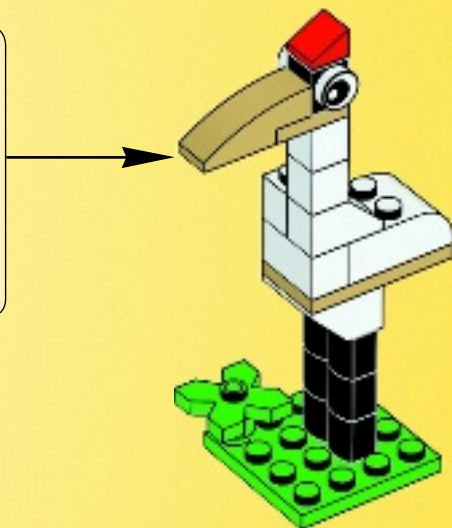
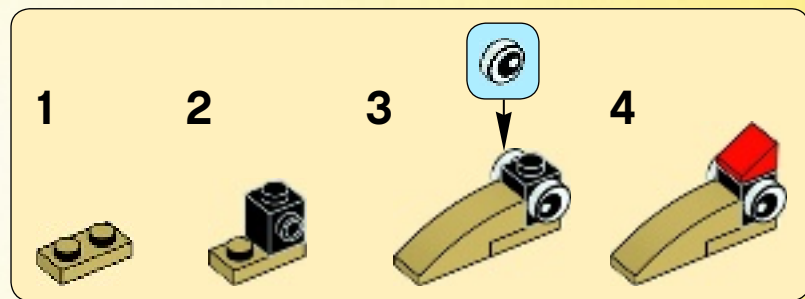



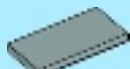

4x

1

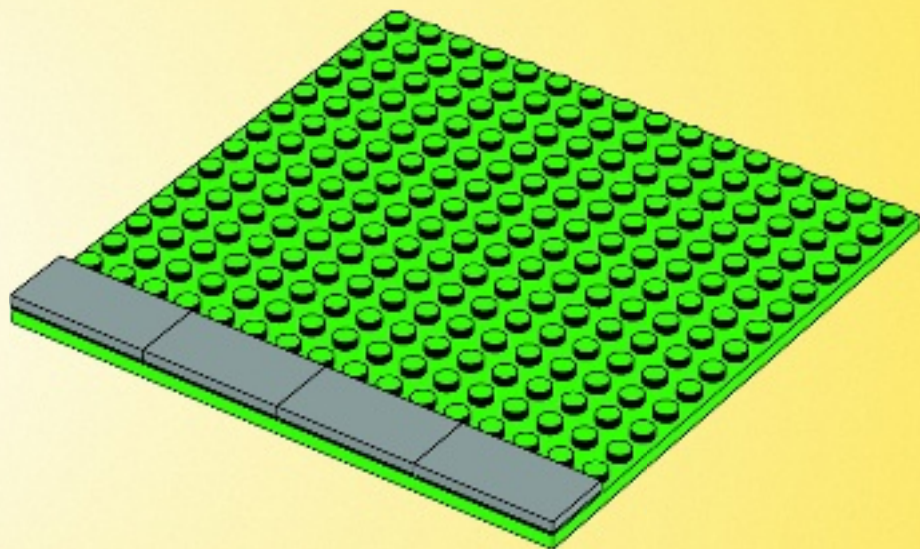

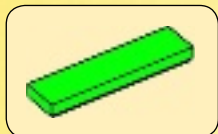
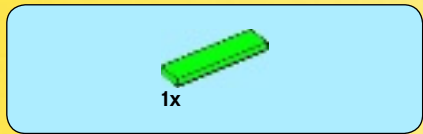

2

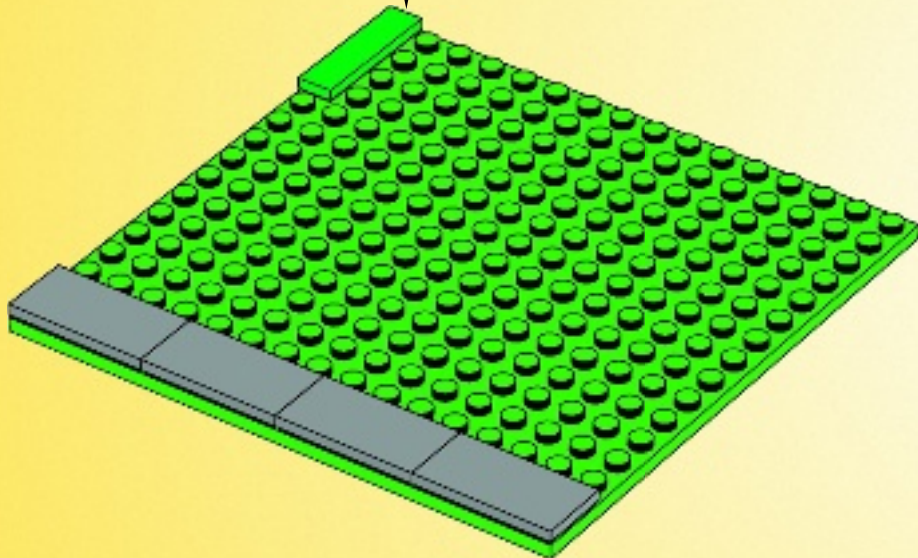



2x

3

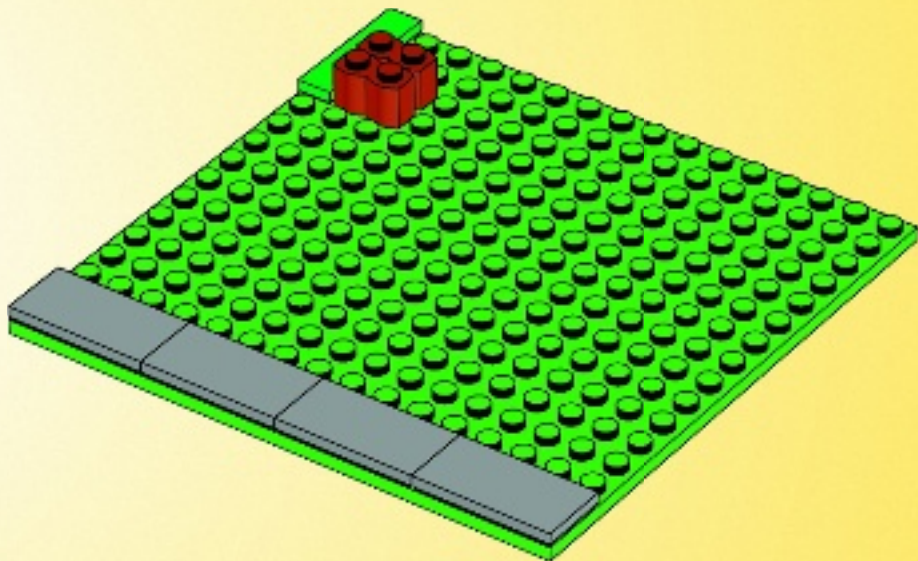



2x

4

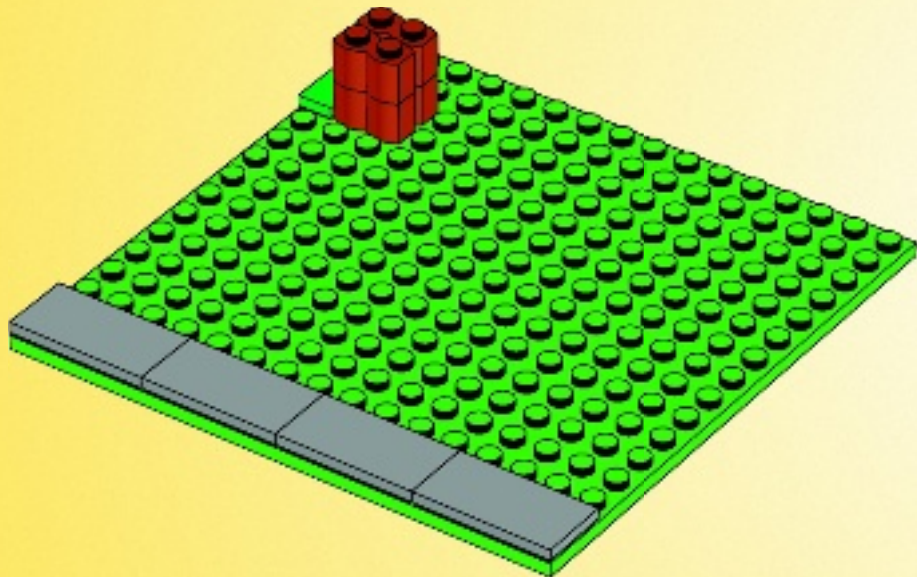

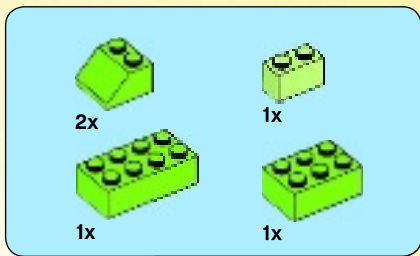

5

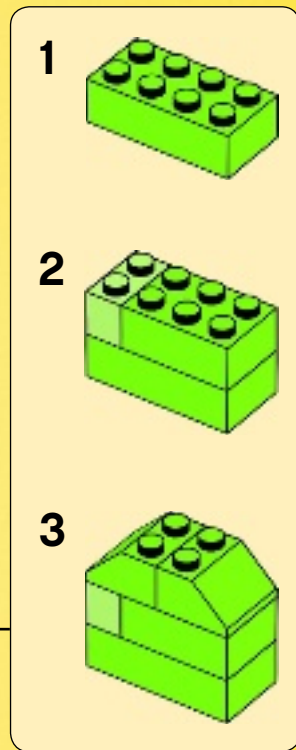
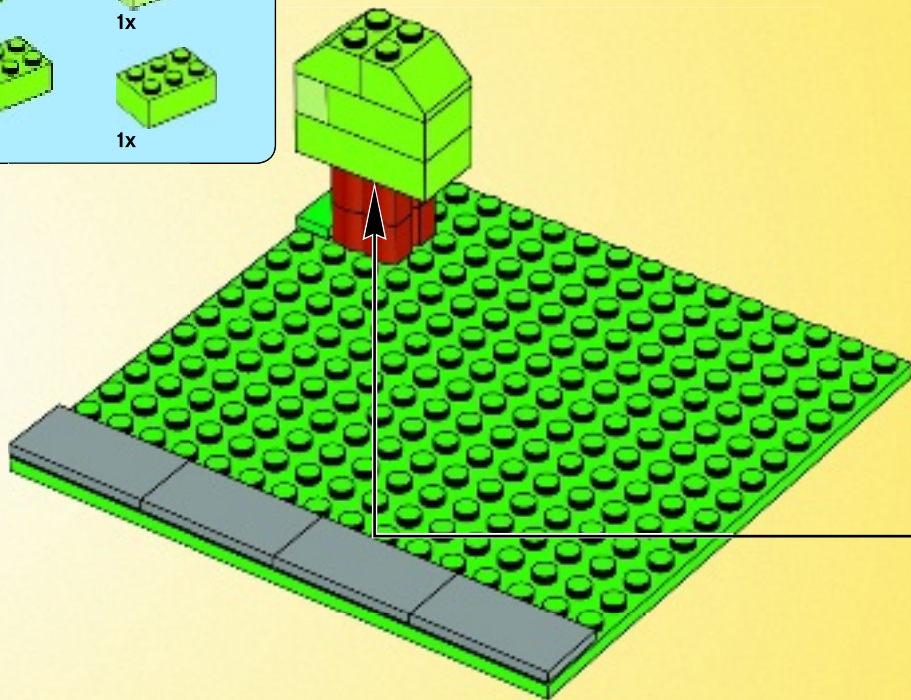

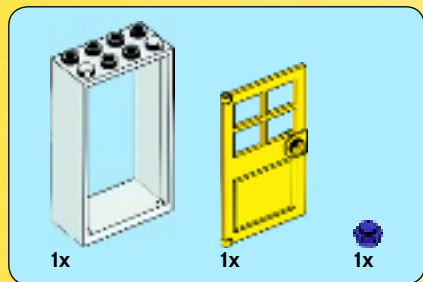

6

1

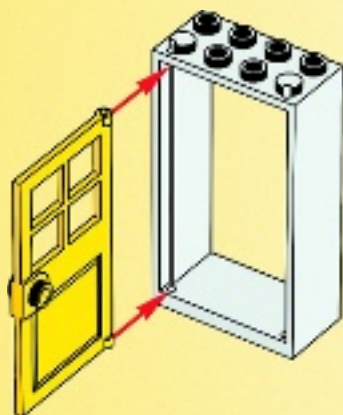

2



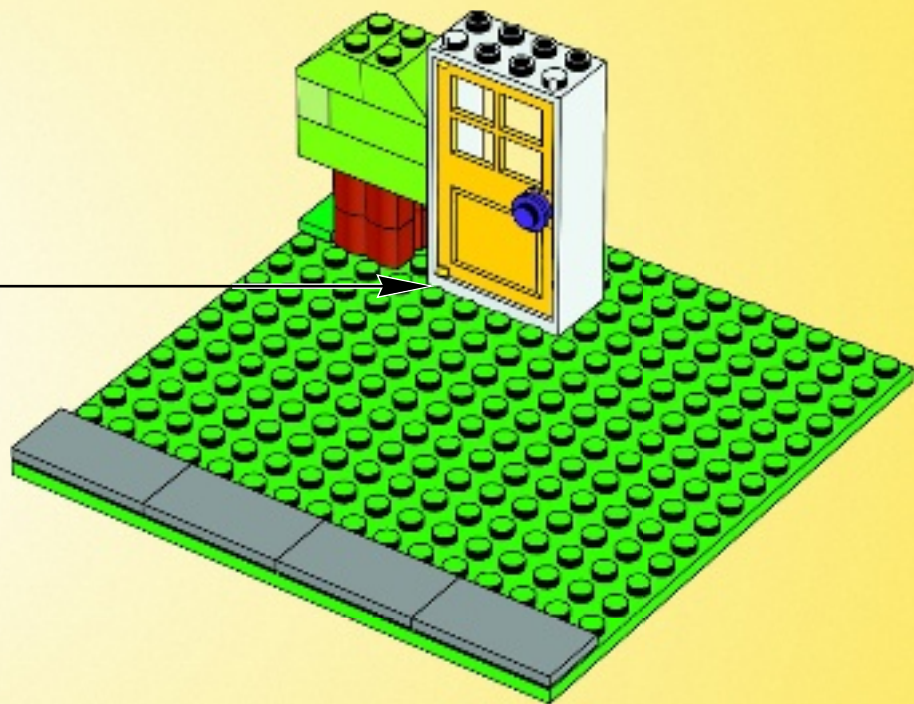



1x

7

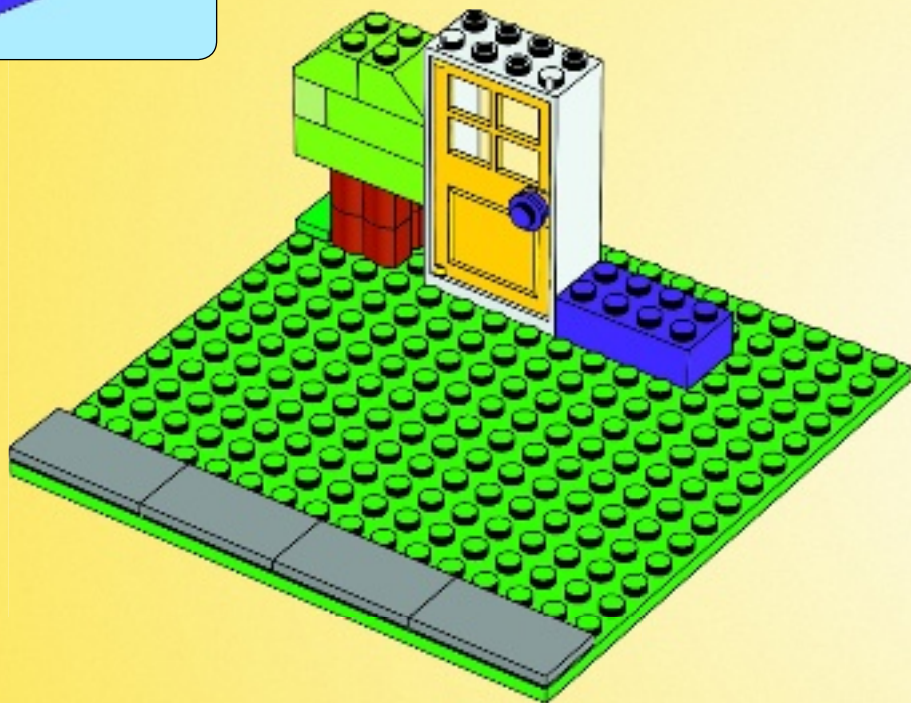



1x

8

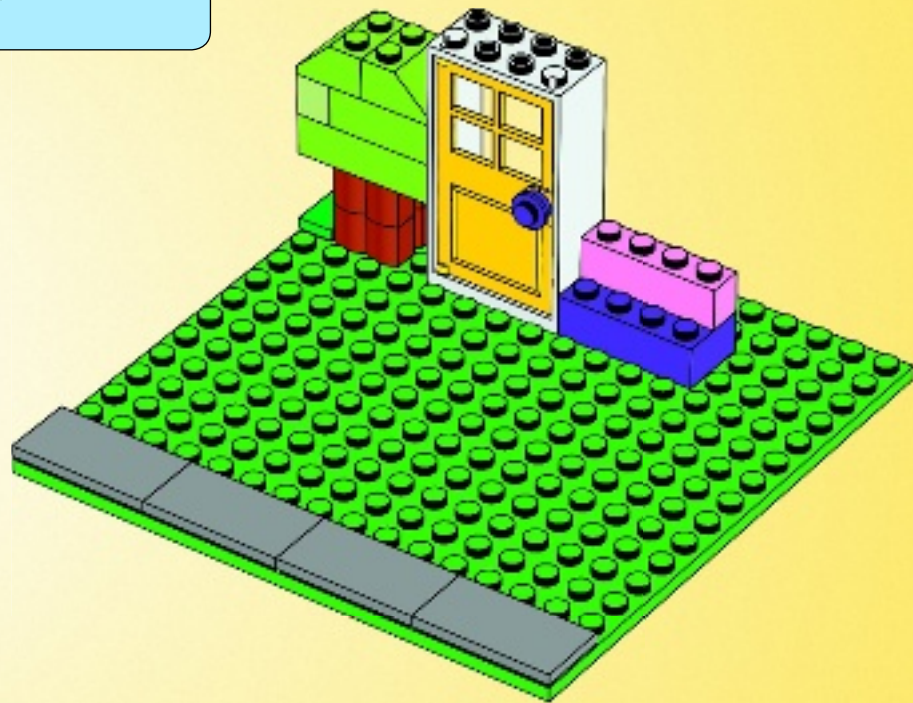



1x

9

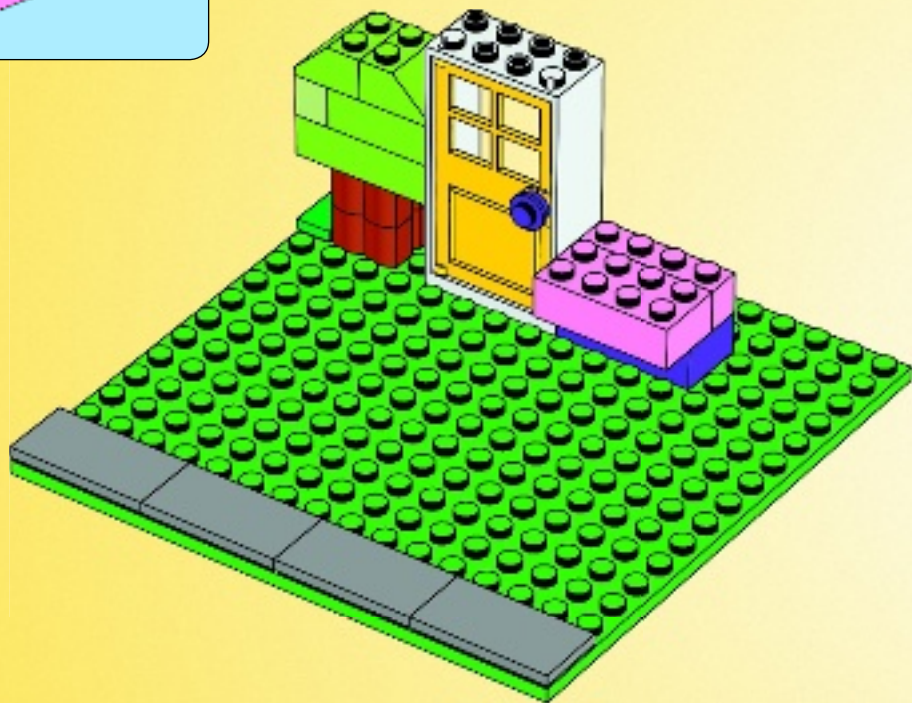



1x

10



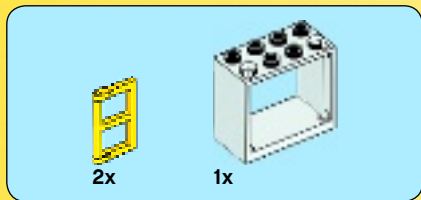

11

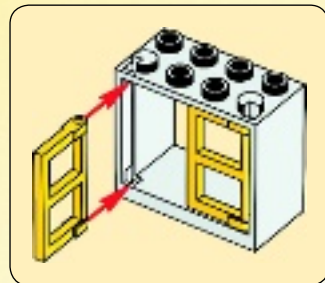
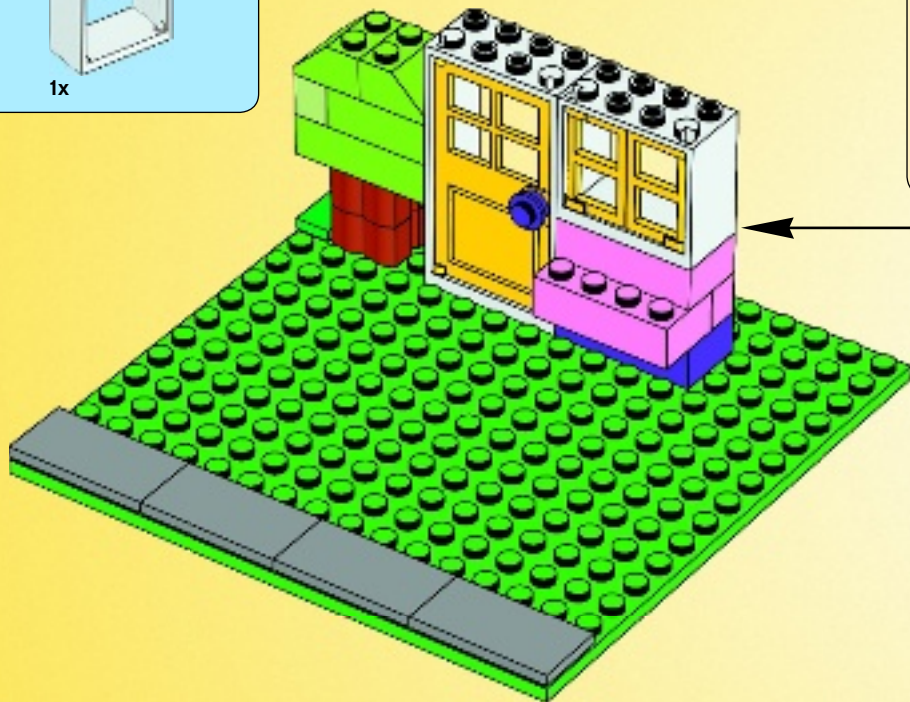



1x



1x

12

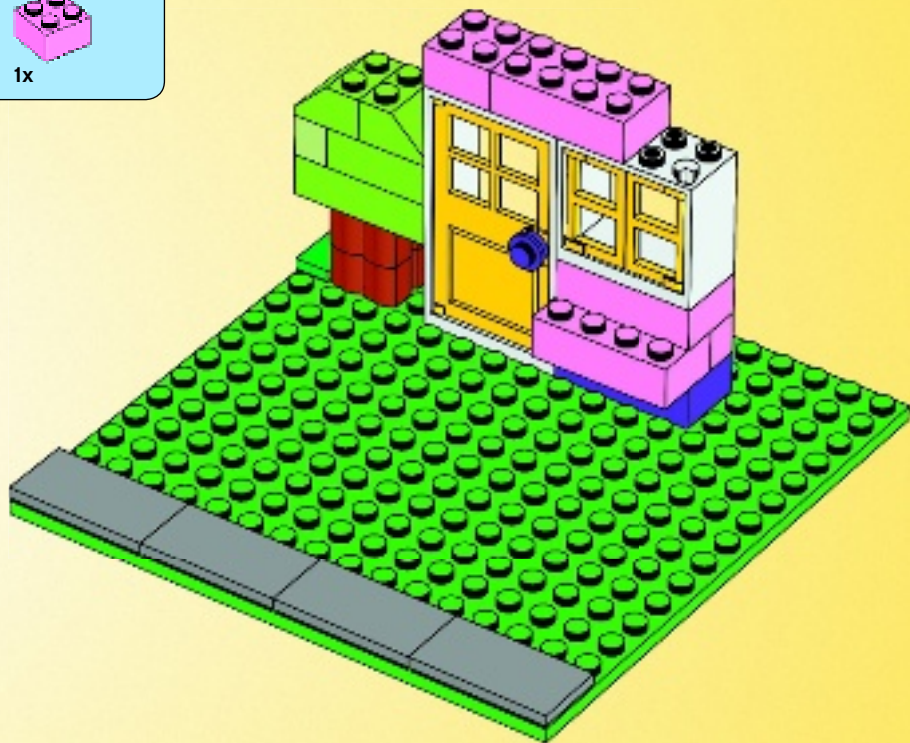

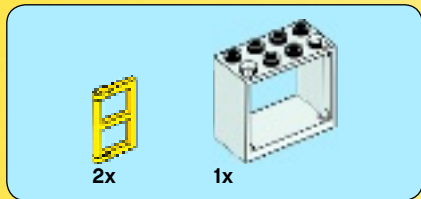

13

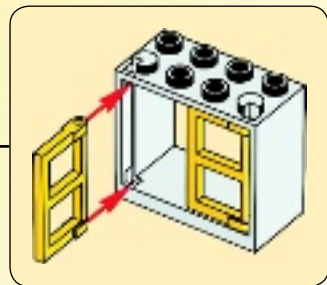
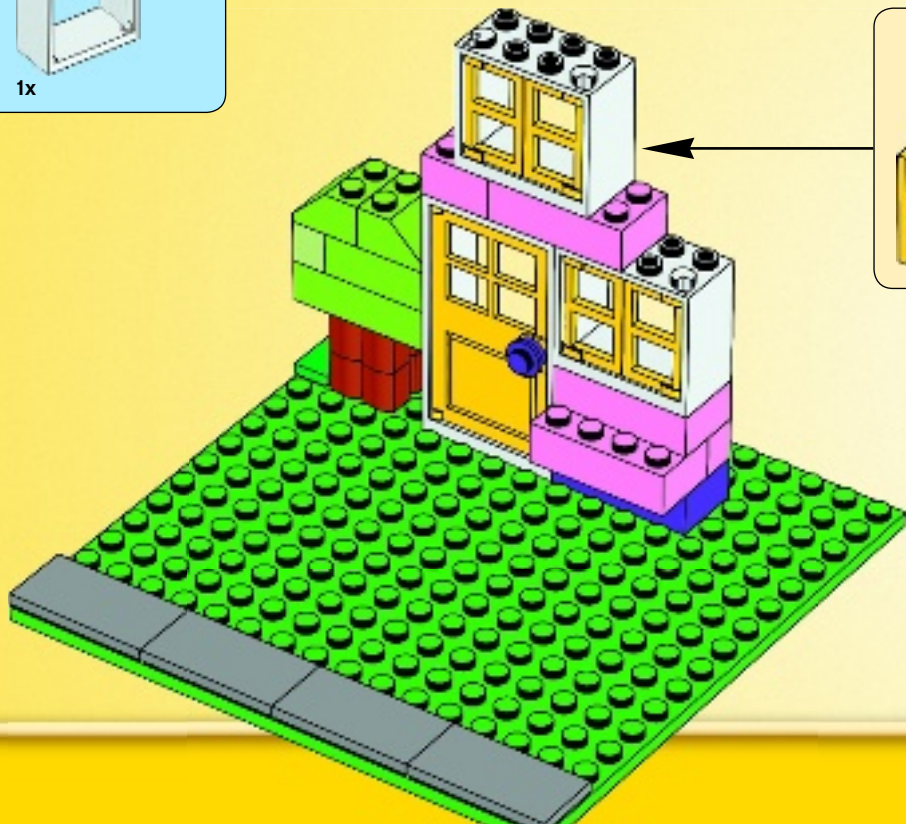



4x



1x

14





2x

15





1x



2x

16





1x



1x

17





1x



1x

18





3x



2x



1x



1x

19

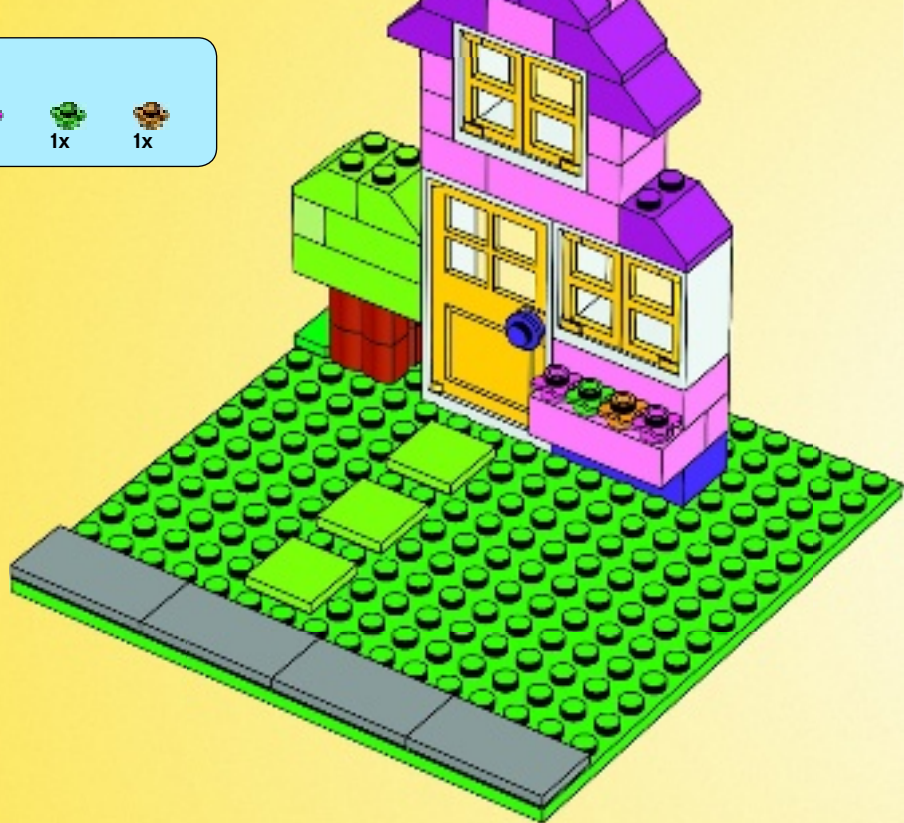

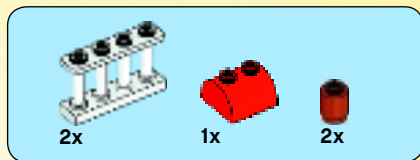

20

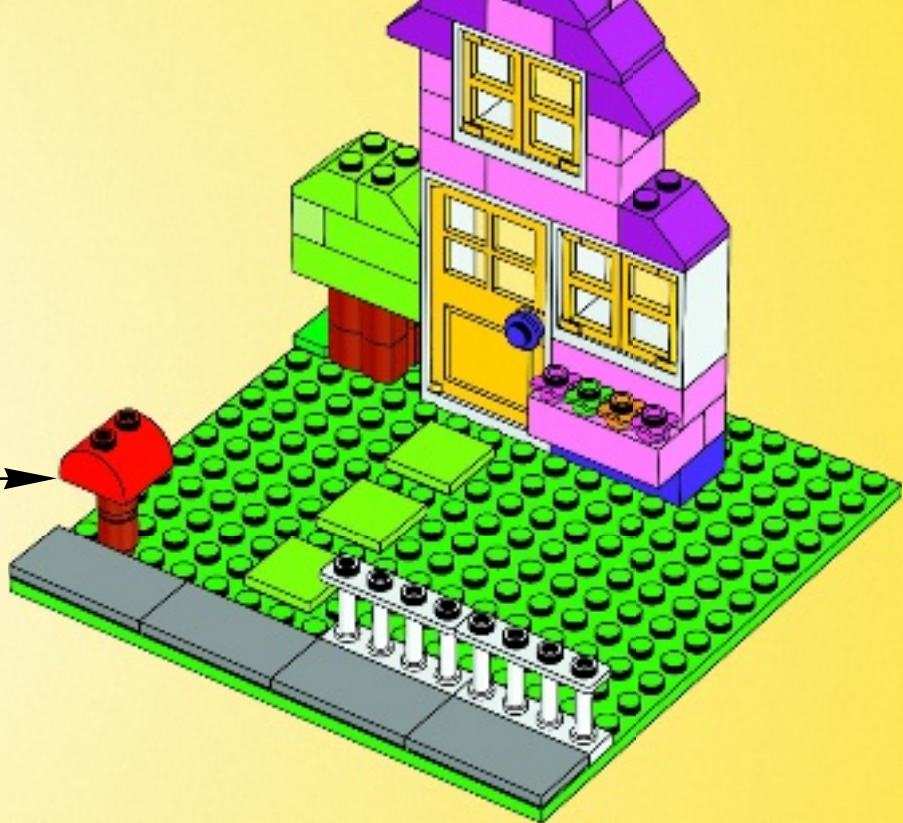
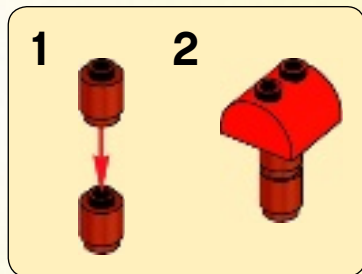



2x

21





2x



2x

22



2x



1



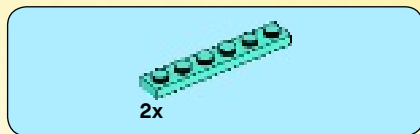

2

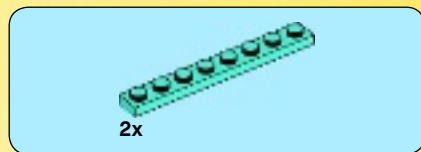
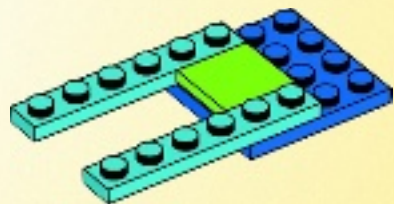

3

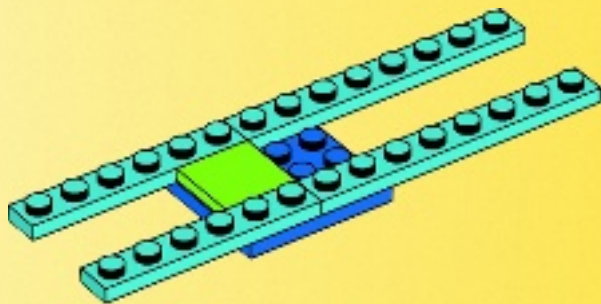

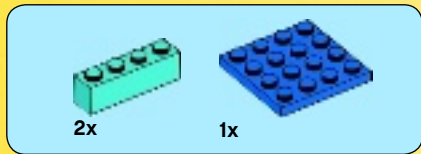

4

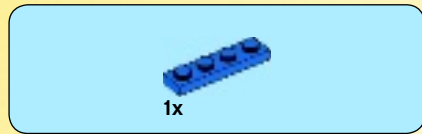
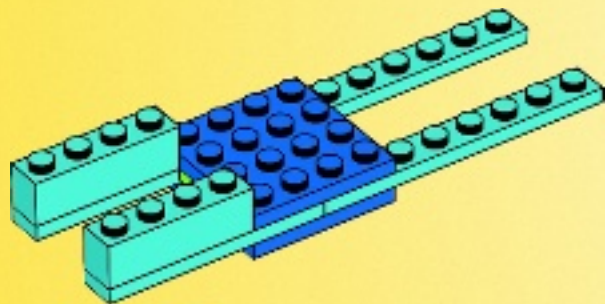

5

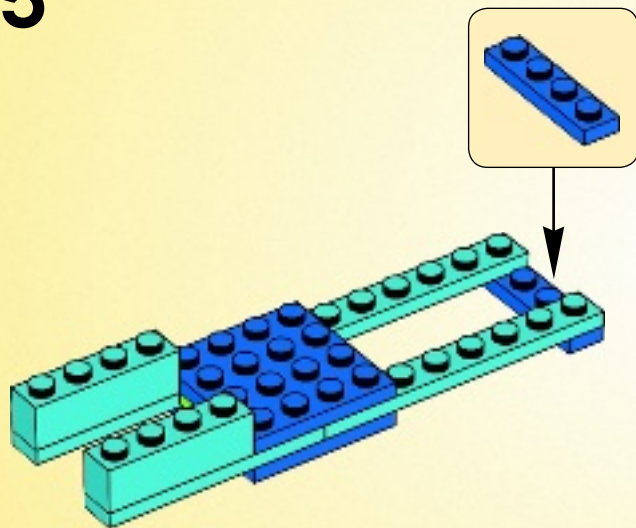



6

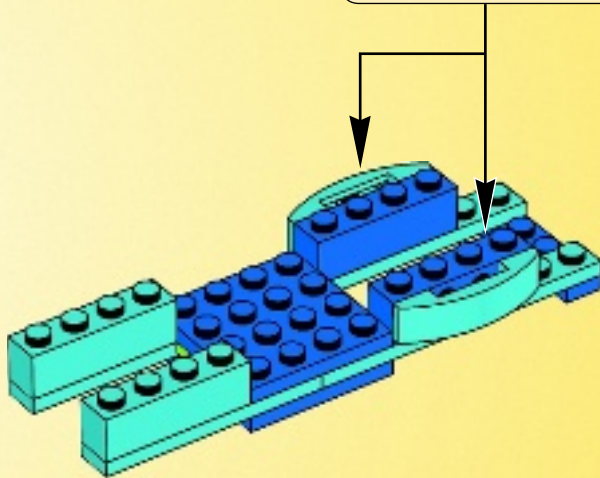
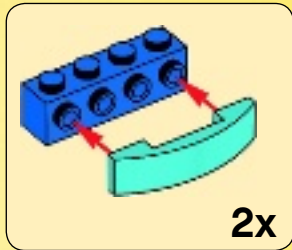



2x

7

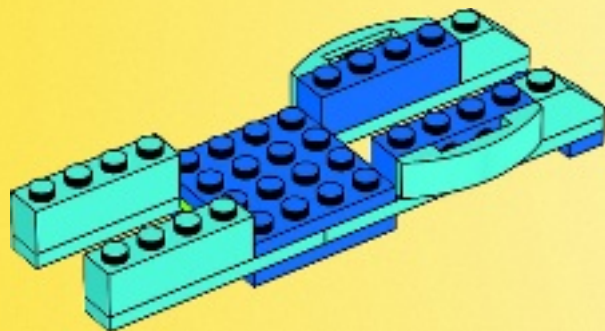

1x

8

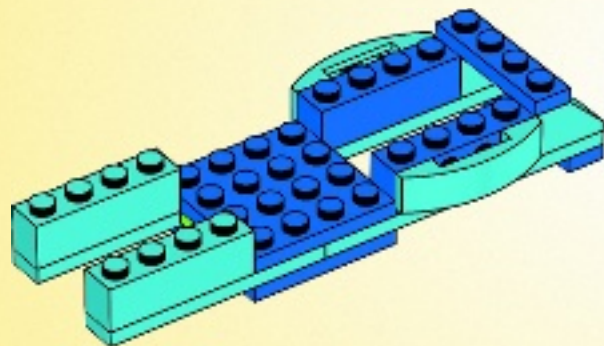



2x



2x

9

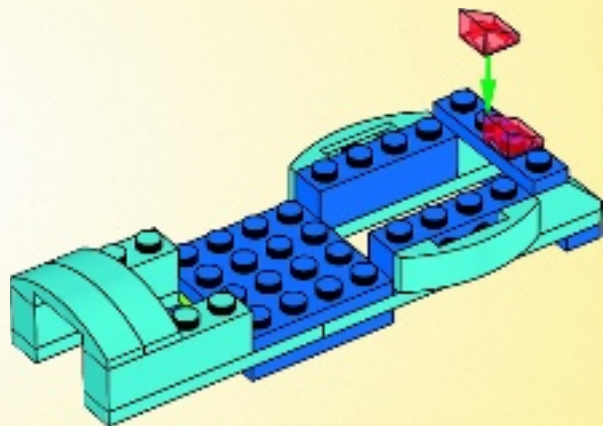

1x

1





1x

2

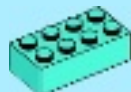

1x

3

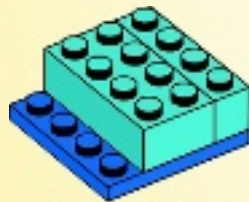



2x

4

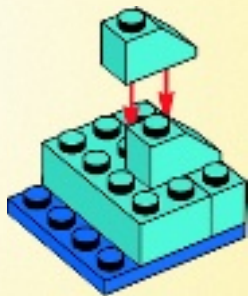

2x



2x

5

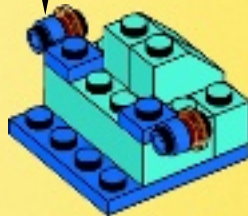



2x

6

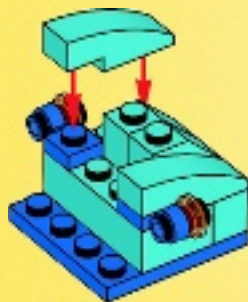

2x

7

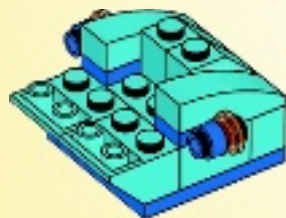



1x

8

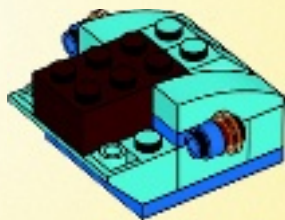

2x

9

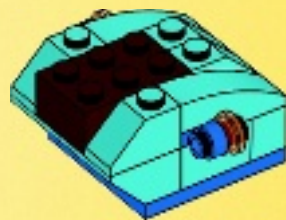

10

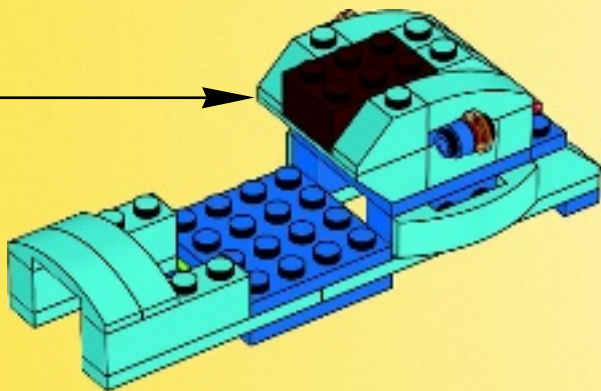

1x

1





2x

2

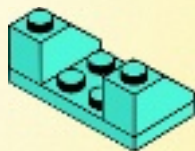

1x

3

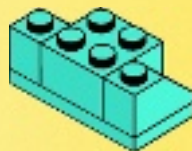



1x



1x

4

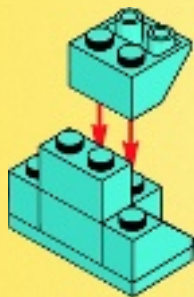

2x

5

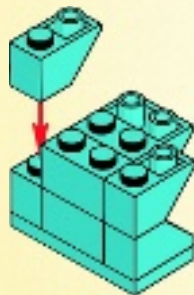

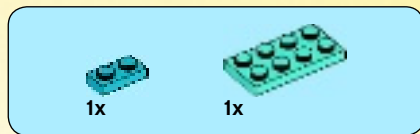

6

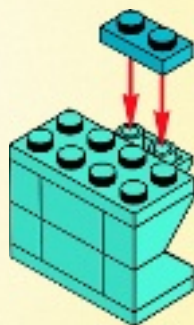

11

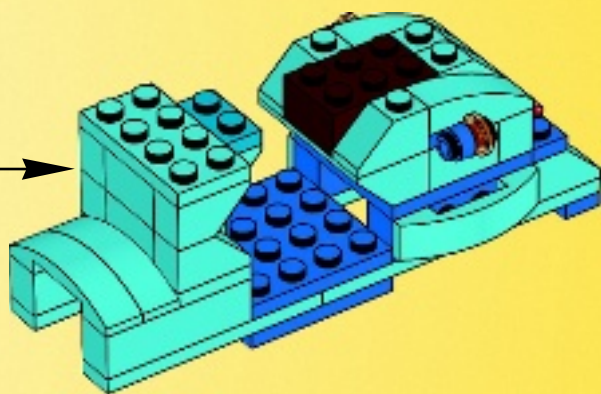

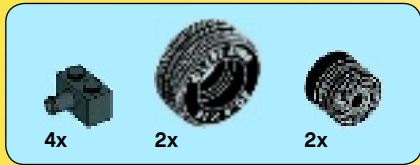

12

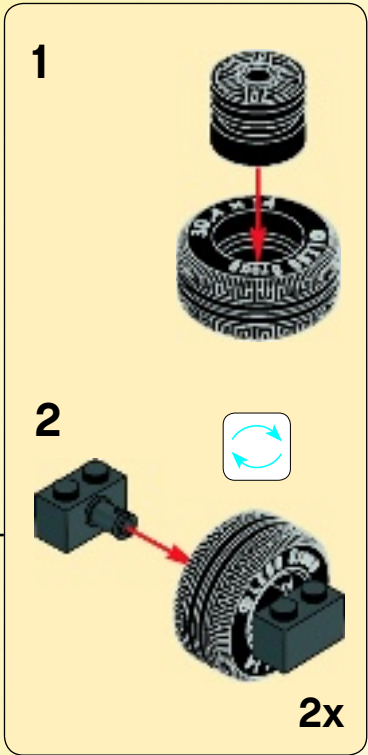
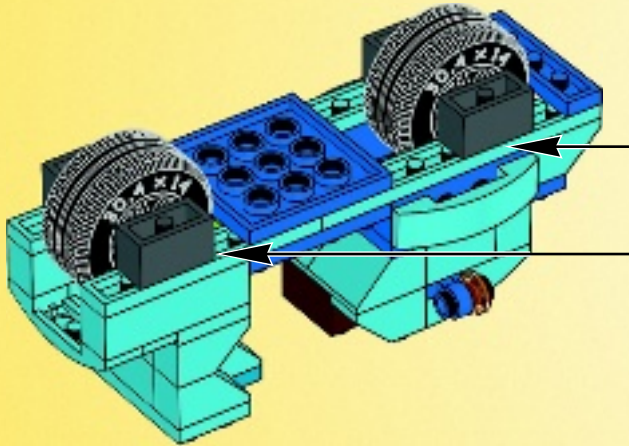
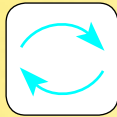



1x



2x

13

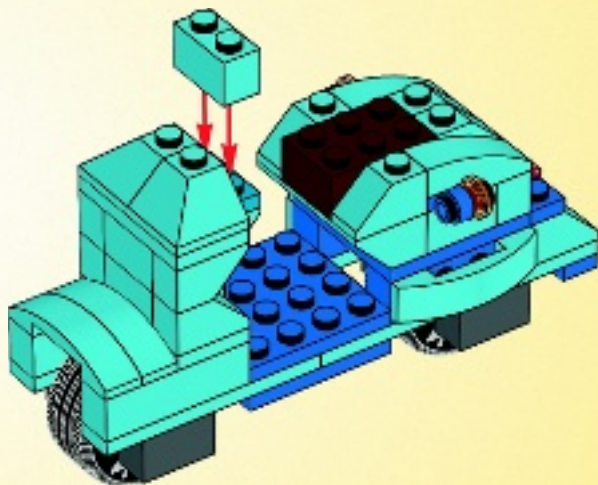
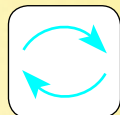

1x



1x

14

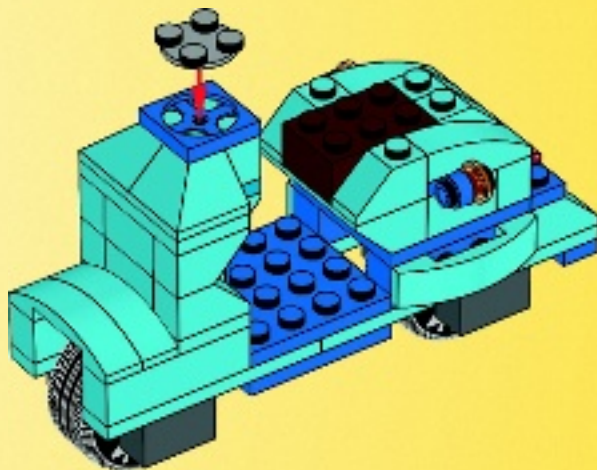

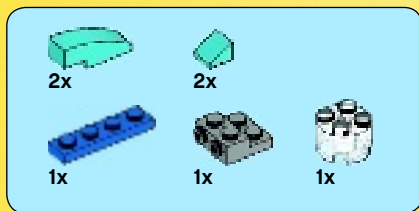

15

1



2



3

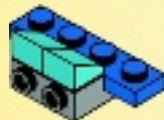

4

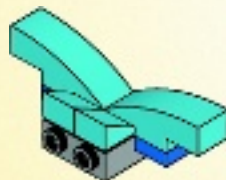

5

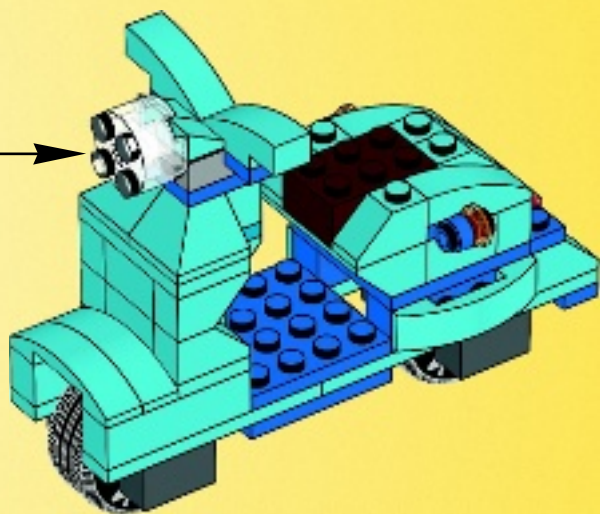
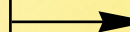
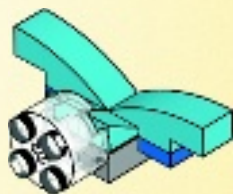



More ideas online:
LEGO.com/classic

More ideas online:
Weitere Ideen online:
Plus d'idées en ligne :
Más ideas en Internet:
Mais ideias online:
Online még több ötletet találsz:
更多在线构思:
LEGO.com/classic



LEGO CLASSIC



10692



10693

10694



10696

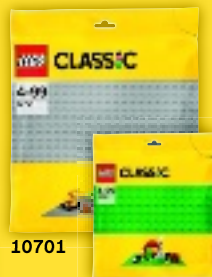







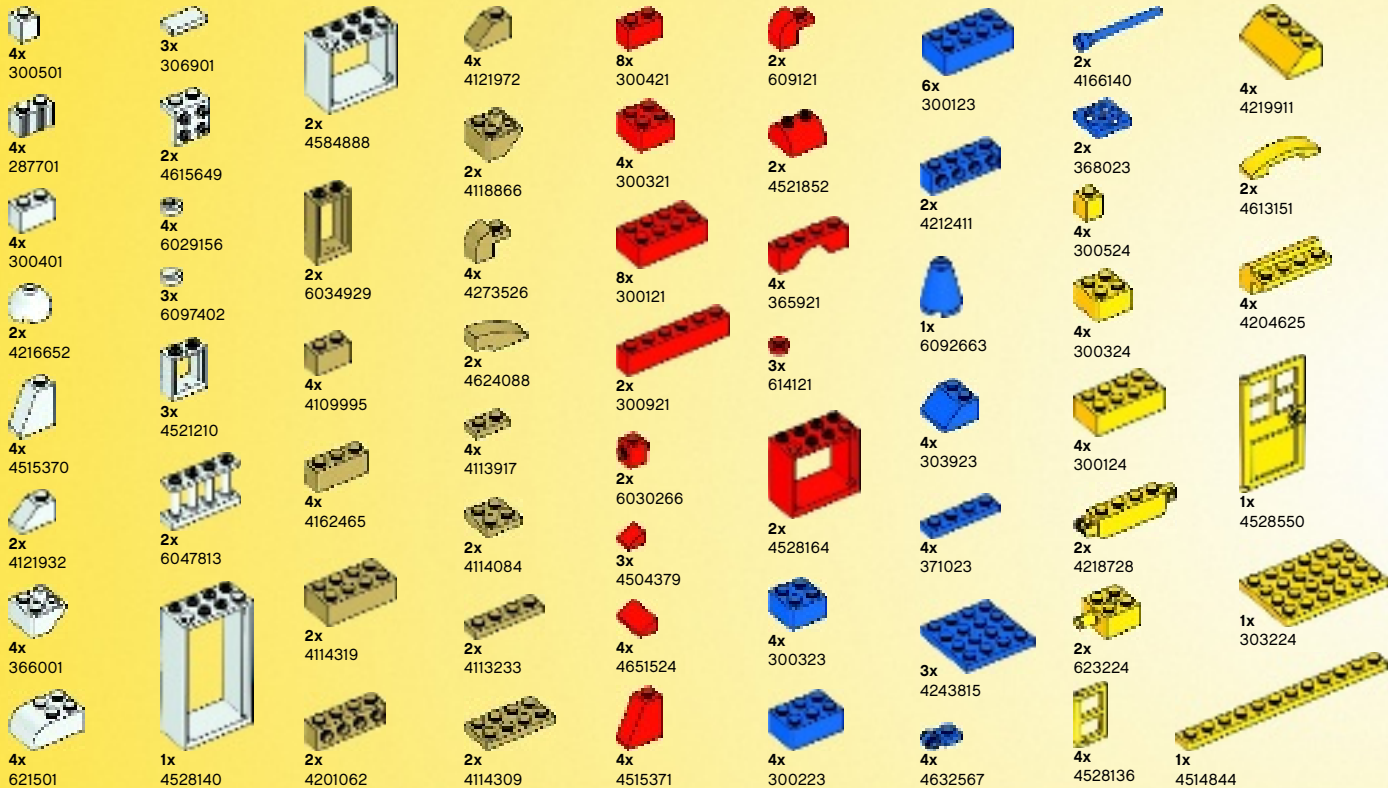

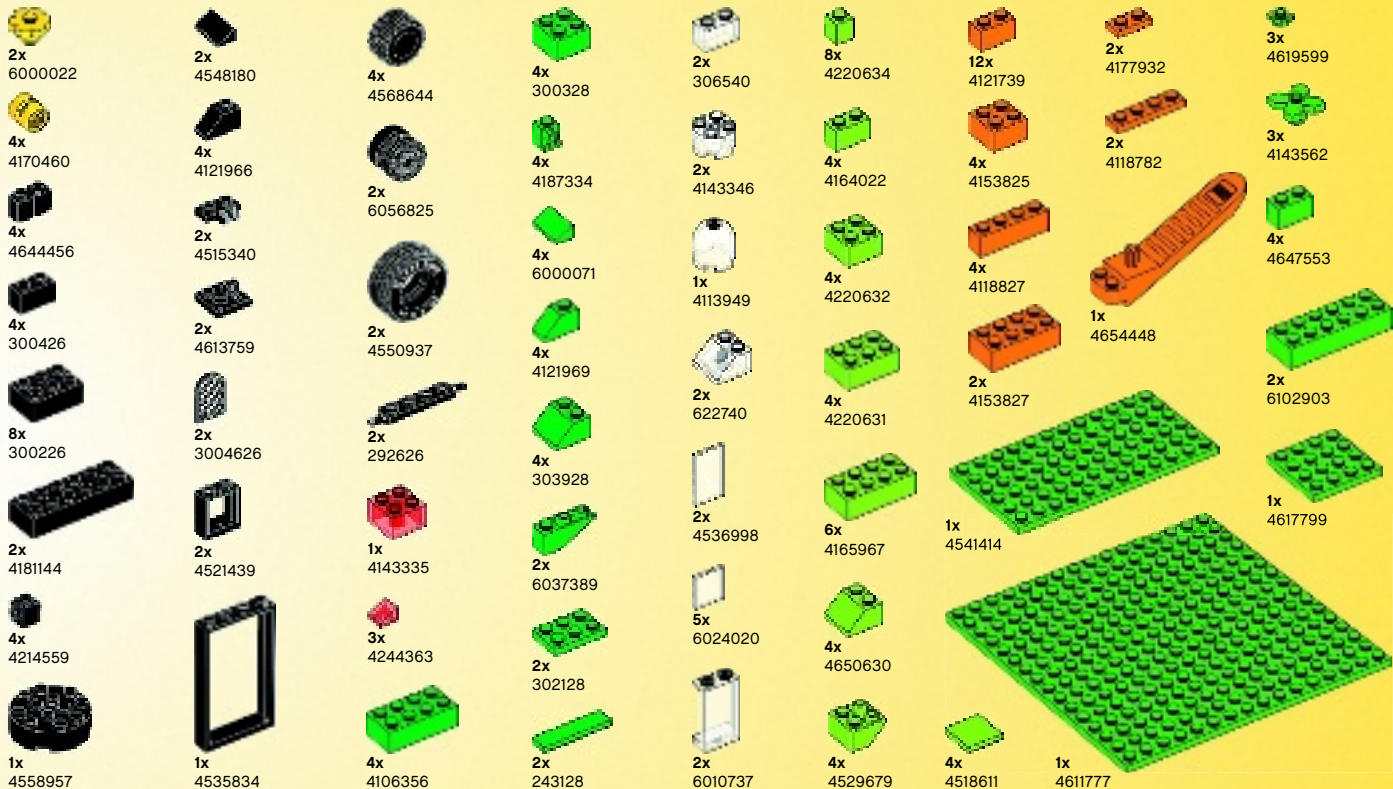

























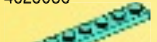















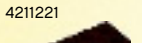



10701

10700





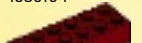

 8x 4569382	 4x 6036238	 4x 6097093	 4x 6022035	 16x 4249891	 4x 4216668	 2x 4542131
 8x 6058085	 4x 4625629	 4x 4655256	 4x 4625626	 8x 4245570	 4x 4211225	 2x 6092659
 2x 6058135	 3x 4619520	 2x 4625036	 8x 4550362	 4x 4260493	 2x 4211183	 3x 4567338
 8x 6004943	 4x 6070769	 2x 6074793	 4x 4518889	 4x 6003331	 2x 4211199	 2x 6061560
 4x 4655172	 8x 4619655	 6x 4651903	 2x 6037652	 4x 4541376	 4x 4211221	 3x 4222960
 4x 4653988	 4x 6070756	 4x 6022023	 4x 4255416	 4x 4539102	 2x 4211247	 4x 6100027
 4x 6092674	 4x 6036493	 2x 6102516	 4x 4247145	 4x 4539104	 3x 4216581	 4x 6020181
 4x 4653970	 4x 6035598	 4x 6104578	 4x 4507045	 2x 6089268	 2x 6084571	 3x 4624184



4x
4211389



8x
4211564



8x
4211388



4x
4211394



4x
4211385



4x
4567448



1x
6106189



2x
4211356



4x
4560183



1x
4541978



1x
4654577



2x
4642934



1x
4610149



2x
4211406



1x
4211473



2x
4540203



4x
4211088



3x
4211085



4x
4211087



4x
4210862



2x
6039176

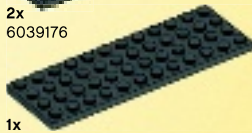

1x
4210706



2x
4210633



2x
6056296



4x
4517992



3x
6057894



3x
4216479



2x
4541873



4x
4653960



4x
4626935



4x
4622176



4x
4566607



4x
6022070



3x
4566522



8x
6057986



6x
4286050



8x
4517993



8x
4550359



4x
4518890



4x
4520632



8x
4666352



2x
6000743



4x
6074890



8x
6022083



8x
6036232



Customer Service

Kundenservice

Service Consommateurs

Servicio Al Consumidor

LEGO.com/service or dial



00800 5346 5555

1-800-422-5346

WIN

GO TO WWW.LEGO.COM/PRODUCTFEEDBACK AND
GIVE US YOUR SHORT **FEEDBACK** ABOUT THIS
LEGO® SET FOR A CHANCE TO WIN
A COOL LEGO PRIZE.



LEGO.com/productfeedback

GEWINNE



Erzähle uns auf
www.LEGO.com/productfeedback

etwas über die Erfahrungen, die du mit
diesem LEGO® Set gemacht hast, und
sichere dir die Chance auf einen coolen
LEGO Preis!

GAGNE



Rends-toi sur
www.LEGO.com/productfeedback

et donne-nous quelques commentaires
sur ce produit LEGO® pour avoir une
chance de gagner un prix LEGO !

GANAN



Visita
www.LEGO.com/productfeedback

y envíanos tu opinión acerca de este set
LEGO®. ¡Participarás en el sorteo de un
premio LEGO!

获取奖品



登录
www.LEGO.com/productfeedback

给出关于此乐高®套装的简短反馈，
就有机会获得炫酷乐高奖品