



MARVEL

# SUPERHEROES



76021



LEGO.com/SuperHeroes

MARVEL  
GUARDIANS  
OF THE GALAXY

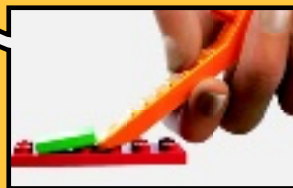
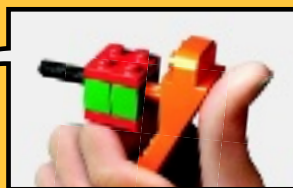

LEGO.com/brickseparator

EN IMPORTANT: Never modify the elements or use other projectiles than provided with this toy.  
 DE WICHTIG: Die Elemente dürfen nicht verändert werden. Es dürfen ausschließlich die mit dem Spielzeug mitgelieferten Geschosse verwendet werden.  
 FR IMPORTANT: Ne jamais modifier les éléments ni utiliser d'autres projectiles que ceux fournis avec ce jouet.  
 IT IMPORTANT: non modificare gli elementi o utilizzare proiettili non forniti con questo prodotto.  
 NL BELANGRIJK! Verander niets aan de elementen en gebruik geen andere projectielen dan de bij het speelgoed geleverde.  
 ES IMPORTANTE: No modifique los elementos ni utilice otros proyectiles diferentes a los suministrados junto con este juguete.  
 DA VIGTIGT: Elementerne må ikke ændres, og der må ikke bruges andre projektiler end dem, der følger med legetøjet.  
 FI TÄRKEÄÄ: Älä koskaan tee osiin muutoksia tai käytä lelussa muita kuin sen sisältämiä ammuksia.  
 SV VIKTIGT: Modifiera aldrig delarna och använd aldrig andra projektiler än de som medföljer denna leksak.  
 PT IMPORTANTE: Nunca modifique os elementos nem utilize projectéis que não tenham sido fornecidos com este brinquedo.  
 EL ΣΗΜΑΝΤΙΚΟ: Ποτέ μην τροποποιείτε τα στοιχεία του παιχνιδιού και μην χρησιμοποιείτε άλλα βλήματα εκτός από αυτά που συνοδεύουν αυτό το παιχνίδι.  
 JA 重要：部品を改造したり、本製品に付属の発射体以外のものを使用しないでください。  
 ZH 重要提示：切勿更改组件或使用并非由本玩具附带的弹丸。  
 KO 중요함: 이들 부품을 수정하거나 이 완구와 함께 제공된 것이 아닌 발사체는 결코 사용하지 마십시오.  
 RU ВАЖНО: запрещается вносить изменения в элементы или использовать другие снаряды, отличные от тех, которые поставляются с данной игрушкой.  
 PL WAŻNE: Nigdy nie modyfikować elementów zabawki ani nie używać pocisków innych niż dostarczone z zabawką.  
 CZ UPOZORNĚNÍ: Nikdy neupravujte součástky a nepoužívejte jiné projektily než ty, které jsou dodávány s touto hračkou.  
 SK UPOZORNENIE: Nikdy neupravujte súčiastky a nepoužívajte iné projektily než tie, ktoré sú dodávané s touto hračkou.  
 HU FONTOS: Az elemeket nem szabad módosítani, és a játékhöz adott lövedékek helyett sem szabad mászt használni.  
 UA ВАЖЛИВО: забороняється вносити зміни до елементів або використовувати інші снаряди на відміну від тих, що поставляються з цією іграшкою.  
 HR VAŽNO: Nemojte nikad mijenjati elemente ili koristiti druge projektile osim onih koji su bili priloženi uz ovu igračku prilikom kupnje.  
 SR Важно: Немојте да модификујете елементе и не користите друге пројектиле осим оних који долазе уз ову играчку.  
 SL POMEMBNO: Nikoli ne spreminjajte elementov in uporabljajte le izstrelke, ki so bili priloženi tej igrači.  
 RO IMPORTANT: Nu modificați niciodată elementele și nu utilizați alte proiectile decât cele furnizate cu această jucărie.  
 BG ВАЖНО: Не видоизменяйте елементите и не използвайте други снаряди освен приложените към тази играчка.  
 LV SVARĪGĪ! Nekad nepārveidojiet rotālietas elementus, vienmēr izmantojiet tikai tās komplektā iekļautās lodītes.  
 ET OLULINE: Mänguasja osi ei tohi teistega asendada, kasutada võib ainult kaasasolevat heitkeha.  
 LT DĖMESIO! Niekuomet nekeiskite elementų ir naudokite tik tuos šovinius, kurie yra pridėti prie šio žaislo.  
 TR ÖNEMLİ: Hiçbir zaman parçalarda değişiklik yapmayın veya bu oyuncakla sağlananlar dışında mermiler kullanmayın.

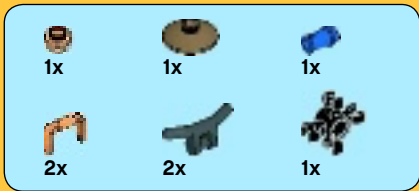
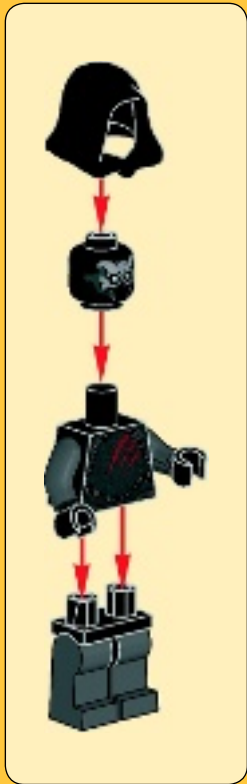
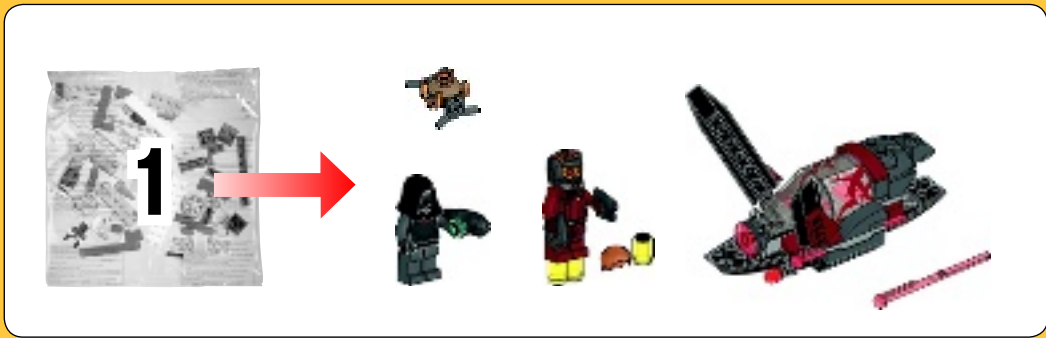



1

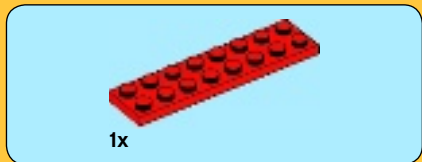

2

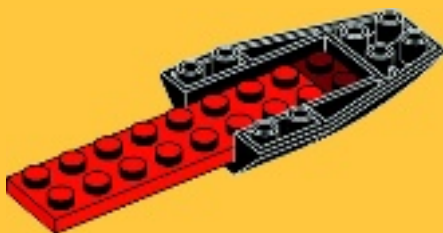

3



4





5



6



7



8

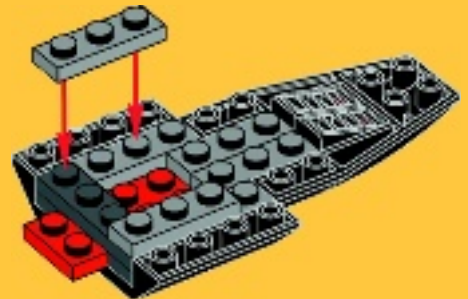



1x

# 9



2x

# 10



2x



2x

# 11



2x

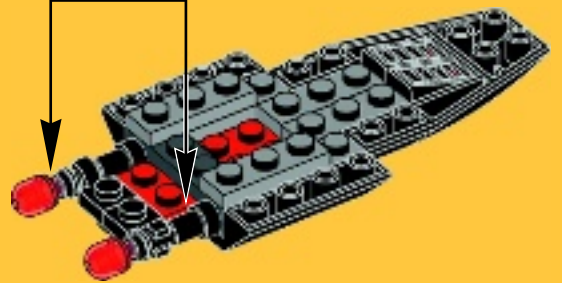

1x

# 12





# 13

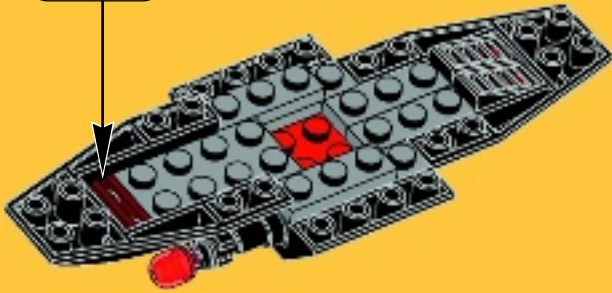

# 15

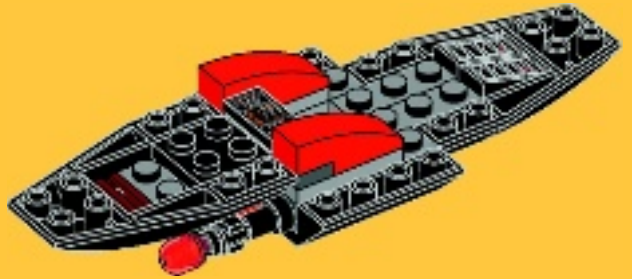

# 14

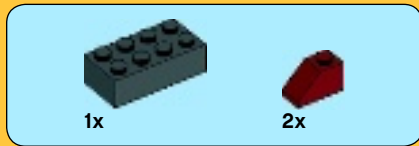
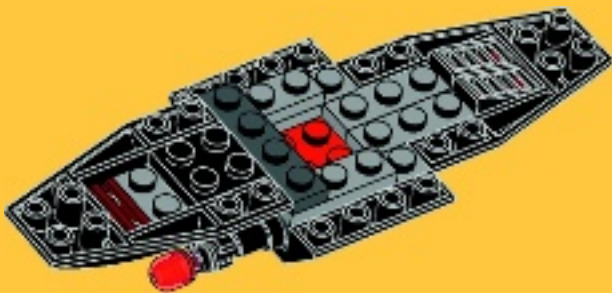

# 16

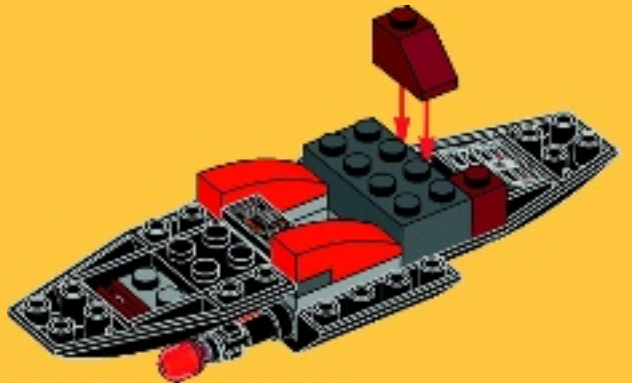



2x



# 17

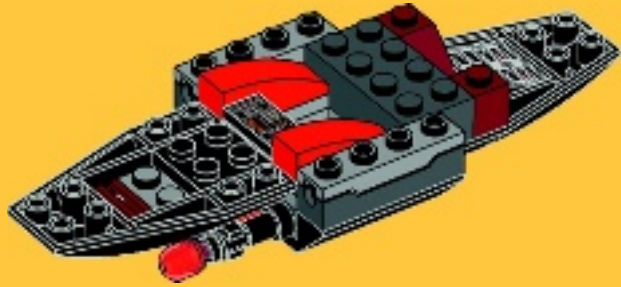

2x



1x

# 19

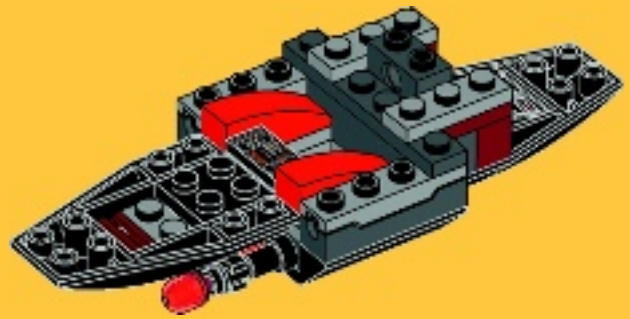

1x



2x

# 18

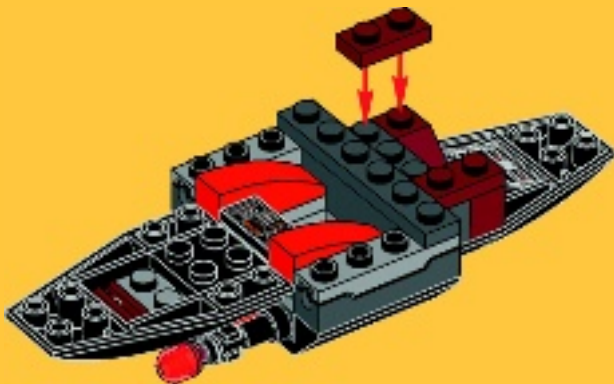

2x



1x

# 20

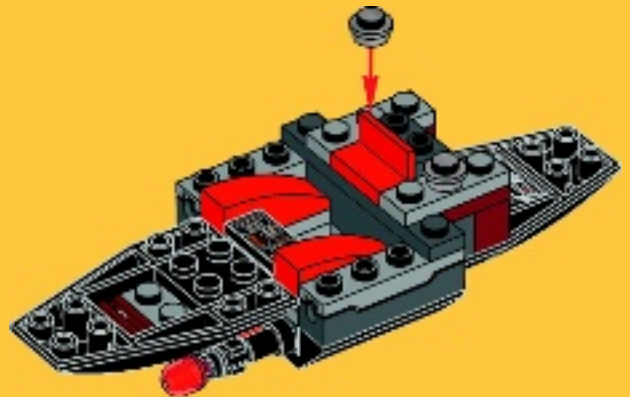



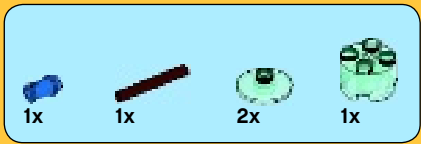

# 21

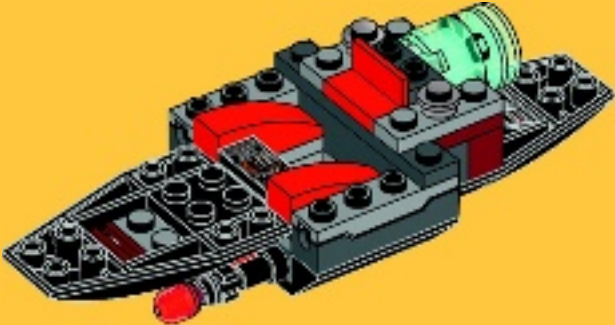
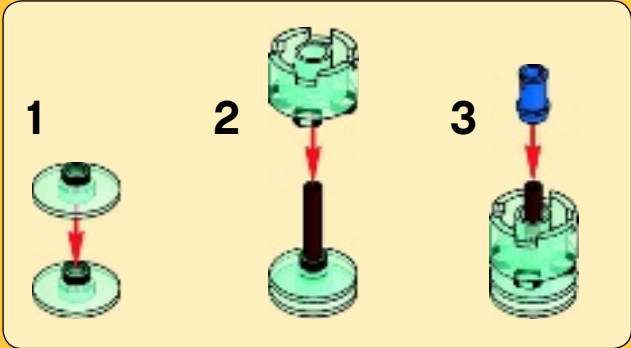

# 22

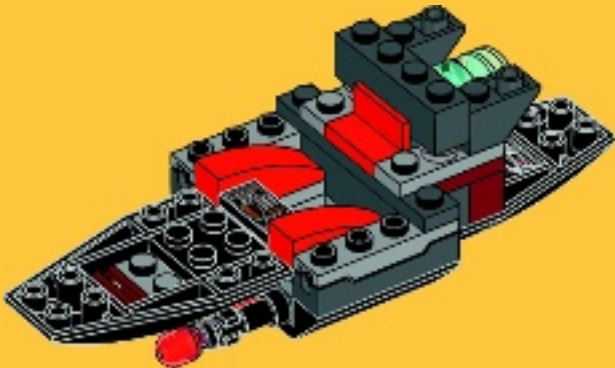



1x

# 23

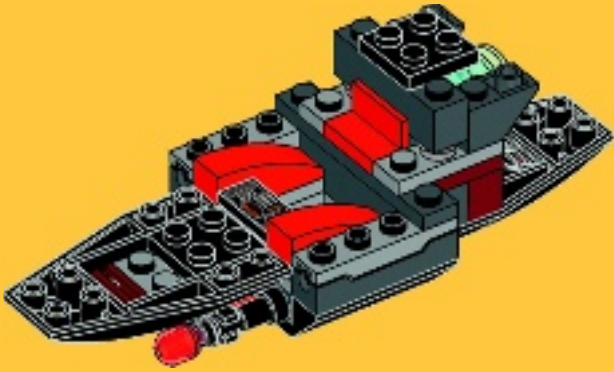

1x

# 24

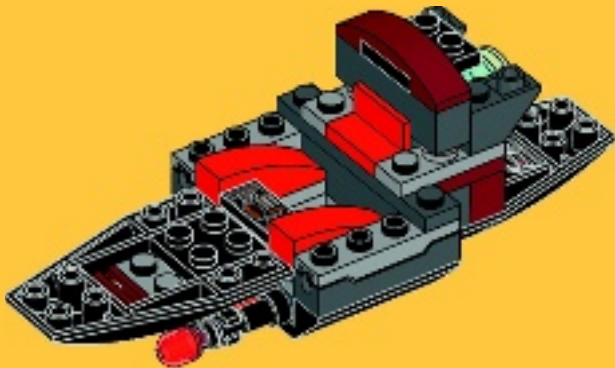

1x

# 25

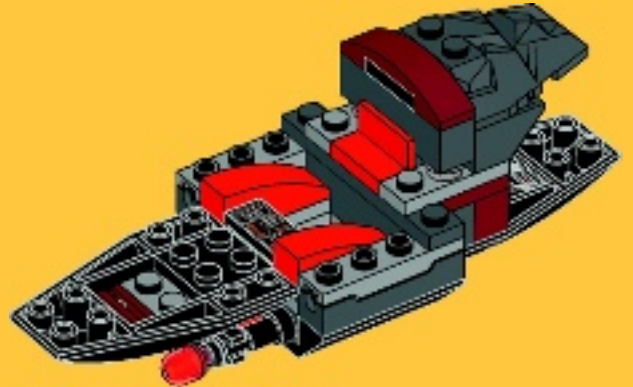



2x

# 26

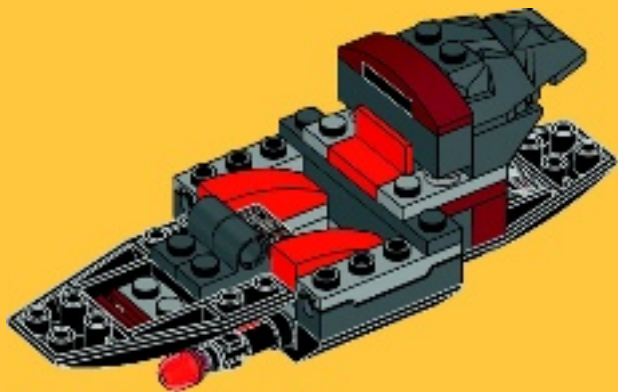

2x



1x

# 27

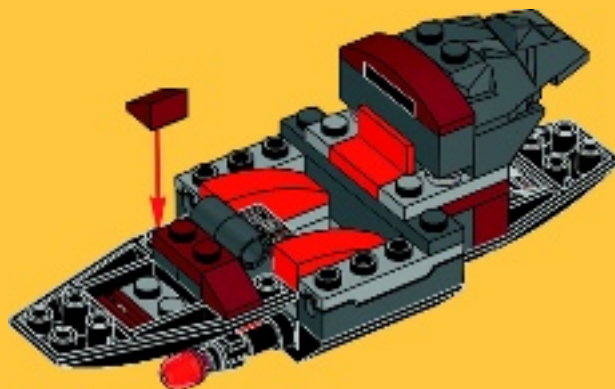

2x



2x

# 28

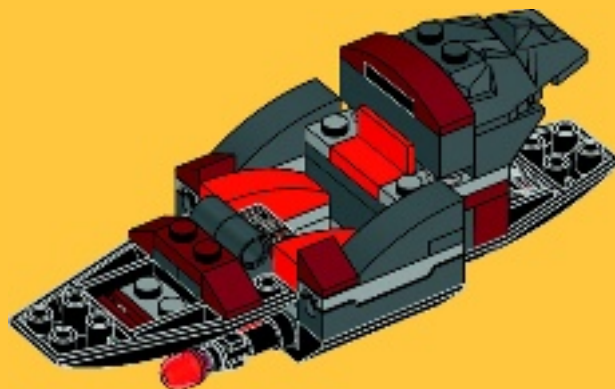



1x

# 29

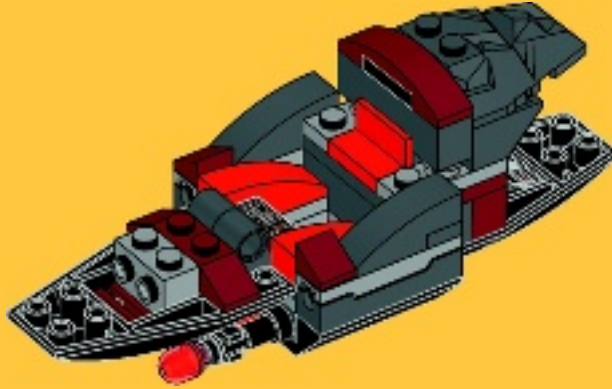

2x



2x

# 30

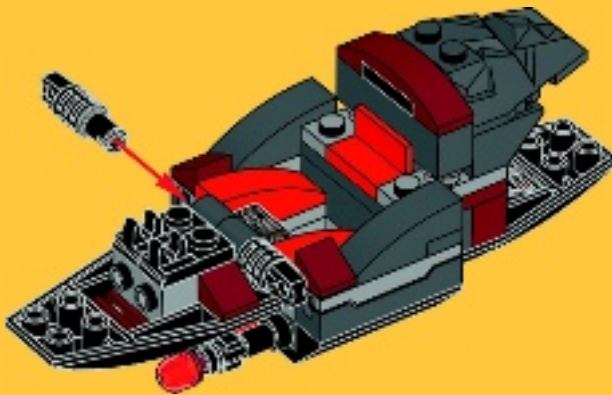

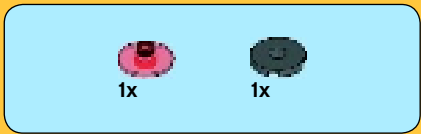

31

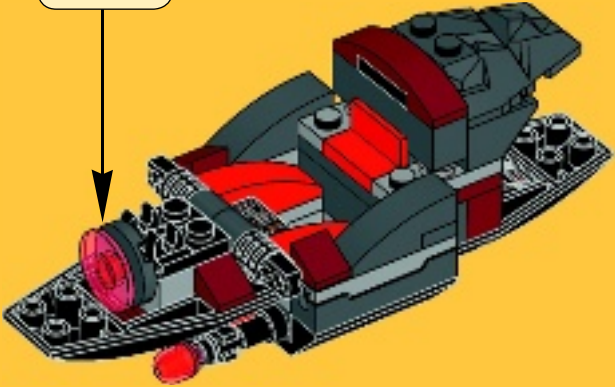

32

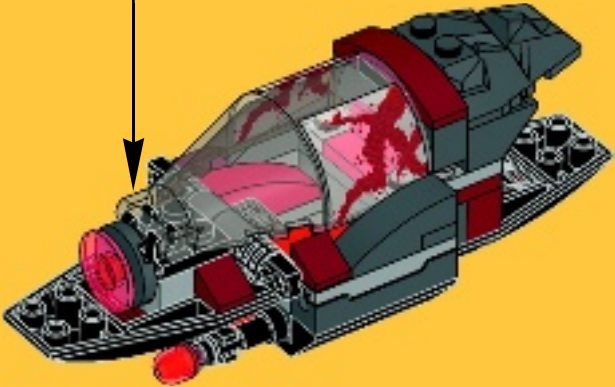
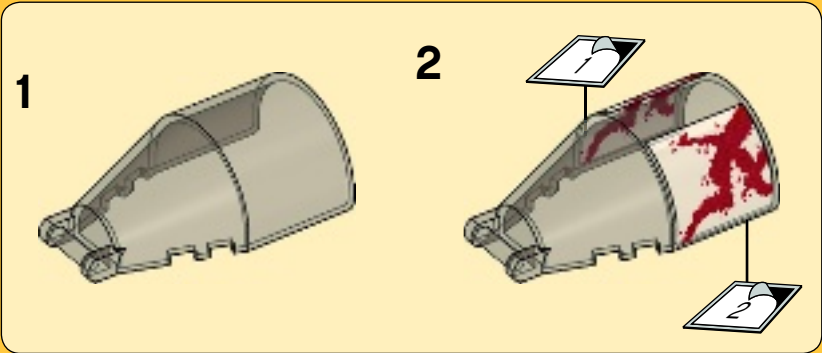



33

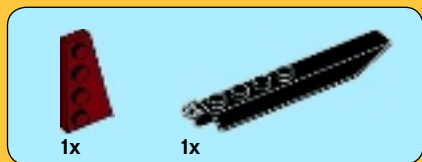
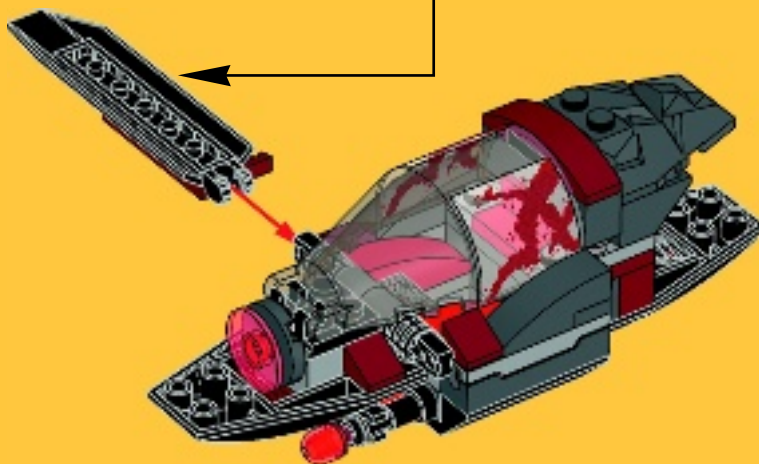
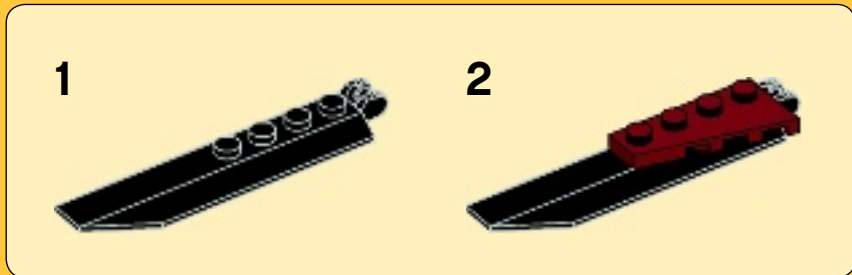

34

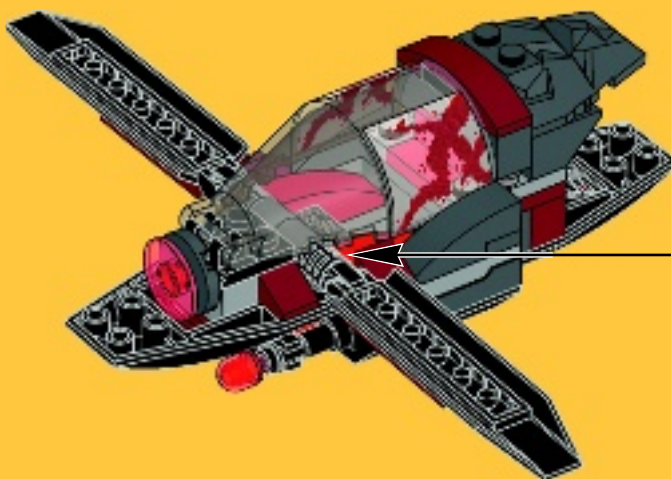
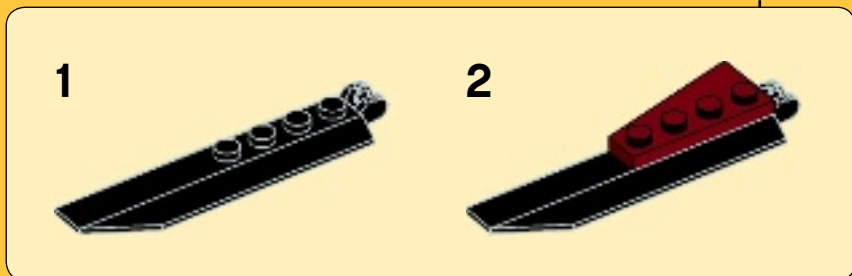

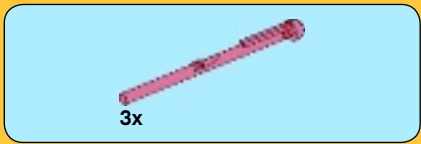

35

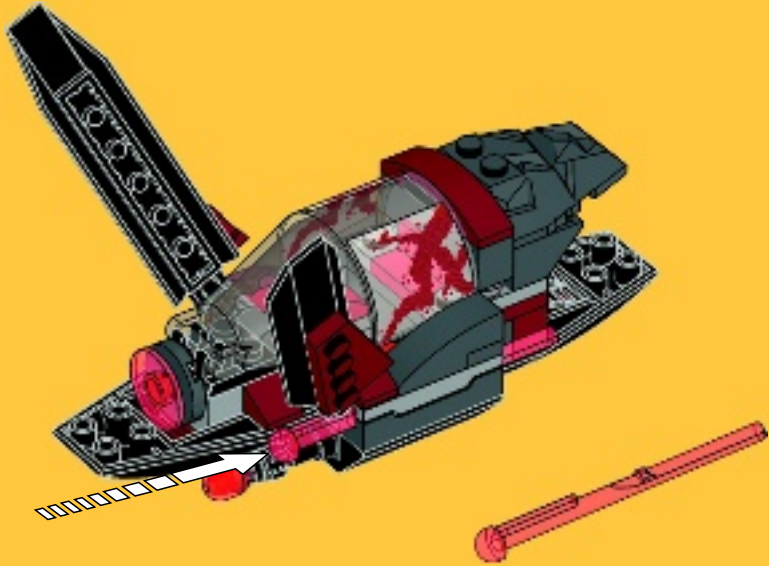

36

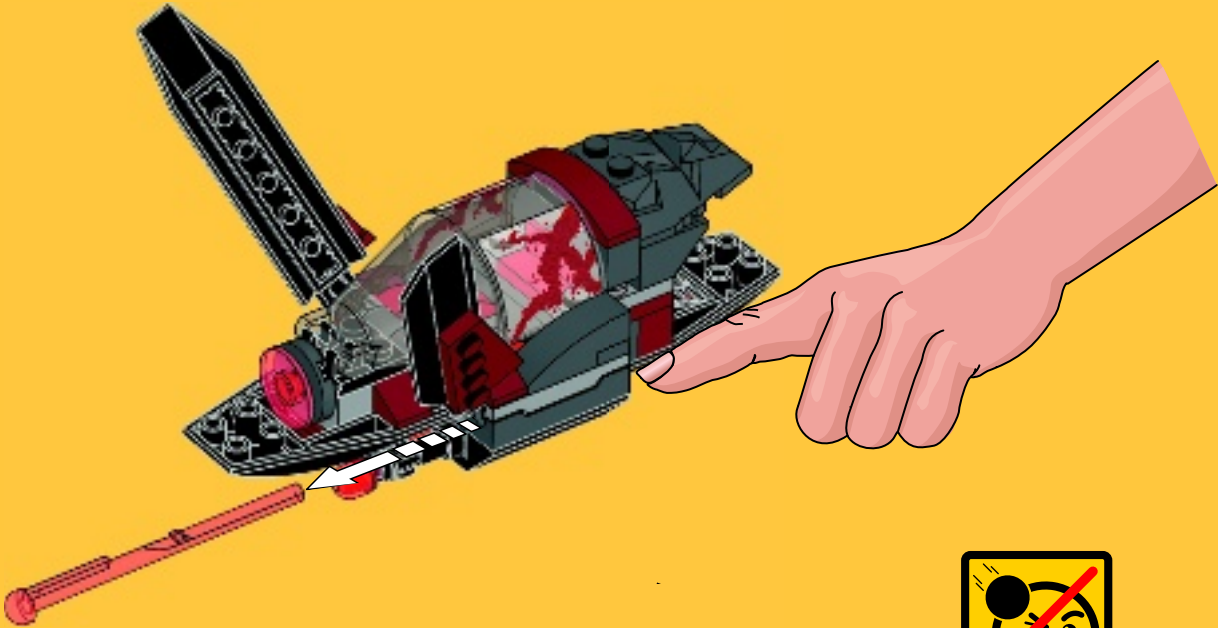

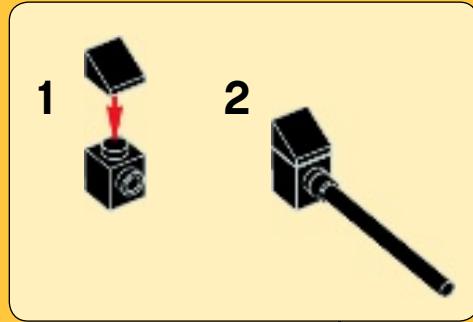
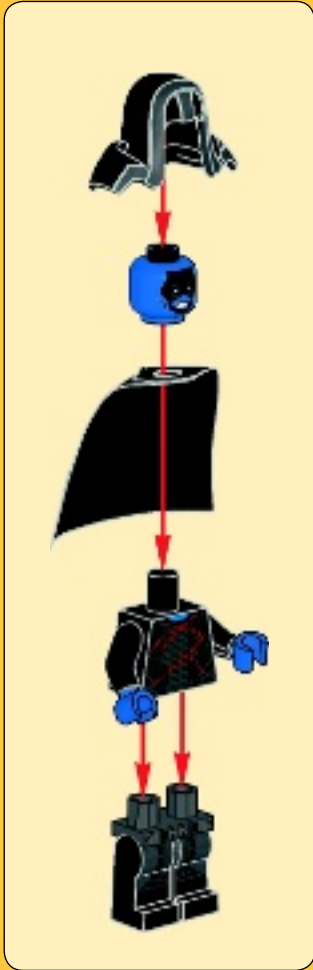
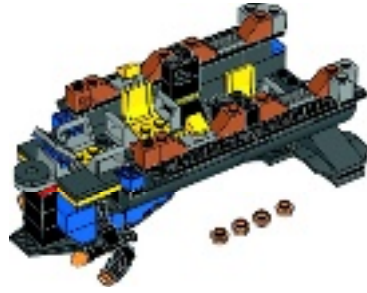



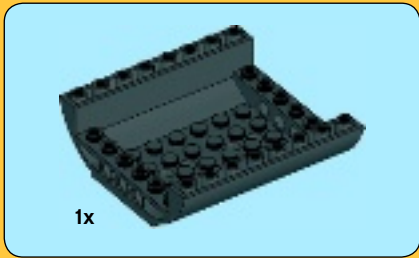

1

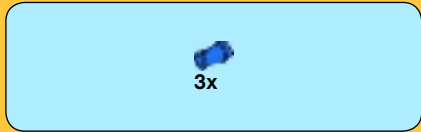
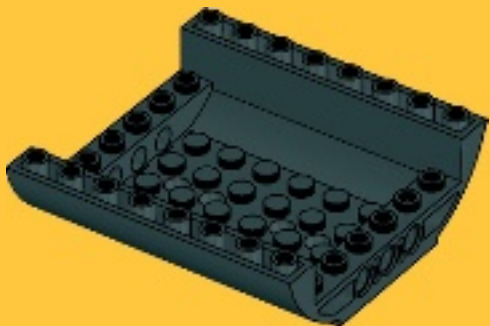

2



3

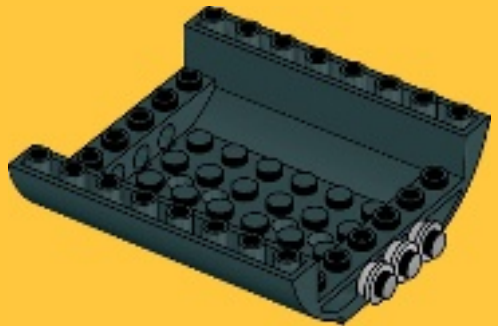



1x



2x

# 4



1x



2x

# 5

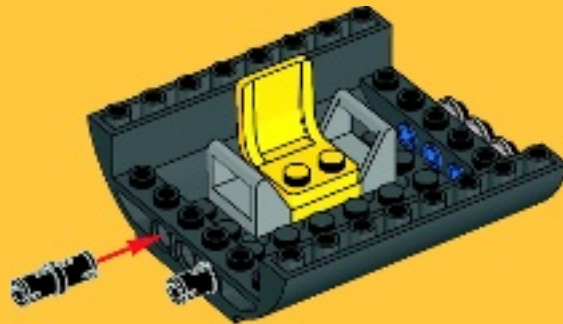

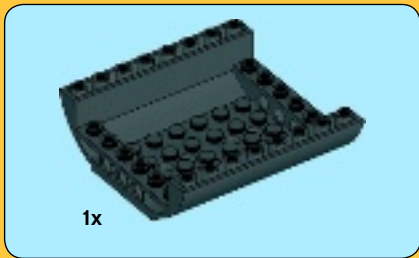

6

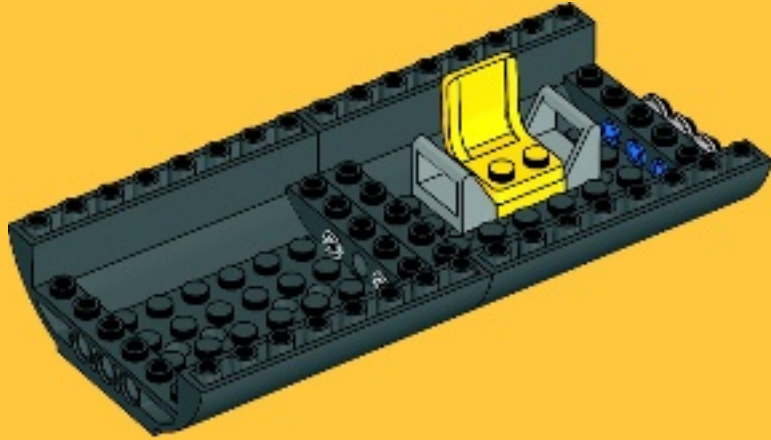

7

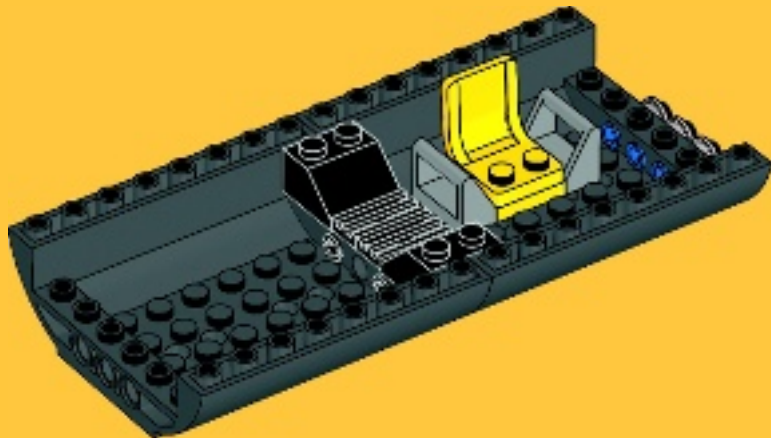



4x

8

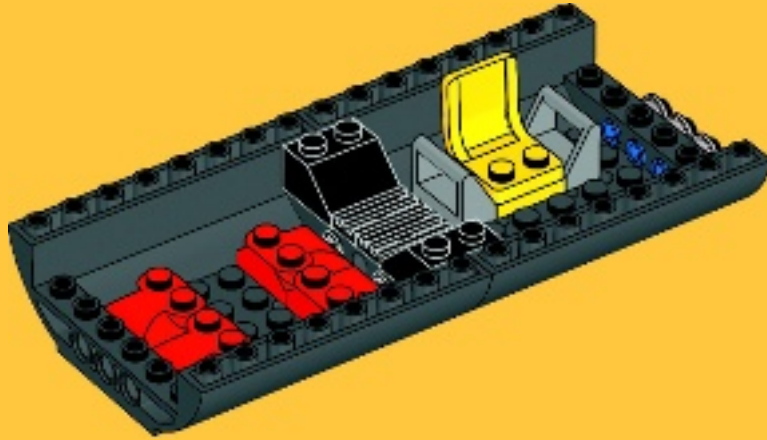

1x



2x

9

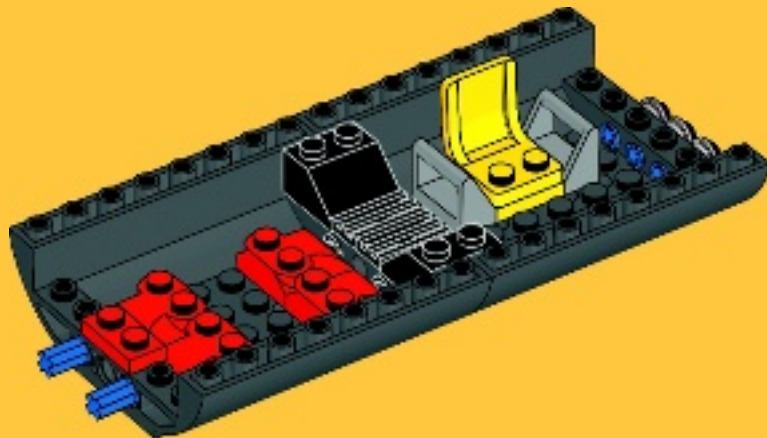

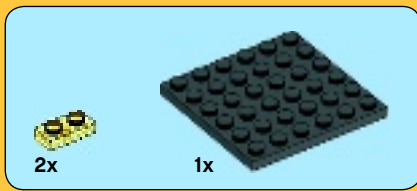

10

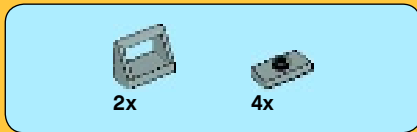
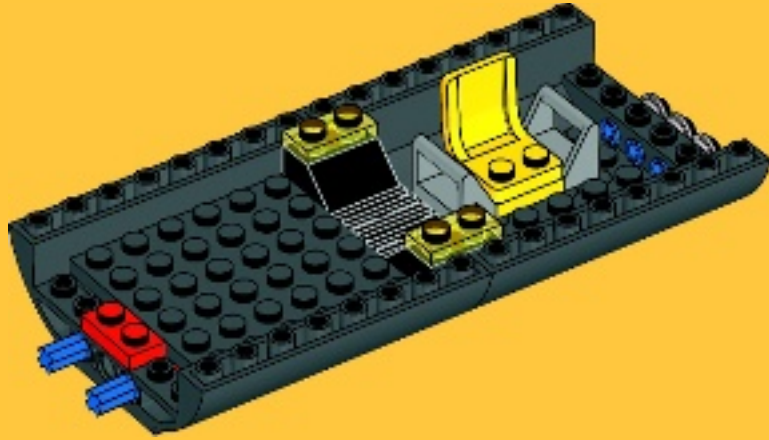

11

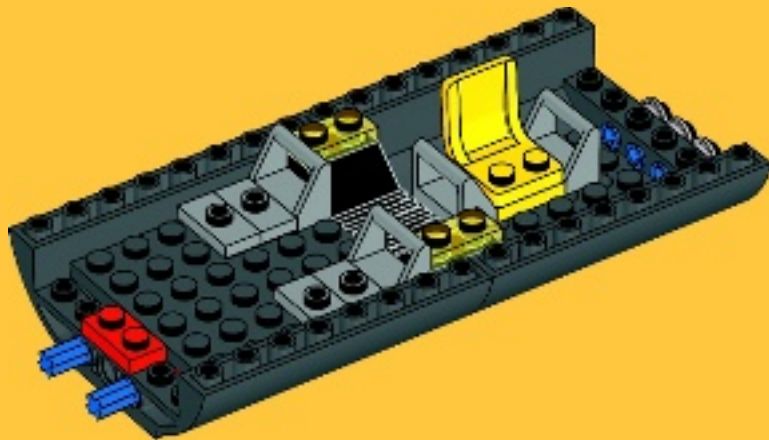



1x



2x

# 12

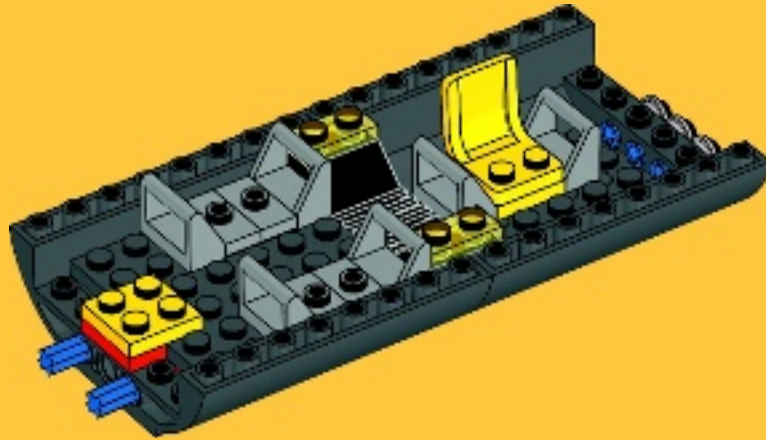

2x



1x

# 13

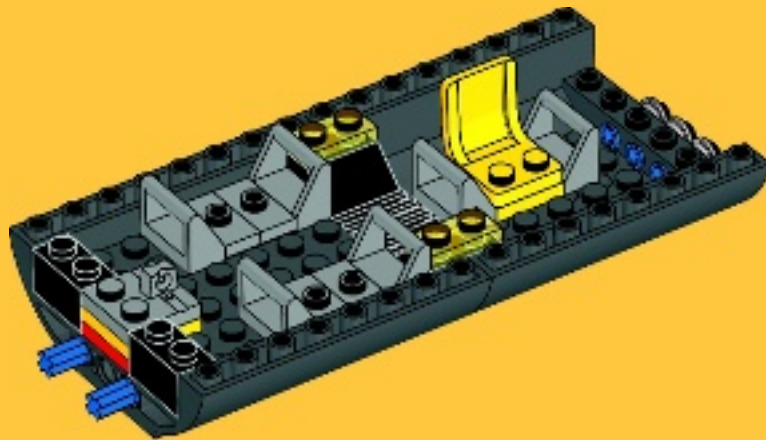



2x

# 14

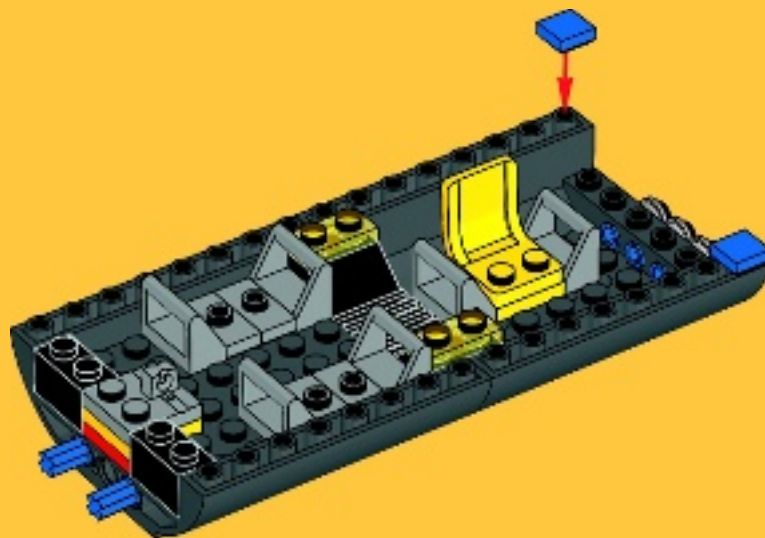

2x



1x

# 15

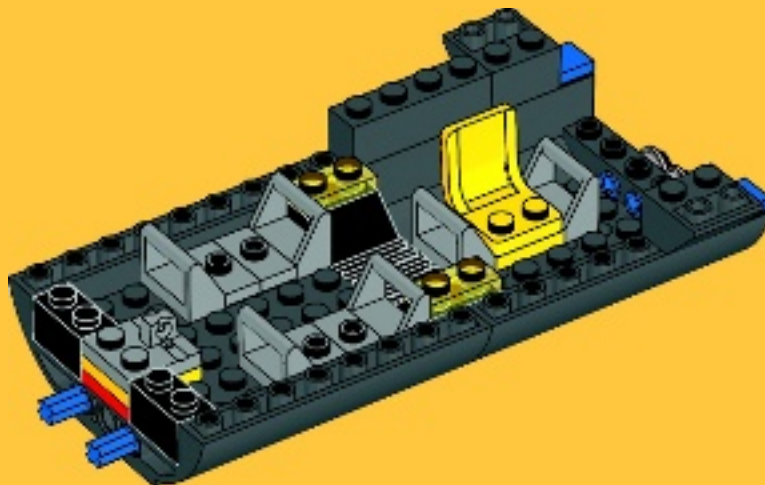



1x

# 16

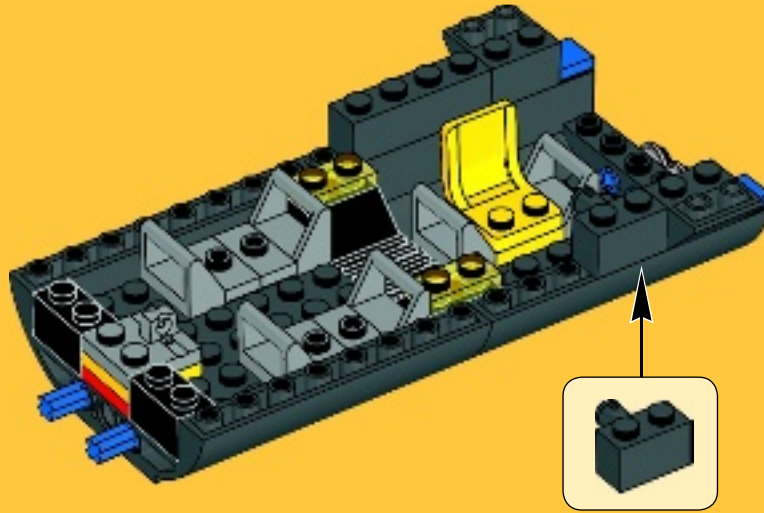

4x



1x



2x

# 17

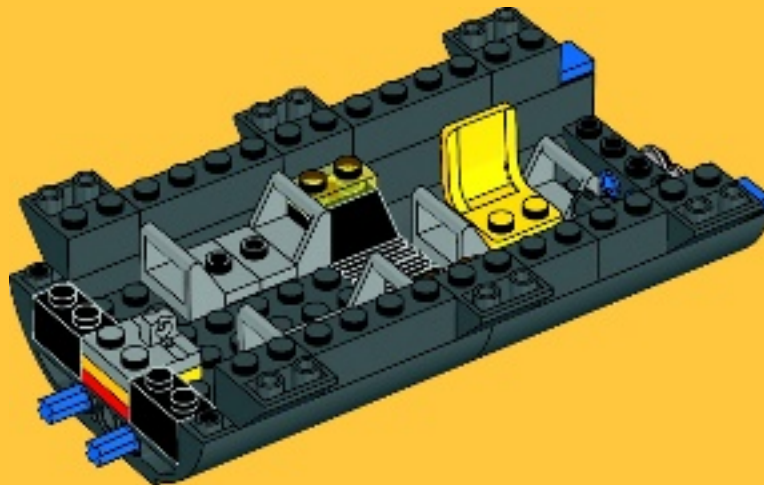





2x

# 18

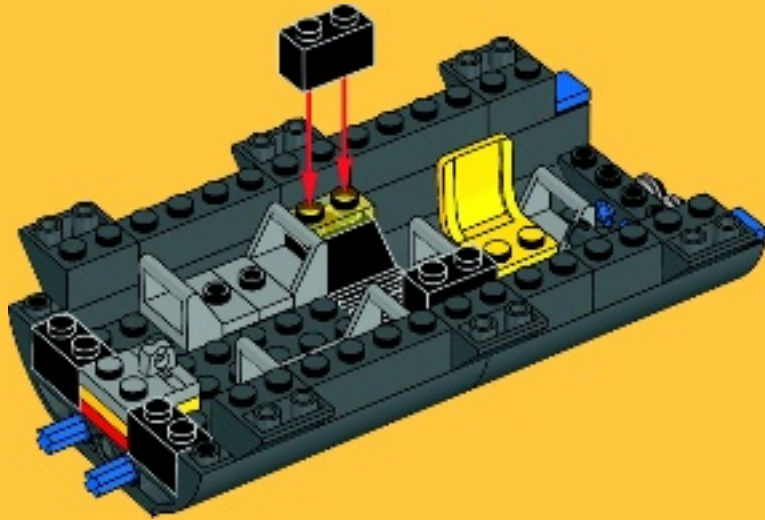

2x

# 19



2x

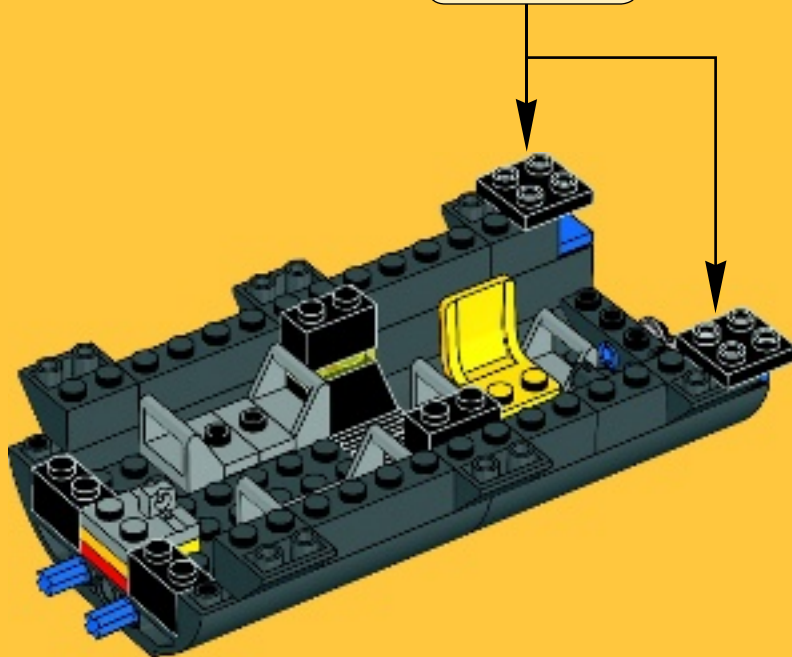



4x

# 20

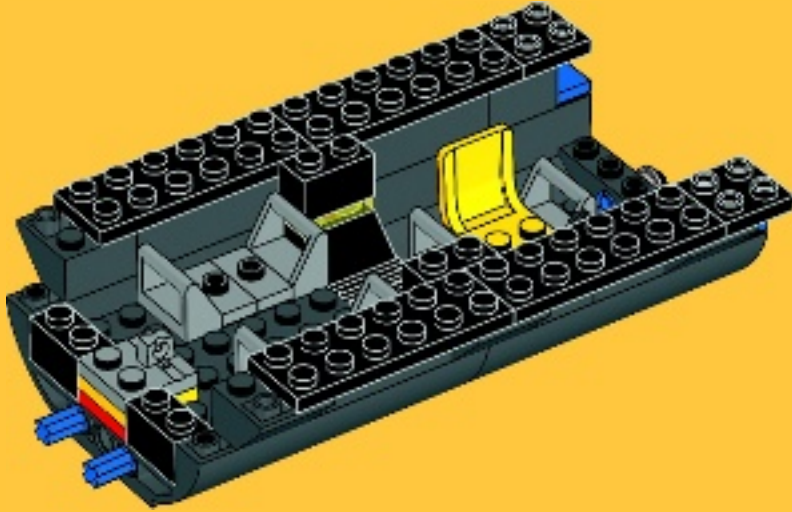

2x

# 21

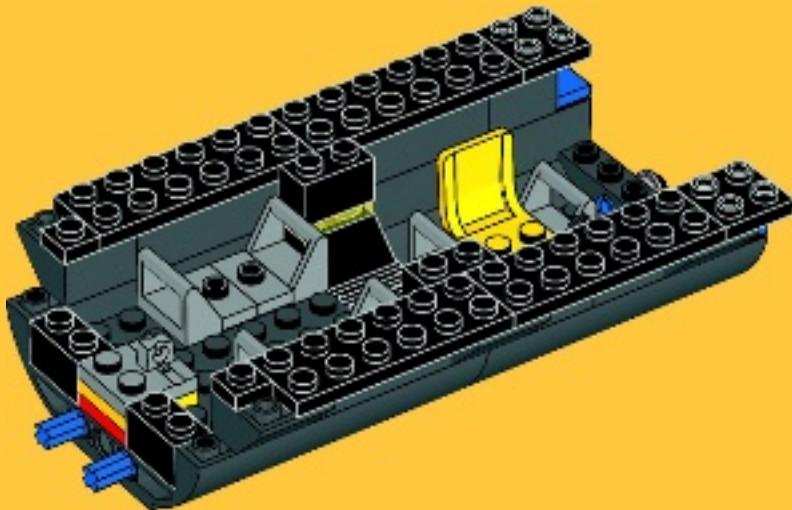

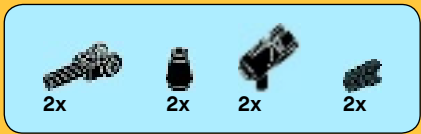

# 22

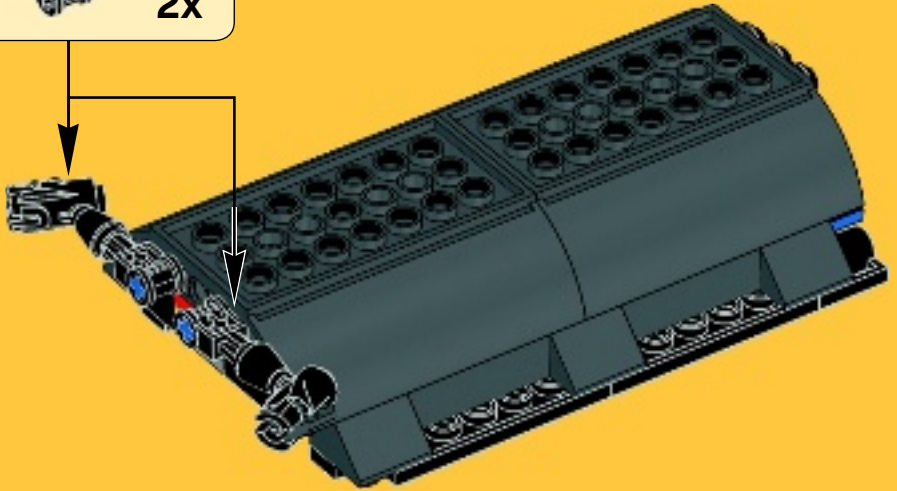
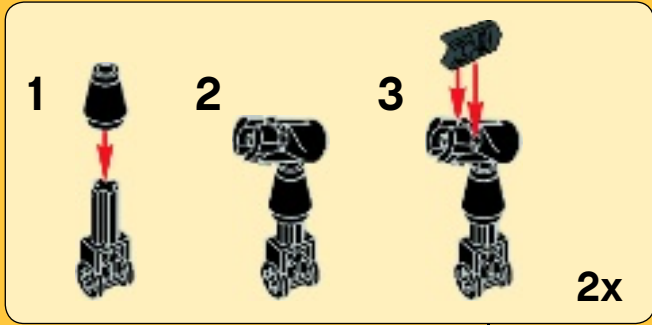

# 23

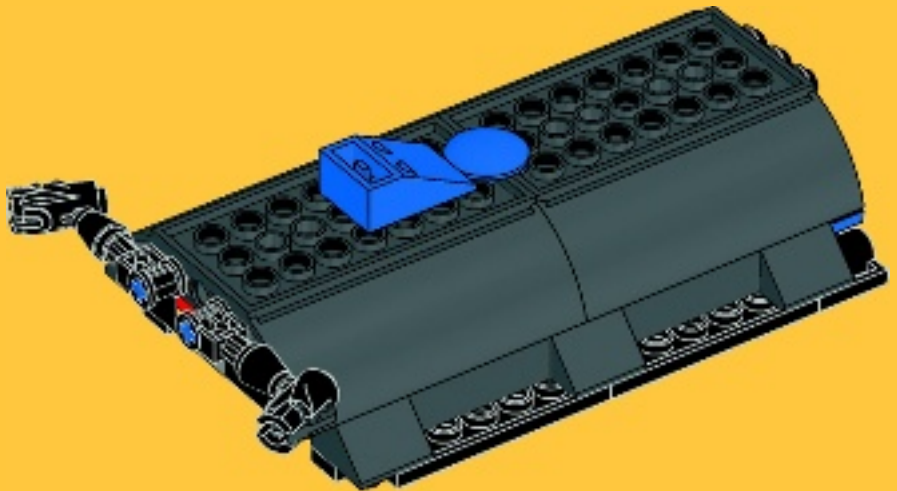





1x

7



2x

8

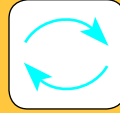

24

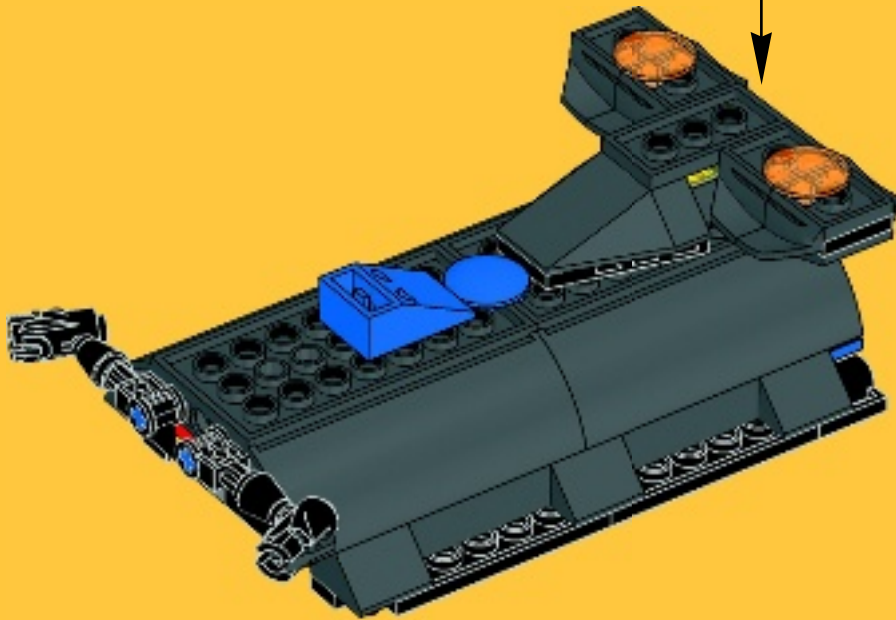



1x

1



2x

2



1x

3



2x

4





5



6

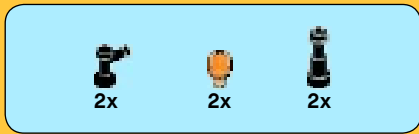

7

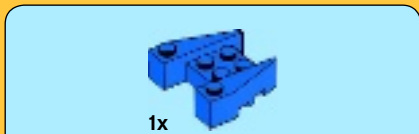
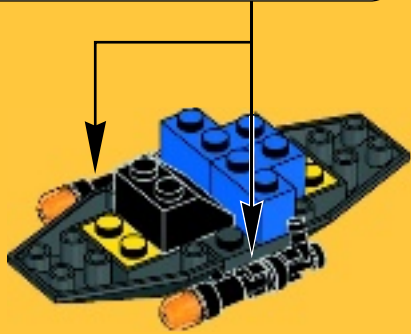

8





9

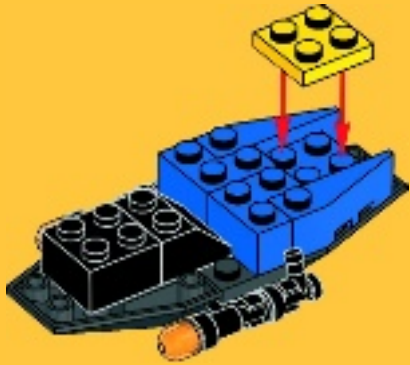

11



10

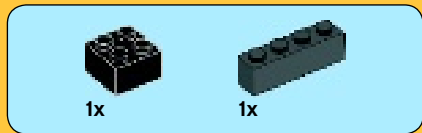

12







2x

13



25

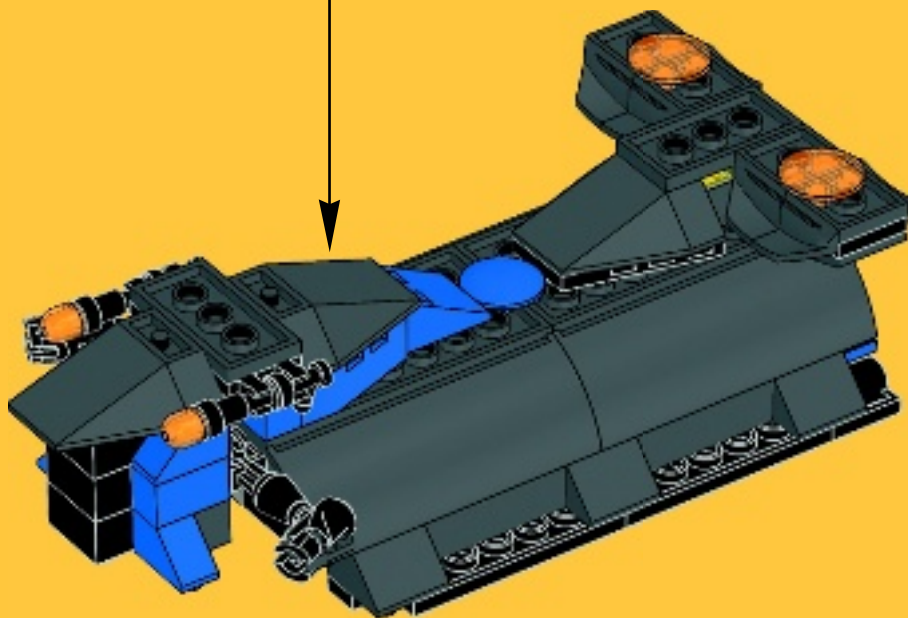



2x

# 26

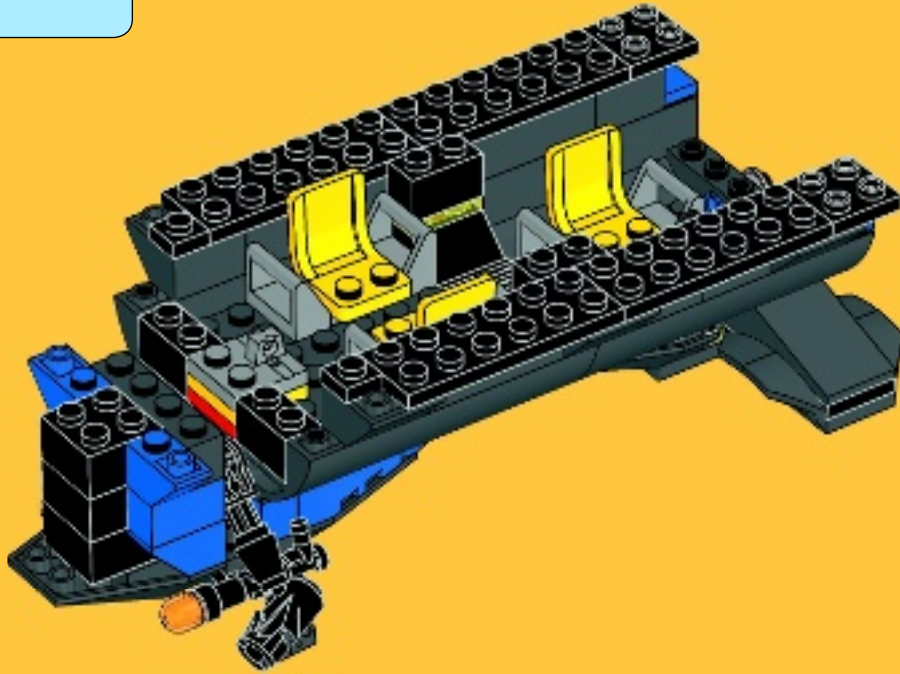

1x



2x



1x

# 27

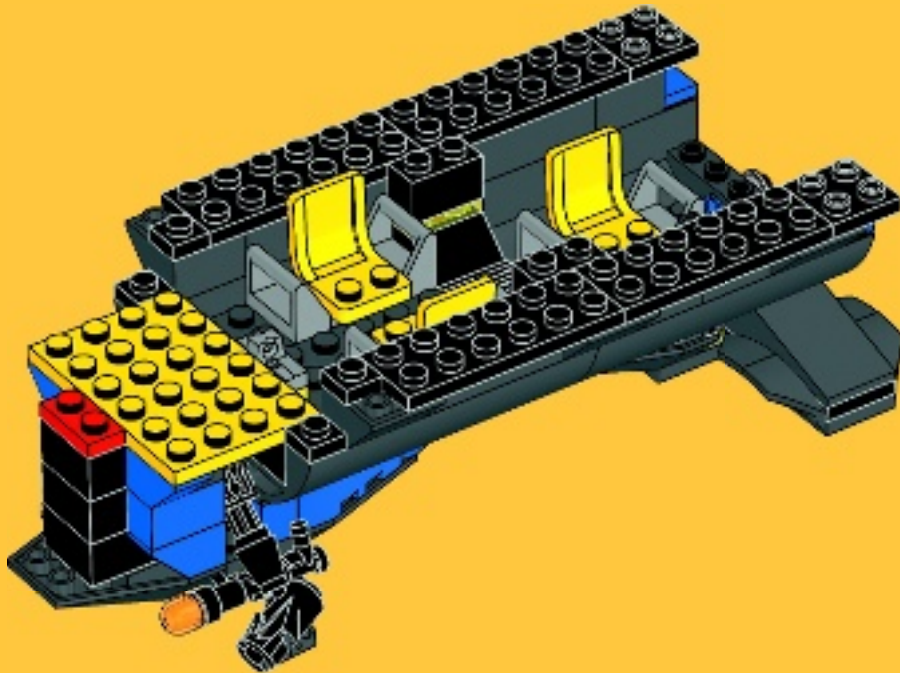

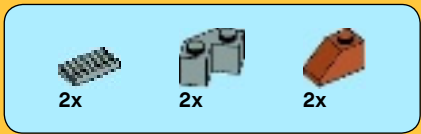

# 28

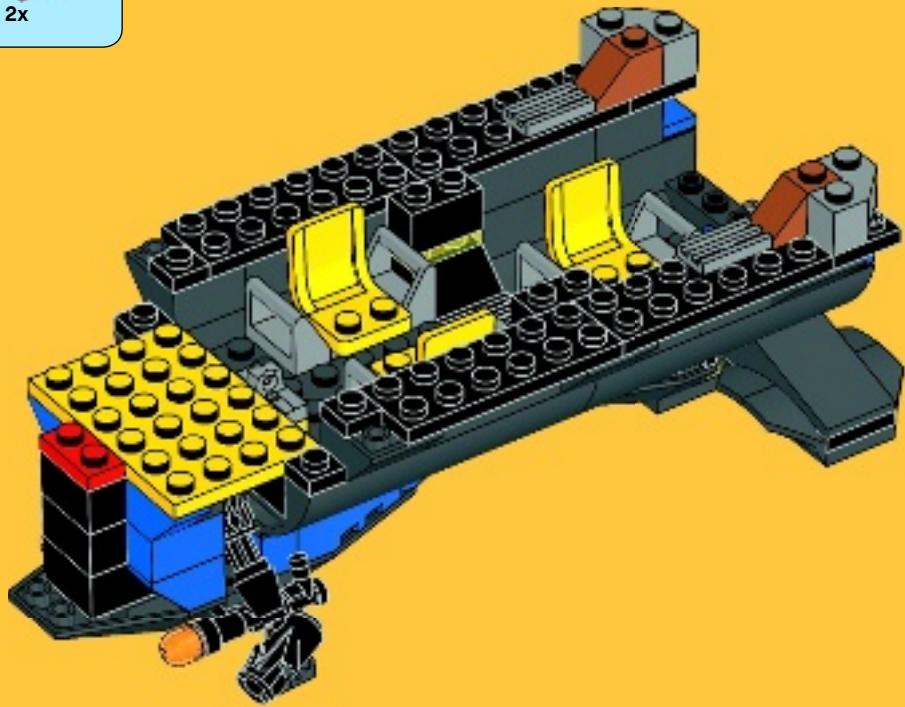

# 29

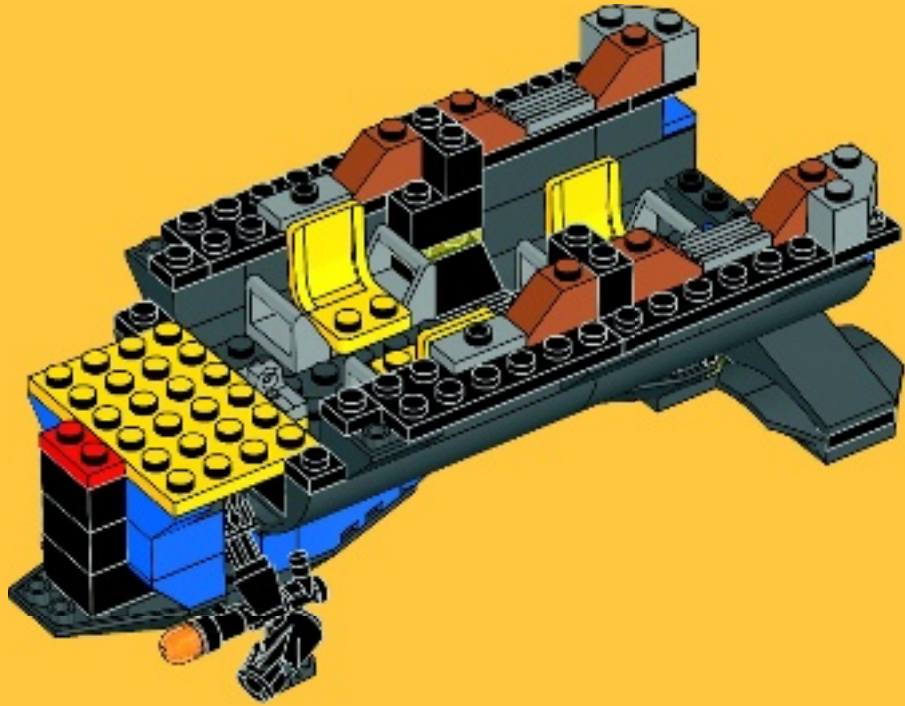



2x



2x

# 30

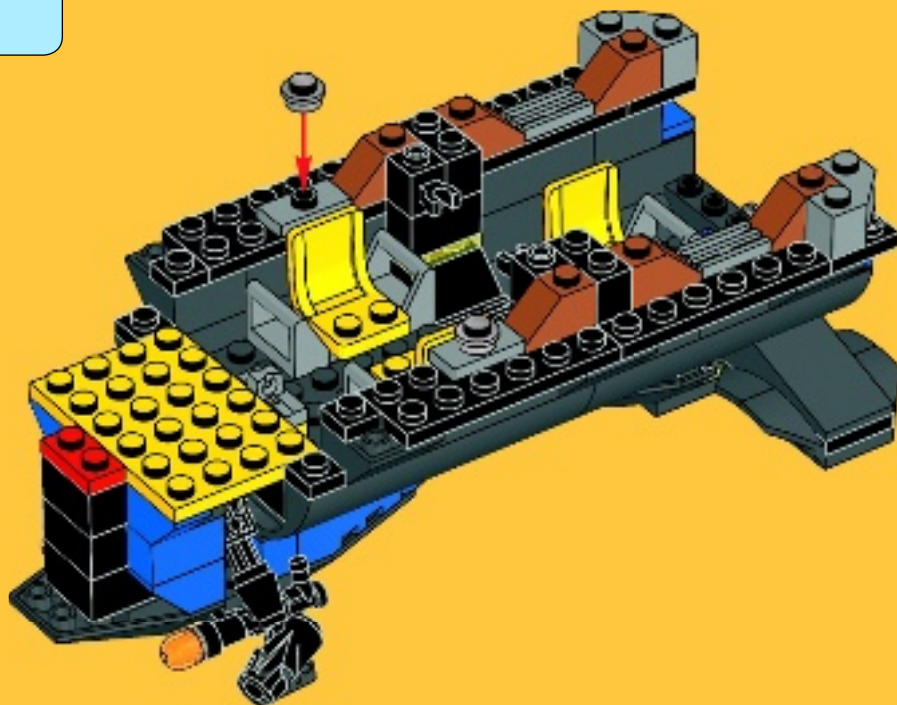

2x



2x



2x

# 31

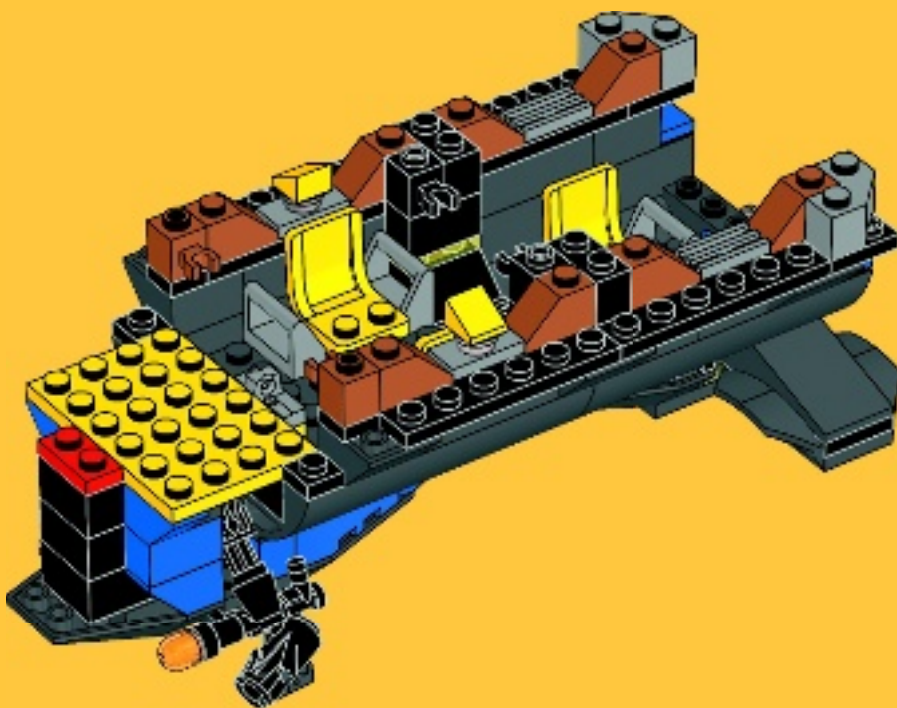

2x



2x

# 32

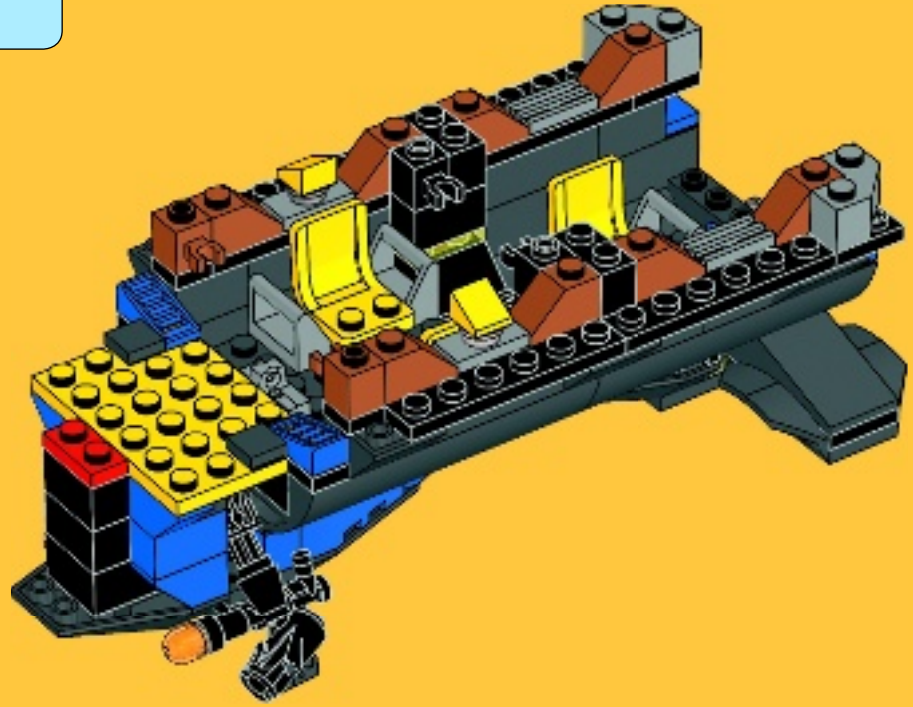

2x



1x



2x

# 33

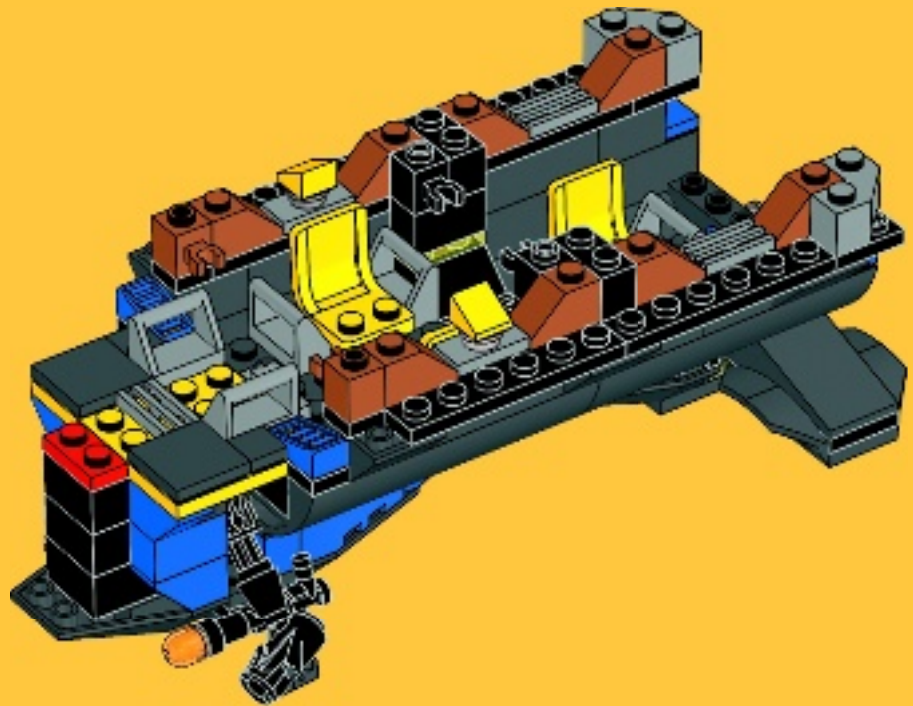

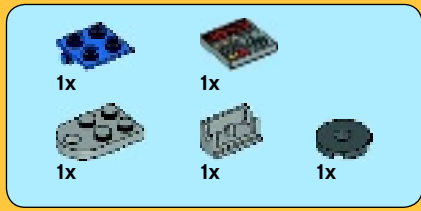

# 34

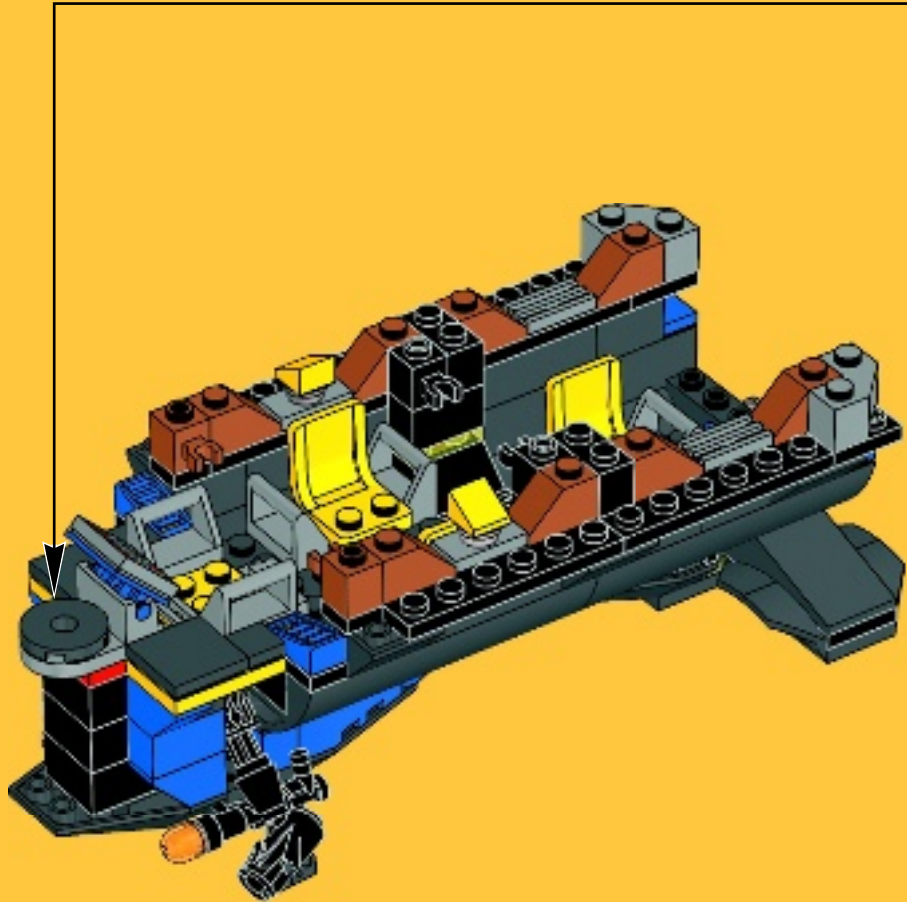



6x

# 35

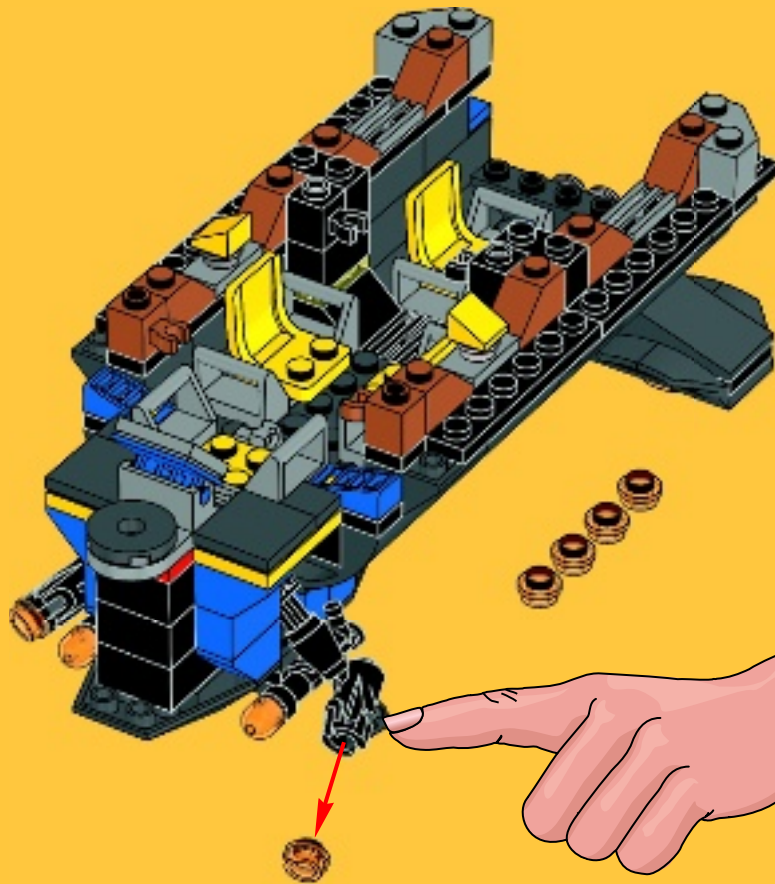
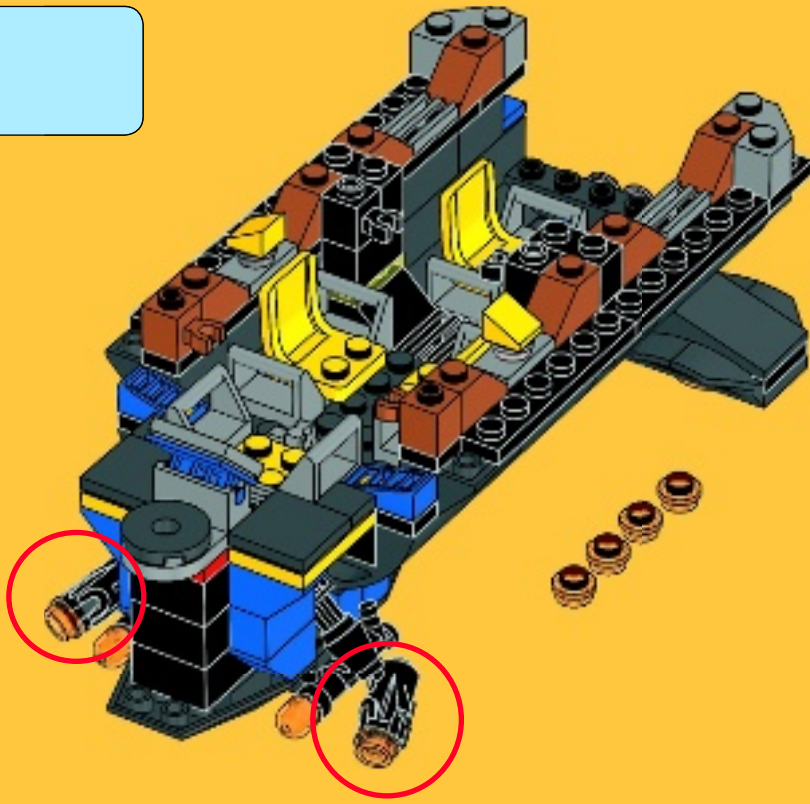

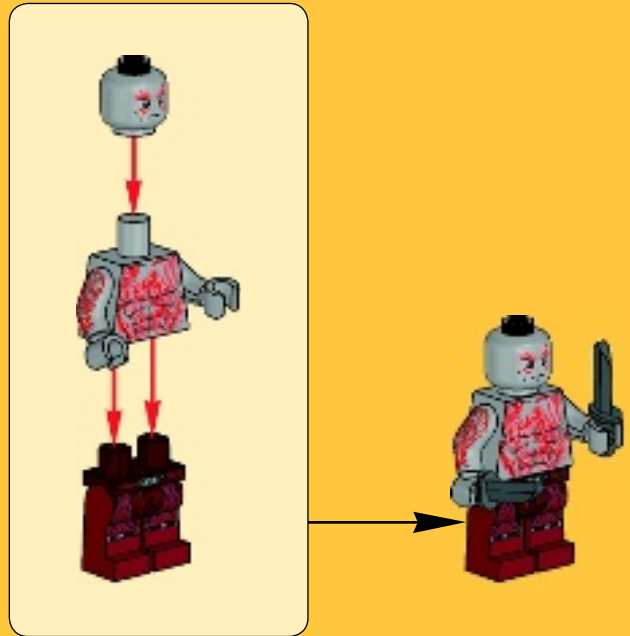

36

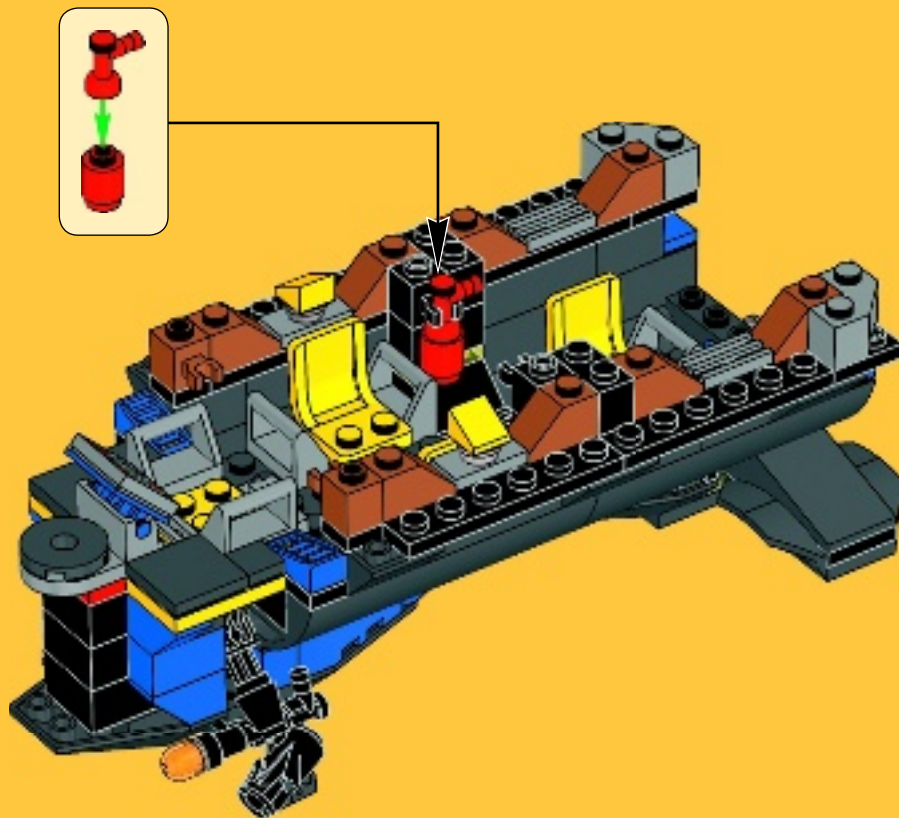





# 37

1



2



3



4



5

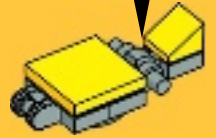

6

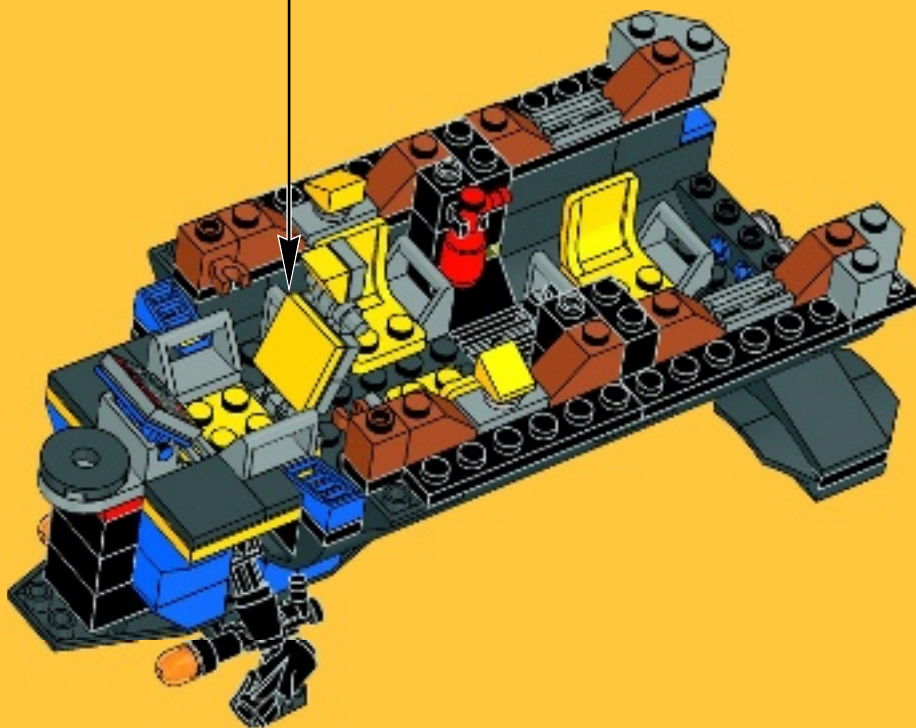
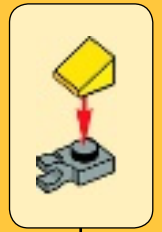

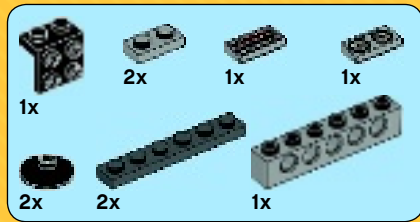

**38**

**1**



**2**



**3**

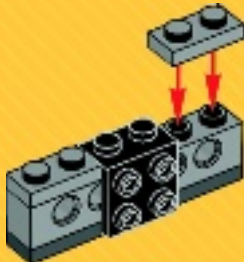

**4**



**5**



**6**

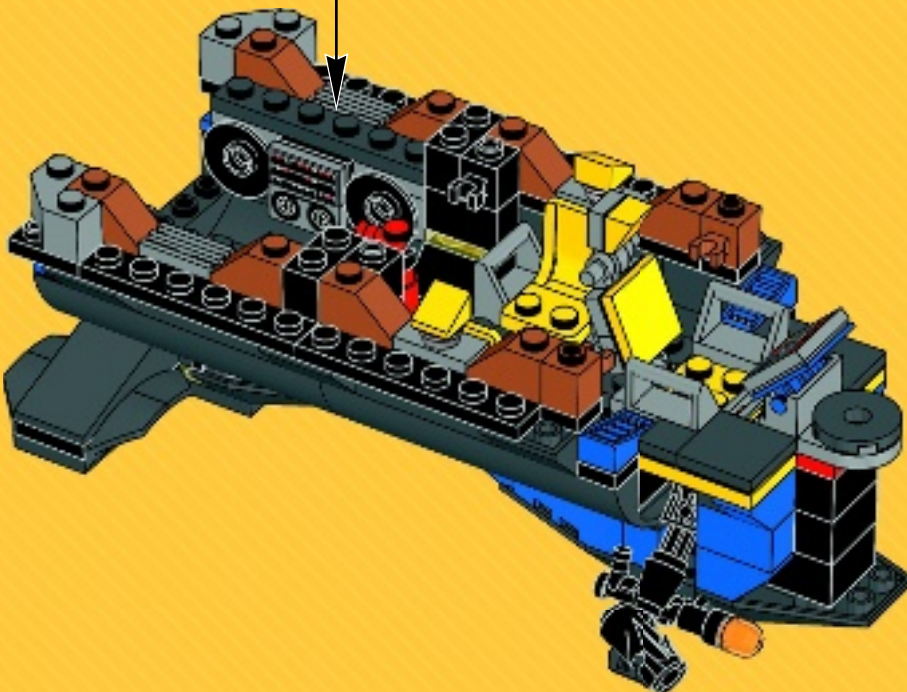

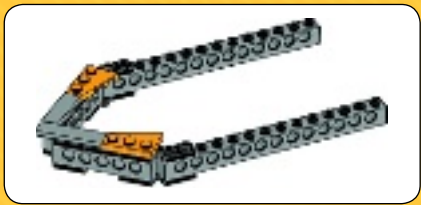

1

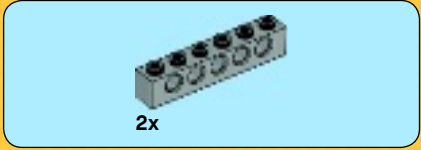

2

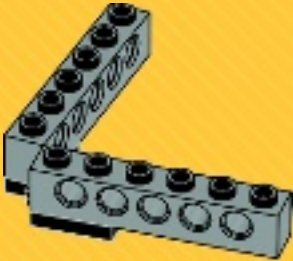

3



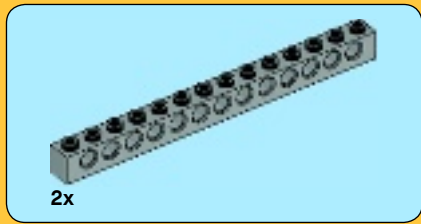

4

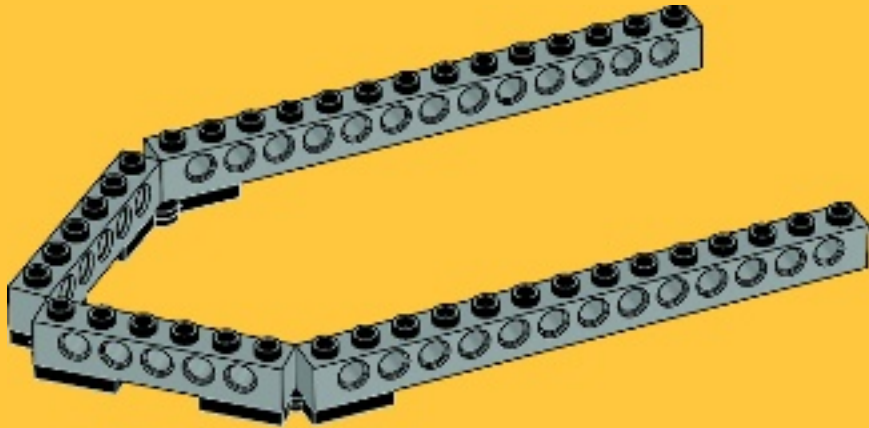

5

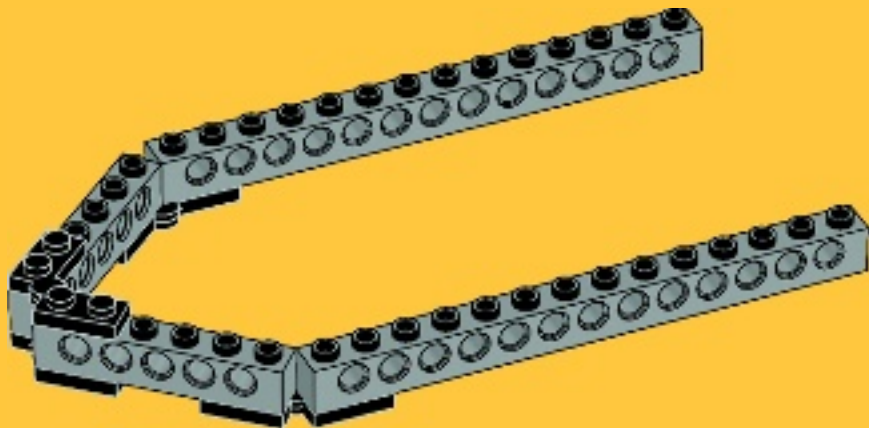



6

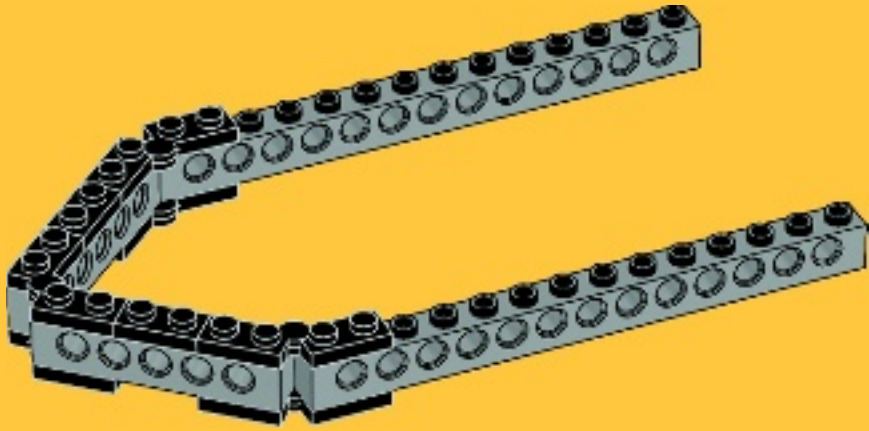

7

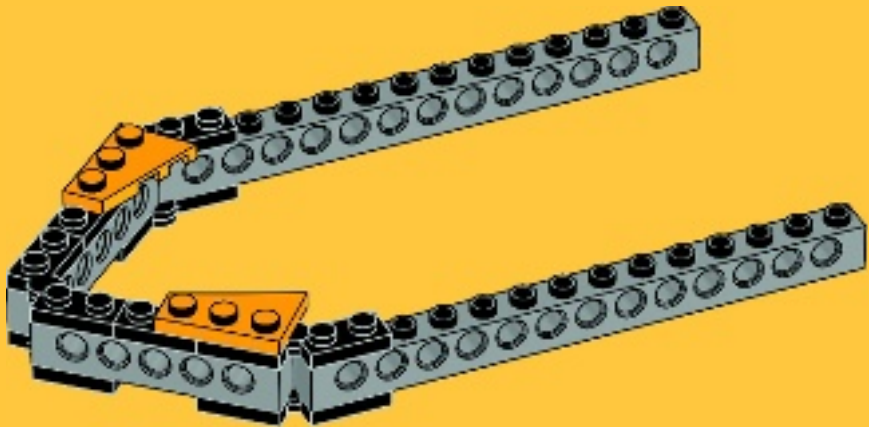



8

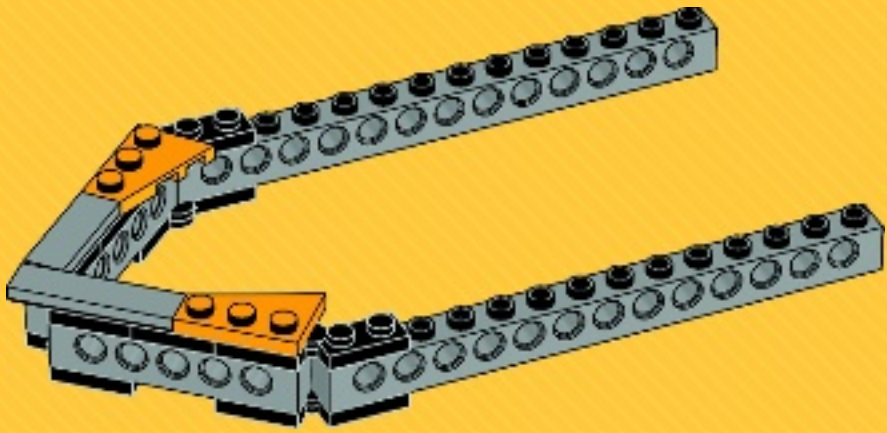

39

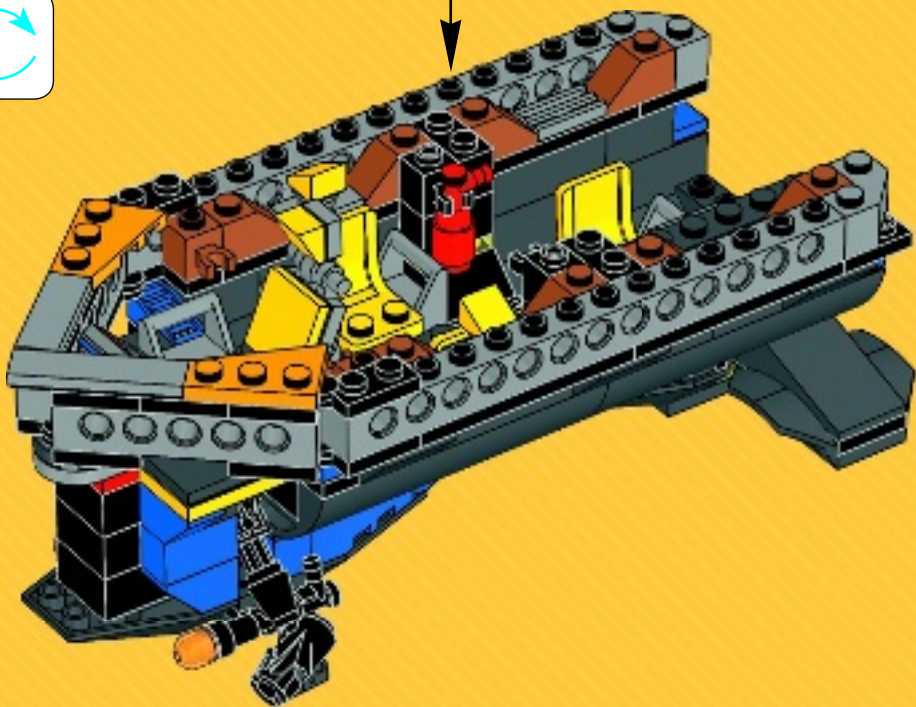

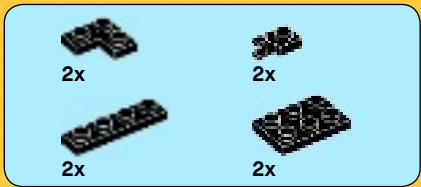

40

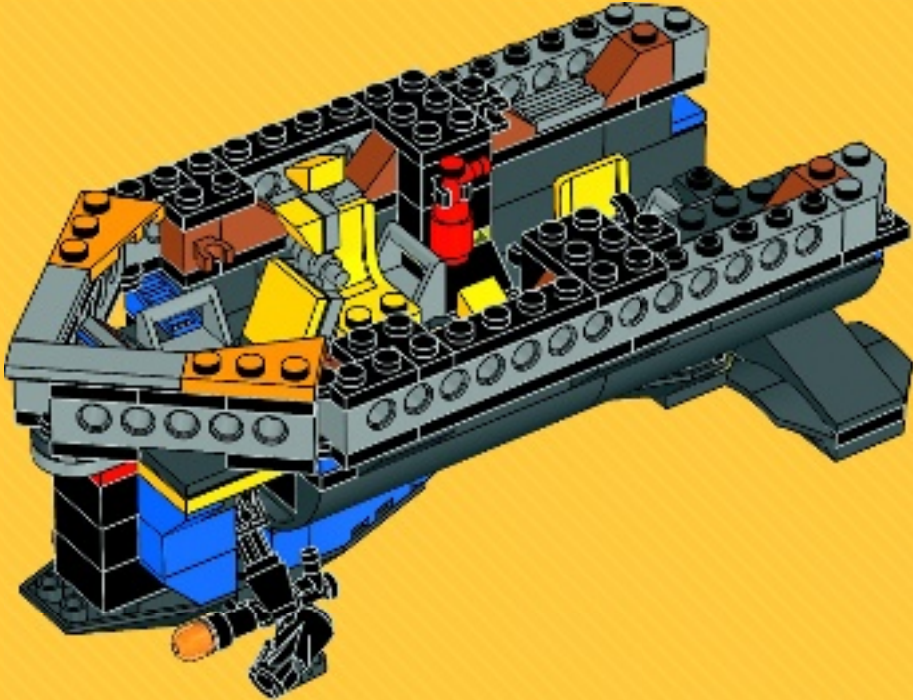



# 41

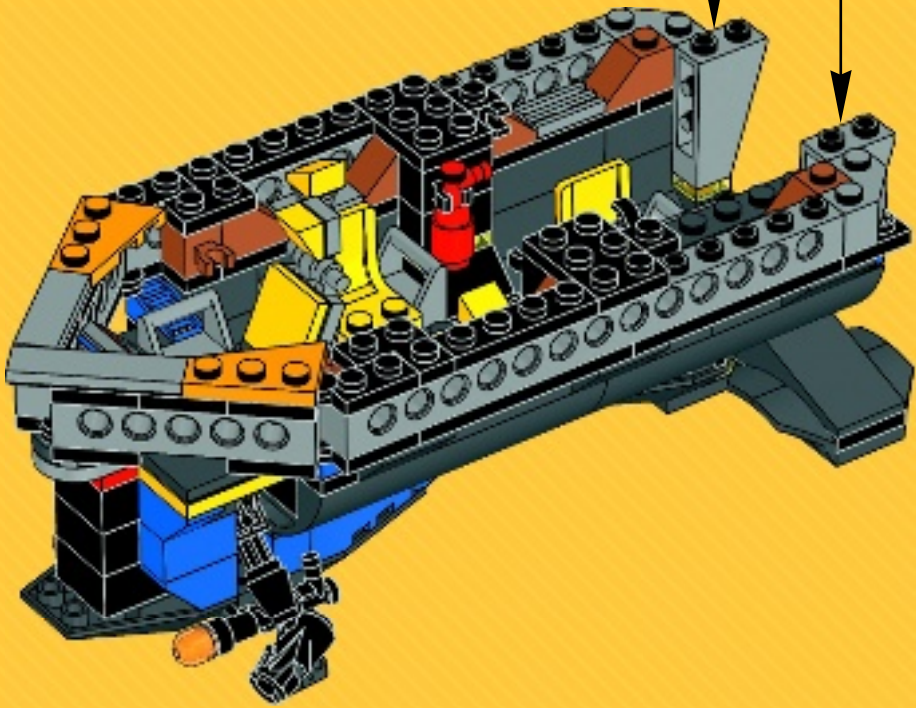
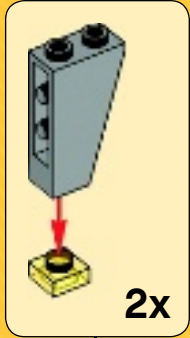





4x



2x

# 42

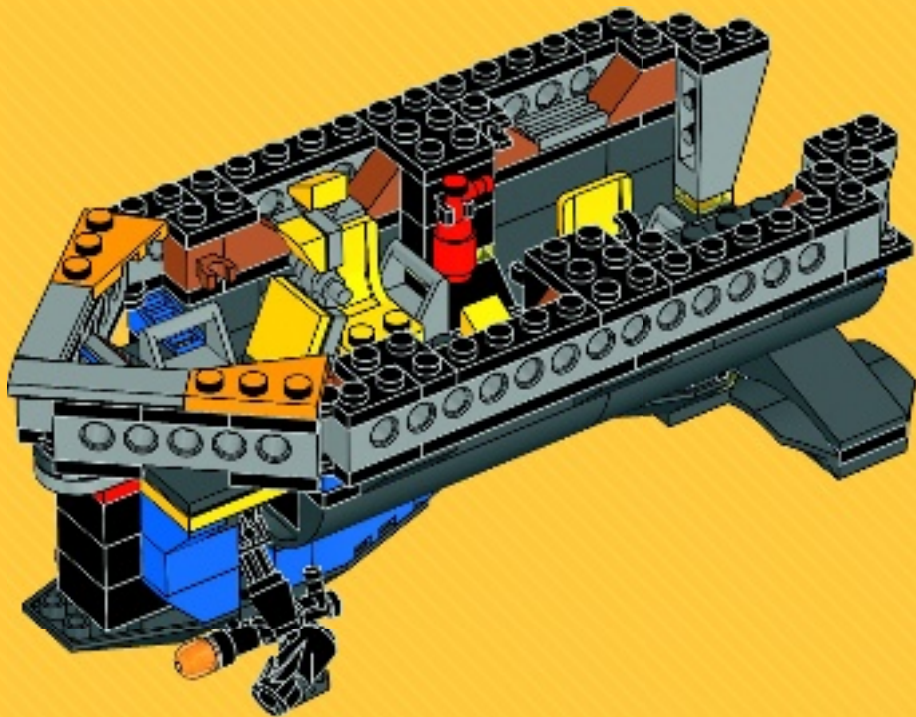

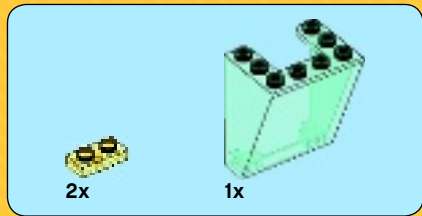

# 43

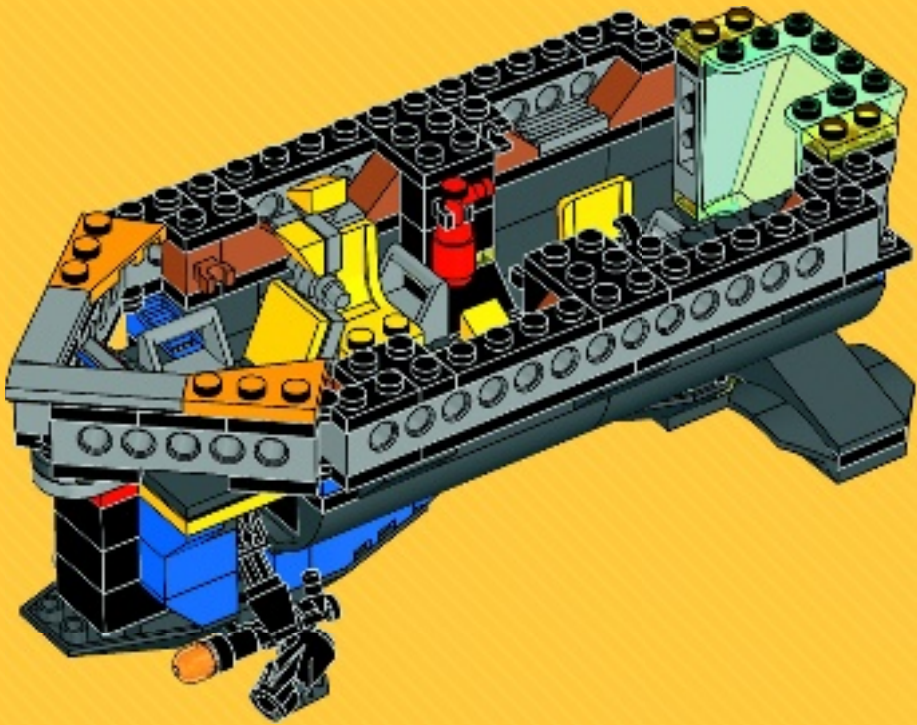



44

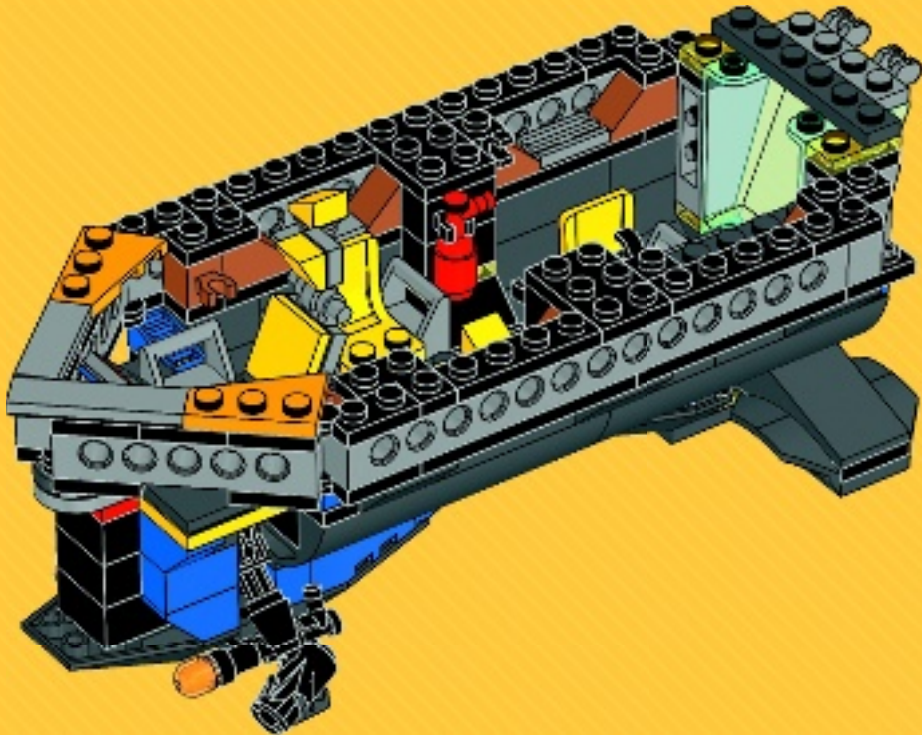



2x

# 45

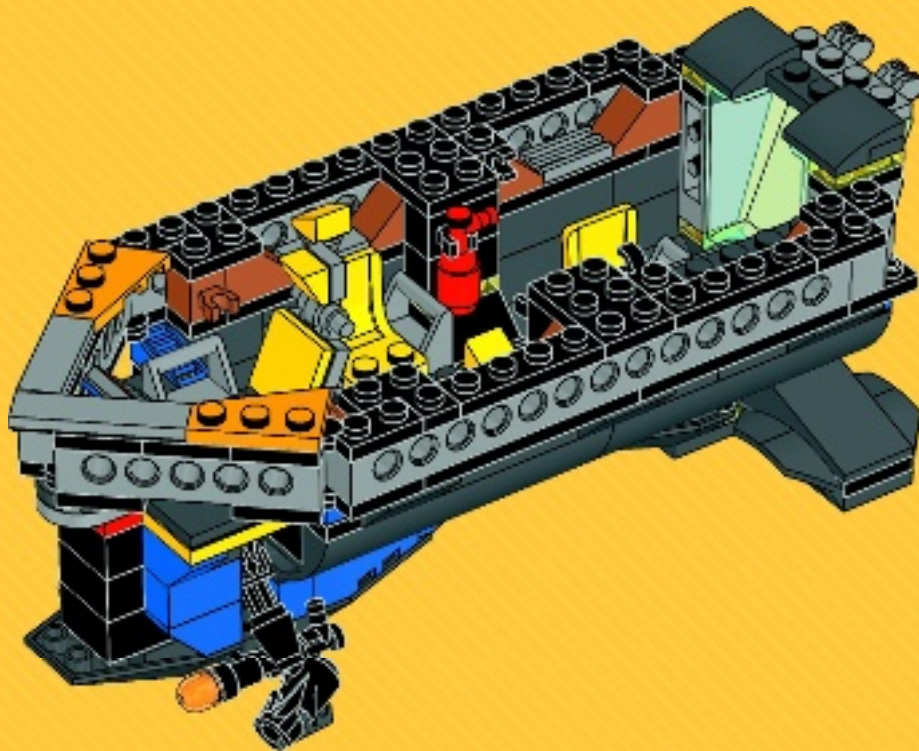

2x



1x

# 46

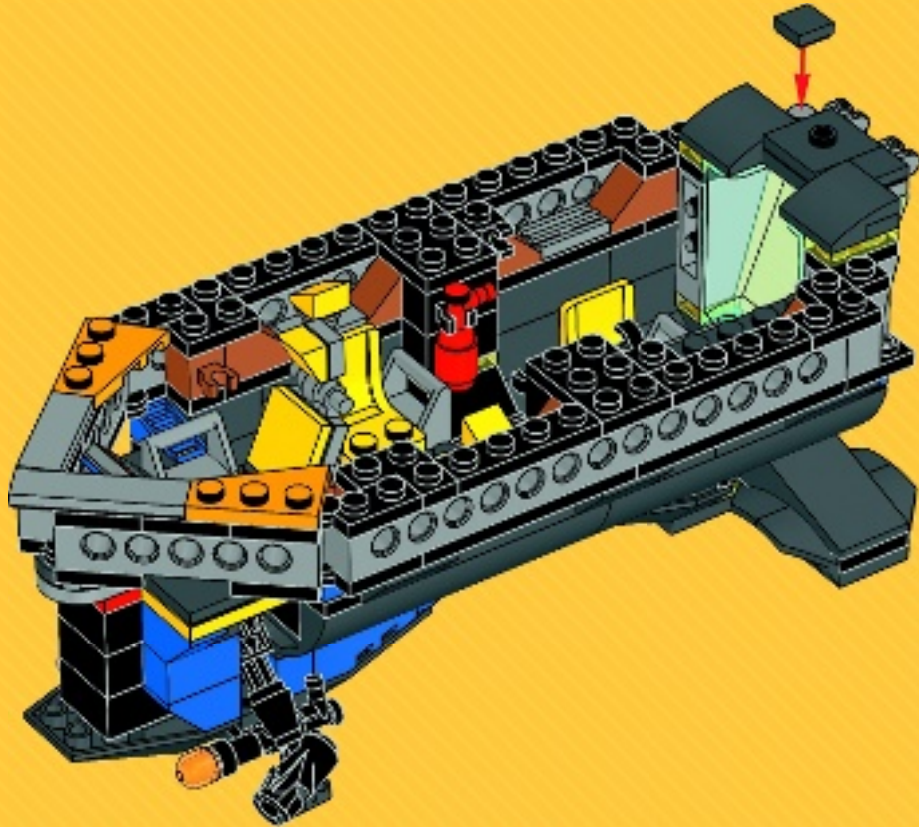



47

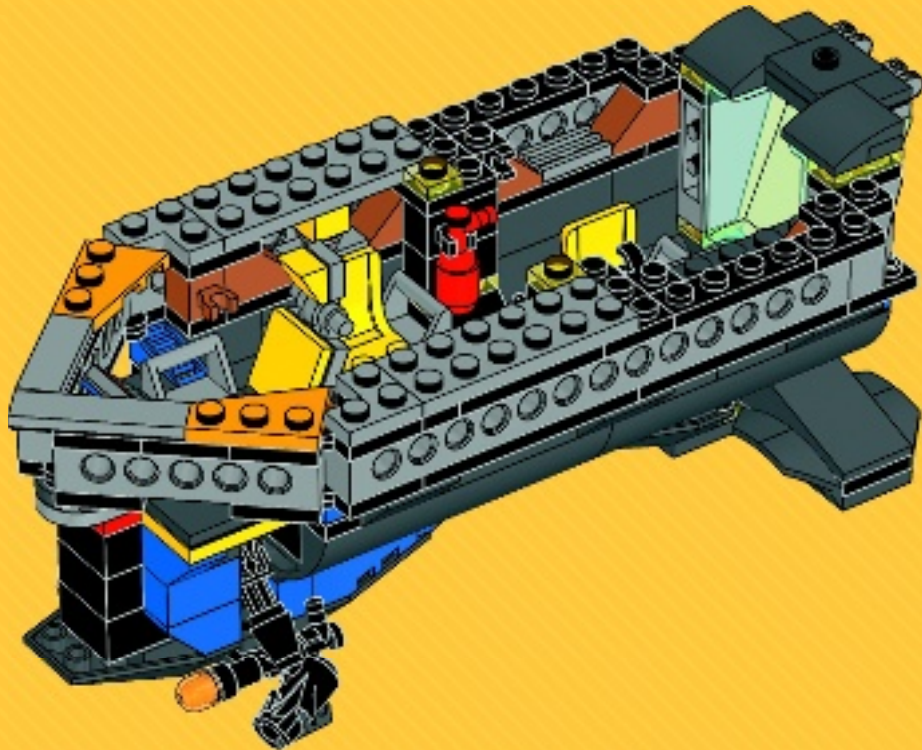



1x

48

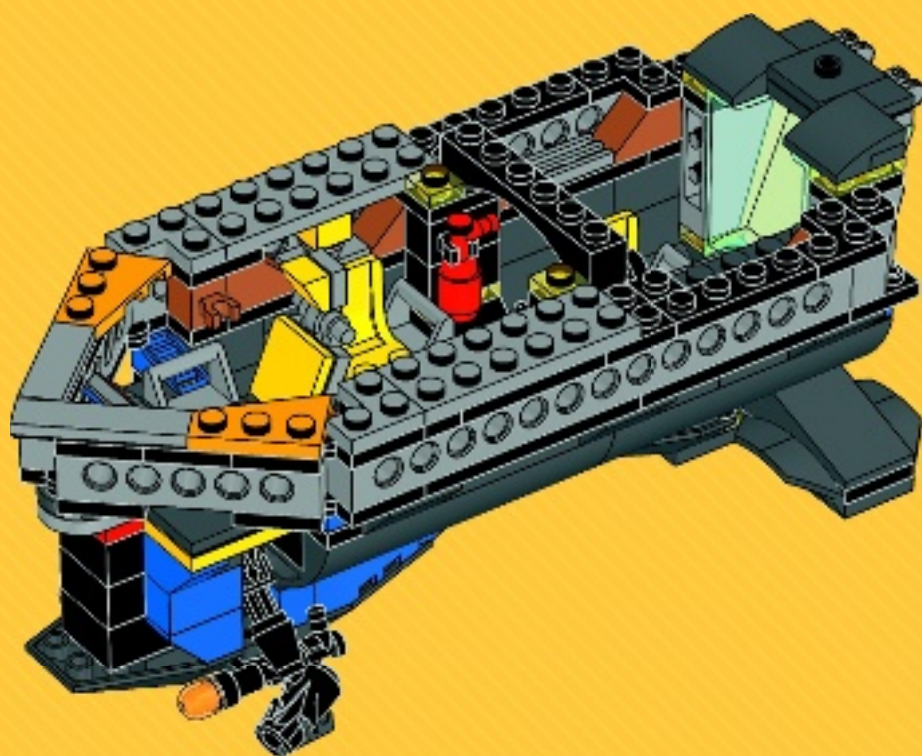

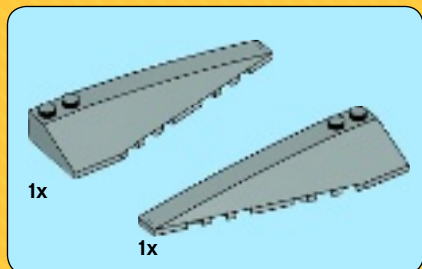

49

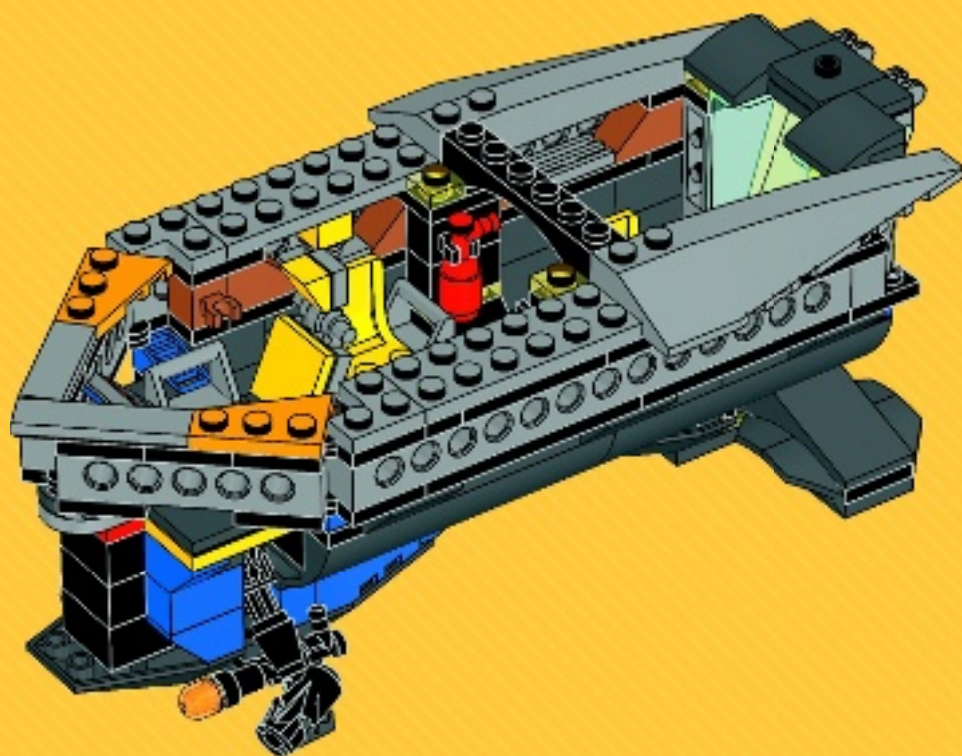



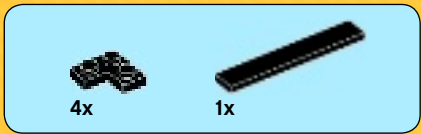

# 50

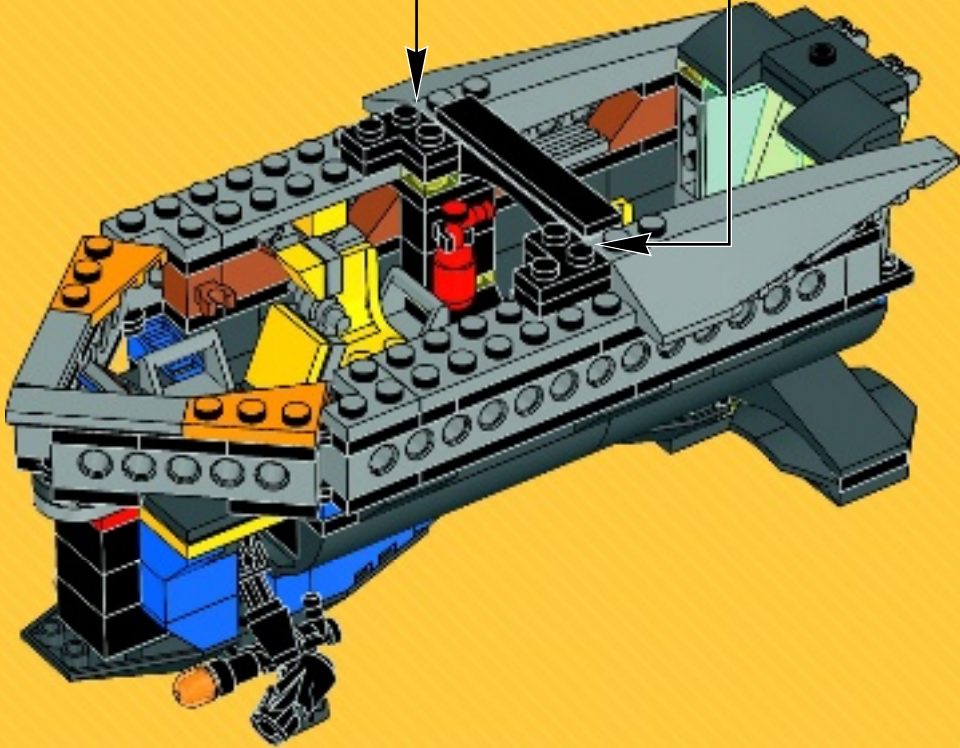
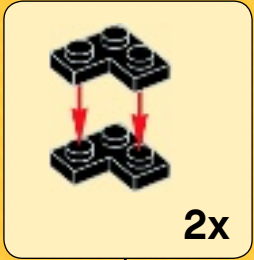

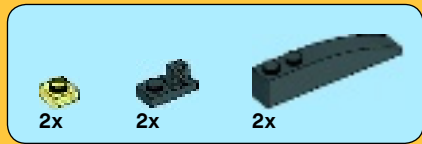

# 51

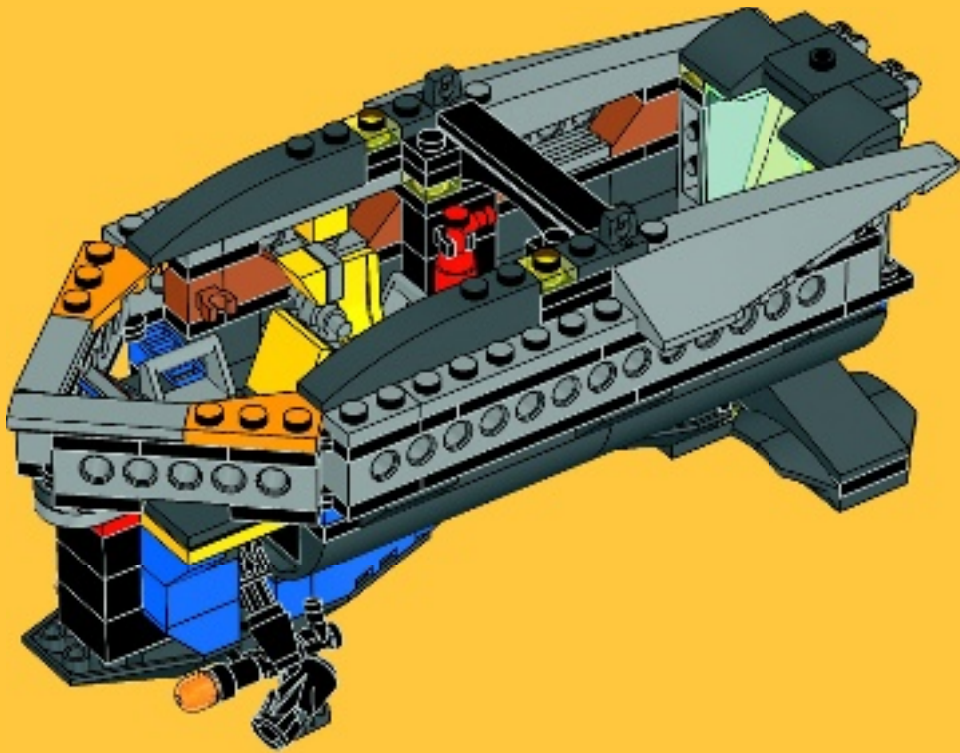



1x

1



2x

2



1x

3



1x

4



1x

5



1x



1x

6

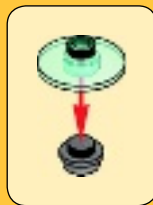



7

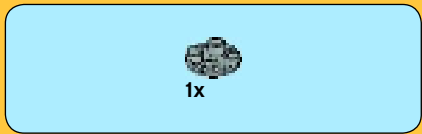

8

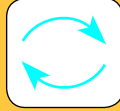

52

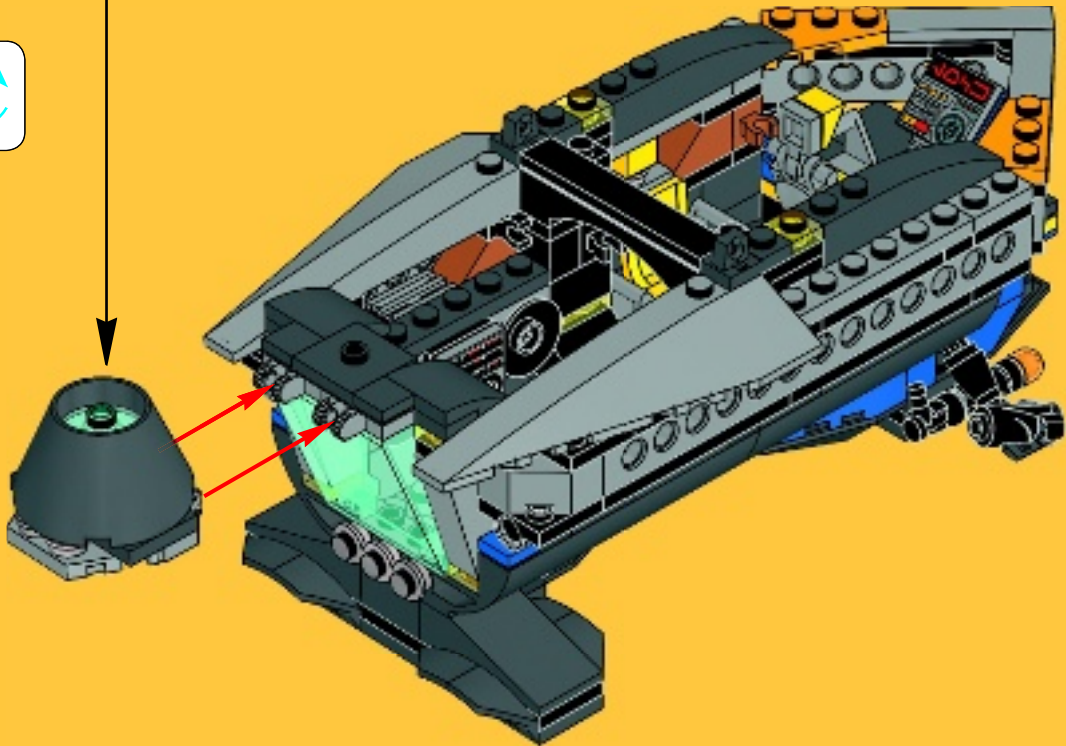



2x



1x

1



1x

2



1x

3



1x

4



6x

5



1x

6



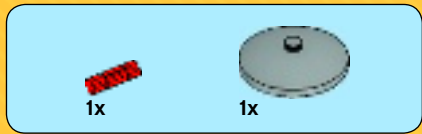

7

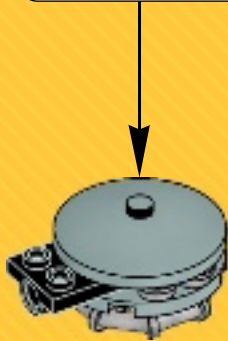
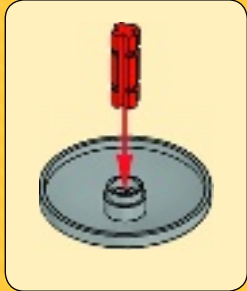

8



9



2x

53

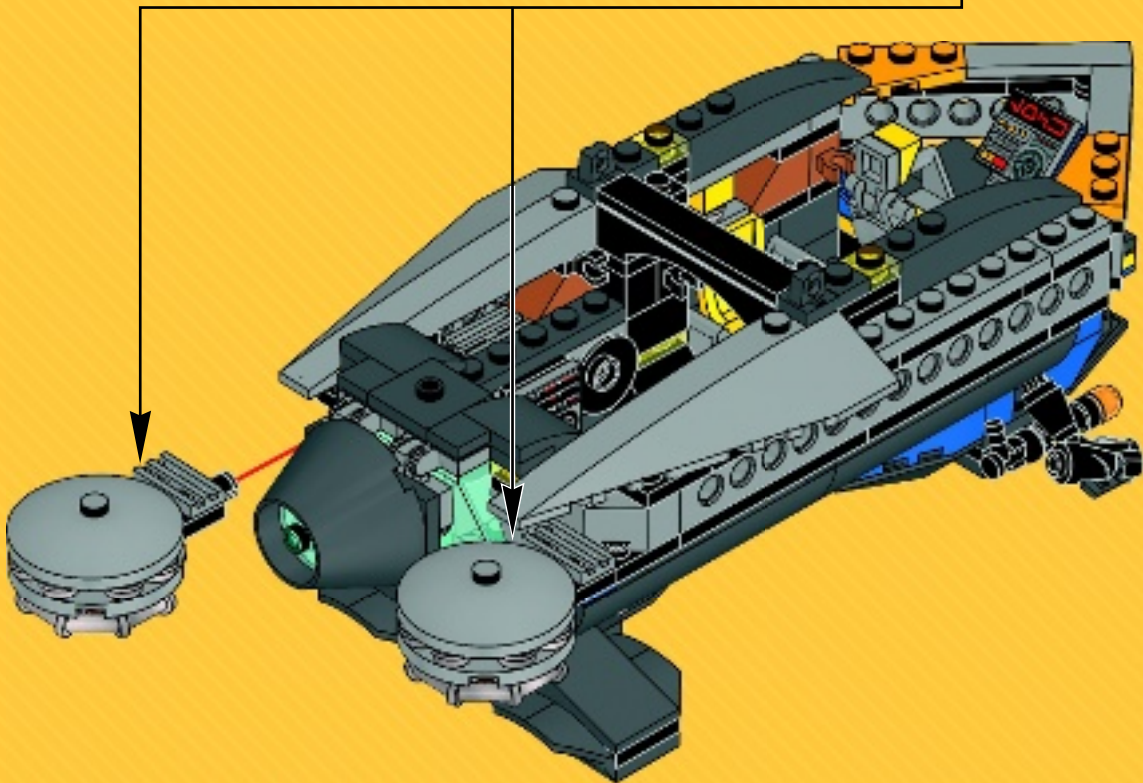



54

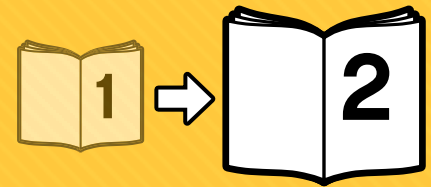
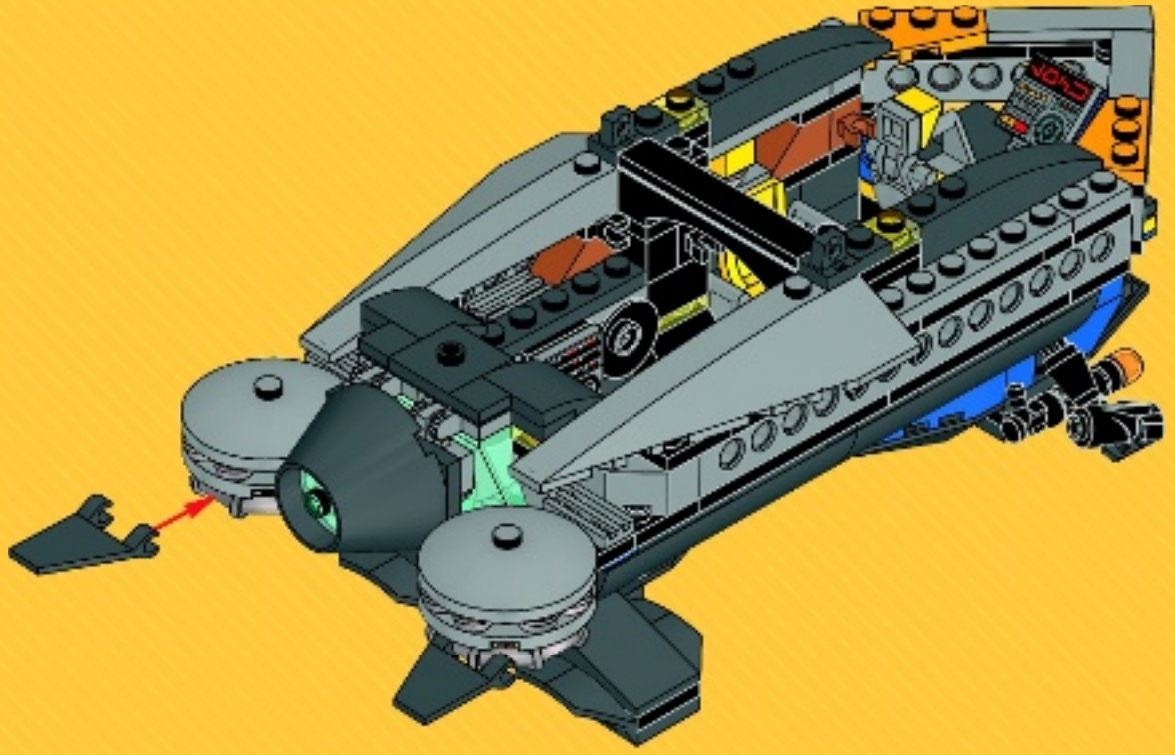

# WIN

GO TO [WWW.LEGO.COM/PRODUCTFEEDBACK](http://WWW.LEGO.COM/PRODUCTFEEDBACK)  
AND GIVE US YOUR SHORT **FEEDBACK**  
ABOUT THIS LEGO® SET FOR A CHANCE  
TO WIN A COOL LEGO PRIZE.



## LEGO.com/productfeedback

### GEWINNE



Erzähle uns auf  
[www.LEGO.com/productfeedback](http://www.LEGO.com/productfeedback)

etwas über die Erfahrungen, die du  
mit diesem LEGO® Set gemacht hast,  
und sichere dir die Chance auf einen  
coolen LEGO Preis!

### GAGNE



Rends-toi sur  
[www.LEGO.com/productfeedback](http://www.LEGO.com/productfeedback)

et donne-nous quelques commen-  
taires sur ce produit LEGO® pour avoir  
une chance de gagner un prix LEGO!

### GANAN



Visita  
[www.LEGO.com/productfeedback](http://www.LEGO.com/productfeedback)

y envíanos tu opinión acerca de este  
set LEGO®. ¡Participarás en el sorteo  
de un premio LEGO!

### 获取奖品



登录  
[www.LEGO.com/productfeedback](http://www.LEGO.com/productfeedback)

给出关于此乐高®套装的简短反馈，  
就有机会获得炫酷乐高奖品

### 경품 당첨 기회



[www.LEGO.com/productfeedback](http://www.LEGO.com/productfeedback)

페이지로 이동하여 이 레고® 세트에  
대한 간략한 피드백을 보내 주시고  
멋진 레고 경품을 탈 수 있는 기회도  
잡으십시오

### ЗАПОЛНИ АНКЕТУ И ПОЛУЧИ ПРИЗ



Перейди по ссылке  
[www.LEGO.com/productfeedback](http://www.LEGO.com/productfeedback)

ответь всего на несколько вопро-  
сов об этом наборе LEGO®, и у тебя  
появится шанс выиграть замеча-  
тельный приз от компании LEGO.