

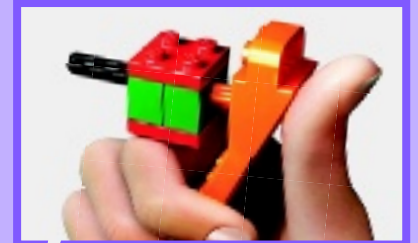

41055

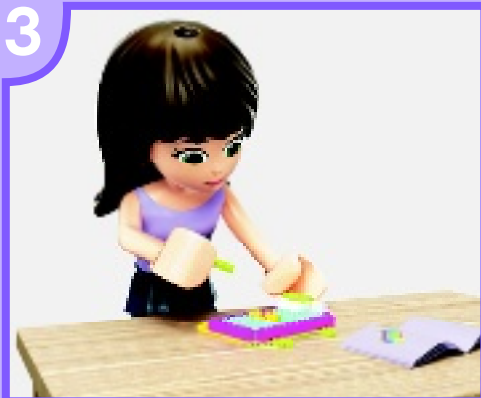

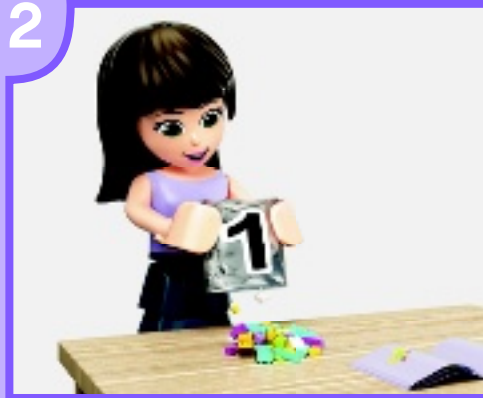

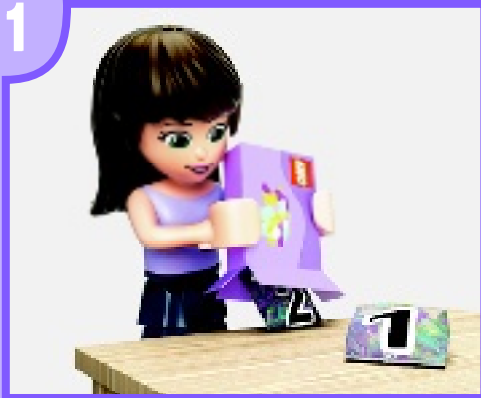

[LEGO.com/brickseparator](https://LEGO.com/brickseparator)

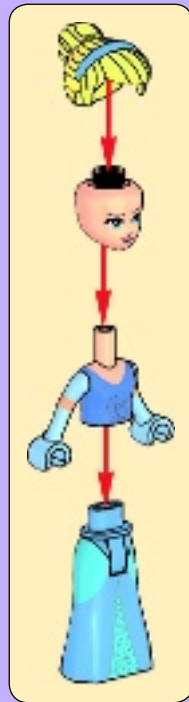
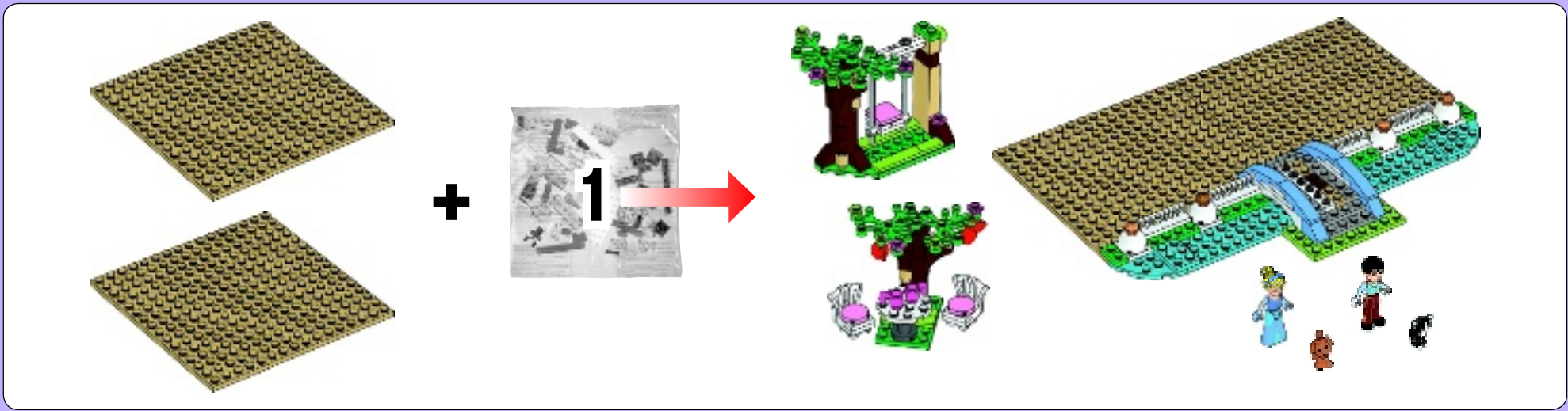

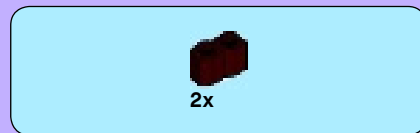
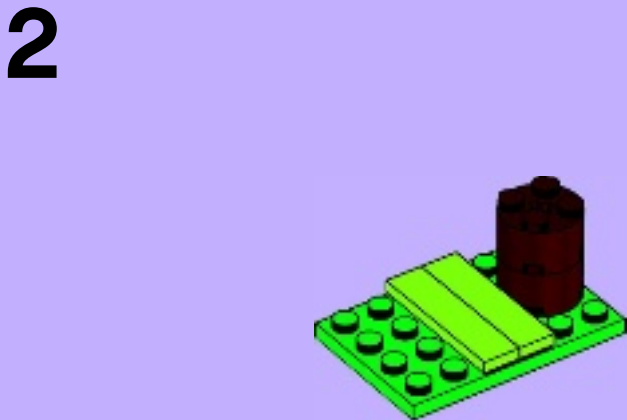
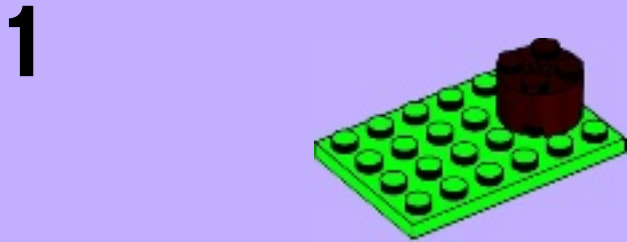
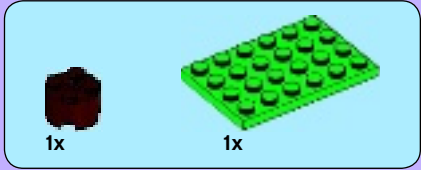

**3**

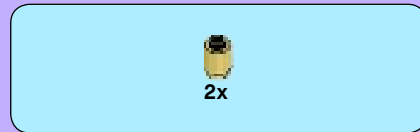
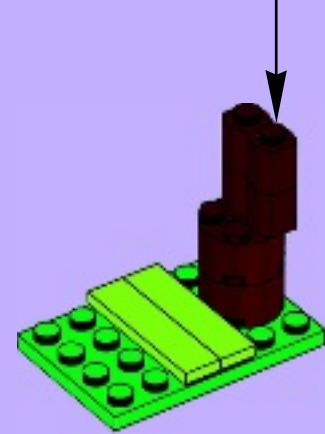

**4**

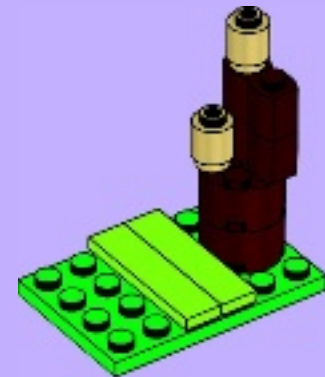





5

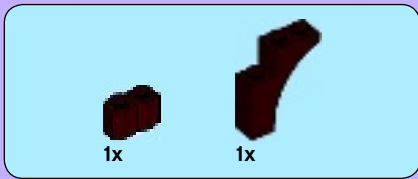
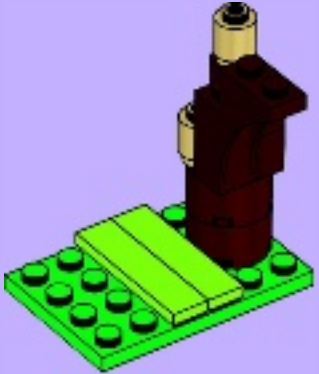

6

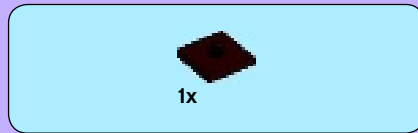
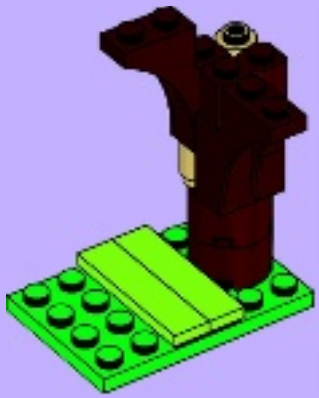

7

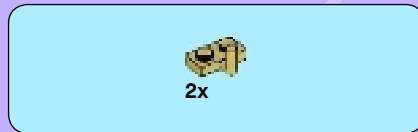
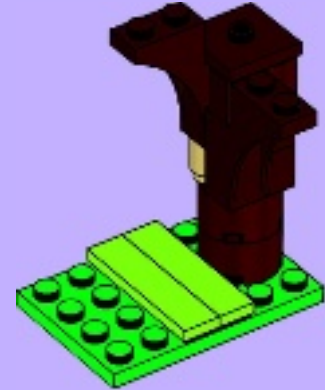

8

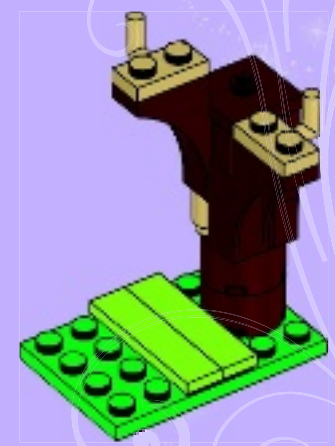



9

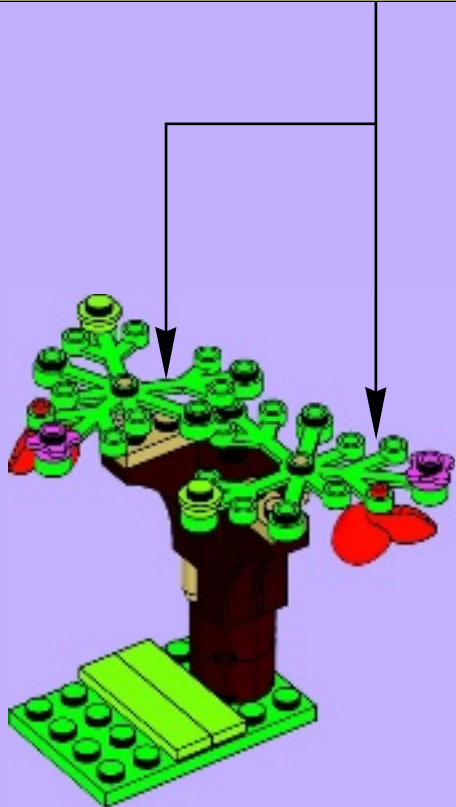
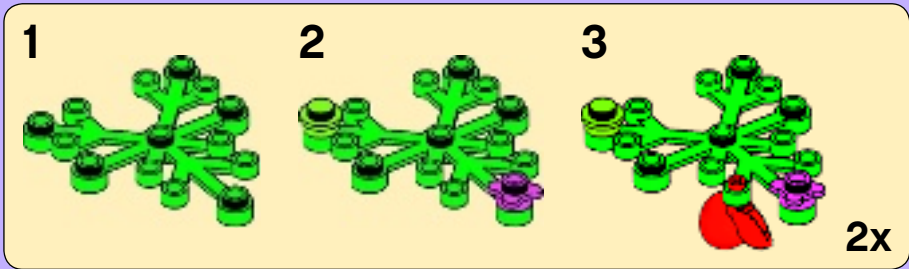

10





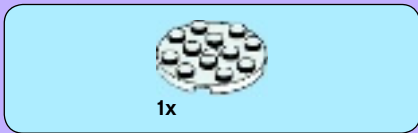

11

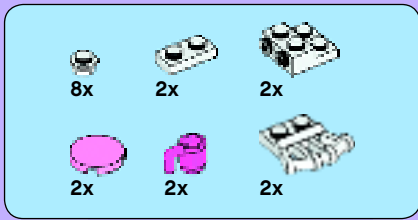

12





1



2

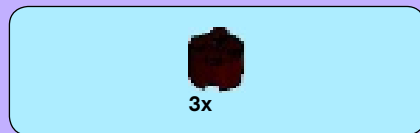

3

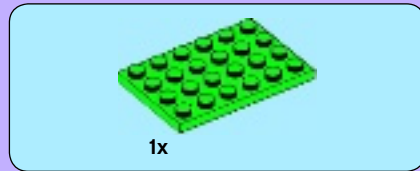
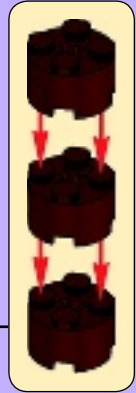

4

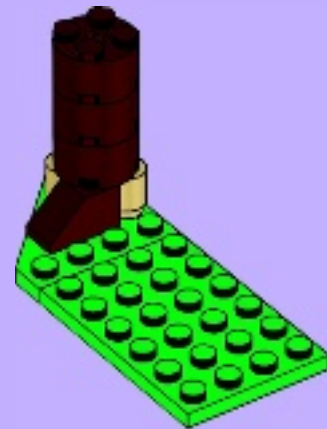



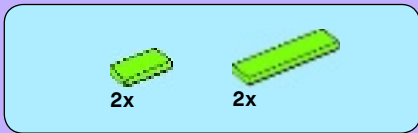

5

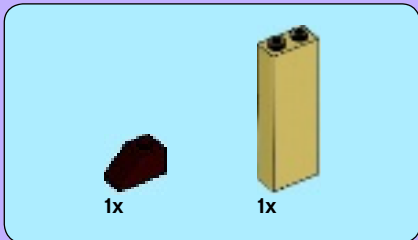
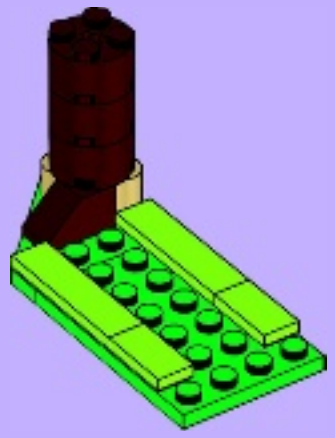

6

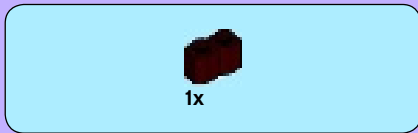
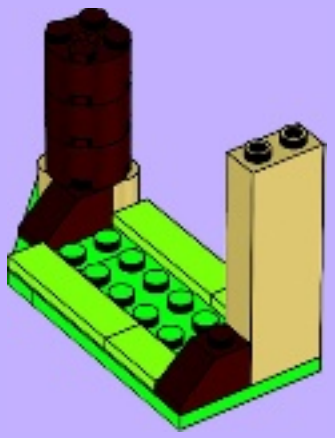

7

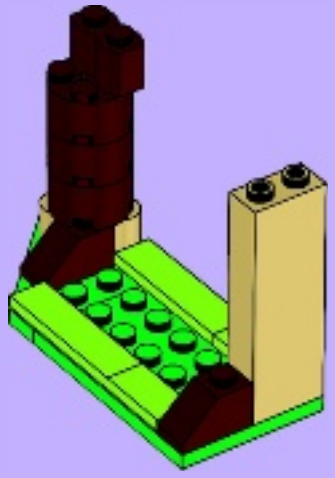

8

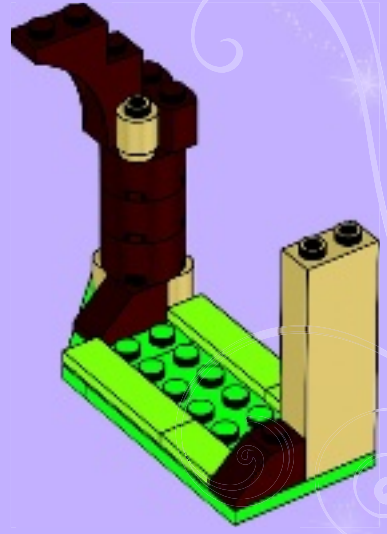



9

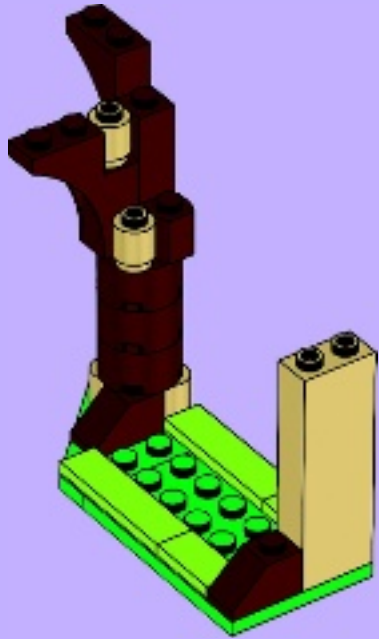

10

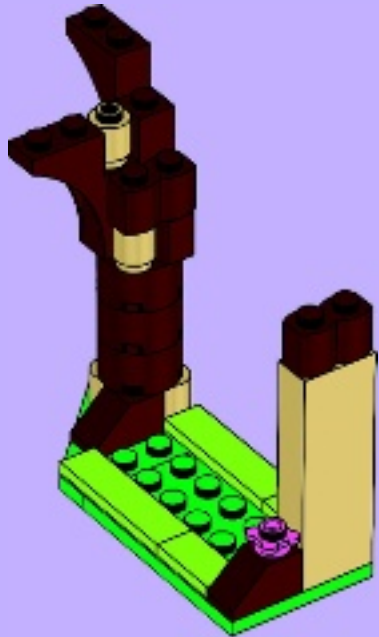

1

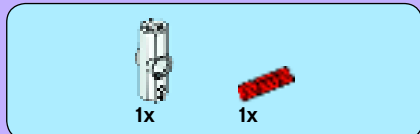
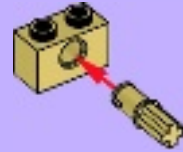

2

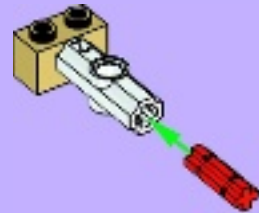



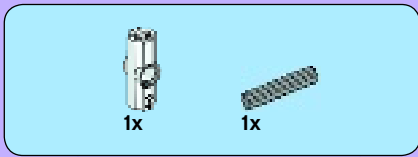

3

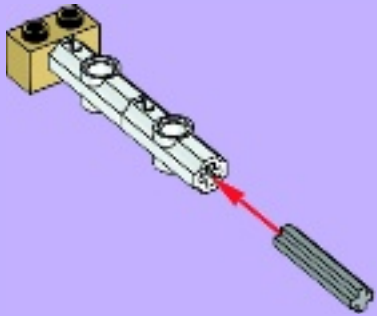

4

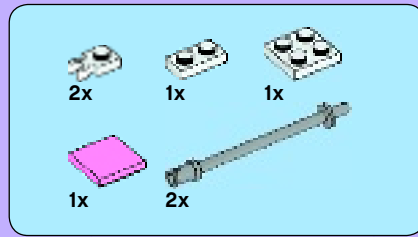
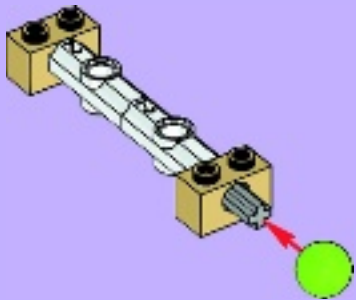

5

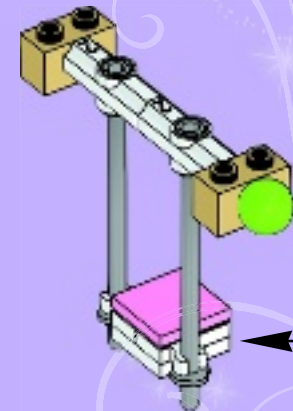
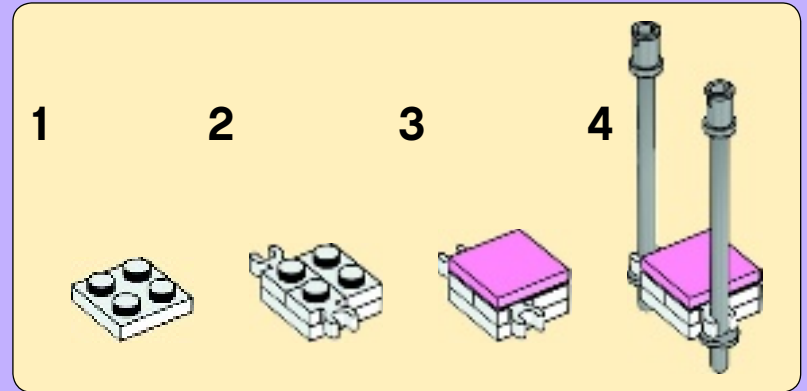





2x

# 13

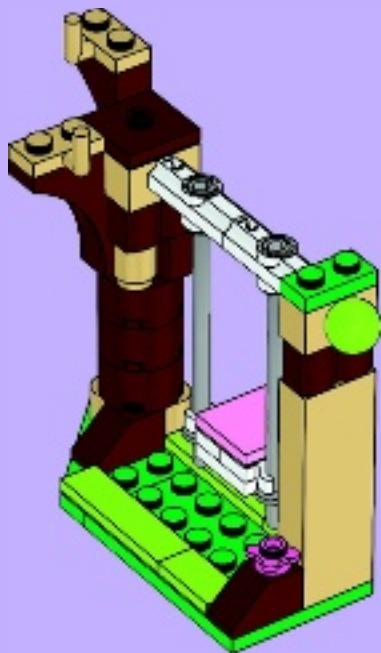

2x

2x

2x

# 14

1

2

2x

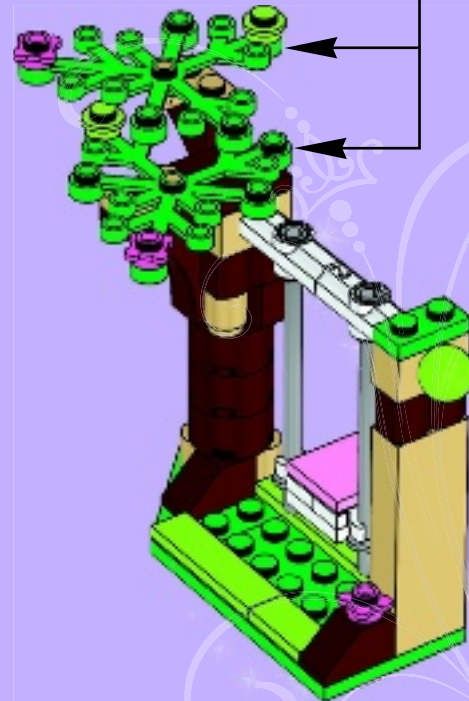

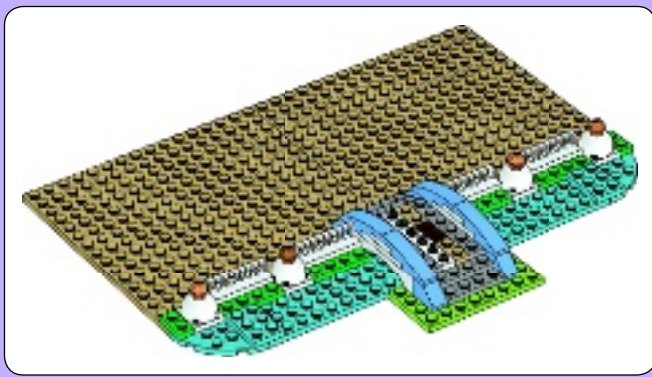

1x

1

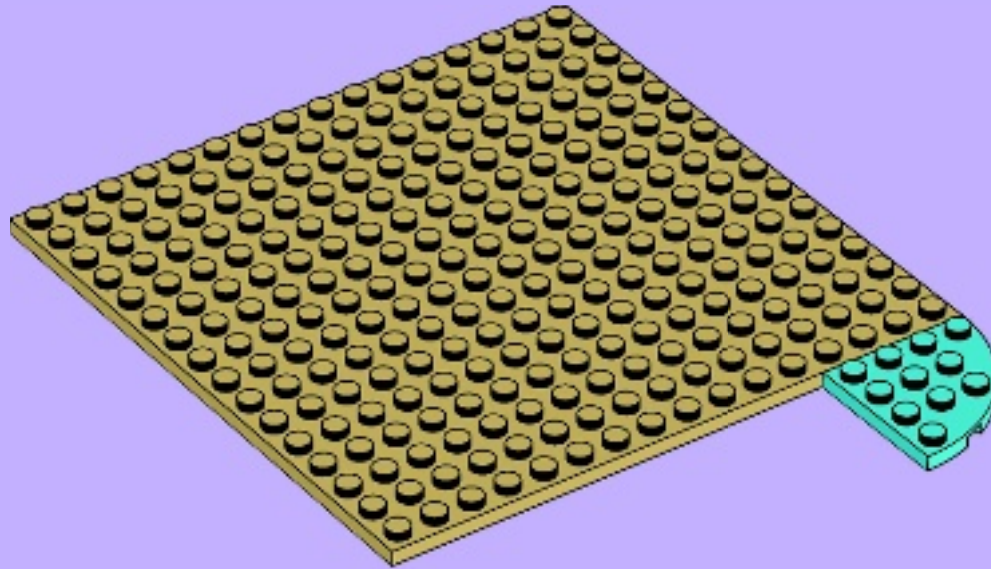





2

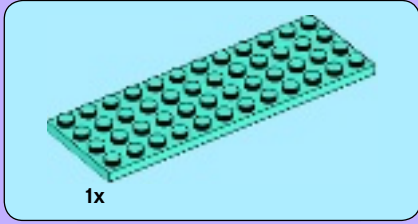
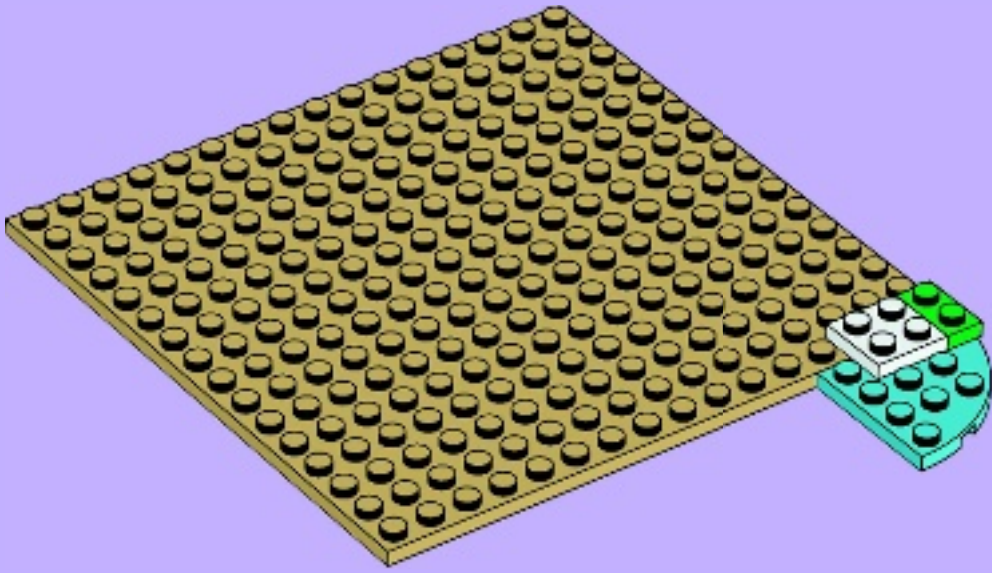

3

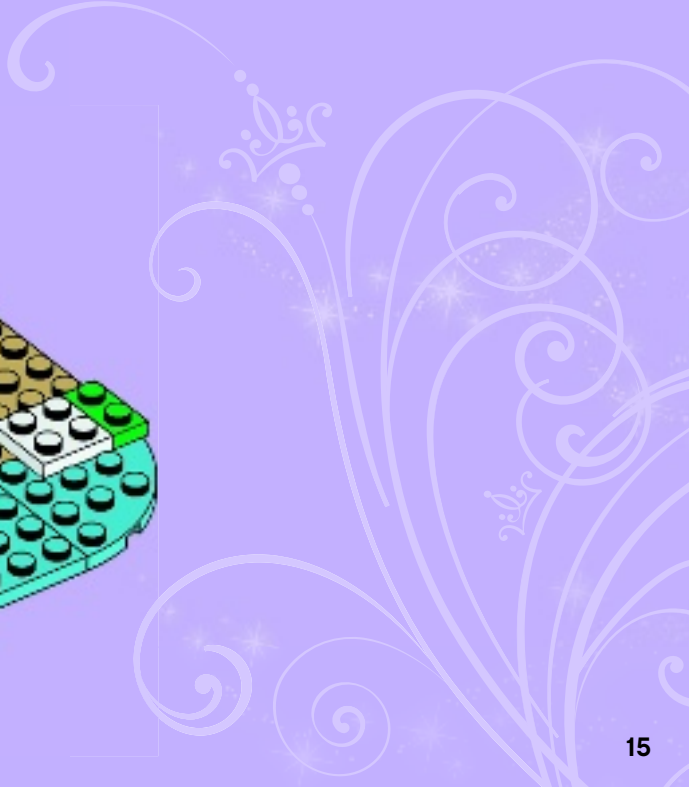
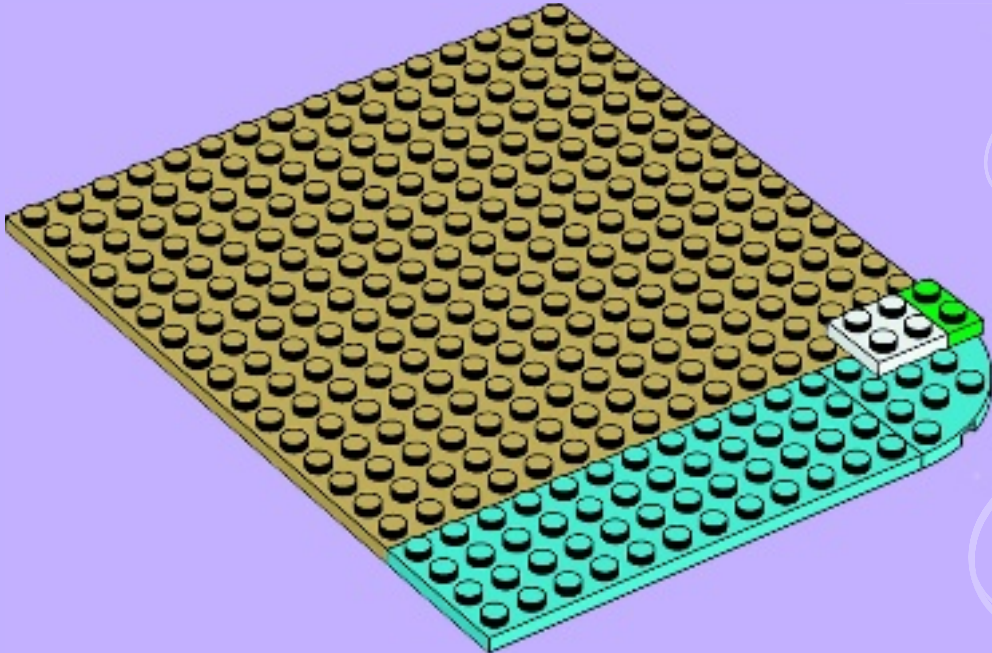



2x



1x

4

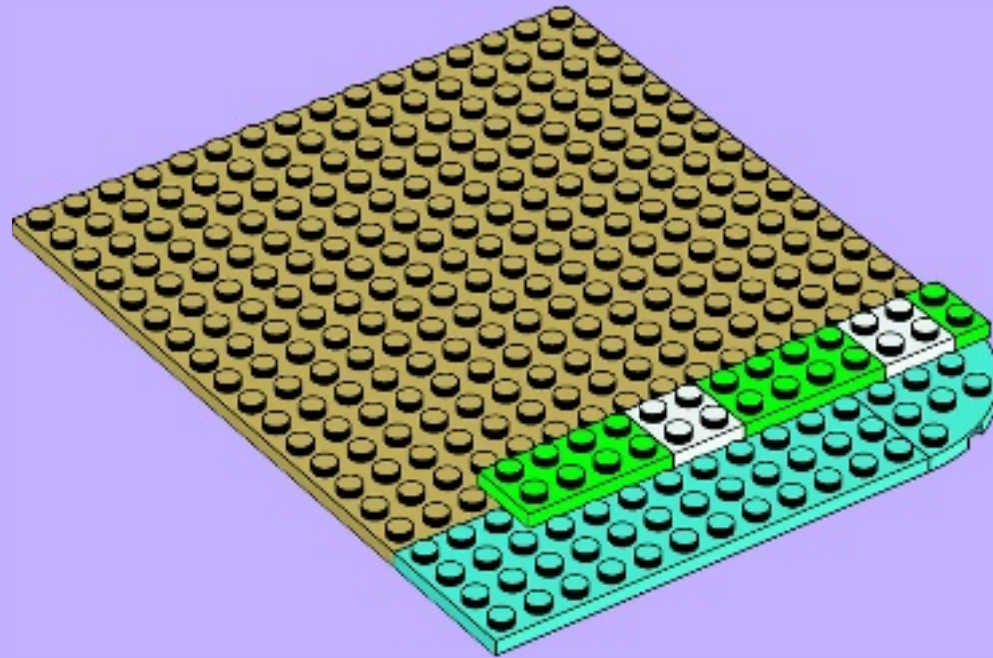

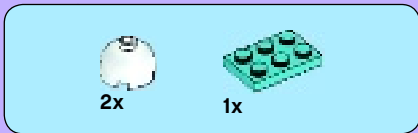

5

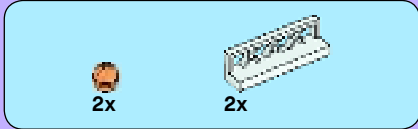
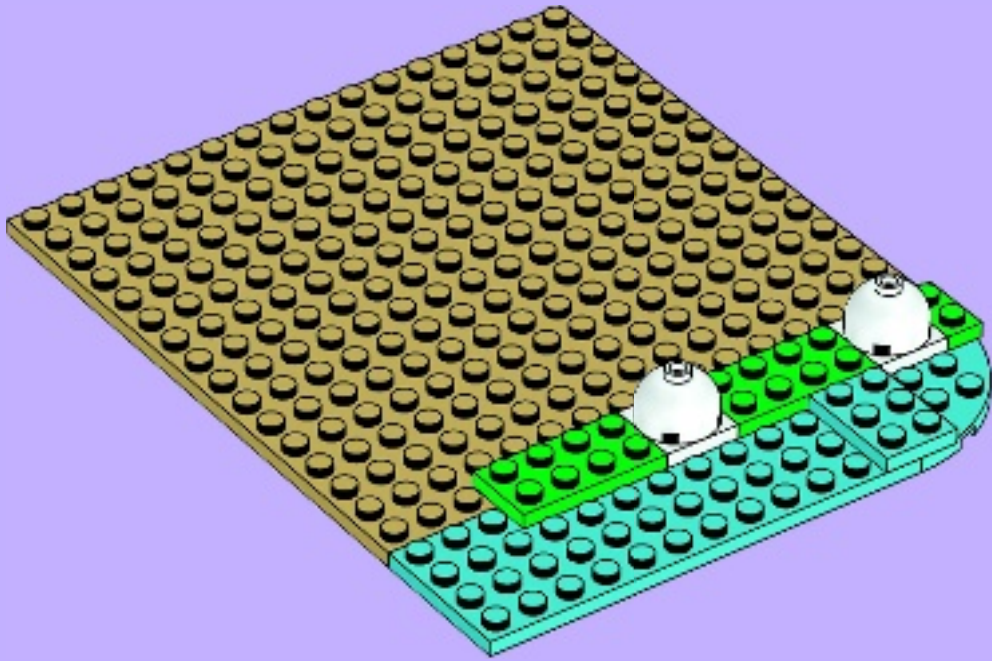

6

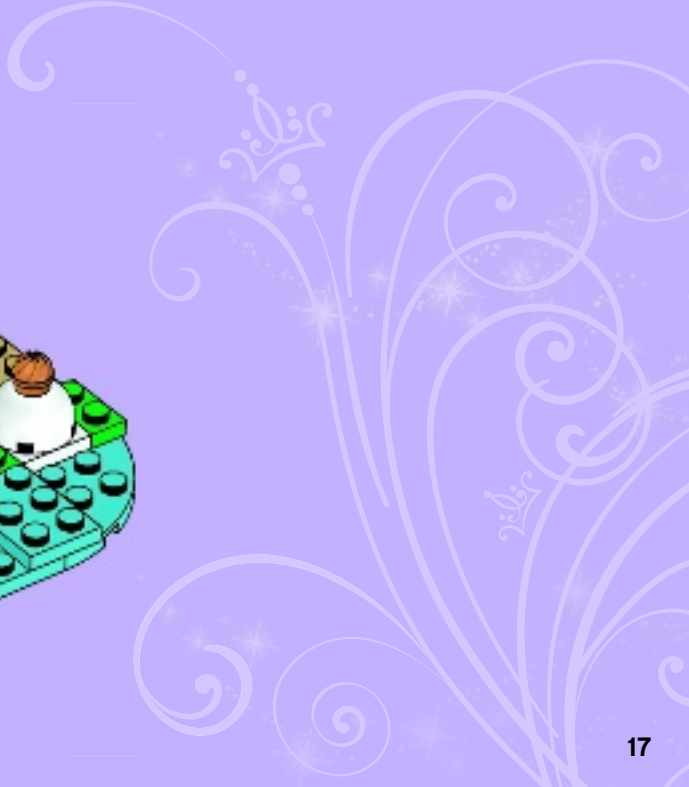
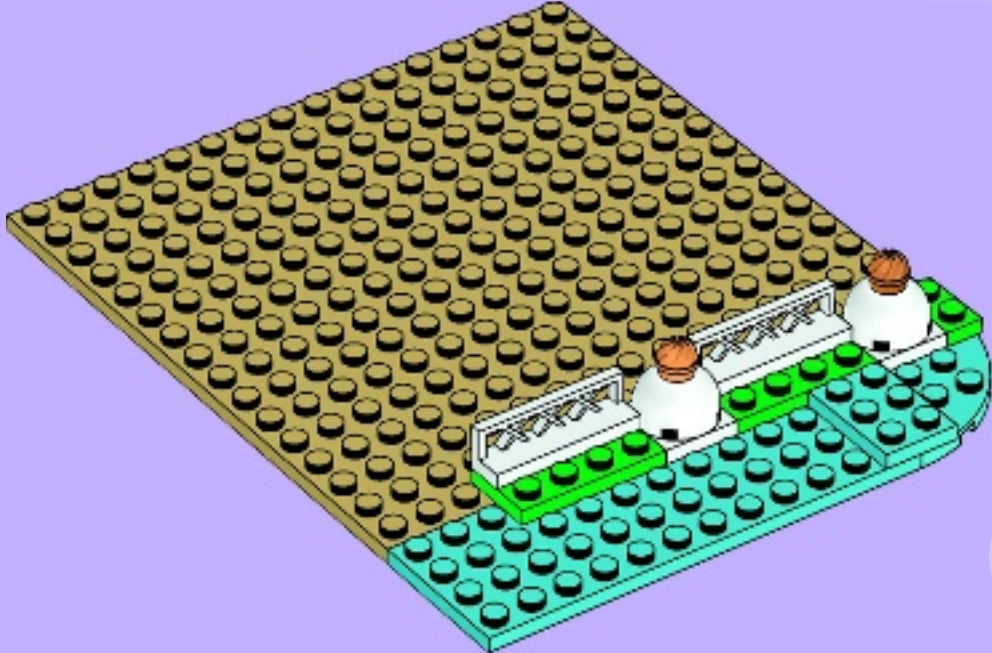





7

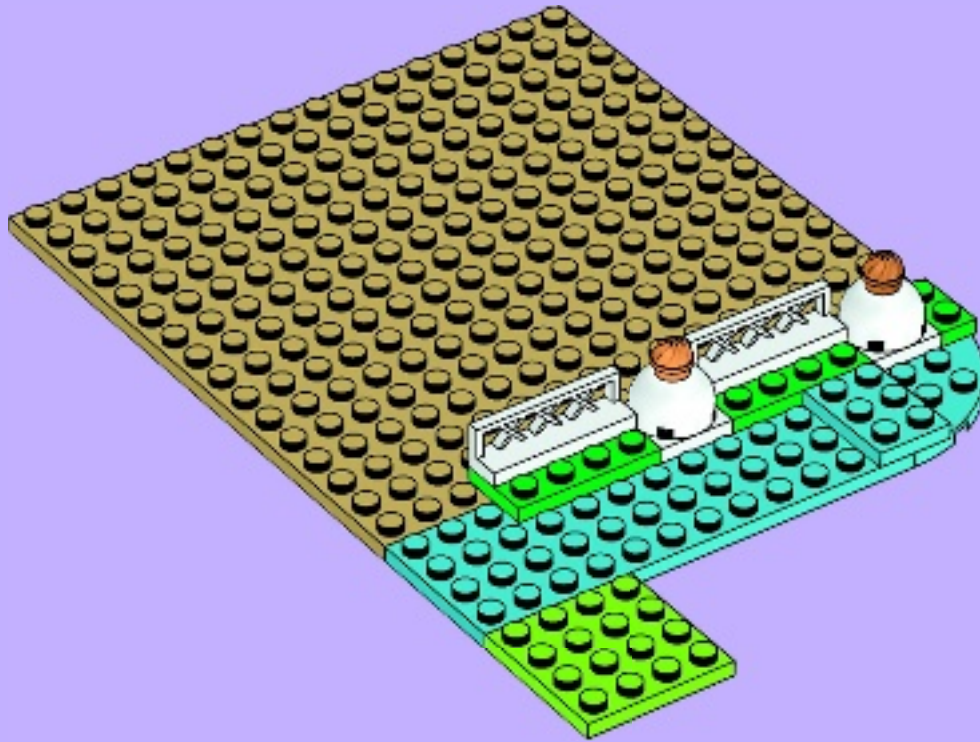



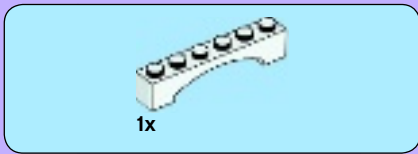

8

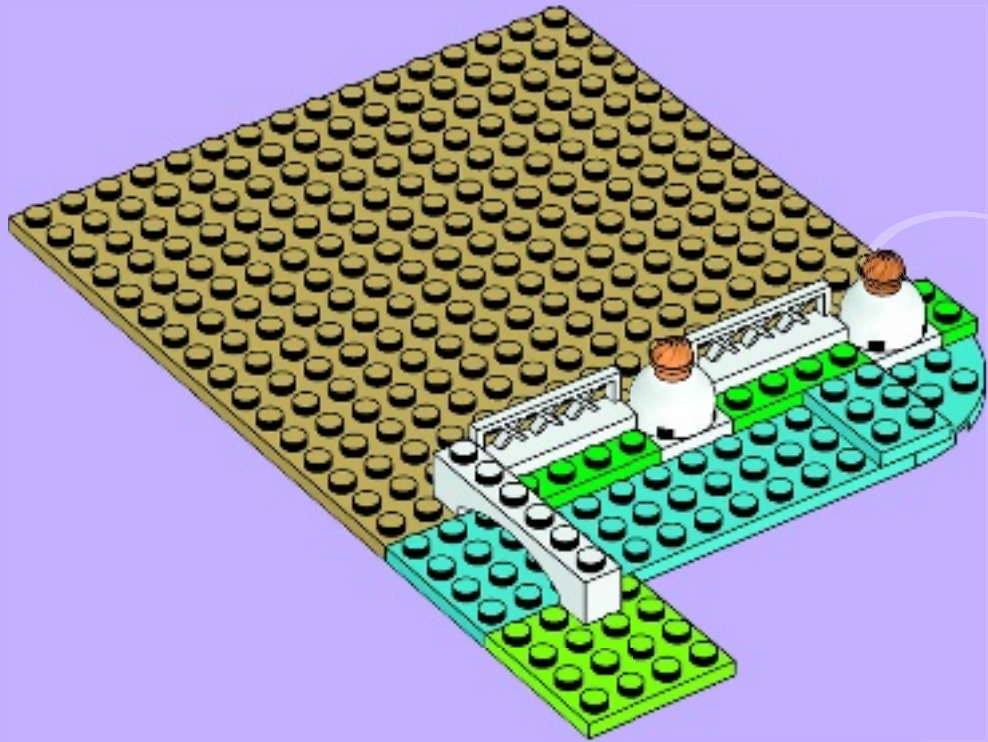

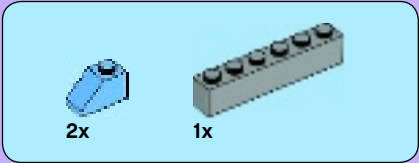

9

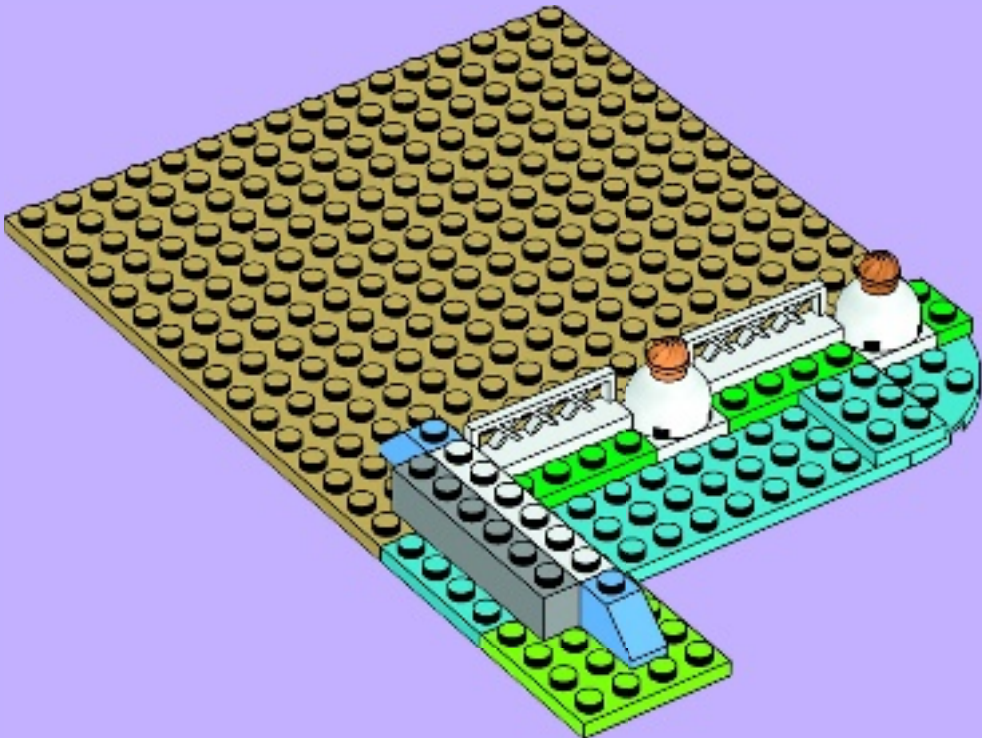

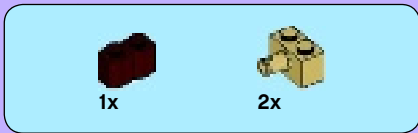

# 10

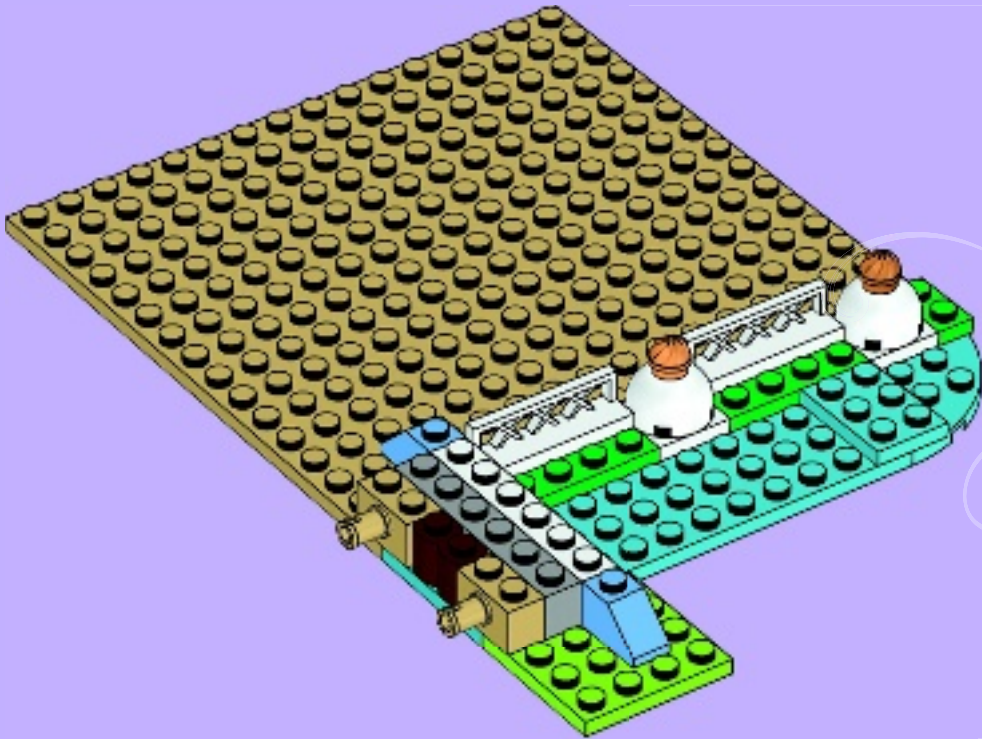



# 11

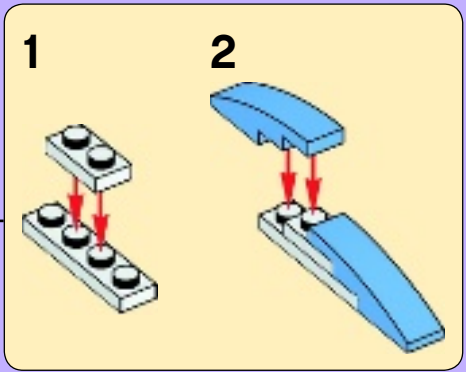
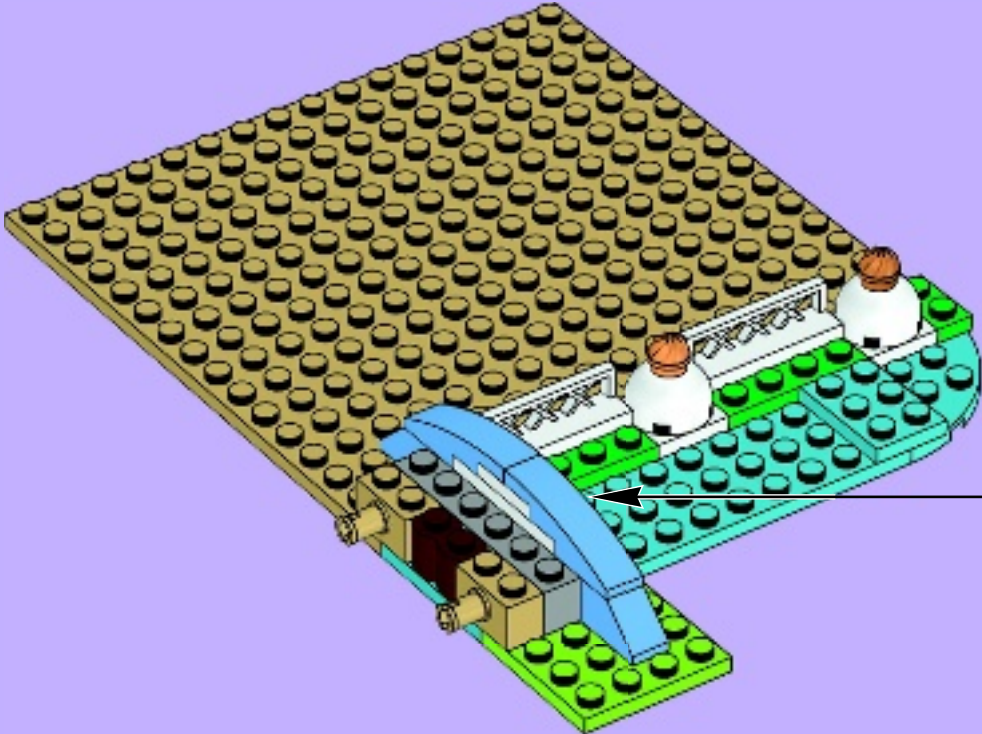



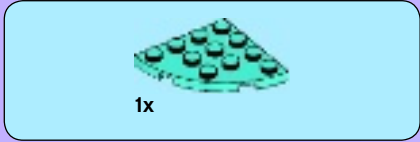
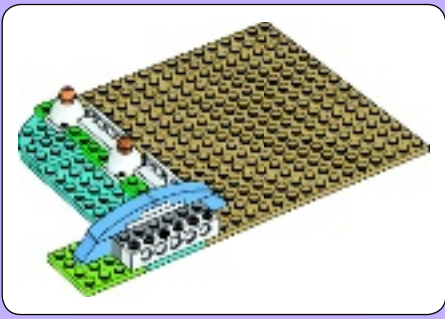

1

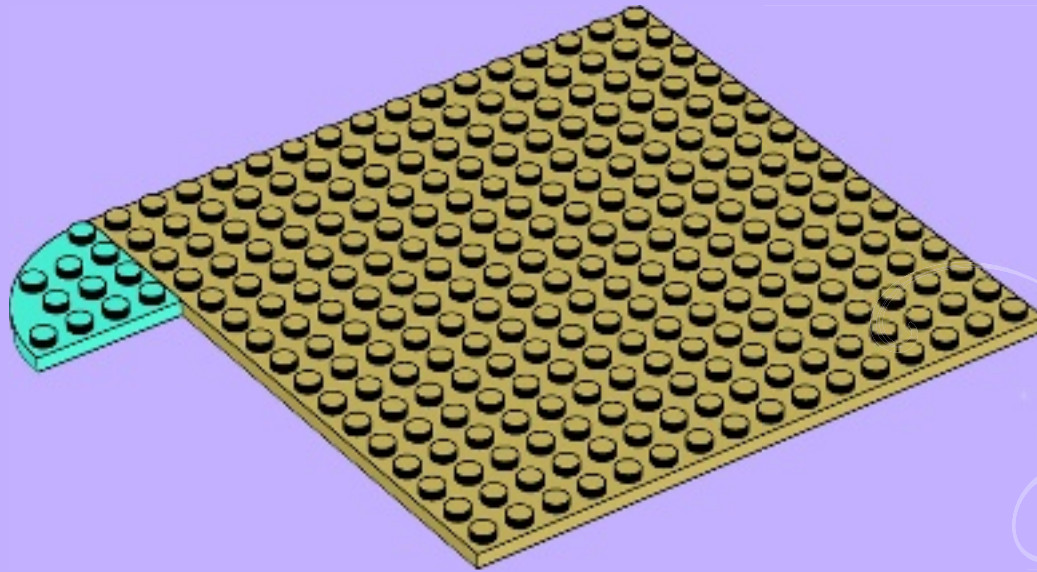

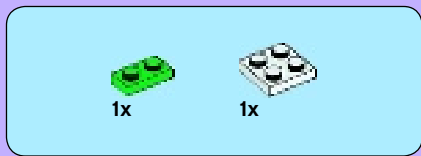

2

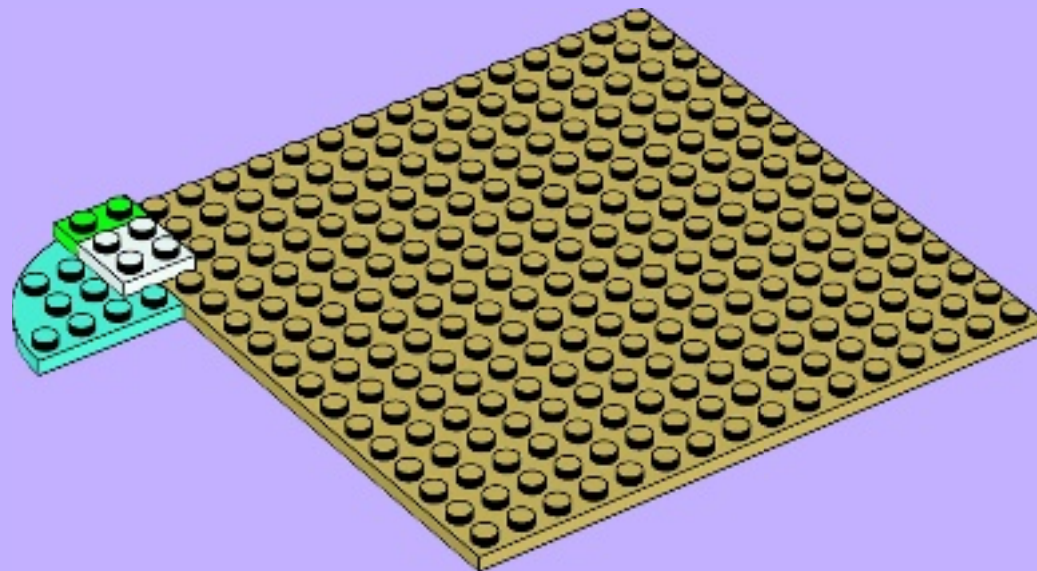

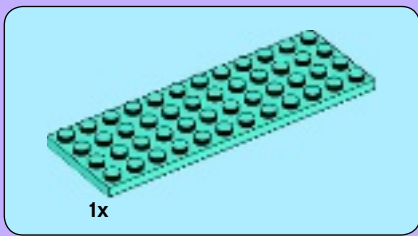

3

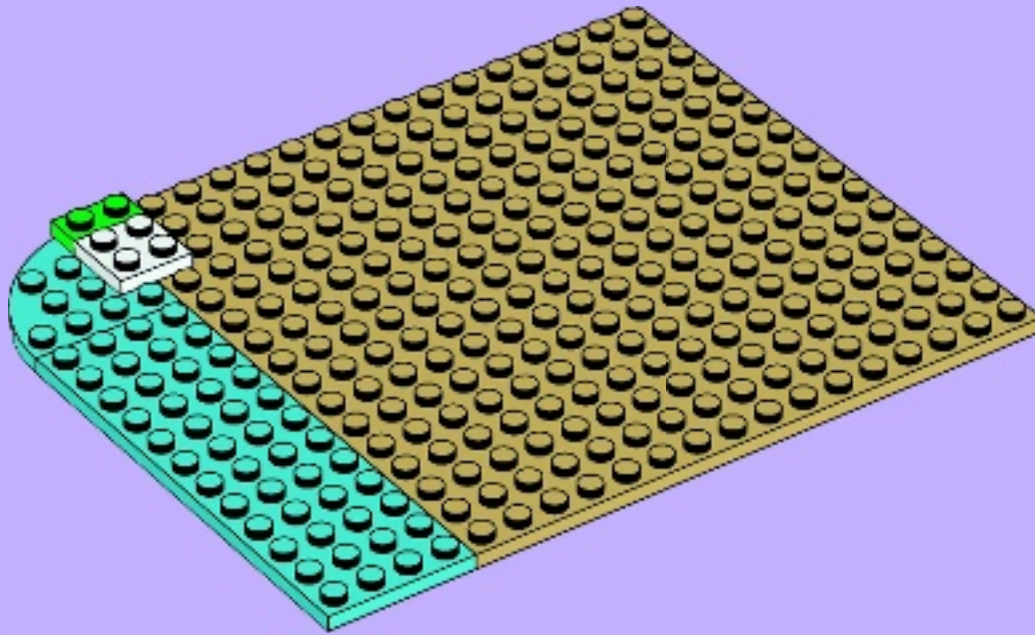

4

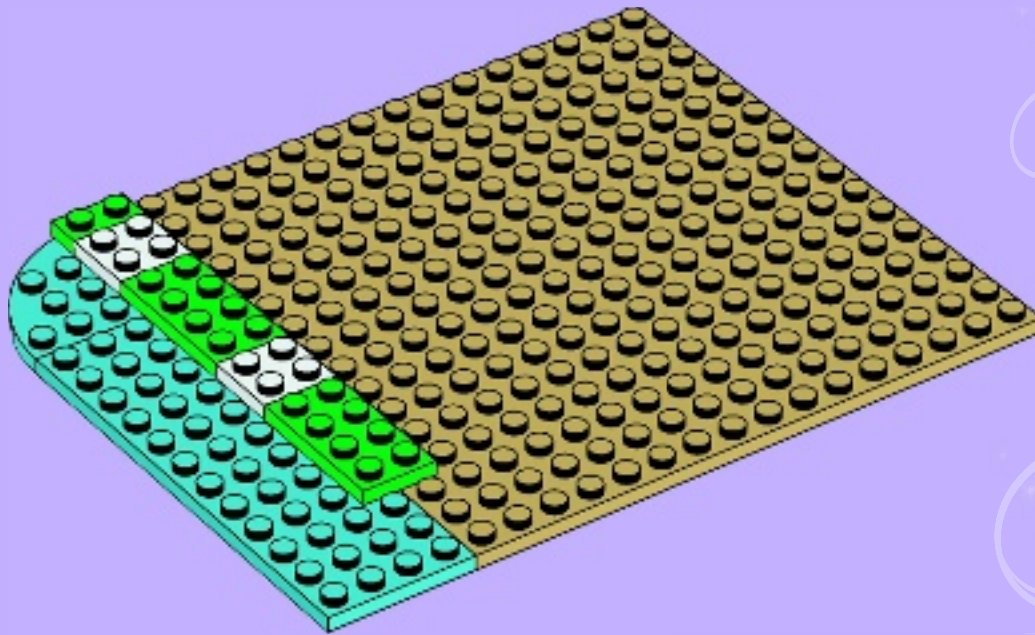



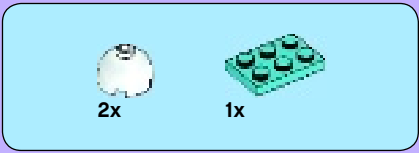

5

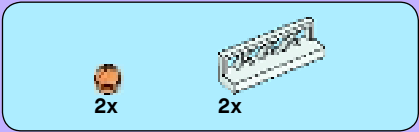
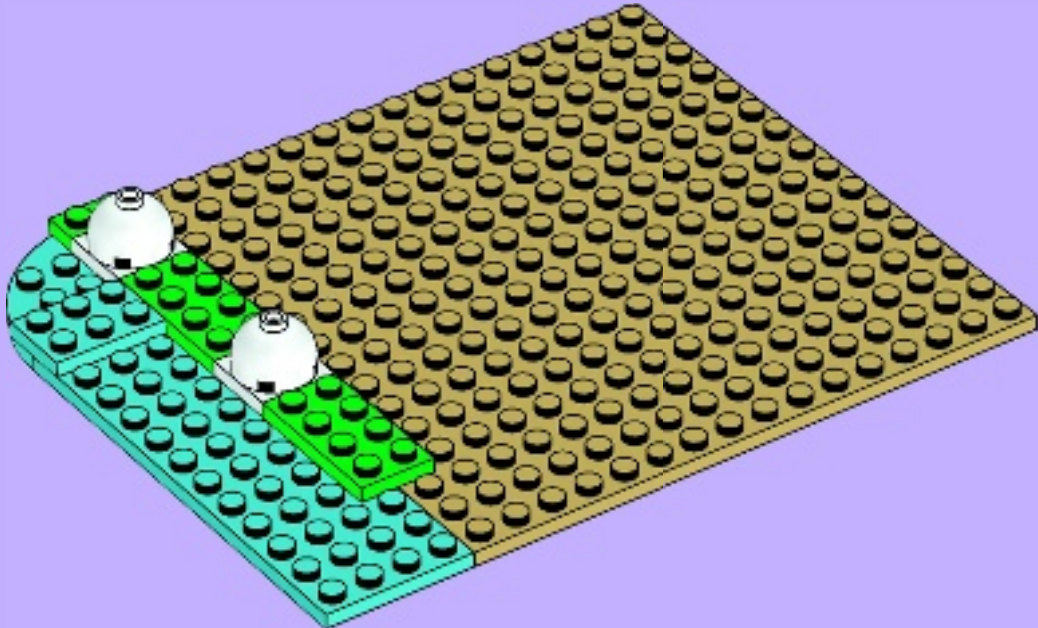

6

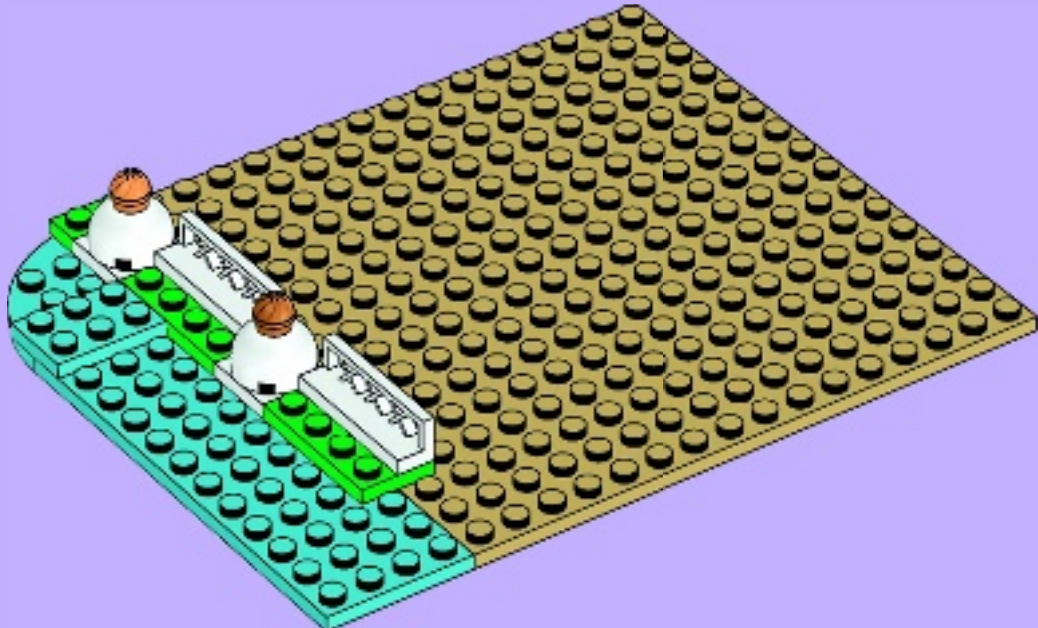



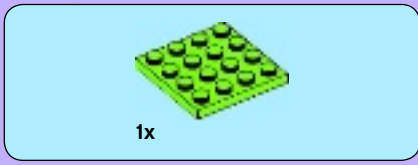

7

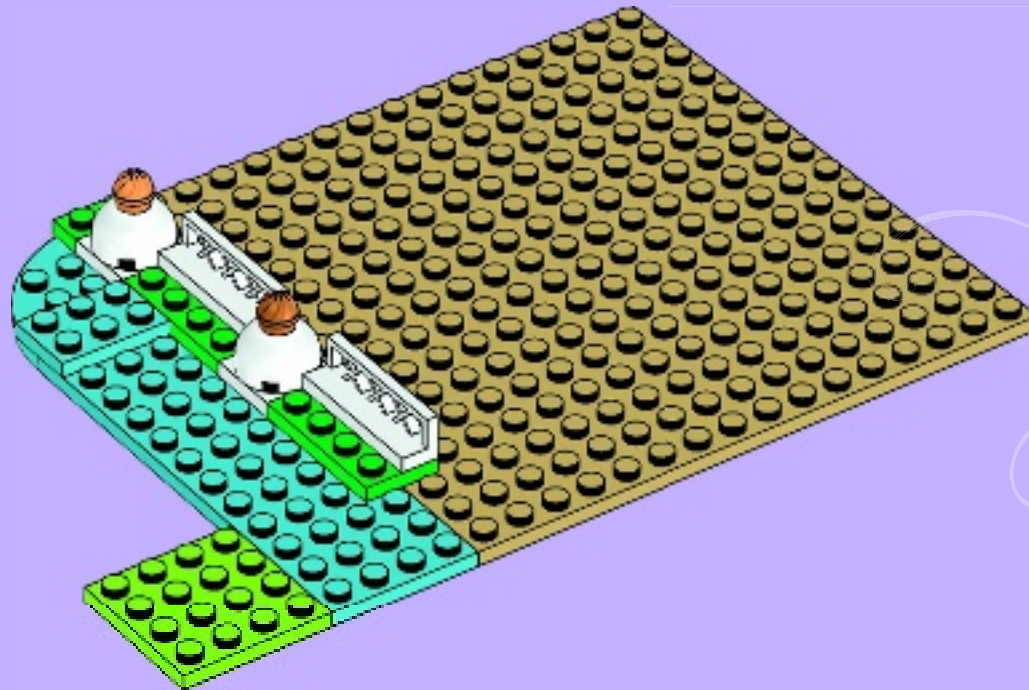

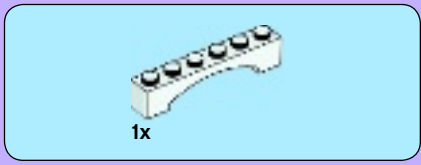

8

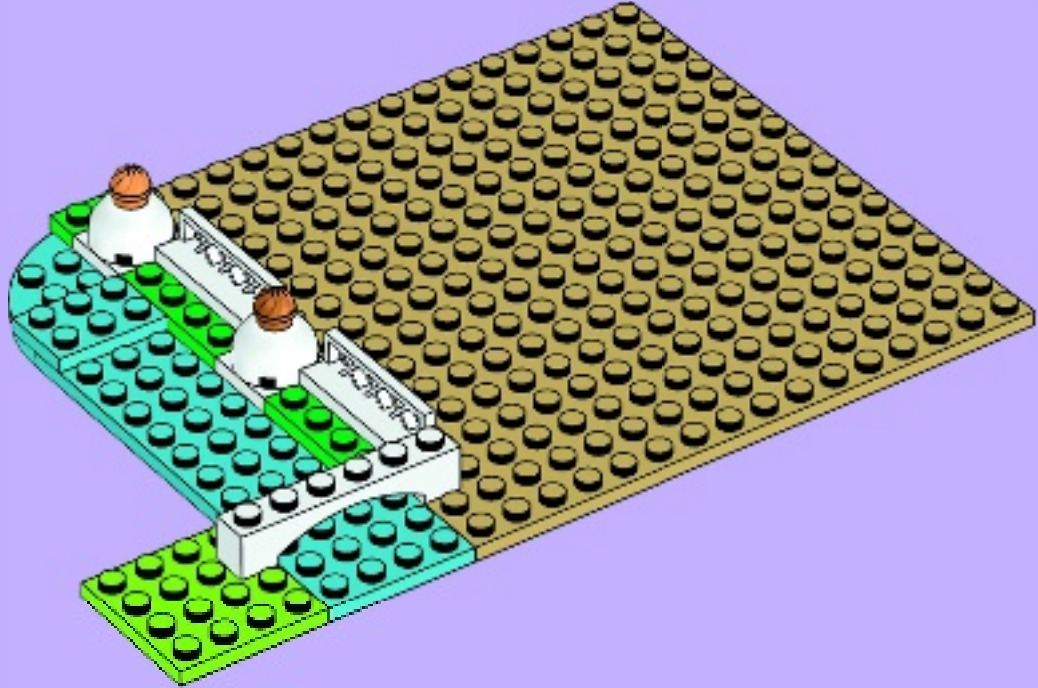

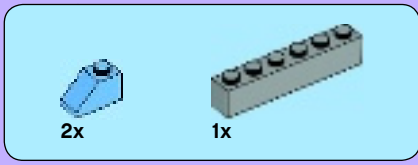

9

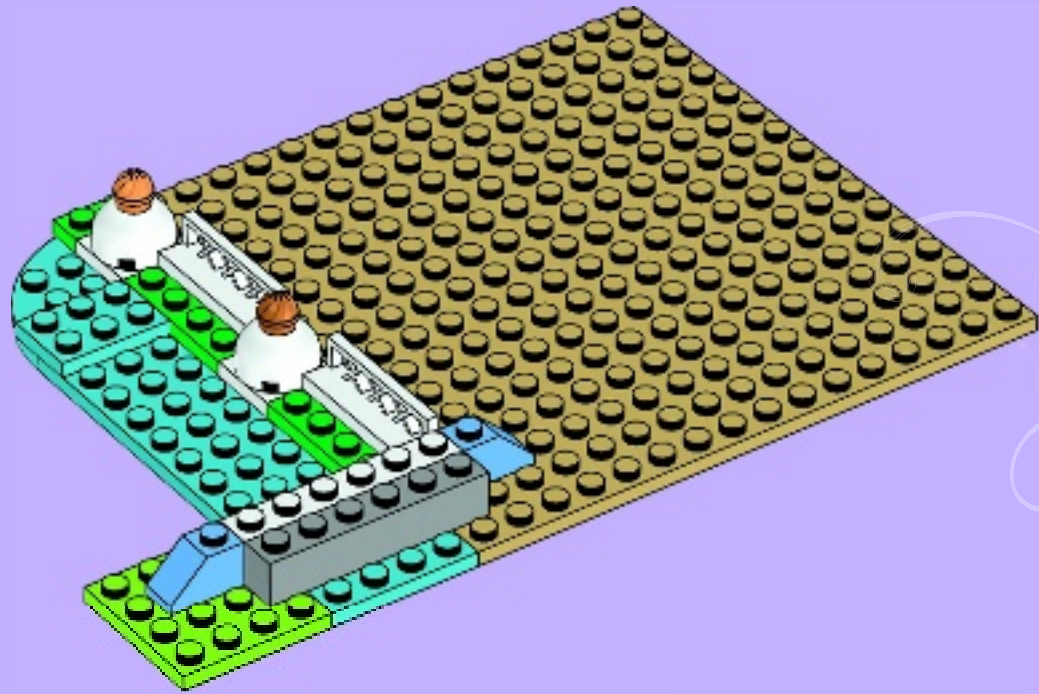

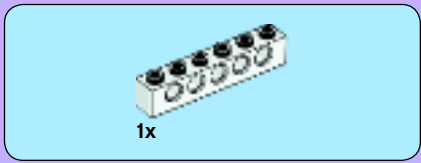

10

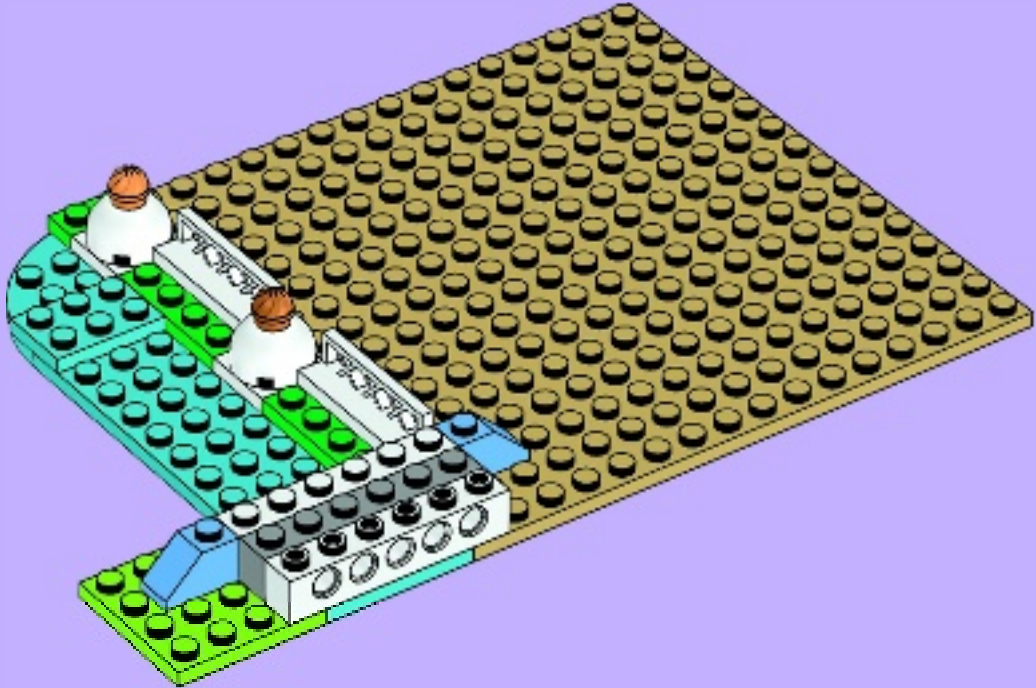





11

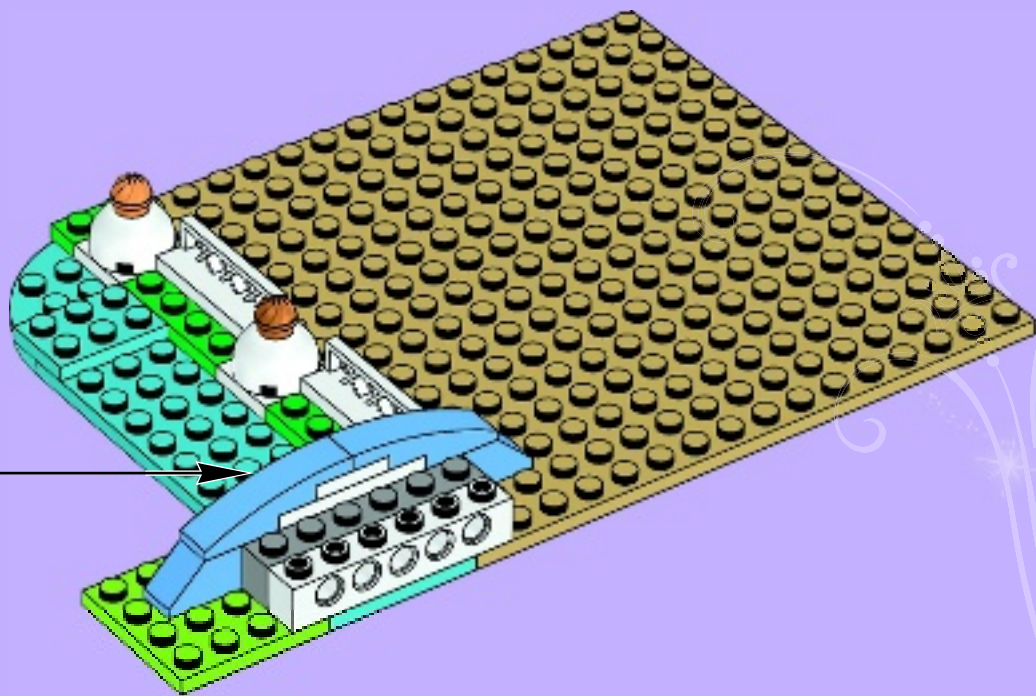
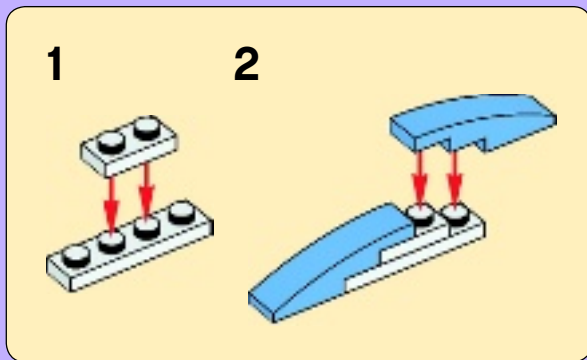

12

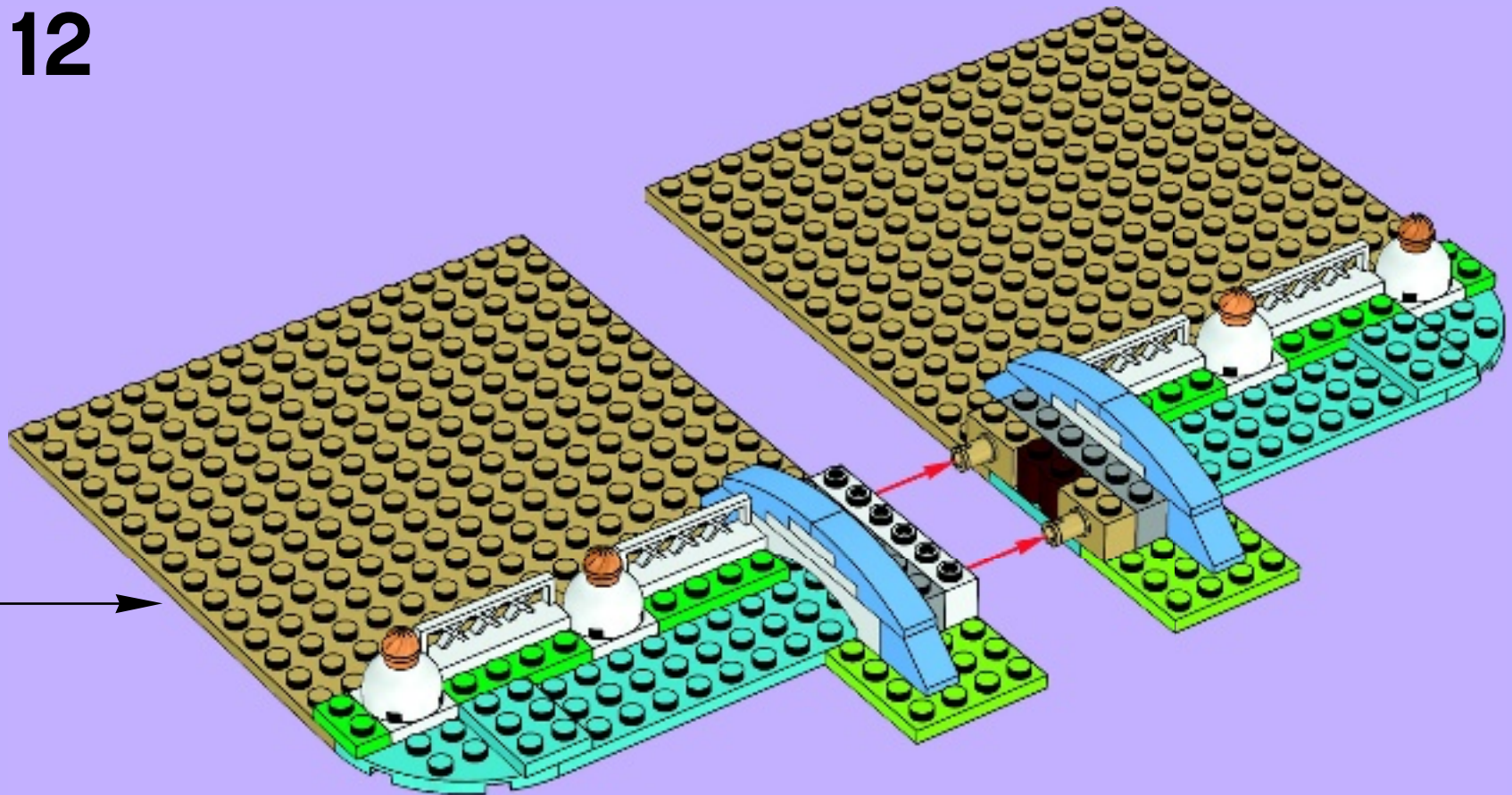

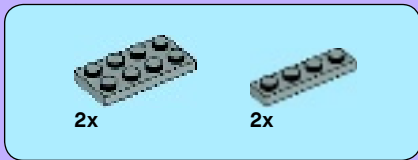

13

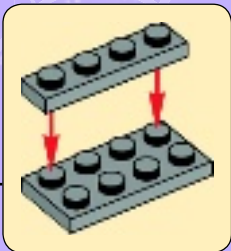
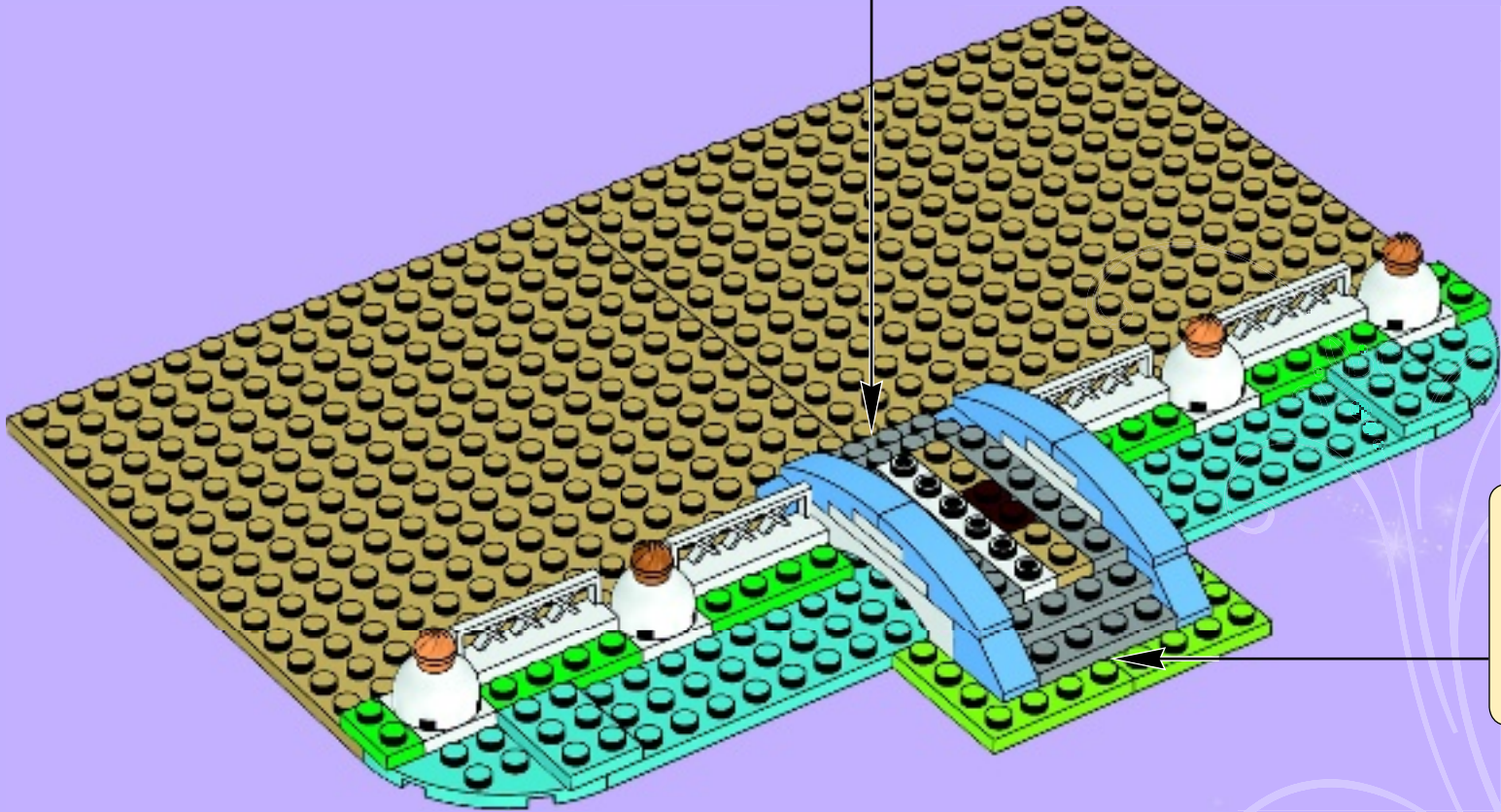
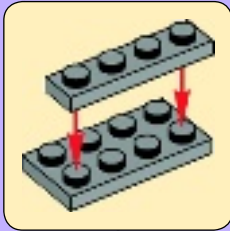



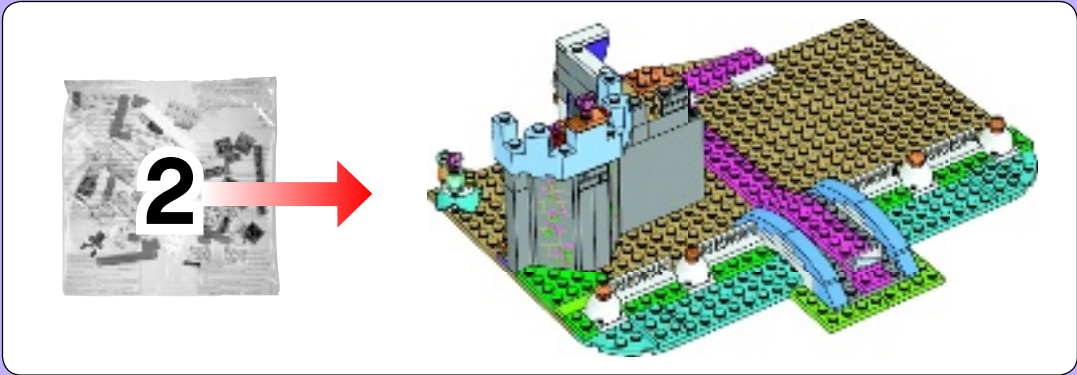

14

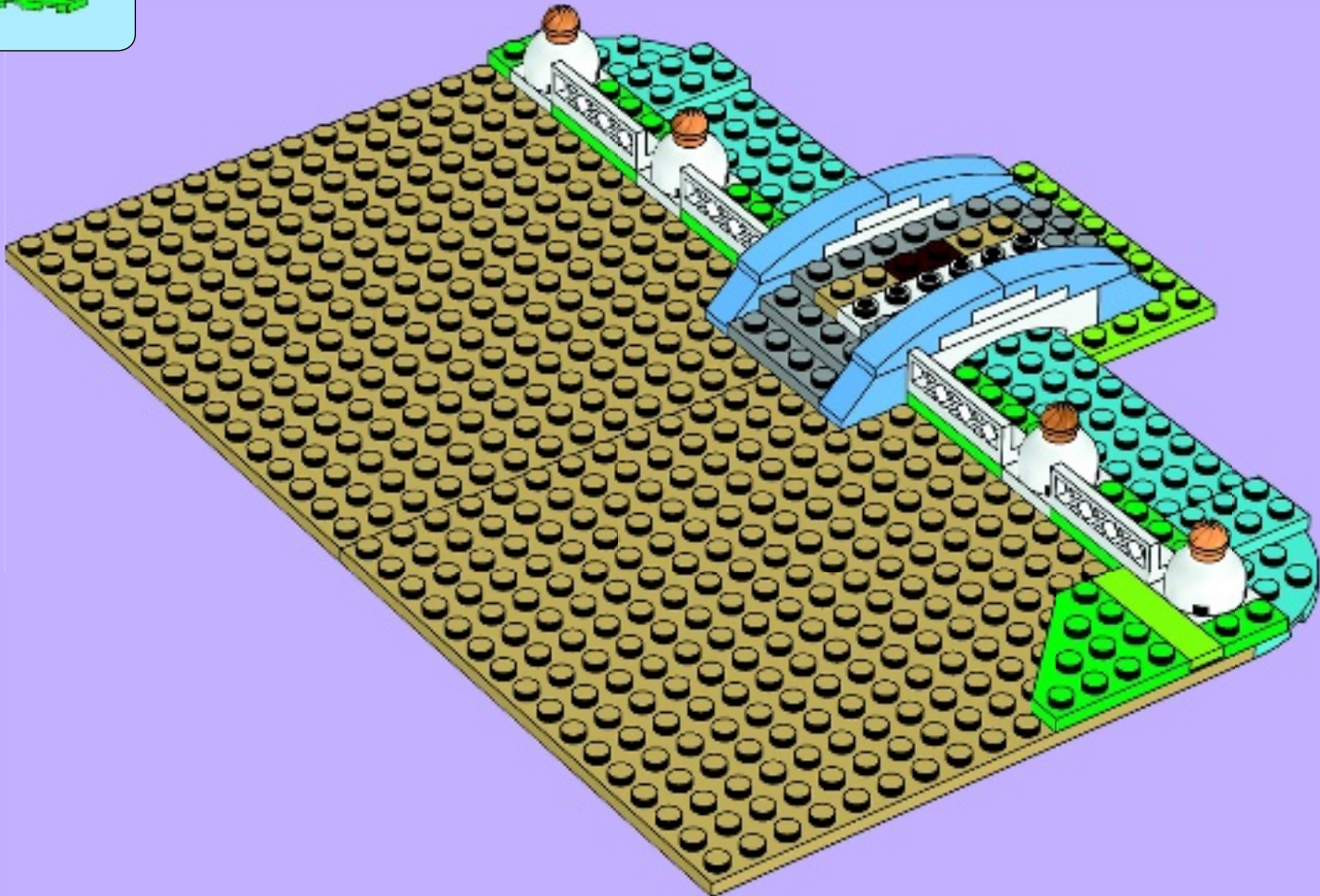



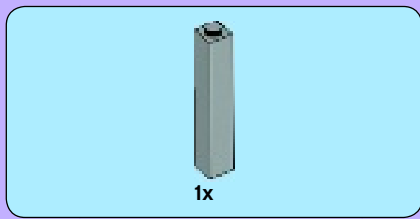

15

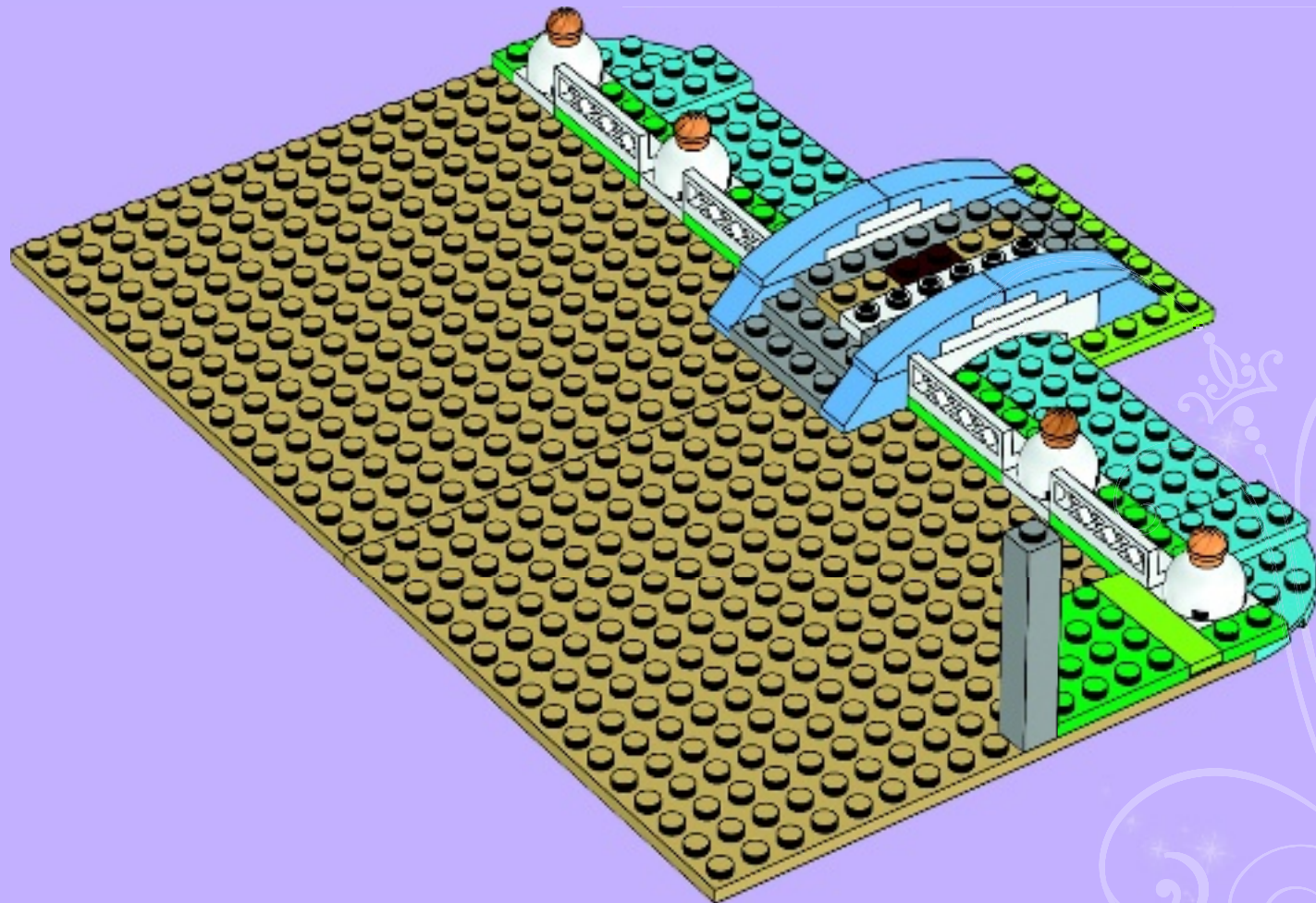

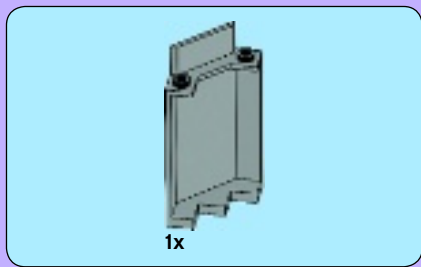

16

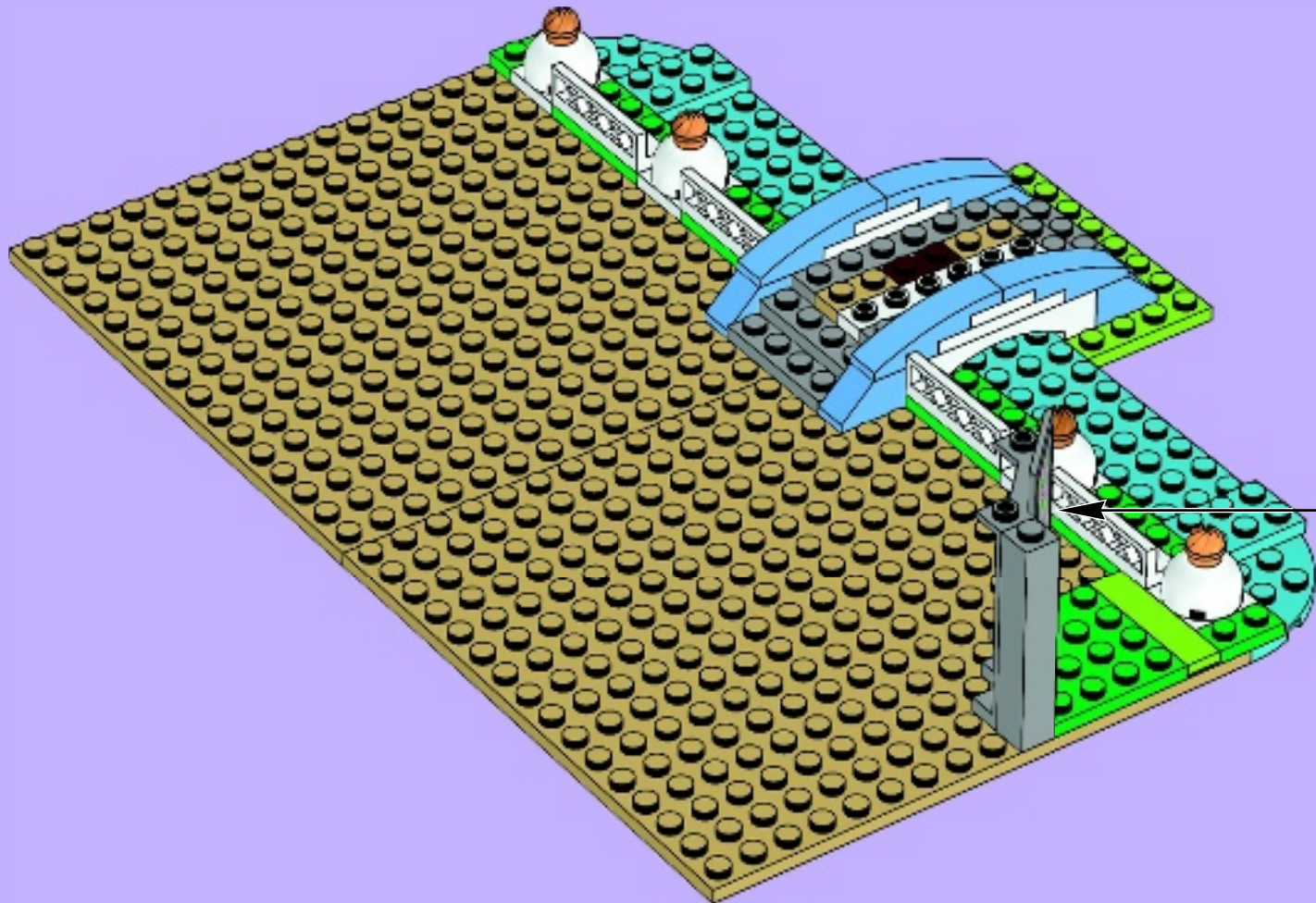
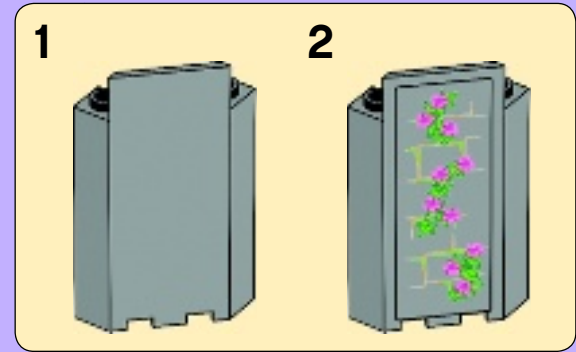



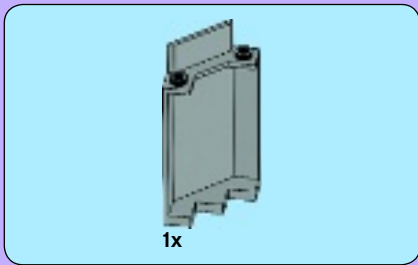

17

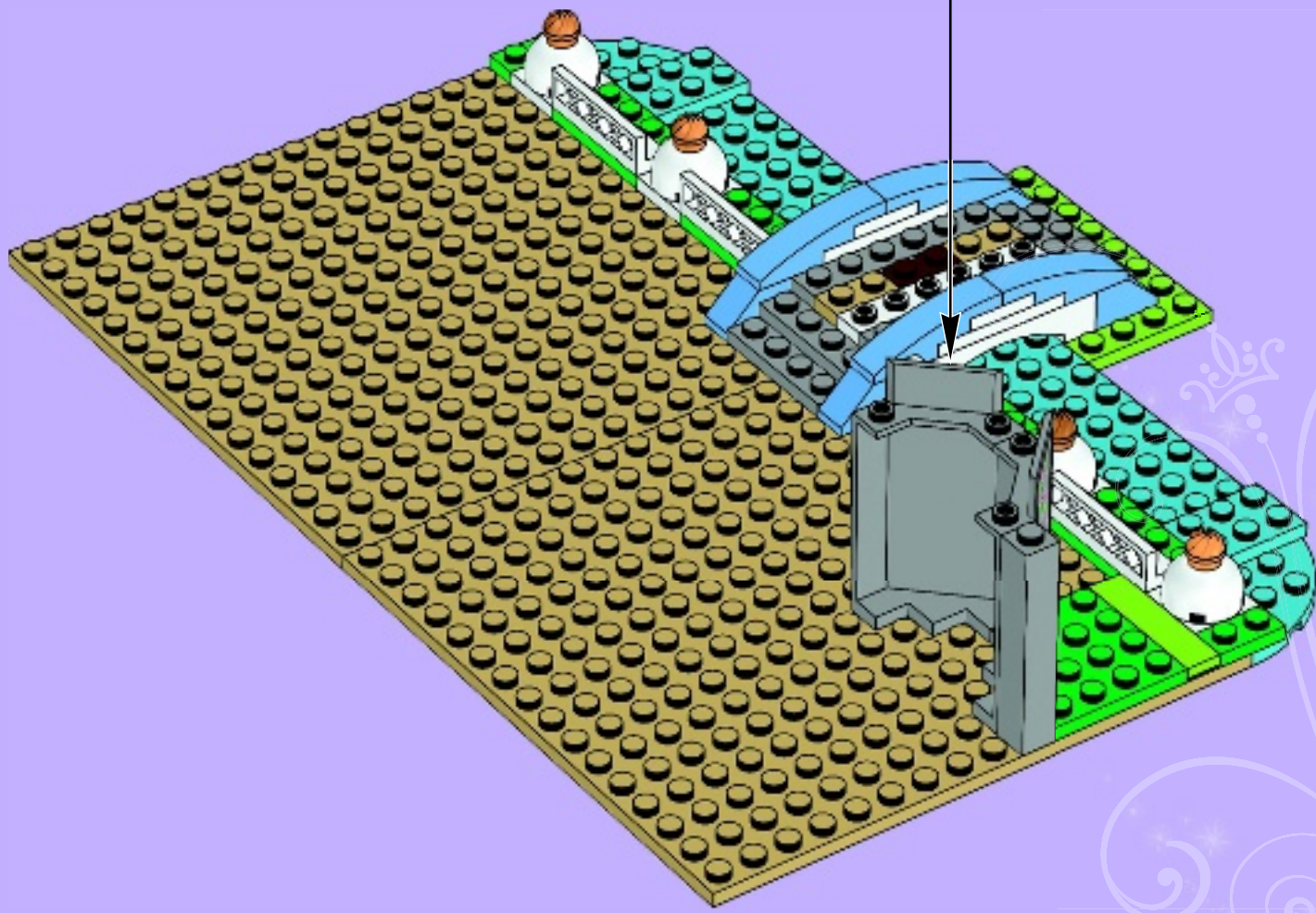
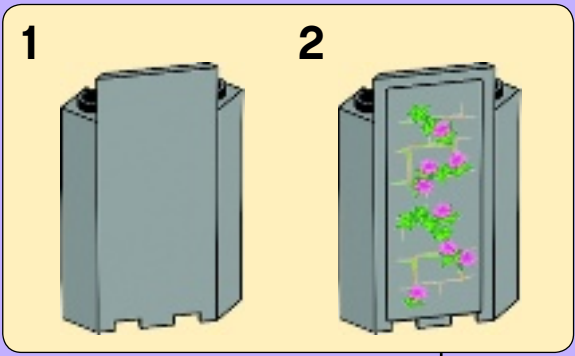

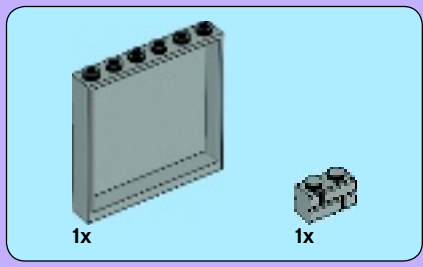

18

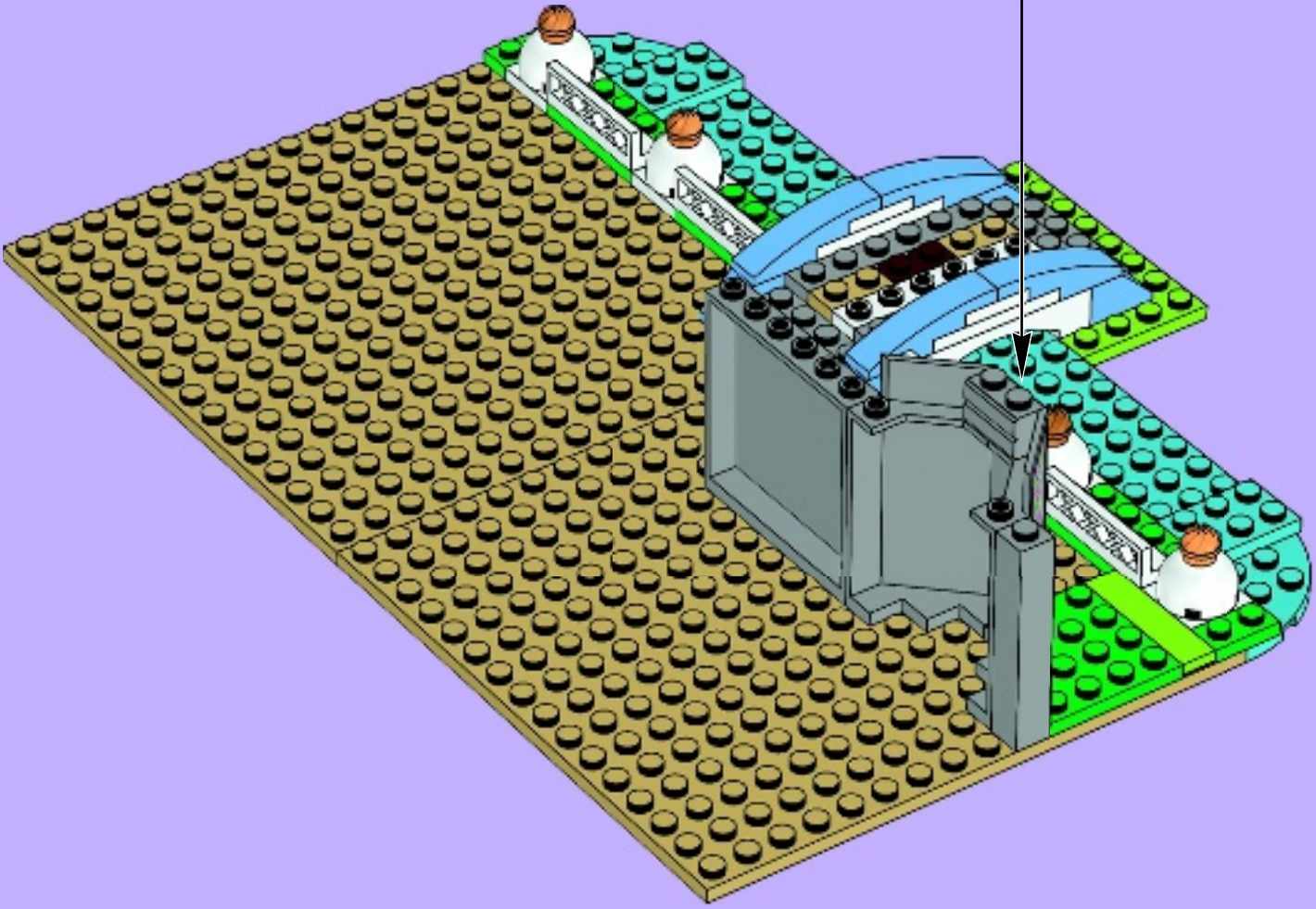





# 19

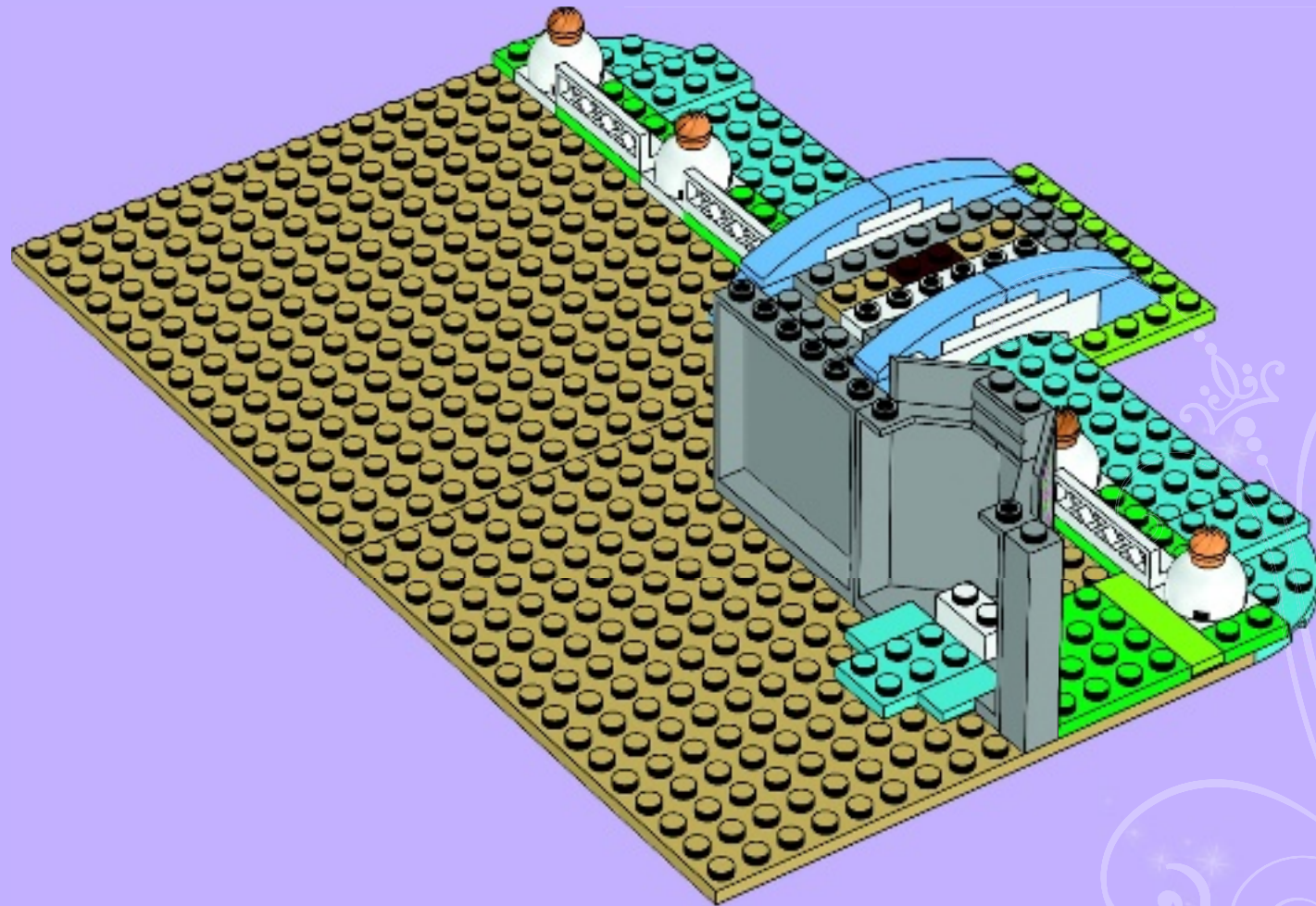

1x



# 20

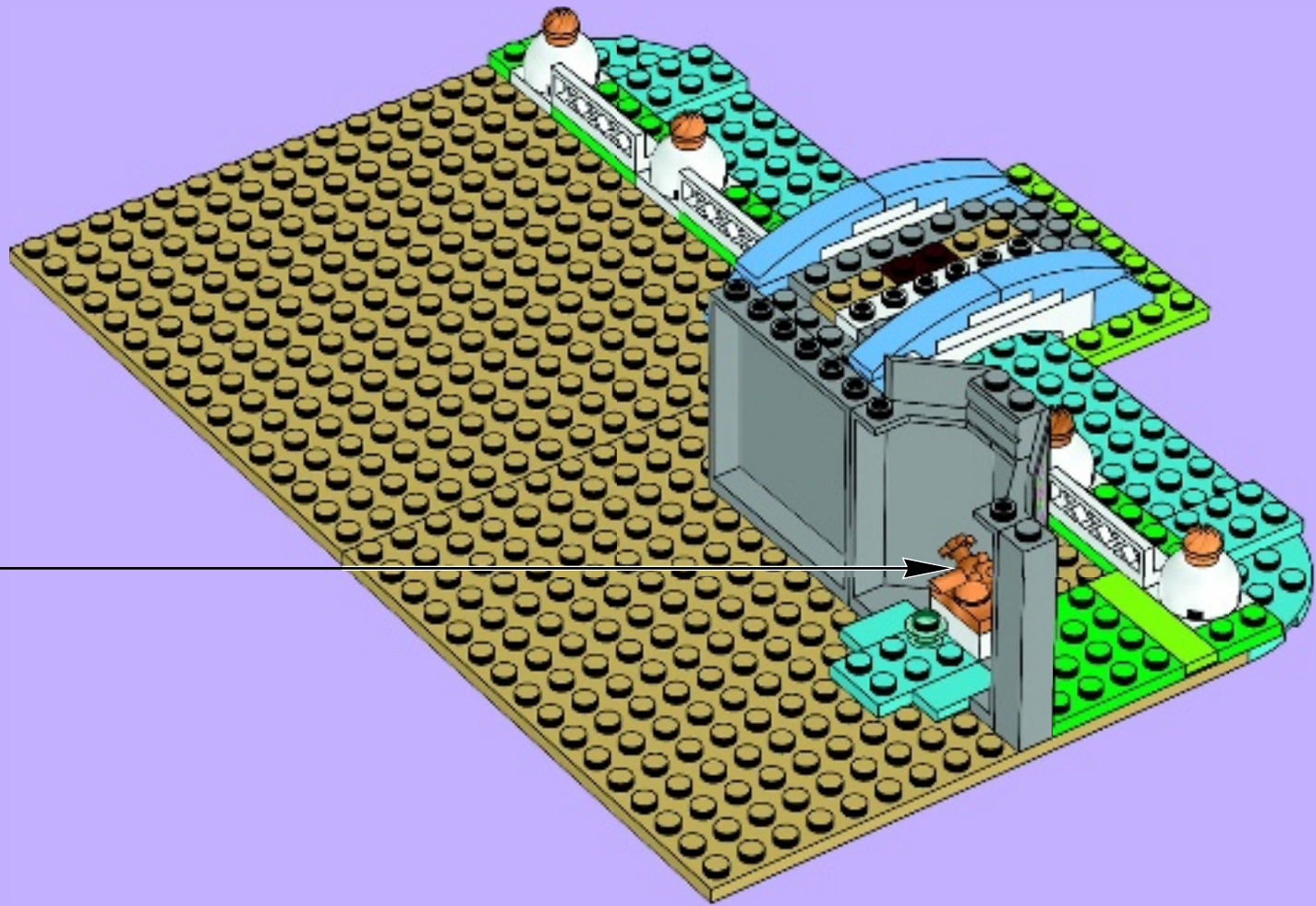







1x



1x



2x

# 22

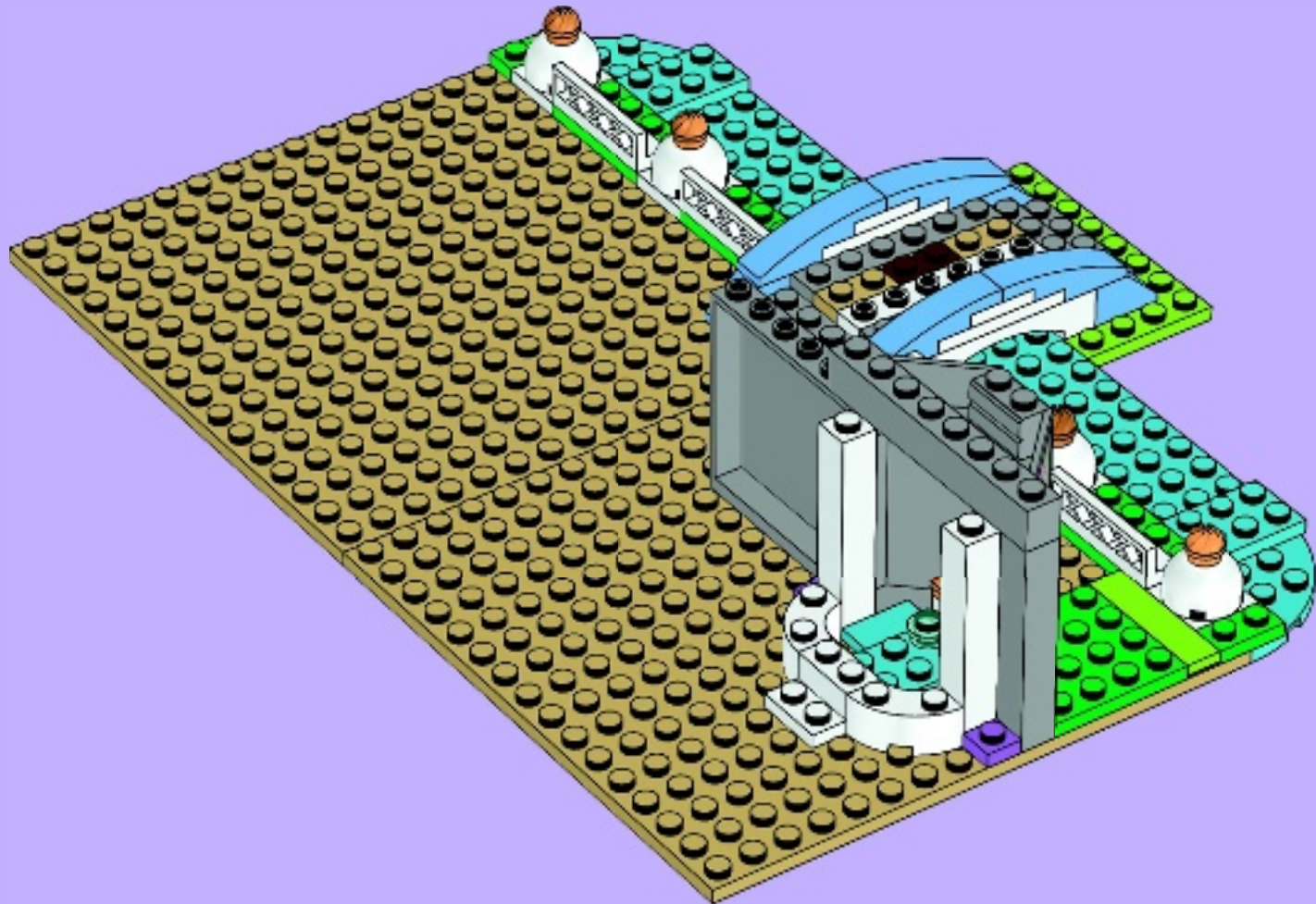



- 1x 
- 1x 
- 1x 
- 1x 

# 23

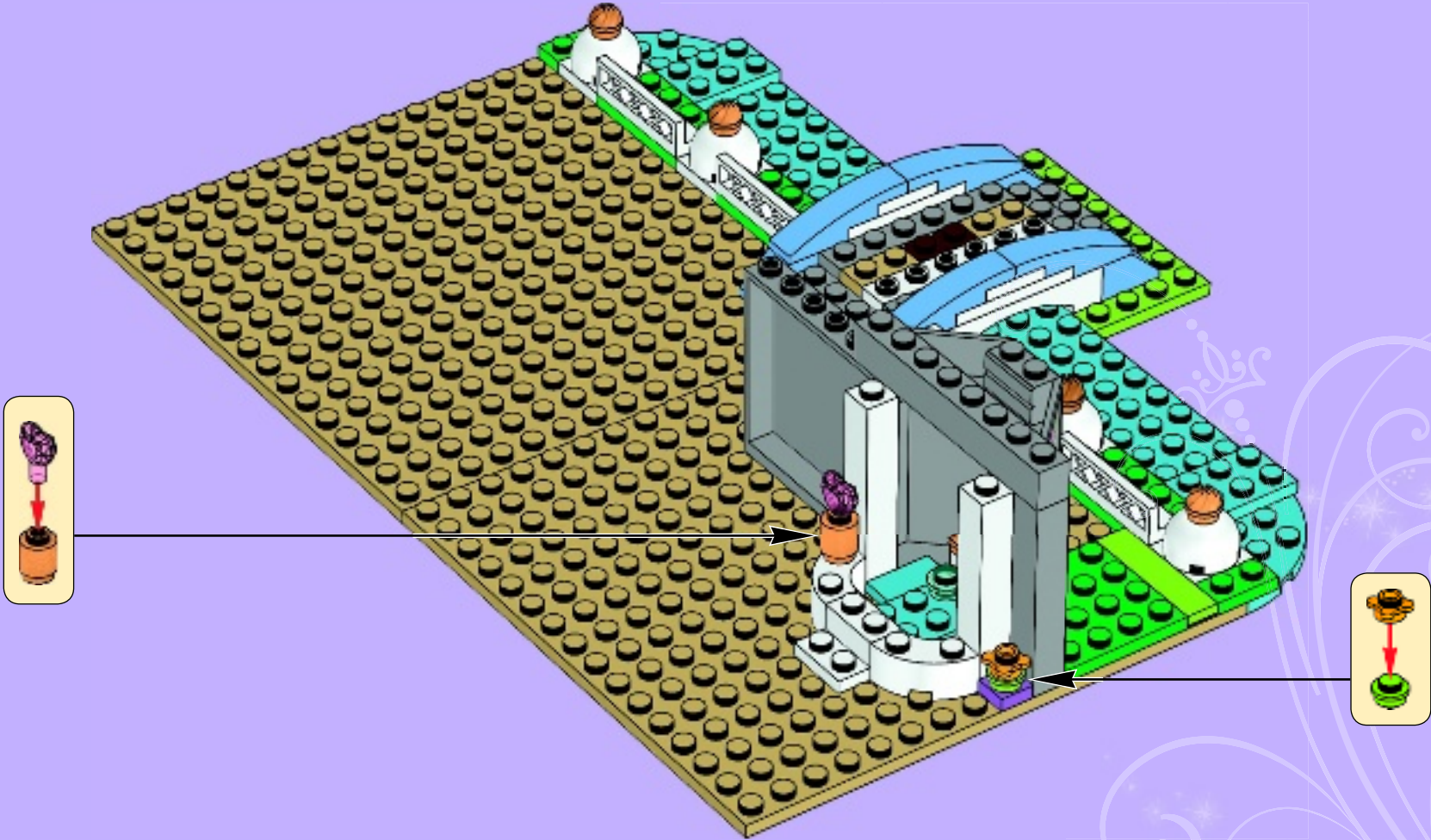

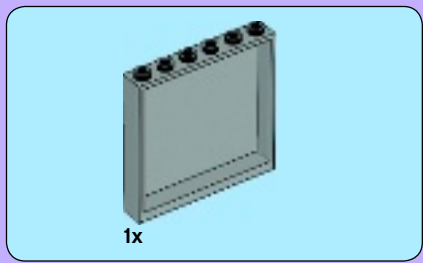

24

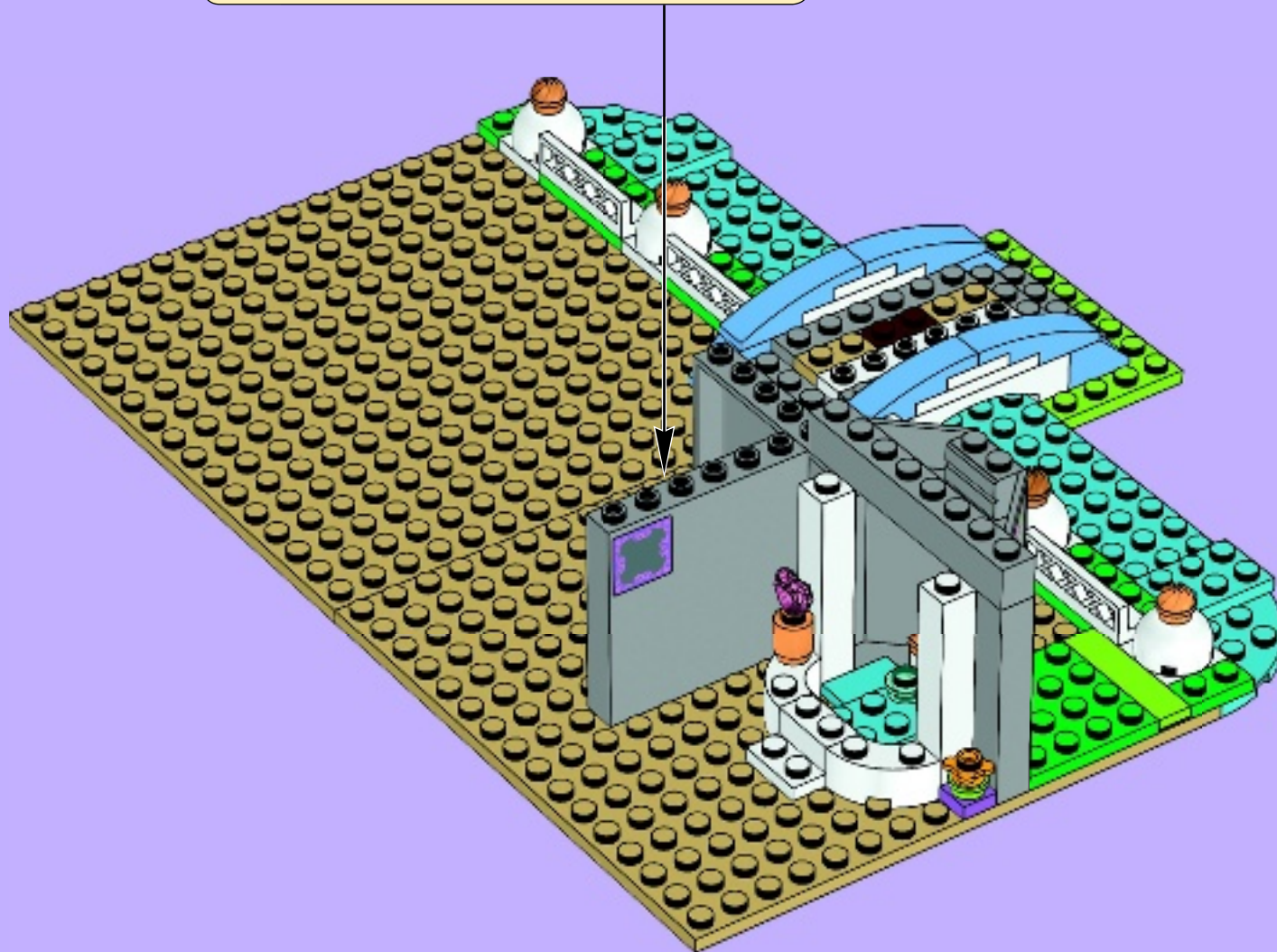
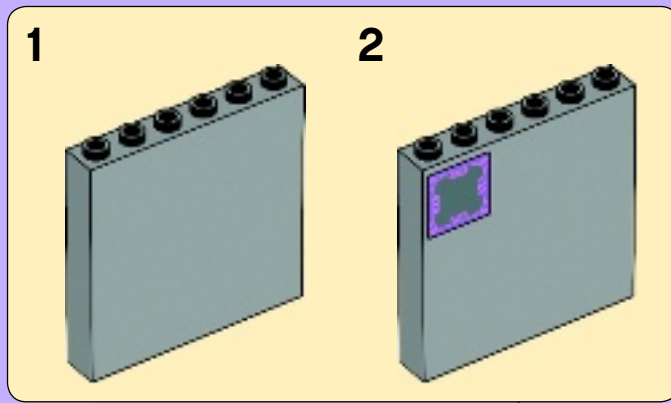



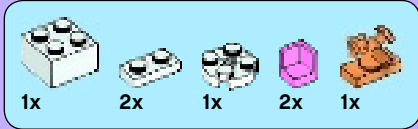

25

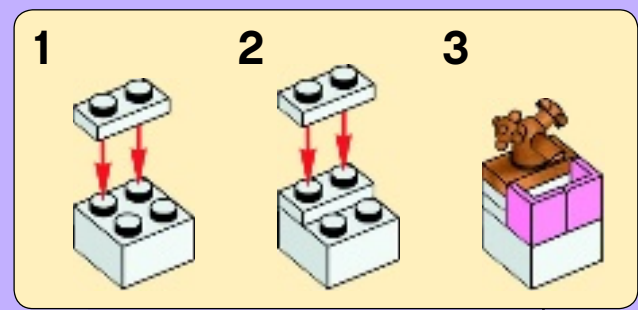



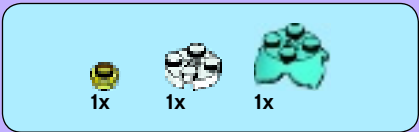

# 26

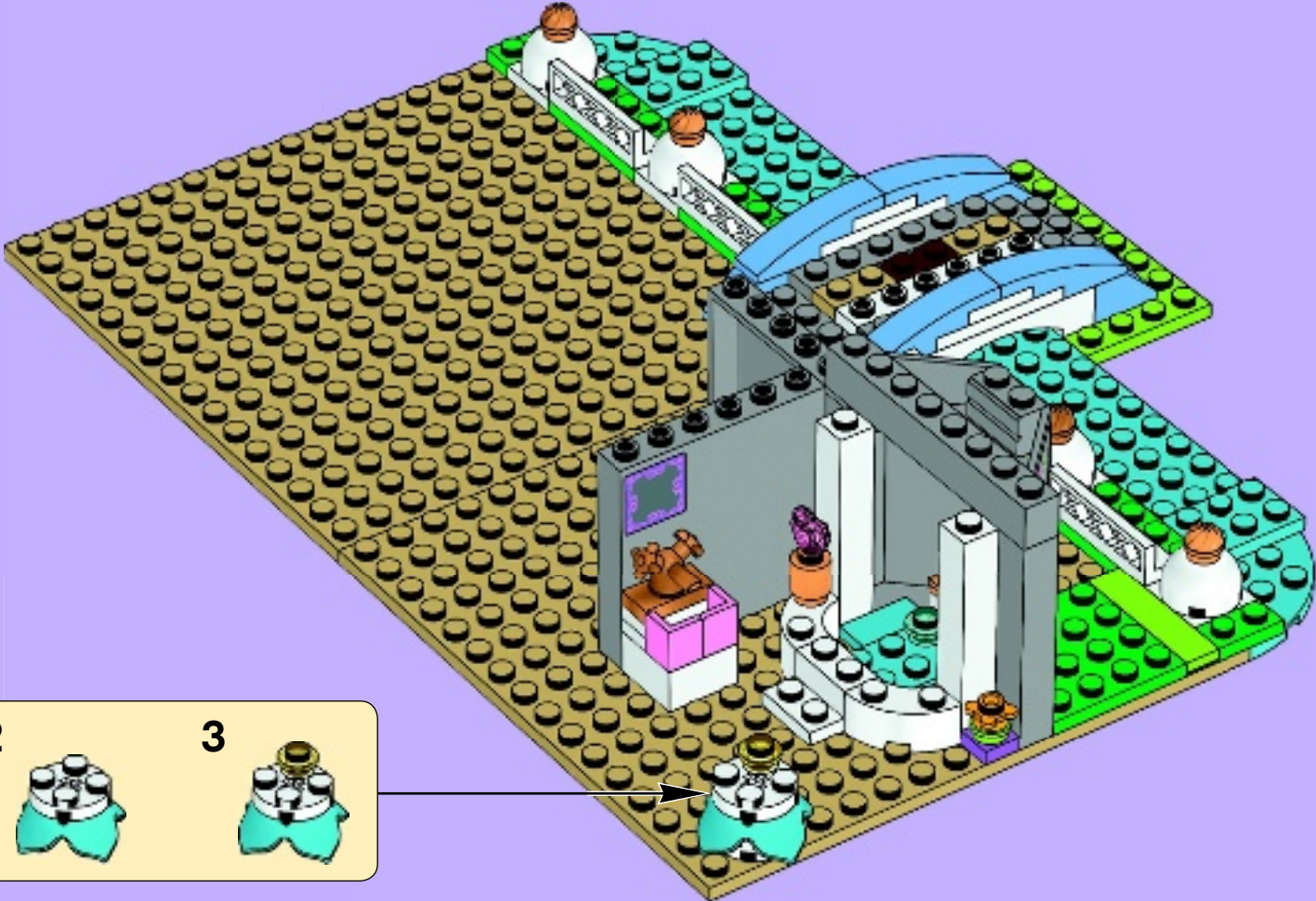

			
1x	1x	1x	1x

# 27





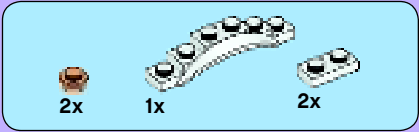

28

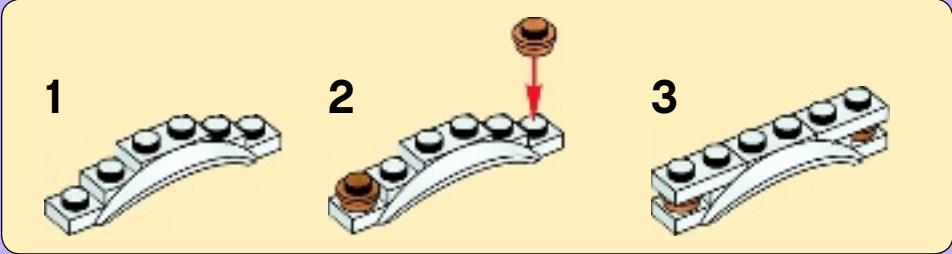



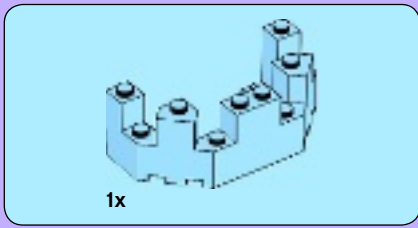

29



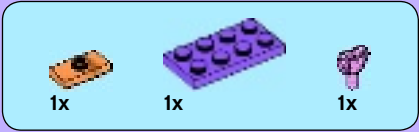

30







31

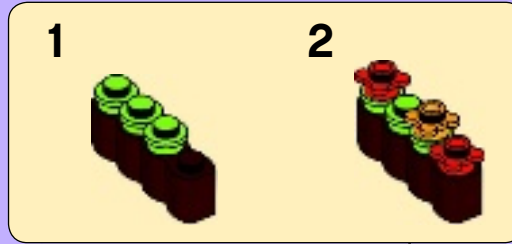



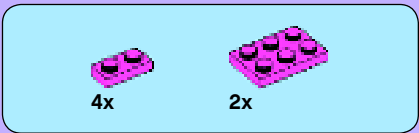

# 32

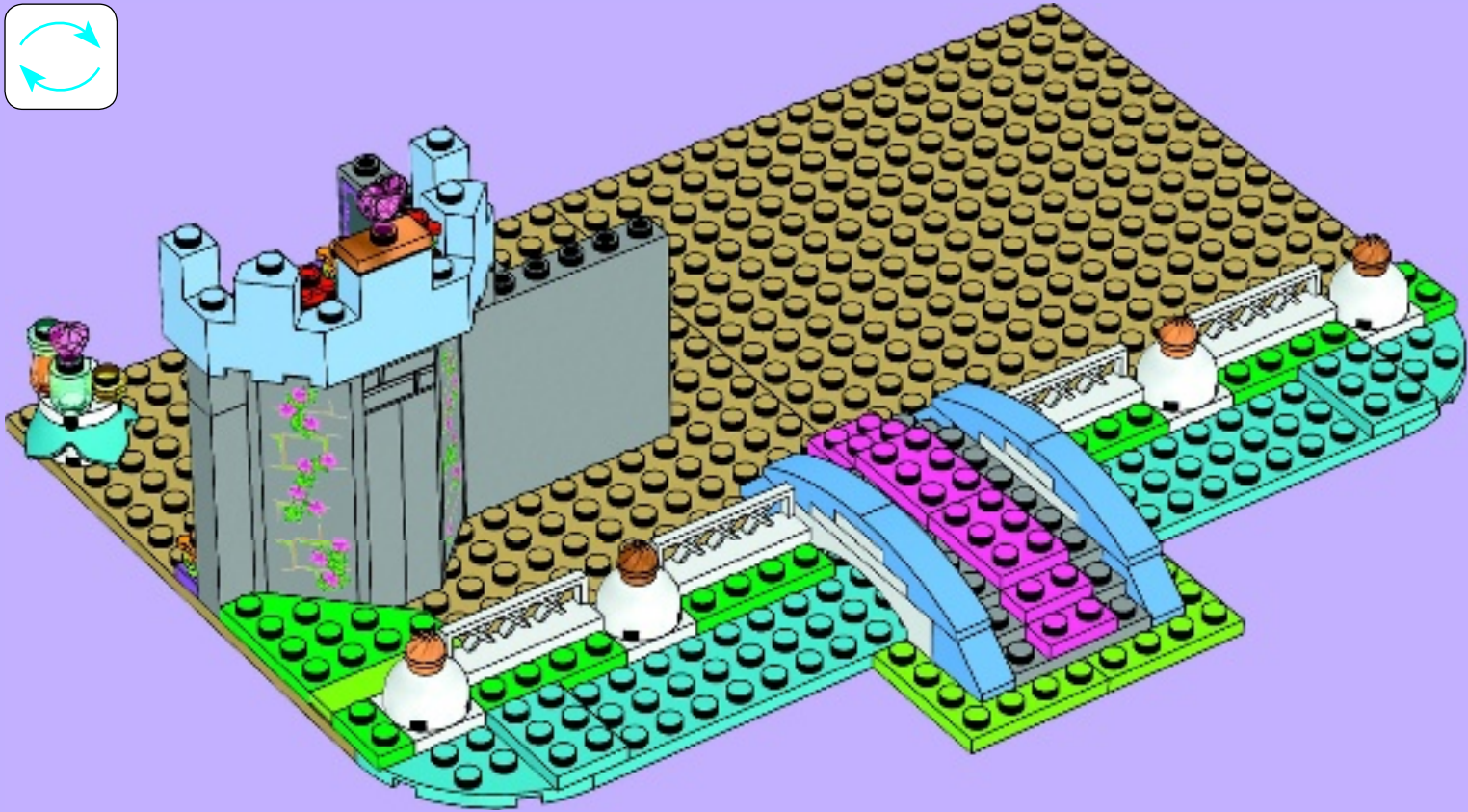
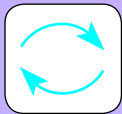



1x

# 33

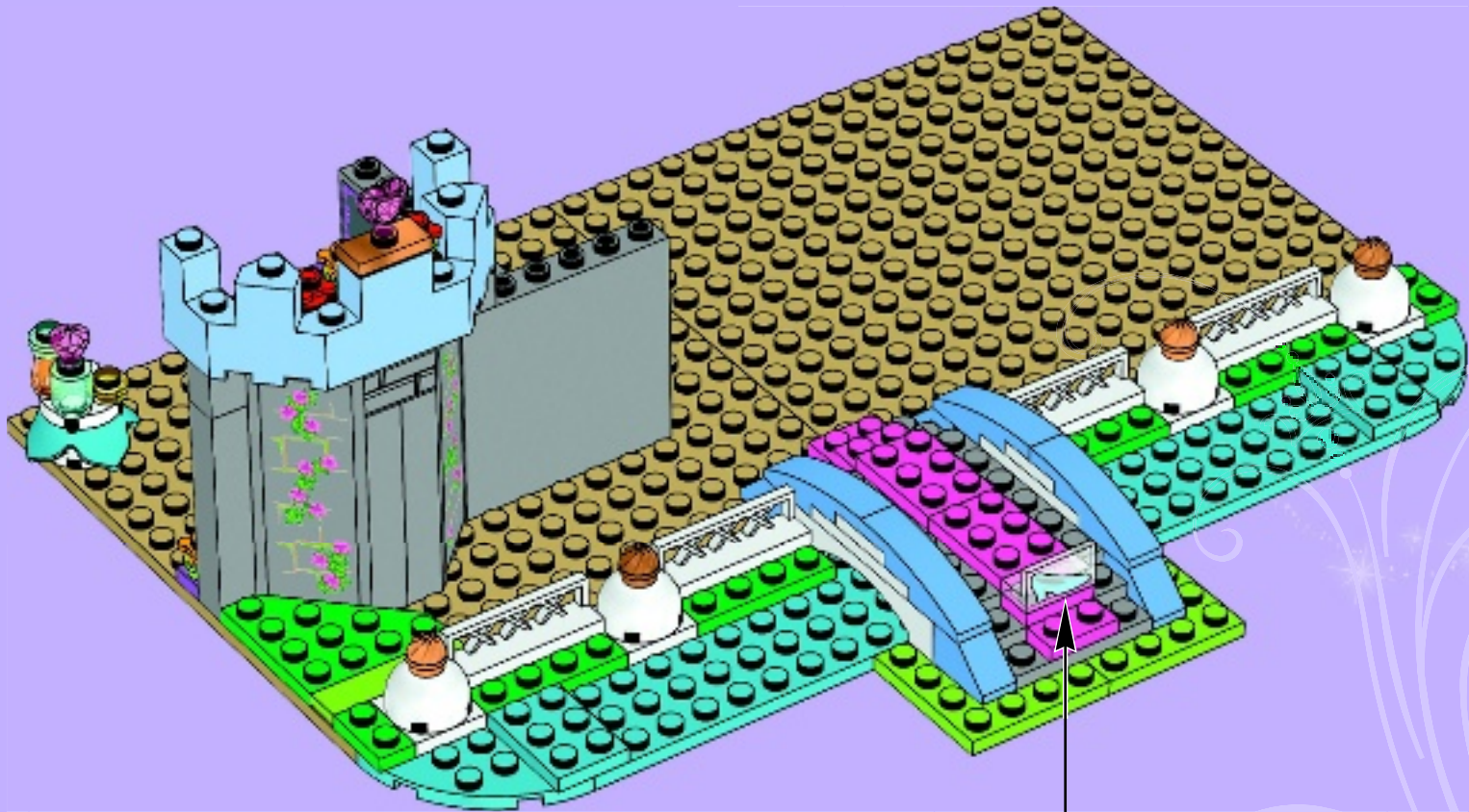

1



2





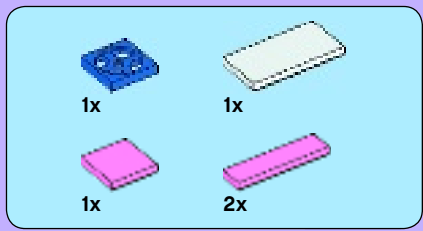

# 34

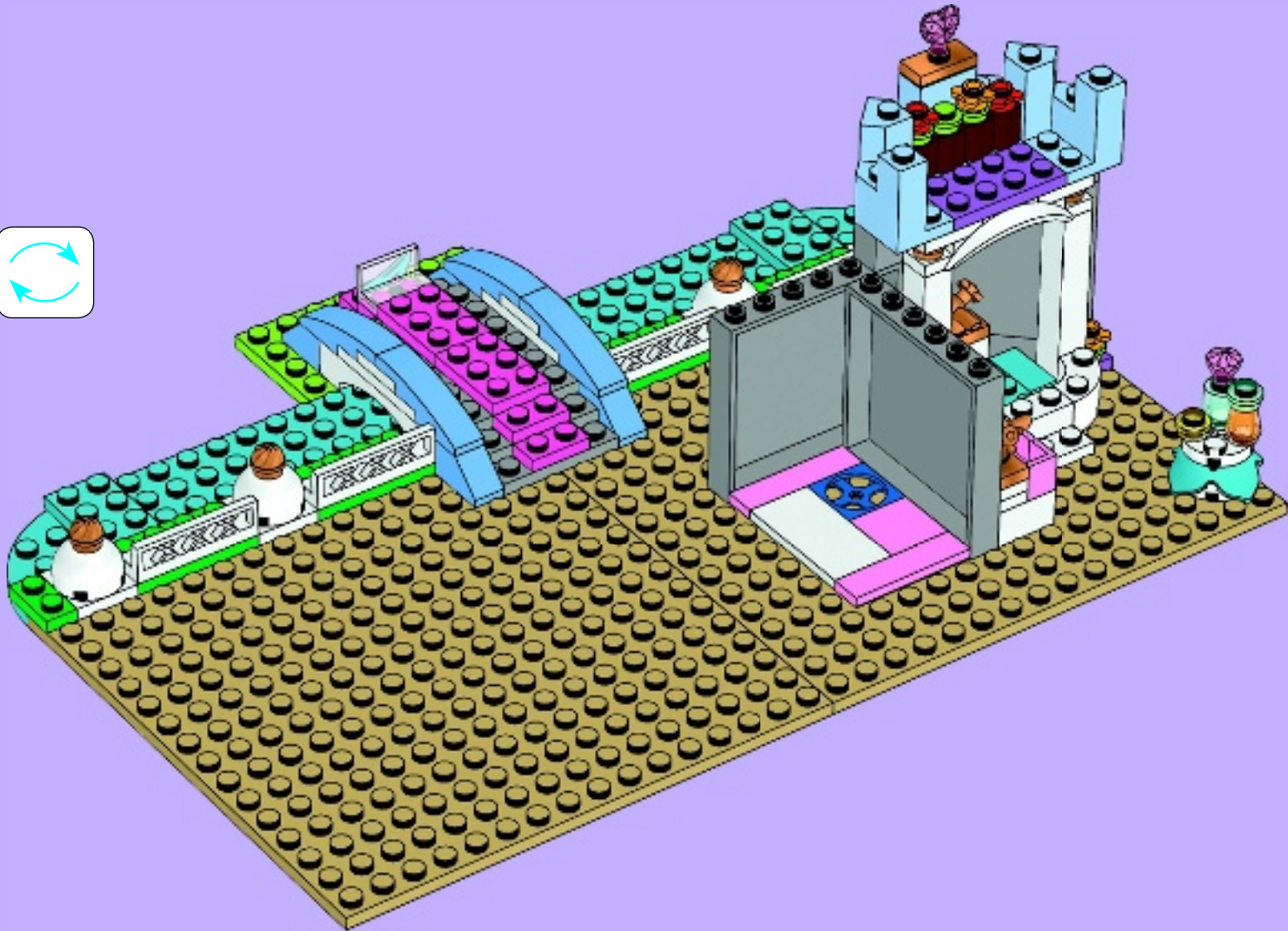





# 35

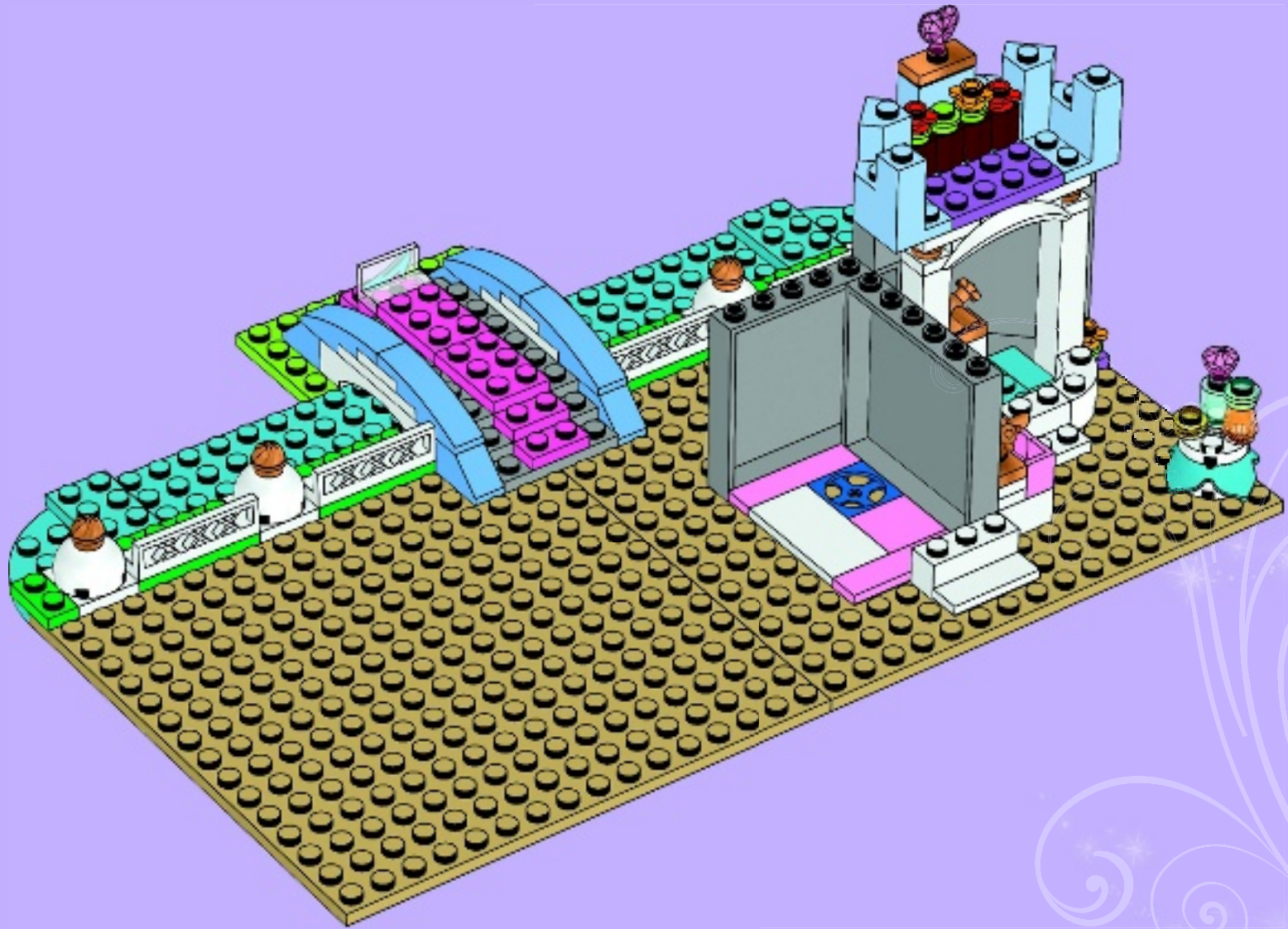

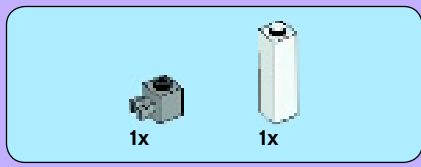

# 36

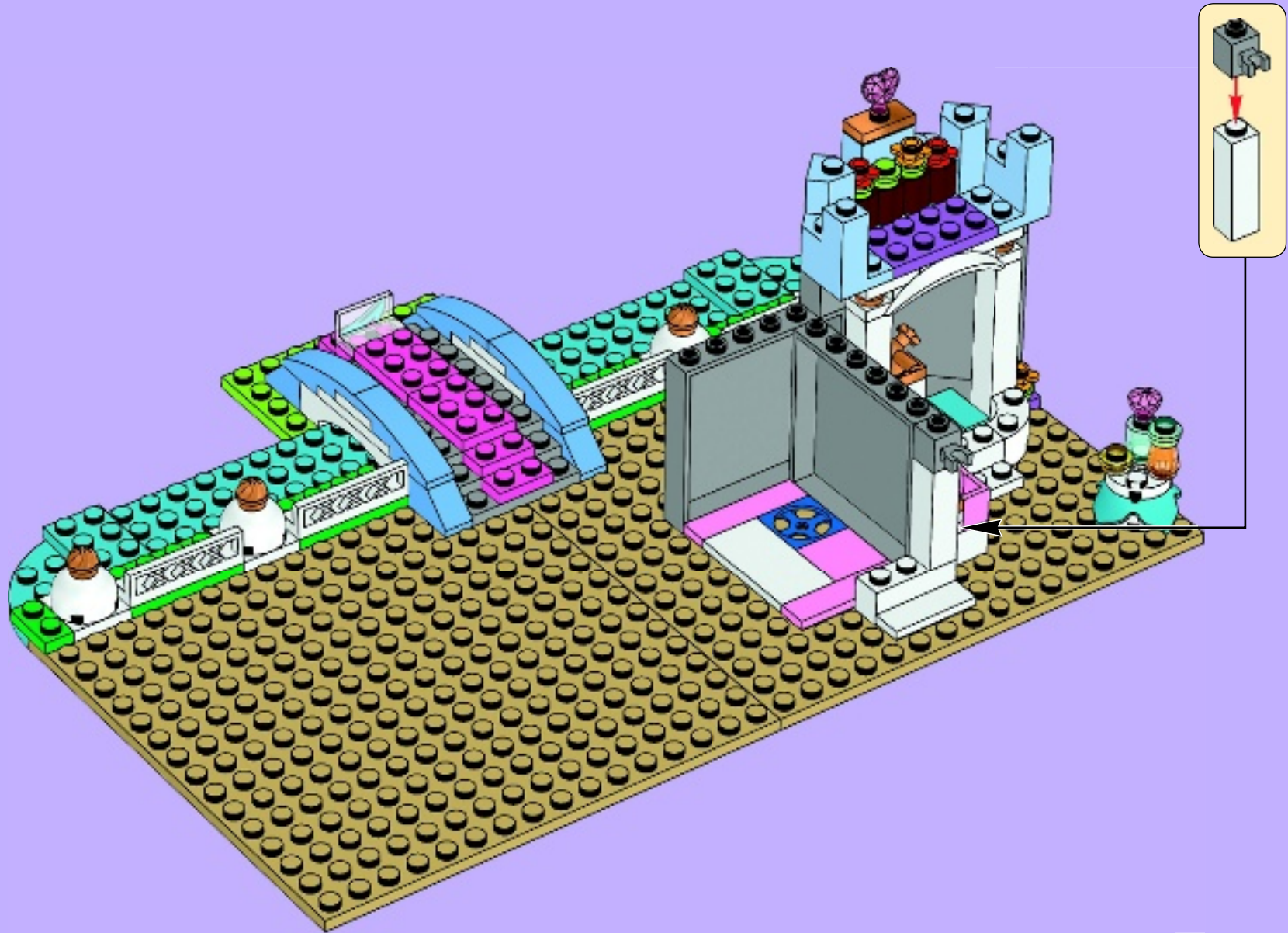



1



2



3

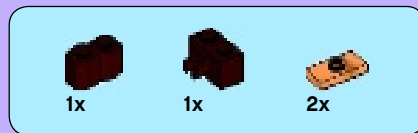

4

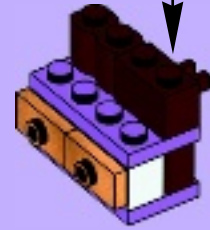

5

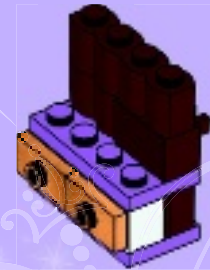

6

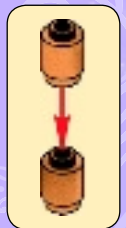





7

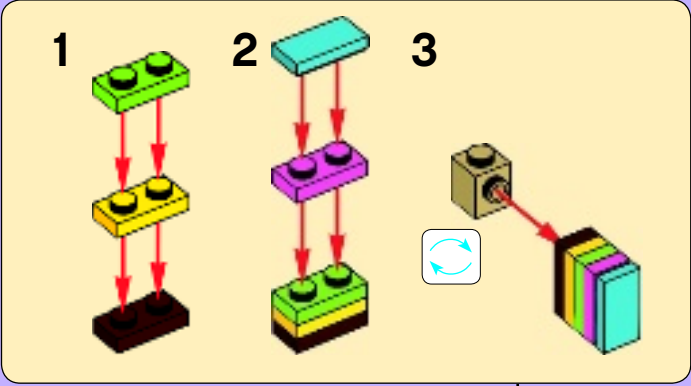

8

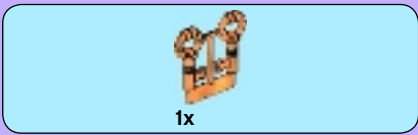

9

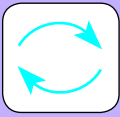

10

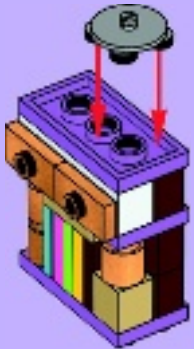
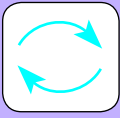

37

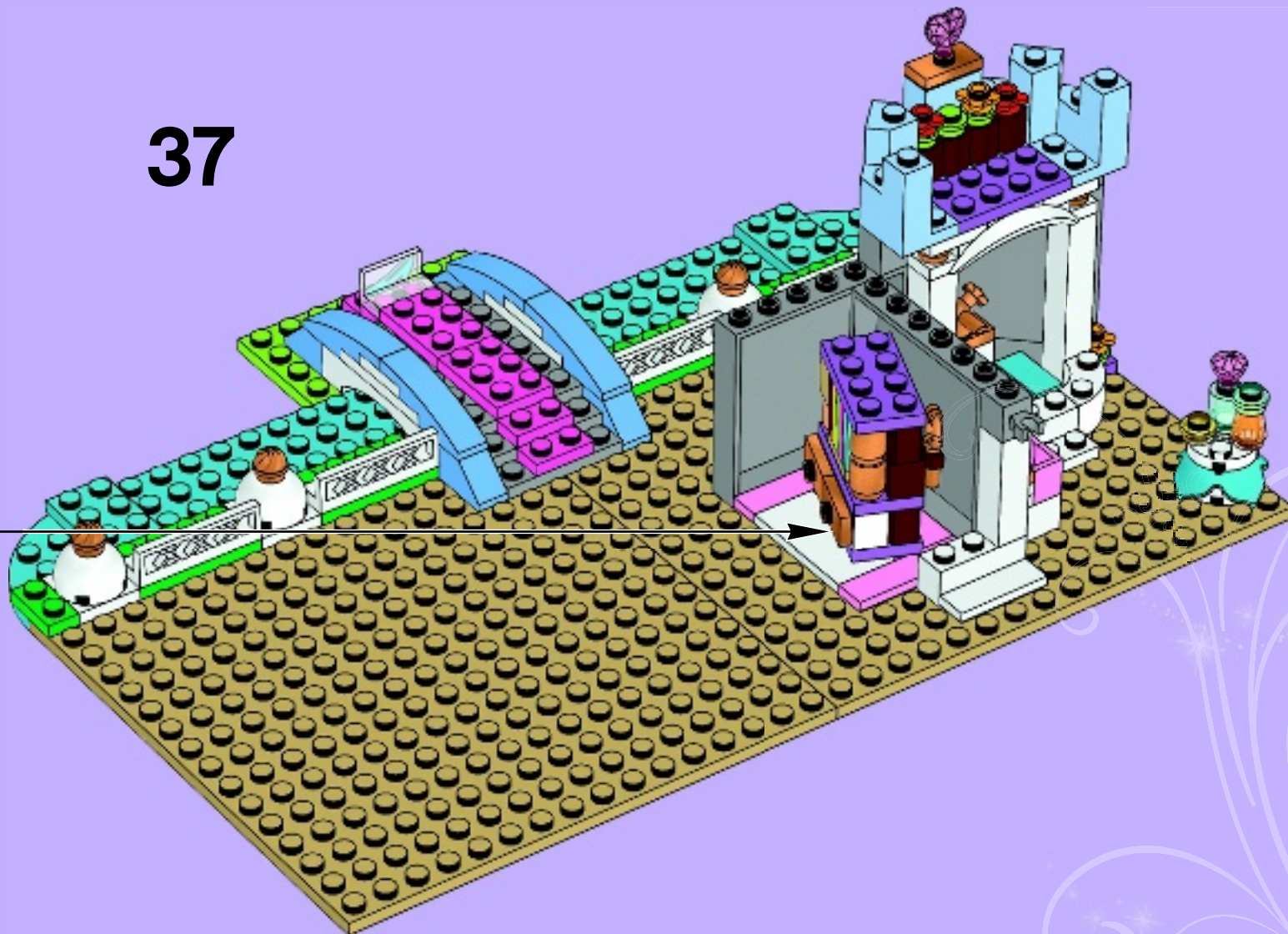

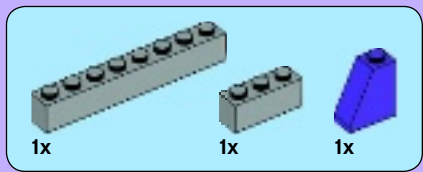

38

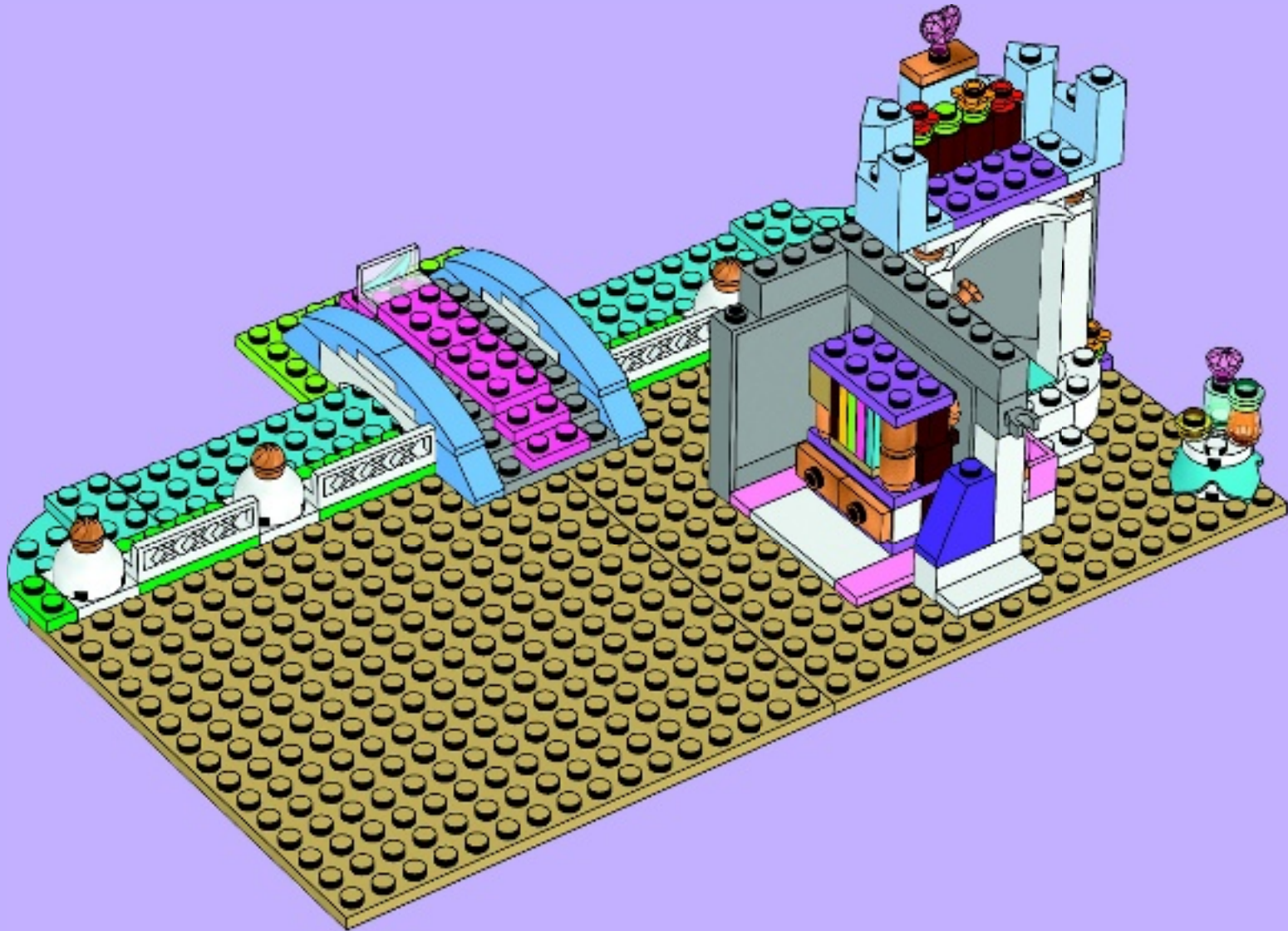



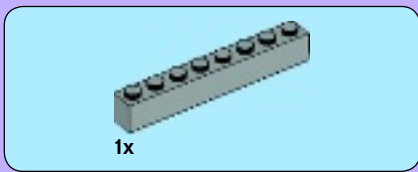

39

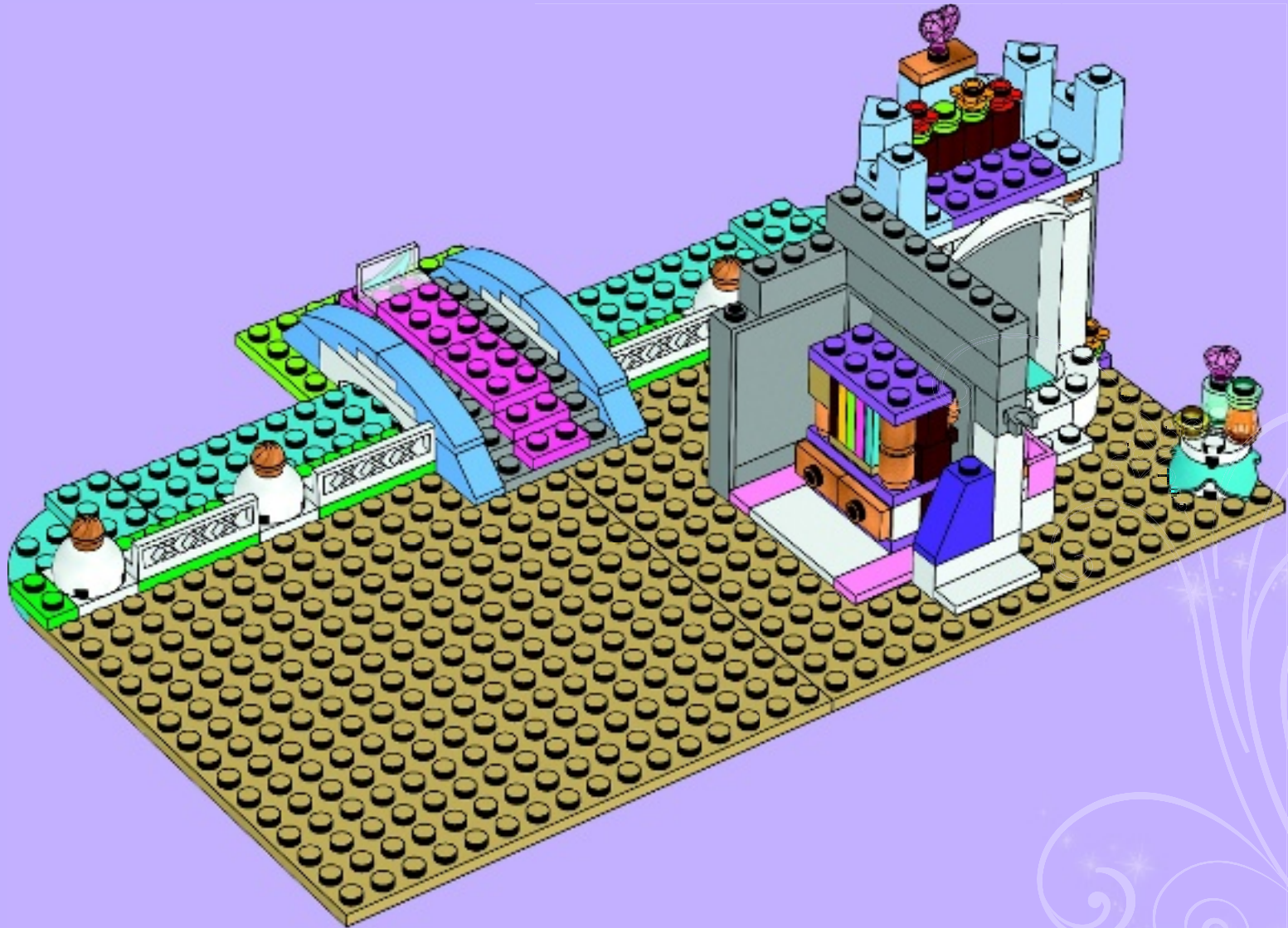



# 40

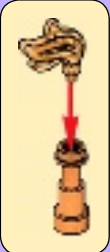
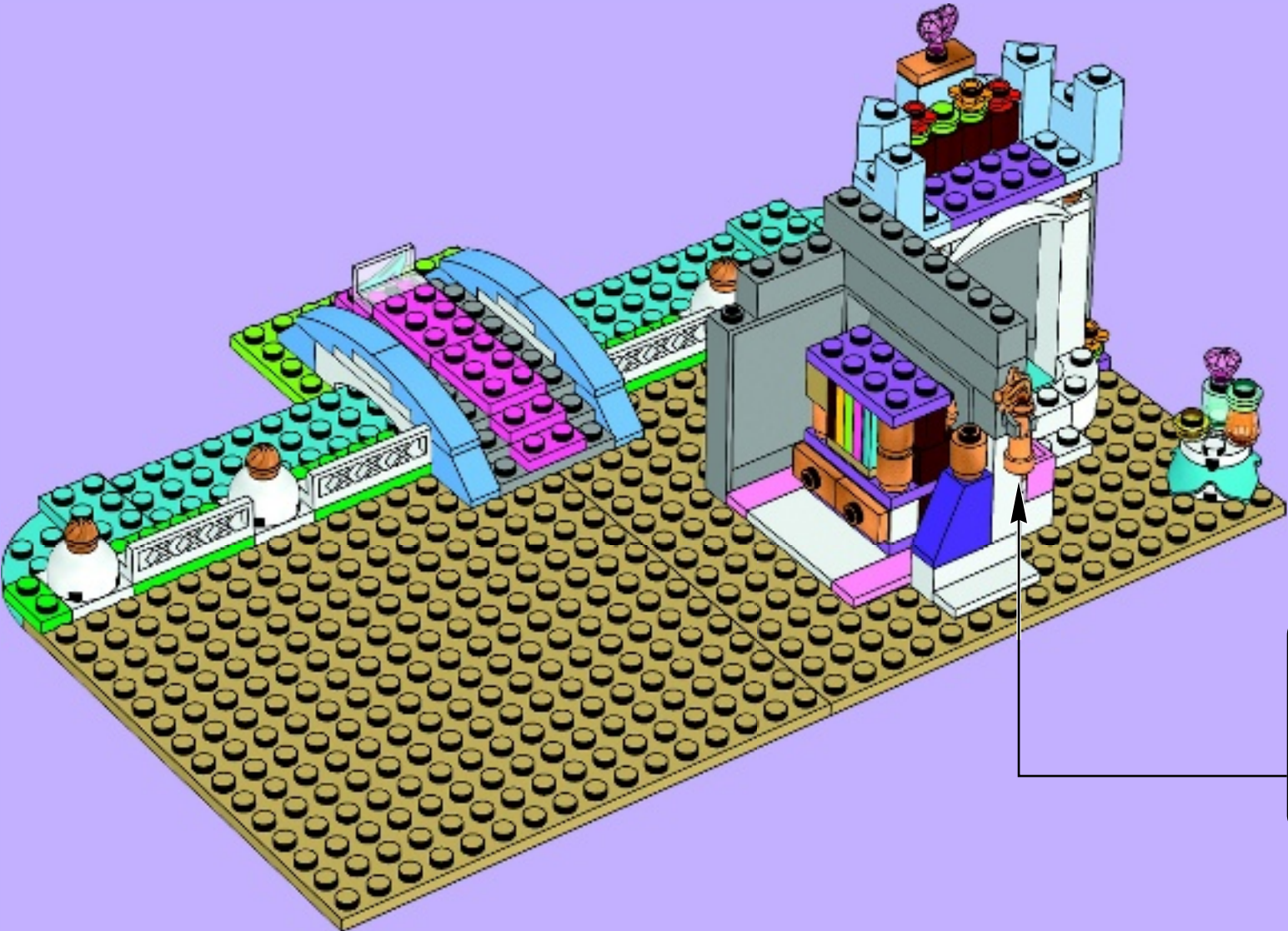





41

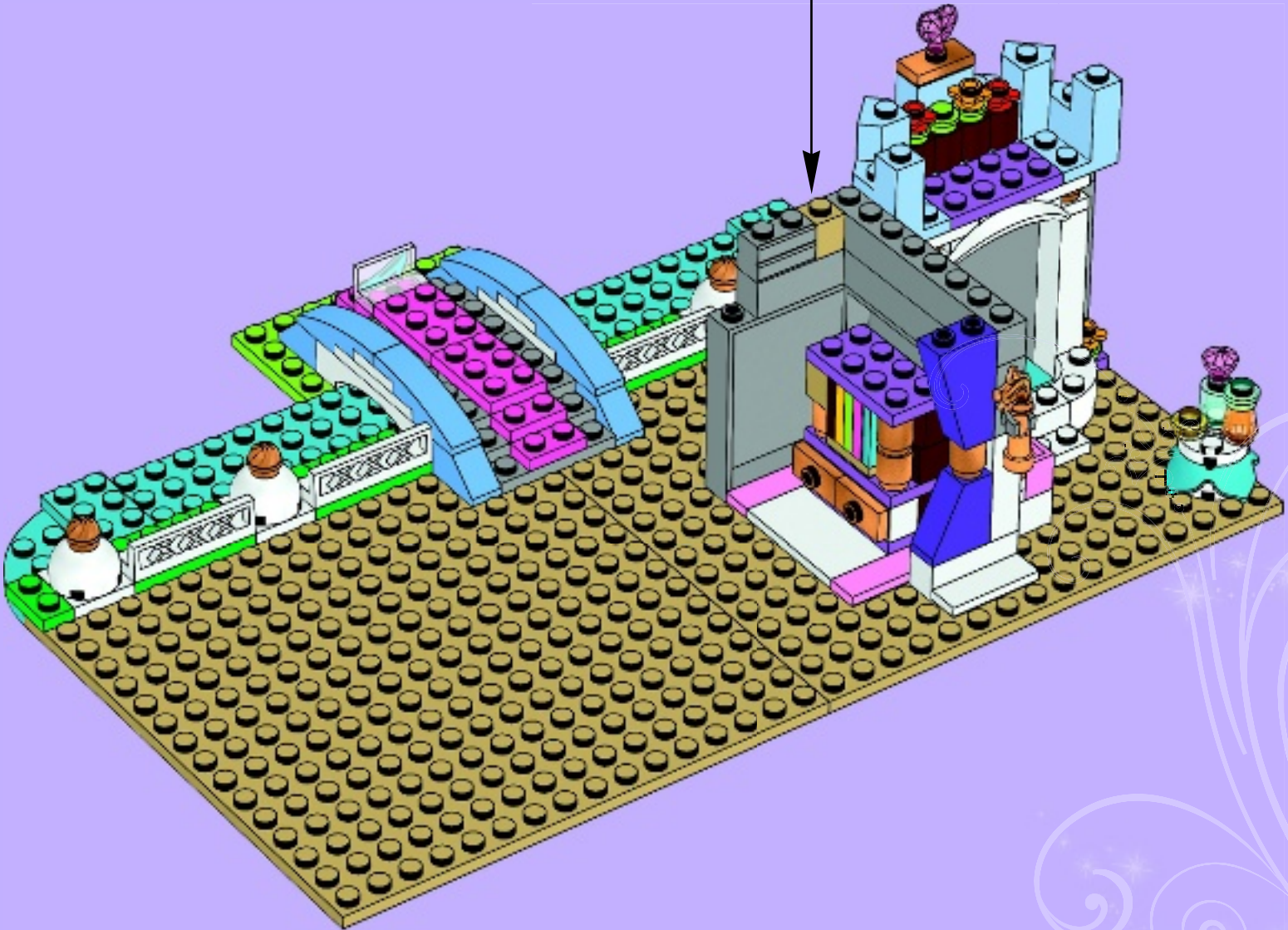



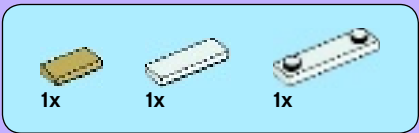

42

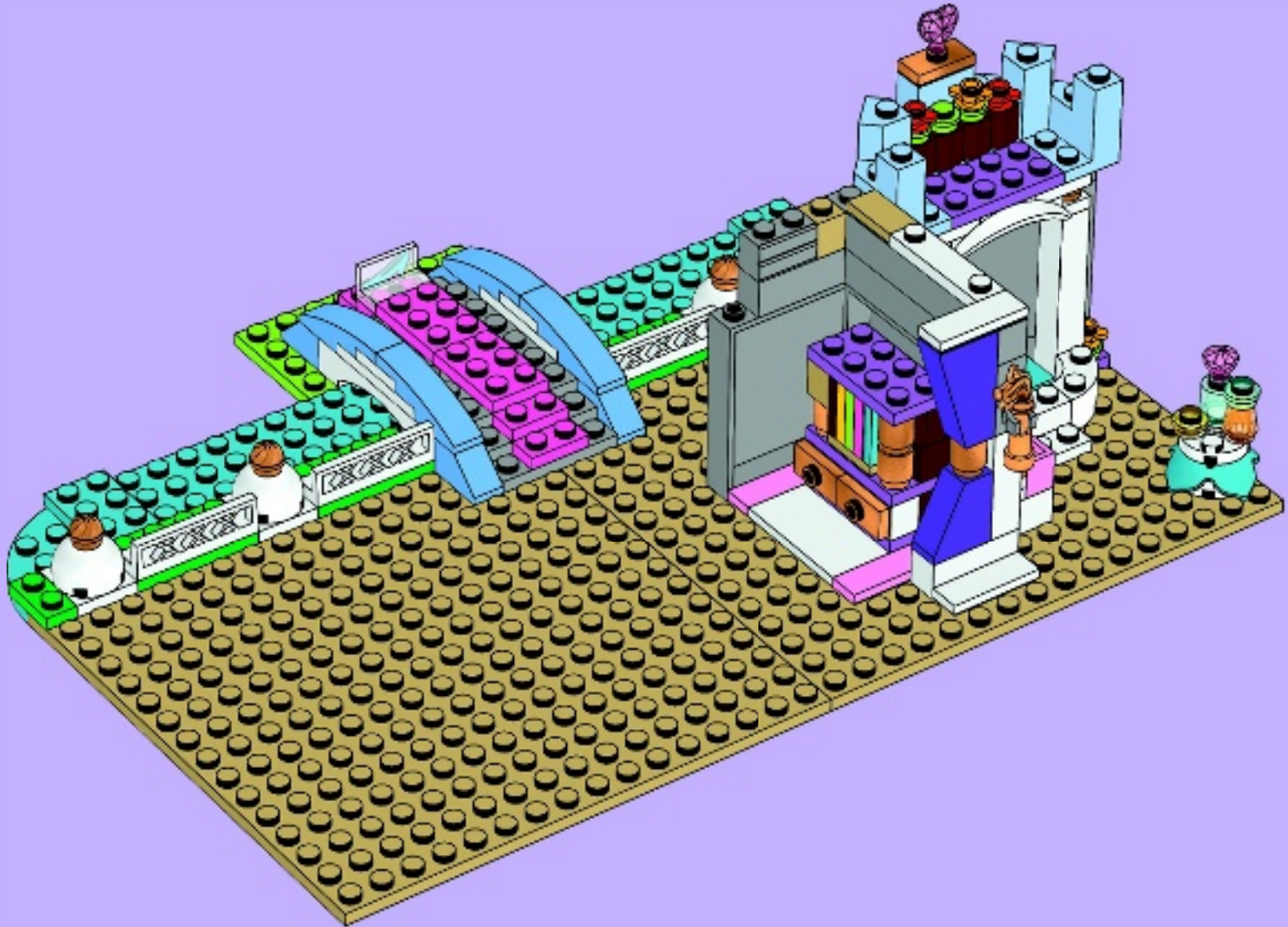



# 43

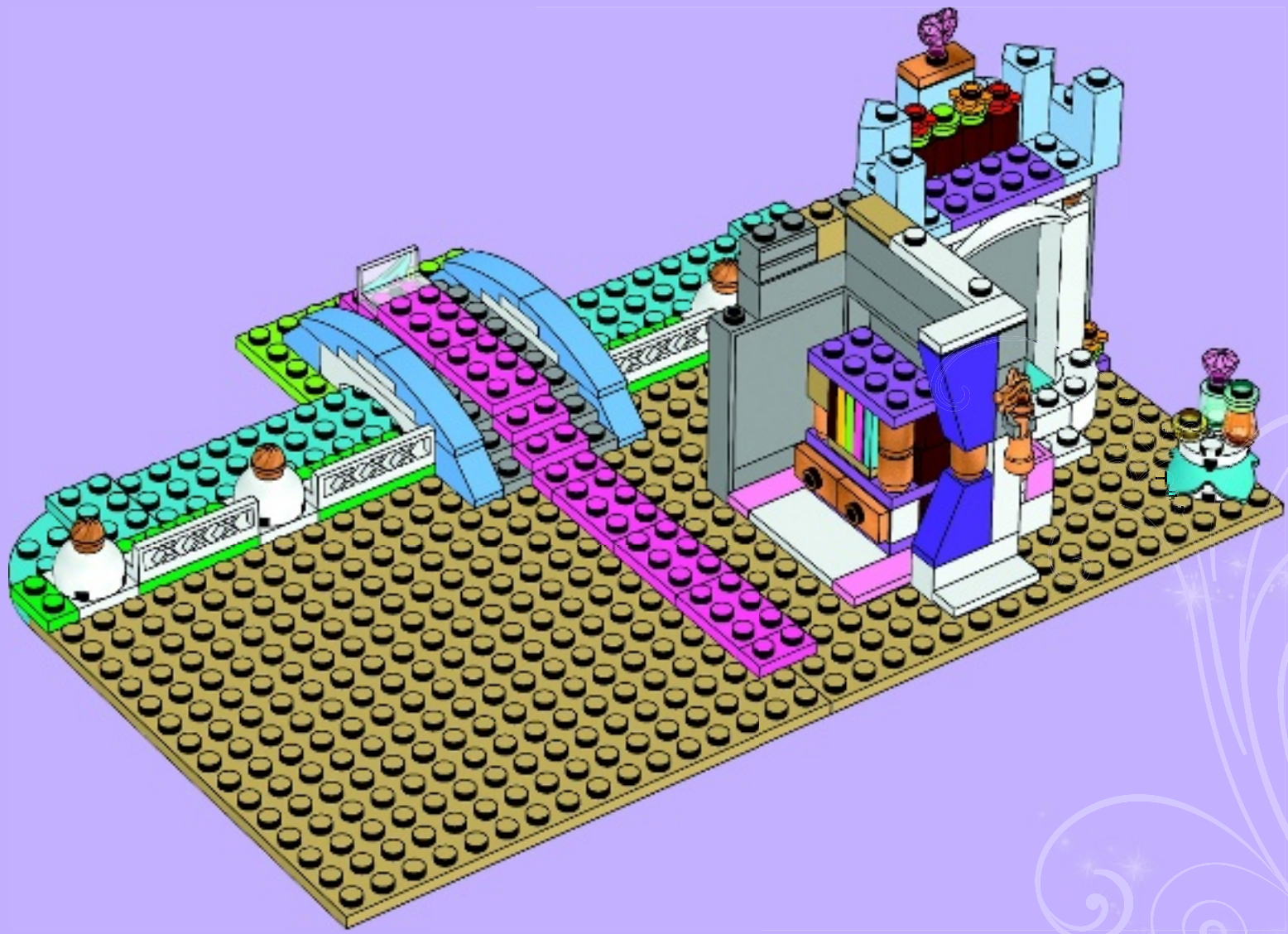



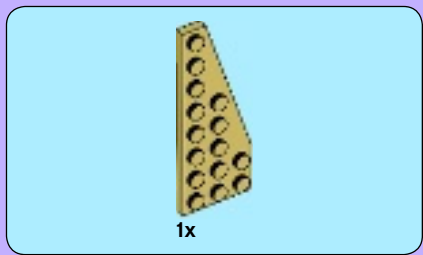

44

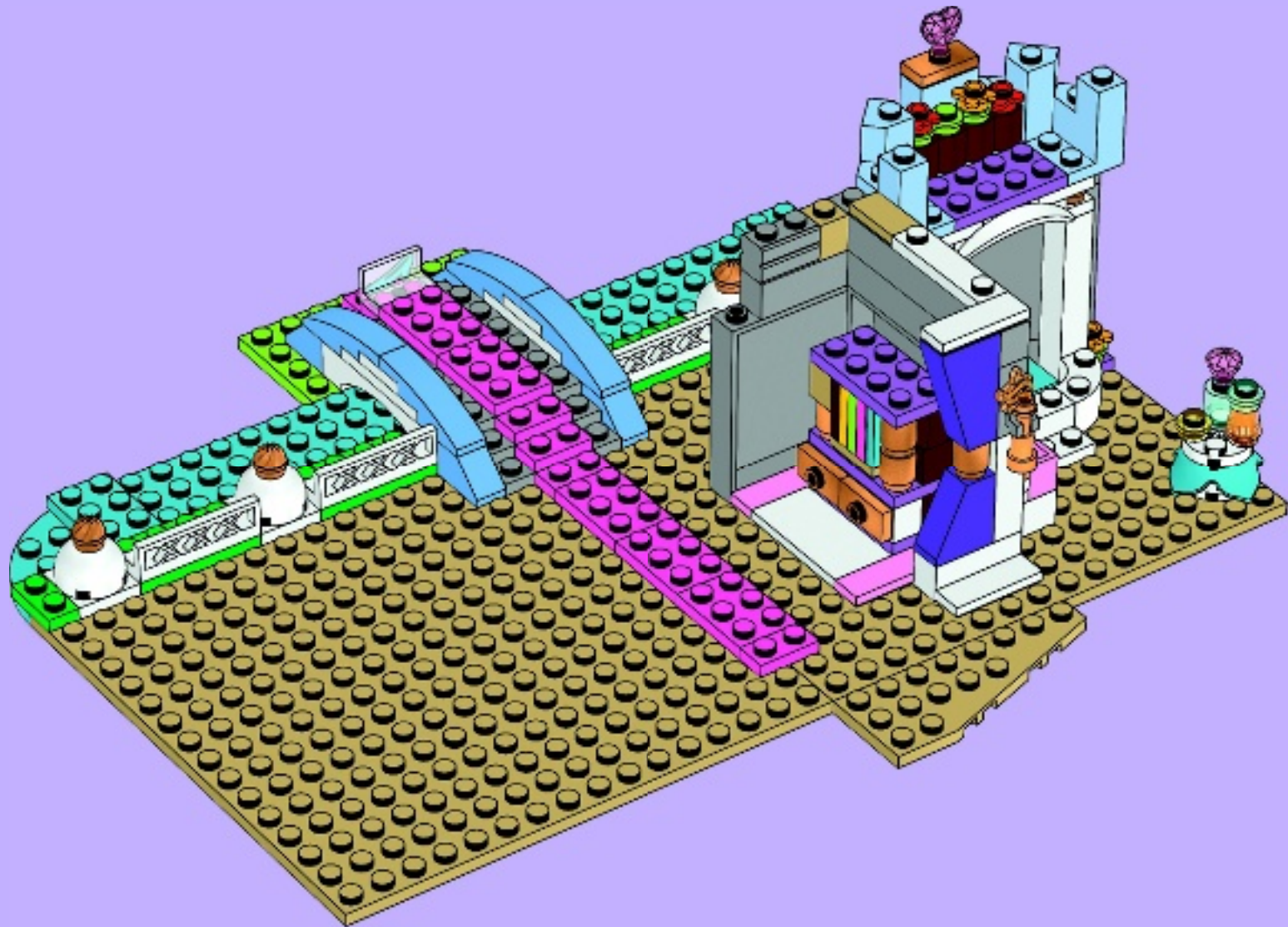



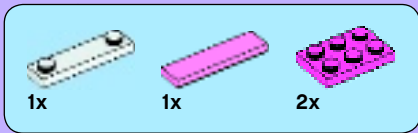

45

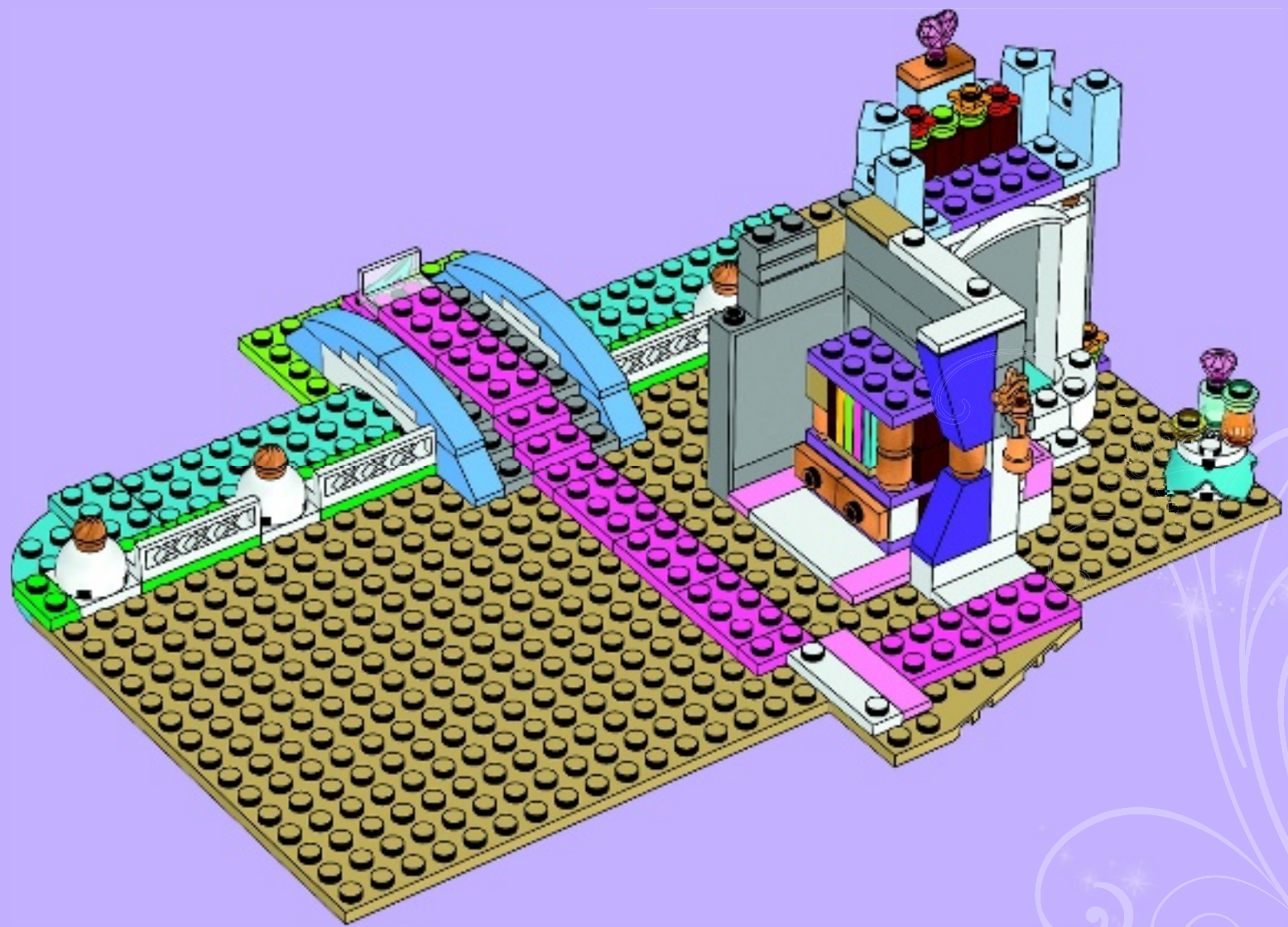

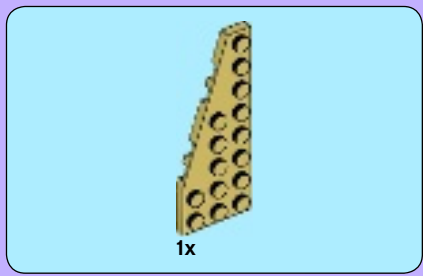

46

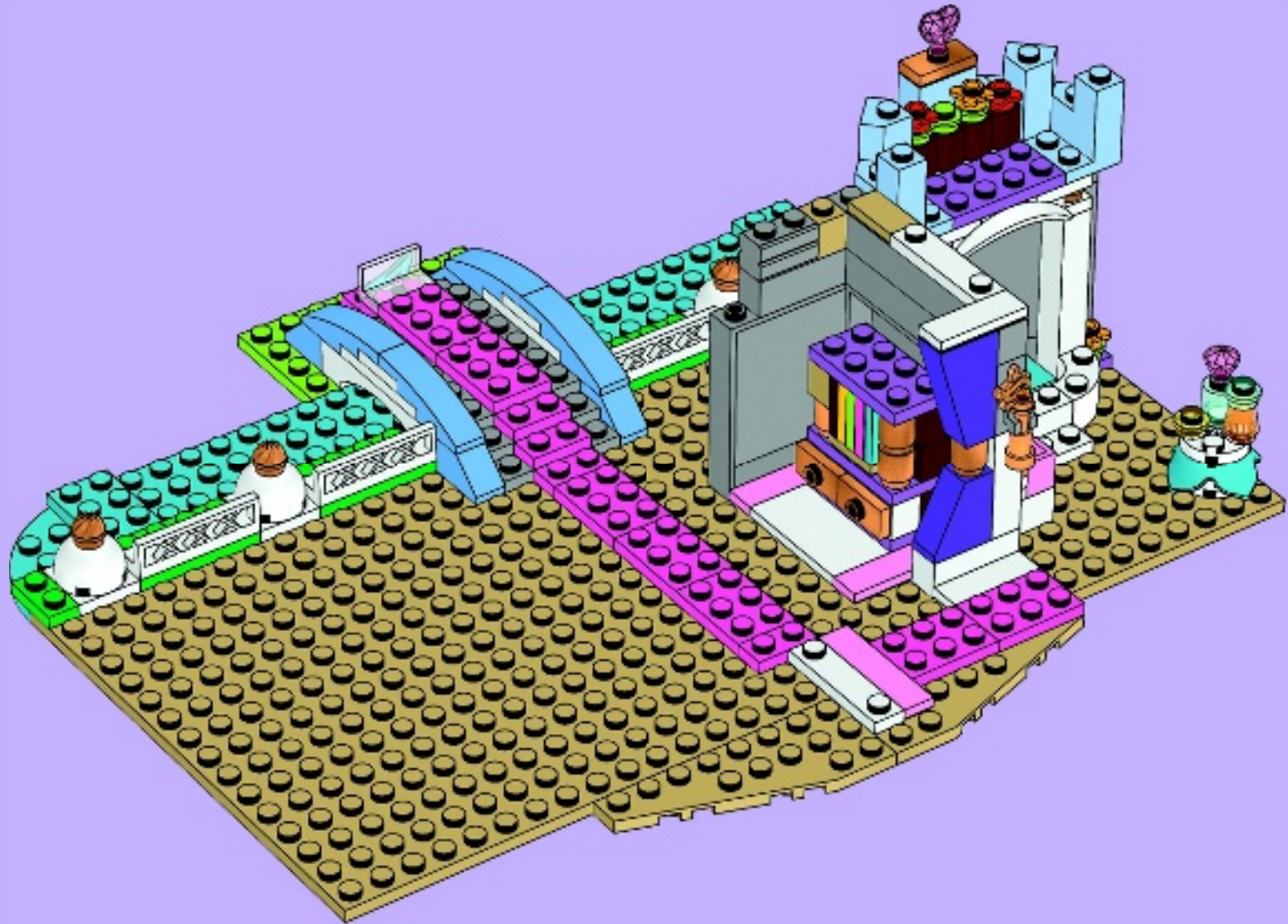



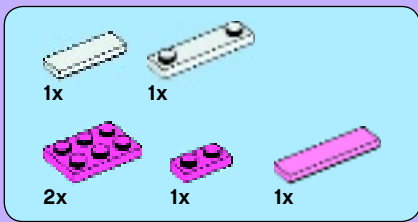

47

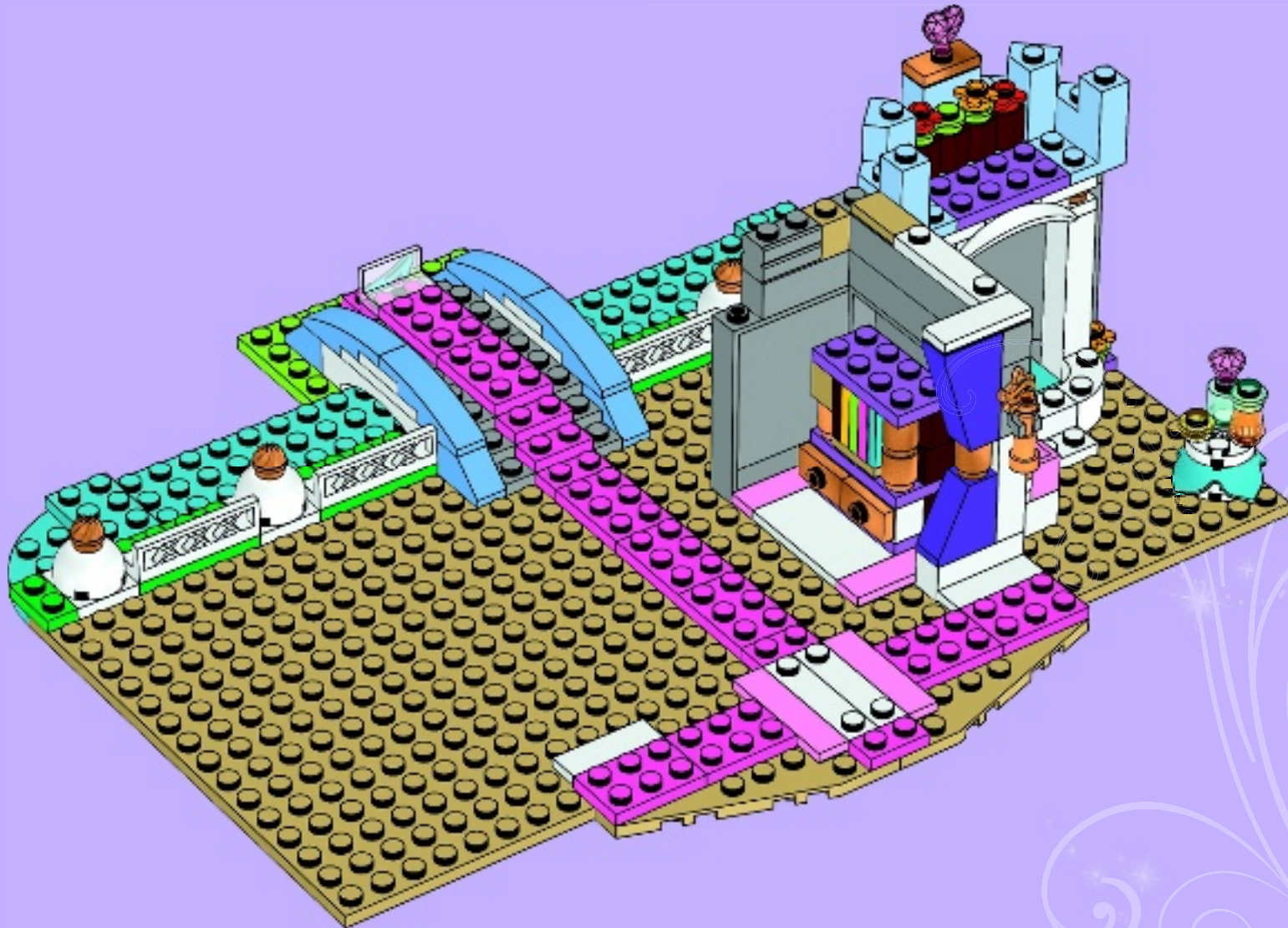



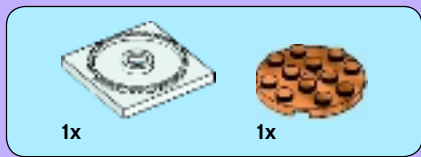

48

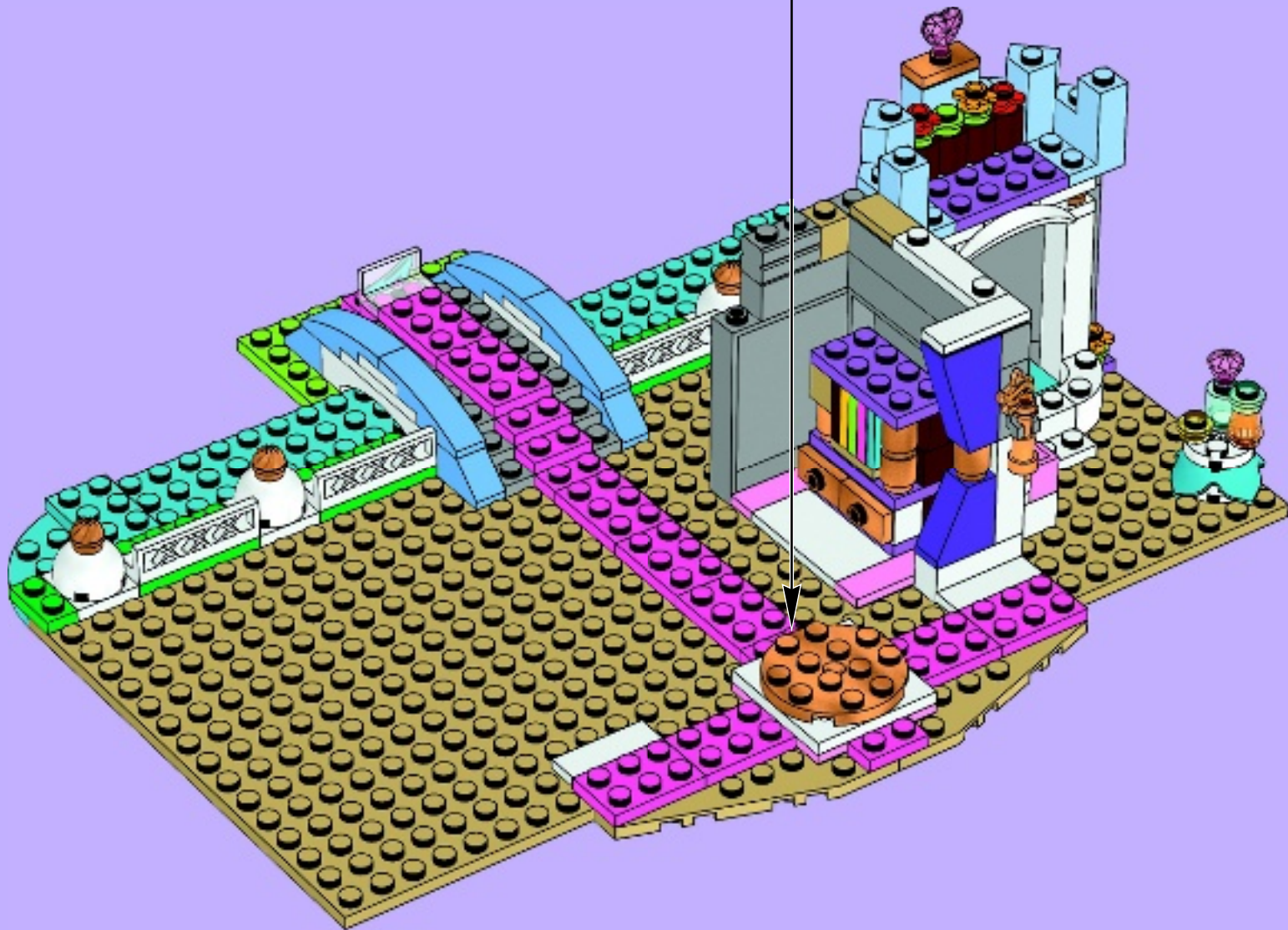

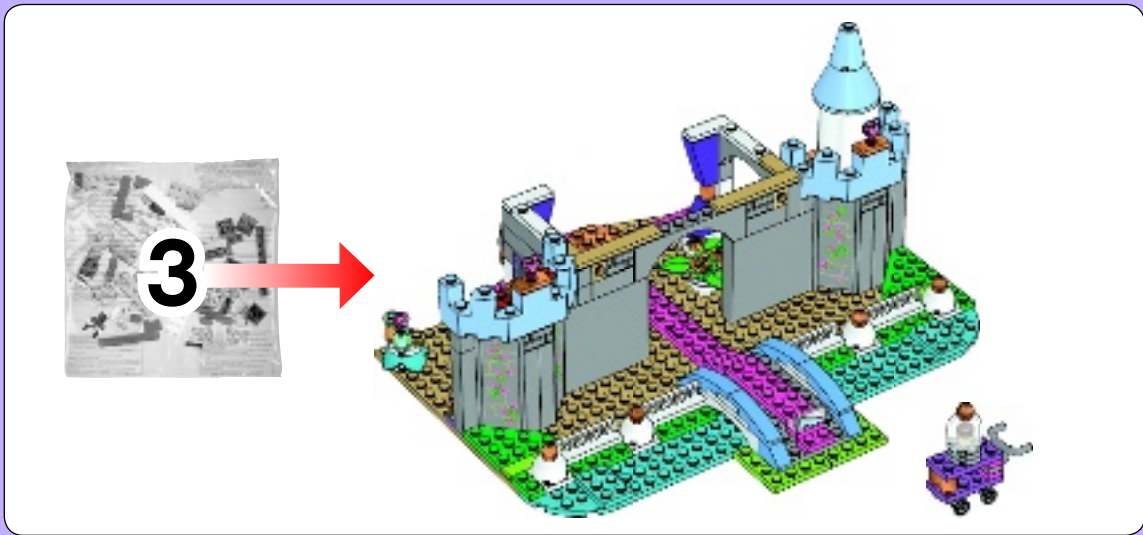

49





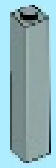

1x

50

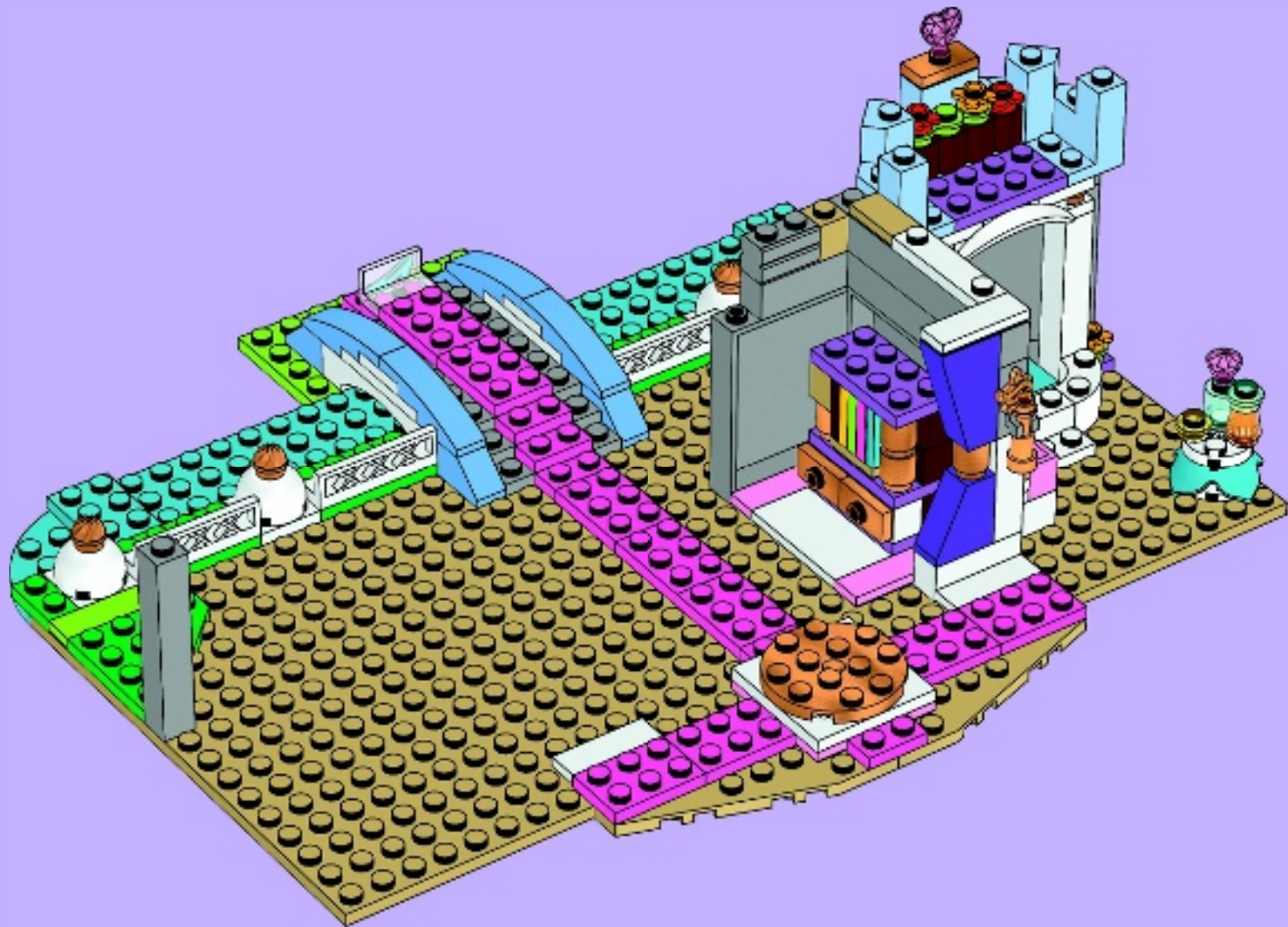



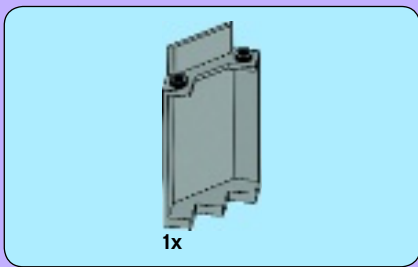

# 51

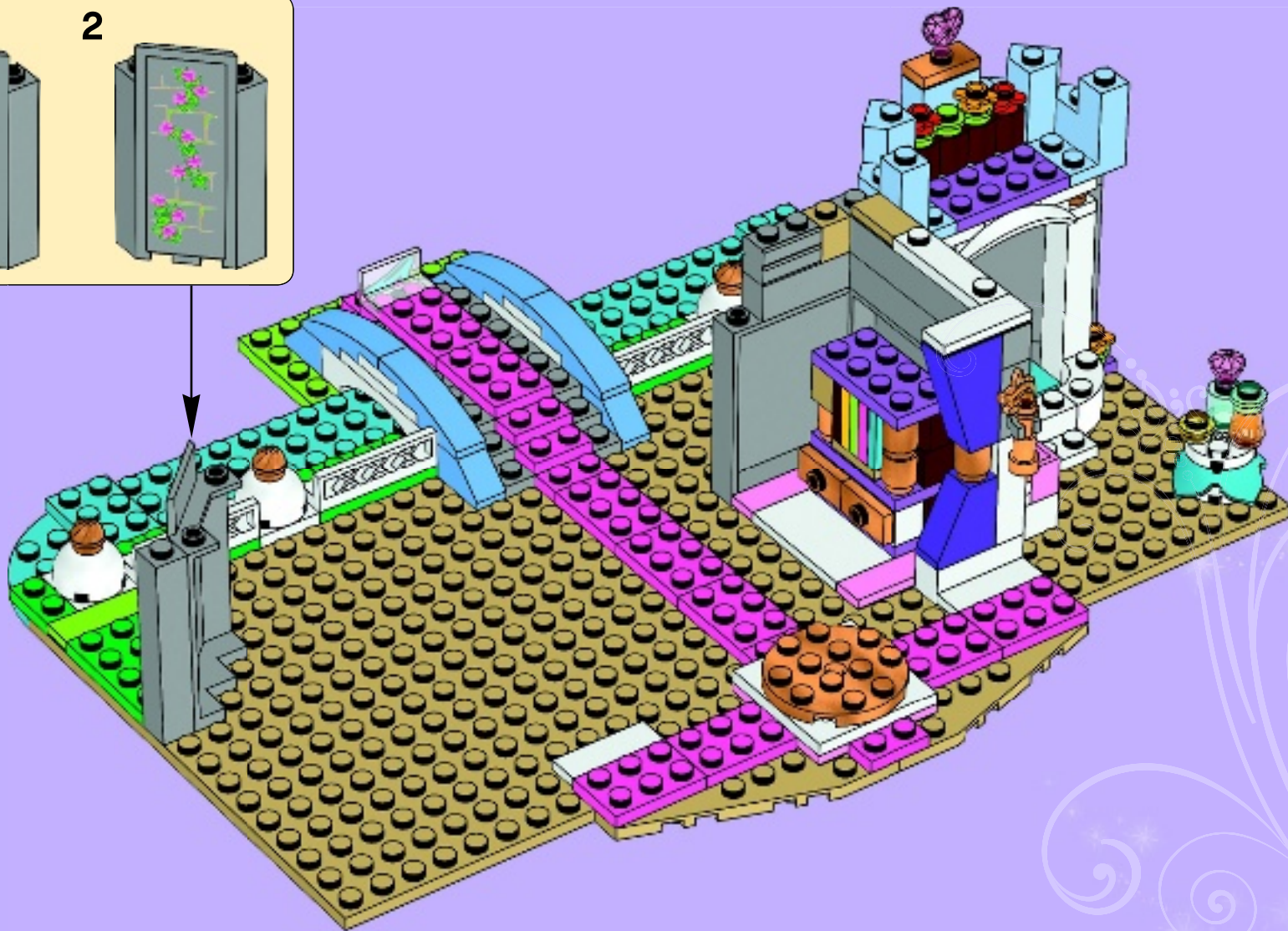
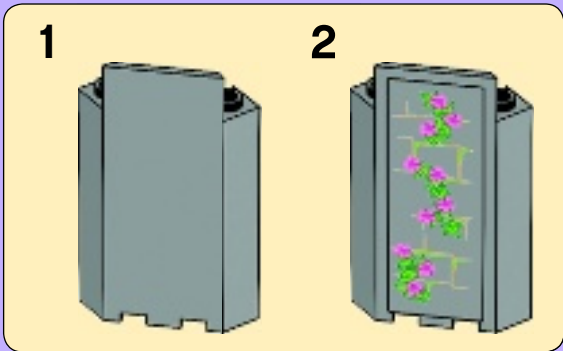

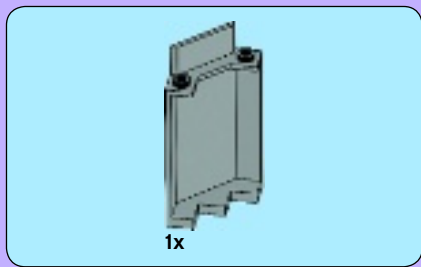

52

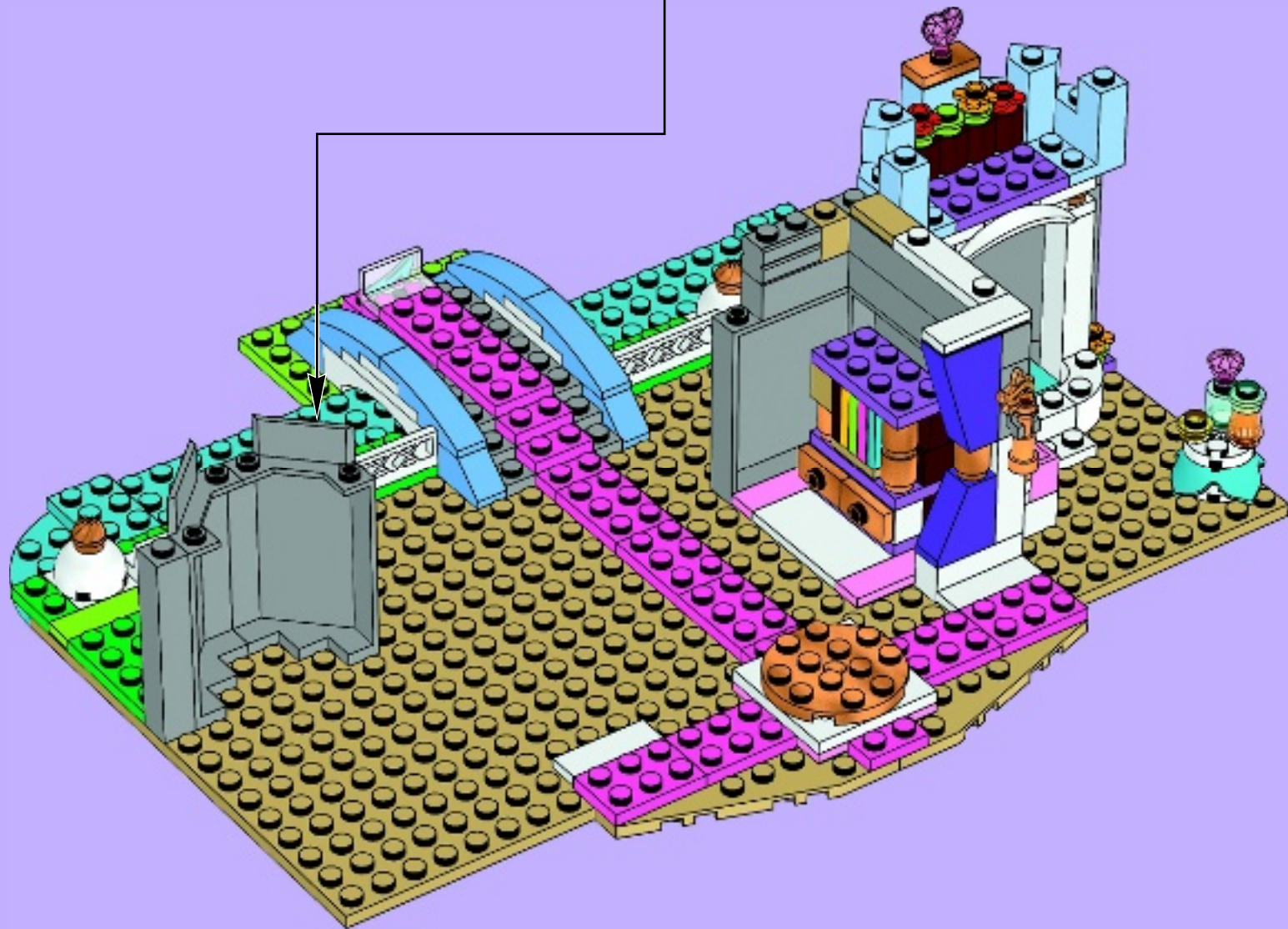
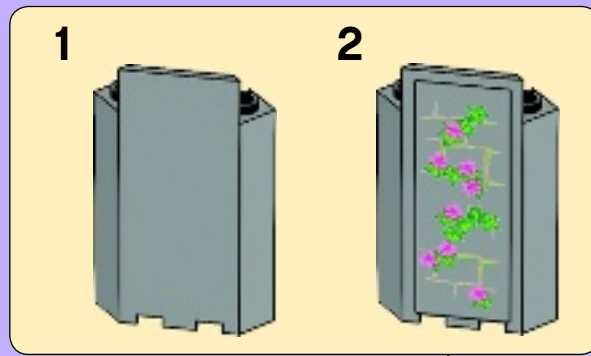



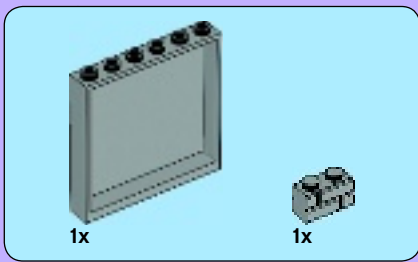

53

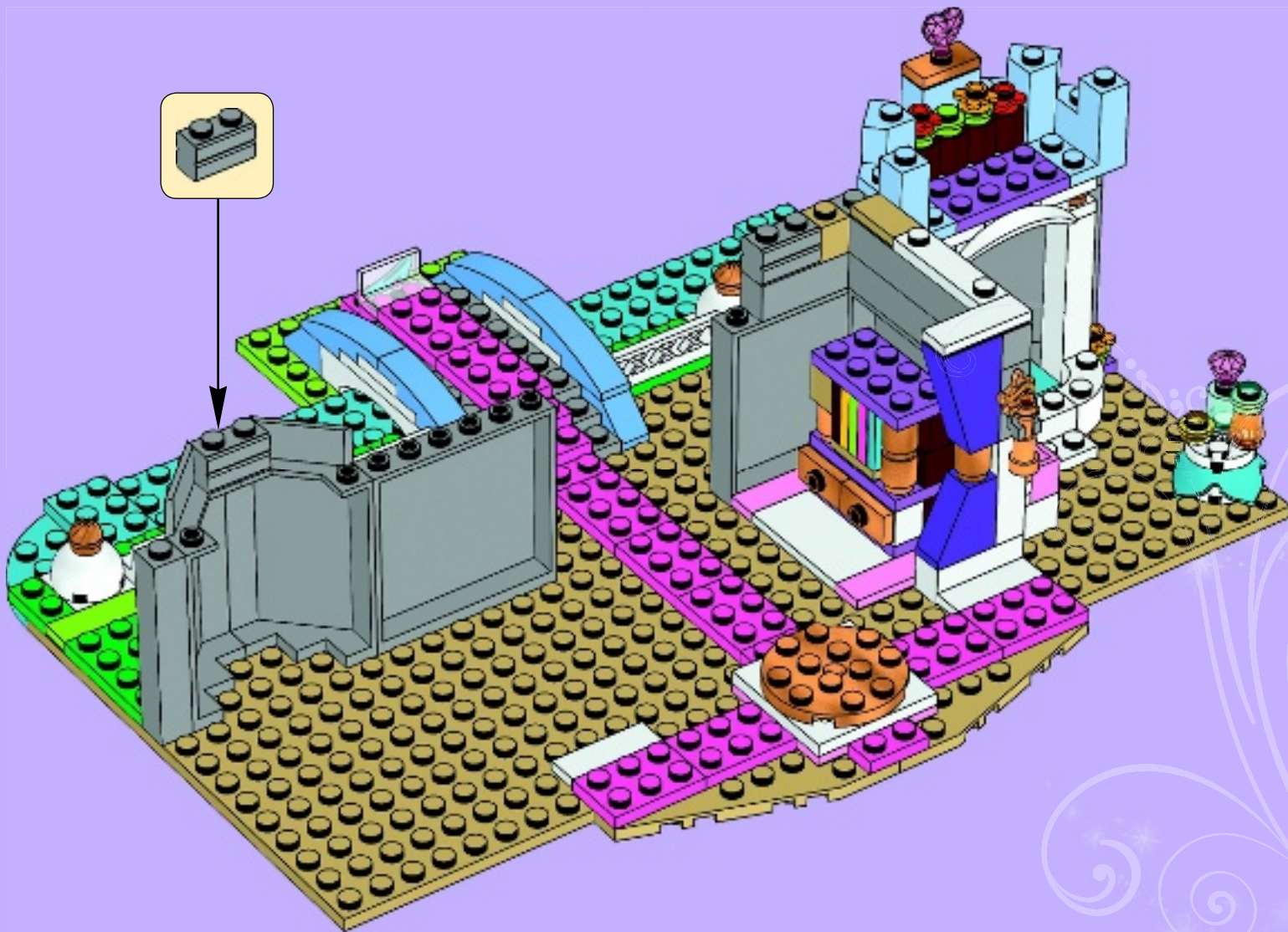



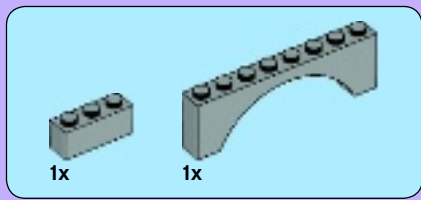

54

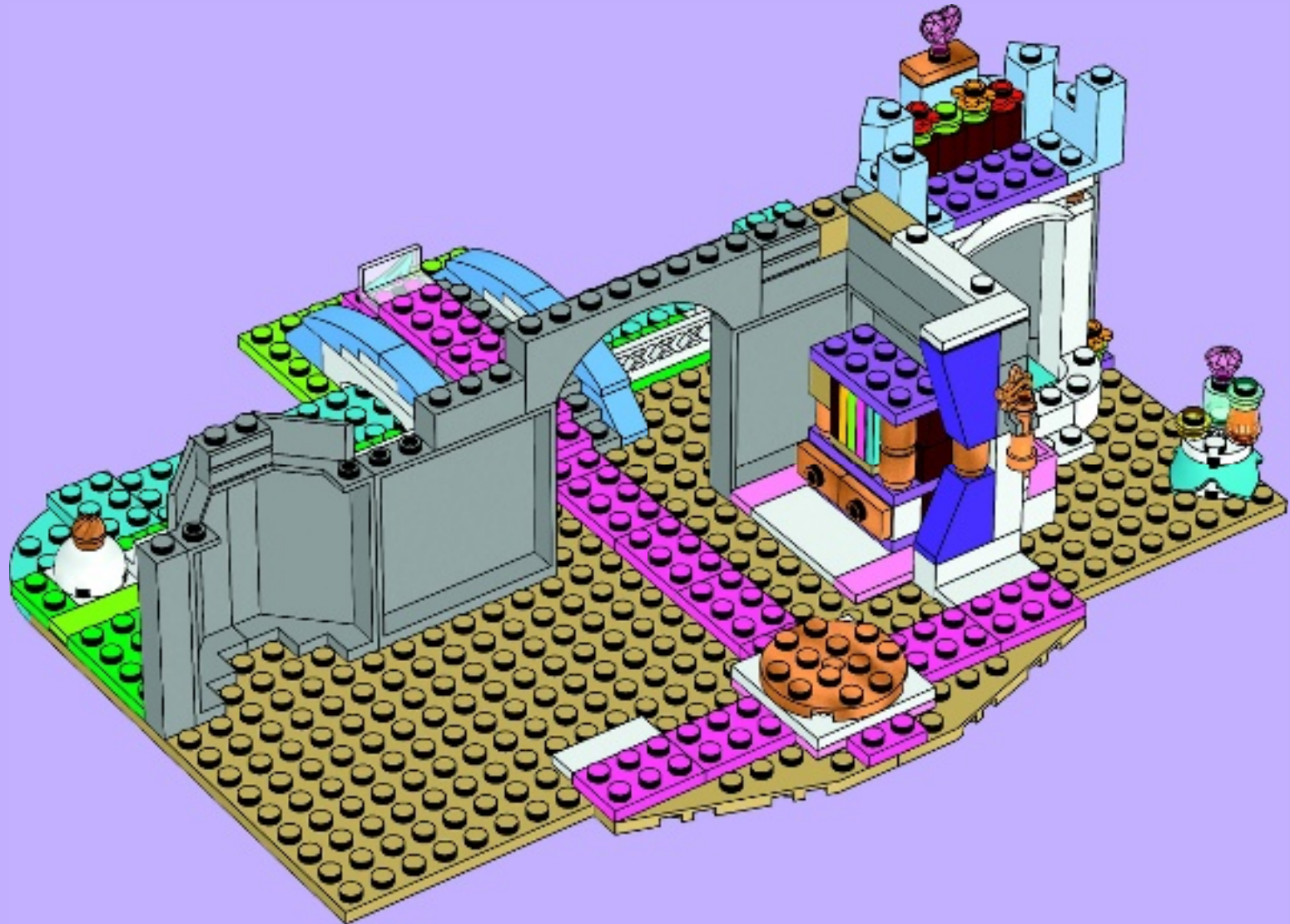



55



1



2



3

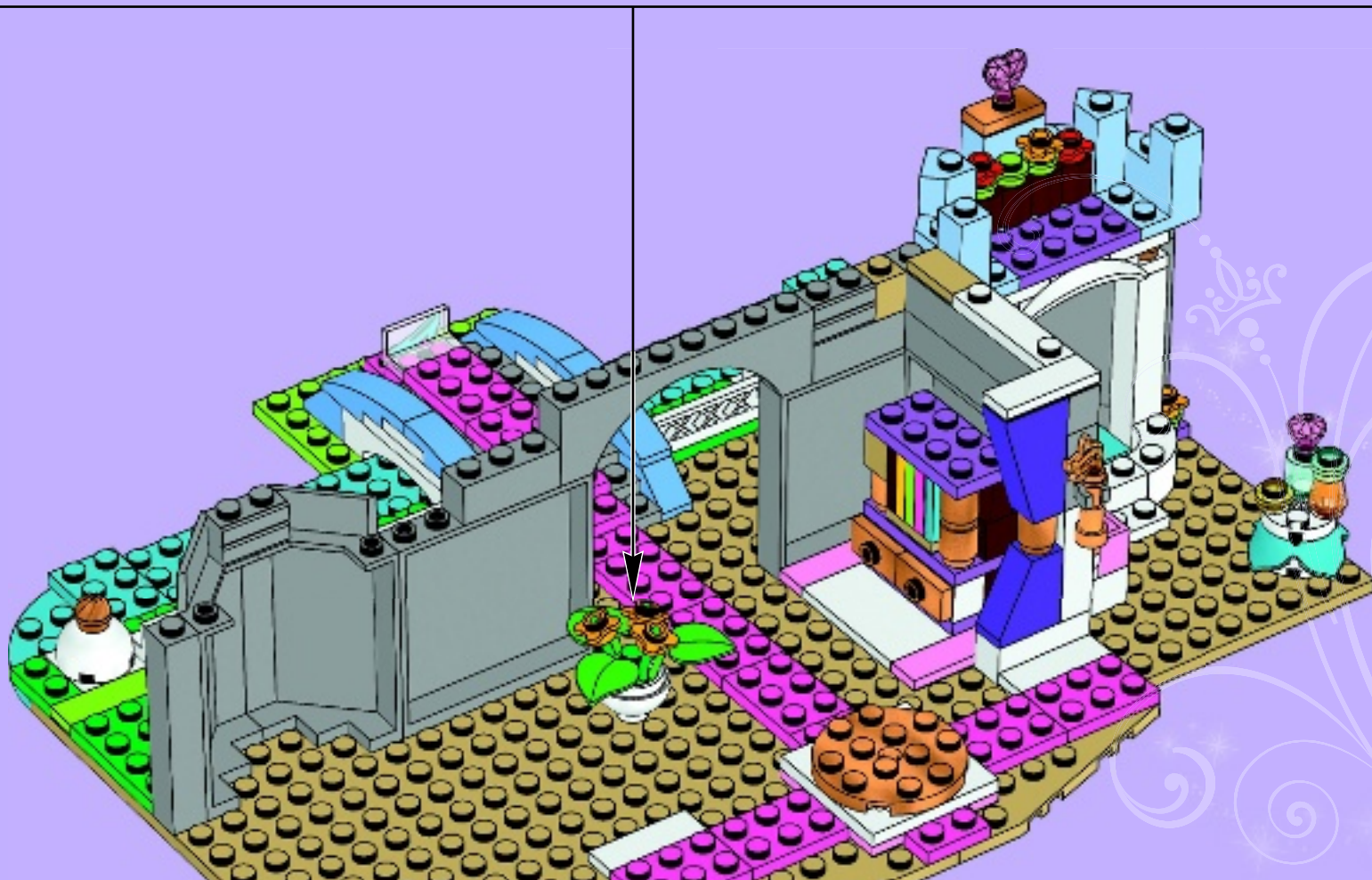



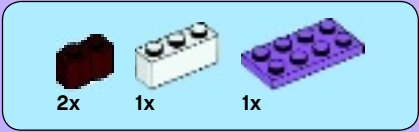

# 56

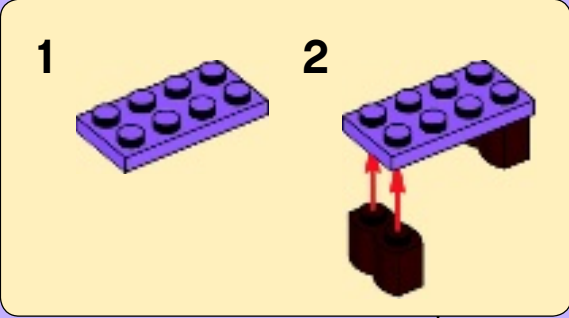



1x 4x 2x

57

2x





1x



1x



1x

# 58

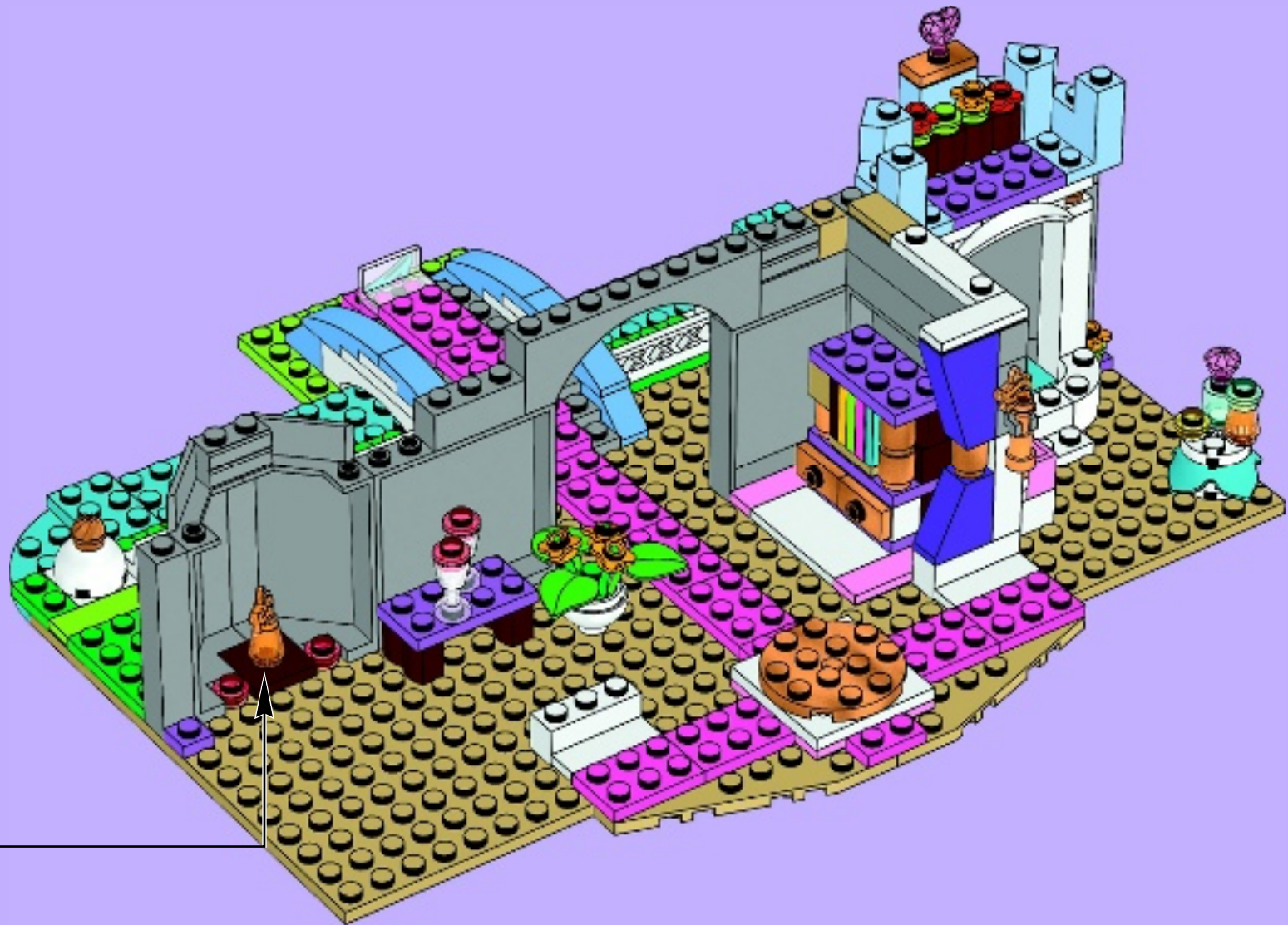





# 59





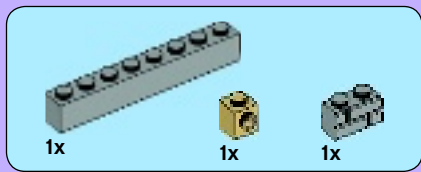

60

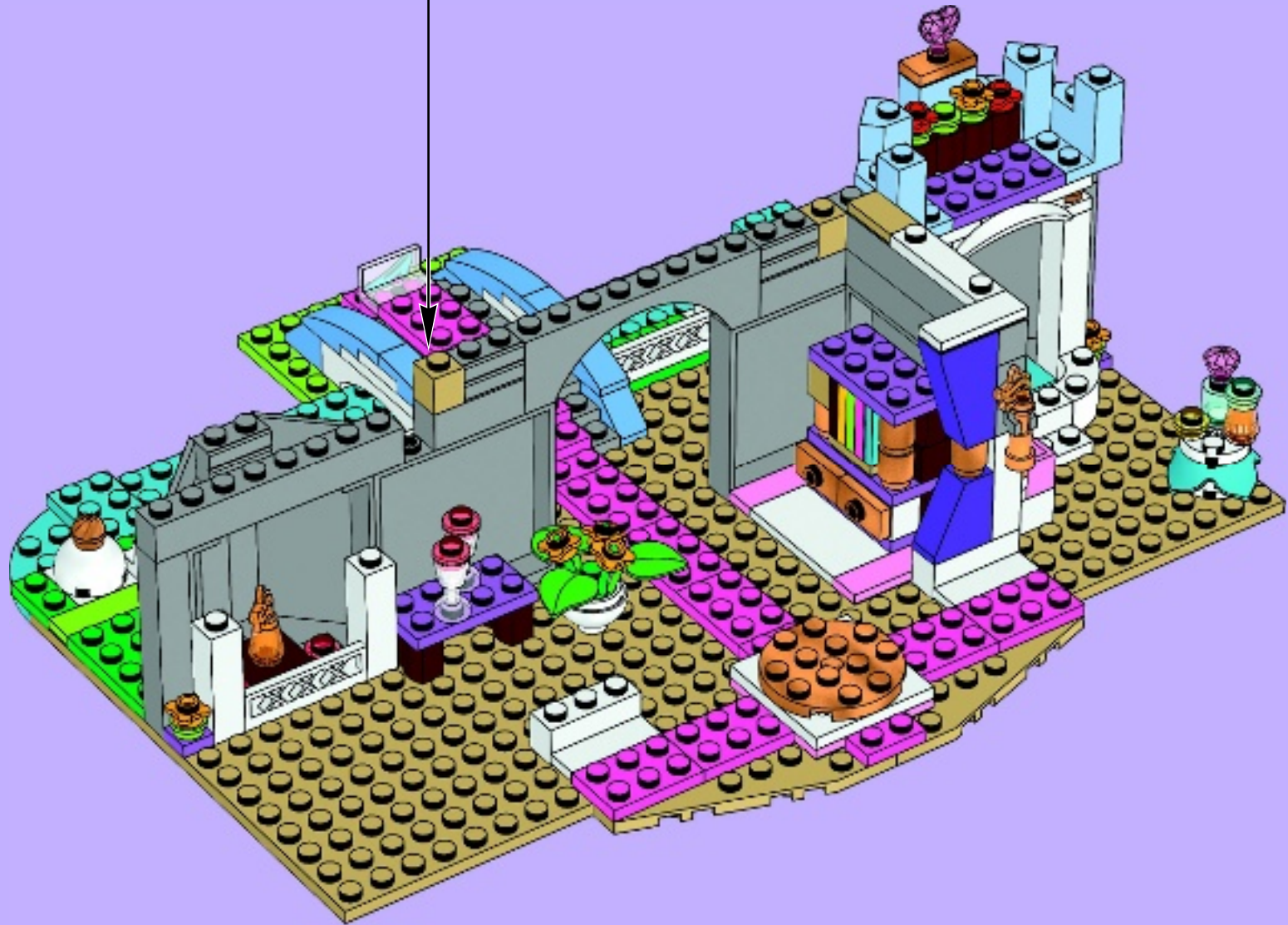

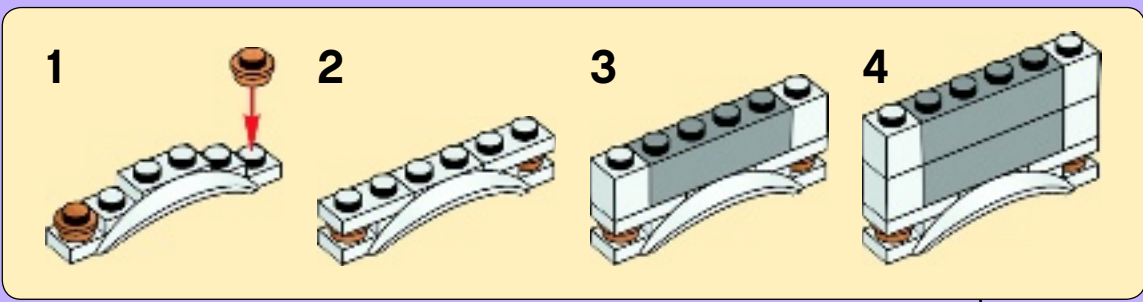
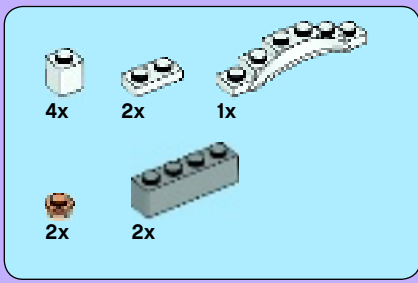

61

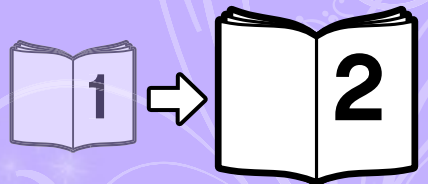



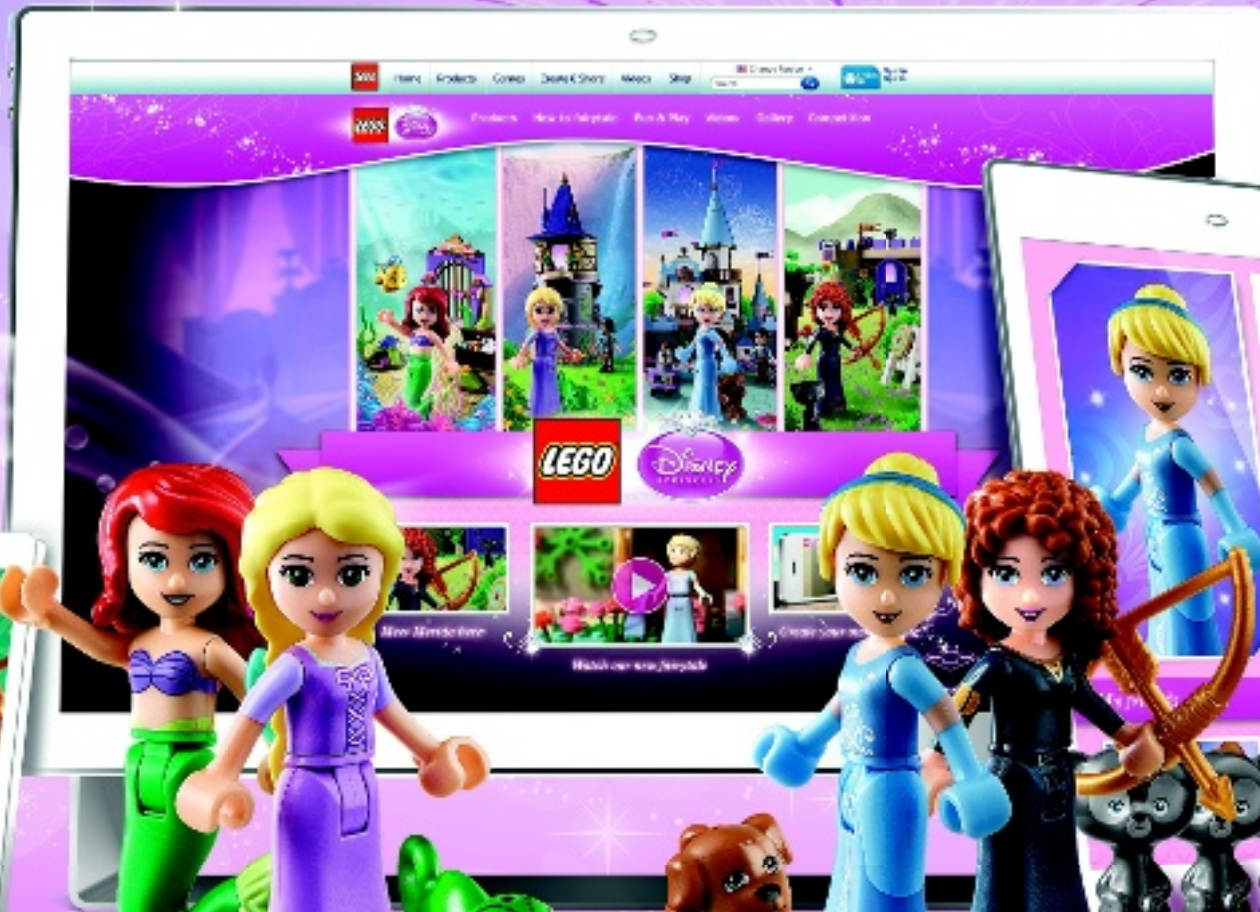
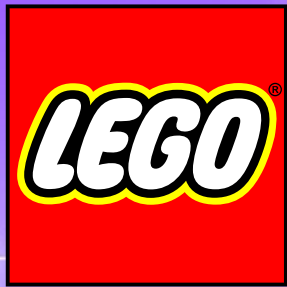

[LEGO.com/disneyprincess](http://LEGO.com/disneyprincess)





41055





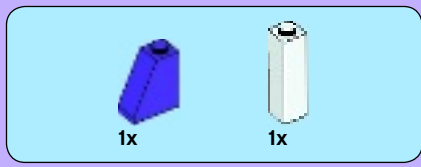

62

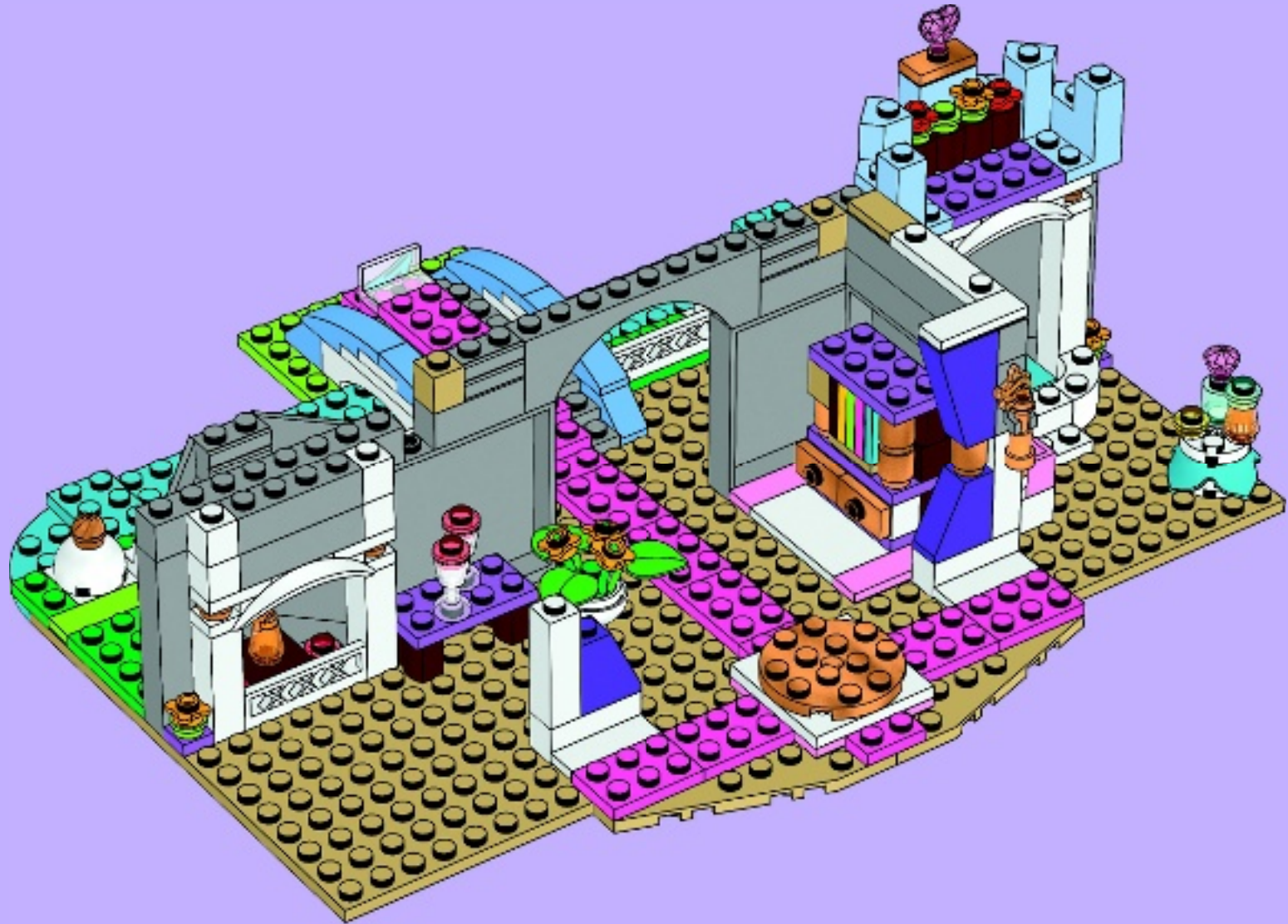



1x



1x

# 63

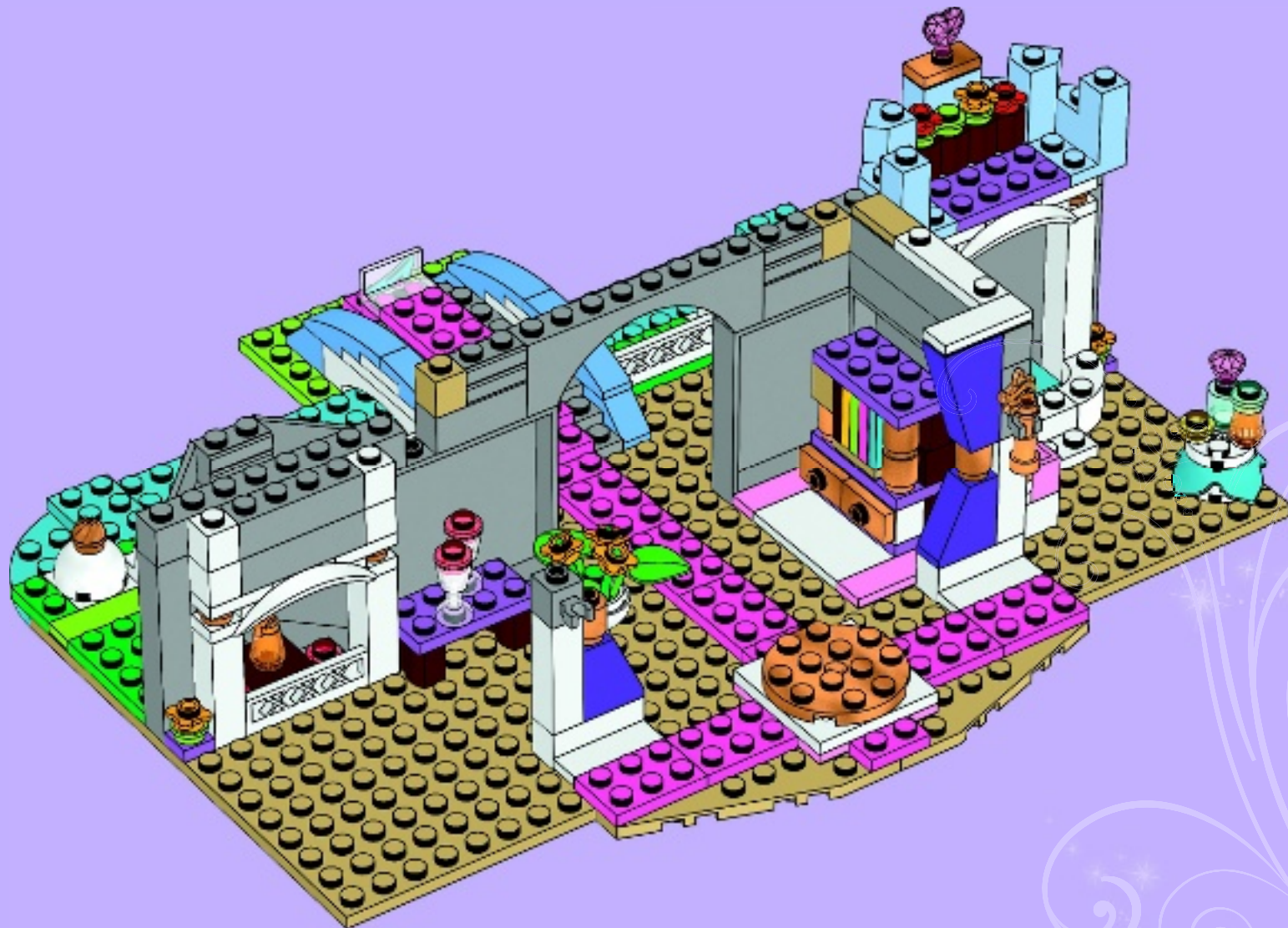



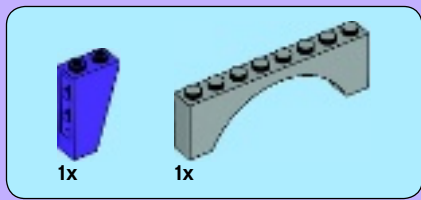

64

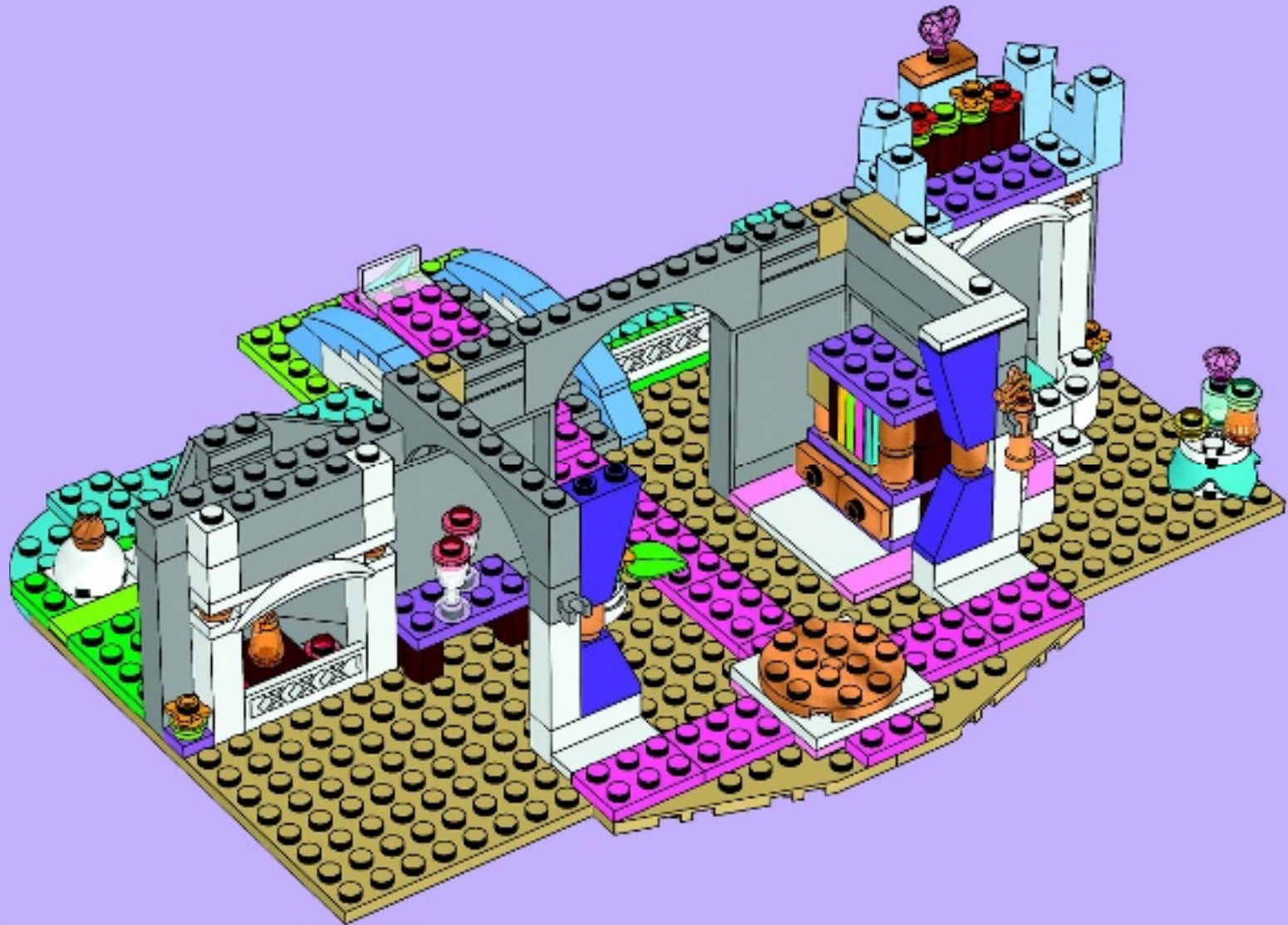

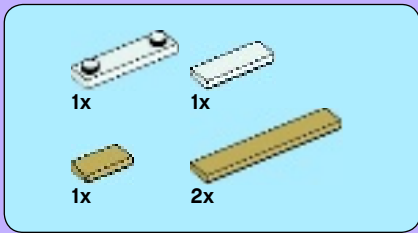

65





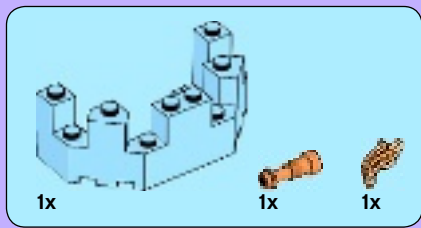

66

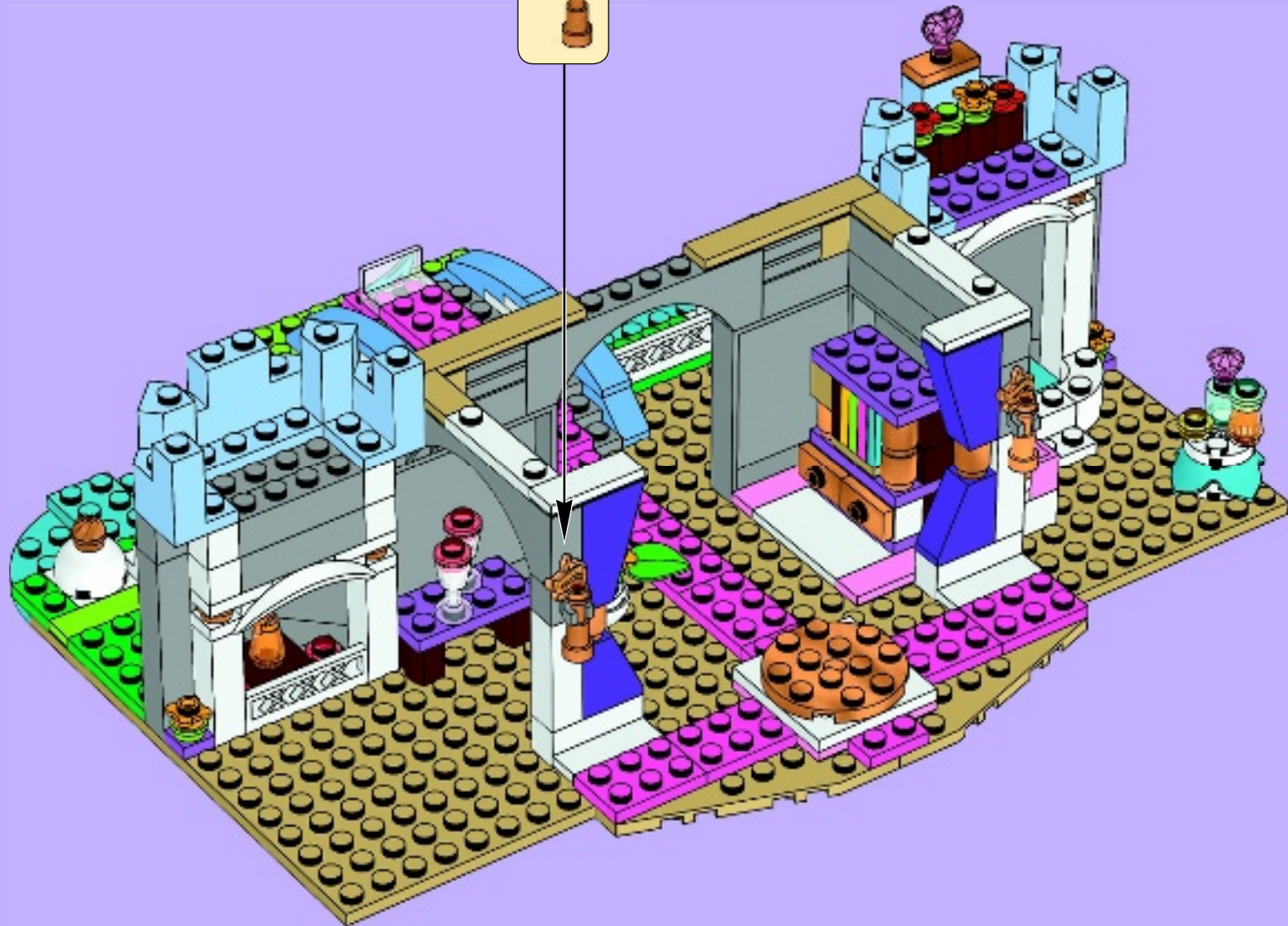
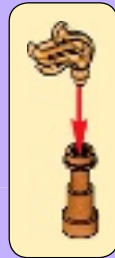





67

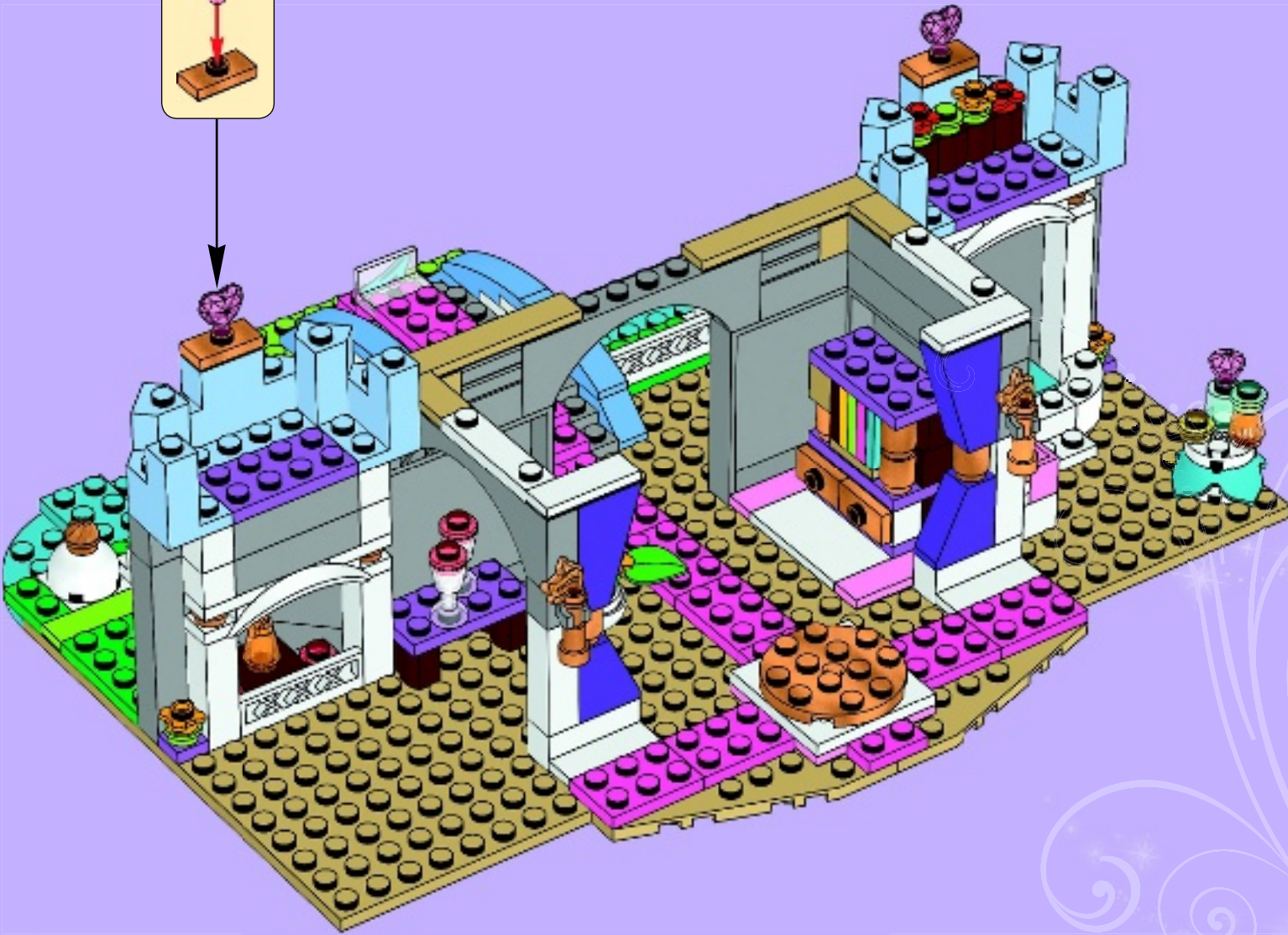



68

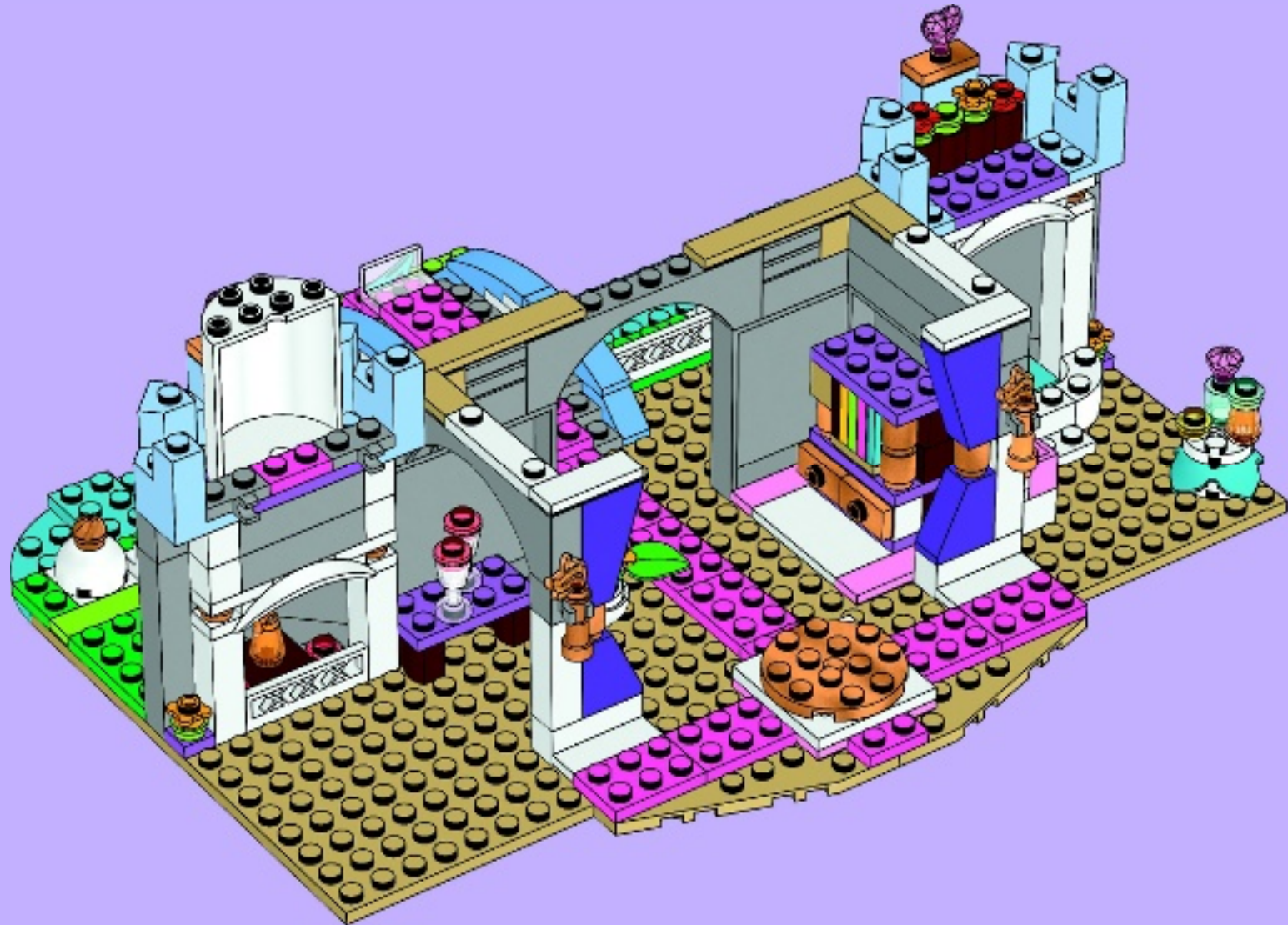



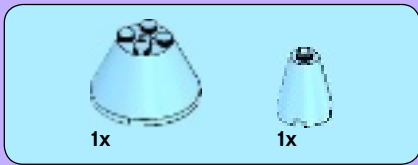

69

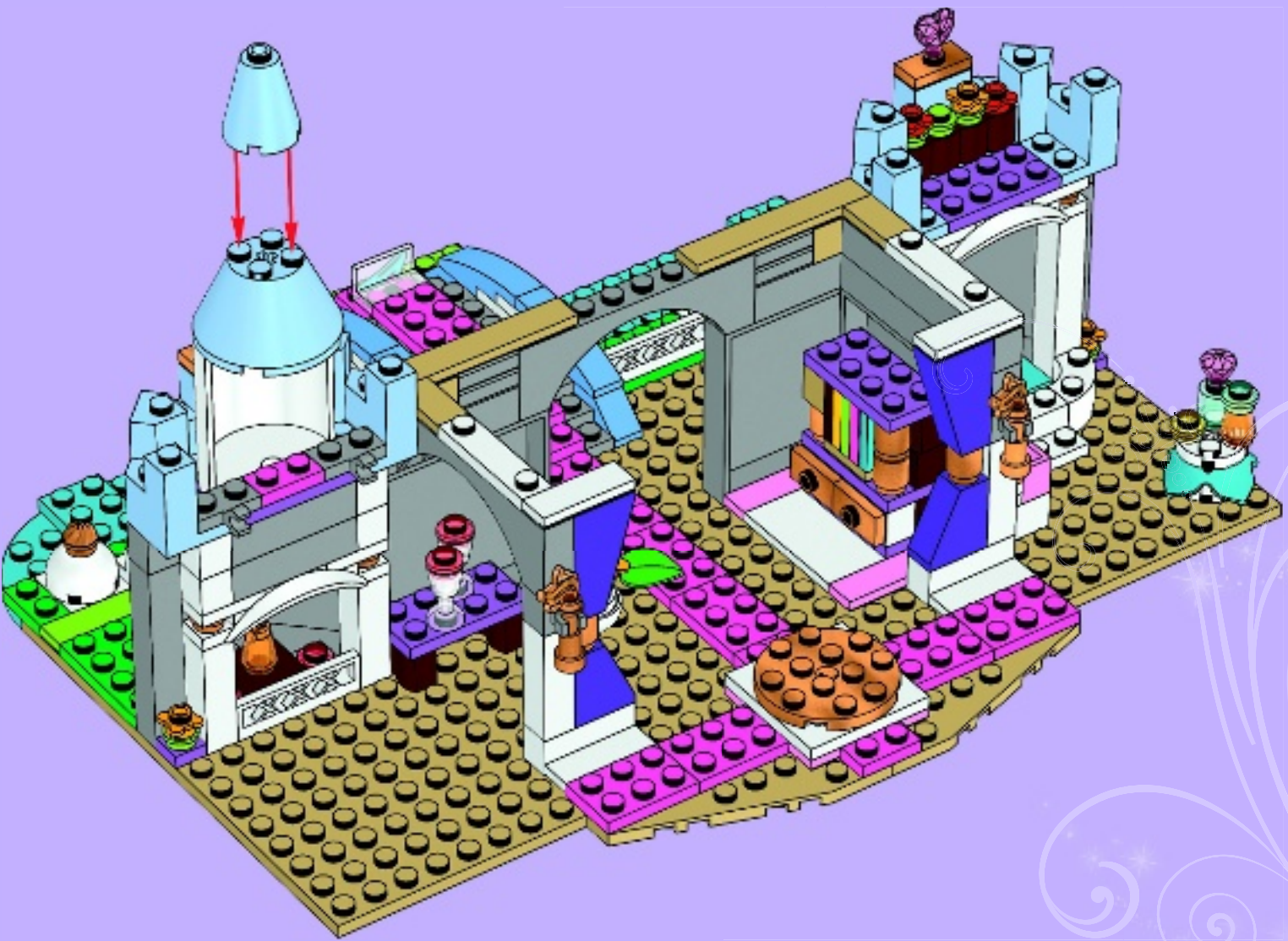



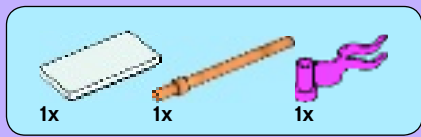

70

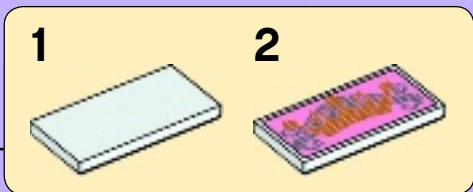
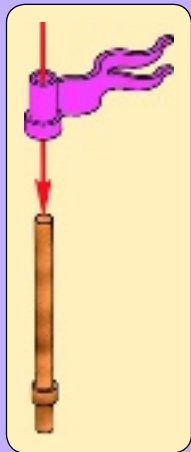



1

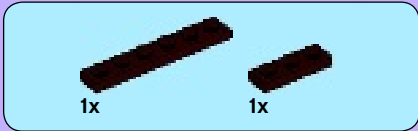
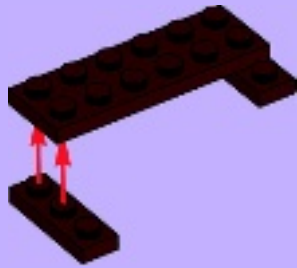

2



3

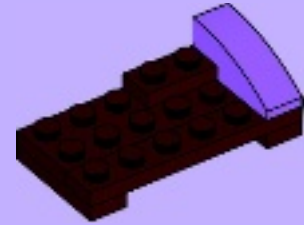

4

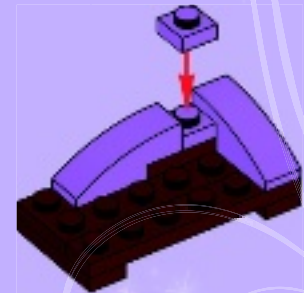



5

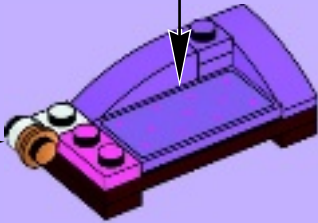
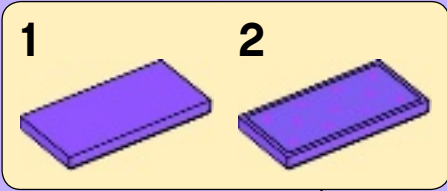

71

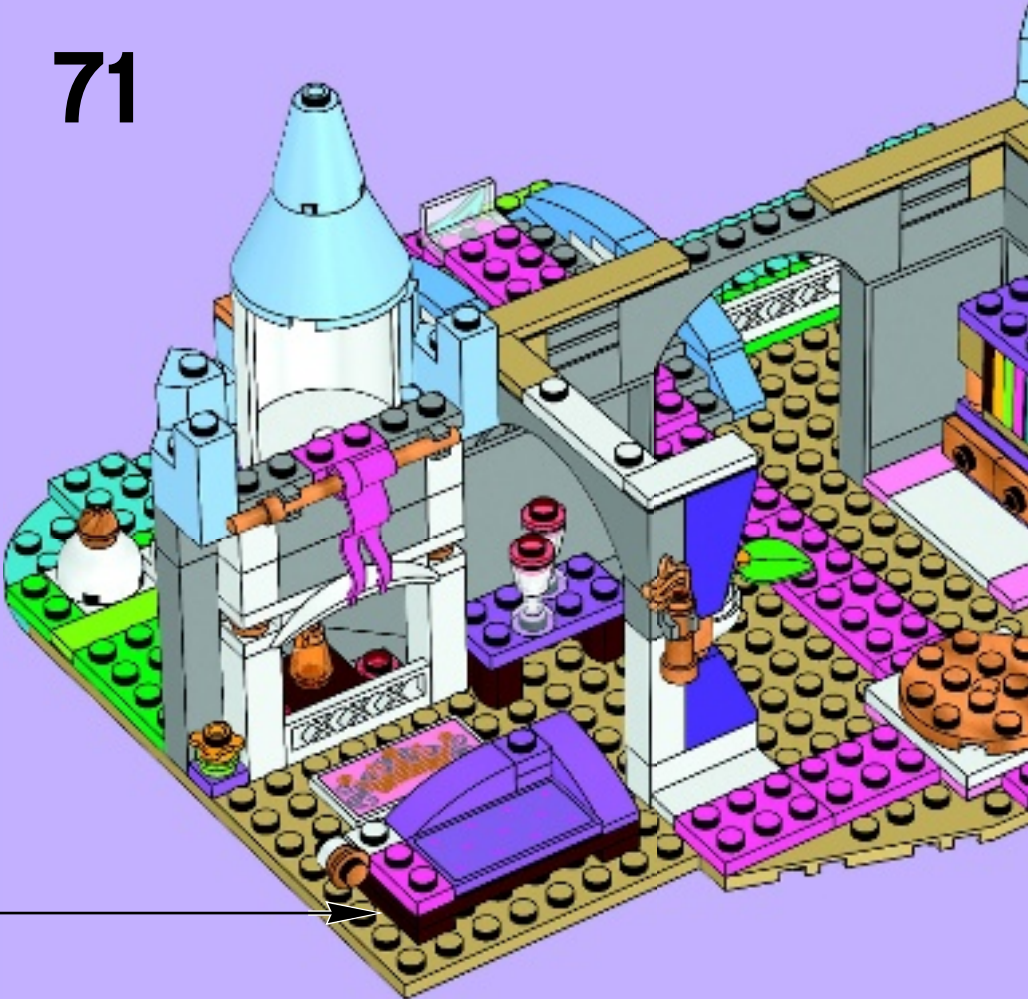





1

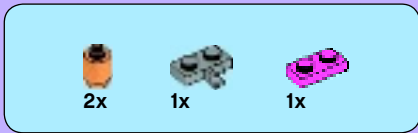
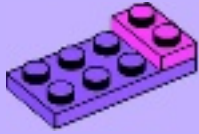

2

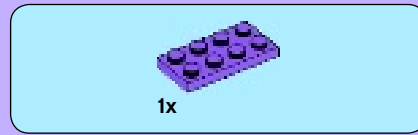

3

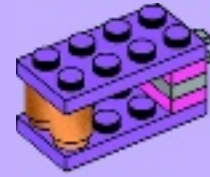

4

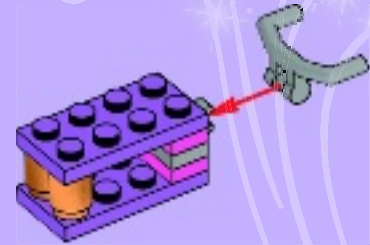



2x

5



2x

6

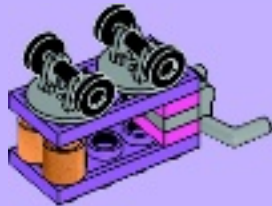

1x



2x



1x



1x



1x

7

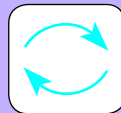
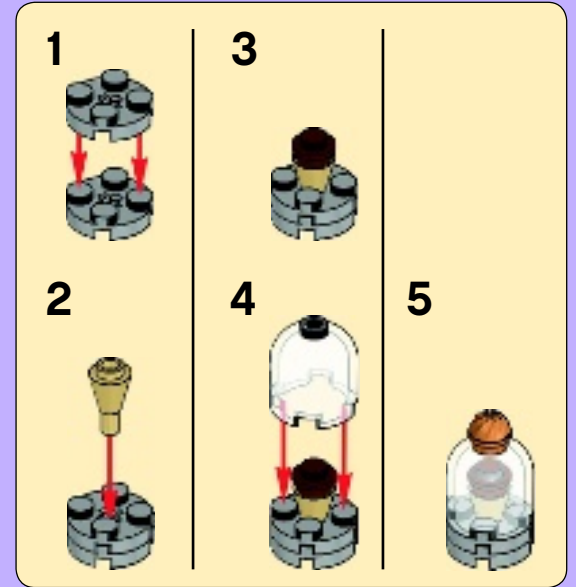

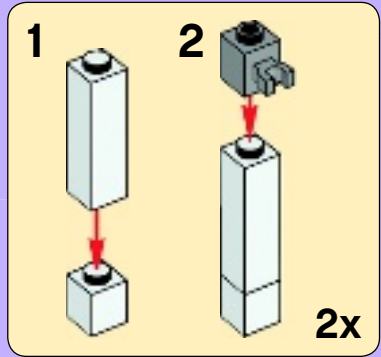

72

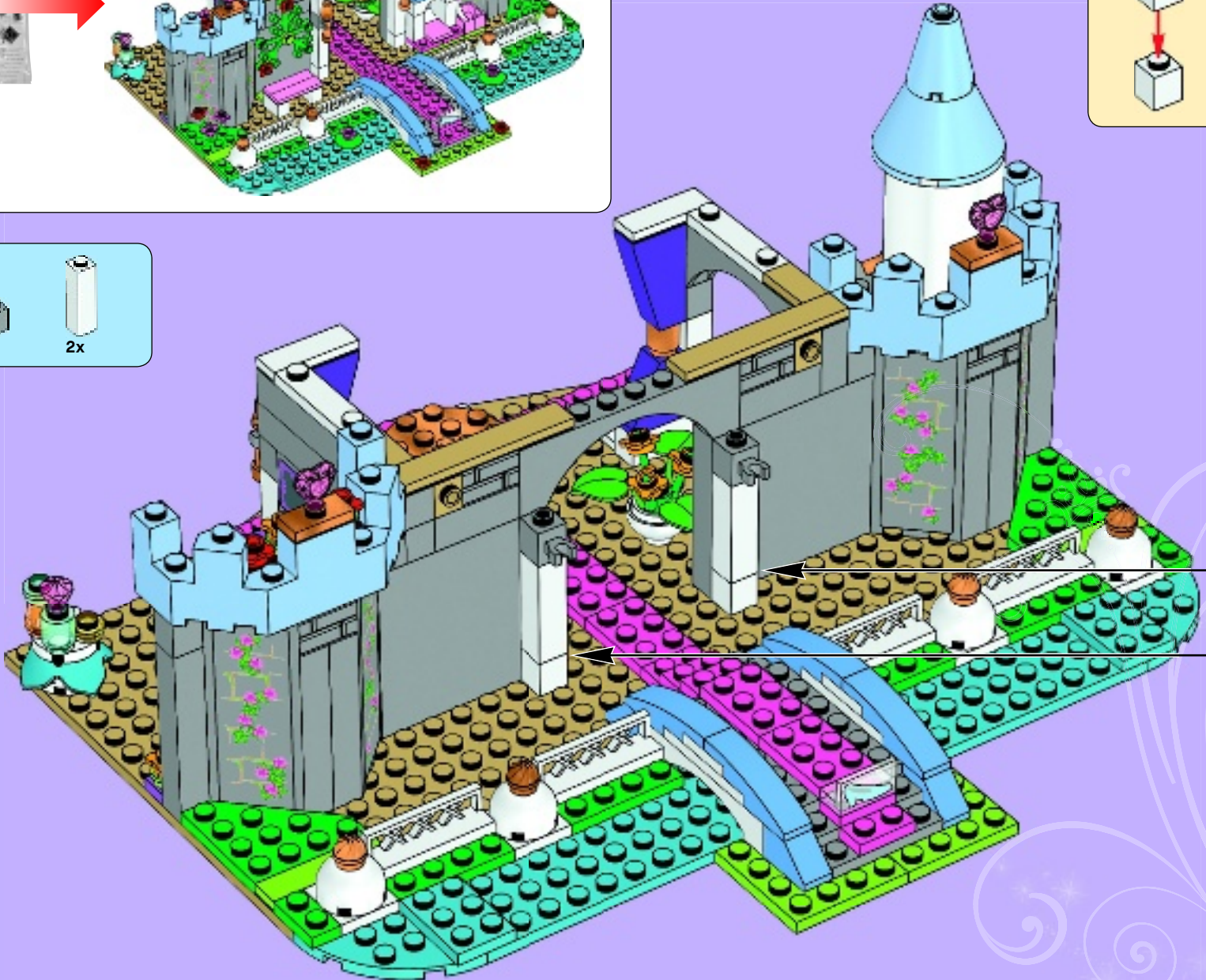
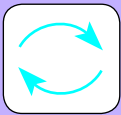



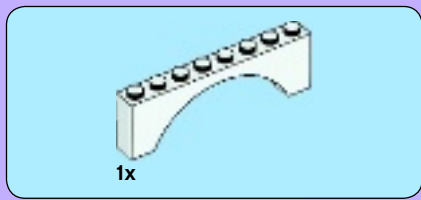

73

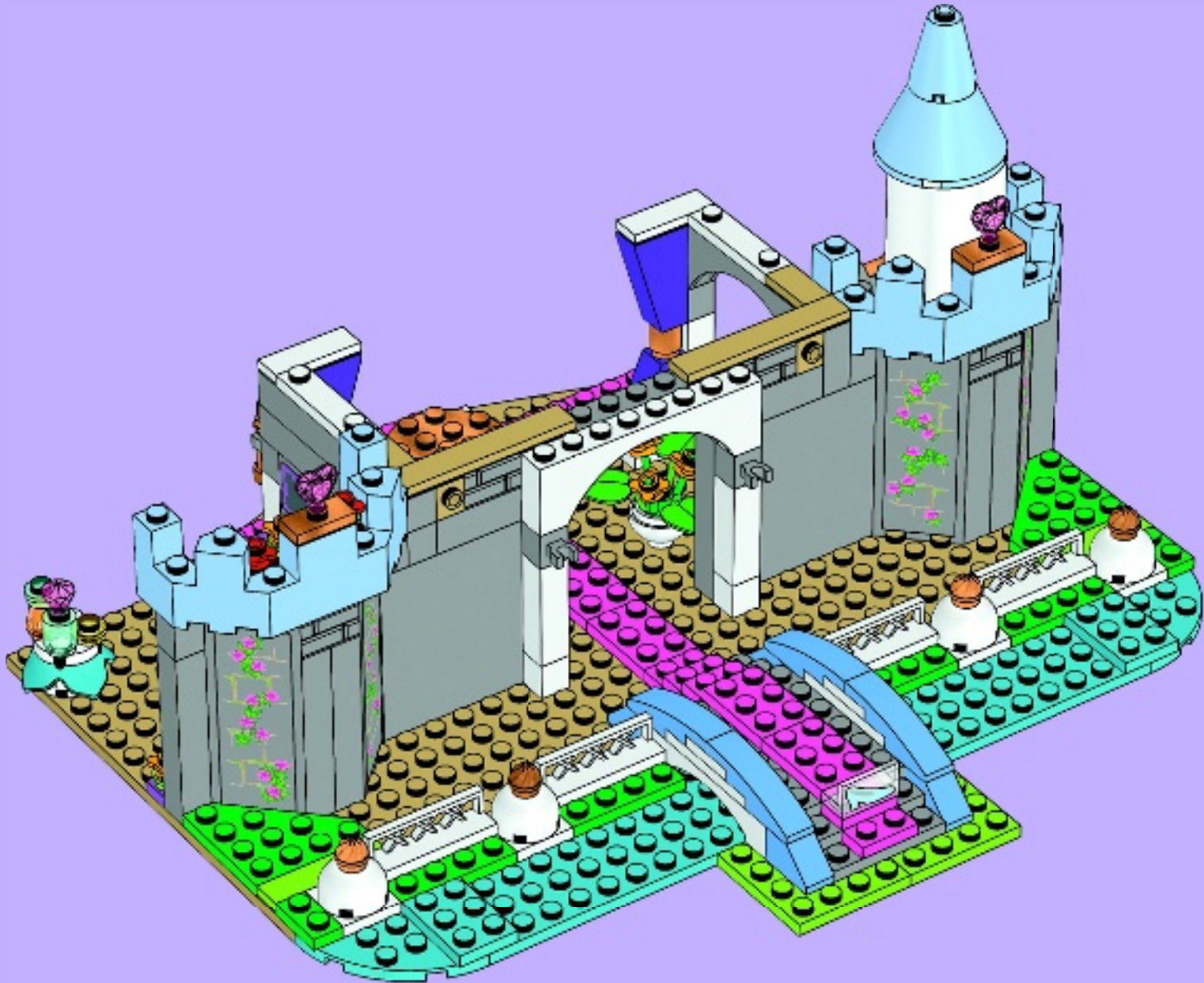



74

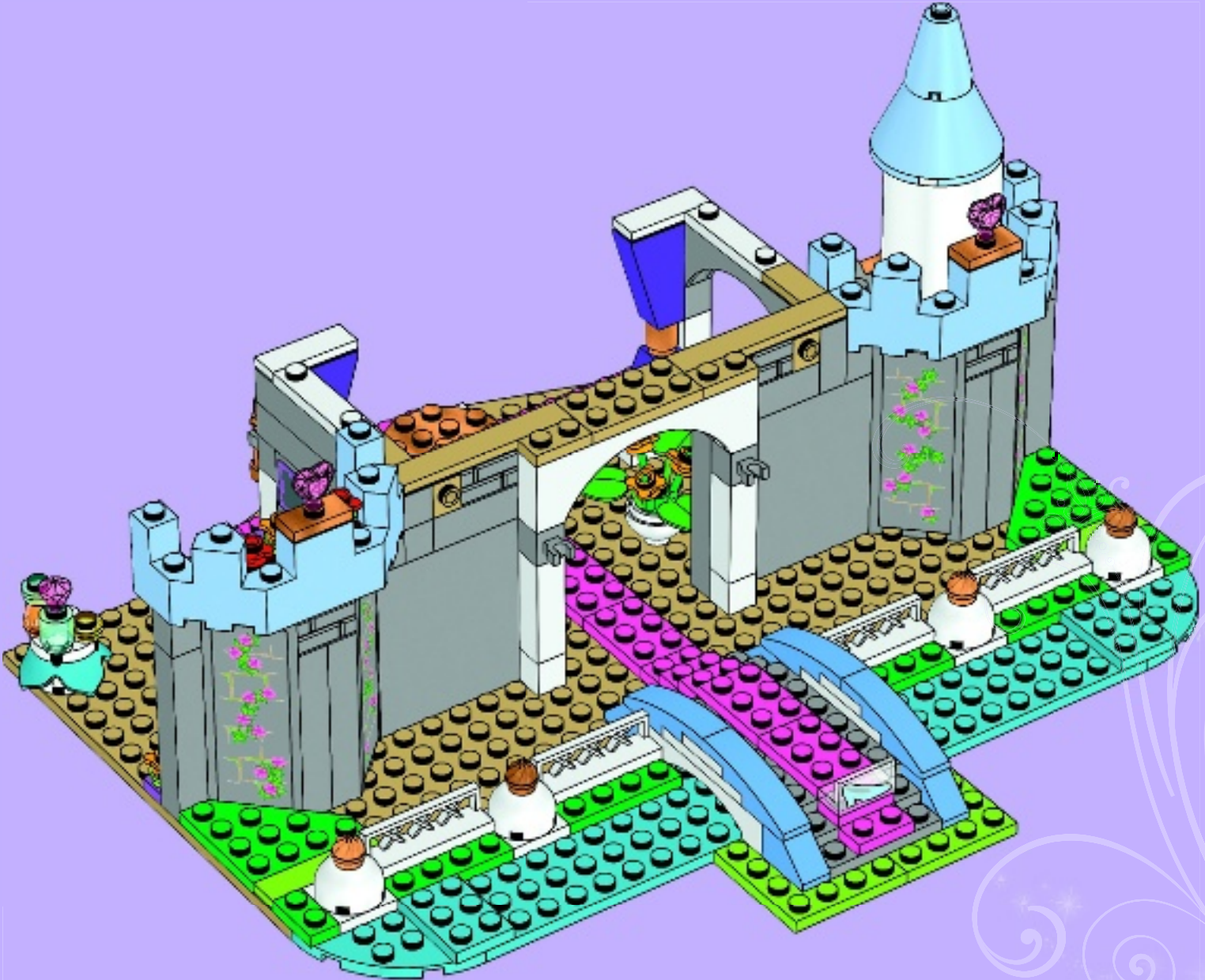





2x

75

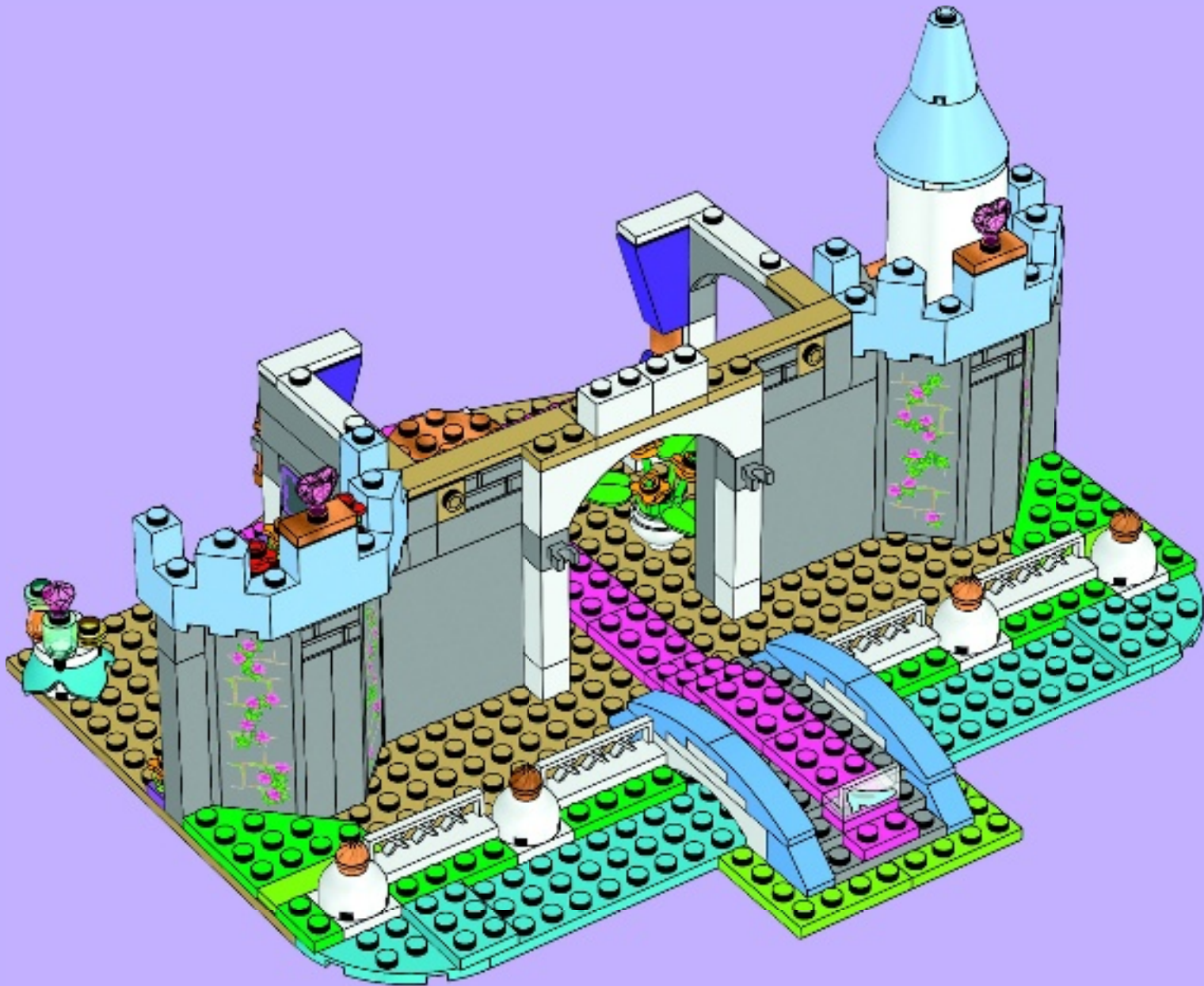





76

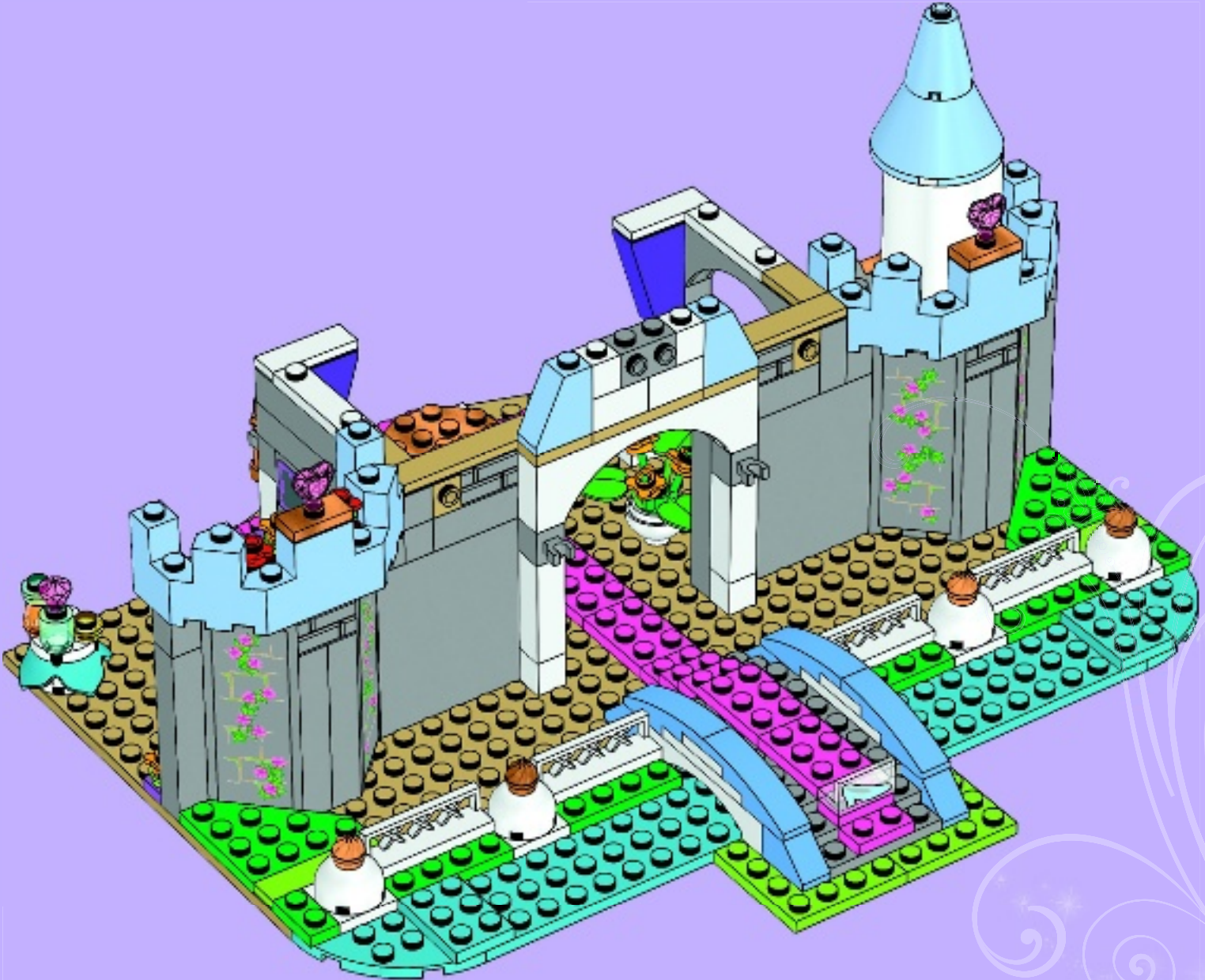



2x

77

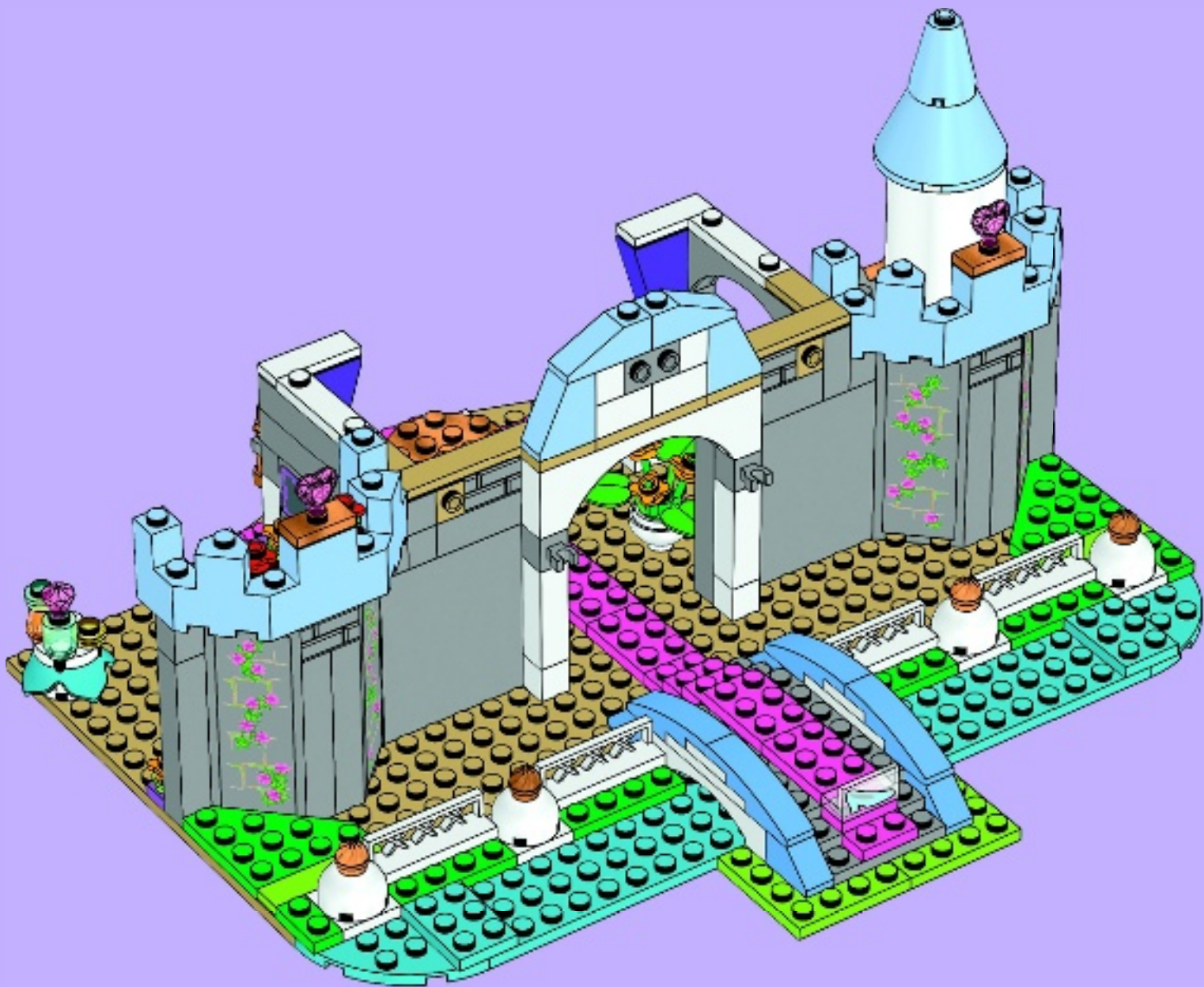



2x  1x 

78

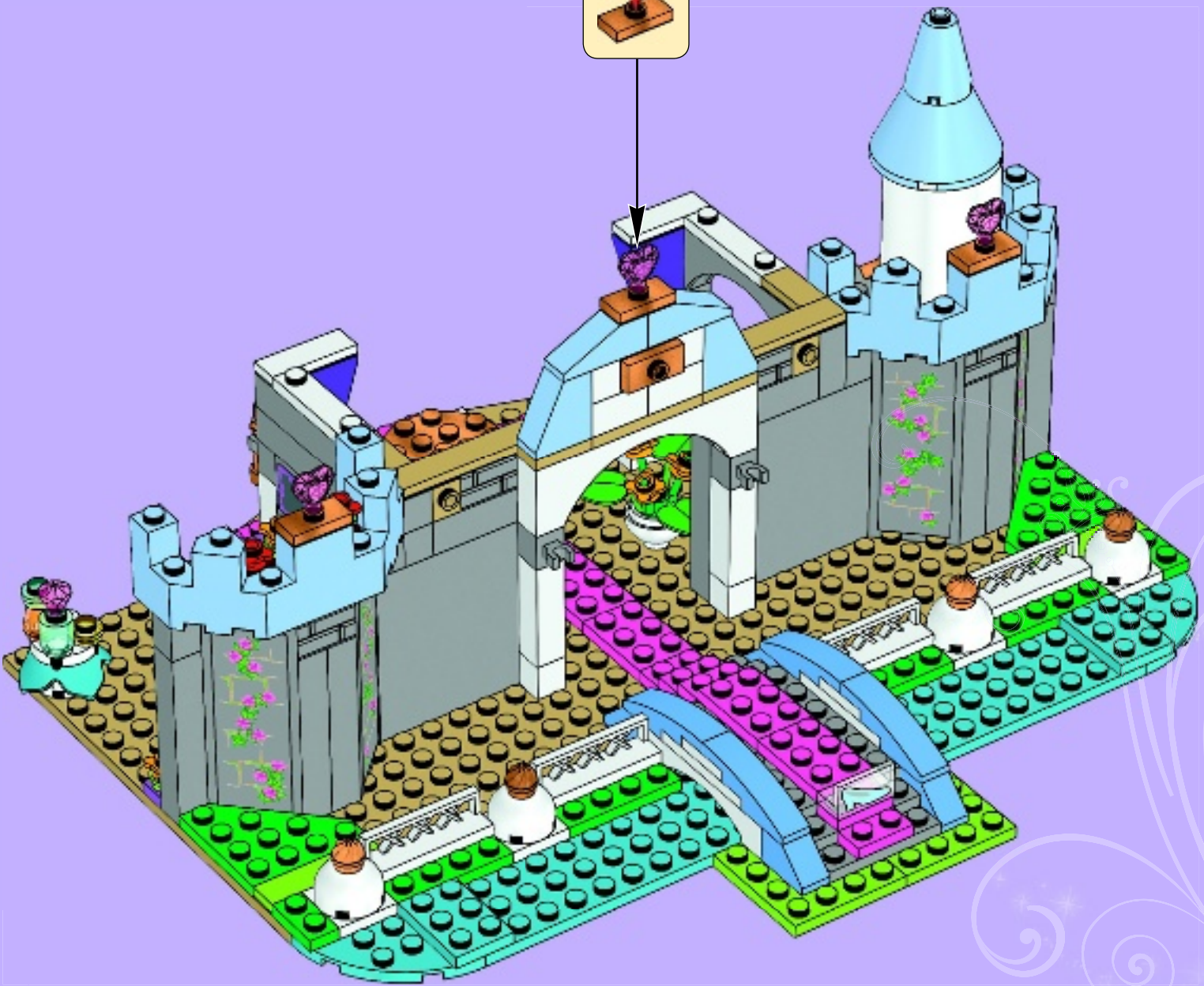
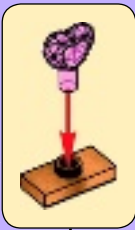



2x 2x 1x

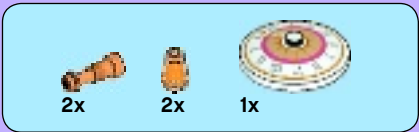

# 79

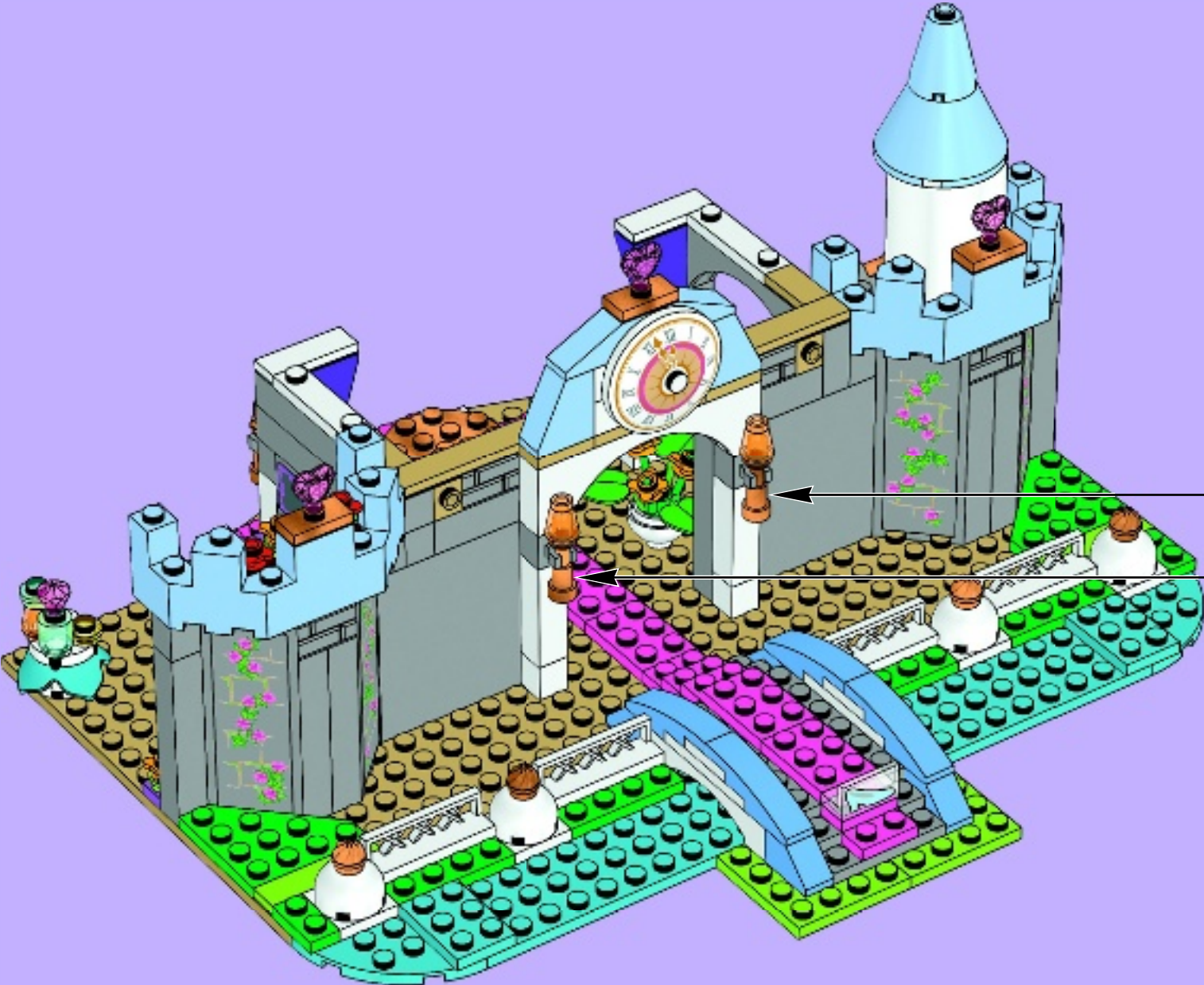

2x





# 80

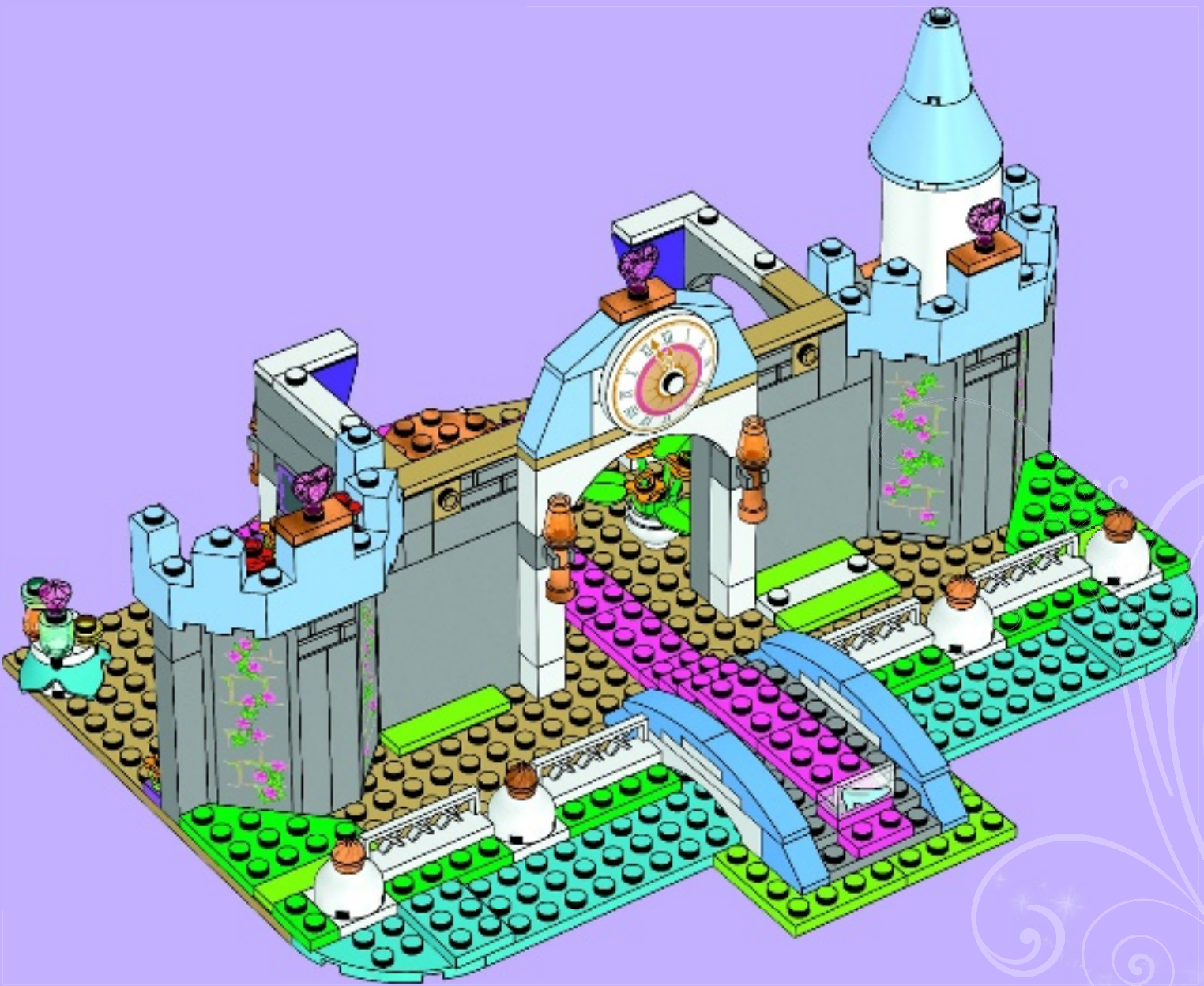



1x 4x 1x

81

1 2 3

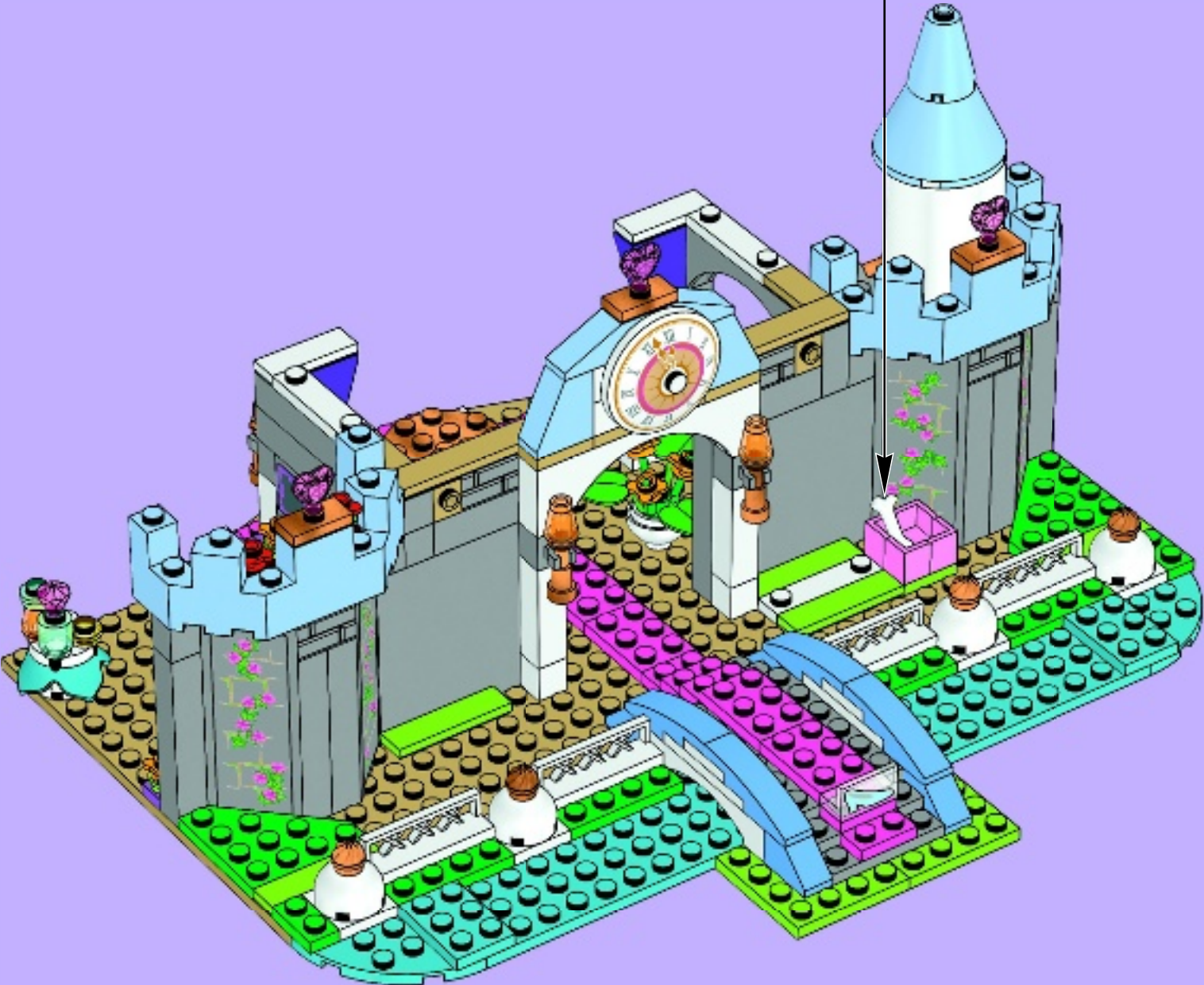



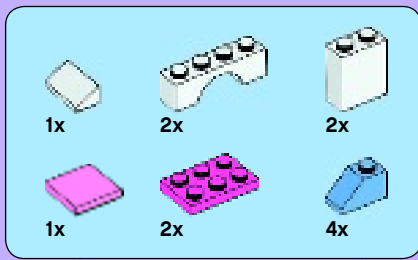

# 82

1

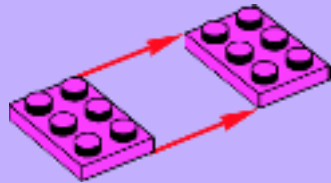

2



3

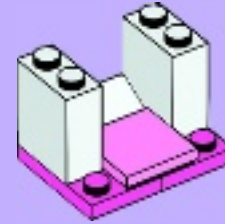

4

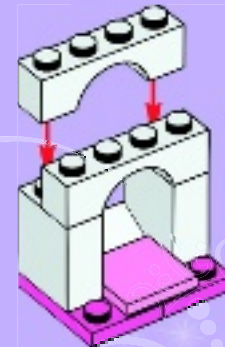

5

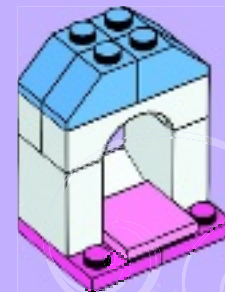

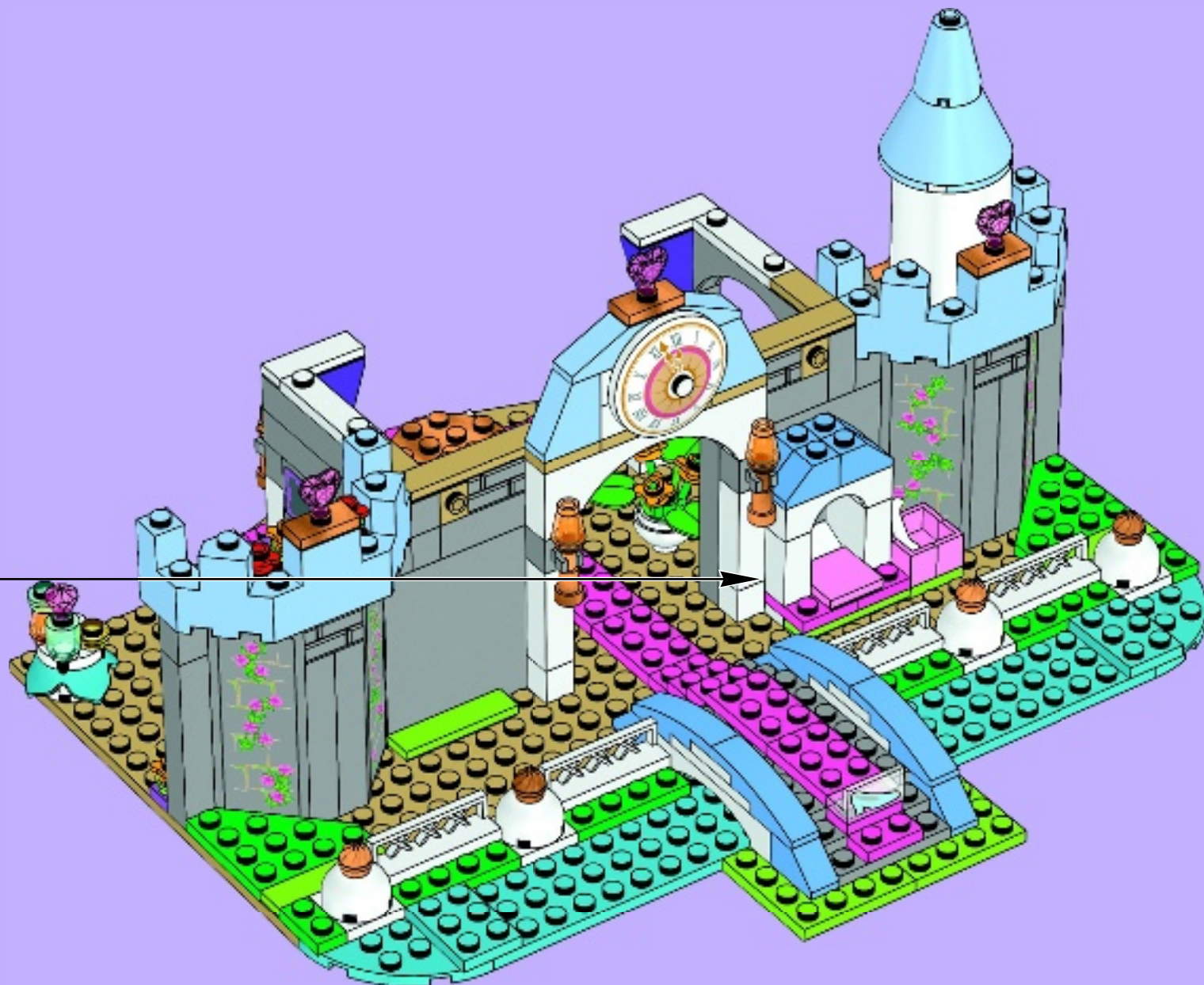

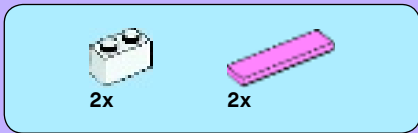

# 83

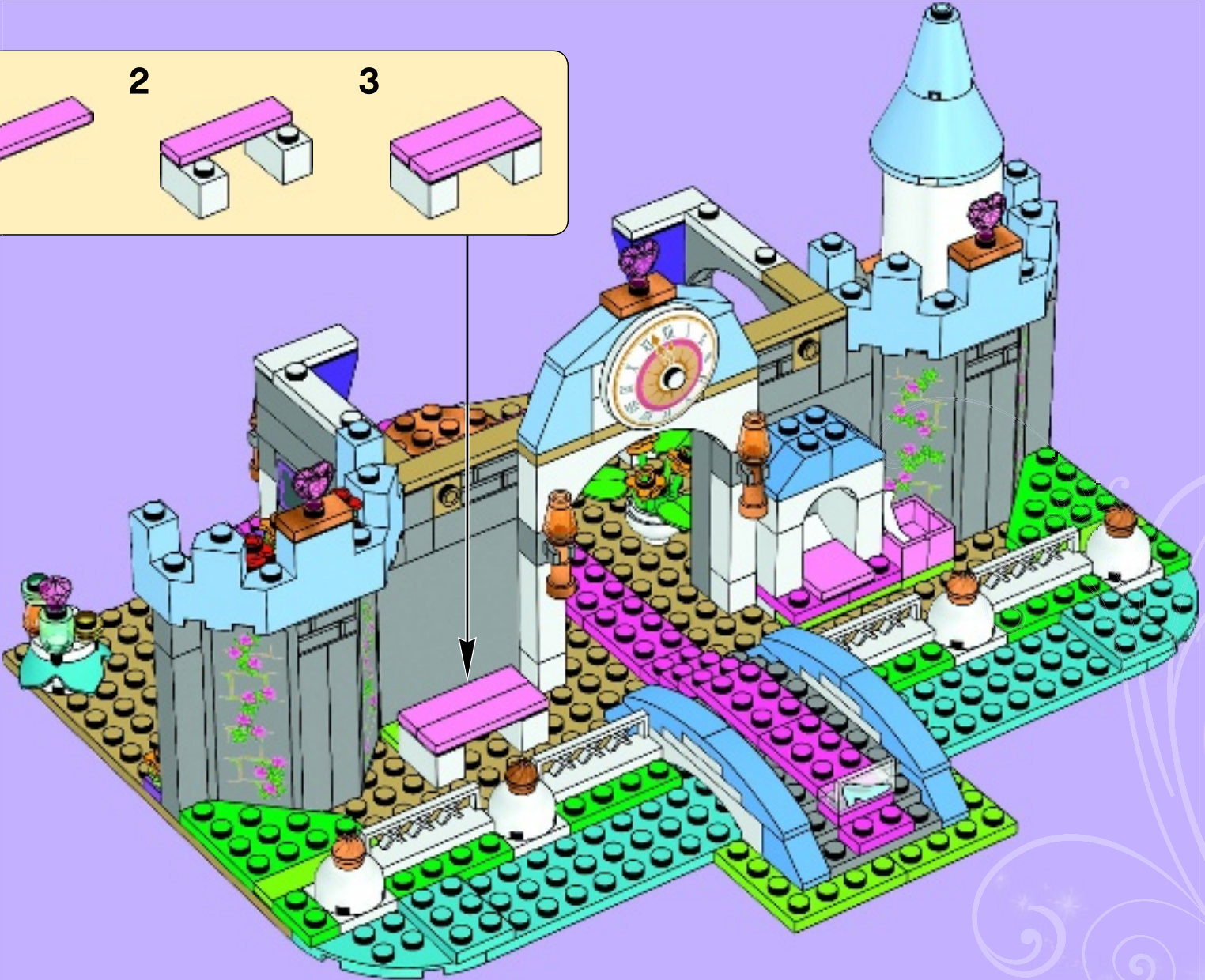
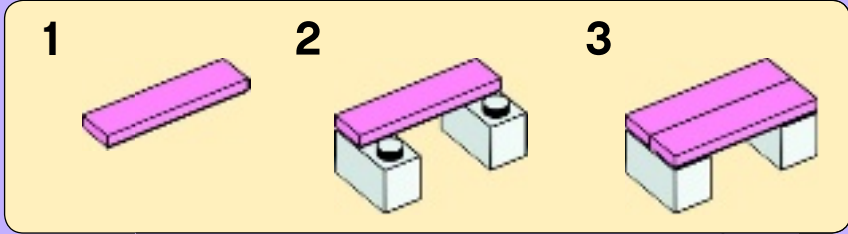



-   
4x
-   
2x
-   
2x
-   
2x

# 84

- 1  

- 2  
  
2x

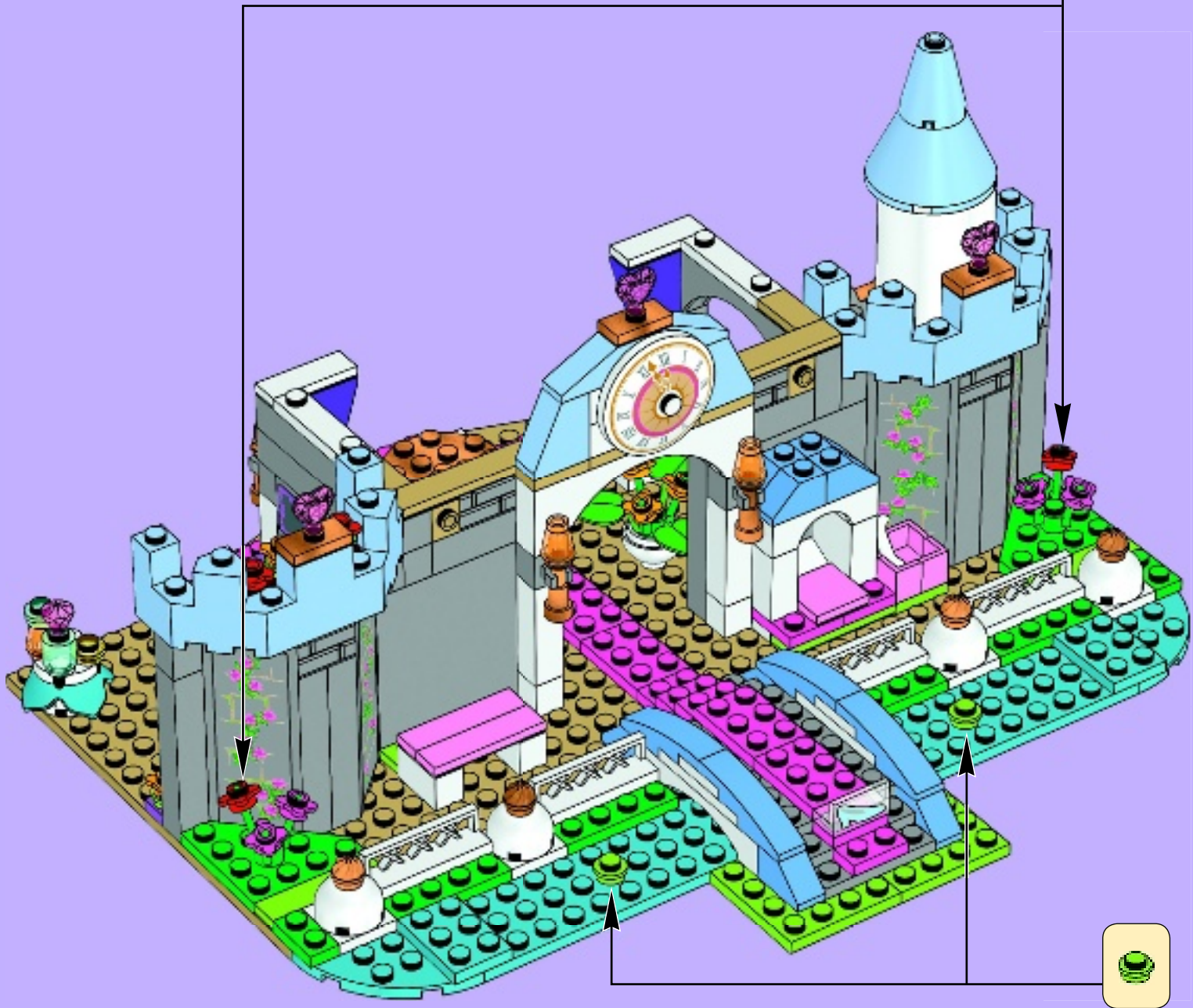

2x 2x 2x

85

2x





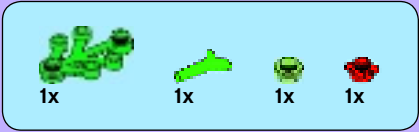

86

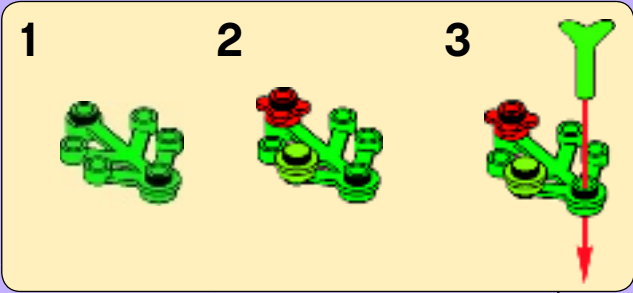



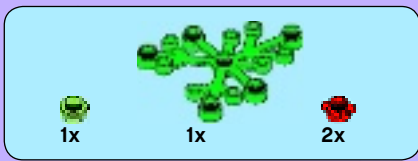

87

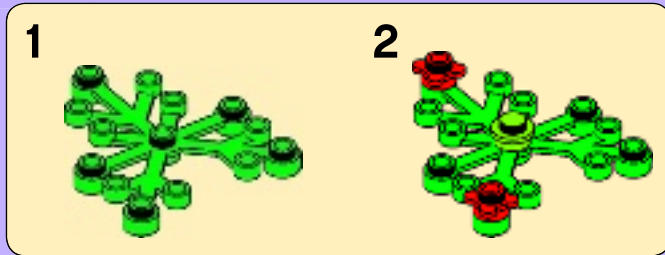

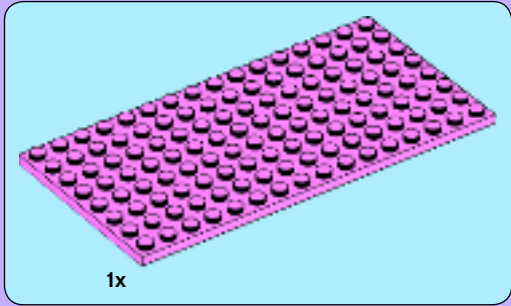
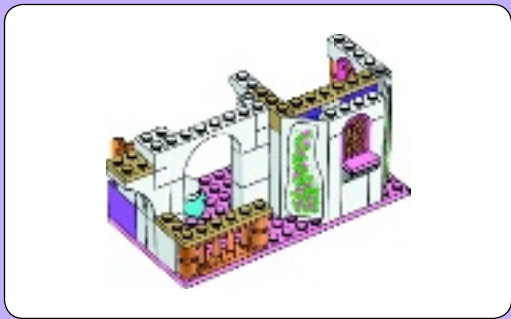

1x

1

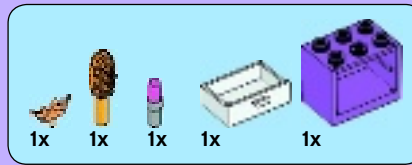
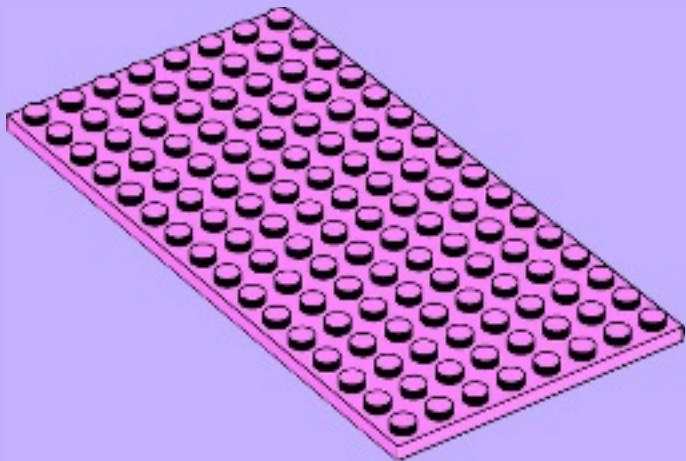

2

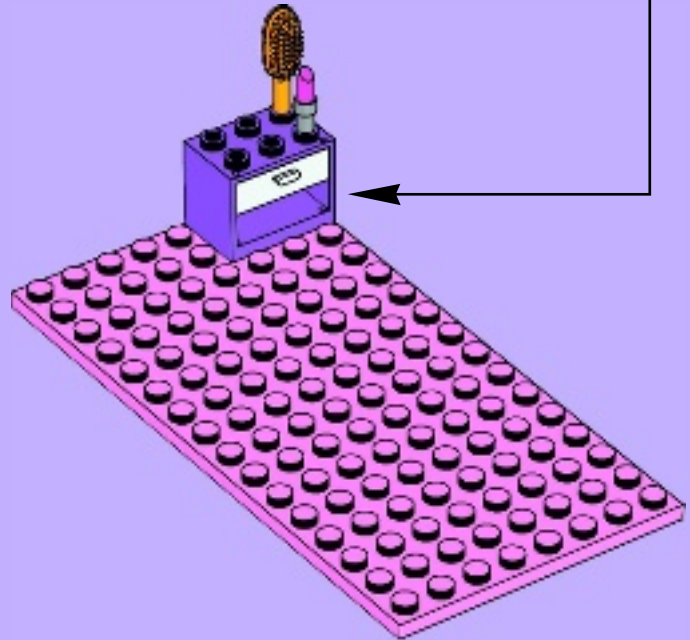
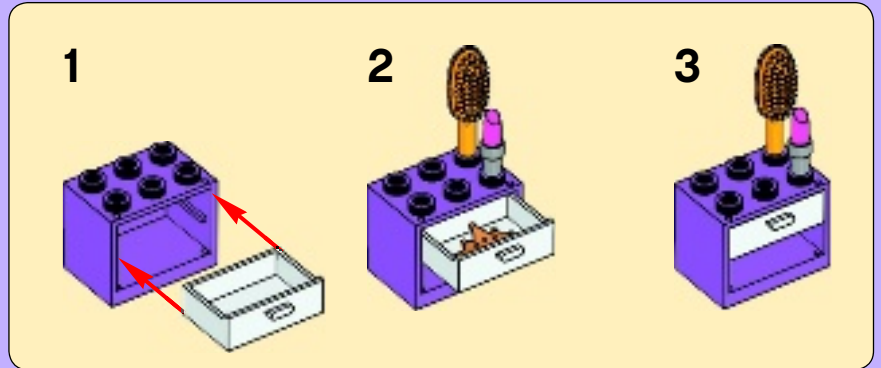

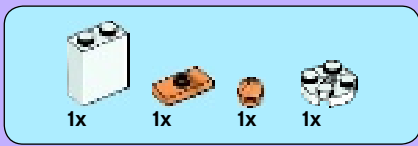

3

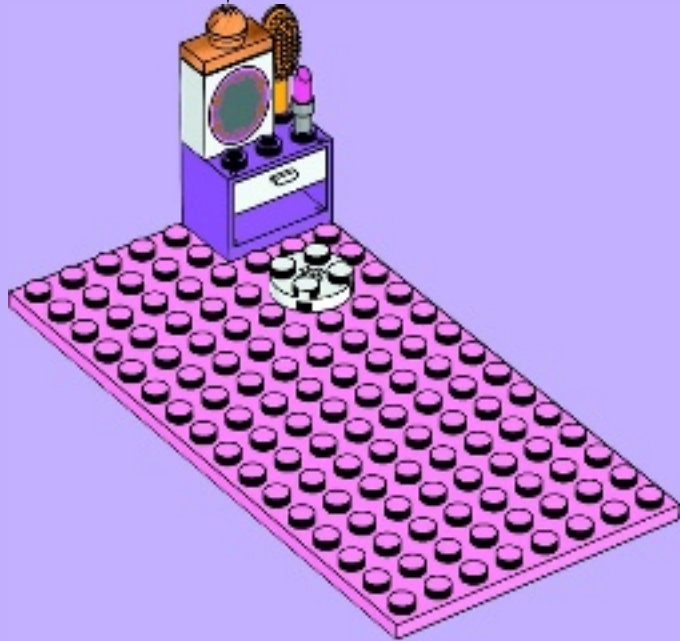
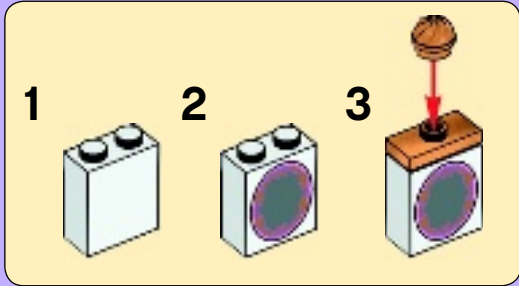

4

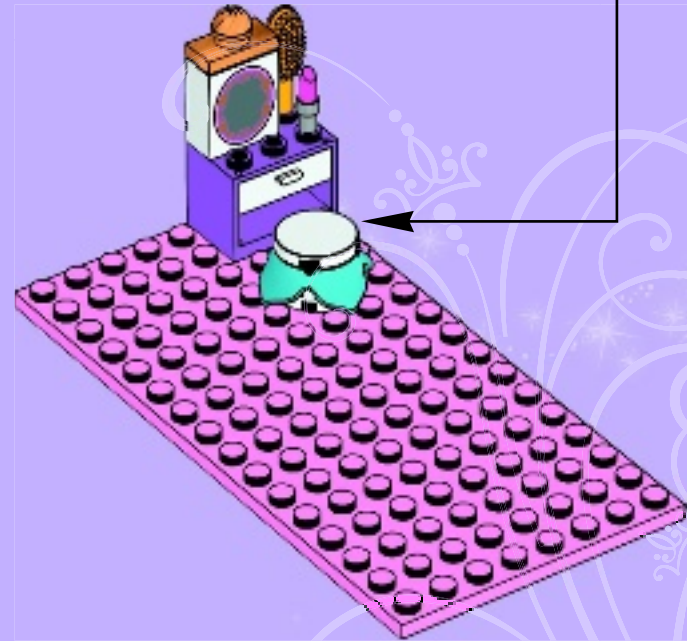
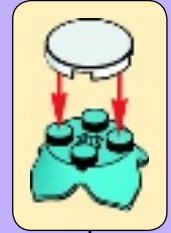





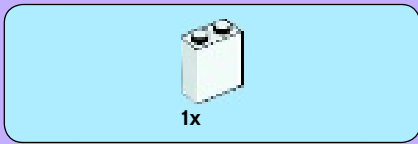

7



8

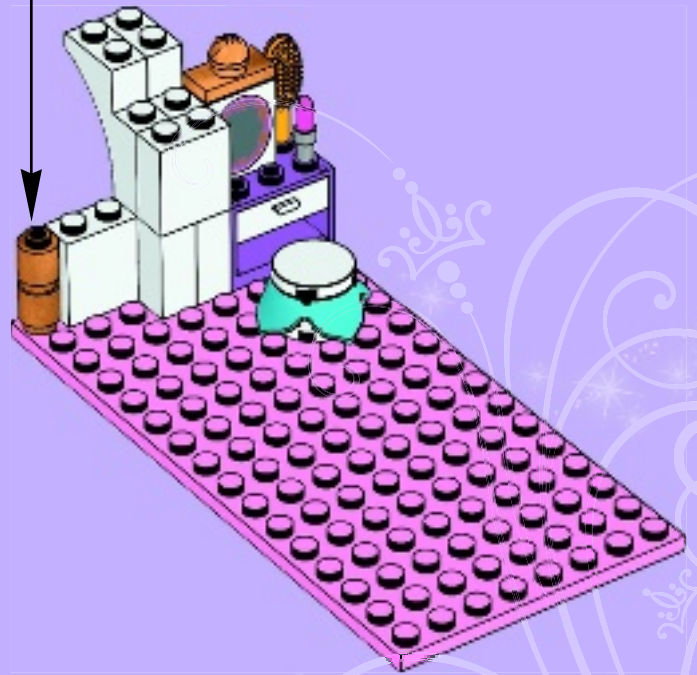

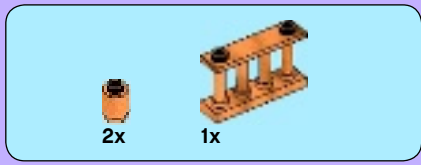

9

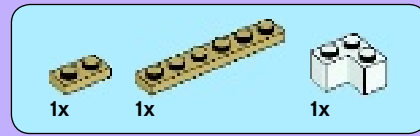
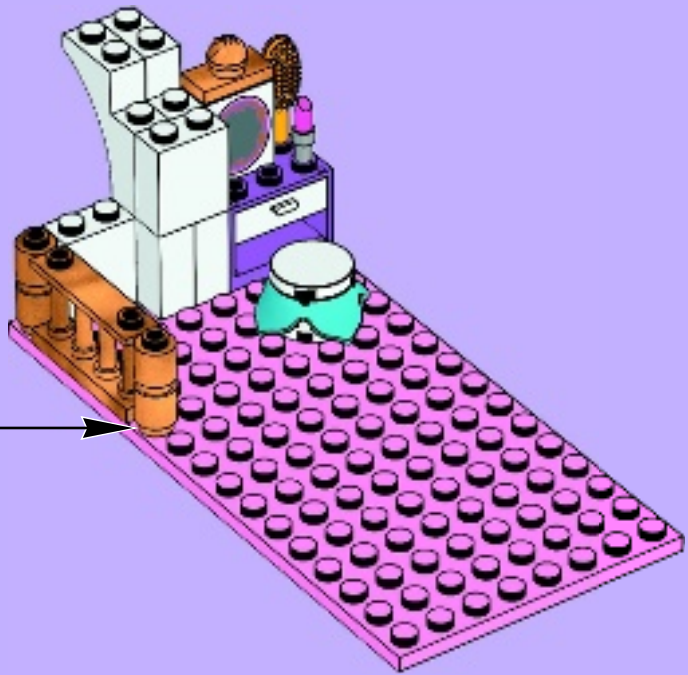

10

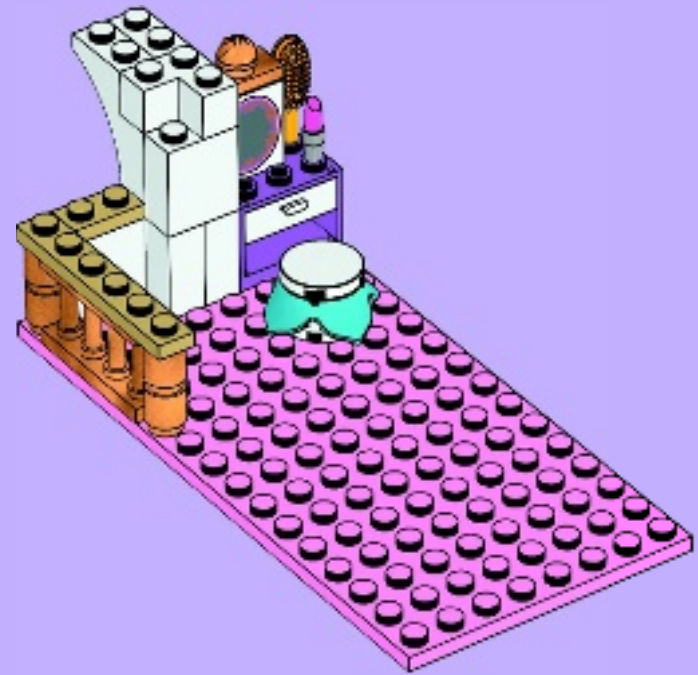





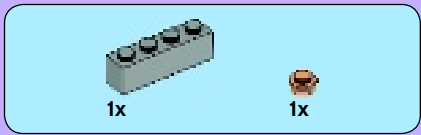

13

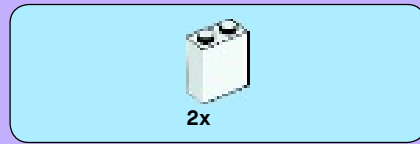
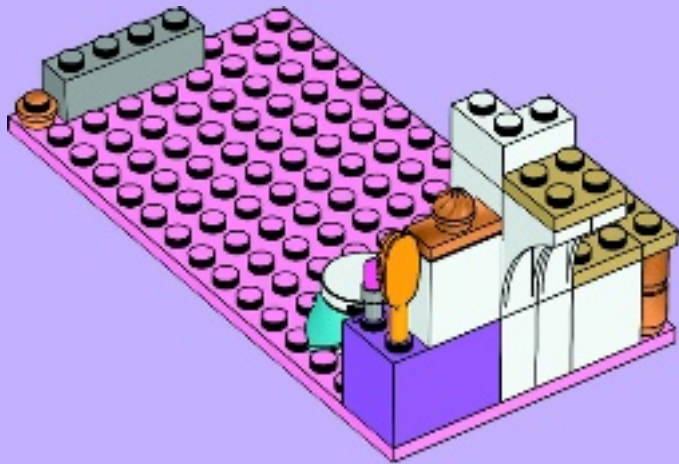
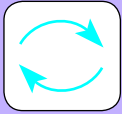

14

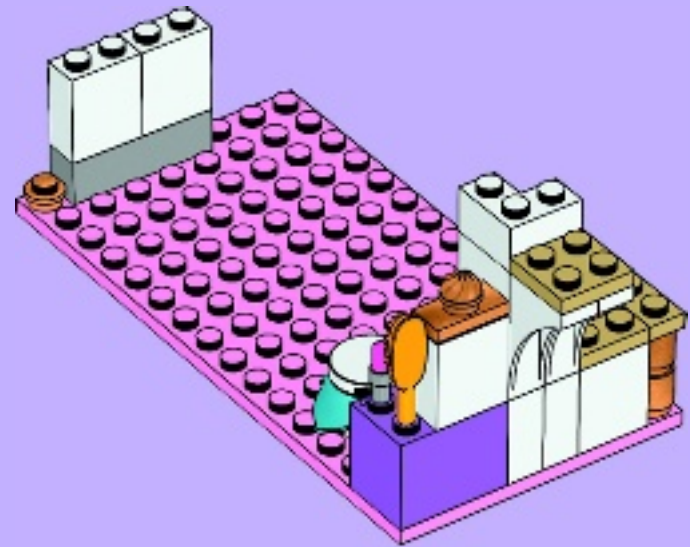



15

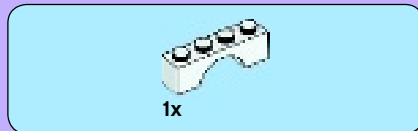
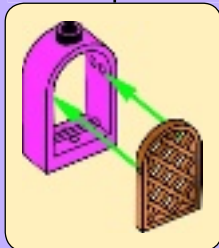
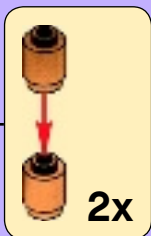

16

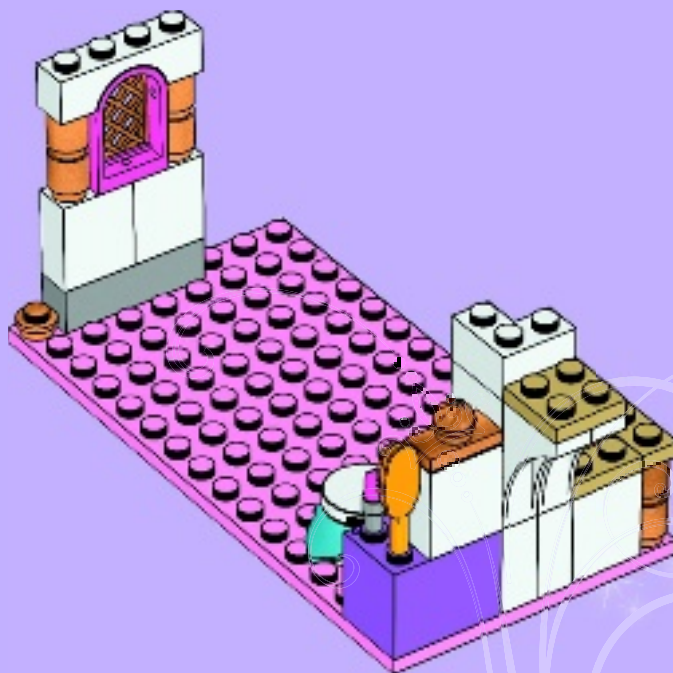



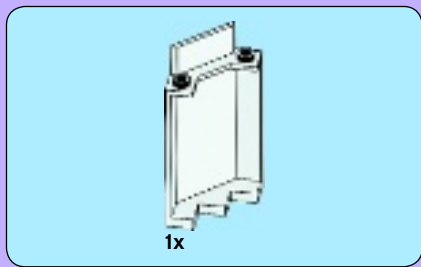

17

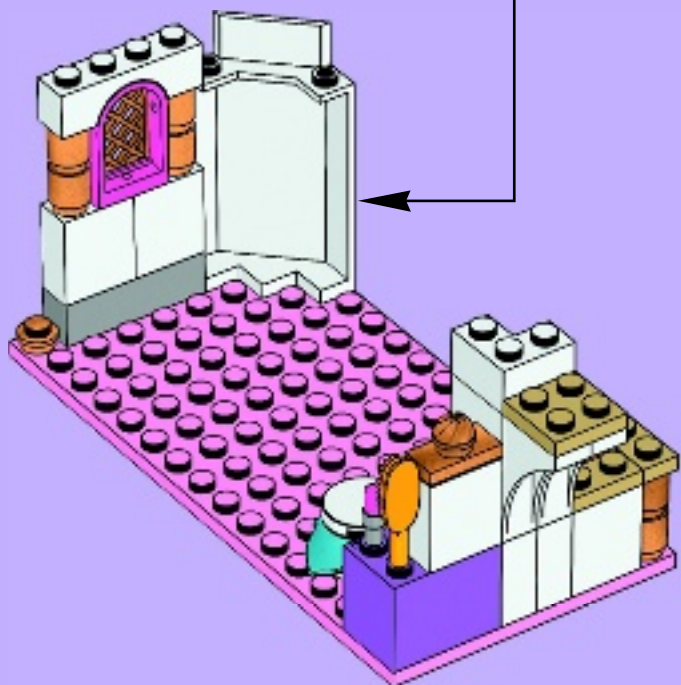
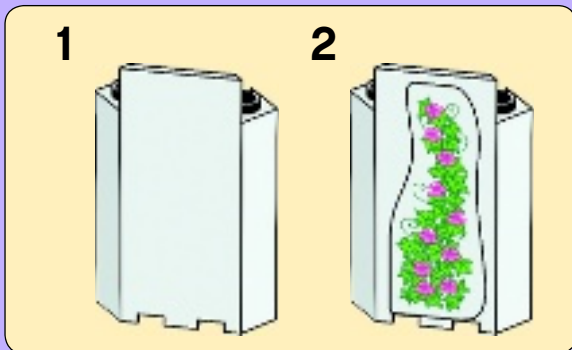

18

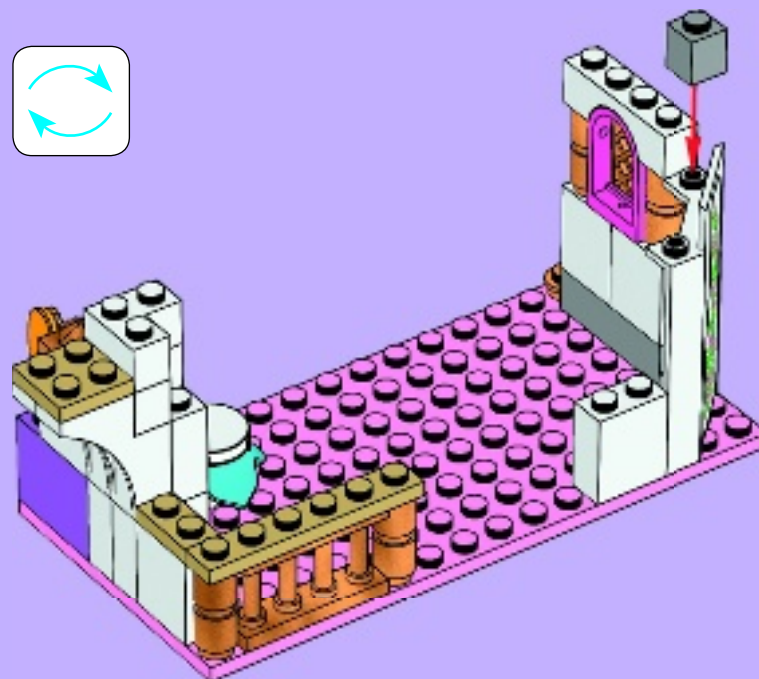
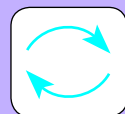



19

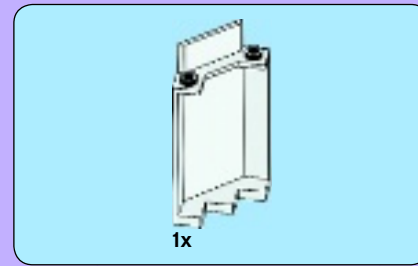
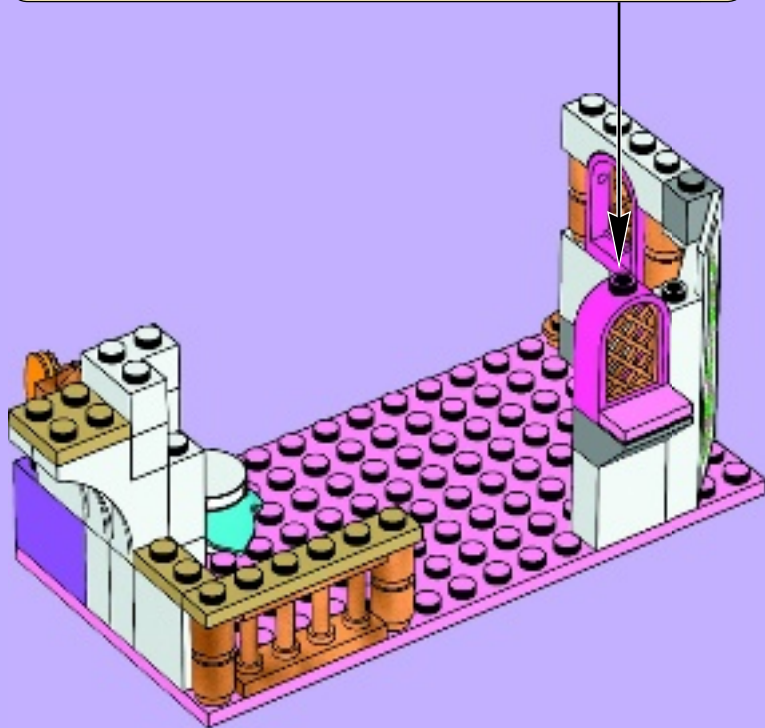
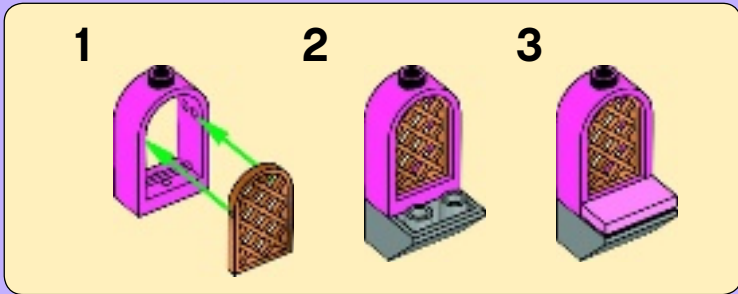

20

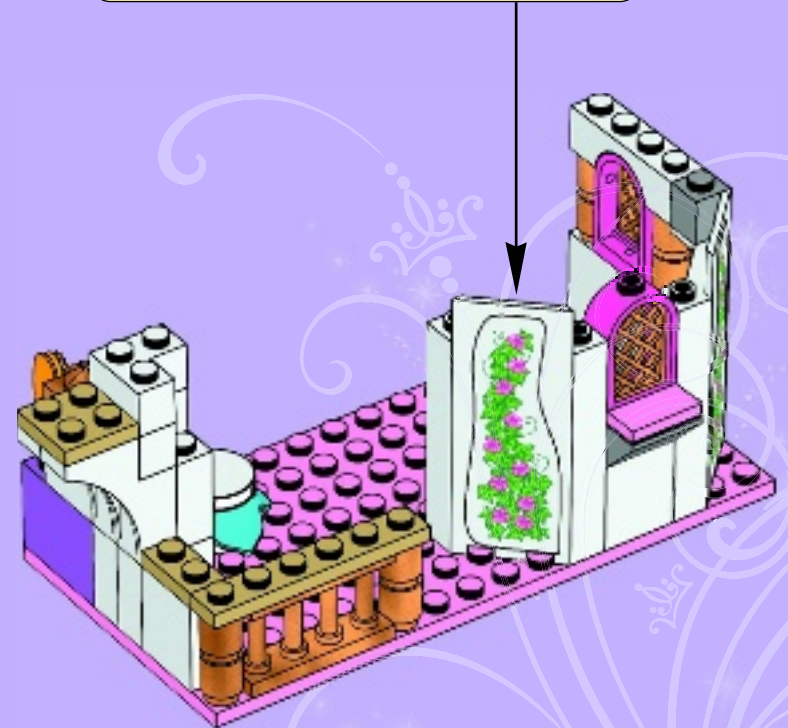
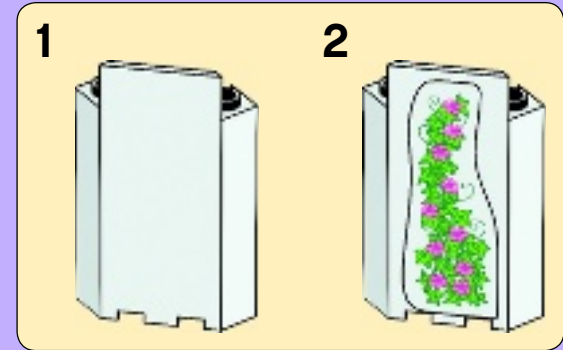

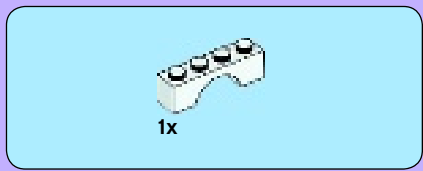

21

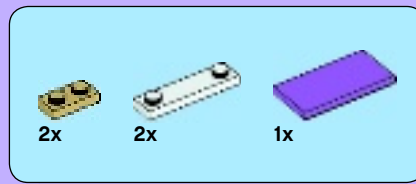
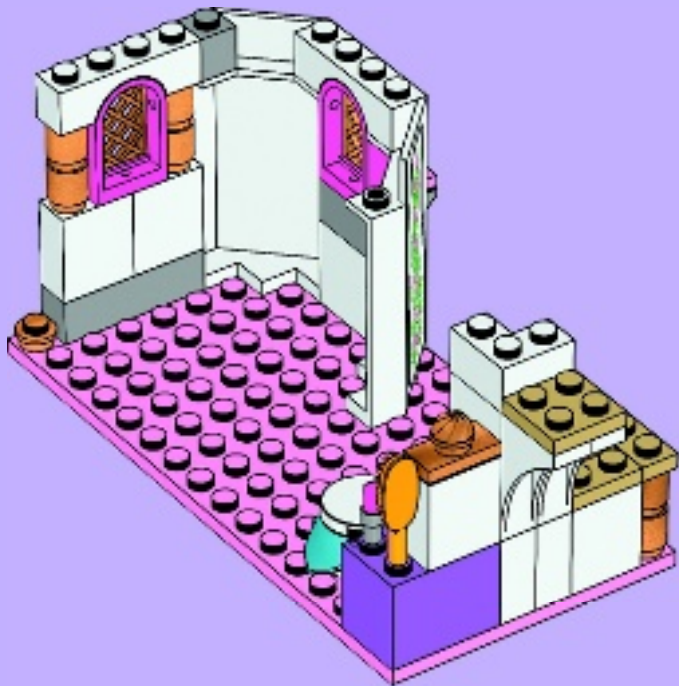
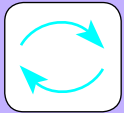

22

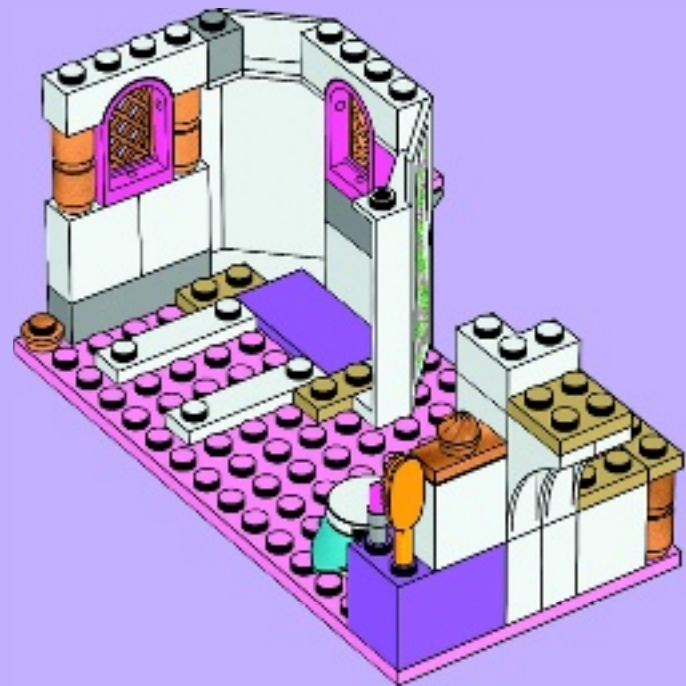





23

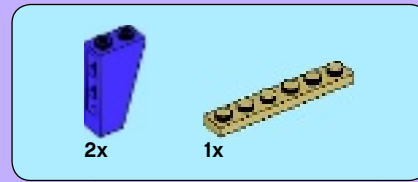
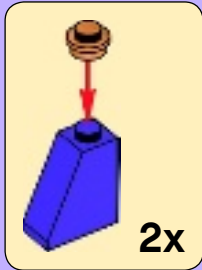

24

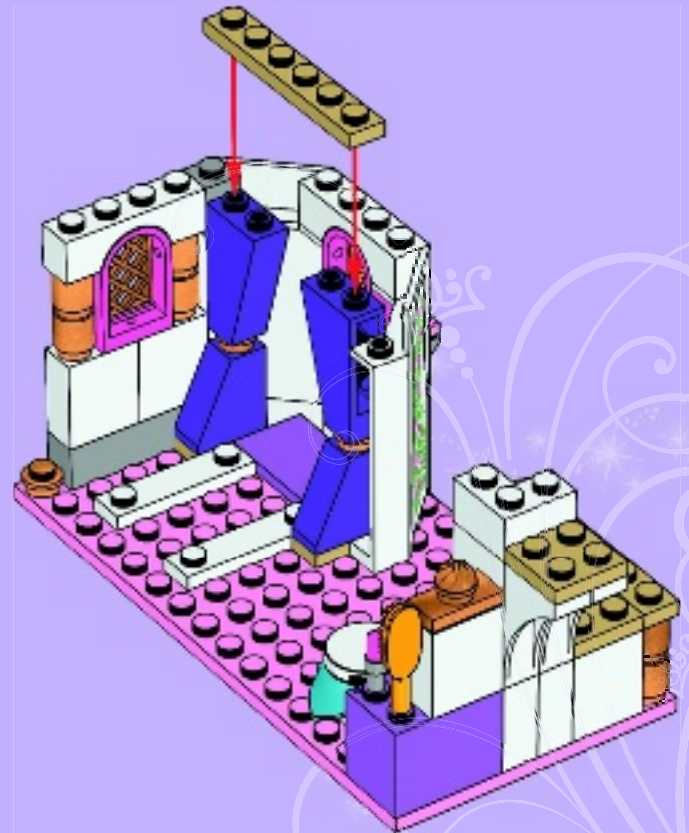

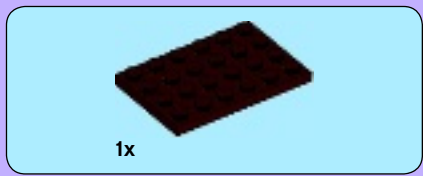

1



2

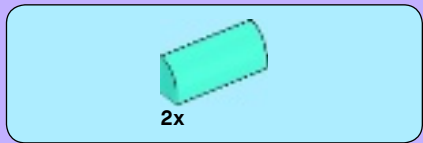

3



4

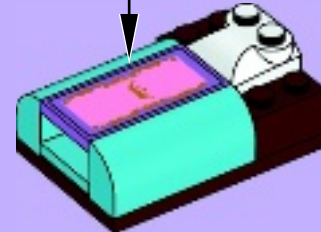
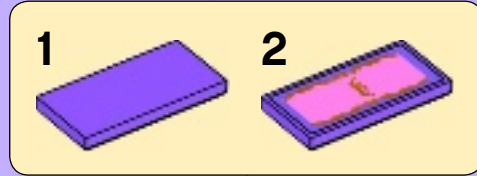

5

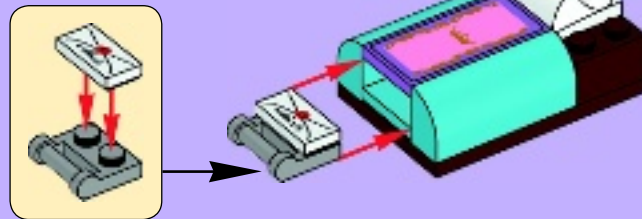

25

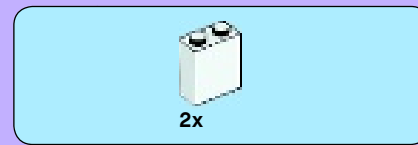
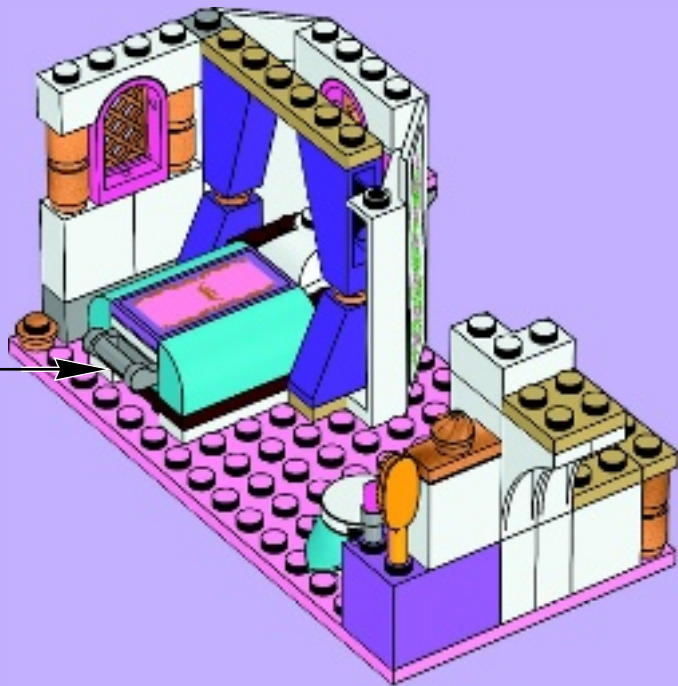

26







1x

27

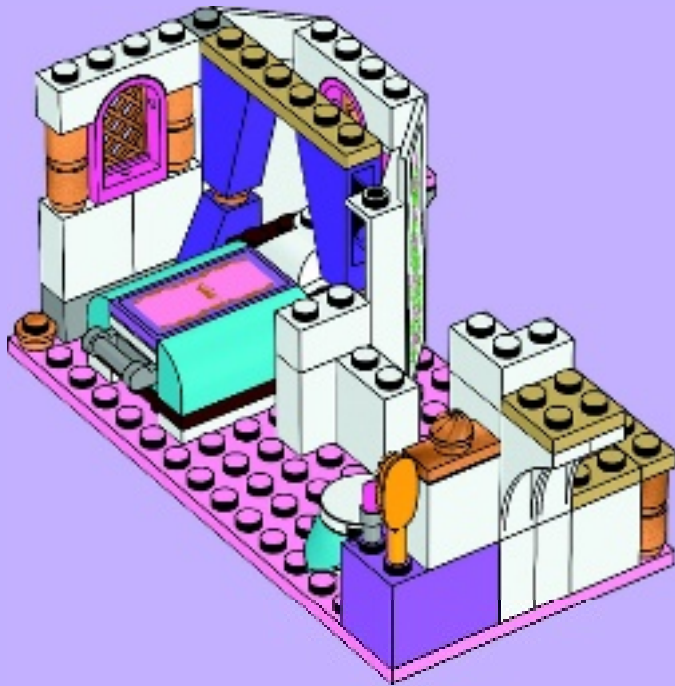

1x



1x

28

1



2

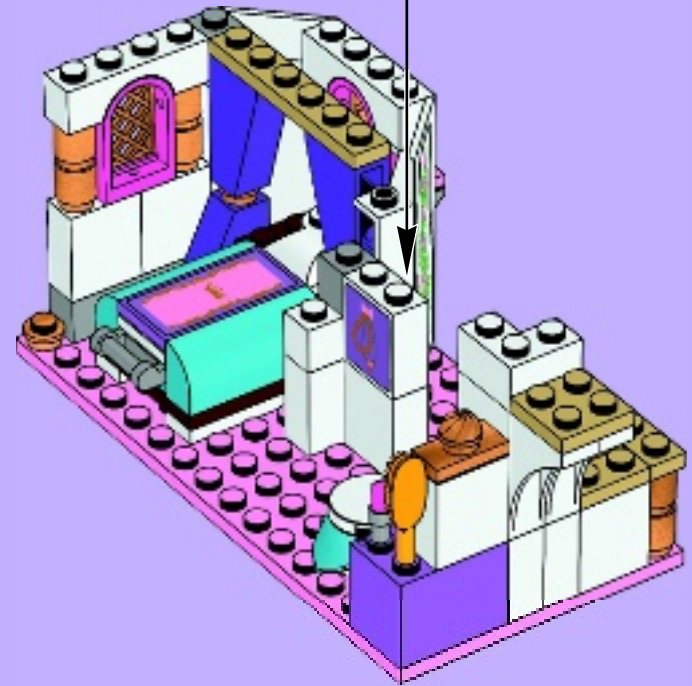

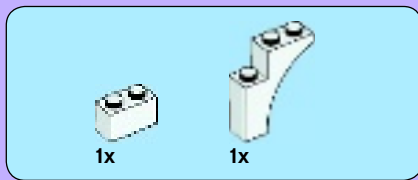

29

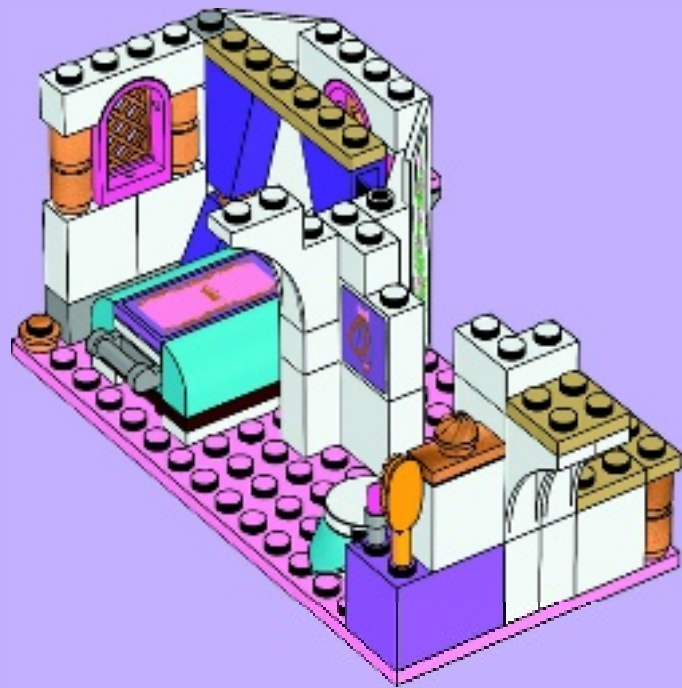

30







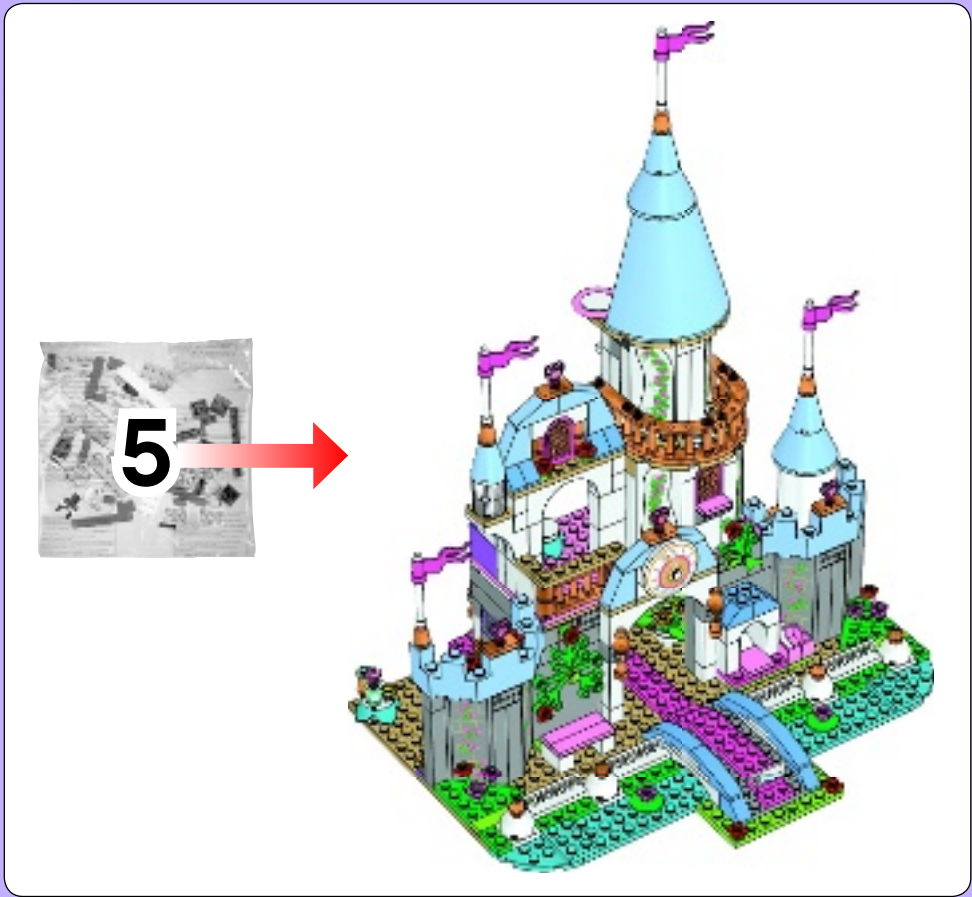

1

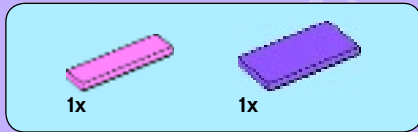

2



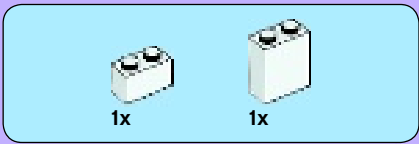

3

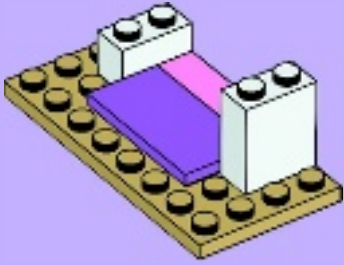

4

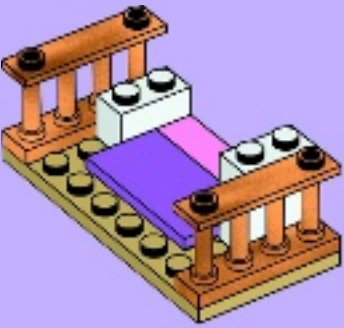

5

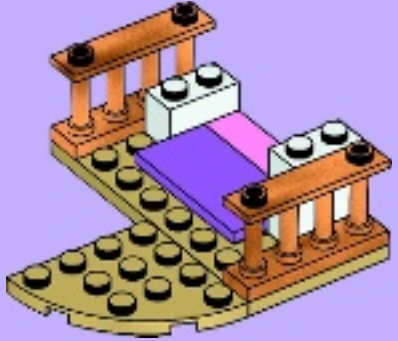

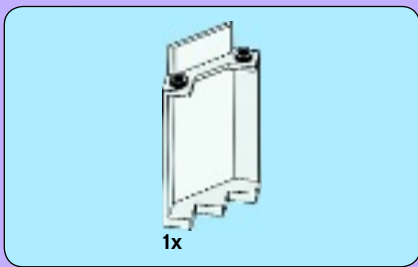

6

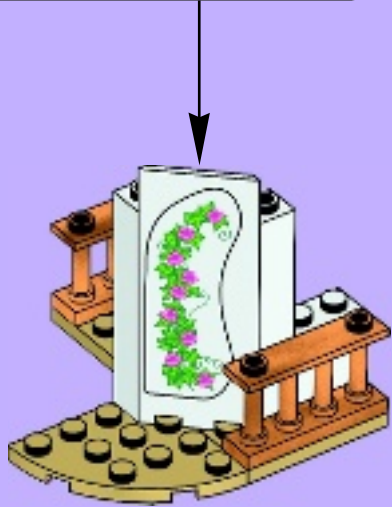
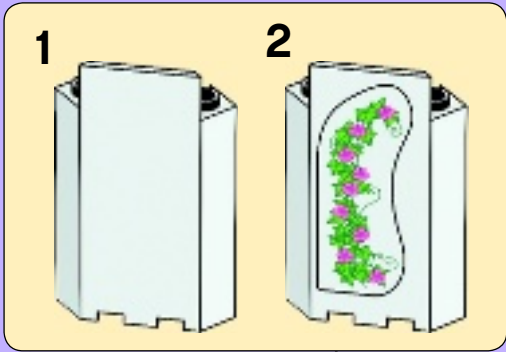

7

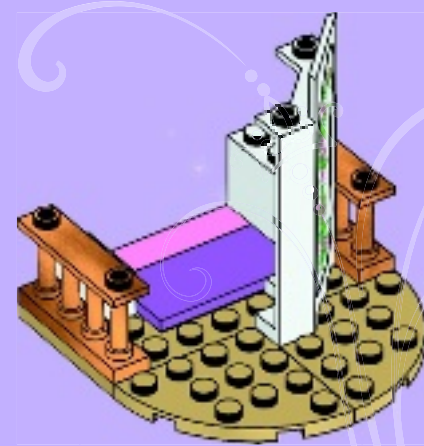
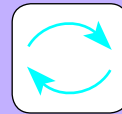



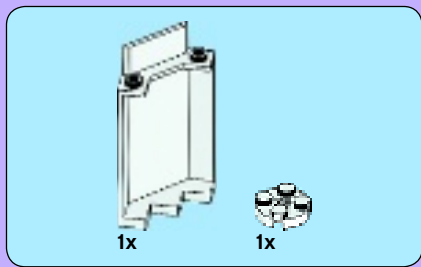

8

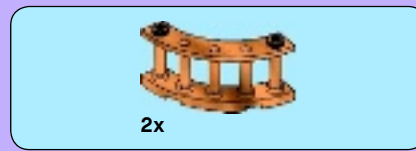
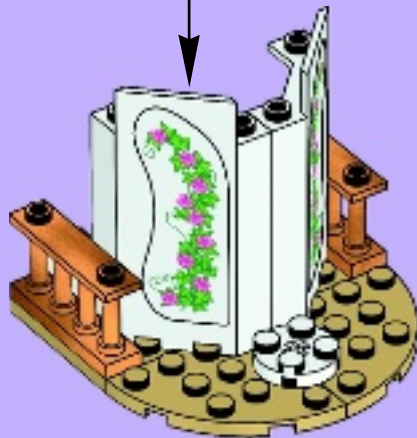
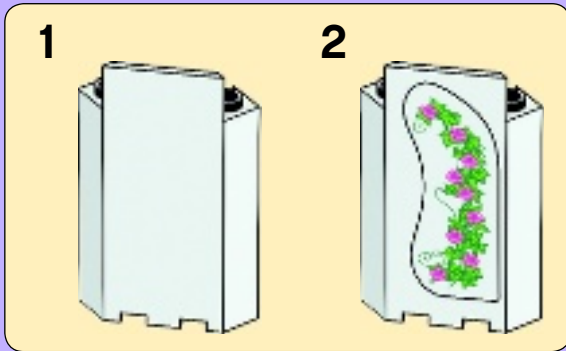

9

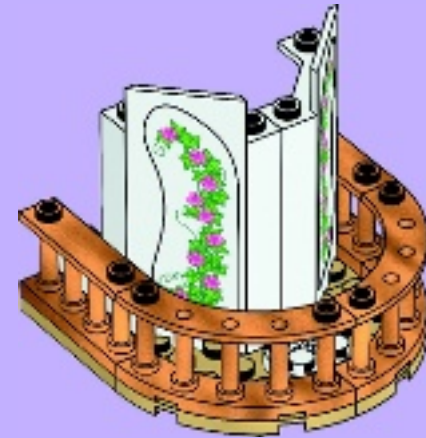

10

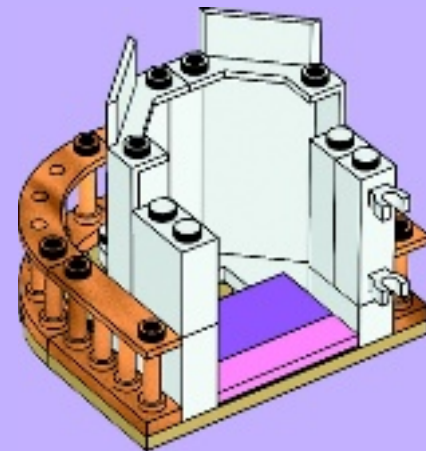
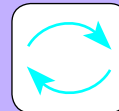



11

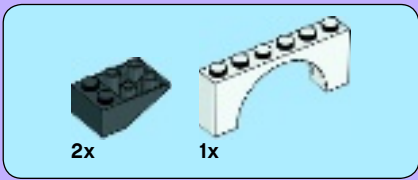
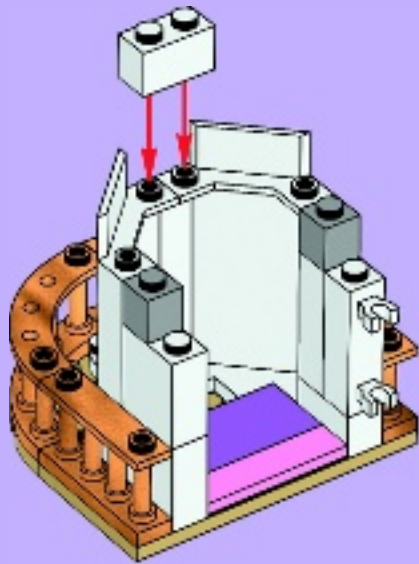

12

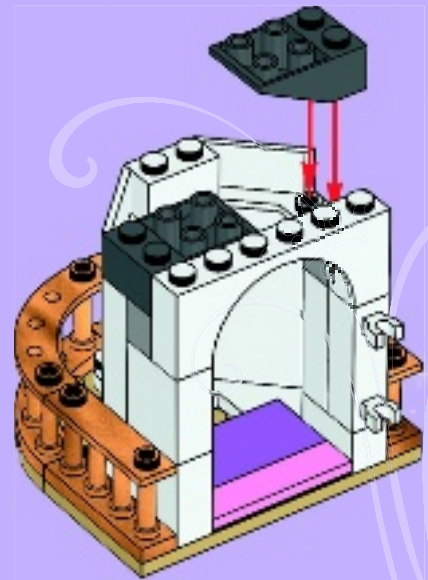



1

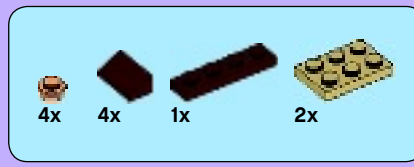

2

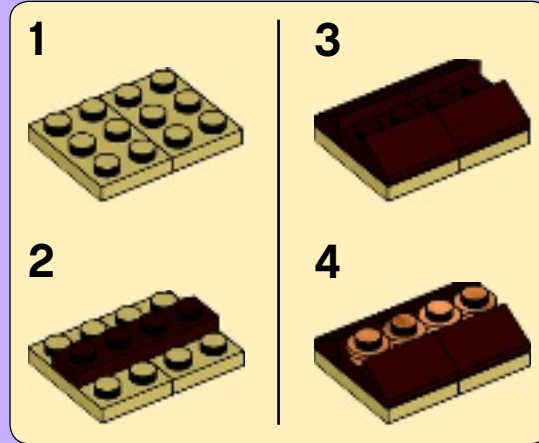



13

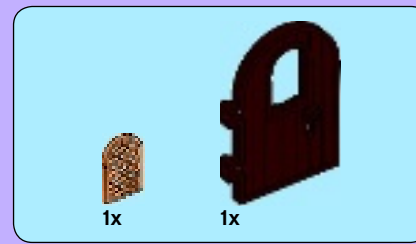
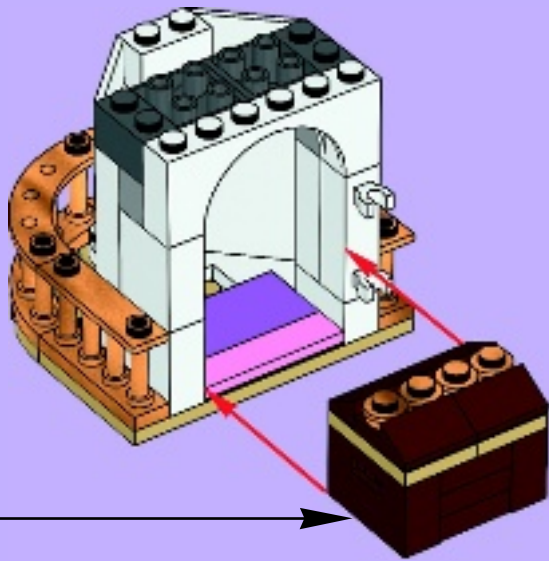

14

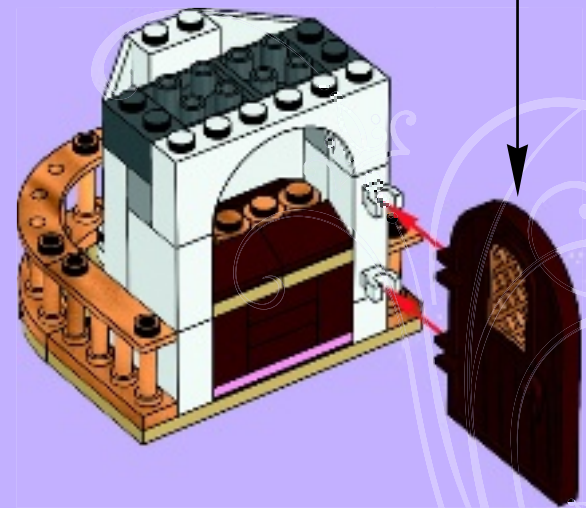

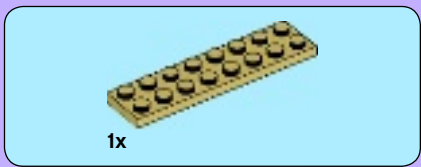

15

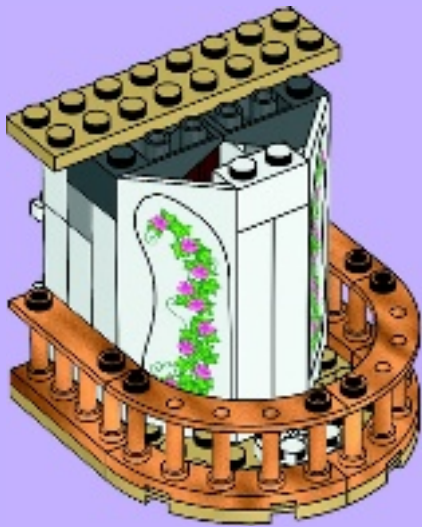
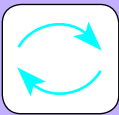

16

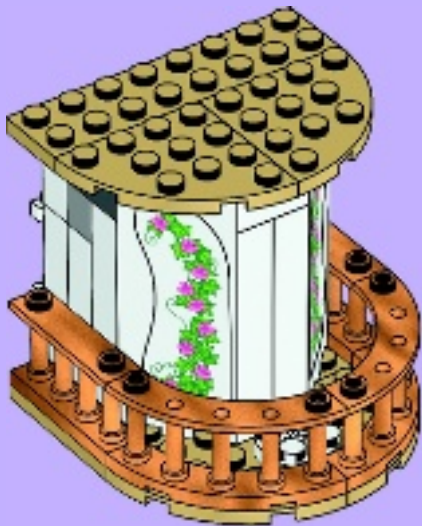

17

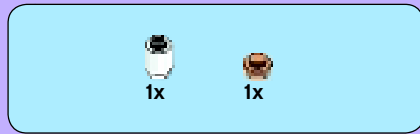
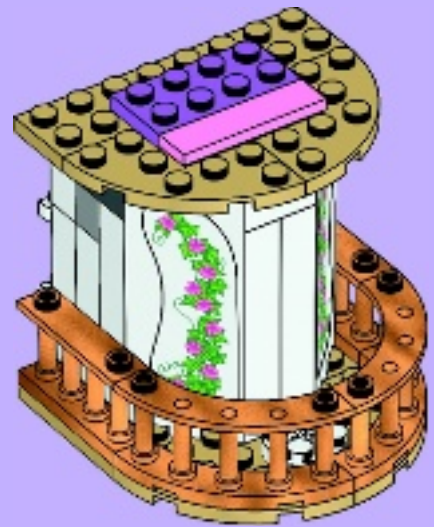

18

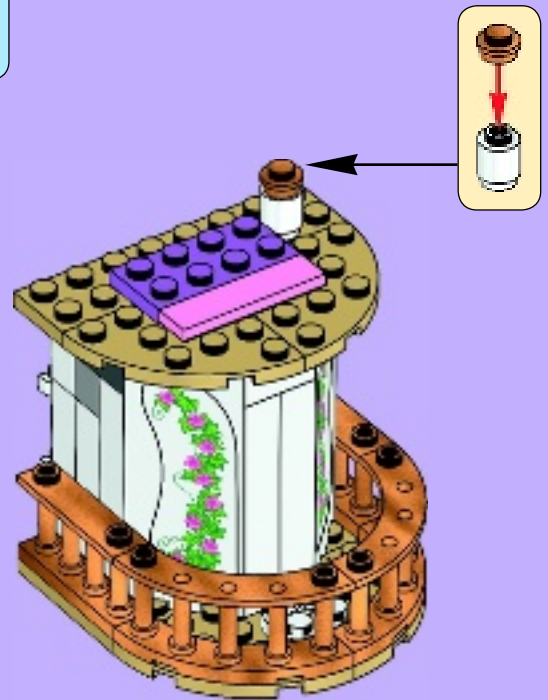



19

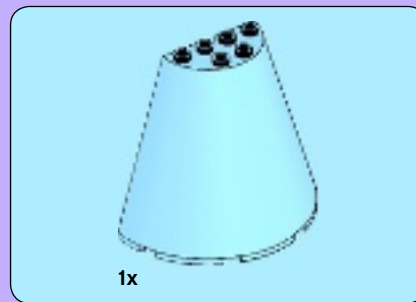
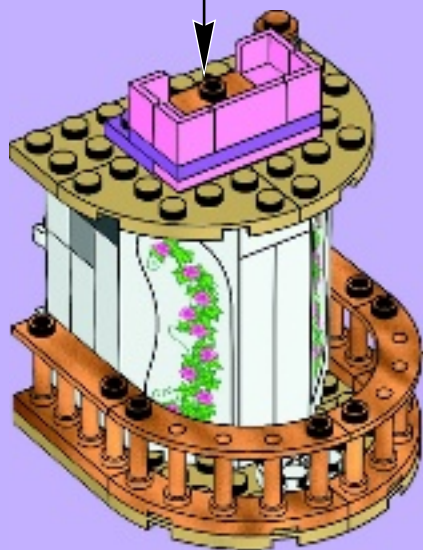
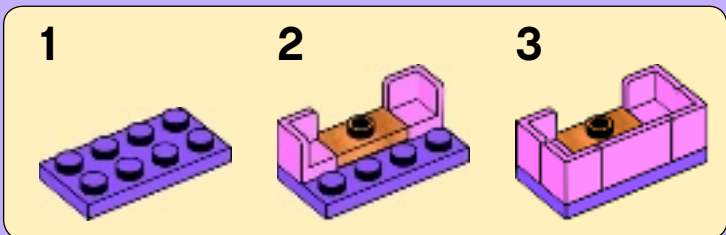

20





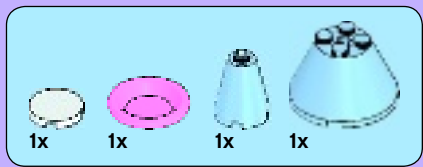

21

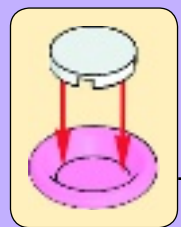

89



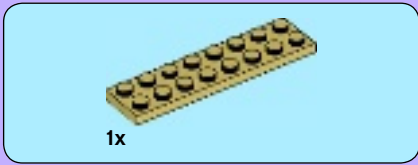

1

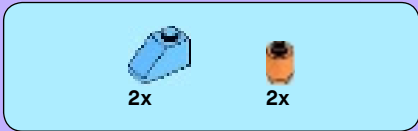
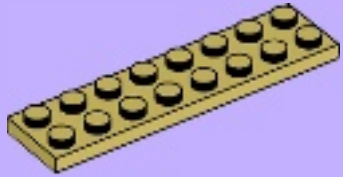

2

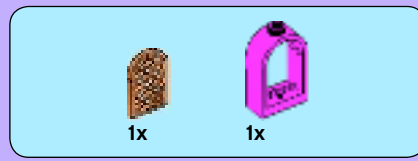
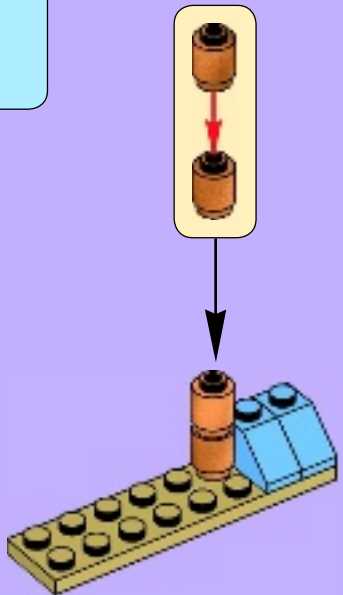

3

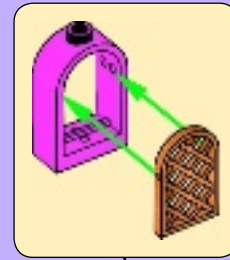

4

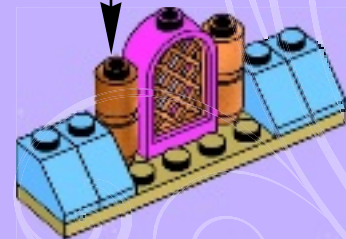
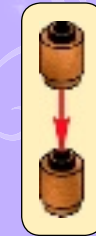



5



6

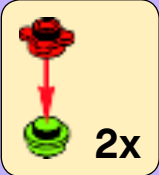

7





90





2x



1x

# 91

1

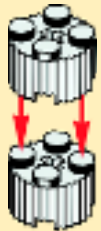

2





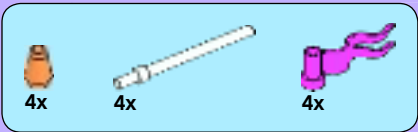

92

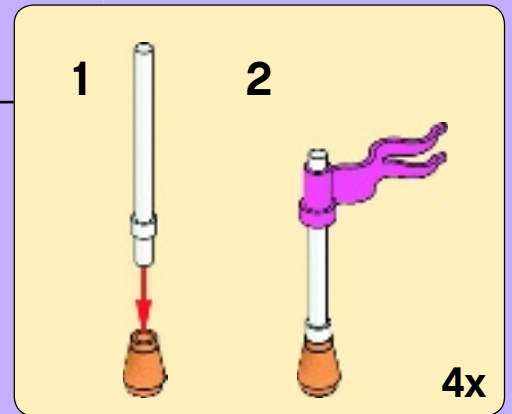





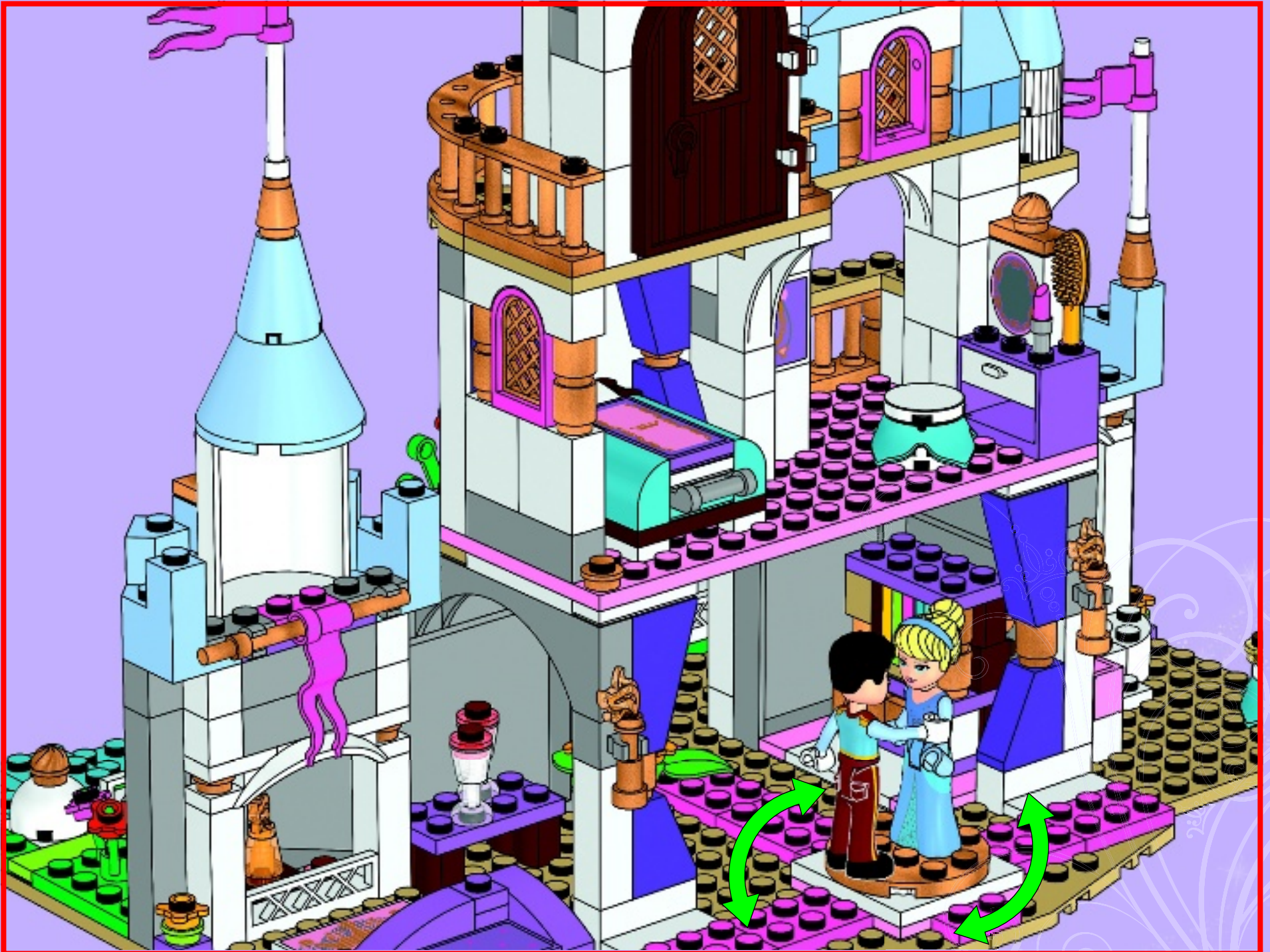



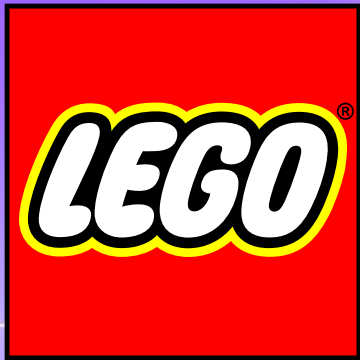

[LEGO.com/disneyprincess](https://www.lego.com/disneyprincess)





41054 ■



41055 ■



41052 ■



41053 ■





# Friends



41039



41026



41029

## Heartlake City

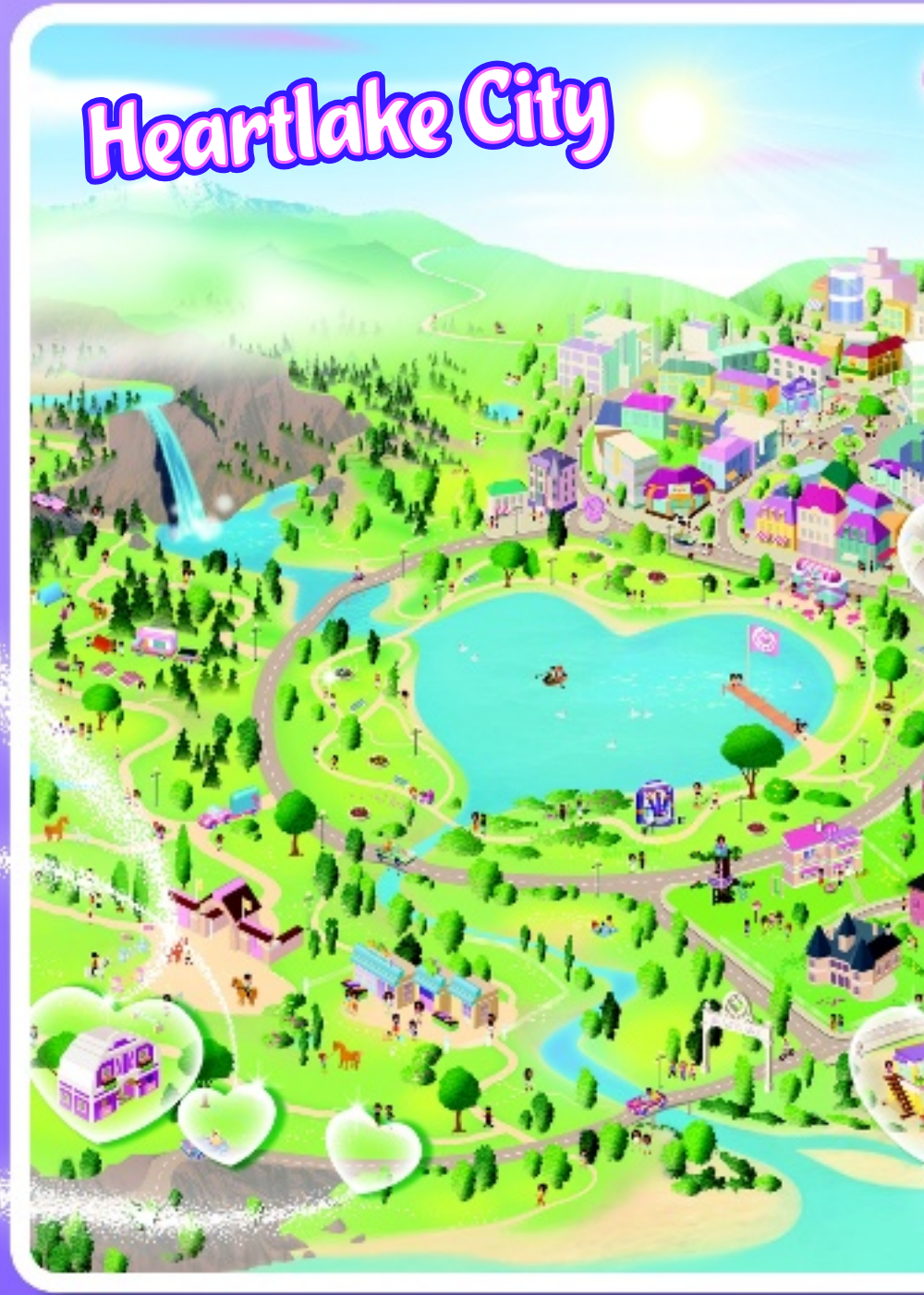





41035



41027



41028



41037





- 2x 245301
- 7x 6055541
- 8x 300501
- 15x 4113261
- 10x 300401
- 1x 300301
- 2x 235701
- 2x 362201
- 1x 4563684
- 1x 4143254
- 1x 306201
- 4x 4216652
- 1x 6050914
- 2x 4650644
- 2x 4567449
- 1x 389401
- 1x 4547489
- 1x 366501
- 3x 6038525
- 5x 365901
- 2x 4620761
- 2x 6023878
- 1x 4611927
- 12x 302301
- 5x 302201
- 4x 4558168
- 7x 4597131
- 1x 4160736
- 2x 371001
- 2x 4560178
- 2x 4613256
- 1x 4632566
- 1x 4119410
- 2x 6046979
- 2x 4622937
- 8x 614101
- 4x 403201
- 2x 6044691
- 1x 4515347
- 1x 6065143
- 4x 4565576
- 1x 4163987
- 1x 4520636
- 5x 4550171
- 4x 4538720
- 1x 4600294
- 2x 4523556
- 1x 4494474
- 2x 4125554
- 1x 4114064
- 1x 4162465
- 3x 4579260
- 6x 4117070
- 2x 4205107
- 2x 4205105
- 3x 4114026
- 2x 4113988
- 1x 4509897
- 5x 4113917
- 1x 4114084
- 2x 4118790
- 1x 4114309
- 2x 4124067
- 2x 4157277
- 4x 4655257
- 1x 6056273
- 1x 6056274
- 4x 4570516
- 1x 6017003
- 1x 4666579
- 1x 300221
- 11x 6035617
- 2x 6054438
- 1x 4142865
- 1x 368023
- 1x 302324
- 1x 6063639
- 1x 6022447
- 2x 249626
- 3x 302328
- 4x 302028
- 2x 4116671
- 2x 4567908
- 3x 4651215
- 3x 374128
- 1x 242328
- 5x 4613823
- 1x 4107432
- 1x 4119479
- 1x 4113949
- 1x 6054554
- 2x 3000240
- 4x 3005741
- 1x 4113954
- 1x 4183544
- 2x 4163917
- 1x 3005744
- 1x 4128576
- 1x 4113955
- 12x 4626883
- 4x 6045942
- 1x 6070904
- 1x 4129917
- 5x 6058337
- 1x 4654448
- 1x 4164037
- 2x 4500125
- 1x 4537937
- 9x 4164021
- 2x 4504850
- 15x 4183133
- 1x 4624381
- 1x 4243703
- 4x 4567338
- 3x 4649066
- 6x 4624184
- 1x 4243668
- 1x 6064747
- 10x 421180
- 3x 421181
- 1x 4211201
- 1x 4215496
- 5x 4211166
- 4x 6035291
- 3x 4211199
- 4x 6055086
- 1x 4211150
- 3x 4565394
- 3x 4211152
- 1x 4211190
- 1x 4221590
- 1x 421247
- 1x 4271874
- 1x 4216581
- 1x 4561915
- 1x 421185



2x  
4211362



4x  
4211389



4x  
6000066



2x  
4211428



3x  
4211394



2x  
4211393



4x  
4211392



4x  
4533772



1x  
6015344



1x  
4211436



2x  
4211445



2x  
4211395



3x  
6028812



1x  
4244627



2x  
4211475



4x  
4563698



3x  
4527174



2x  
4211373



1x  
4644102



2x  
4211859



1x  
4540203



1x  
4211815



2x  
4211064



1x  
4211110



3x  
6056242



2x  
6056240



4x  
6060798



4x  
6056239



12x  
6057387



11x  
6060801



3x  
6056260



11x  
4216479



5x  
4243677



1x  
4624571



2x  
4618670



1x  
4580010



3x  
4615728



8x  
4621552



2x  
4654127



10x  
4655258

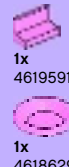

1x  
4619591



1x  
4618629



1x  
6055643



4x  
6022072



4x  
6022070



1x  
6058330



1x  
6062110



1x  
6062103



1x  
6017021



20x  
6060800



4x  
4529247



9x  
4523157



13x  
4523159



1x  
6013297



4x  
4541895



2x  
6044591



3x  
6060803



2x  
6060804



1x  
4600270



1x  
4656153



4x  
4538126



6x  
6050916



1x  
6022033



1x  
4535553



1x  
6017046



2x  
6015098



4x  
4649741



3x  
4619513



2x  
6056271



2x  
6058746



2x  
4619514



5x  
4619521



10x  
4619516



4x  
4651902



1x  
6035703



2x  
4221589



1x  
6056243



2x  
6056246

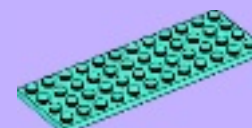

2x  
6056270

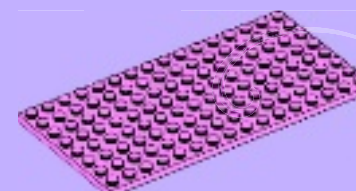

1x  
4610355



2x  
4611414

Customer Service  
Kundenservice  
Service Consommateurs  
Servicio Al Consumidor  
LEGO.com/service or dial



: 00800 5346 5555  
: 1-800-422-5346



# Win!

Go to [LEGO.com/productfeedback](http://LEGO.com/productfeedback) to fill out a survey for a chance to win a cool LEGO® Product.

No purchase necessary.  
Open to all residents  
where not prohibited.



## [LEGO.com/productfeedback](http://LEGO.com/productfeedback)

### Gewinne!

Nimm an der Umfrage auf [LEGO.com/productfeedback](http://LEGO.com/productfeedback) teil und hab die Chance ein cooles LEGO® Produkt zu gewinnen!

Die Teilnahme am Gewinnspiel führt zu keinerlei Kaufverpflichtungen. Teilnahme in allen nicht ausgeschlossenen Ländern möglich.

### Win!

Ga naar [LEGO.com/productfeedback](http://LEGO.com/productfeedback), vul een enquêteformulier in en maak kans op een cool LEGO® product.

Geen aankoopverplichting. Ledereen mag deelnemen, uitgezonderd ingezetenden van landen waar een enquêteverbod geldt.

### Gagne!

Visite [LEGO.com/productfeedback](http://LEGO.com/productfeedback) pour répondre à un questionnaire et avoir une chance de gagner un produit LEGO® très cool !

Aucune obligation d'achat. Ouvert à tous les résidents des pays autorisés.

### 当てよう!

[LEGO.com/productfeedback](http://LEGO.com/productfeedback)にアクセスして、アンケートにご記入ください。当選者にはレゴ®製品を差し上げます。

お買い上げの必要はありません。

禁止されていない限り、すべての皆様にご利用いただけます。



[LEGO.com](http://LEGO.com)

6078361

LEGO and the LEGO logo are trademarks of the LEGO Group. ©2014 The LEGO Group © Disney