



LEGENDS OF  
**CHIMA**  
TM

70008





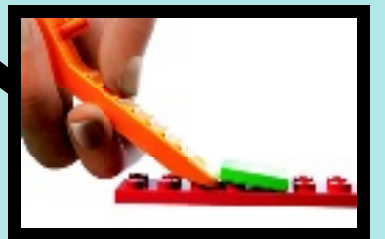
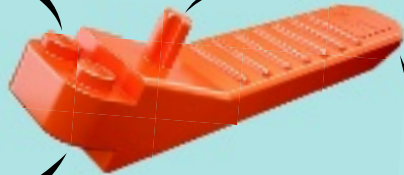

[LEGO.com/brickseparator](https://LEGO.com/brickseparator)

EN IMPORTANT: Never modify the elements or use other projectiles than provided with this toy.  
 DE WICHTIG: Die Elemente dürfen nicht verändert werden. Es dürfen ausschließlich die mit dem Spielzeug mitgelieferten Geschosse verwendet werden.  
 FR IMPORTANT : Ne jamais modifier les éléments ni utiliser d'autres projectiles que ceux fournis avec ce jouet.  
 IT IMPORTANTE: non modificare gli elementi o utilizzare proiettili non forniti con questo prodotto.  
 NL BELANGRIJK! Verander niets aan de elementen en gebruik geen andere projectielen dan de bij het speelgoed geleverde.  
 ES IMPORTANTE: No modifique los elementos ni utilice otros proyectiles diferentes a los suministrados junto con este juguete.  
 DA VIGTIGT: Elementerne må ikke ændres, og der må ikke bruges andre projektiler end dem, der følger med legetøjet.  
 FI TÄRKEÄÄ: Älä koskaan tee osin muutoksia tai käytä lelussa muita kuin sen sisältämiä ammuksia.  
 SV VIKTIGT: Modifiera aldrig delarna och använd aldrig andra projektiler än de som medföljer denna leksak.  
 PT IMPORTANTE: Nunca modifique os elementos nem utilize projécteis que não tenham sido fornecidos com este brinquedo.  
 EL ΣΗΜΑΝΤΙΚΟ: Ποτέ μην τροποποιείτε τα στοιχεία του παιχνιδιού και μην χρησιμοποιείτε άλλα βλήματα εκτός από αυτά που συνοδεύουν αυτό το παιχνίδι.  
 JA 重要： 部品を改造したり、本製品に付属の発射体以外のものを使用しないようにしてください。  
 ZH 重要提示： 切勿更改组件或使用并非由本玩具附带的弹丸。  
 KO 중요함: 이들 부품을 수정하거나 이 완구와 함께 제공된 것이 아닌 발사체는 결코 사용하지 마십시오.  
 RU ВАЖНО: запрещается вносить изменения в элементы или использовать другие снаряды, отличные от тех, которые поставляются с данной игрушкой.  
 PL WAŻNE: Nigdy nie modyfikować elementów zabawki ani nie używać pocisków innych niż dostarczone z zabawką.  
 CZ UPOZORNĚNÍ: Nikdy neupravujte součástky a nepoužívejte jiné projektily než ty, které jsou dodávány s touto hračkou.  
 SK UPOZORNENIE: Nikdy neupravujte súčiastky a nepoužívajte iné projektily než tie, ktoré sú dodávané s touto hračkou.  
 HU FONTOS: Az elemeket nem szabad módosítani, és a játékhoz adott lövedékek helyett sem szabad másat használni.  
 UA ВАЖЛИВО: забороняється вносити зміни до елементів або використовувати інші снаряди на відміну від тих, що поставляються з цією іграшкою.  
 HR VAŽNO: Nemojte nikad mijenjati elemente ili koristiti druge projektilе osim onih koji su bili priloženi uz ovu igračku prilikom kupnje.  
 SR Важно: Немојте да модификујете елементе и не користите друге пројектиле осим оних који долазе уз ову играчку.  
 SL POMEMBNO: Nikoli ne spreminjajte elementov in uporabljajte le izstrelke, ki so bili priloženi tej igrači.  
 RO IMPORTANT: Nu modificați niciodată elementele și nu utilizați alte proiectile decât cele furnizate cu această jucărie.  
 BG ВАЖНО: Не видоизменяйте елементите и не използвайте други снаряди освен приложените към тази играчка.  
 LV SVARĪGĪ! Nekad nepārveidojiet rotallietas elementus, vienmēr izmantojiet tikai tās komplektā iekļautās lodītes.  
 ET OLULINE: Mänguosa ei tohi teistega asendada, kasutada võib ainult kaasasolevat heitkeha.  
 LT DĖMESIO! Niekuomet nekeiskite elementų ir naudokite tik tuos šovinius, kurie yra pridėti prie šio žaislo.  
 TR ÖNEMLİ: Hiçbir zaman parçalarda değişiklik yapmayın veya bu oyuncakla sağlananlar dışında mermiler kullanmayın.

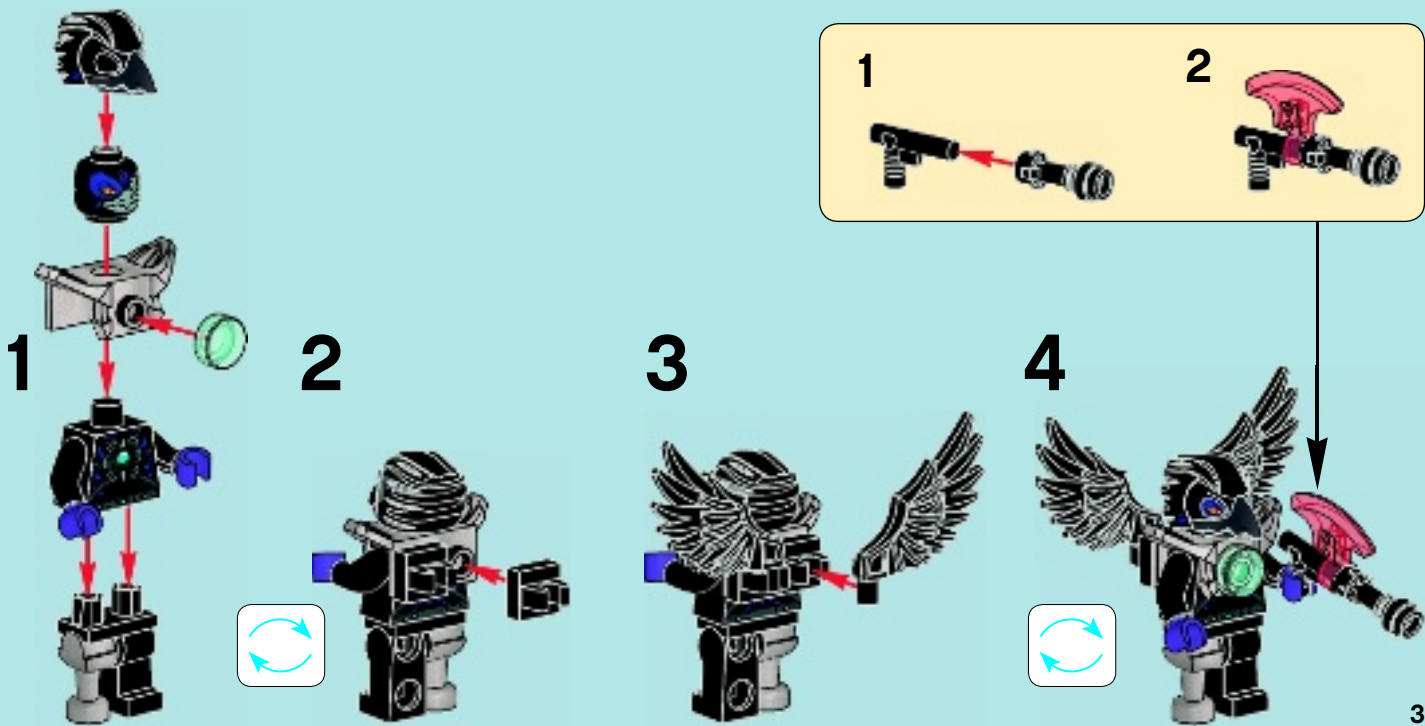
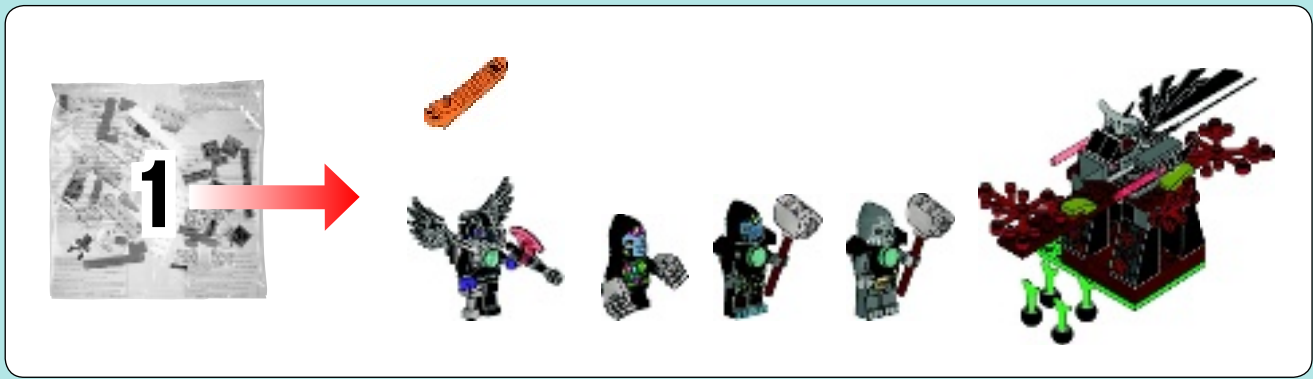

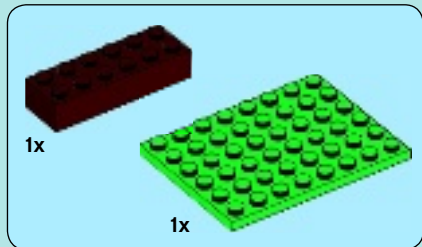
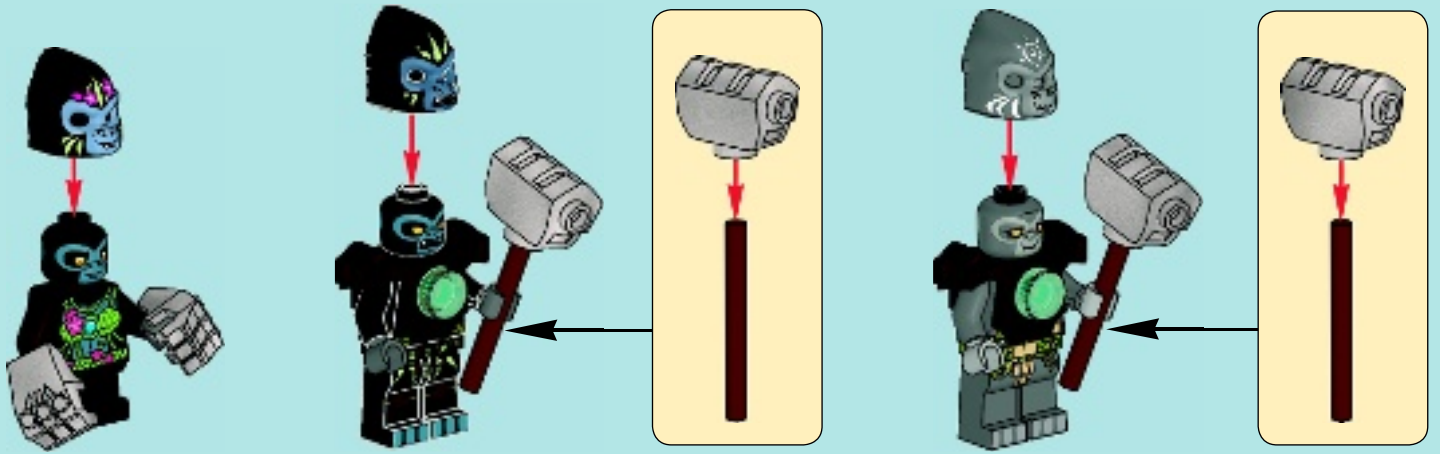

1

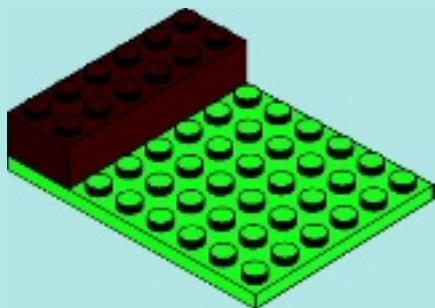

2

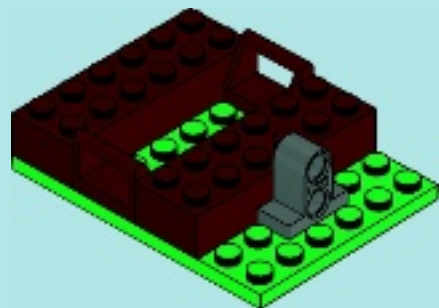



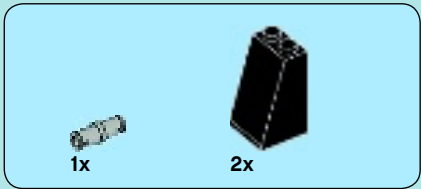

3

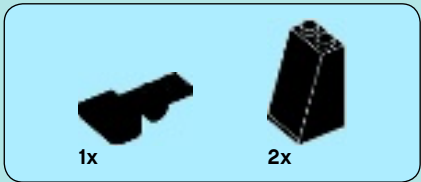
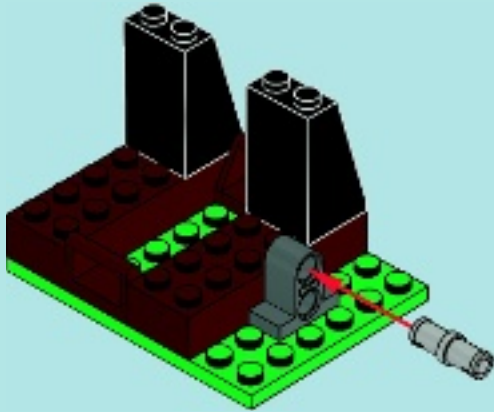

4

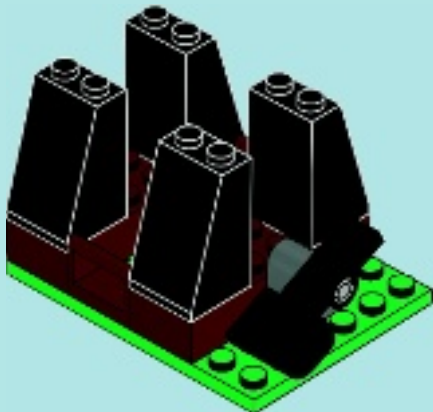

5

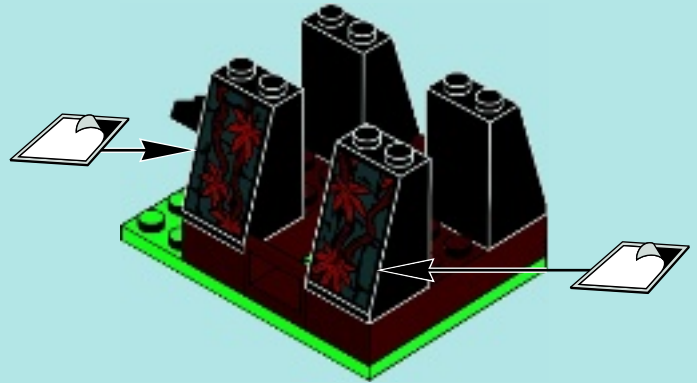
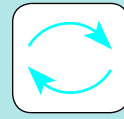

6

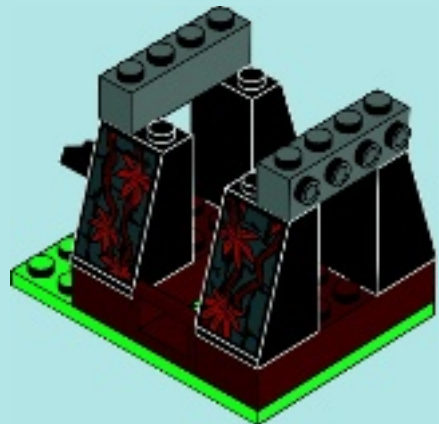



7

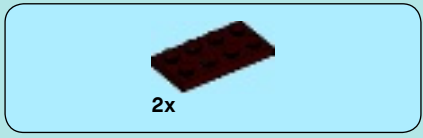
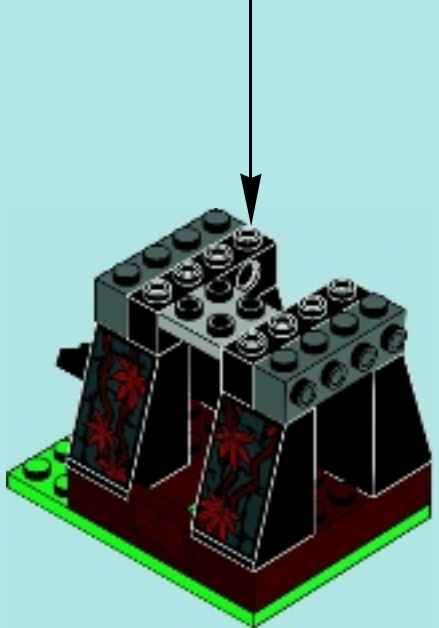
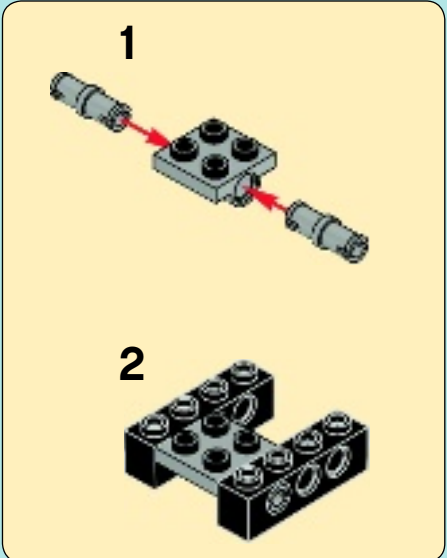

8

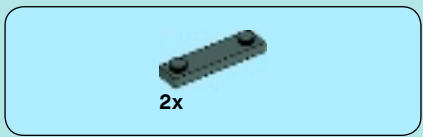
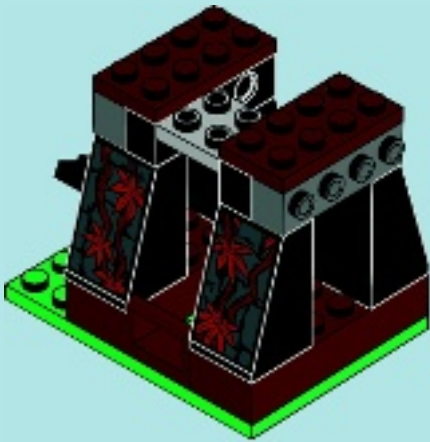

9

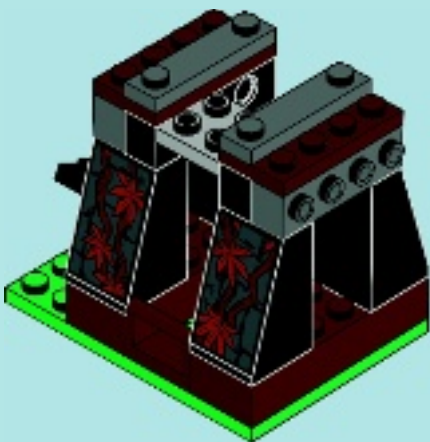



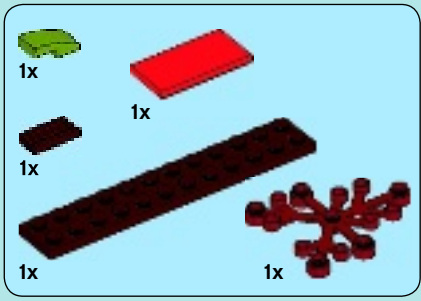

# 10

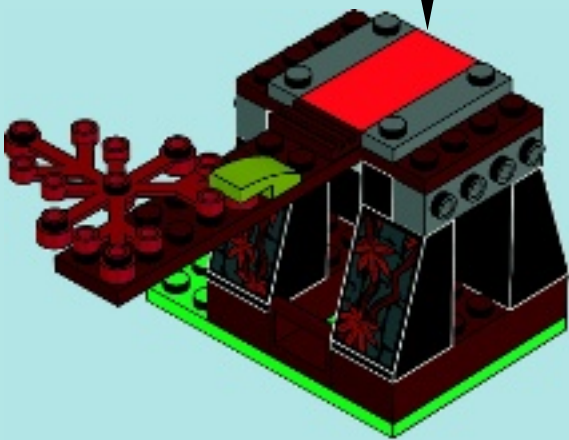
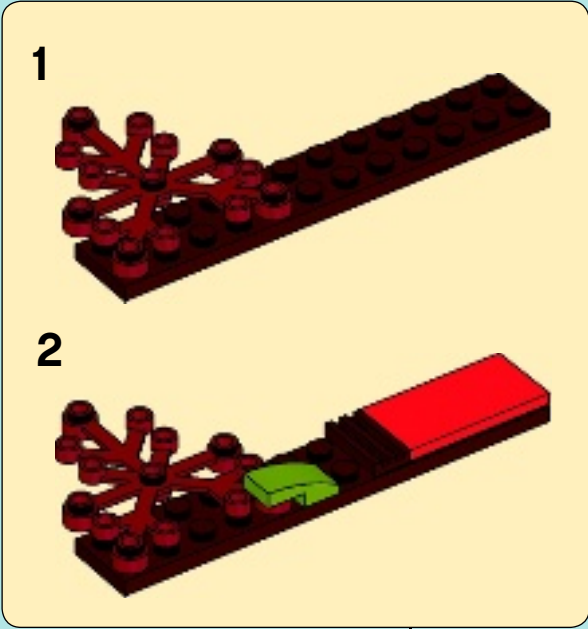

# 11

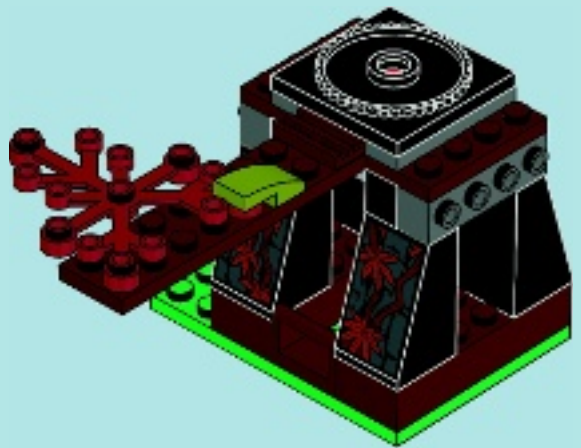



# 12

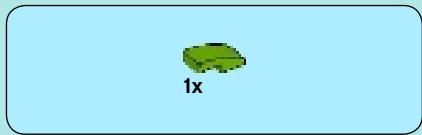
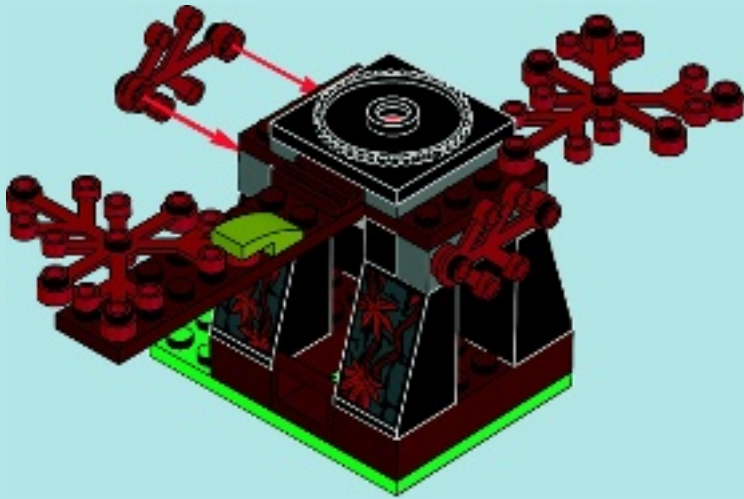

# 13

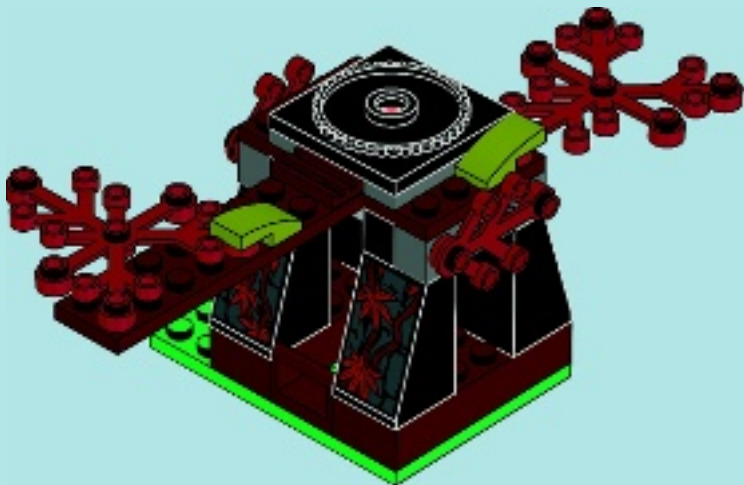



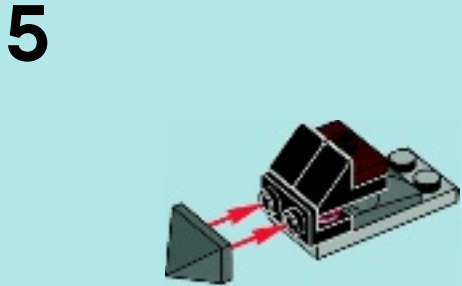
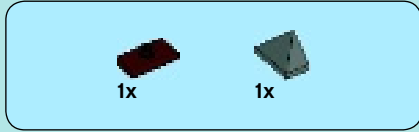
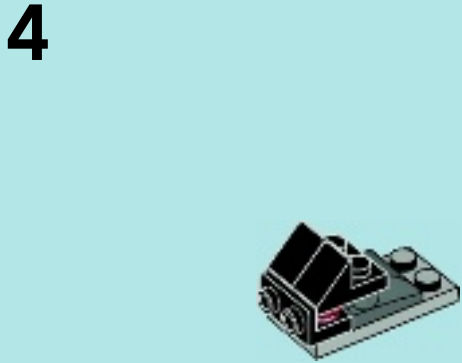
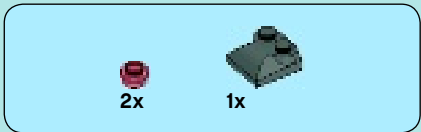
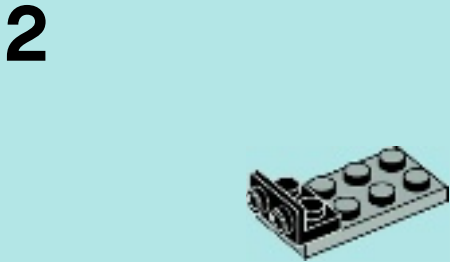
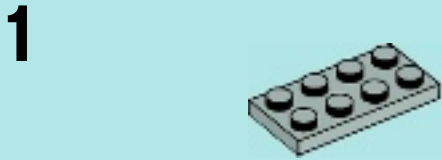



1x

7



2x

8



2x

9



2x



2x

10

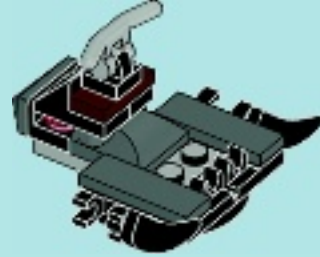

2x



2x

11

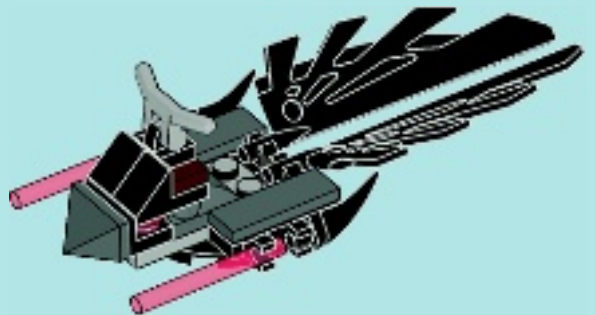



# 14

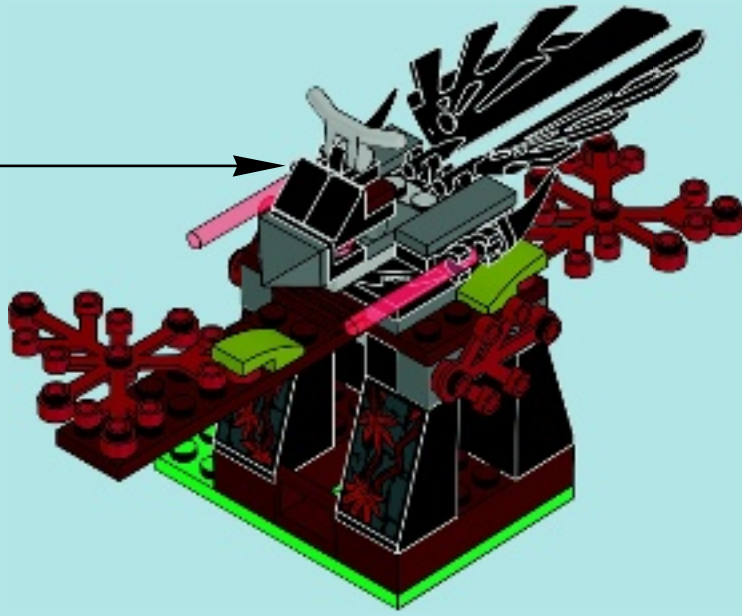

4x  4x 

# 15



 4x



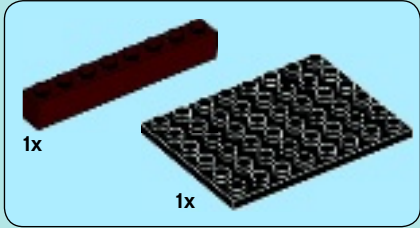
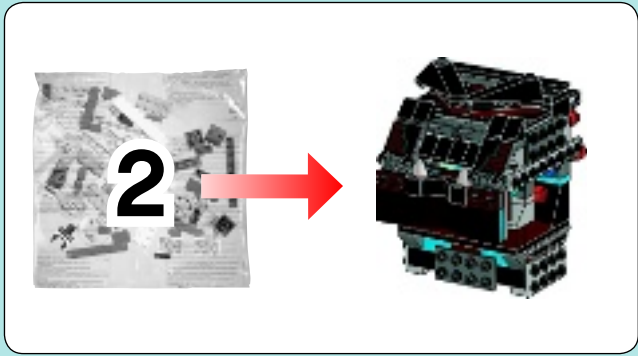

1

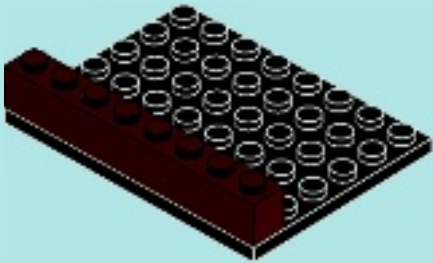

2

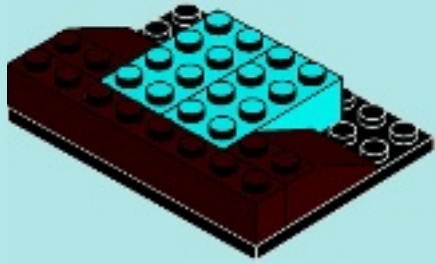

3

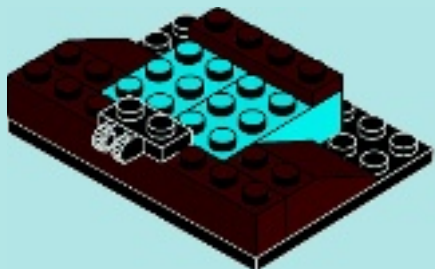

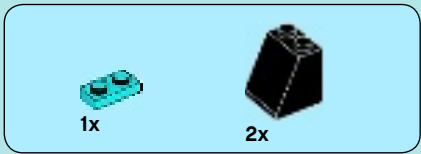

4

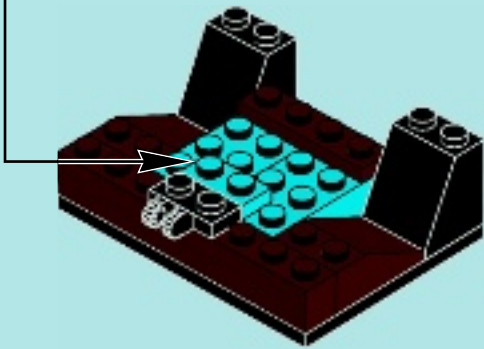

5

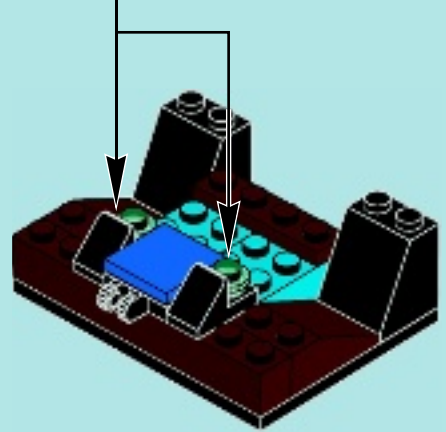
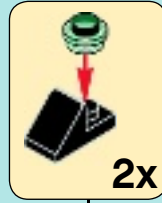

6

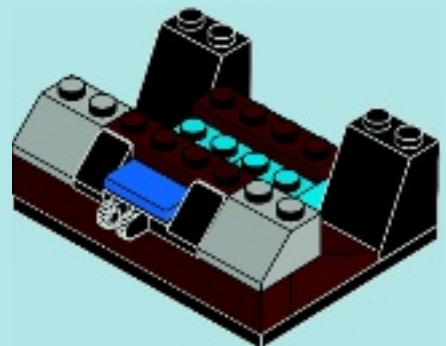

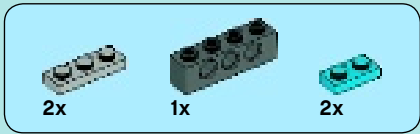

7

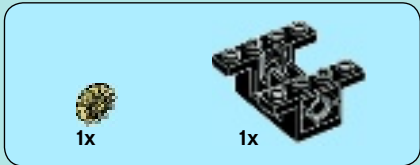
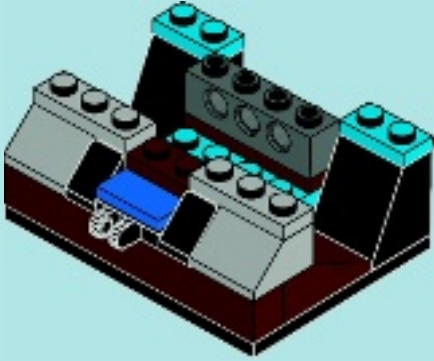

8

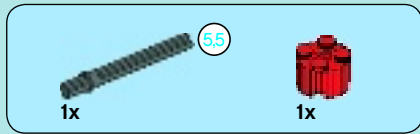
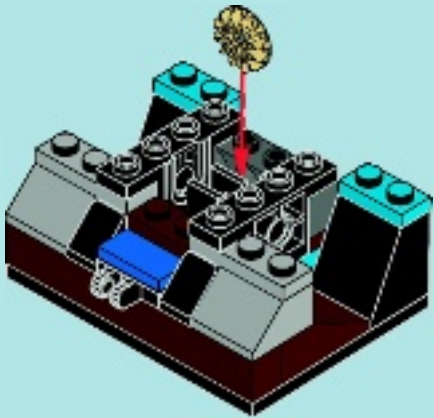

9

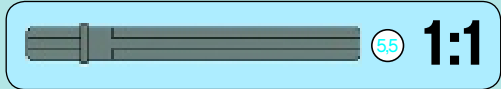
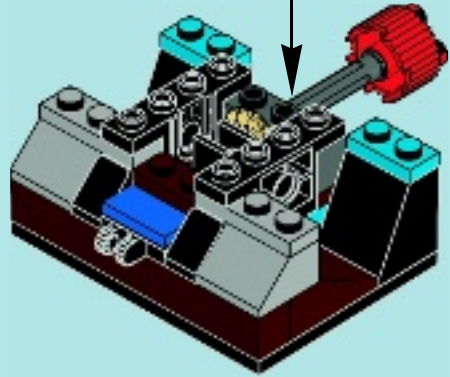
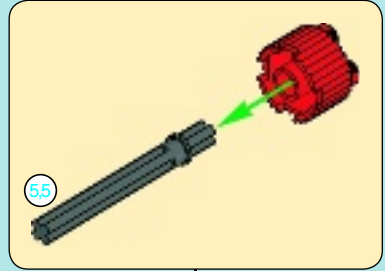



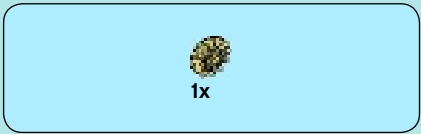

# 10

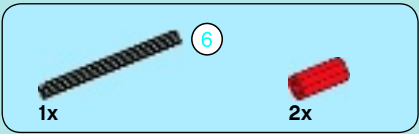
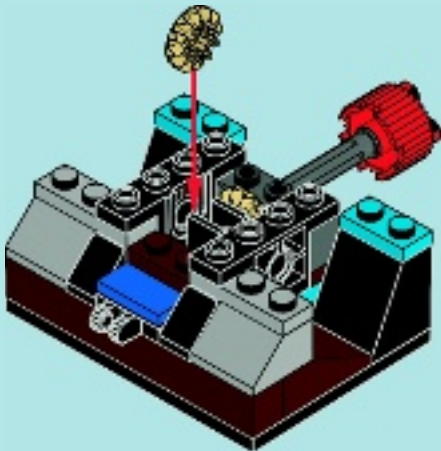

# 11

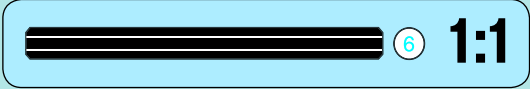
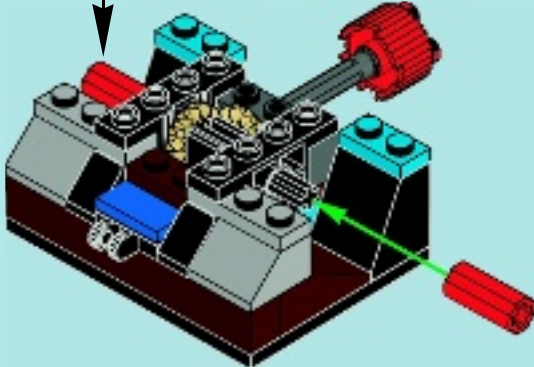
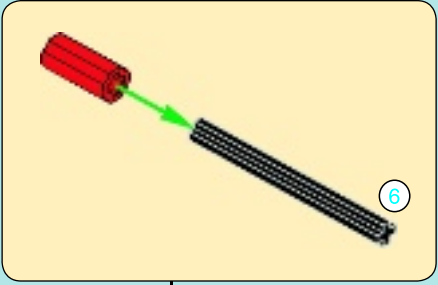

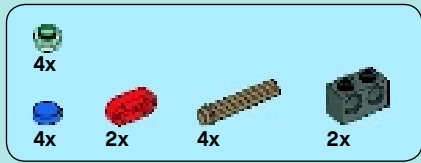

# 12

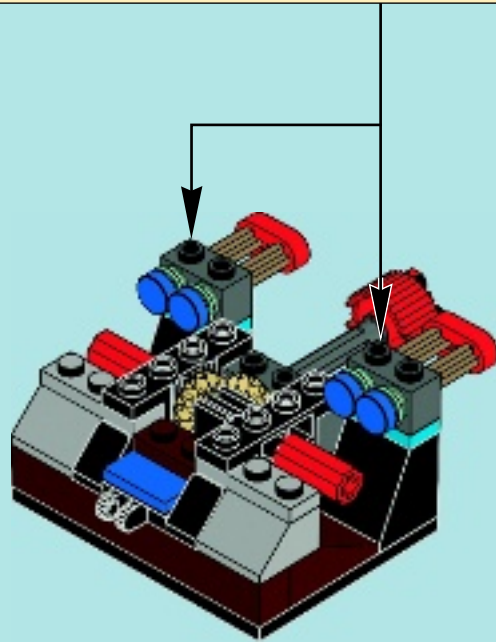
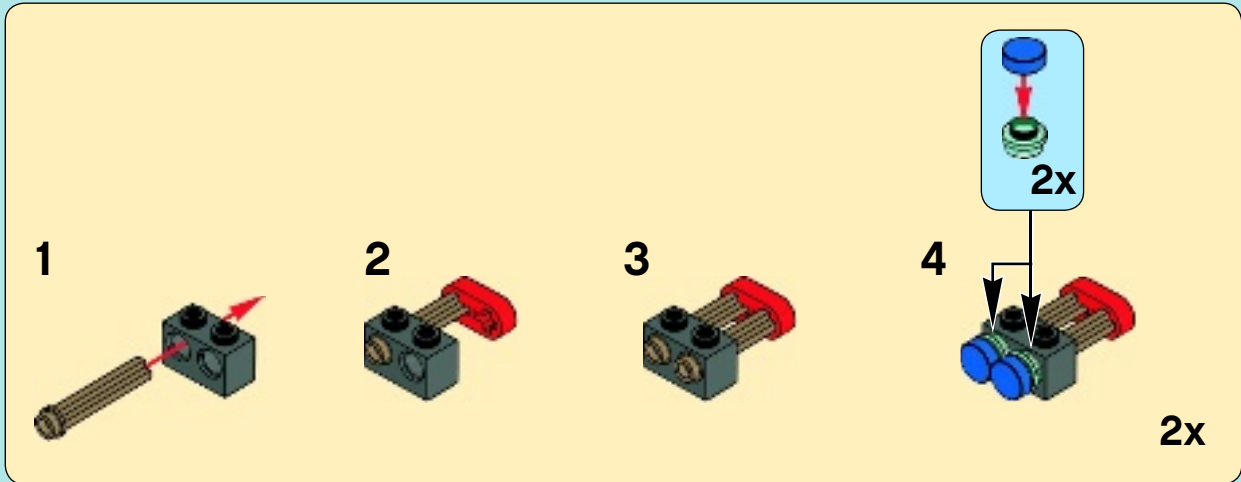

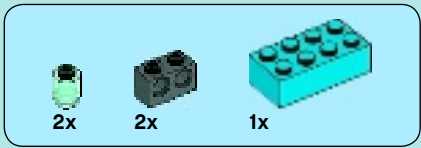

# 13

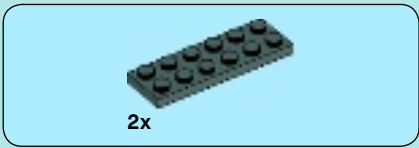
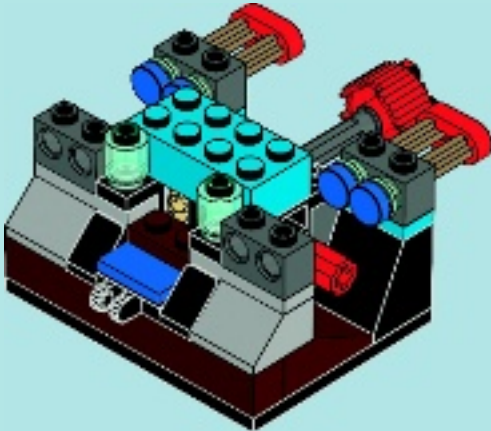

# 14

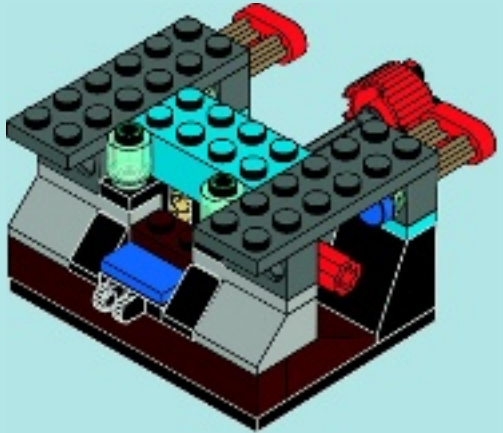

# 15

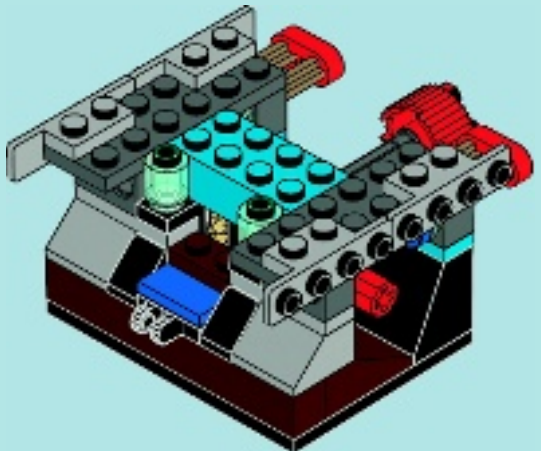

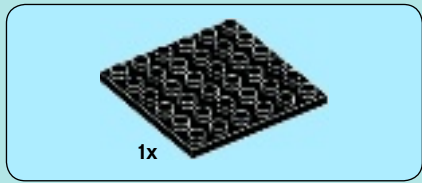

# 16

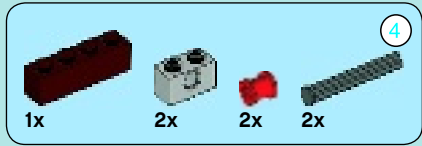
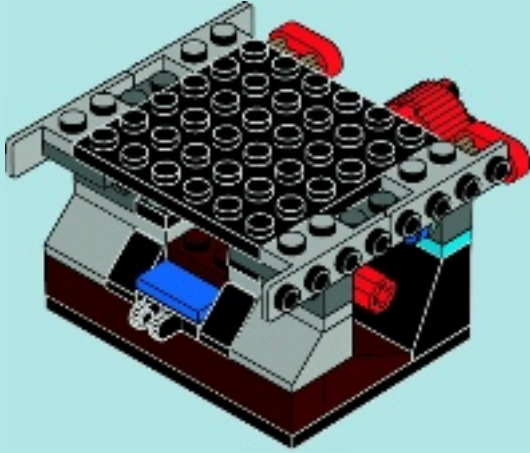

# 17

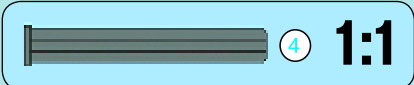
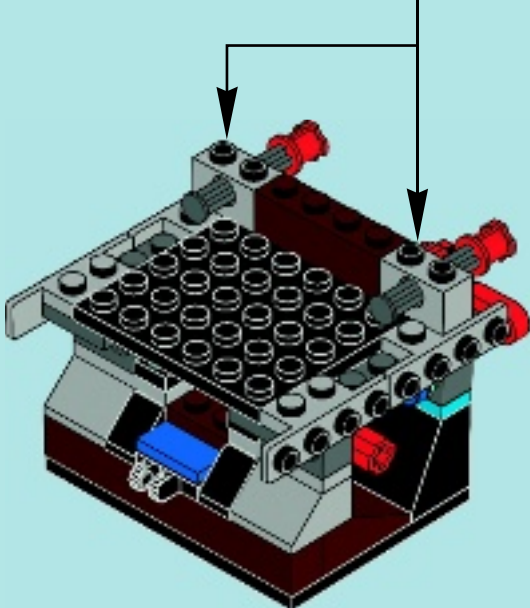
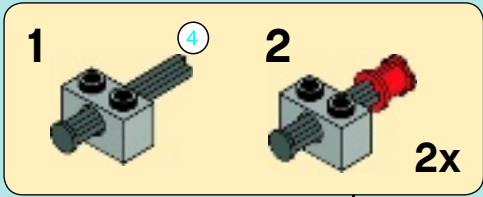





# 18

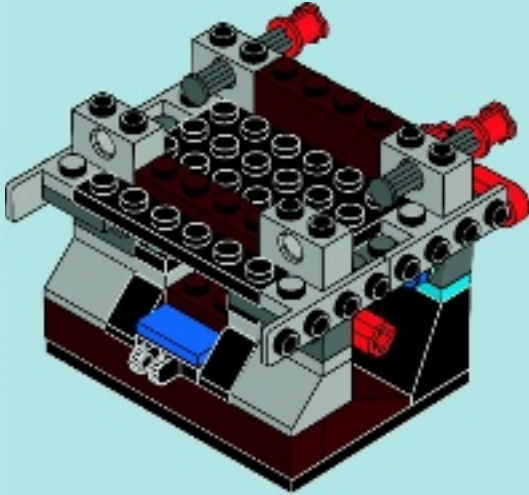

# 19

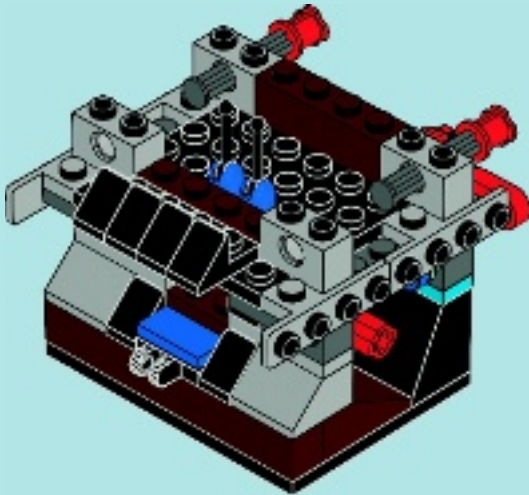

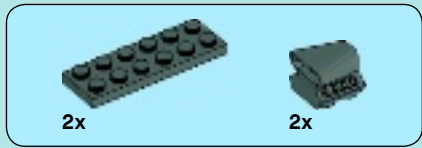

# 20

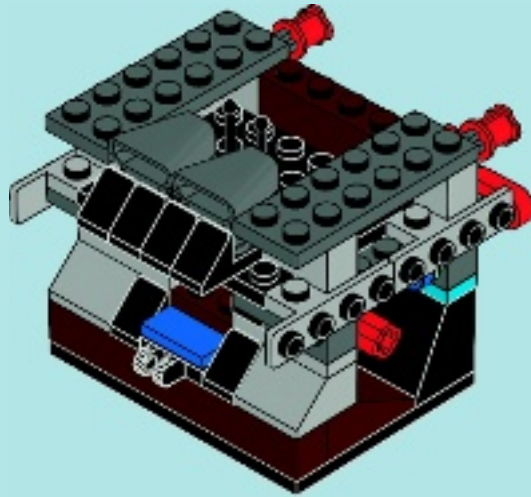

# 21

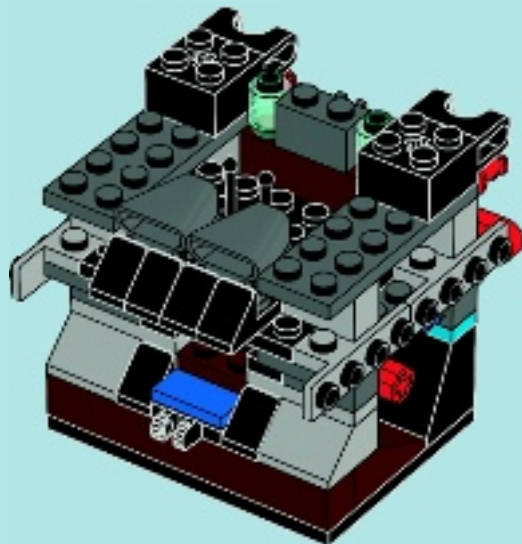



# 22

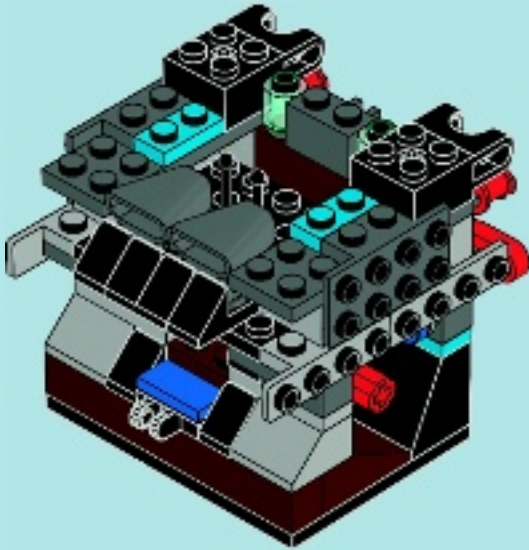

# 23

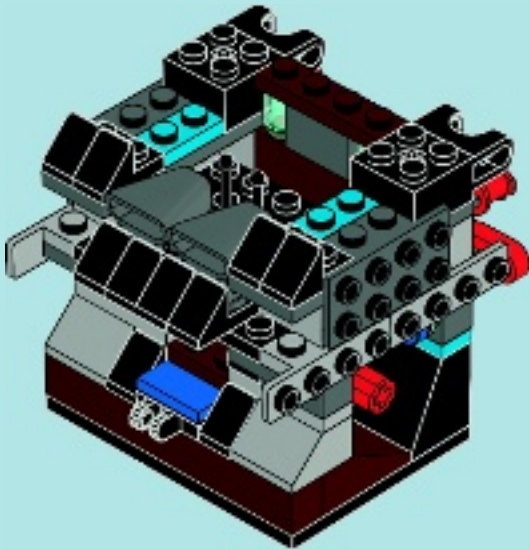

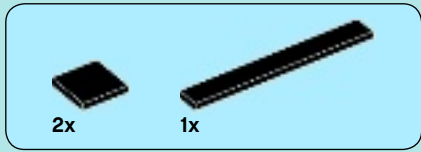

# 24

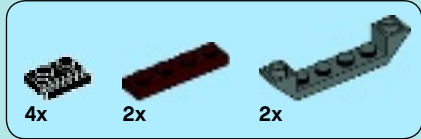
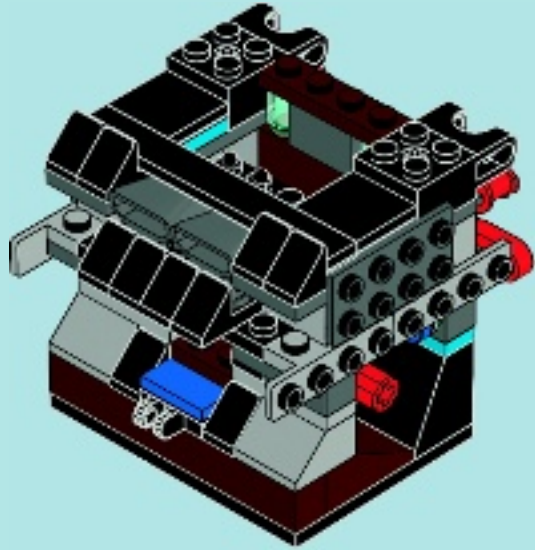

# 25

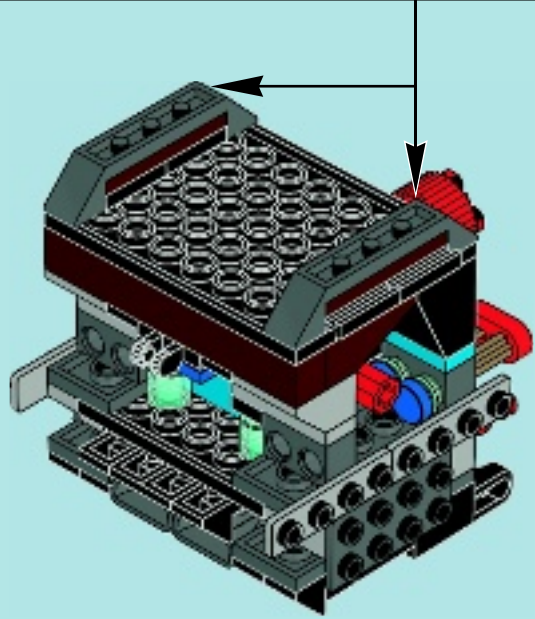
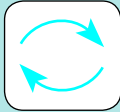
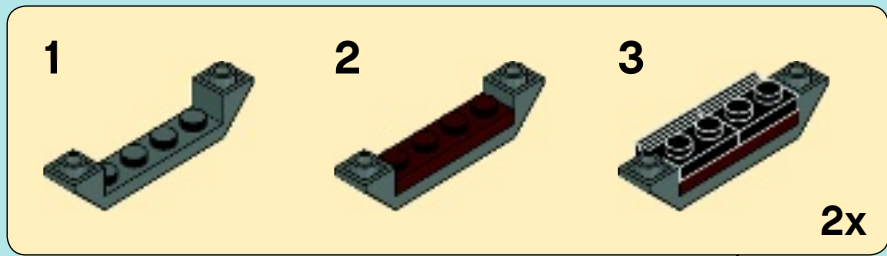



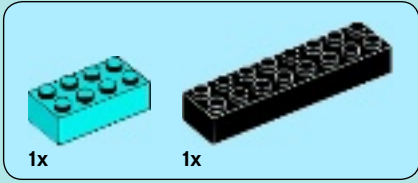
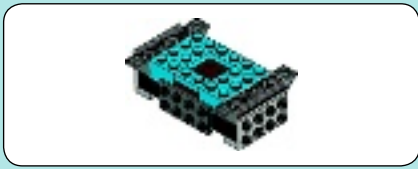

1

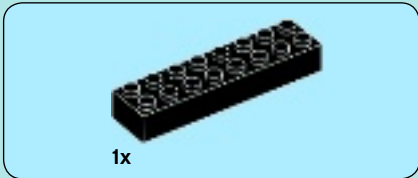
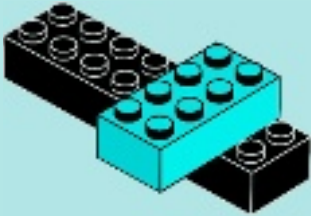

2

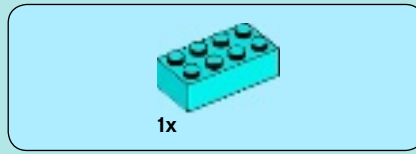
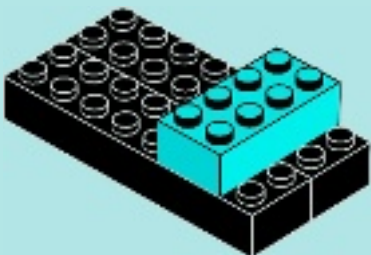

3

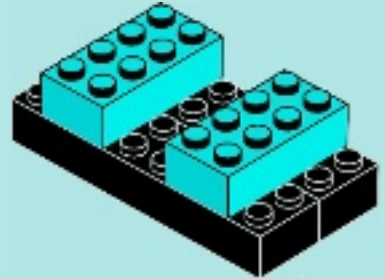

4

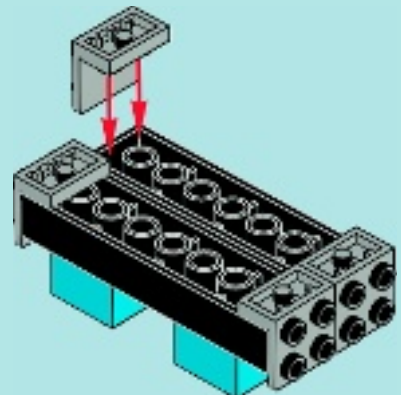
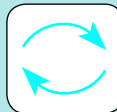



2x

5

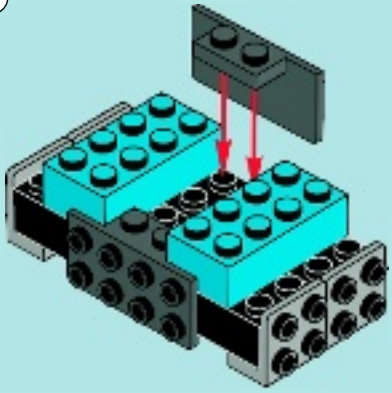
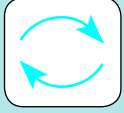

1x

6

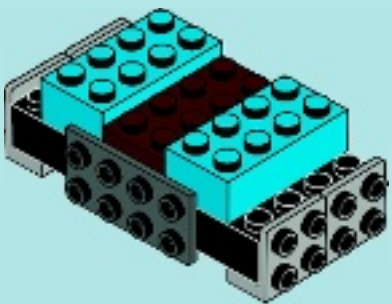

2x

7

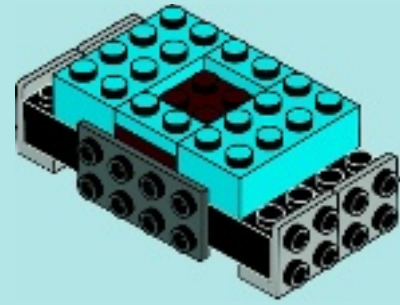

26

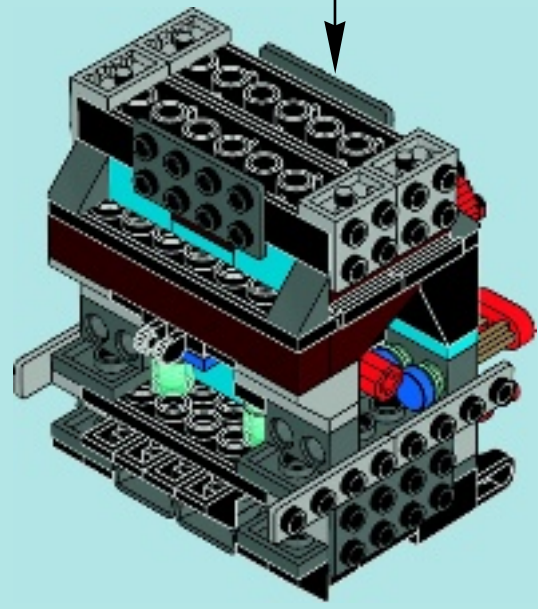

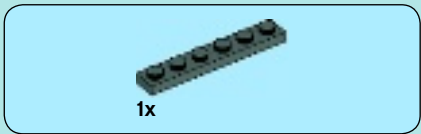

# 27

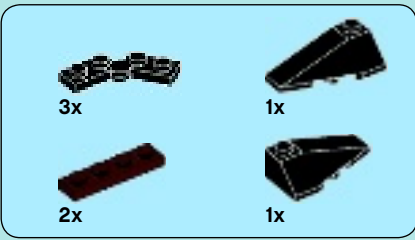
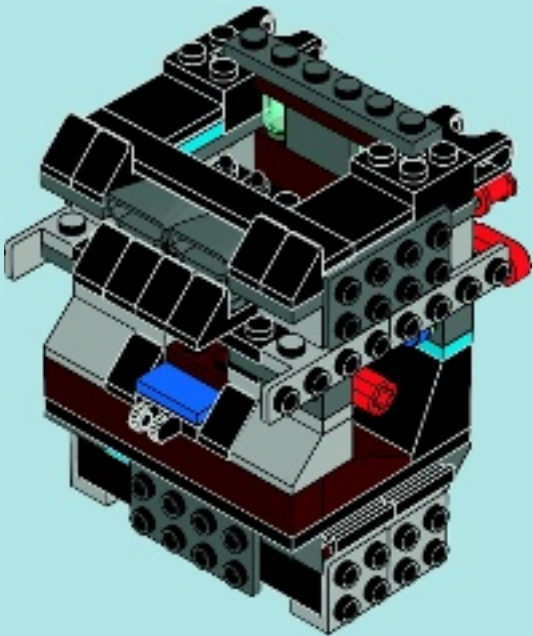

# 28

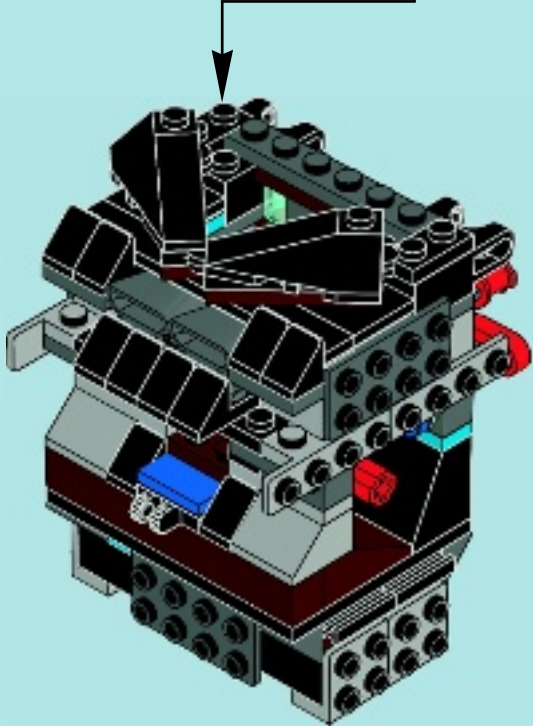
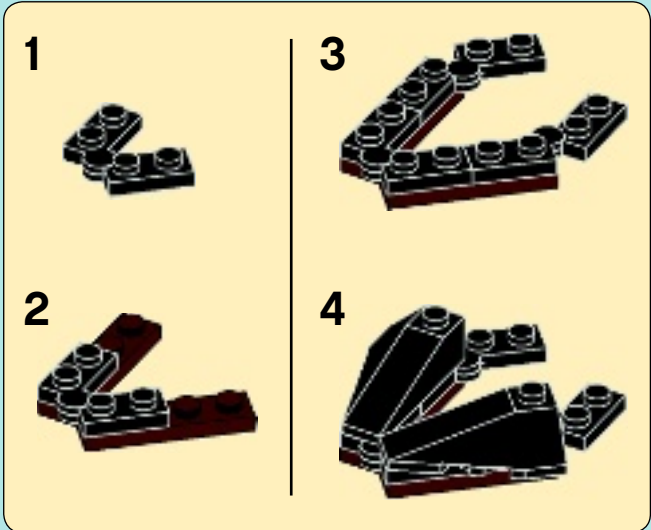

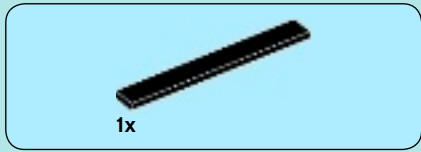

# 29

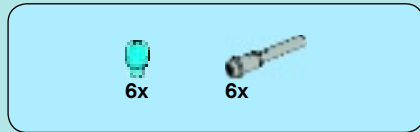
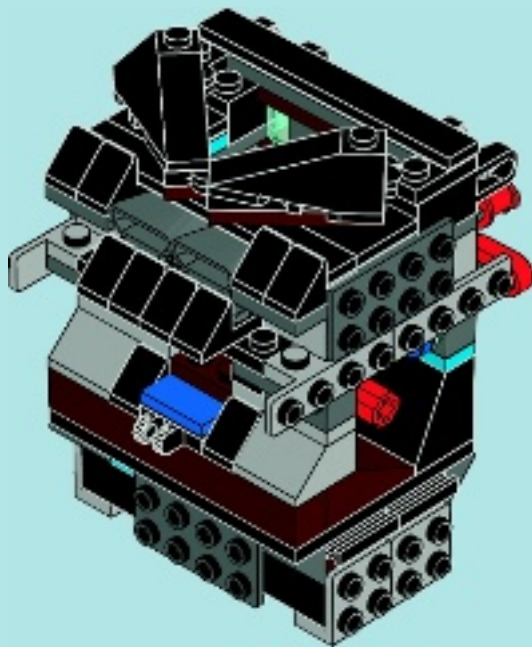

# 30

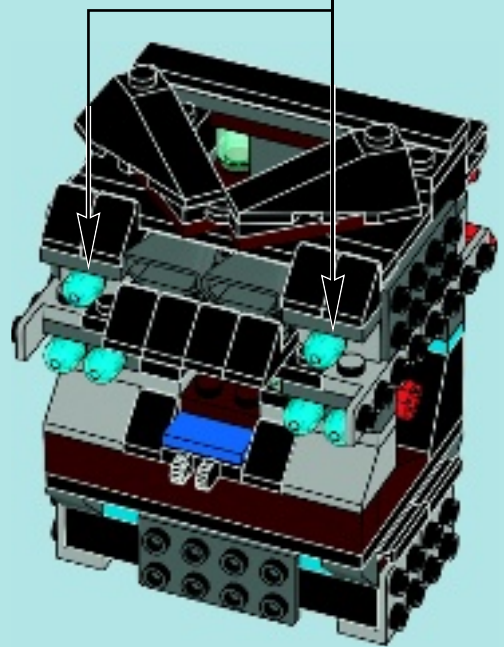
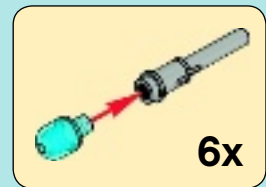



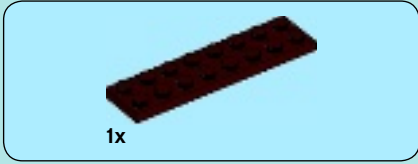

1x

1



2x

2x

2



2x

2x

3

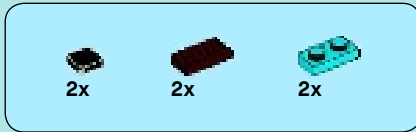

2x

2x

2x

4

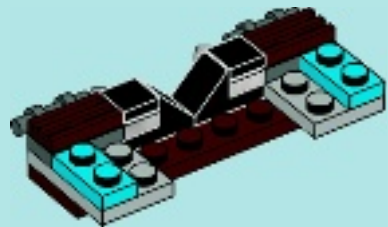

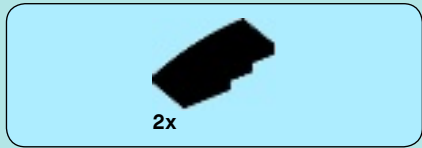

5



6

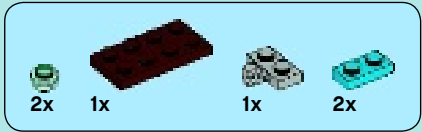
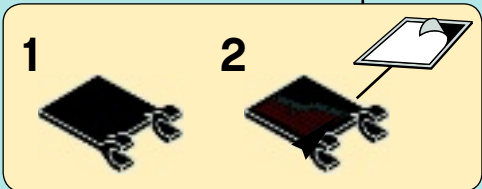
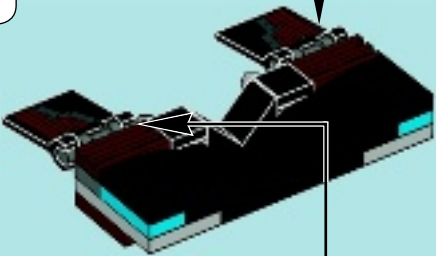

7

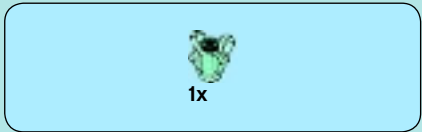
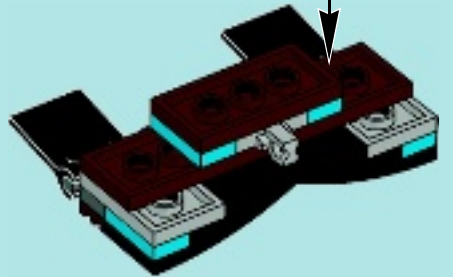
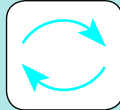
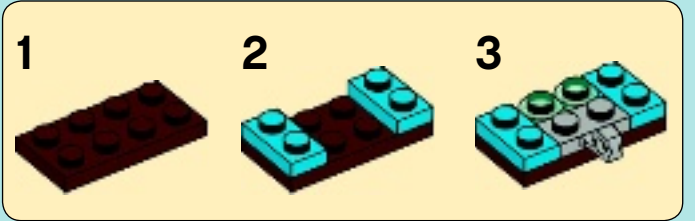

8

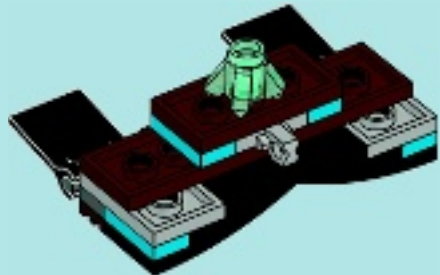

31

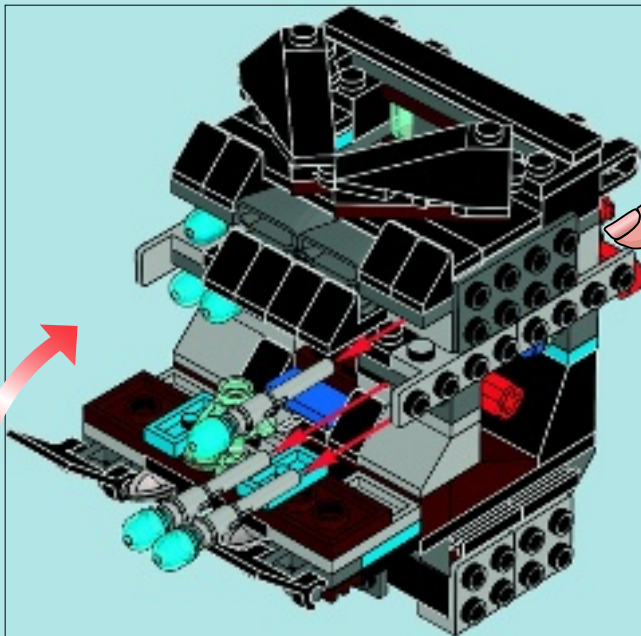
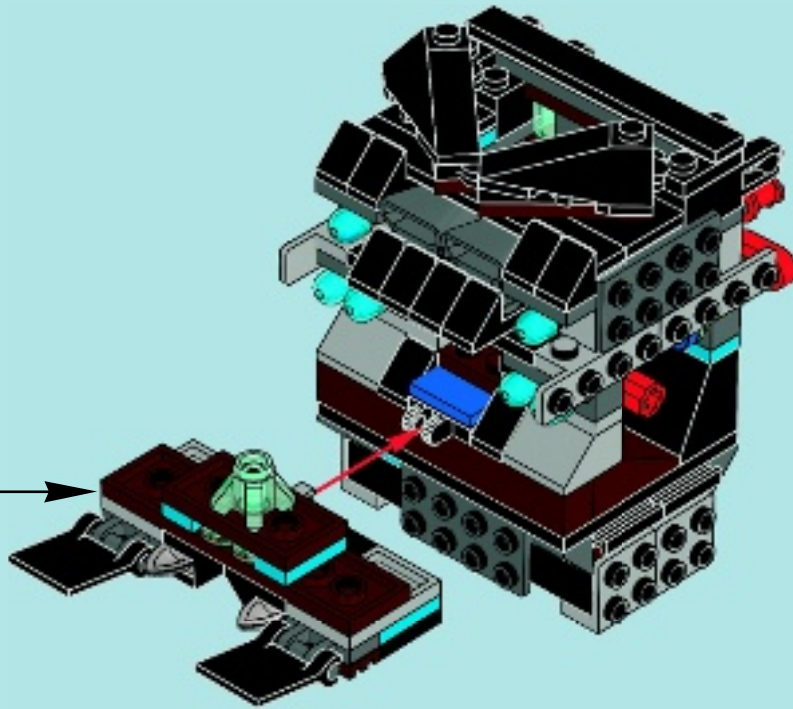

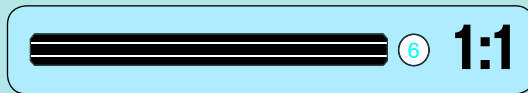
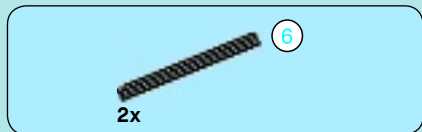
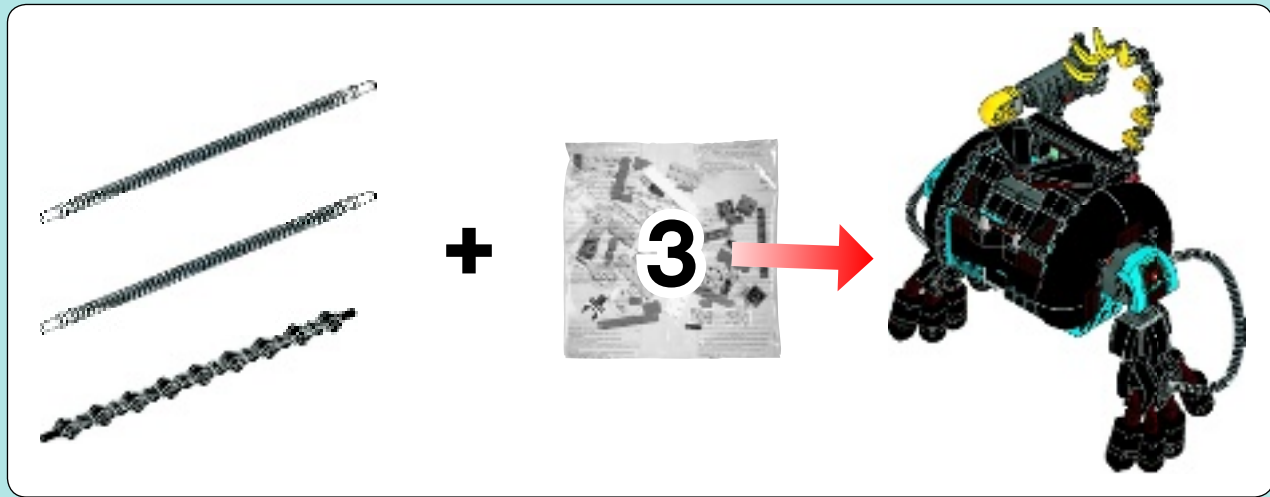

32

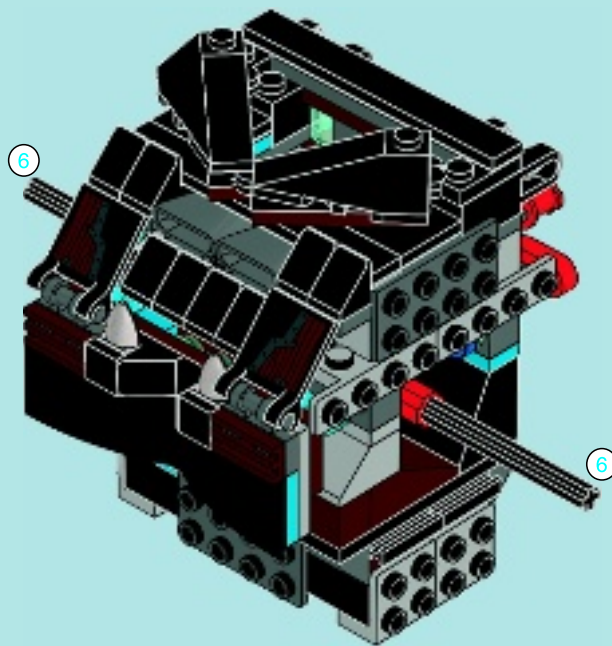



4x

# 33



2x

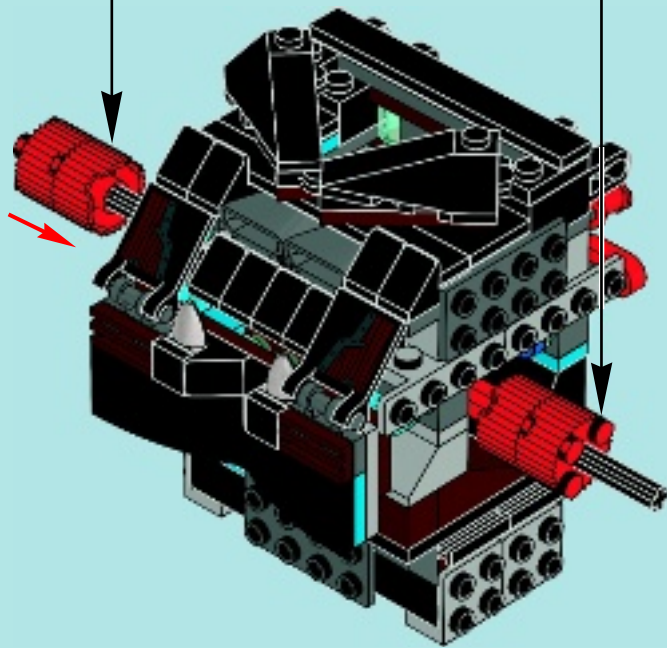



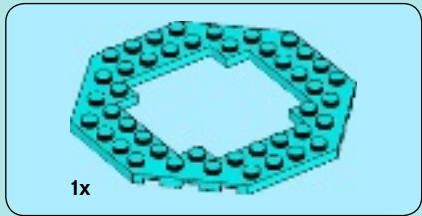

1

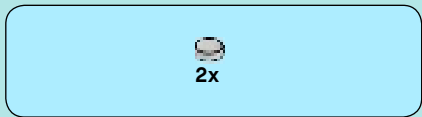
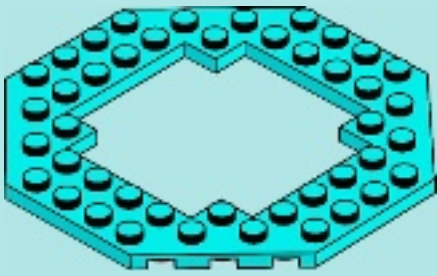

2

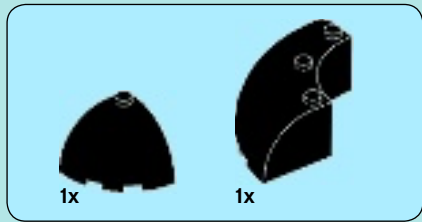

3

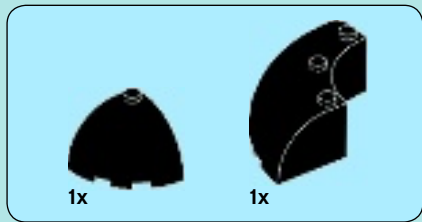
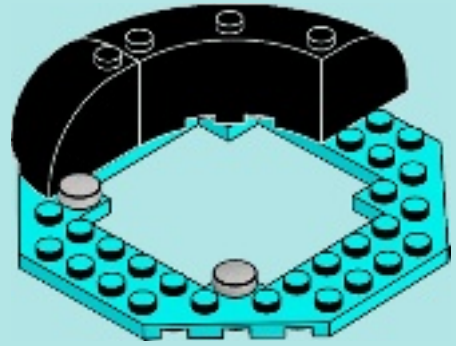

4

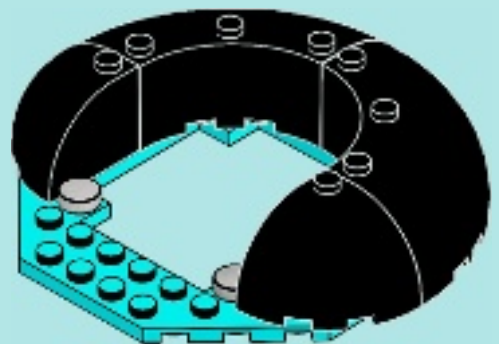





LEGENDS OF CHIMA™

# CHIMA

**WATCH THE VIDEO**

WATCH THE VIDEO · SICH DAR DAS VIDEO AN  
REGARDE LA VIDEO · MIRA EL VIDEO  
VÉ O VIDEO · MÓZD MEG A VIDEO!

**SCAN THE QR CODE**

SCAN THE QR CODE · SCANNE DEN QR-CODE  
SCANNI LE QR CODE · CAPTURA EL CÓDIGO QR  
PRZESKAN DO CÓDIGO QR · OLVYSAJ ME A QR KÓDOT



**LEGO.COM/CHIMA**







# LEGENDS OF CHIMA™

**LAGRAVIS**



70010 70108

**LAVAL**



70005  
70010 70115

**LONGTOOTH**



70005  
70010 70113

**LENNOX**



70002  
70006 70011  
70014 70104

**LEONIDAS**



70001 70006  
70014 70102

**FURTY**



70111

**SKINNET**



70107

**EWALD**



70010 70011

**ERIS**



70003  
70009 70114

**EQUILA**



70004  
70013 70101

**EGLOR**



70007  
70013 70105

**EWAR**



70012

**GRUMLO**



70008

**G'LDUNA**



70008

**GURZAN**



70008 70109

**GRIZZAM**



70009 70110



**CROMINUS**



70006  
70014 70103

**CRAGGER**



70006 70010  
70014 70115

**CROOLER**



70006

**CRUG**



70002  
70014 70112

**CRAWLEY**



70001  
70005 70010

**RAWZOM**



70006 70114

**RAZAR**



70003 70010  
70012 70100

**RIZZO**



70003  
70008 70012

**RAZCAL**



70000 70007

**WORRIZ**



70009 70011

**WAKZ**



70004  
70009 70113

**WILHURT**



70009 70013

**WINDRA**



70009

**WINZAR**



70004 70106





LEGO  
LEGENDS OF  
**CHIMA**<sup>TM</sup>

**WATCH THE MODEL  
IN ACTION**

ERLEBE DAS MODELL IN AKTION  
REGARDE LA DÉMO DU MODÈLE EN ACTION  
MIRA EL MODELO EN ACCIÓN  
VÉ O MODELO EM AÇÃO  
NÉZD MEG A MODELLT MŰKÖDÉS KÖZBEN

**SCAN THE QR CODE**  
SCANNE DEN QR-CODE  
SCANNE LE QR CODE  
CAPTURA EL CÓDIGO QR  
FAZ SCAN DO CÓDIGO QR  
OLVASD BE A QR KÓDOT



LEGO.COM/CHIMA



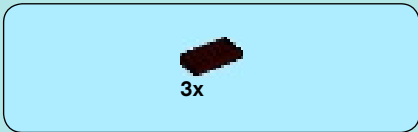

5

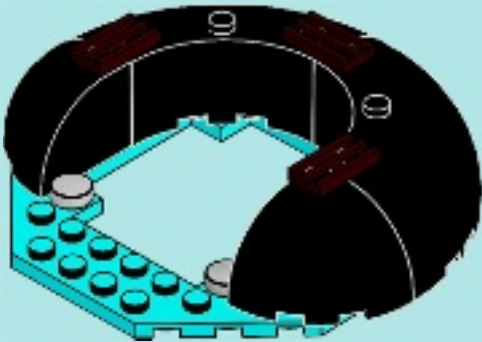

2x

34

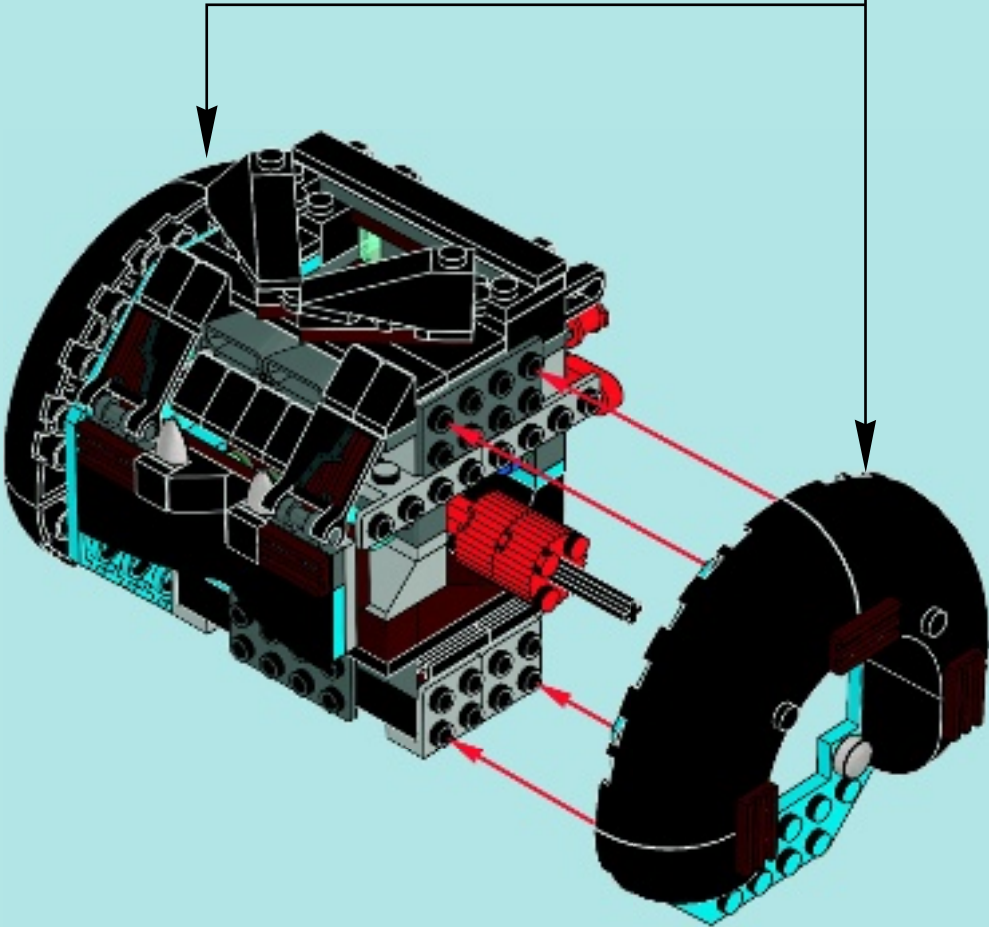

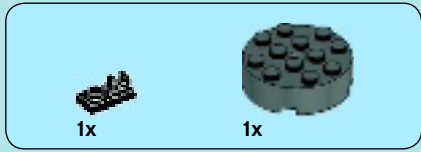

1

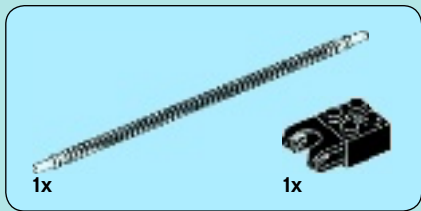

2

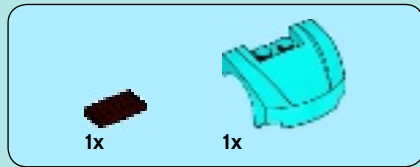
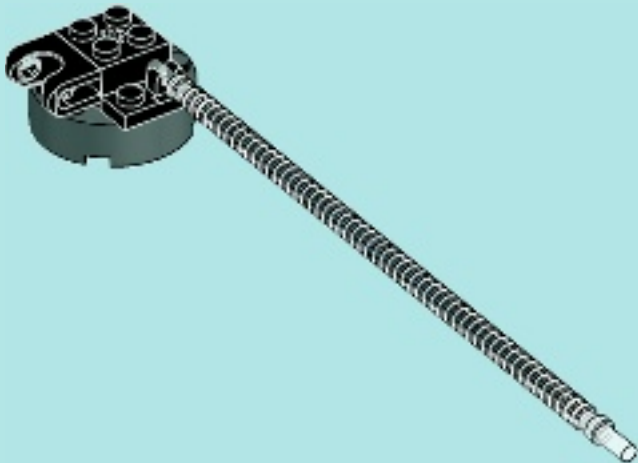

3

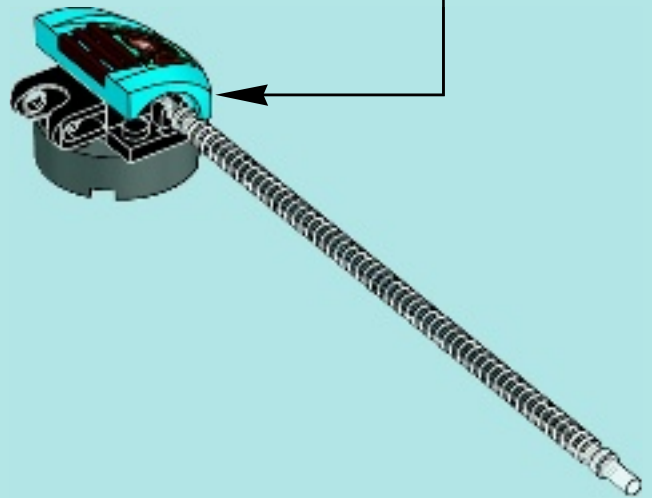
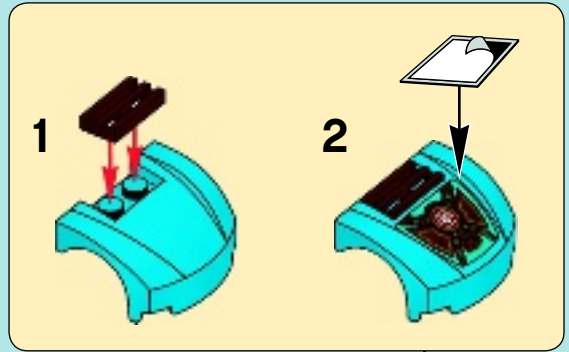

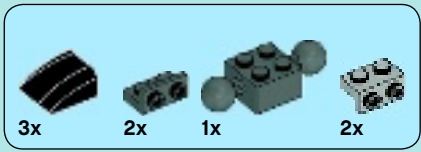

4

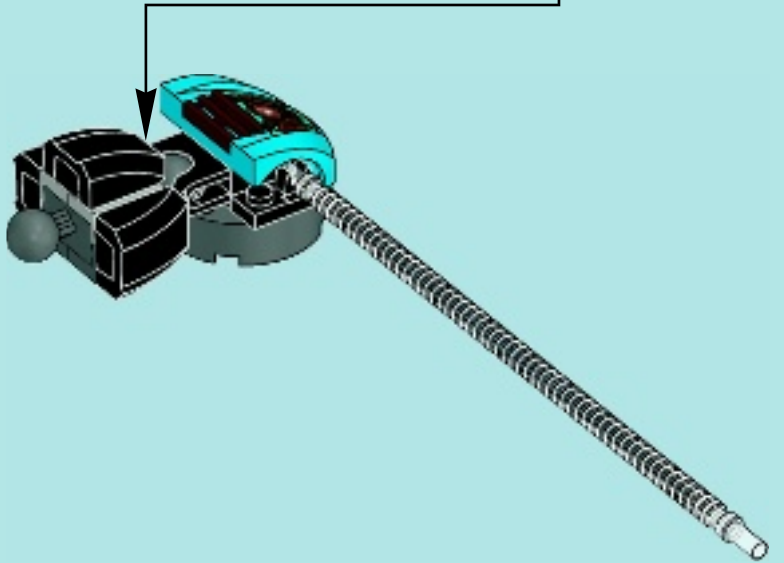
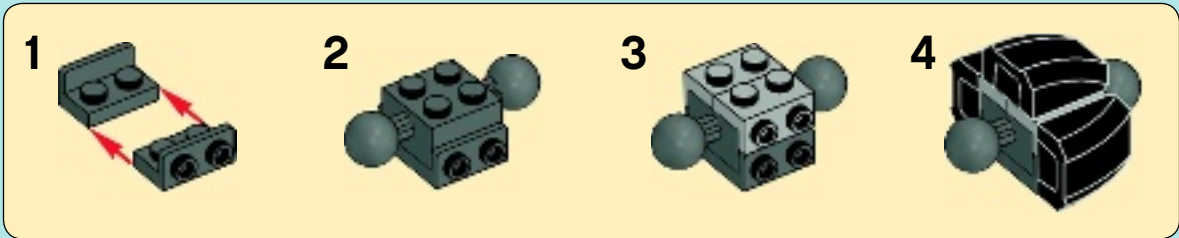

5

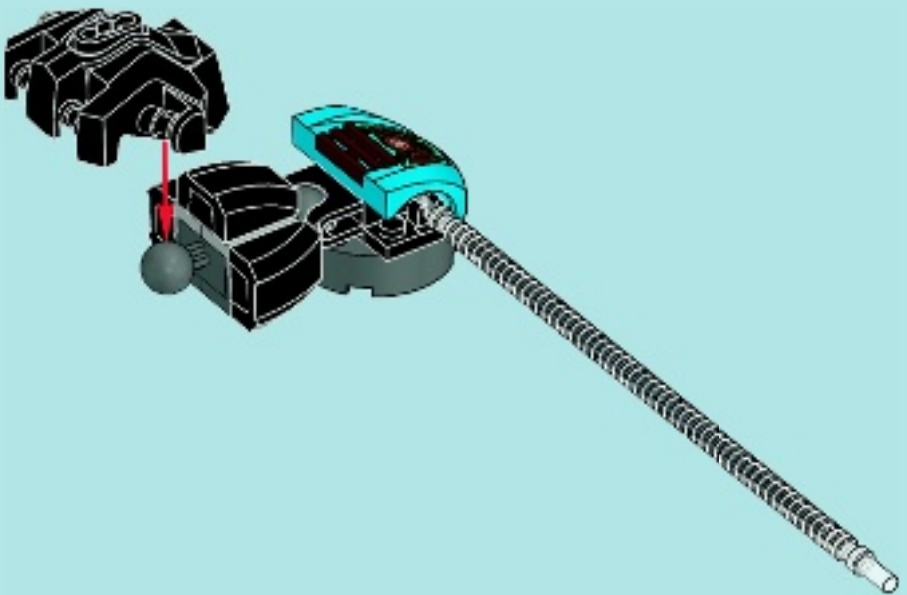

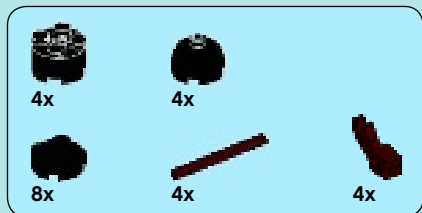

# 6

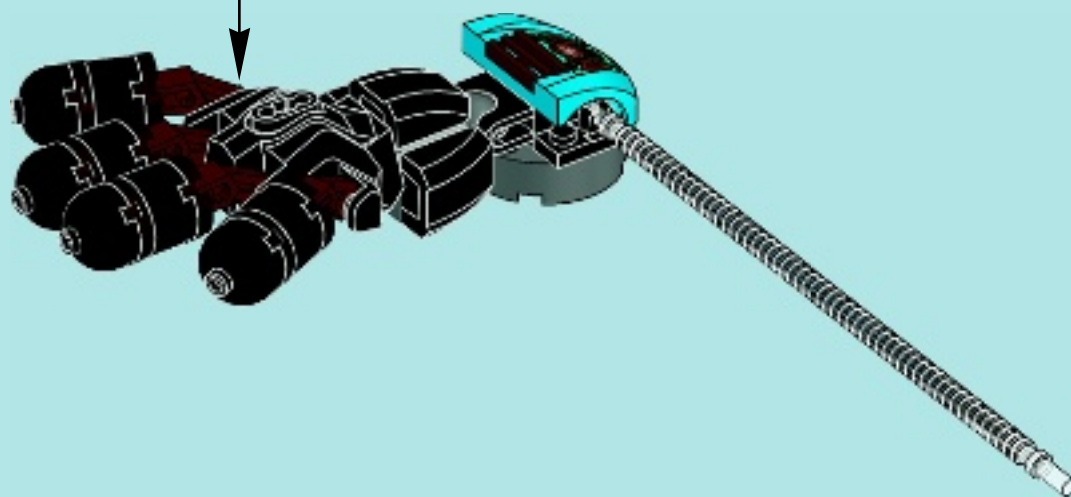

7



35

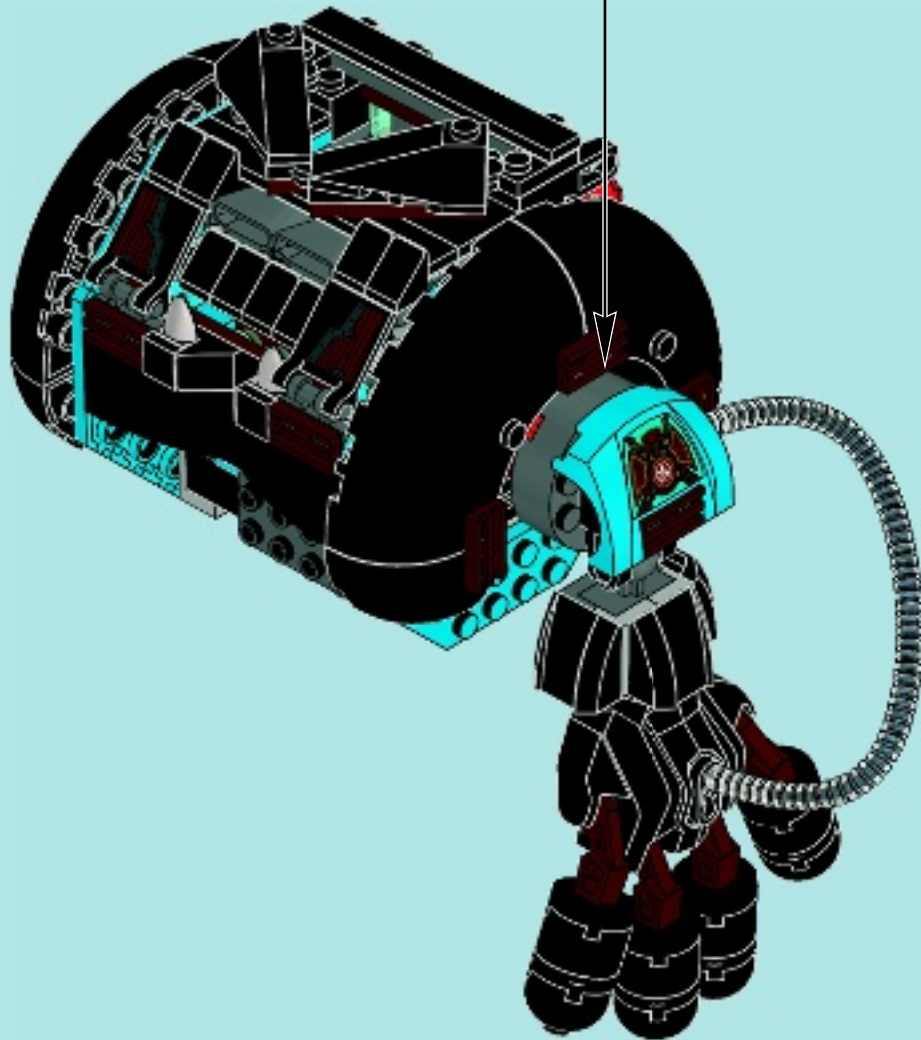





1

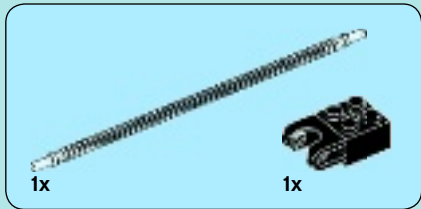

2

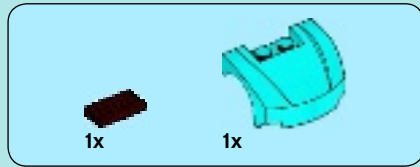
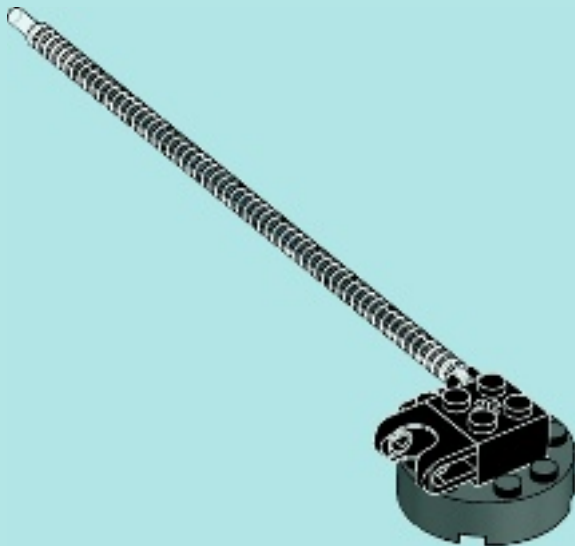

3

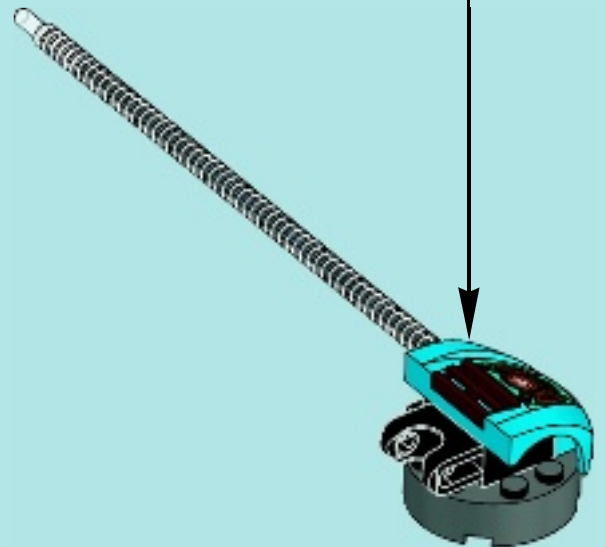
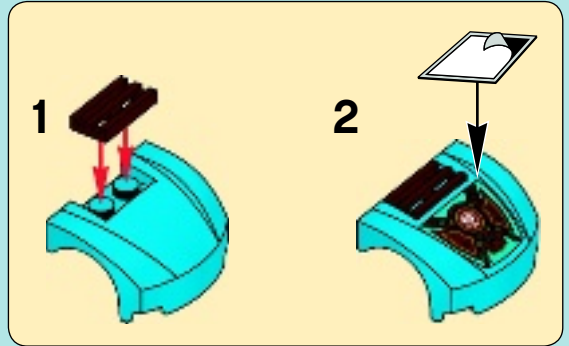

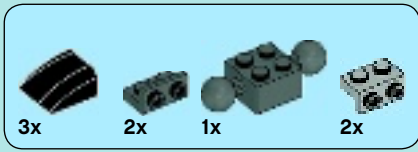

4

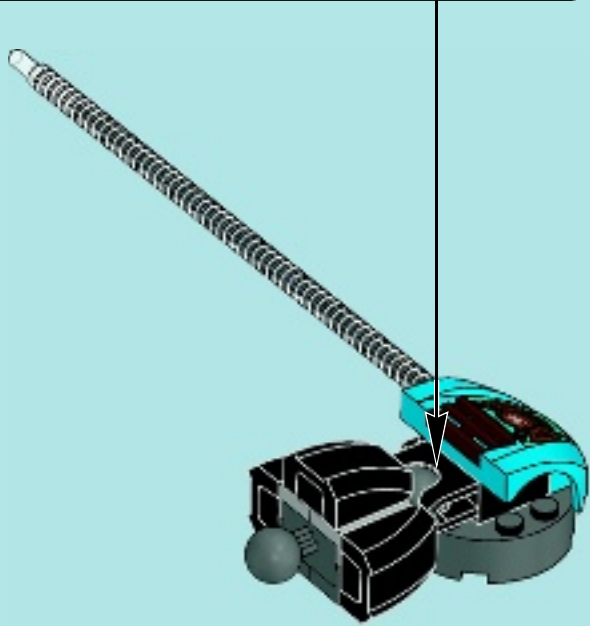
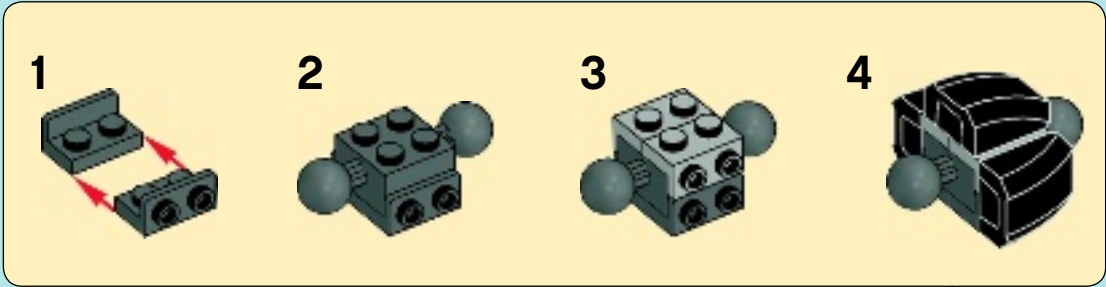

5

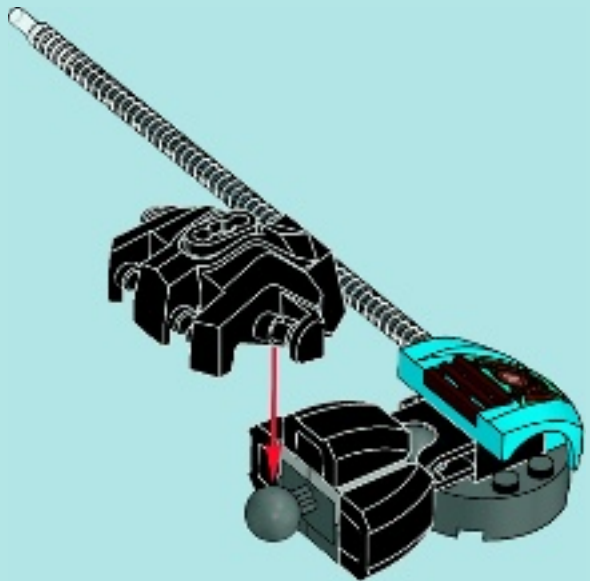

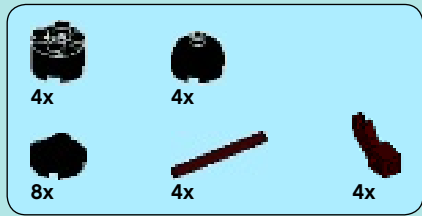

# 6

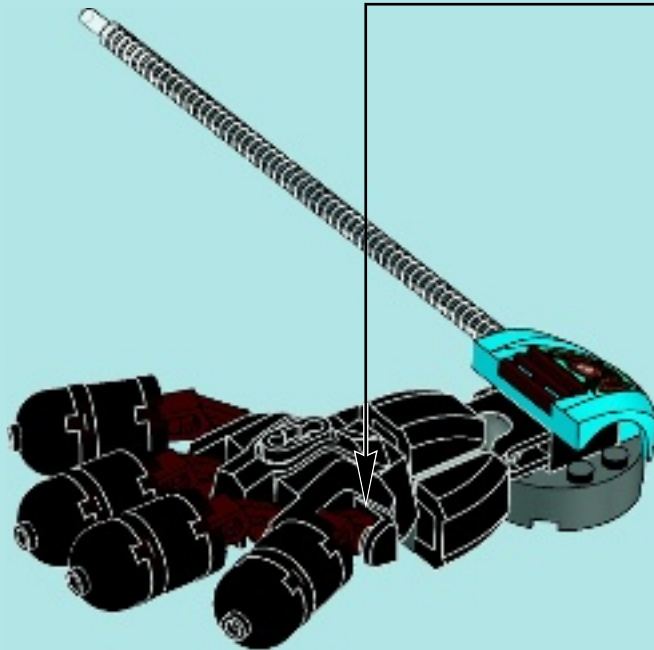

7

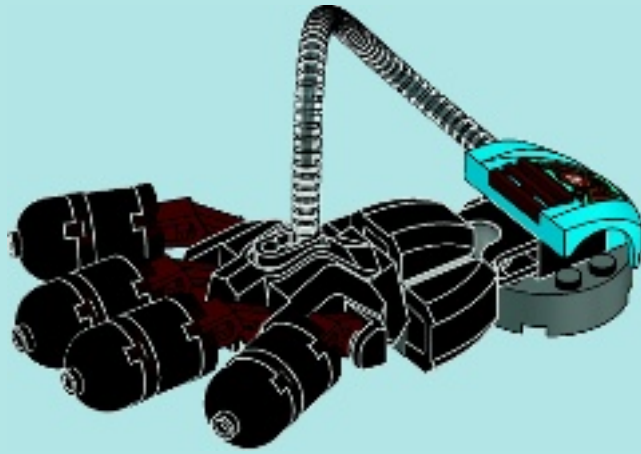

36

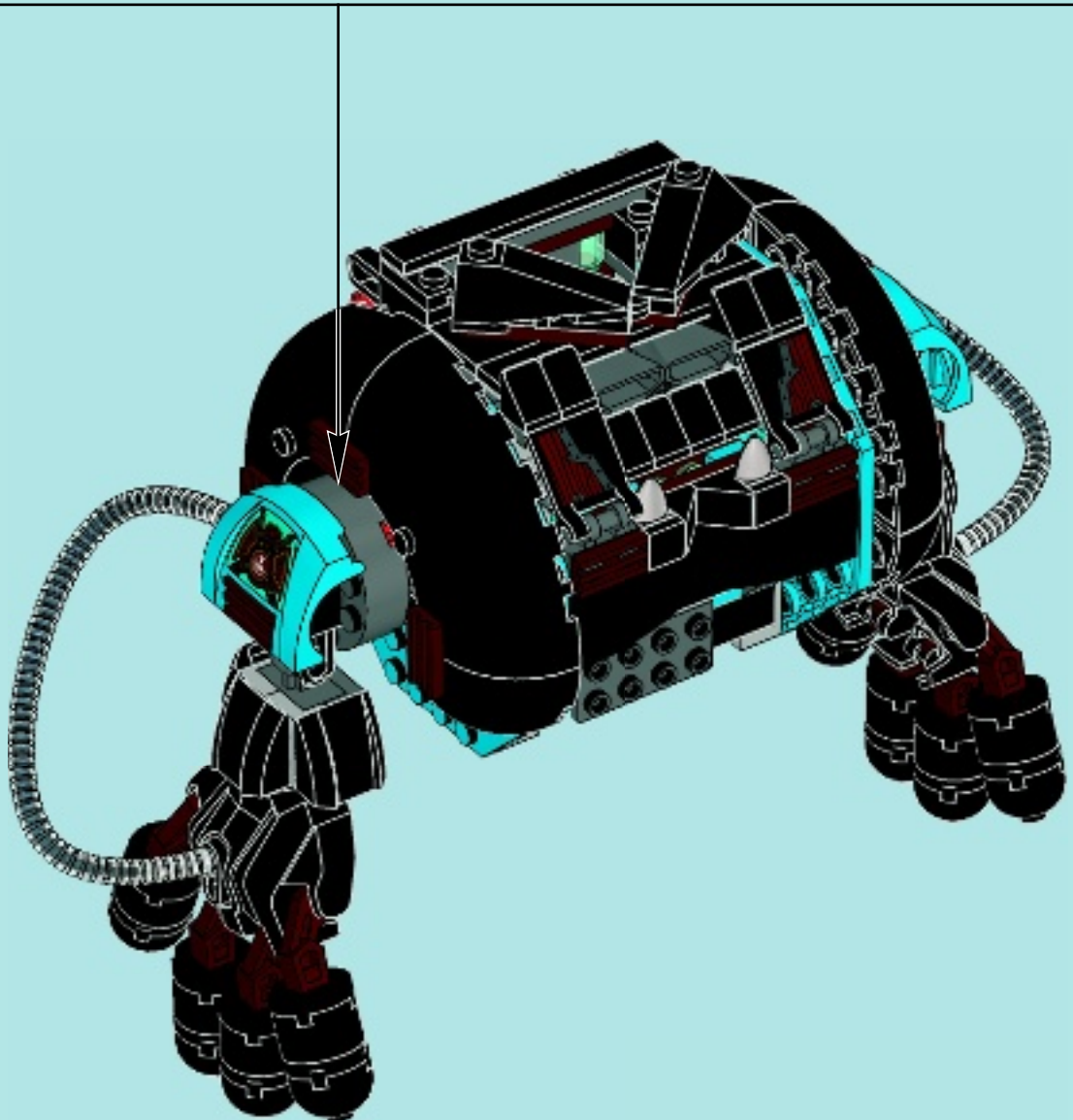

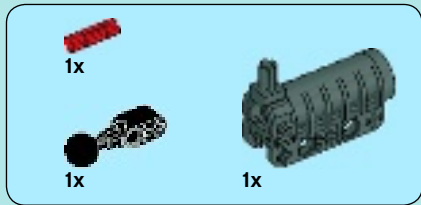

# 37

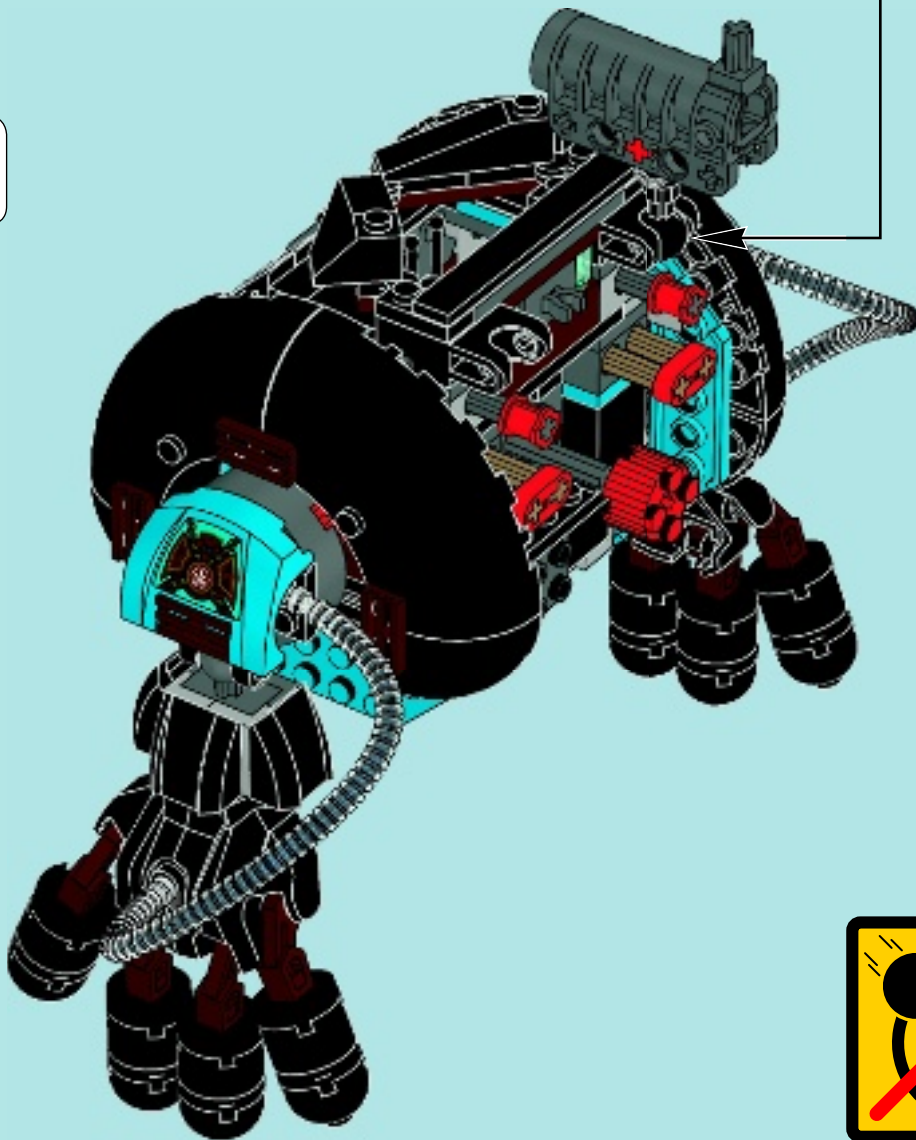
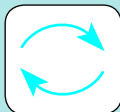
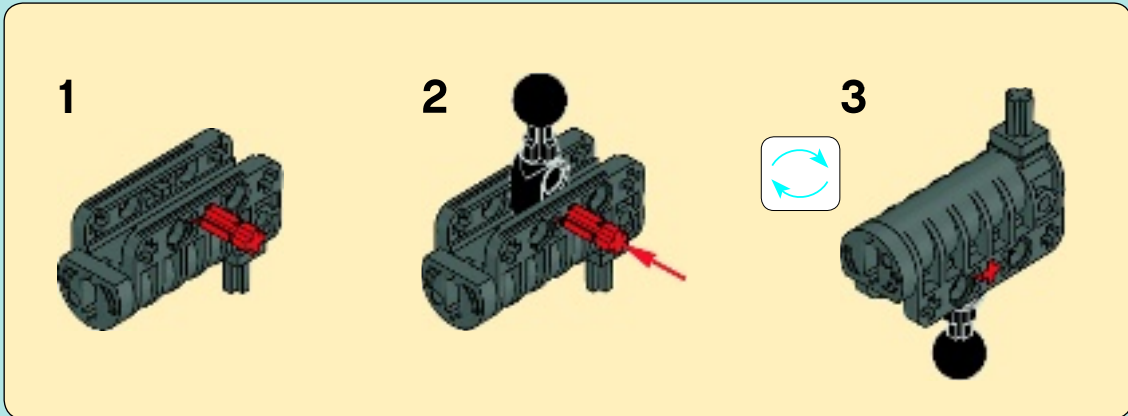



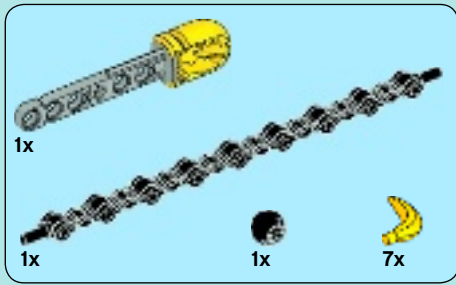

38

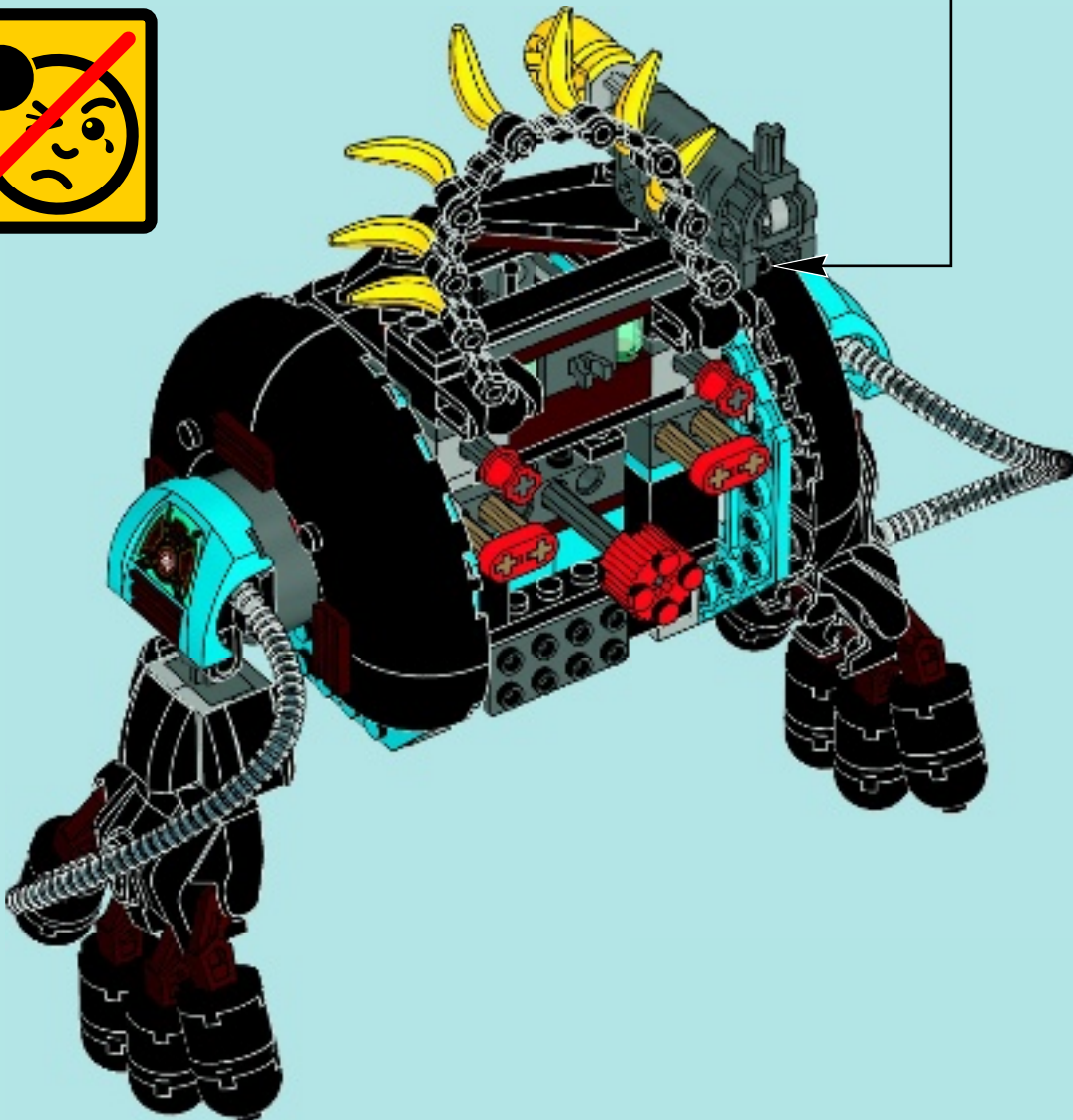
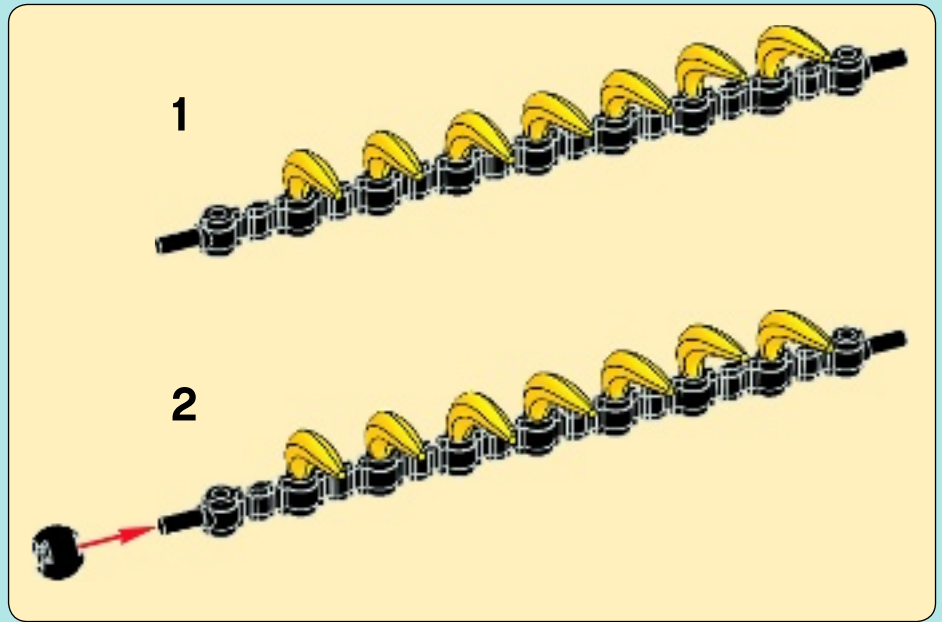

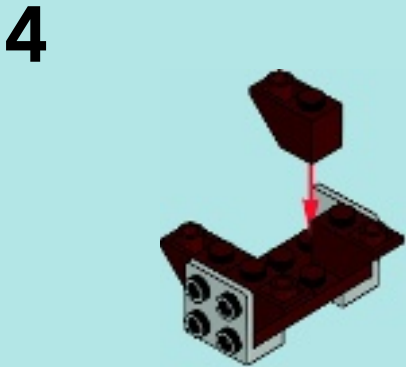
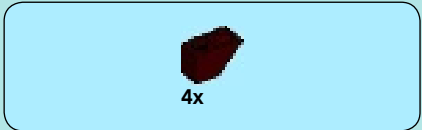
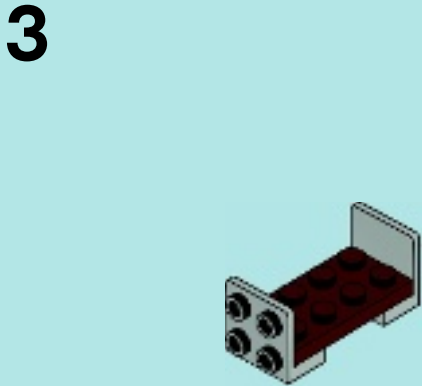
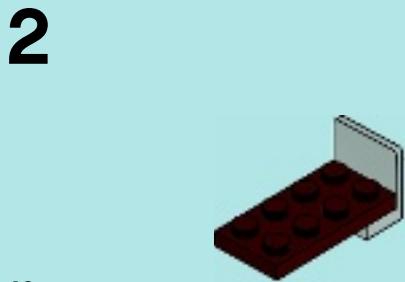
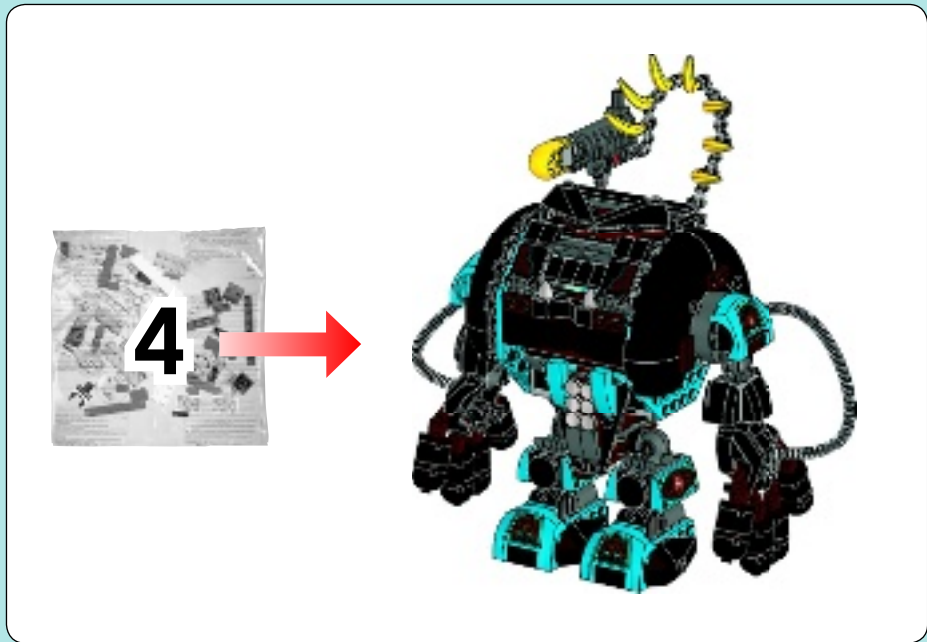

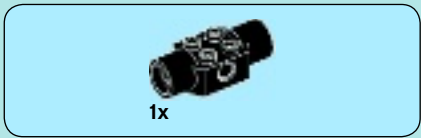

5

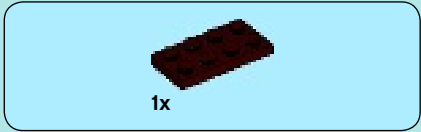

6

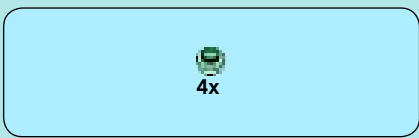

7

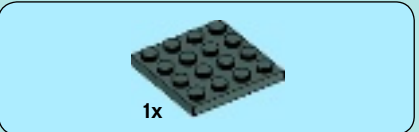

8





2x

9



1x

10



1x



2x

11



2x



4x

12

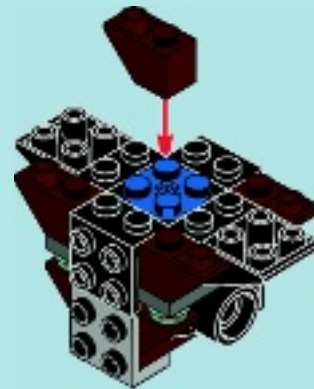



13



39

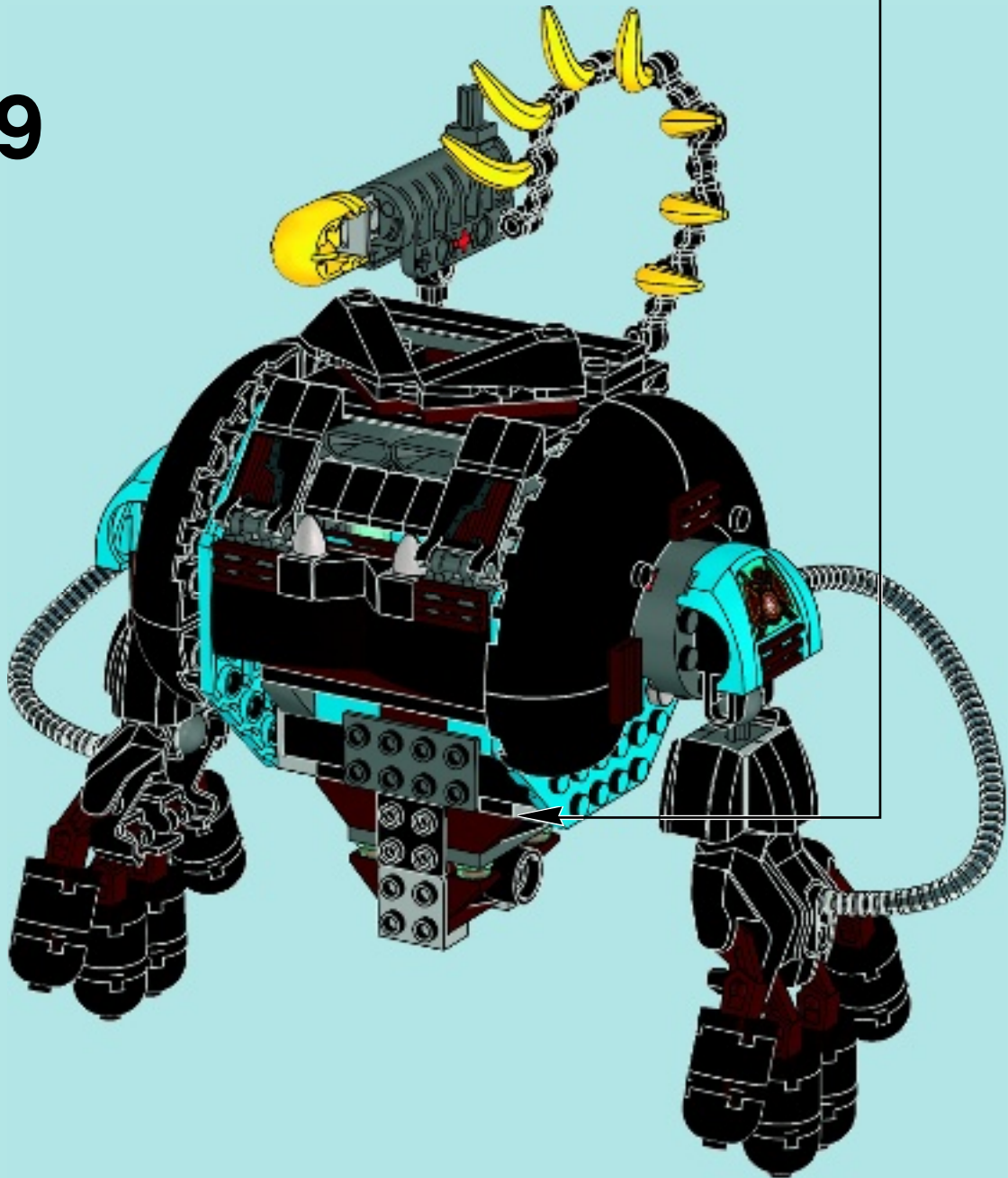



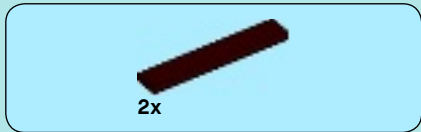

40

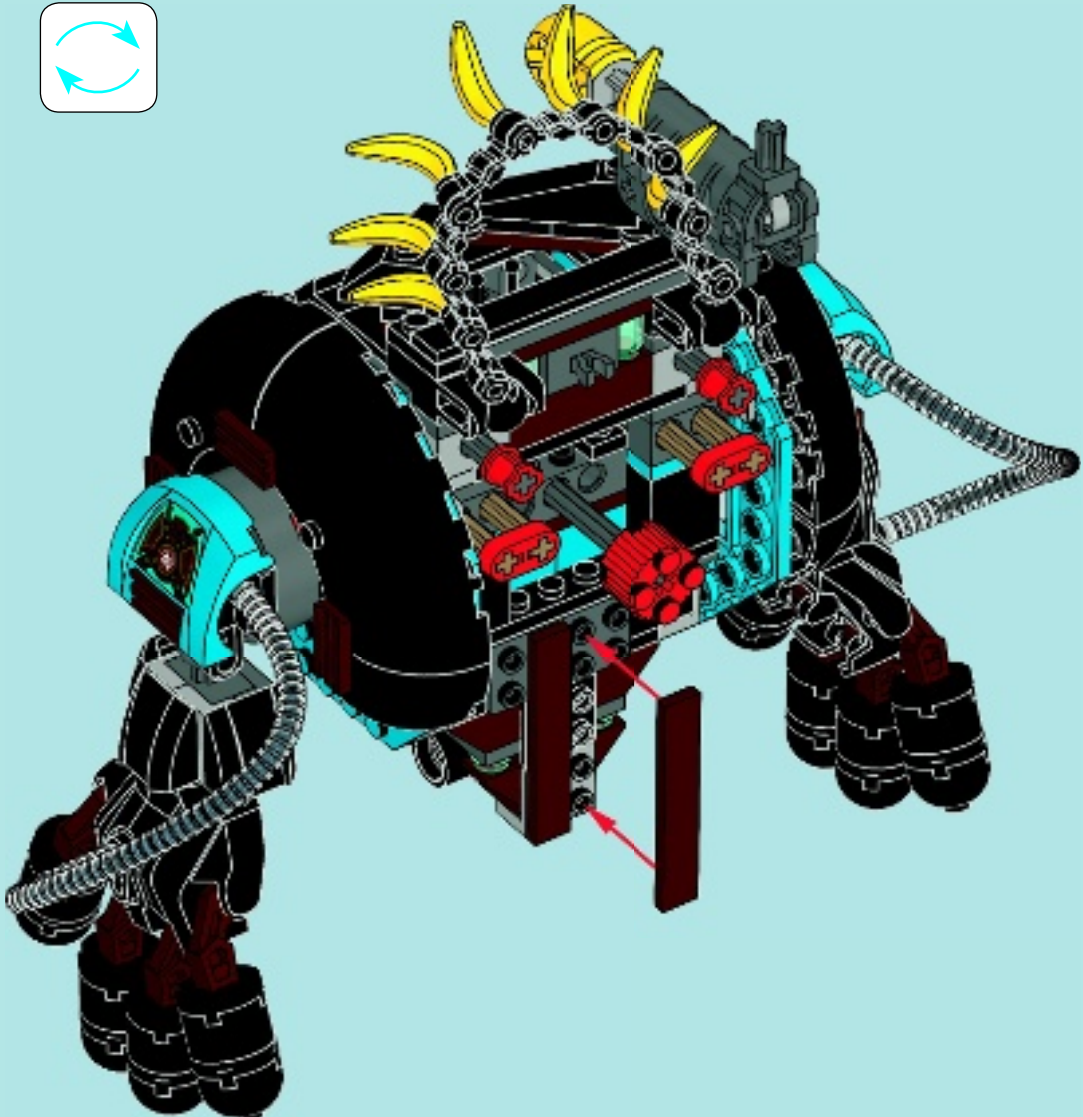
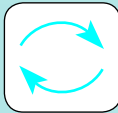

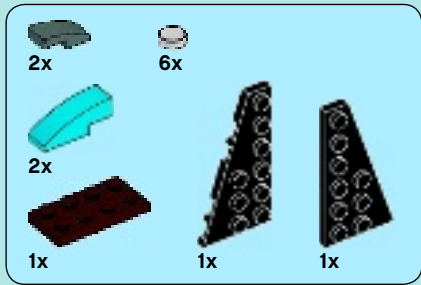

# 41

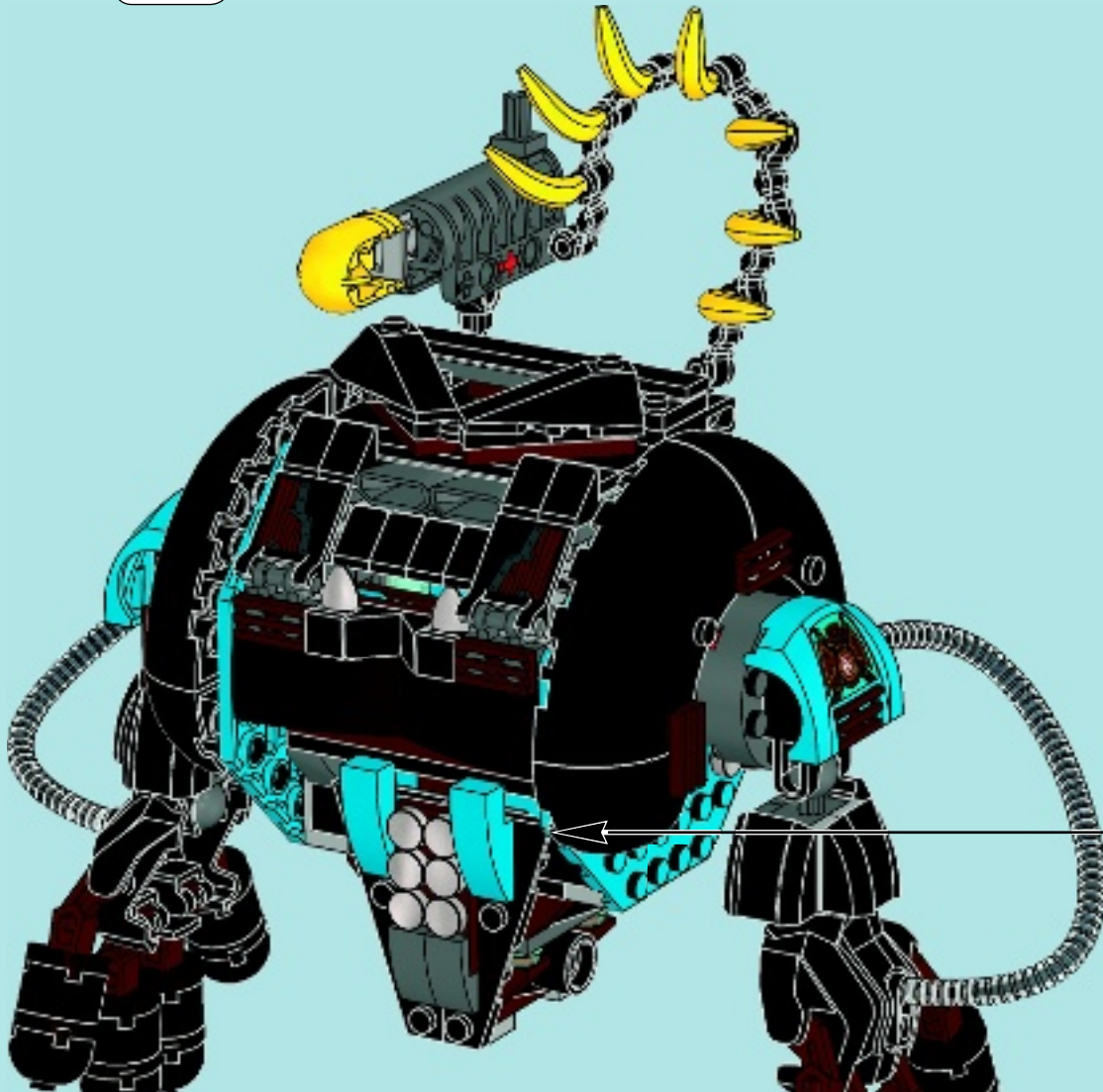
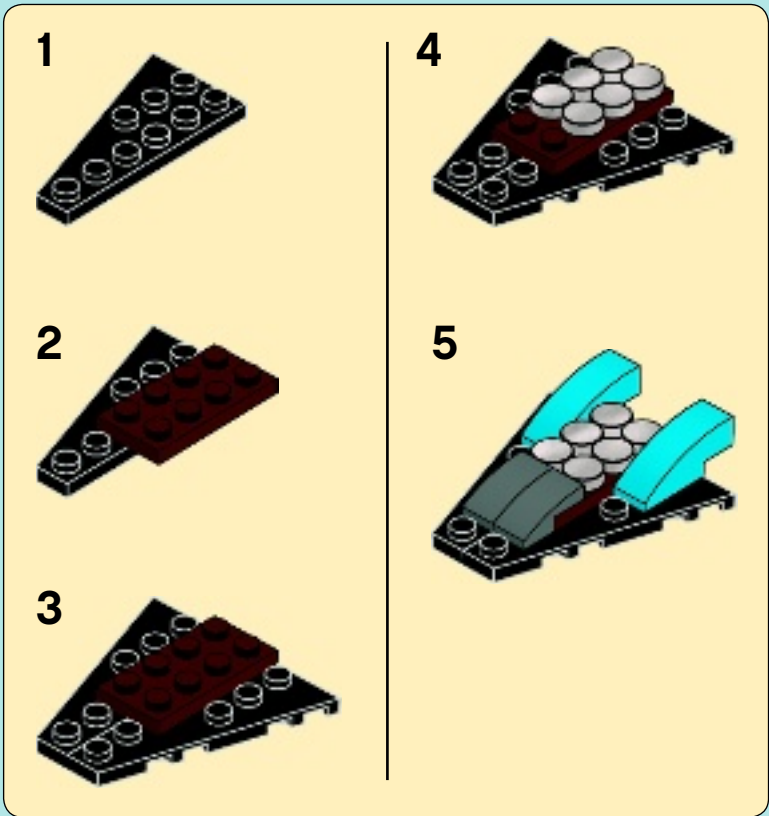
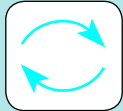

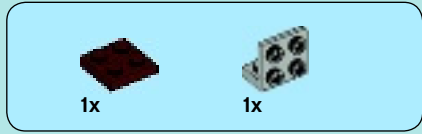

1



2

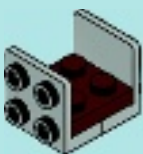

3

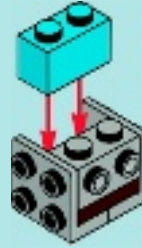

4





5



6

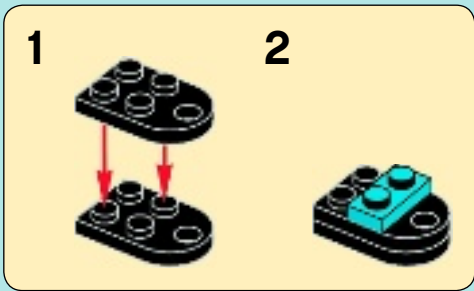

7



8







9

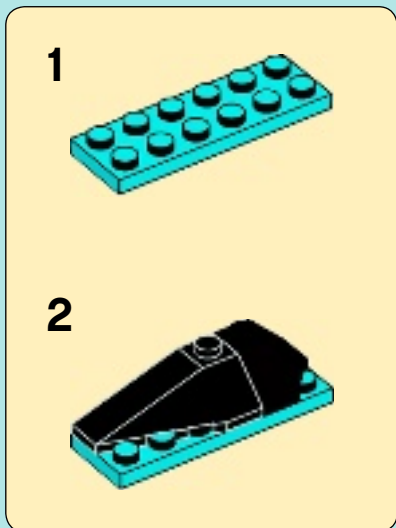

10

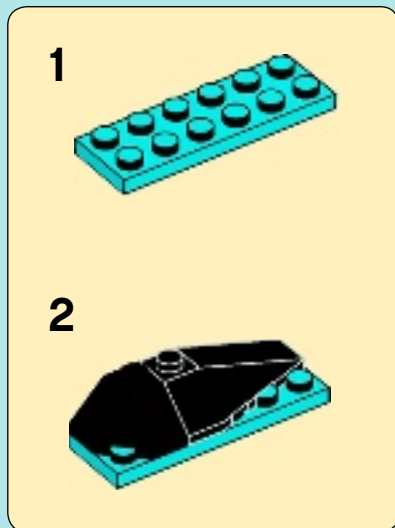

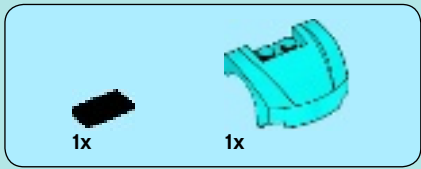

11



12

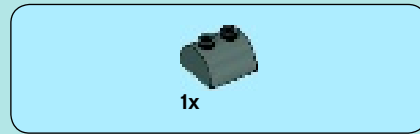

13

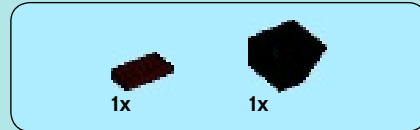
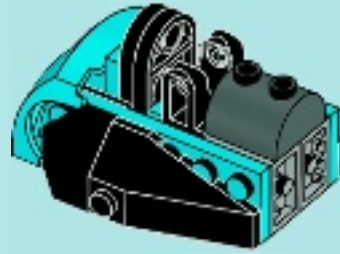
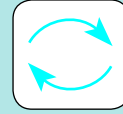

14

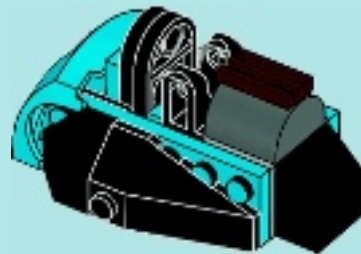



1



2

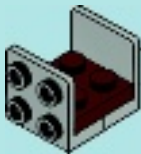

3

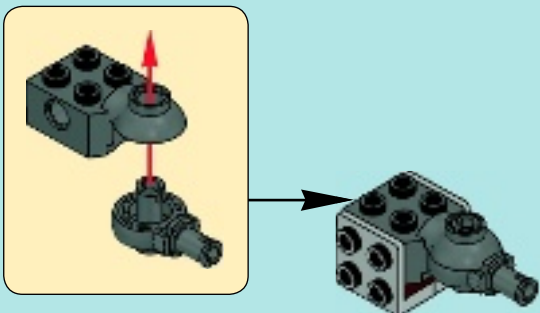

4



5



6





7

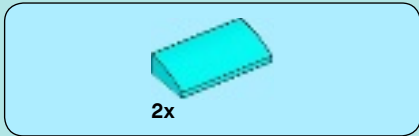

8

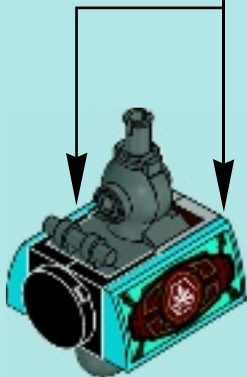
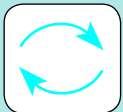
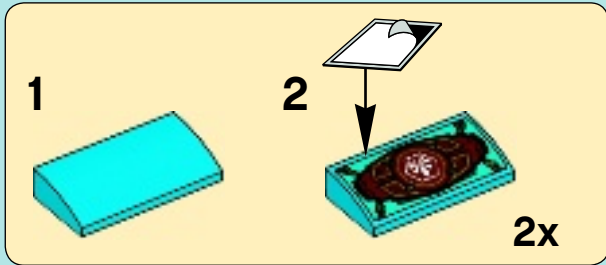

15

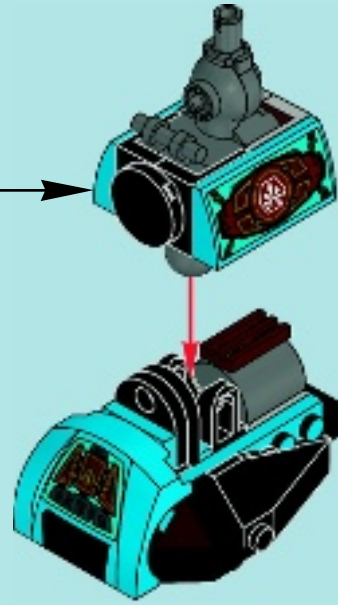

2x

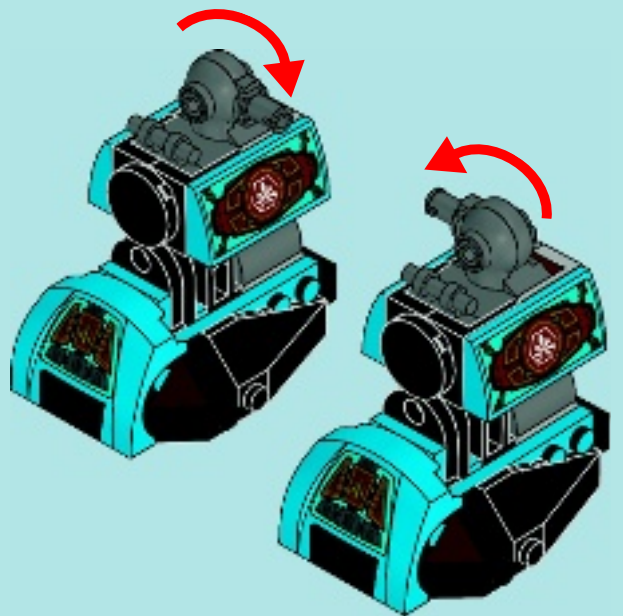



42

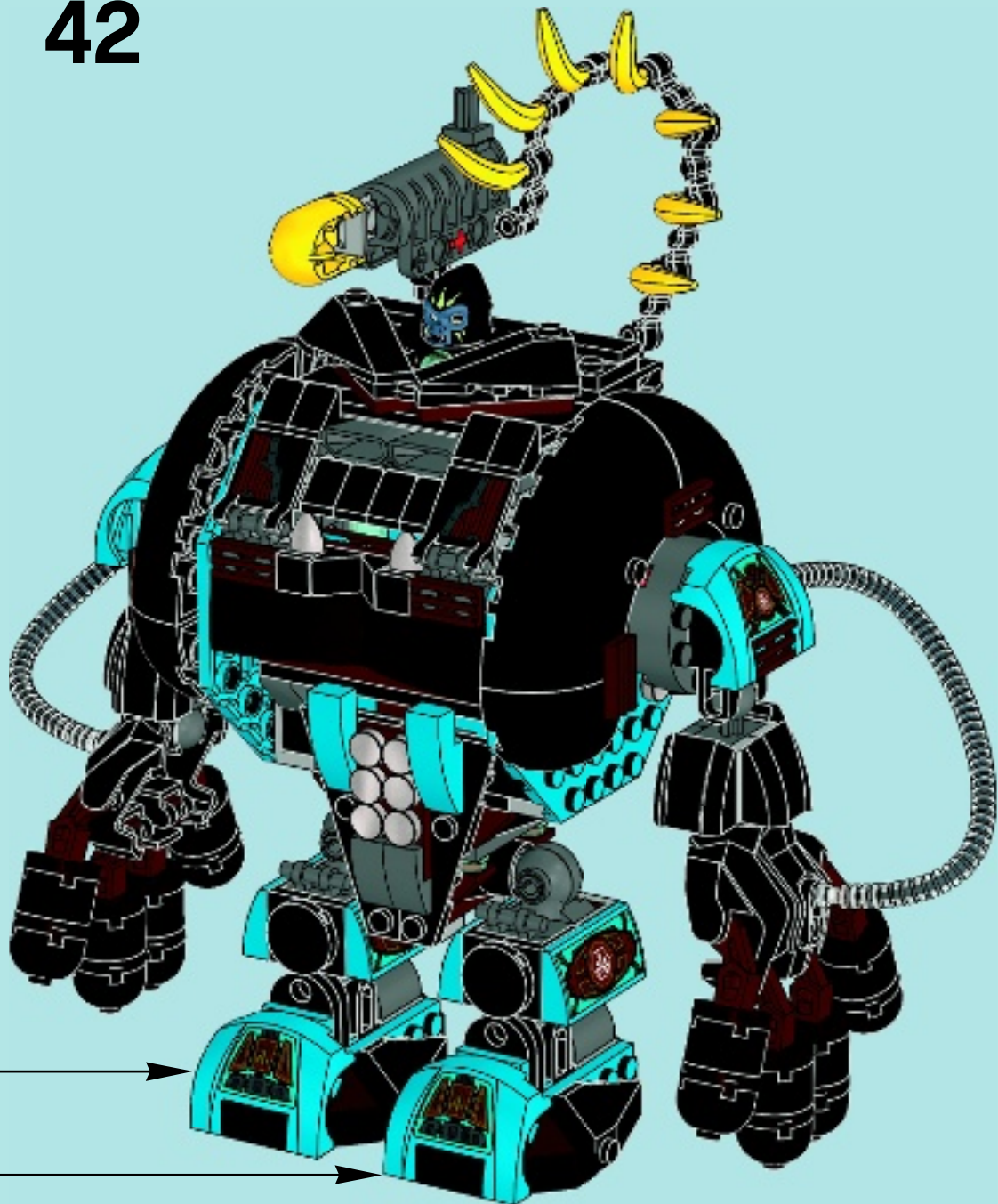



2x 4565452  
 5x 4650646  
 1x 4560179  
 2x 4186678  
 2x 4227155  
 1x 4142865  
 2x 4513174  
 1x 306823  
 4x 6009460  
 1x 403223  
 2x 4296152  
 7x 4114584  
 2x 6037390  
 6x 4619763  
 1x 4275826  
 8x 4216660  
 8x 614326  
 4x 4609397  
 4x 6025219

2x 370126  
 14x 4653087  
 2x 4273703  
 4x 6007896  
 2x 374726  
 3x 6040298  
 3x 6040297  
 2x 4599499  
 1x 395826  
 1x 303626  
 3x 6030718  
 2x 307026  
 2x 415026  
 4x 4598528  
 1x 4515340  
 10x 6048856  
 1x 6020193  
 2x 4556158

4x 4107761  
 2x 306826  
 4x 317626  
 3x 74011  
 2x 416226  
 1x 4283047  
 1x 4283046  
 1x 4515350  
 2x 6011815  
 1x 6024850  
 1x 6037625  
 1x 6022564  
 1x 6035319  
 1x 6035176  
 1x 6022509  
 1x 6022292  
 1x 6035141  
 1x 4537551



1x 4598897  
 2x 4563477  
 2x 6015899  
 2x 6018304  
 6x 4143875  
 1x 4517986  
 1x 4500902  
 4x 4290713  
 1x 4286267  
 1x 4560108  
 2x 4652375  
 3x 370626  
 1x 4652060  
 4x 4119479  
 1x 4507311

2x 3005741  
 2x 4124108  
 1x 6024904  
 4x 4183544  
 3x 6022171  
 12x 4163917  
 1x 6019570  
 6x 4497952  
 1x 4654448  
 4x 6031821  
 2x 6024916  
 2x 6021978  
 1x 4211225  
 2x 4216615  
 1x 4263776  
 8x 4211222  
 2x 4216625  
 2x 4614561

6

- 1x 4219726
- 4x 4216695
- 8x 4211190
- 8x 4211186
- 1x 4211211
- 1x 4225700
- 13x 4224243
- 2x 4211204
- 2x 4211219
- 10x 4262974
- 8x 6006740
- 2x 6015344
- 2x 4650645
- 4x 4211440
- 2x 4211410
- 2x 4211429
- 2x 4211396
- 1x 4211395
- 1x 4211814
- 14x 4654580
- 4x 4654582
- 1x 4211376
- 4x 6014615
- 1x 4258308
- 6x 4520320
- 3x 4211807
- 1x 6043056
- 1x 4265794
- 2x 4497253
- 2x 4210725
- 2x 4227395
- 2x 4498096
- 2x 4294180
- 2x 4558959
- 4x 4210762
- 1x 4213607
- 1x 4552203
- 2x 6029948
- 2x 4211093
- 2x 4598769
- 1x 4211056
- 1x 4243831
- 4x 4211002
- 1x 4210763
- 4x 6000606
- 4x 4210660
- 2x 4568734
- 4x 4648067
- 2x 4560184
- 1x 6037691
- 1x 6035318
- 1x 6035175
- 1x 6035135
- 2x 4502068
- 1x 4218696
- 2x 4522784
- 2x 4560177
- 2x 4560177
- 1x 4508553
- 1x 4518308
- 2x 4648296
- 4x 6034202
- 2x 6032854
- 2x 4566688
- 16x 4623298
- 1x 6035317
- 1x 6037419
- 1x 6035087
- 1x 6005225
- 2x 6035093
- 1x 4568951
- 10x 4655241
- 2x 6037878
- 2x 6037408
- 1x 6029660
- 2x 4625146
- 4x 6004943
- 5x 4655172
- 2x 4640901
- 19x 4653988
- 4x 4640891
- 4x 6036880
- 4x 4653722
- 2x 6038284
- 2x 6031787



**Customer Service**  
**Kundenservice**  
**Service Consommateurs**  
**Servicio Al Consumidor**  
**LEGO.com/service or dial**  
**00800 5346 5555 :**       
**1-800-422-5346 :**  





LEGENDS OF  
**CHIMA**<sup>TM</sup>

**IB70008-62**



**USE THE ONLINE CODE TO  
UNLOCK YOUR REWARD  
GIB DEN ONLINE-CODE EIN,  
UM DEINE BELOHNUNG  
FREIZUSCHALTEN**

**UTILISE LE CODE EN LIGNE  
POUR DÉBLOQUER TA  
RÉCOMPENSE**

**USA EL CÓDIGO EN  
INTERNET PARA  
DESBLOQUEAR TU  
RECOMPENSA**

**USA O CÓDIGO ONLINE  
PARA DESBLOQUEARES O  
TEU PRÉMIO**

**HASZNÁLD AZ ONLINE  
KÓDOT, HOGY MEGKAPD  
A JUTALMAD**

**LEGO.COM/CHIMA**





LEGENDS OF  
**CHIMA**<sup>TM</sup>

70203

70200

70010

70115

70009

[LEGO.COM/CHIMA](http://LEGO.COM/CHIMA)











LEGENDS OF CHIMA™



7+



GAMES



LEGO, the LEGO logo and LEGENDS OF CHIMA are trademarks of the LEGO Group. ©2013 The LEGO Group.





# club™

## Free\*! Gratuit!

\* Paid subscription in Australia and New Zealand.  
Abonnement payant en Australie et Nouvelle-Zélande



© 2013 The LEGO Group.

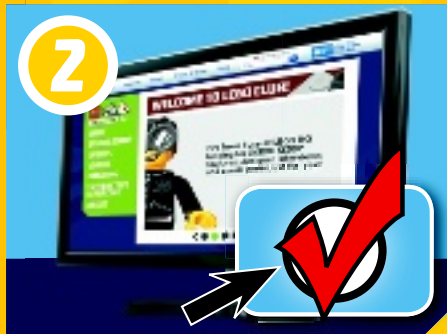

[LEGO.com/club](http://LEGO.com/club)





# WIN!

Go to [www.LEGOsurvey.com/product](http://www.LEGOsurvey.com/product) to fill out a survey for a chance to win a cool LEGO® Product.

No purchase necessary.

Open to all residents where not prohibited.



## [www.LEGOsurvey.com/product](http://www.LEGOsurvey.com/product)

### GEWINNE!

Nimm an der Umfrage auf [www.LEGOsurvey.com/product](http://www.LEGOsurvey.com/product) teil und hab die Chance ein cooles LEGO® Produkt zu gewinnen!

Die Teilnahme am Gewinnspiel führt zu keinerlei Kaufverpflichtungen. Teilnahme in allen nicht ausgeschlossenen Ländern möglich.

### WIN!

Ga naar [www.LEGOsurvey.com/product](http://www.LEGOsurvey.com/product), vul een enquêteformulier in en maak kans op een cool LEGO® product.

Geen aankoopverplichting.  
Iedereen mag deelnemen, uitgezonderd ingezetenden van landen waar een enquêteverbod geldt.

### GAGNE!

Visite [www.LEGOsurvey.com/product](http://www.LEGOsurvey.com/product) pour répondre à un questionnaire et avoir une chance de gagner un produit LEGO® très cool!

Aucune obligation d'achat.  
Ouvert à tous les résidents des pays autorisés.

### 当てよう!

[www.LEGOsurvey.com/product](http://www.LEGOsurvey.com/product) にアクセスして、アンケートにご記入ください。当選者にはレゴ製品を差し上げます。

お買い上げの必要はありません。  
禁止されていない限り、すべての皆様にご利用いただけます。



LEGO.com

6050707

LEGO, the LEGO logo and LEGENDS OF CHIMA are trademarks of the LEGO Group.  
©2013 The LEGO Group.