



# HERO FACTORY

44000



1



2





3



4







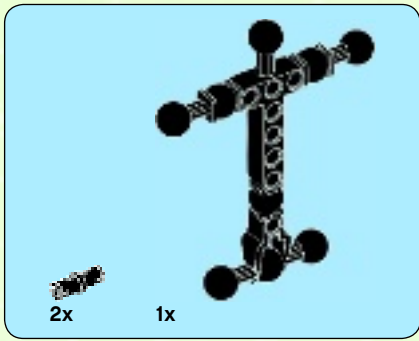

1

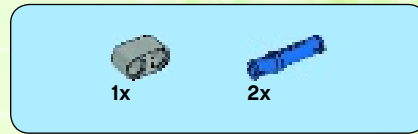

2

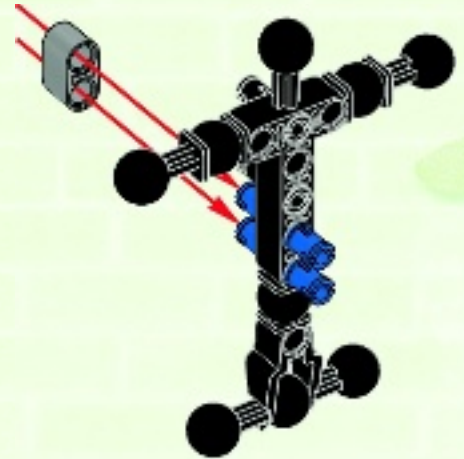



2x

3

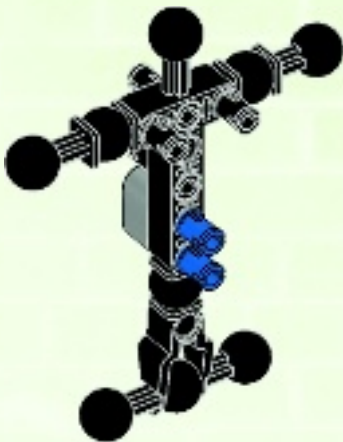

1x



1x

4





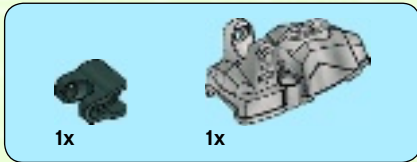

1

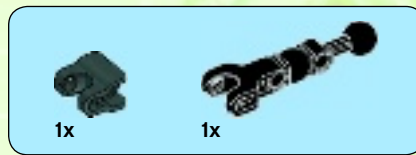
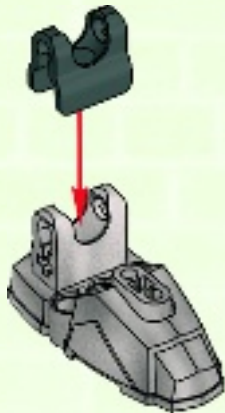

2

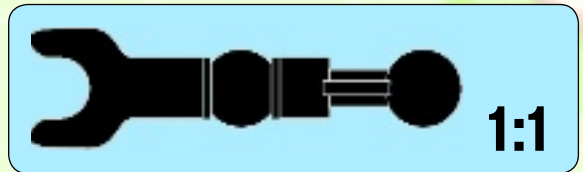



3



4



2x



5

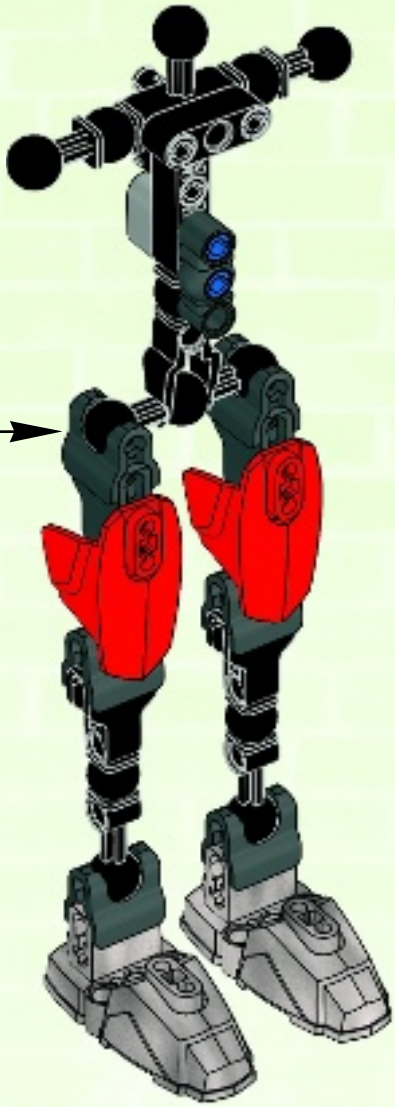

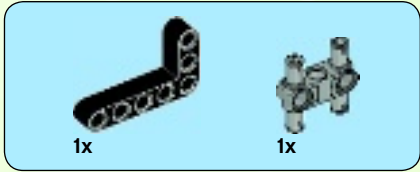

1

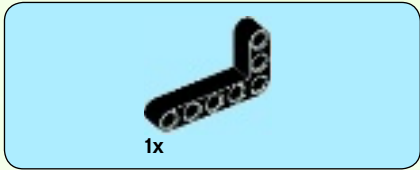

2

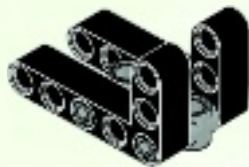

3

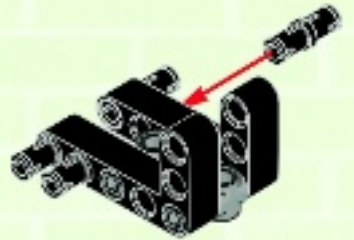

4

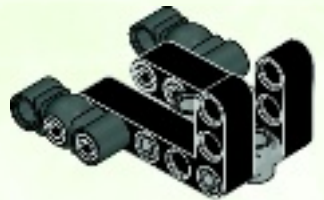



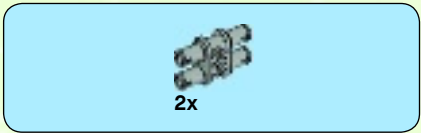

5

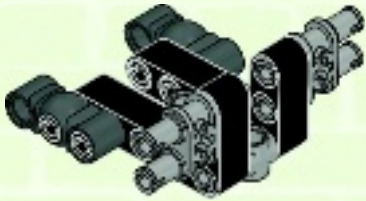

6

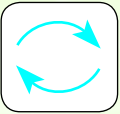

6

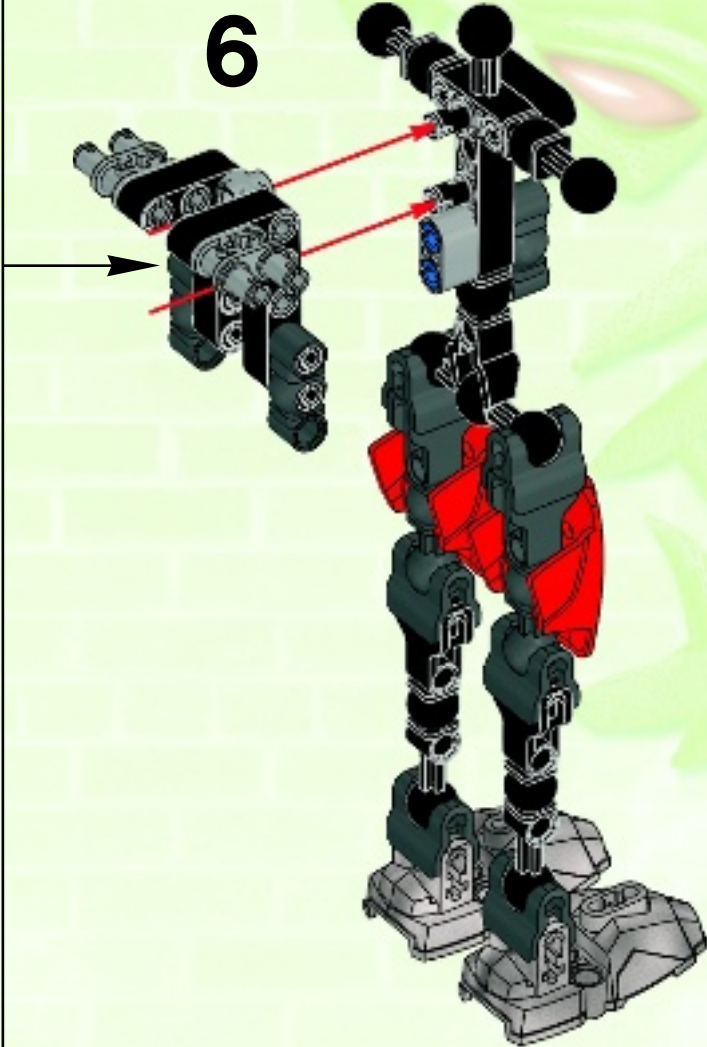



7

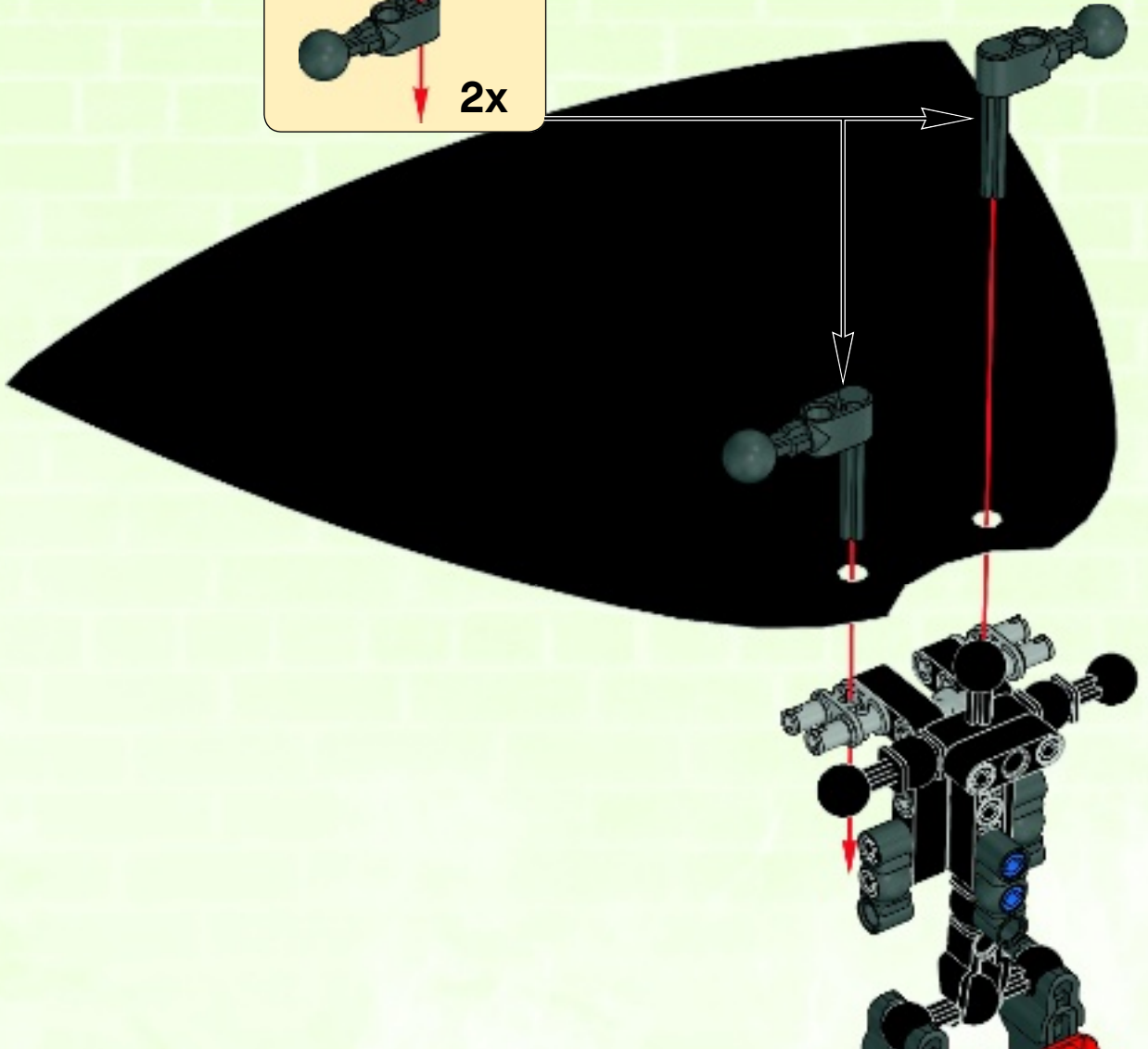
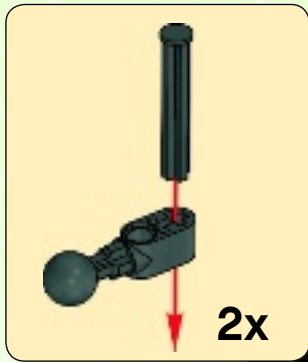

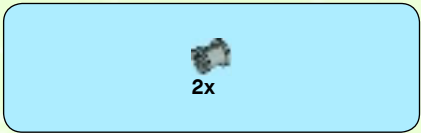

8

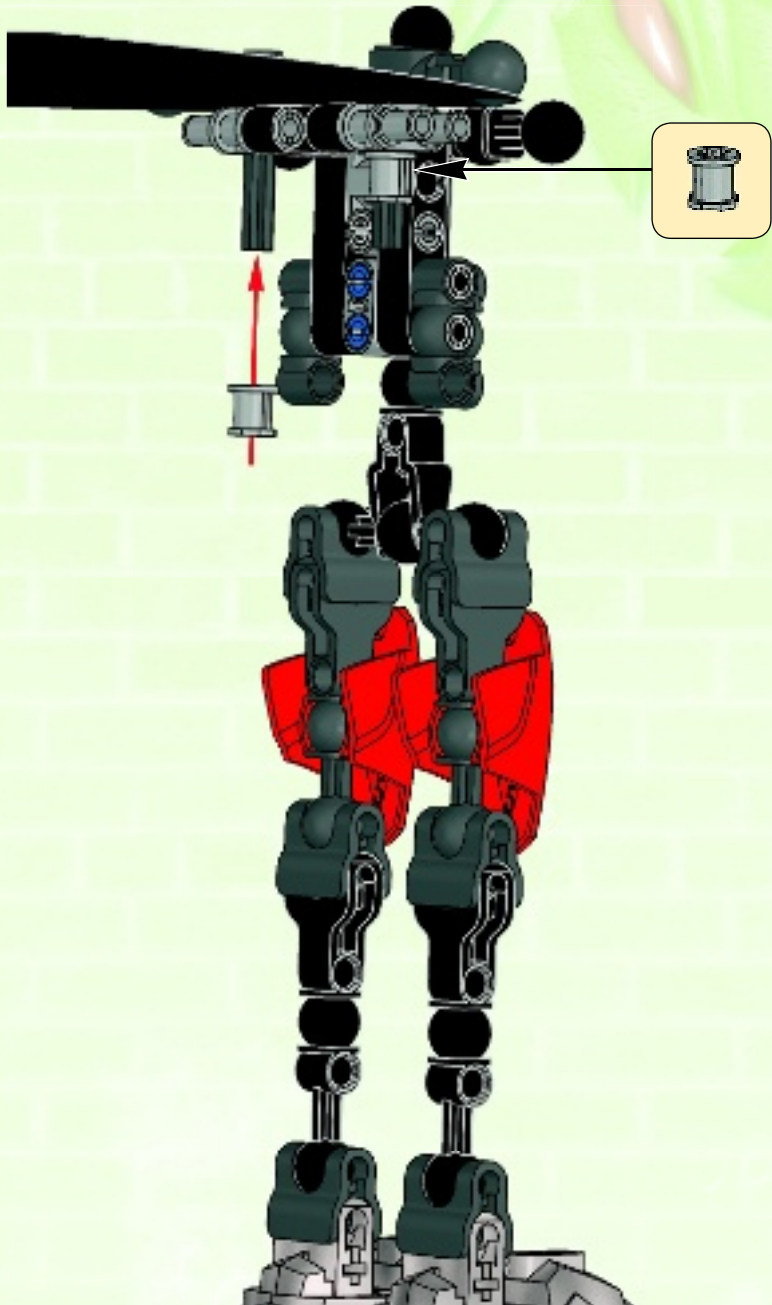





2x

9

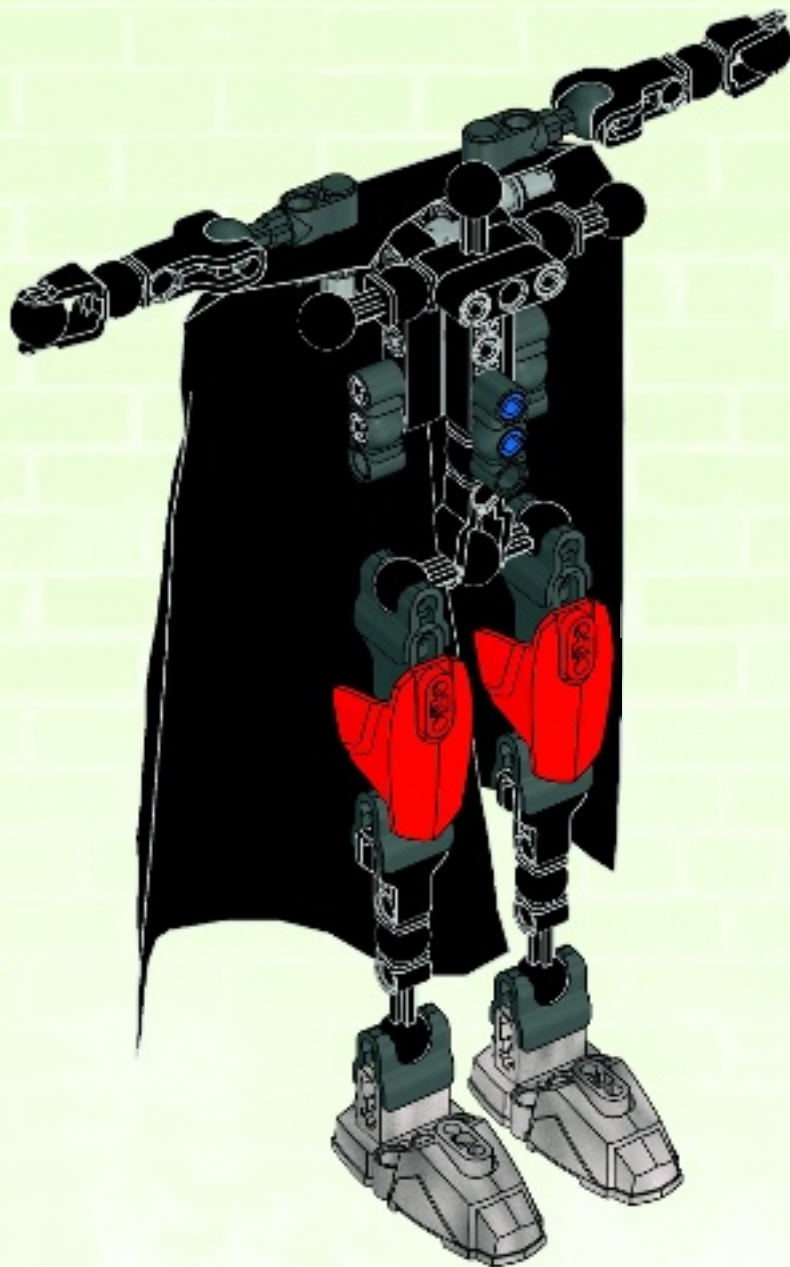



2x

10

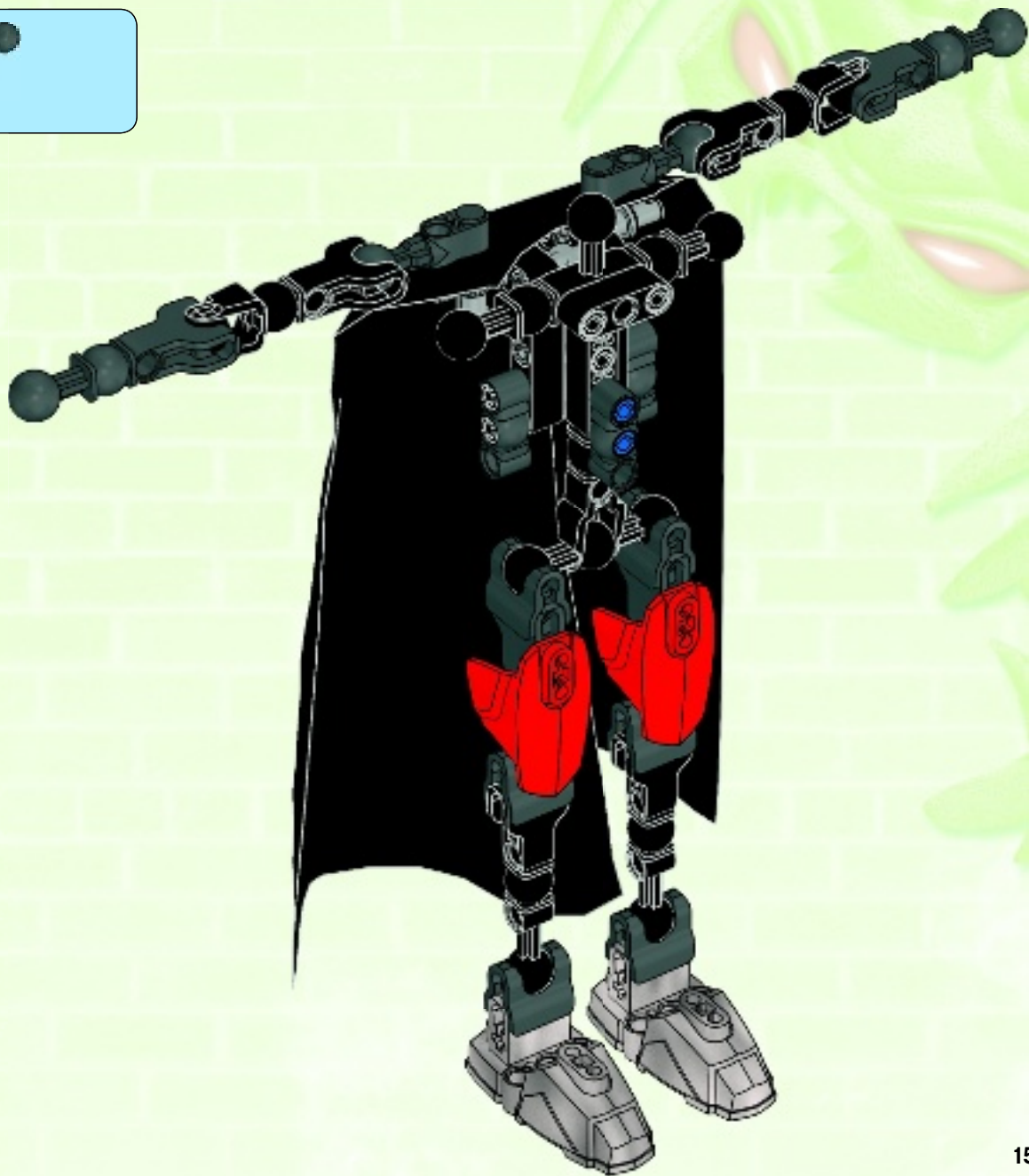



11

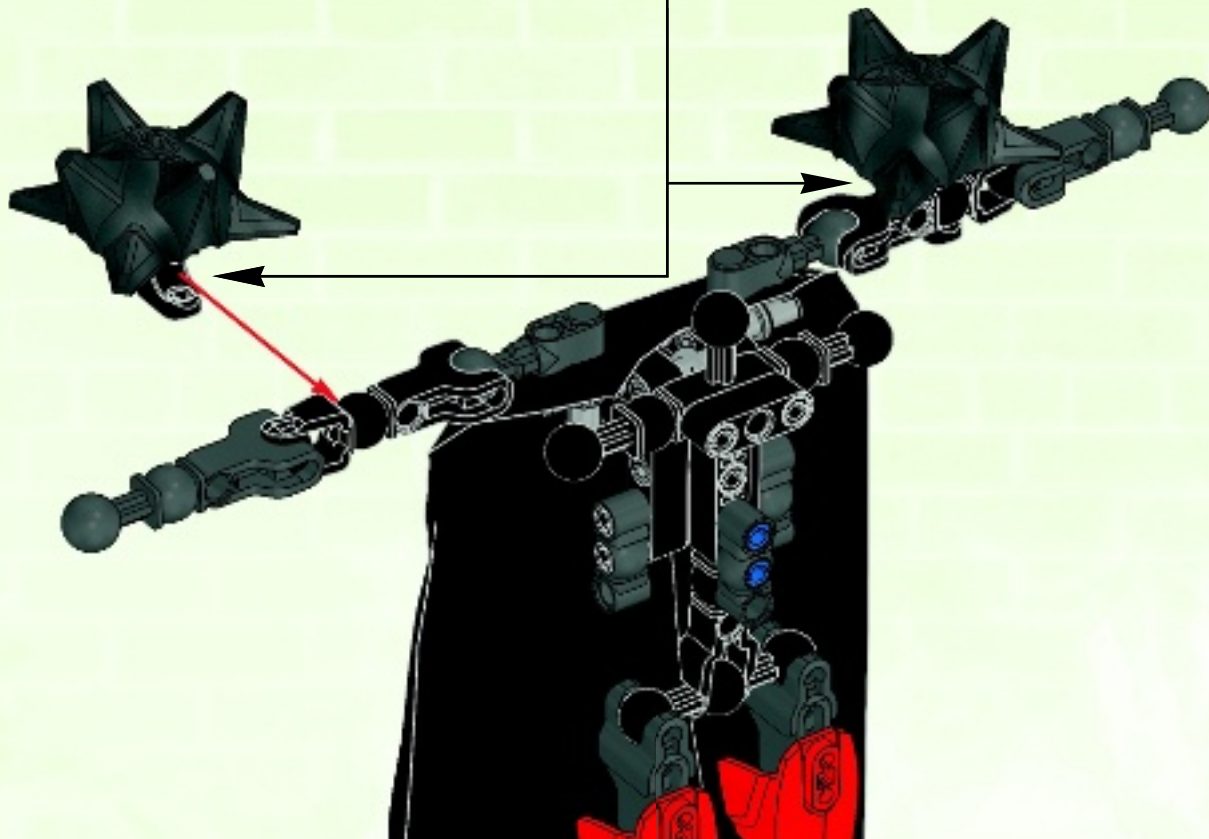
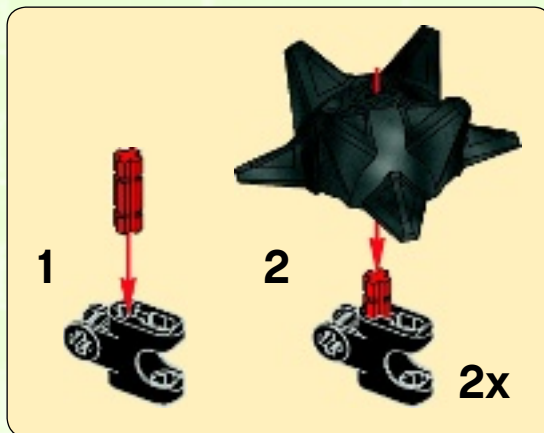





4x

12

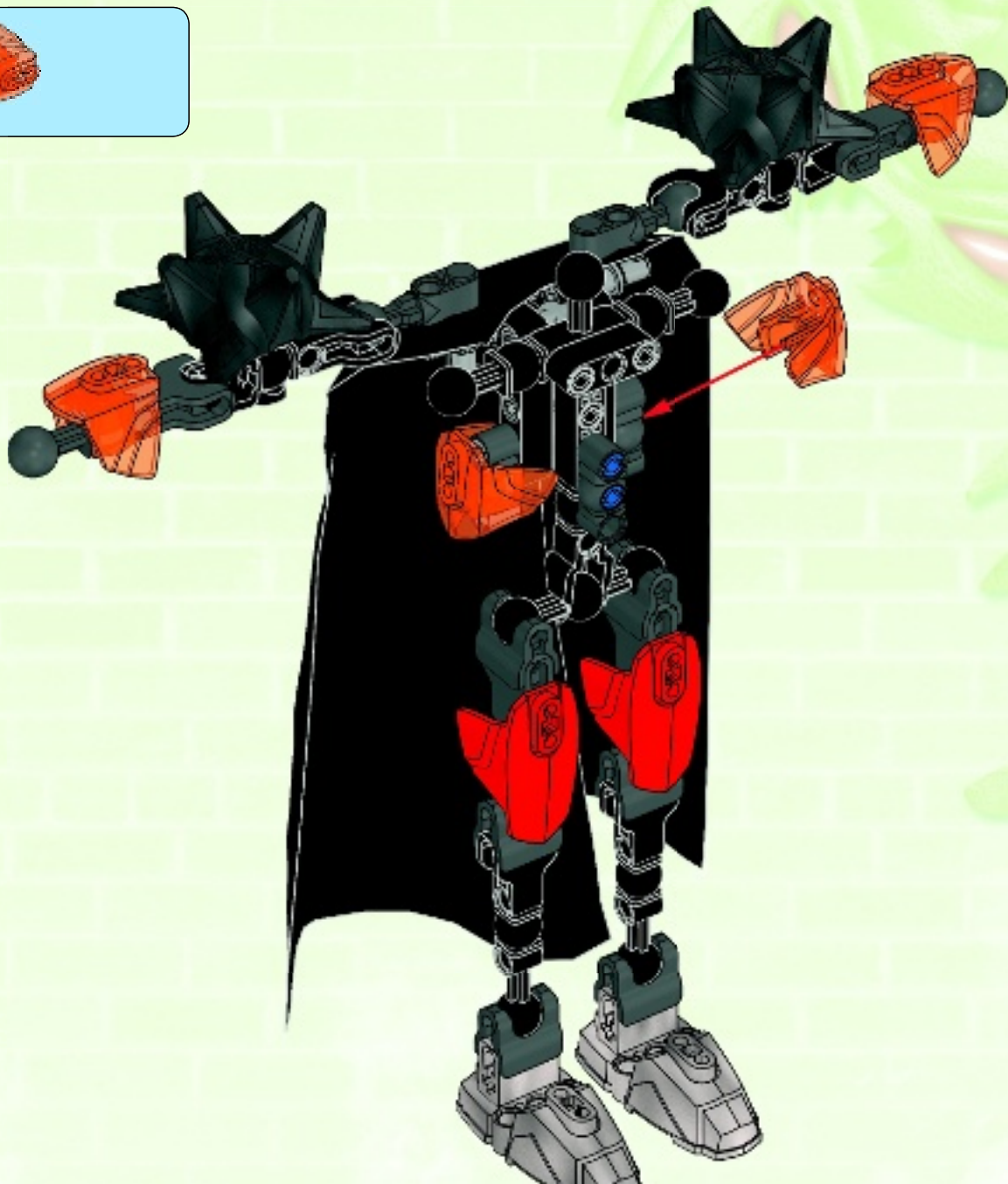

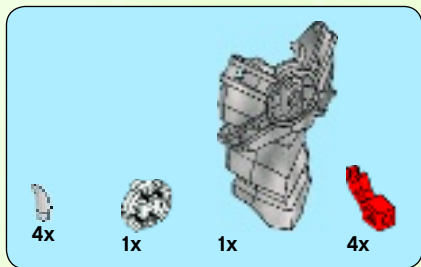

# 13

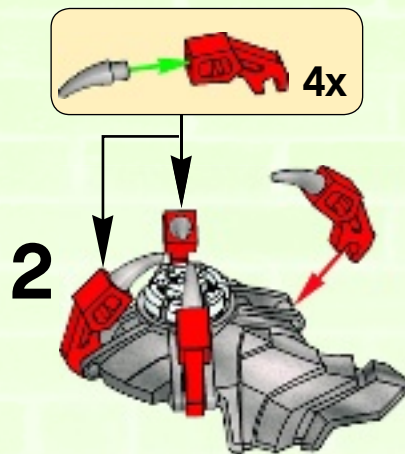

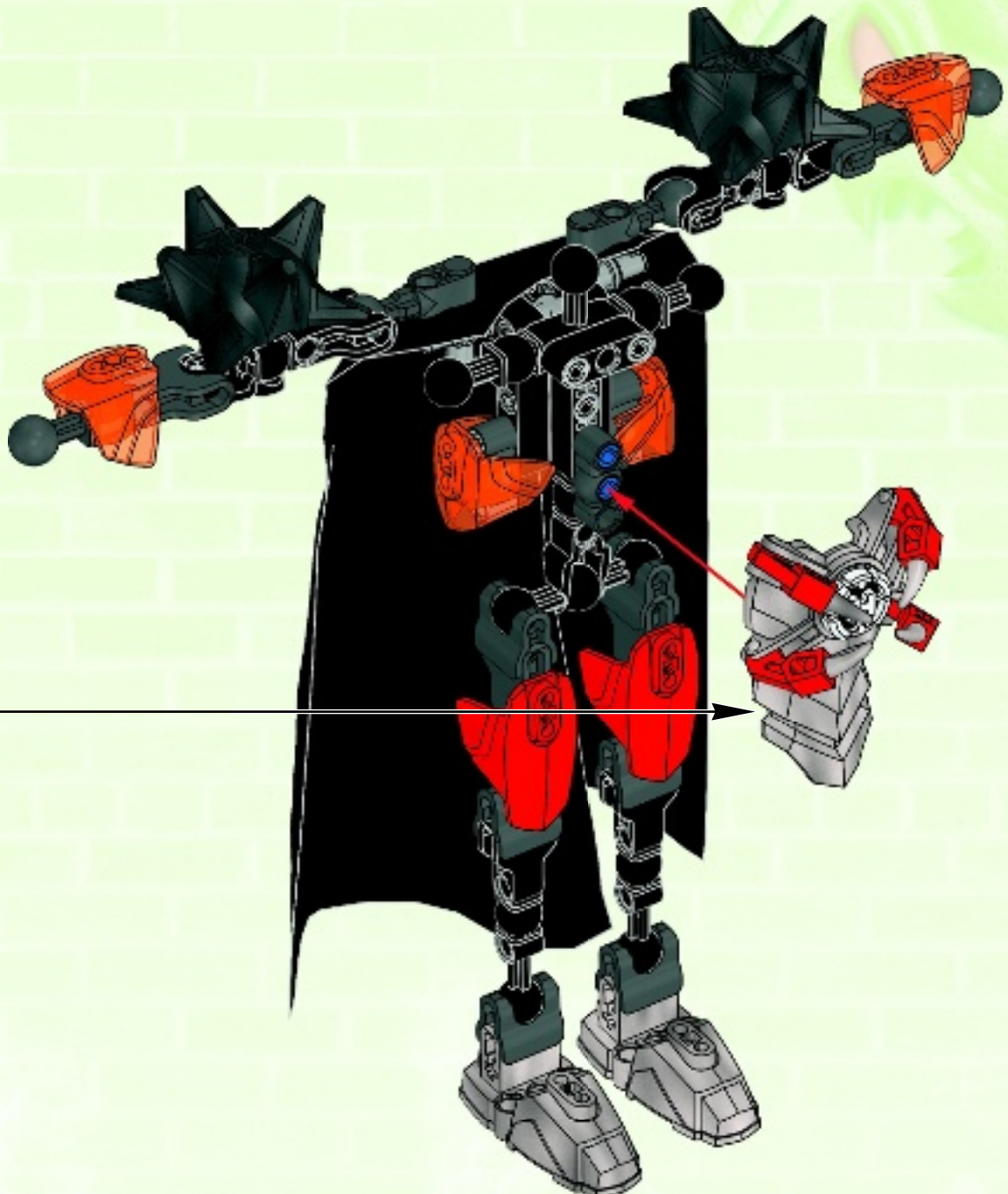



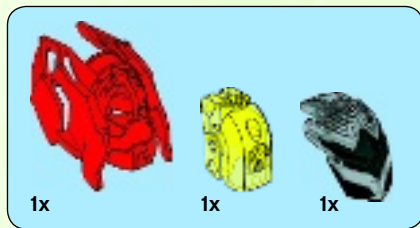

14

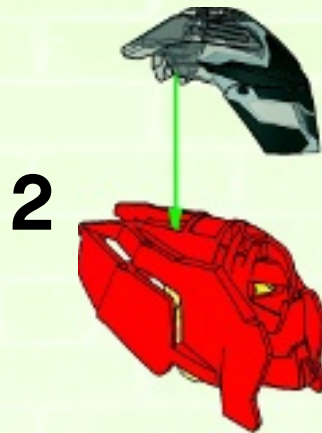
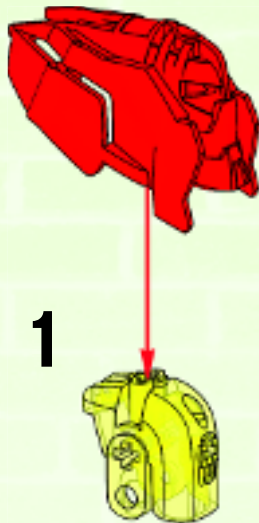

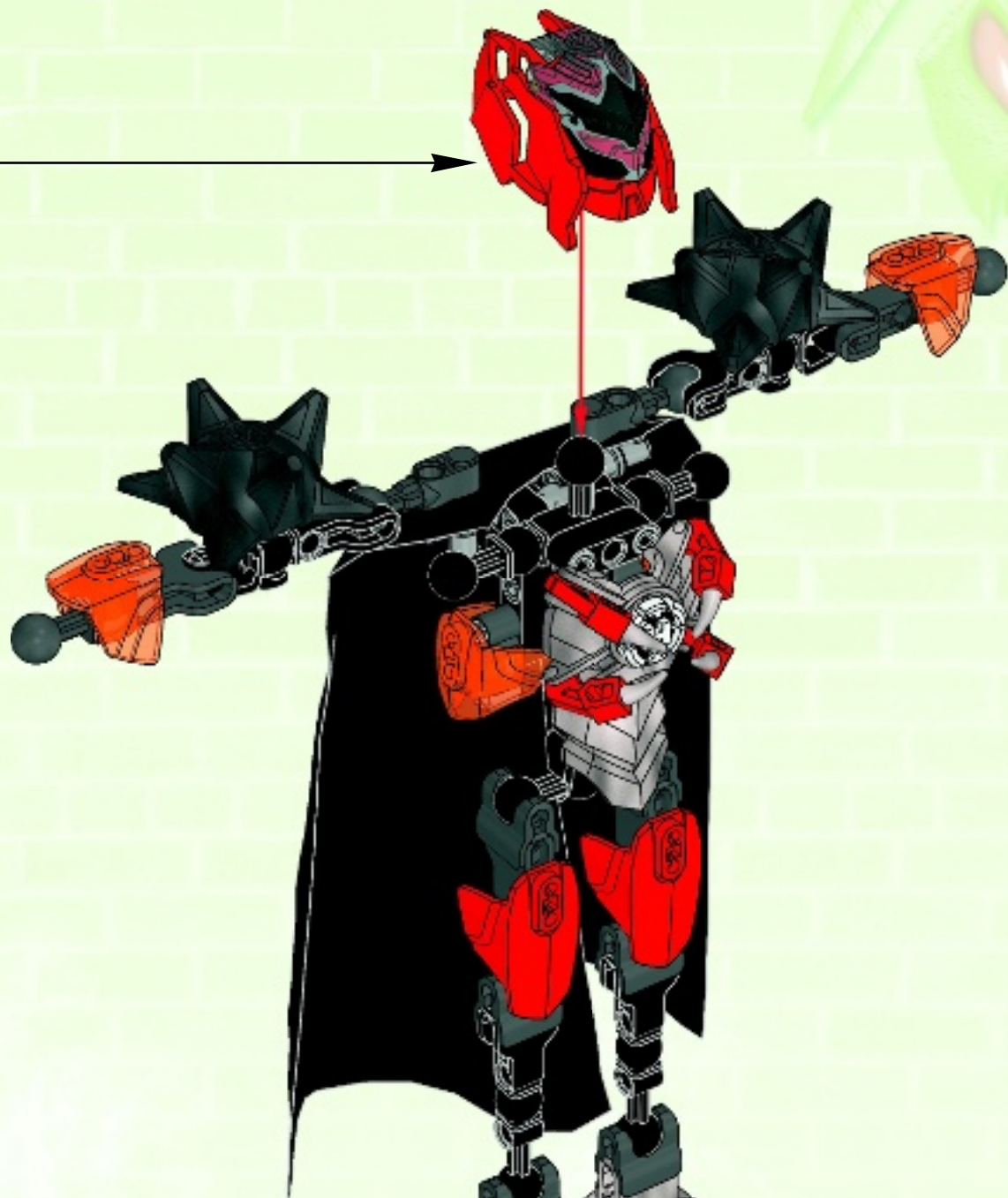

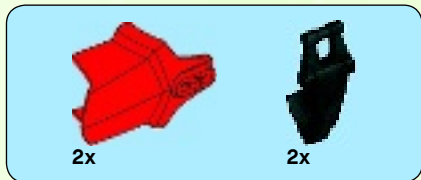

15

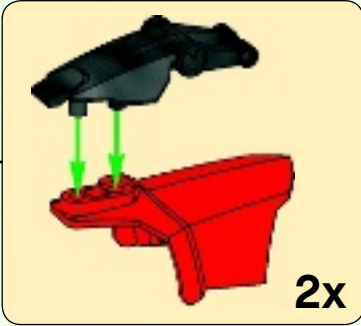
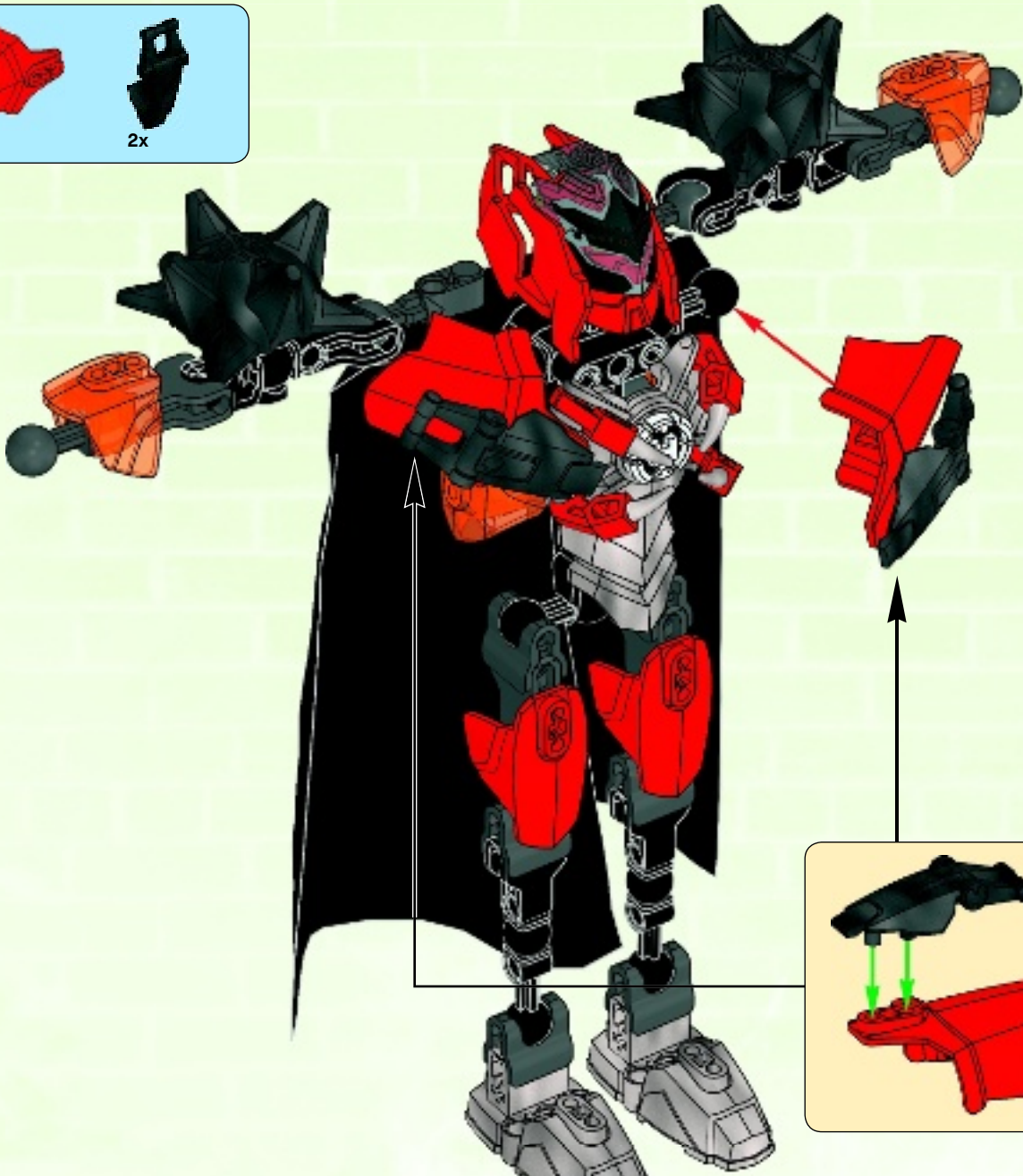





1

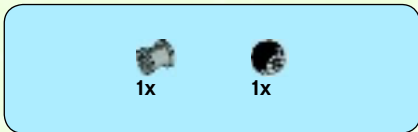

2



3



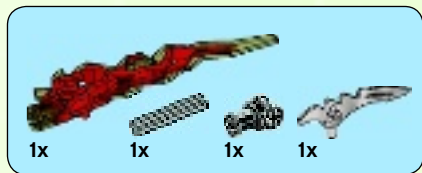

4

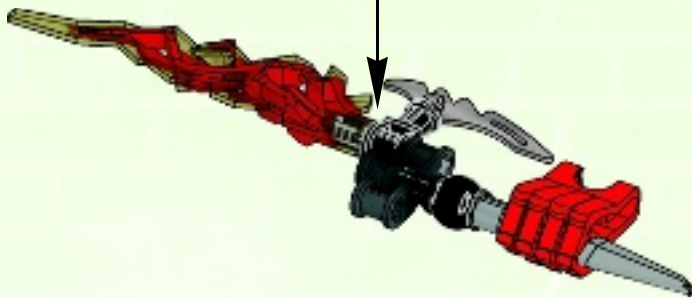
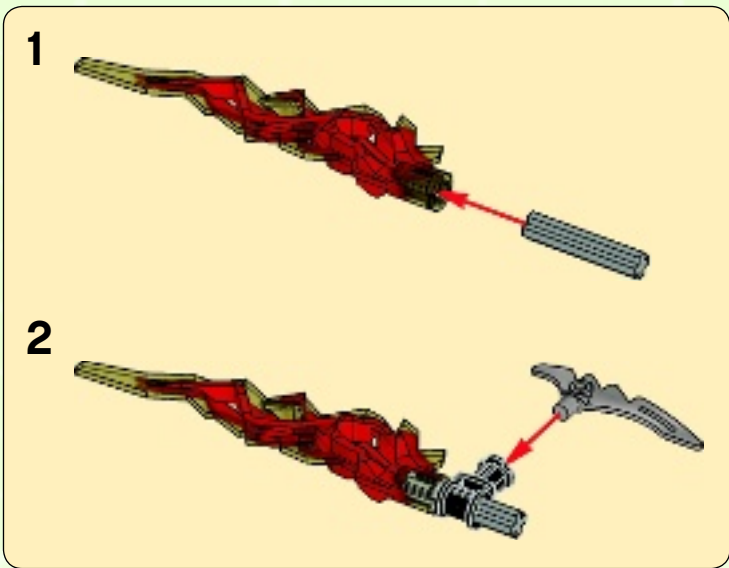

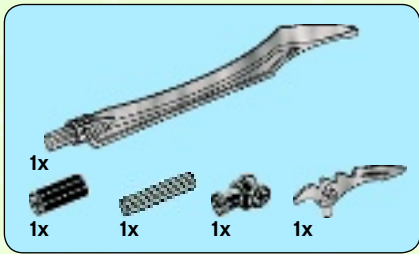

5

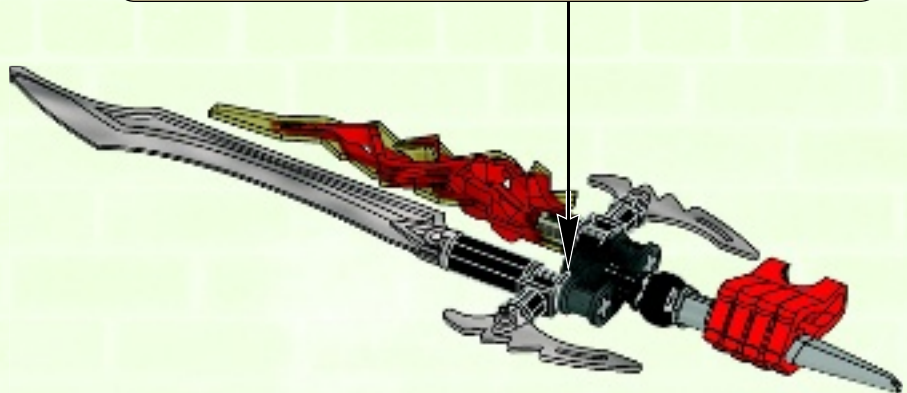
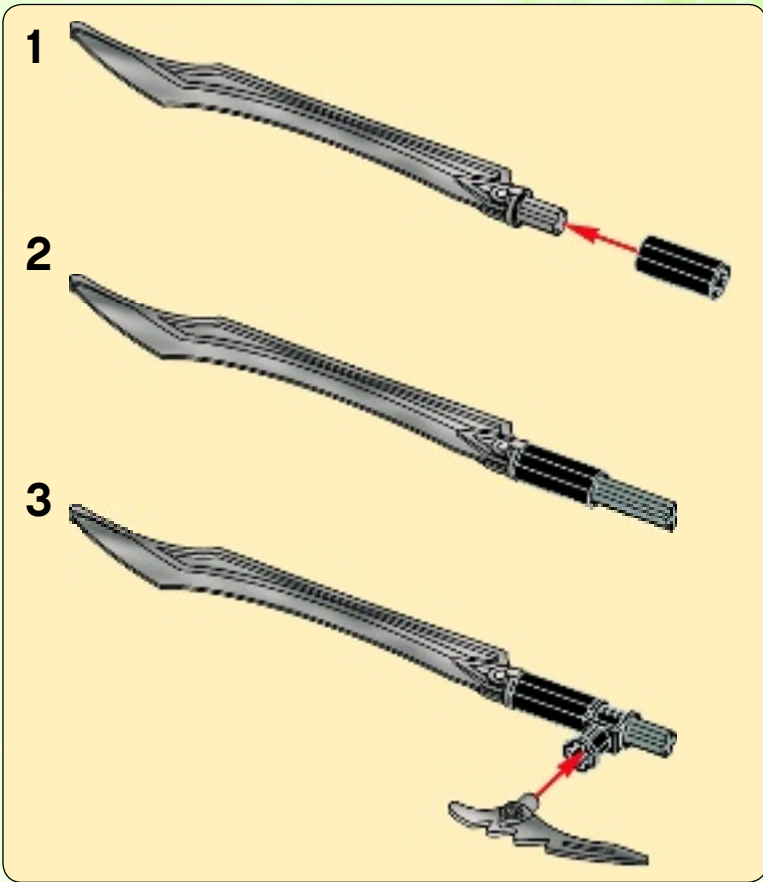

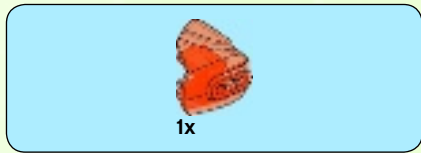

6



16





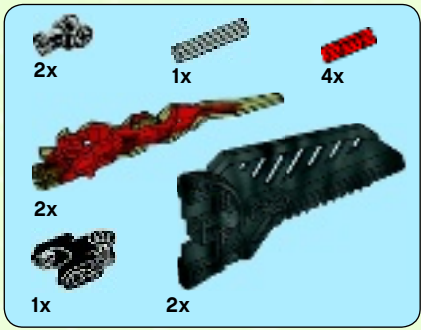

17

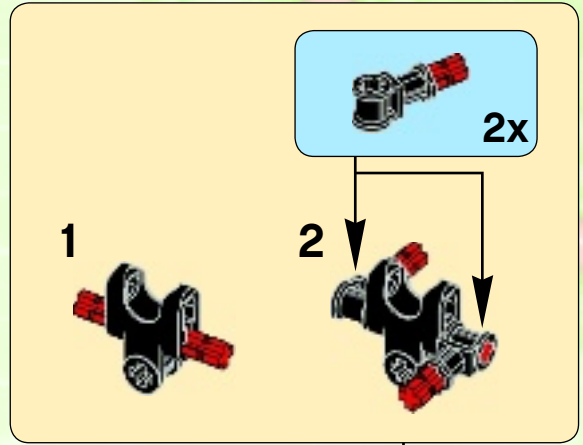

2



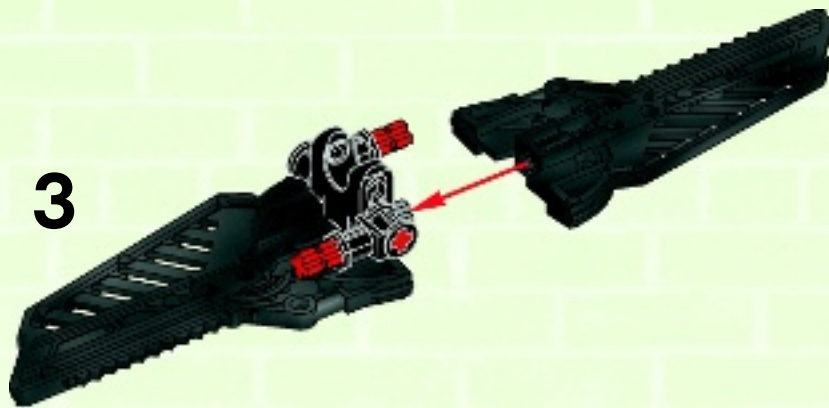







2x

18





8x  
4121715

4x  
4107081

1x  
4512363

1x  
370526

1x  
4142822

2x  
4142823

1x  
4286267

3x  
4610948

2x  
4593562

2x  
4593553

1x  
4593569

1x  
6016208

2x  
4632589

2x  
4651535

4x  
4612901

2x  
4632585

1x  
6016238

3x  
6016236

1x  
6028865

4x  
6014030

1x  
4610915

1x  
6016218

2x  
4632636

2x  
4611198

6x  
4142865

1x  
4616840

1x  
4211862

1x  
4225033

3x  
4211622

3x  
4211815

2x  
4211888

2x  
6030824

6x  
4666471

3x  
6001085

4x  
6013996

2x  
4560177

2x  
4514553

1x  
6000982

1x  
6022718

5x  
6014043

1x  
6021060

2x  
6016212

2x  
4623002

2x  
6014026



1x  
6022629

Customer Service  
Kundenservice  
Service Consommateurs  
Servicio Al Consumidor

LEGO.com/service or dial



: 00800 5346 5555

: 1-800-422-5346

The background features a large green dragon head with red eyes and sharp teeth on the left. Scattered around are images of the game being played on a smartphone, a tablet, and a laptop. The central text is in large, bold, red-outlined letters. A red arrow points from the game code on a tablet to a laptop and another tablet, both displaying the same code.

# +1000

GAME POINTS  
POINTS À COLLECTIONNER  
PUNTOS DE JUEGO

Use the code - get 1000 game points  
Utilise le code - obtiens 1000 points bonus  
Consigue 1000 puntos para el juego en la web con este código

A LEGO Herofactory game box is shown in the bottom left corner, featuring the dragon head and the text 'Blood Attack'.

[LEGO.com/herofactory](http://LEGO.com/herofactory)

Available on the  
App Store











44001



44000

[LEGO.com/herofactory/bi](http://LEGO.com/herofactory/bi)

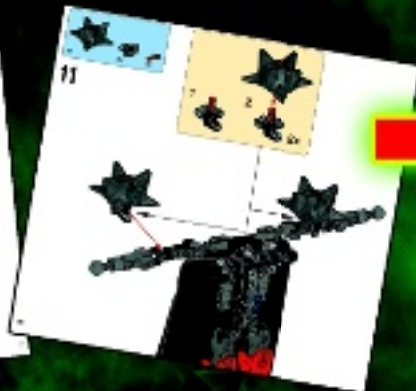







44005



44003





44007



44001



Available on the  
**App Store**





1



2



3

[www.LEGOclub.com/Max](http://www.LEGOclub.com/Max)

[www.LEGOclub.com/Max](http://www.LEGOclub.com/Max)



**club**™

**FREE\*! GRATIS! GRATUIT!**

\*Paid subscription in Australia and New Zealand.  
\*Abonnement payant en Australie et Nouvelle-Zélande.

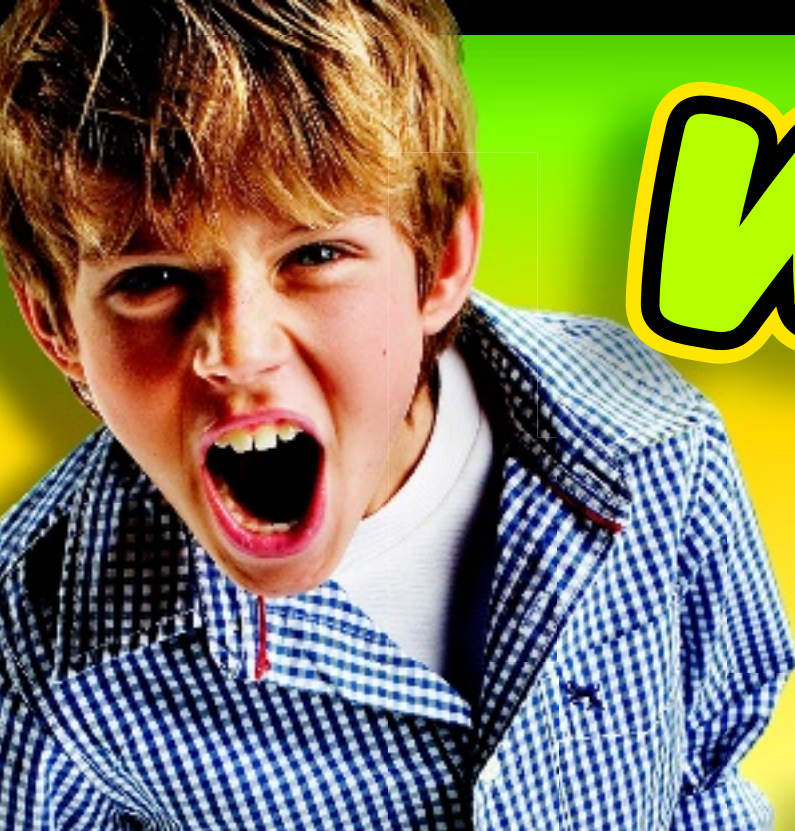

# WIN!

Go to [www.LEGOsurvey.com/product](http://www.LEGOsurvey.com/product)  
to fill out a survey for a chance  
to win a cool LEGO® Product.  
No purchase necessary.  
Open to all residents where not prohibited.



LEGO.com



## [www.LEGOsurvey.com/product](http://www.LEGOsurvey.com/product)

### GEWINNE! WIN!

Nimm an der Umfrage auf  
[www.LEGOsurvey.com/product](http://www.LEGOsurvey.com/product)  
teil und hab die Chance ein cooles  
LEGO® Produkt zu gewinnen!

Die Teilnahme am Gewinnspiel führt zu keinerlei  
Kaufverpflichtungen. Teilnahme in allen nicht  
ausgeschlossenen Ländern möglich.

Ga naar [www.LEGOsurvey.com/product](http://www.LEGOsurvey.com/product),  
vul een  
enquêteformulier in en maak  
kans op een cool LEGO® product.  
Geen aankoopverplichting.  
Iedereen mag deelnemen, uitgezonderd  
ingezetenden van landen waar een  
enquêteverbod geldt.

### GAGNE! 当てよう!

Visite [www.LEGOsurvey.com/product](http://www.LEGOsurvey.com/product)  
pour répondre à un  
questionnaire et avoir une chance de  
gagner un produit LEGO® très cool!  
Aucune obligation d'achat.  
Ouvert à tous les résidents des pays  
autorisés.

[www.LEGOsurvey.com/product](http://www.LEGOsurvey.com/product) にアクセスして、  
アンケートにご記入ください。当選者にはレゴ®  
製品を差し上げます。

お買い上げの必要はありません

禁止されていない限り、すべての皆様にご利用いただけます。