



Friends



3186



Andrea



Mia



Stephanie



Friends



Olivia



Emma

1

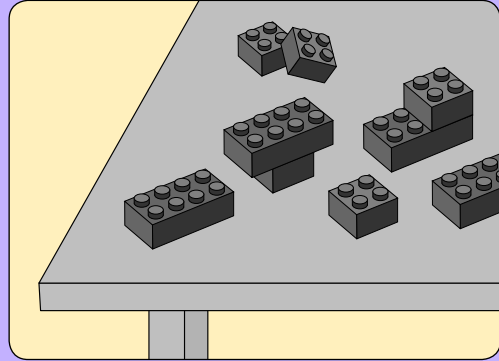
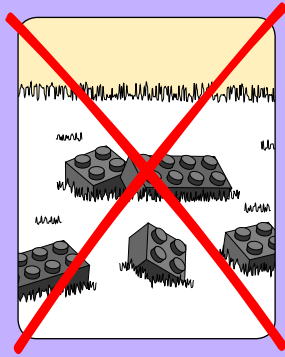

2



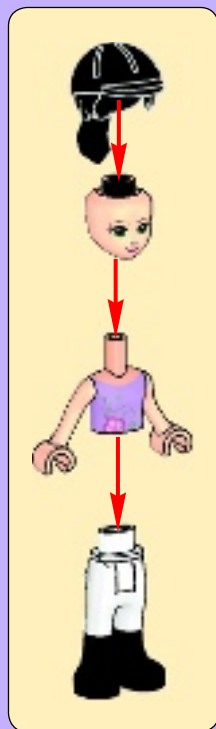
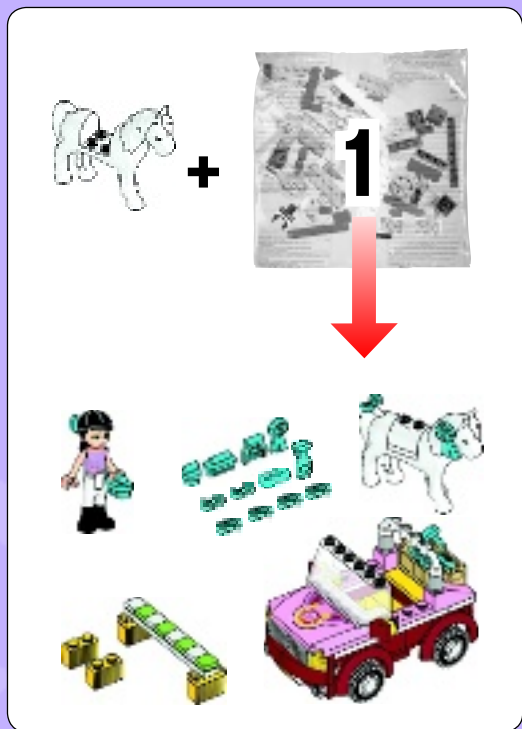



1x



1x

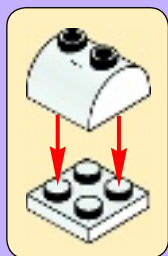

1



2



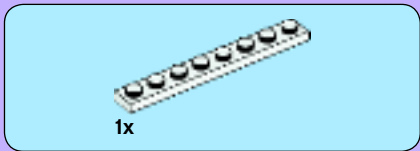
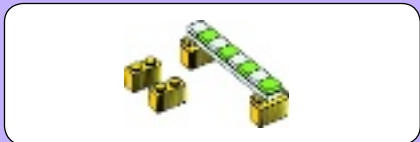

1



2

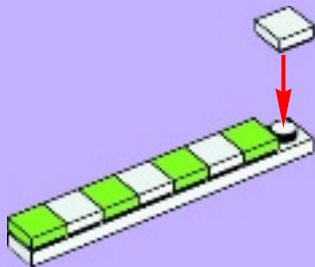



2x



2x

3

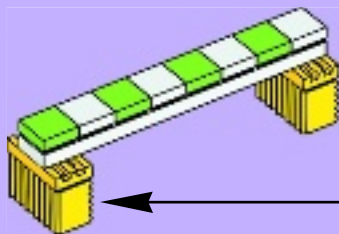
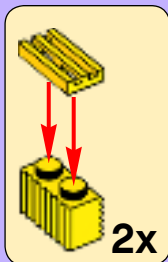

2x

4



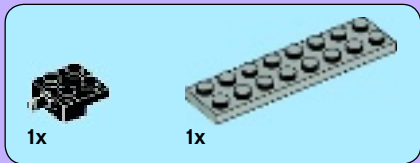

1

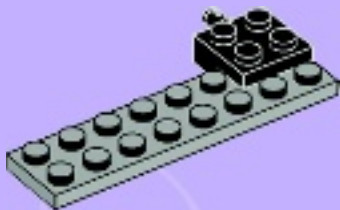

2





2x

3



1x



1x

4

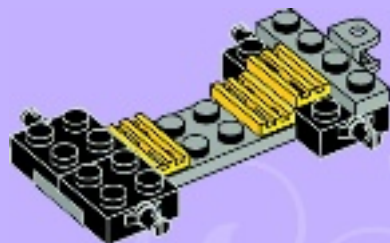



5



6

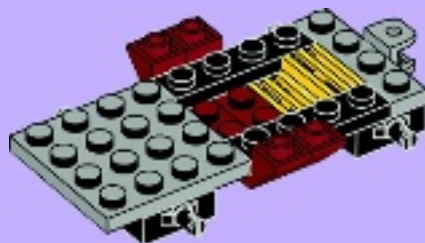

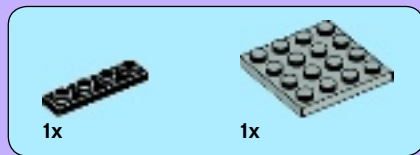

7

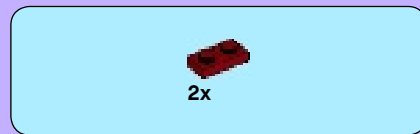

8

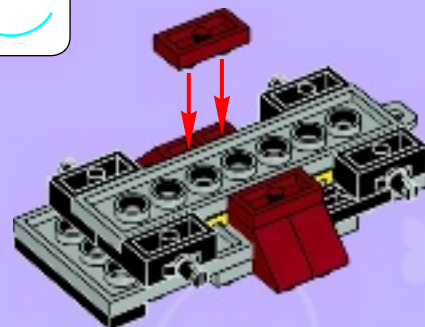
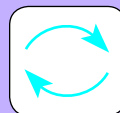



2x



1x

9

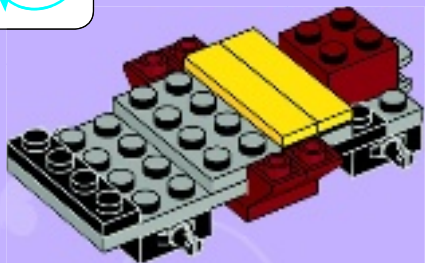
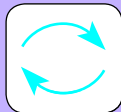

2x

10

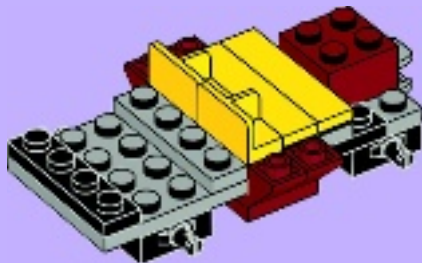

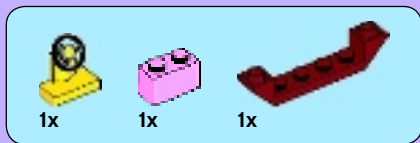

11

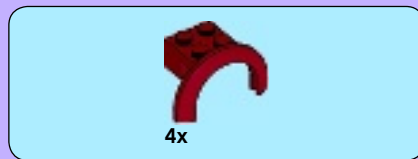
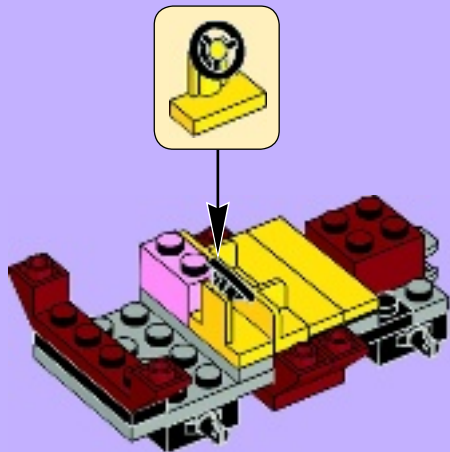

12



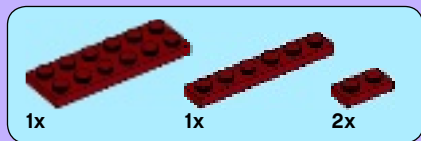

13

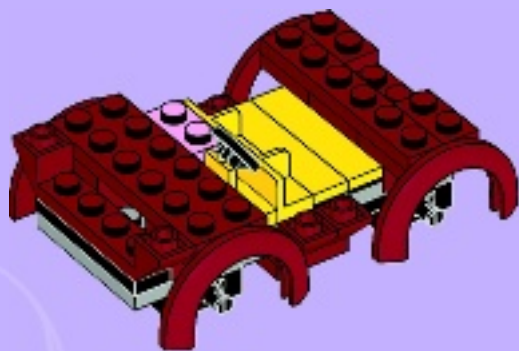



4x

14

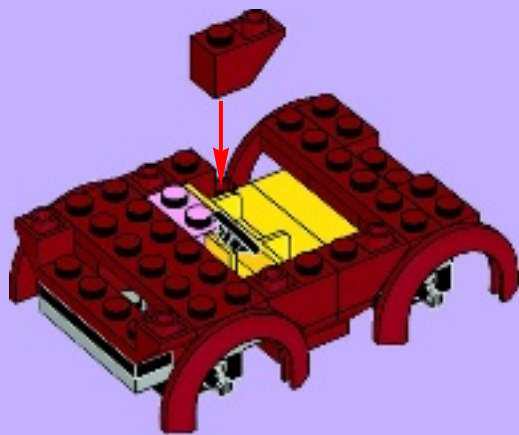



1x



1x

15

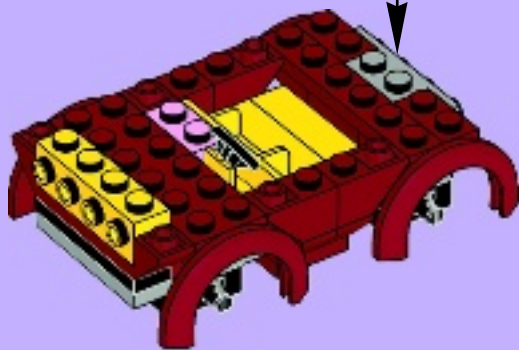
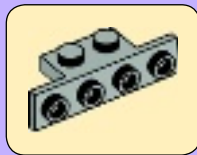

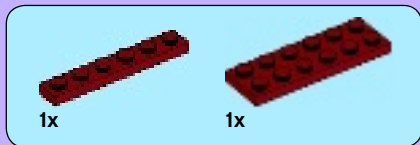

1

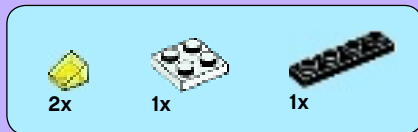
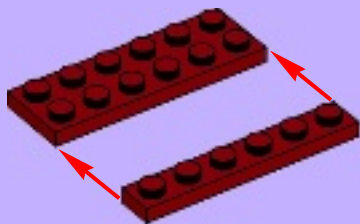

2





2x



2x

3

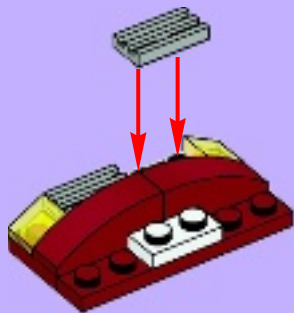

2x



2x



1x

4



5

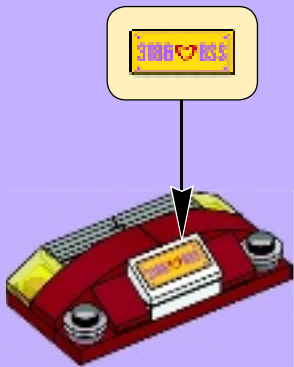

16

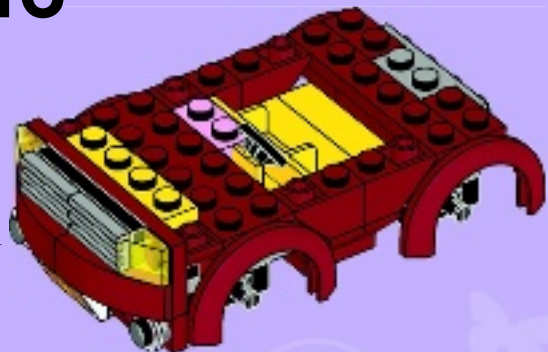

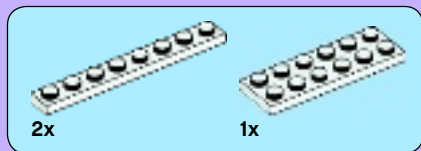

17

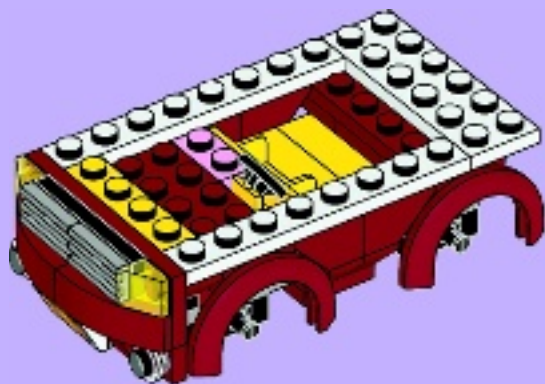



1x



1x

18



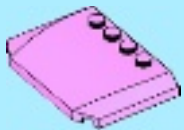

1x

19

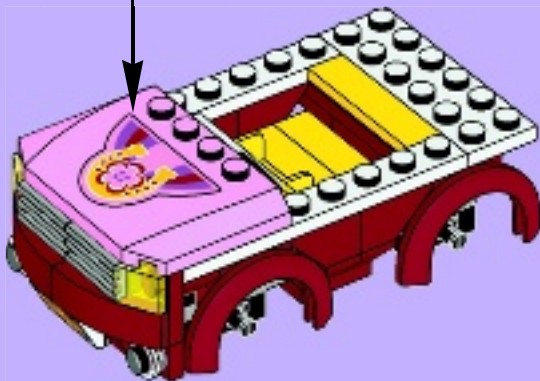



2x



2x

20

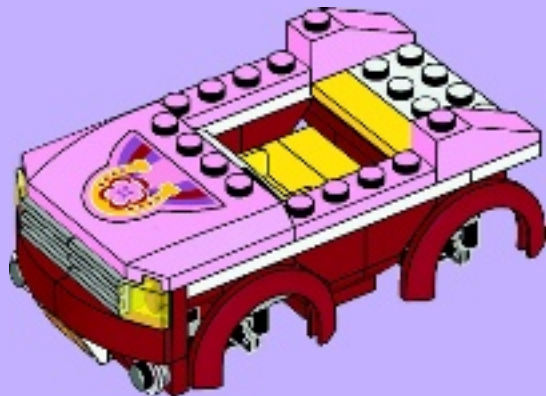

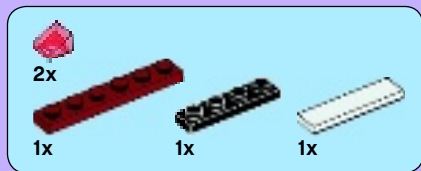

21

1



2



3



4

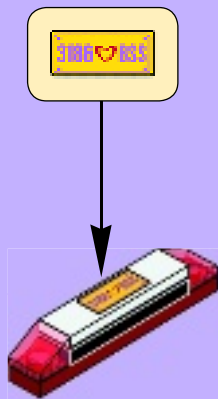



2x



2x

22

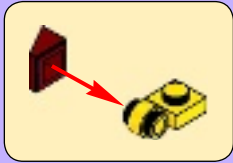



2x



1x

23





24

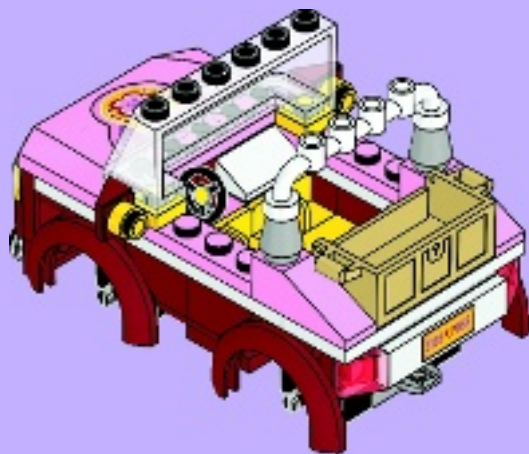



4x



4x

25

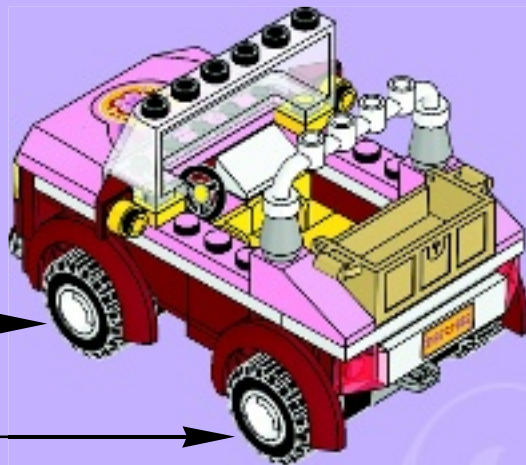
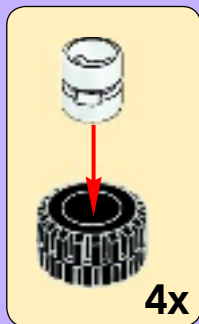

26



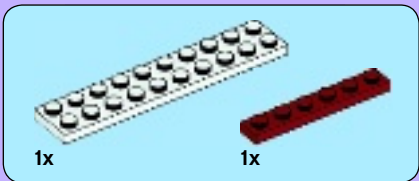

1





1x

2

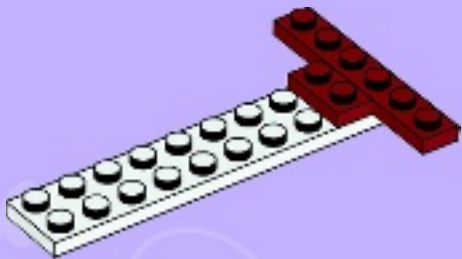

2x

3

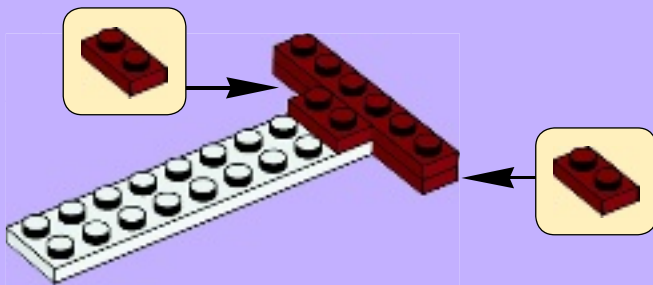



2x

4

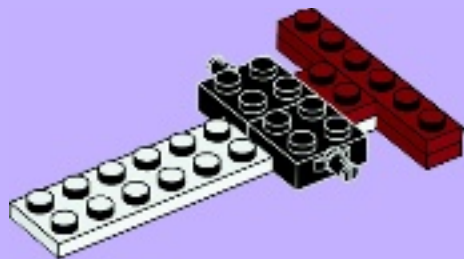

2x



2x

5





2x

6



2x



2x

7





8

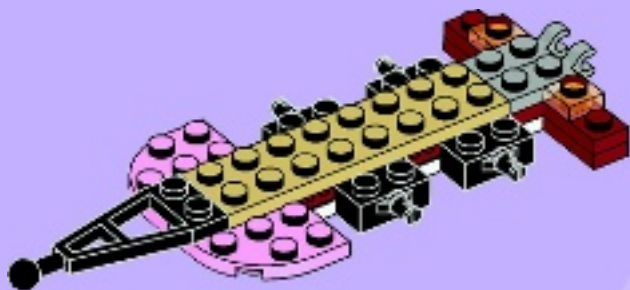



1x



1x

9

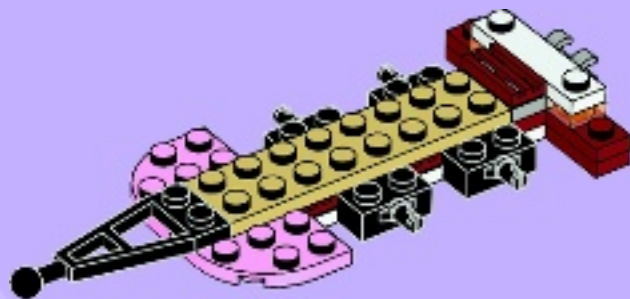

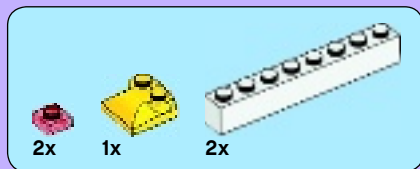

10

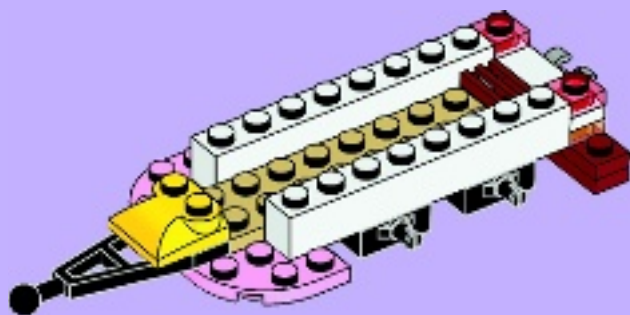



4x



2x

11

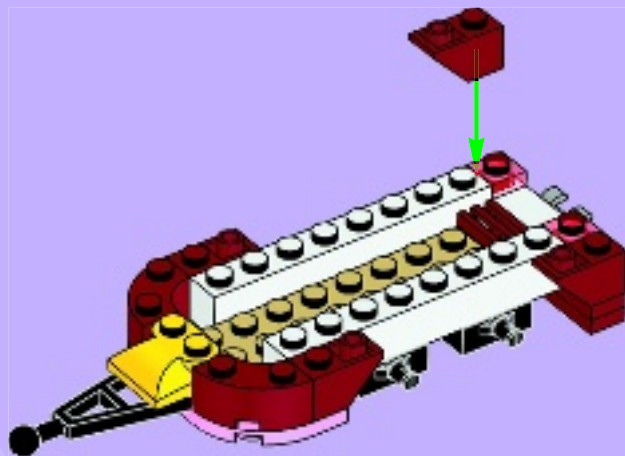

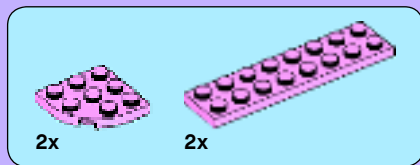

12

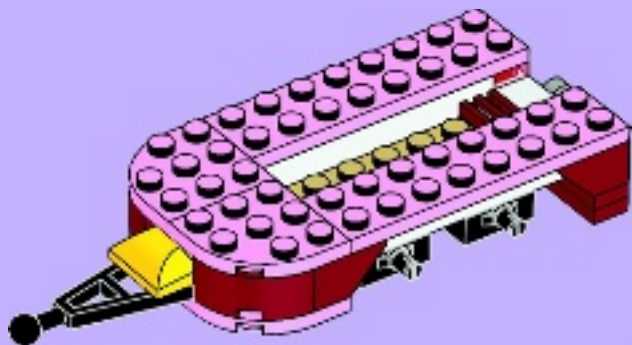

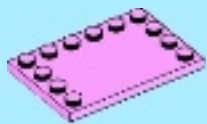

1x

1

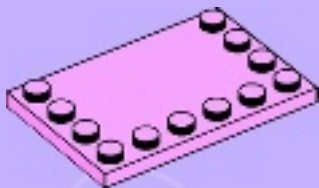

4x



2x

2

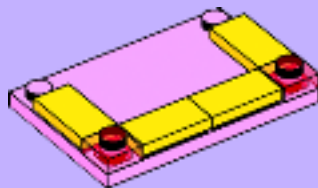



2x

3

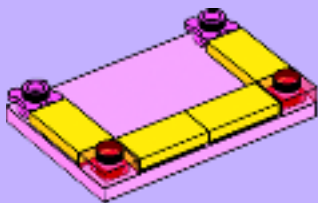

2x

4

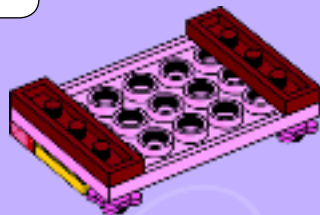
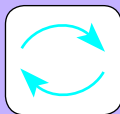

5

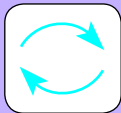

6

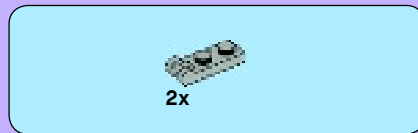

13

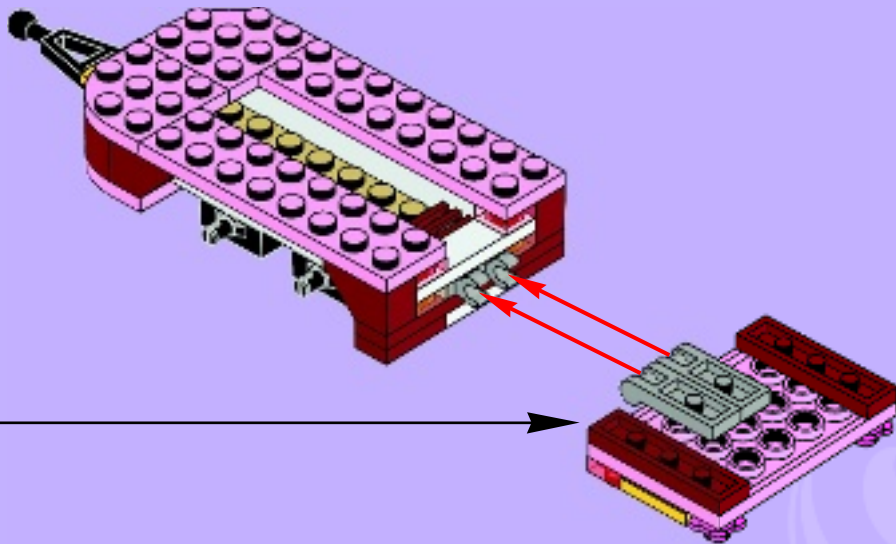

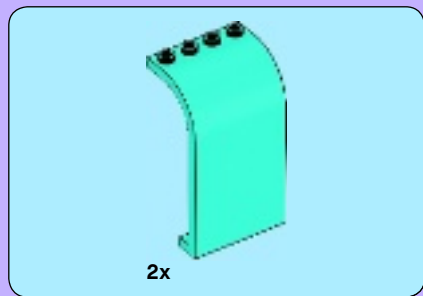

14

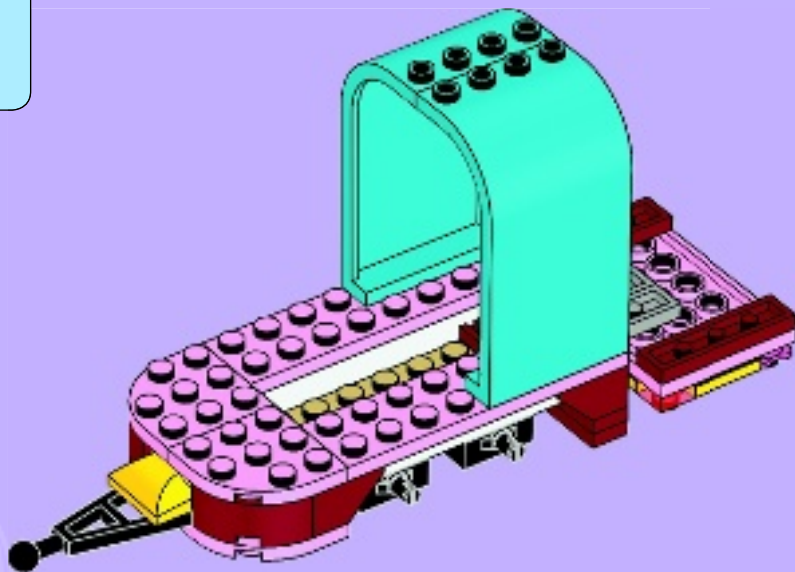

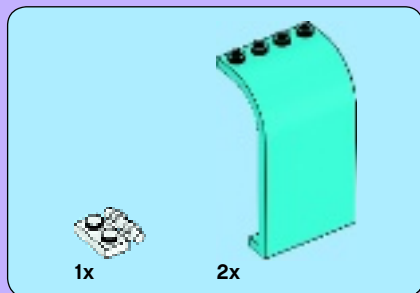

15

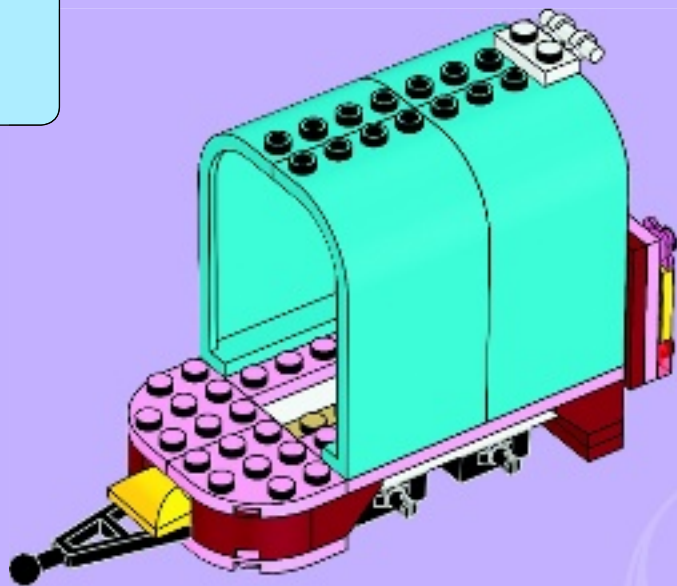

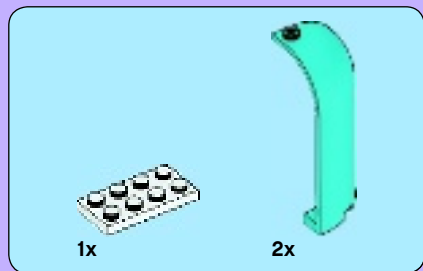

16

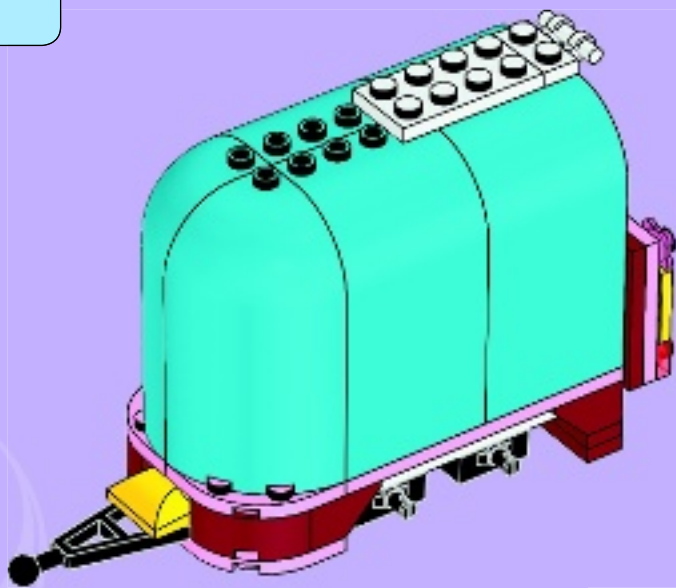

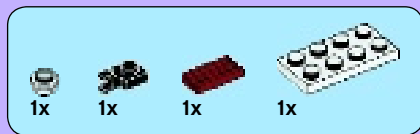

17

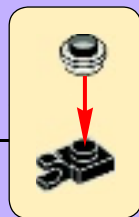
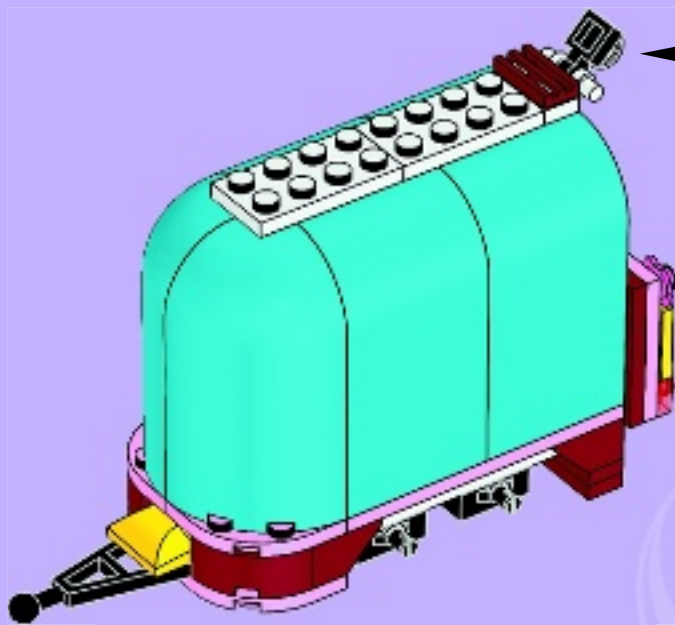

18

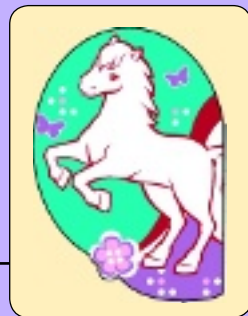
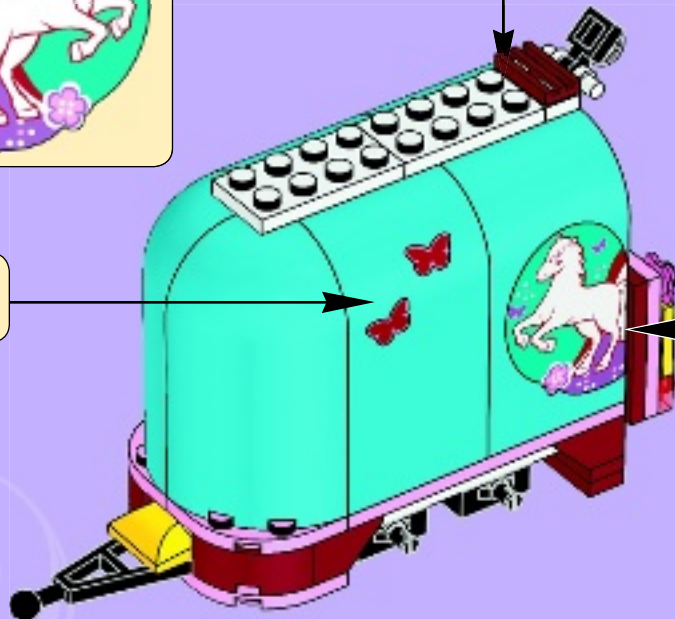

19

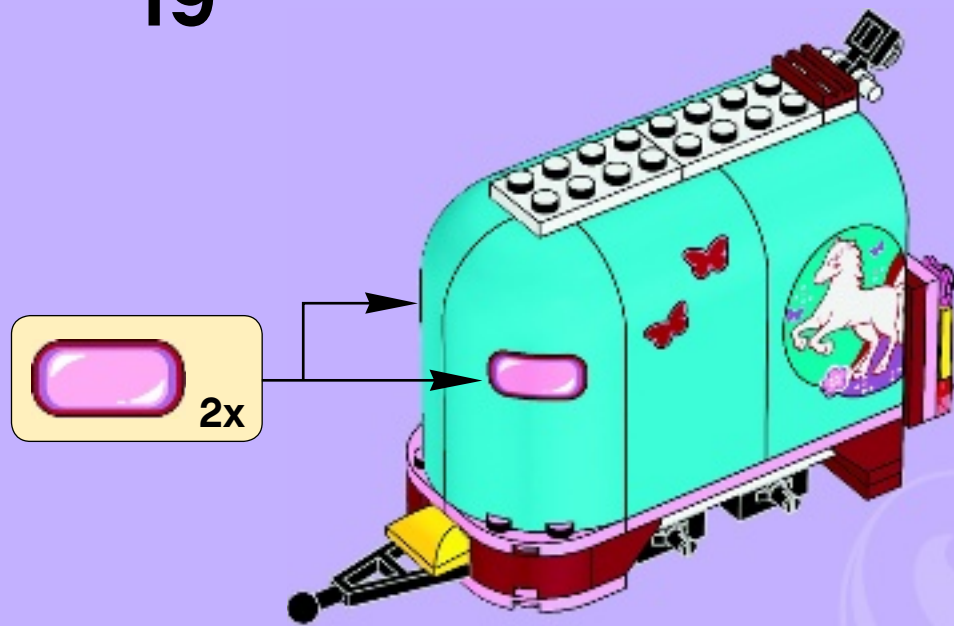

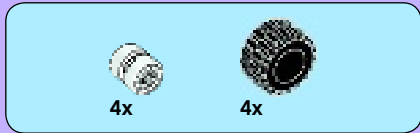

20

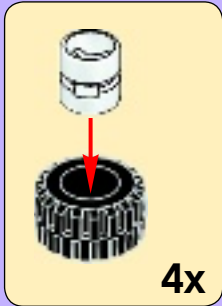
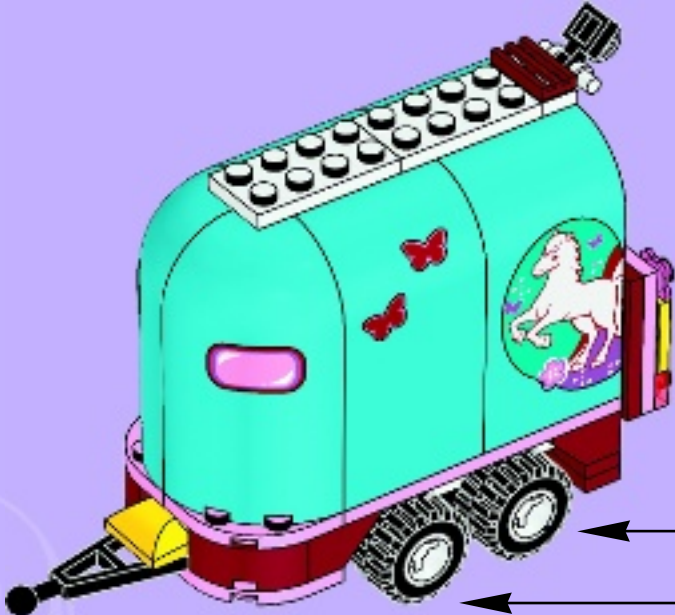

21

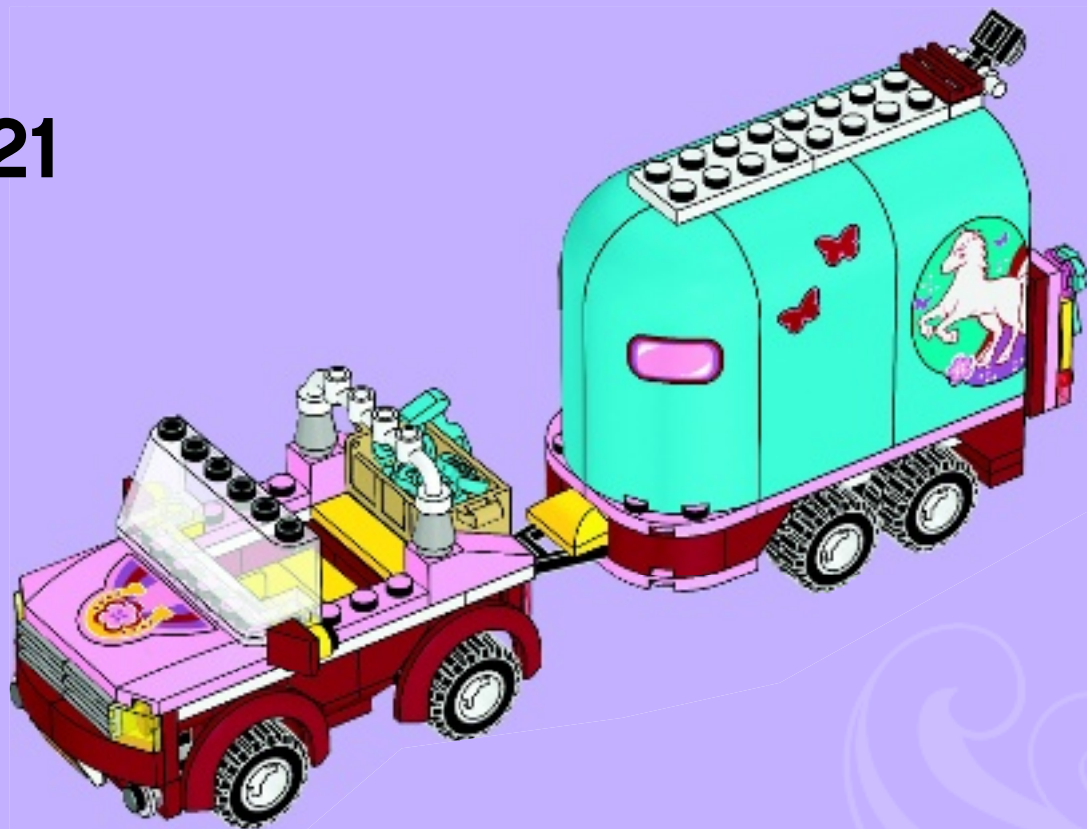

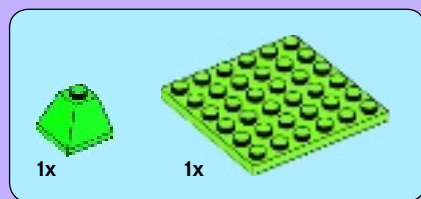

1

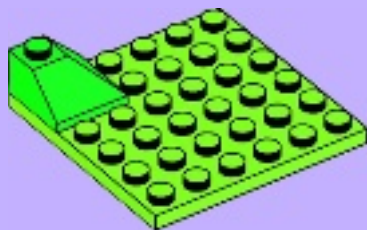

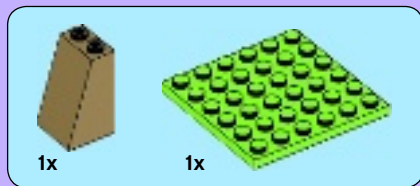

2

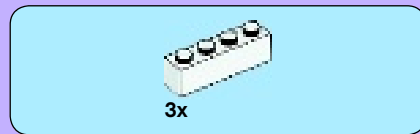
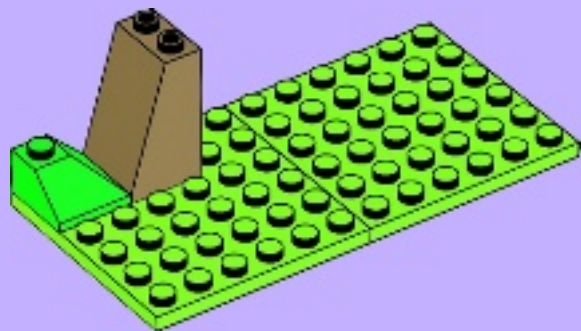

3

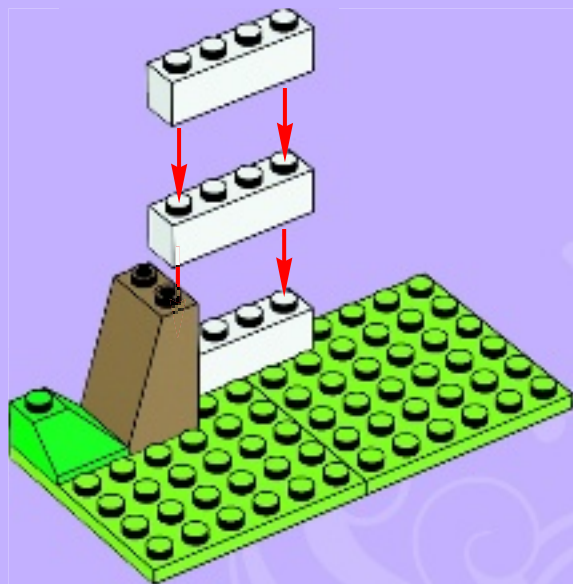



1x

4



2x



1x

5

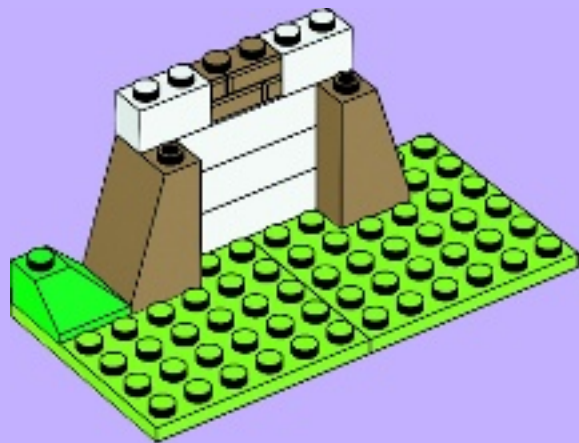

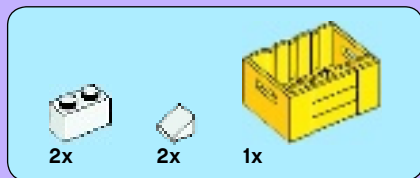

6

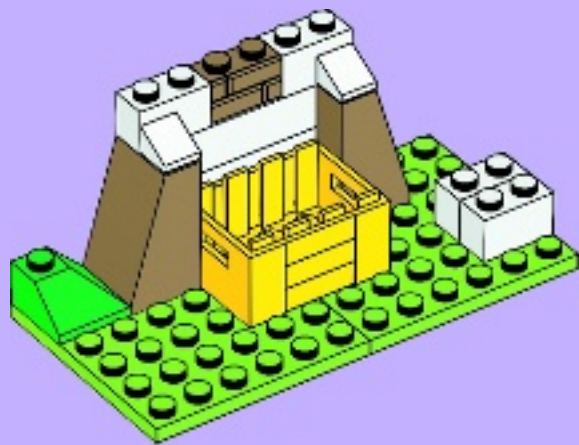

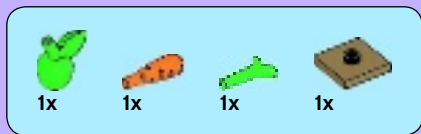

7

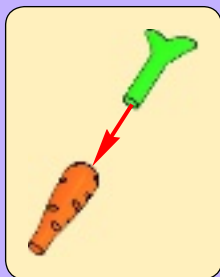



1x



2x



1x

8

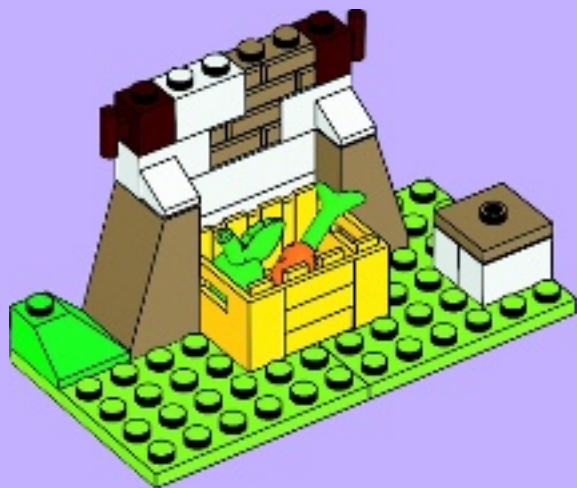



1x



1x

9

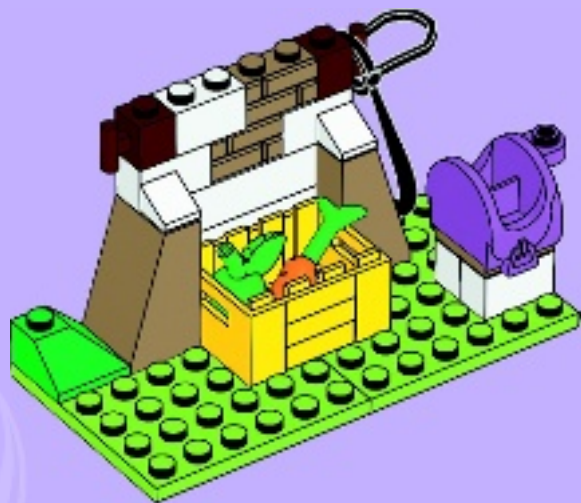



1x



1x

10

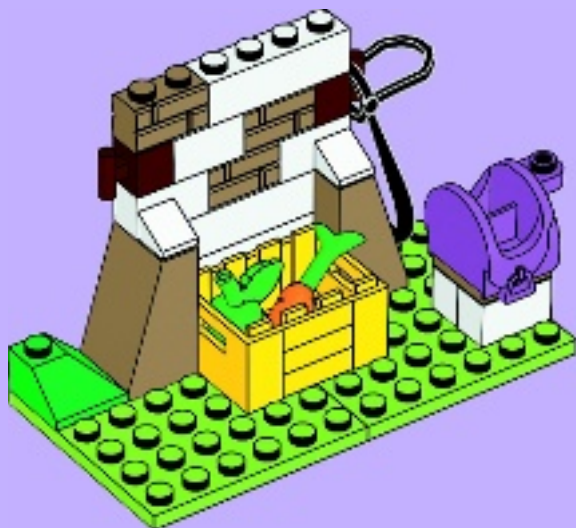

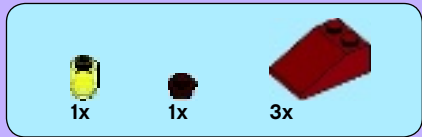

11

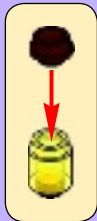



12

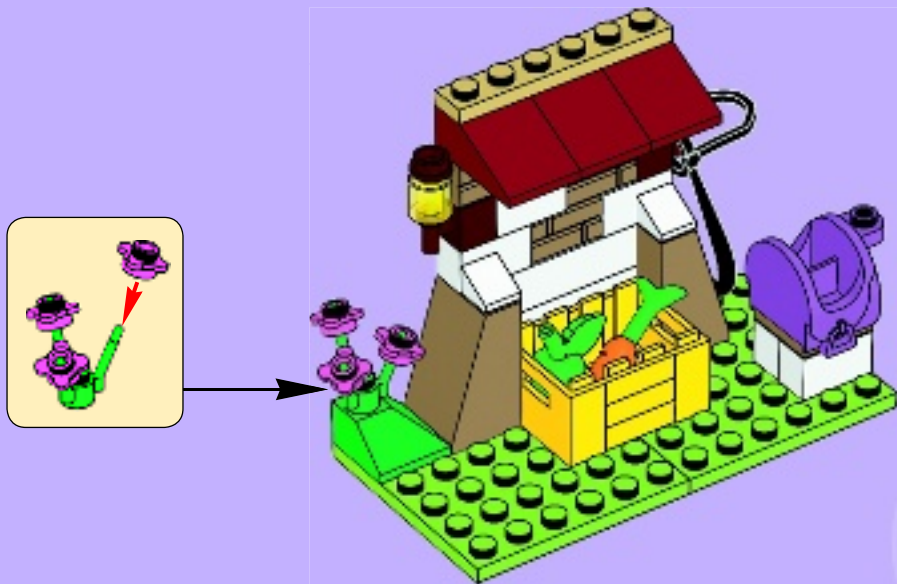

1



2



















































3

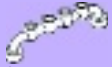

4





 5x 300401	 1x 379501	 1x 4623219	 2x 4632569	 1x 4517925	 3x 3005740	 3x 4646577
 4x 301001	 3x 346001		 5x 241224	 1x 4274405	 1x 4502193	 1x 4578032
 2x 300801	 1x 383201	 8x 4170457	 4x 306924	 1x 6014568	 2x 4244363	 2x 6000852
 2x 4504369	 4x 307001	 1x 4622821	 3x 243124	 1x 4599734	 4x 3000841	 4x 4537251
 2x 4547489	 1x 4140583	 1x 4624989	 2x 4621603	 8x 4568644	 1x 4119478	 2x 4525858
 2x 302201	 1x 243101	 4x 287724	 1x 4599378	 8x 448826	 1x 4514396	 1x 3006844
 1x 4597131	 1x 4288961	 1x 4164073	 1x 9553	 5x 371026	 1x 374128	 2x 4260942



1x
4539104



2x
4625551



4x
4531415



8x
4590811



3x
4569379



4x
4541506



3x
4618657



2x
4541546



7x
4539097



2x
4539061



4x
4539062



2x
4618986



4x
4621617



2x
4542673



5x
4216479



2x
4225823



1x
4216581



2x
4529241



2x
4243797



1x
4211406



2x
4211350



2x
4535738



2x
4515369



1x
6014615



1x
4667166



1x
4517993



2x
4621620



2x
6002148

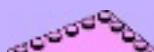

1x
4625545



2x
4625550



4x
4620318



1x
4618656



1x
6011444



1x
4612388



1x
4119479



1x
4107050



1x
4124067



1x
4113988



1x
4618652



1x
6002630



2x
4625546



4x
4625548



1x
4625440



Customer Service

Kundenservice

Service Consommateurs

Servicio Al Consumidor

www.lego.com/service or dial



00800 5346 5555 :



1-800-422-5346 :



Heartlake City



LEGO Friends



3934



3187



3183



3936



3935



3942



3186



3063



3065



3061



3184



3932



3937



3938



3939



3933



3183



3189



3315



3185



Friends



LEGOFriends.com

1



2



3



www.LEGOclub.com/Nina

www.LEGOclub.com/Nina



clubTM

FREE*! GRATIS! GRATUIT!



*Paid subscription in Australia and New Zealand.
*Abonnement payant en Australie et Nouvelle-Zélande.



Win!

Go to www.LEGOsurvey.com/product to fill out a survey for a chance to win a cool LEGO® Product.
No purchase necessary.
Open to all residents where not prohibited.



www.LEGOsurvey.com/product

Gewinne! Win!

Nimm an der Umfrage auf www.LEGOsurvey.com/product teil und hab die Chance ein cooles LEGO® Produkt zu gewinnen!

Die Teilnahme am Gewinnspiel führt zu keinerlei Kaufverpflichtungen. Teilnahme in allen nicht ausgeschlossenen Ländern möglich.

LEGO and the LEGO logo are trademarks of the/son des marques de commerce de/son marcas registradas de LEGO Group. ©2012 The LEGO Group.

Ga naar www.LEGOsurvey.com/product, vul een enquêteformulier in en maak kans op een cool LEGO® product.

Geen aankoopverplichting. Iedereen mag deelnemen, uitgezonderd ingezetenden van landen waar een enquêteverbod geldt.

Gagne! 当てよう!

Visite www.LEGOsurvey.com/product pour répondre à un questionnaire et avoir une chance de gagner un produit LEGO® très cool!

Aucune obligation d'achat. Ouvert à tous les résidents des pays autorisés.

www.LEGOsurvey.com/product にアクセスして、アンケートにご記入ください。当選者にはレゴ® 製品を差し上げます。

お買い上げの必要はありません。

禁止されていない限り、すべての皆様にご利用いただけます。

6014461 / 6014462

