

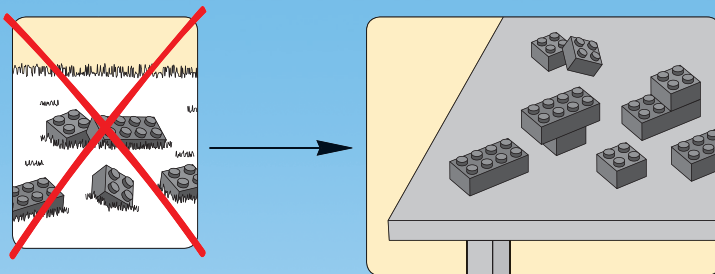

4628



1



2

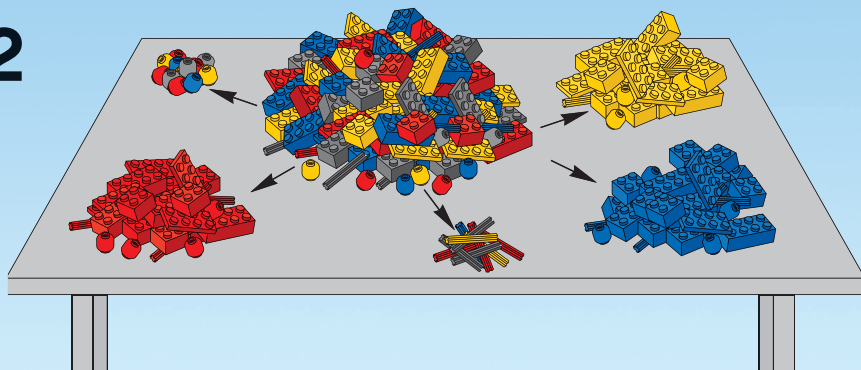

2

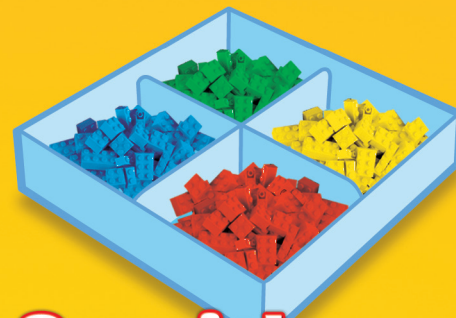

## Special Sorting Lid

Deckel mit toller Sortierfunktion

Couvercle de tri spécial

Tapa clasificadora especial

Tampa classificadora especial

Különleges osztályozó fedél



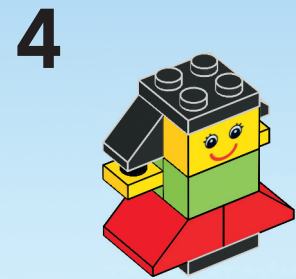
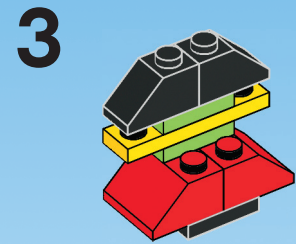
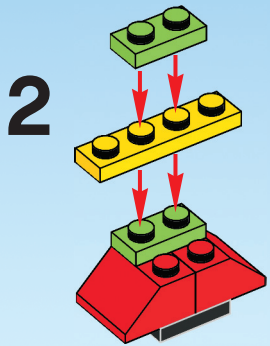
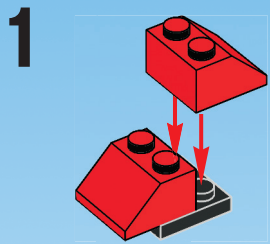

1

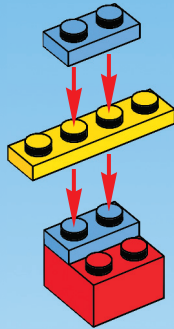

2

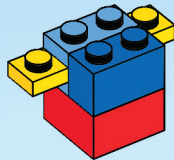

3

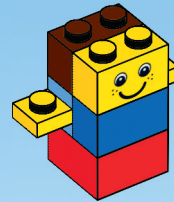

4

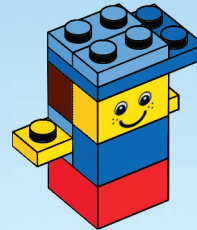



1

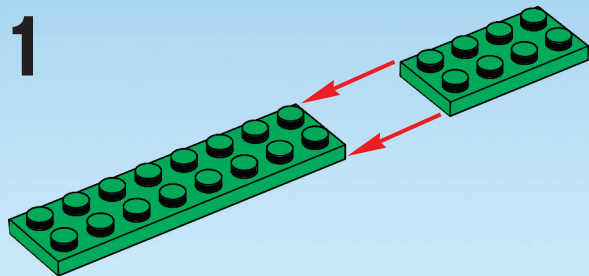

2

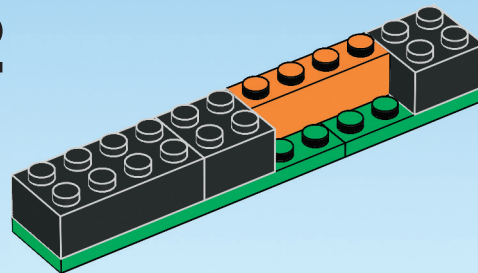

3

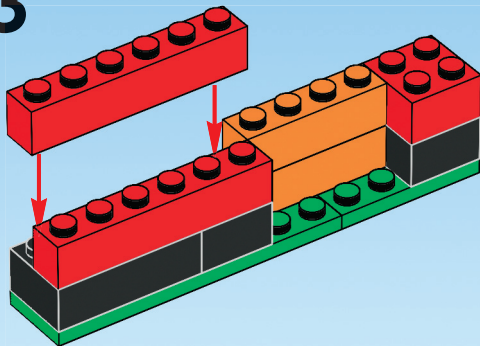

4

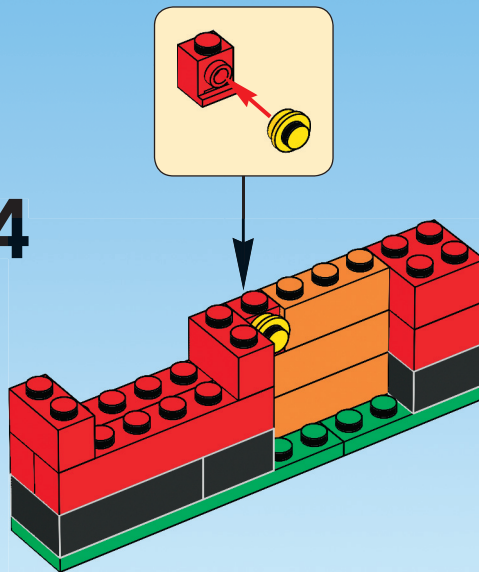



5

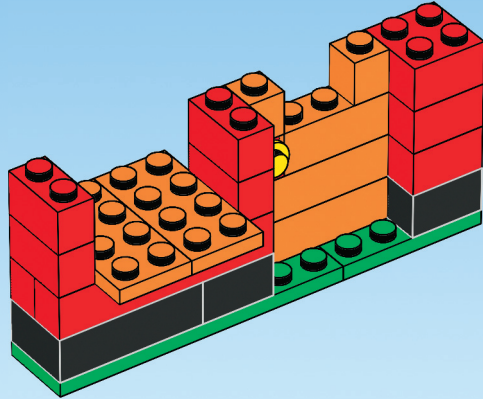

6

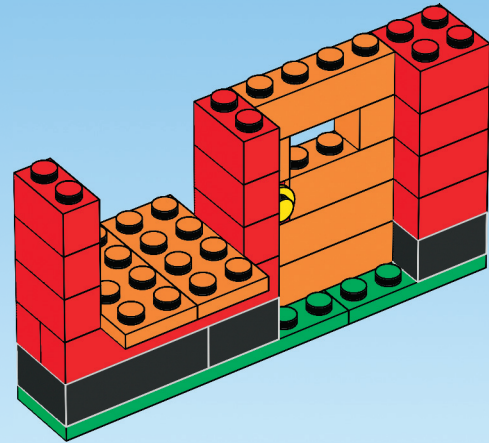

7

7

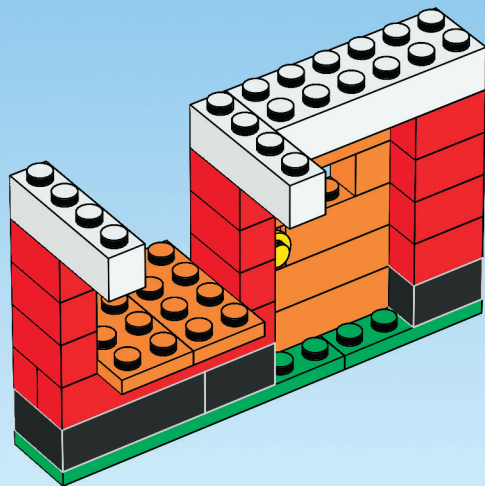

8

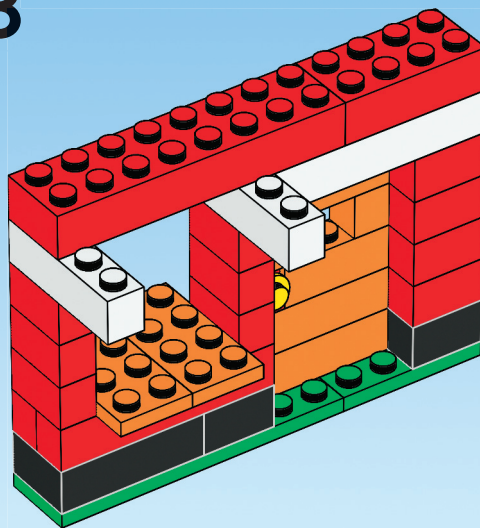

8

9

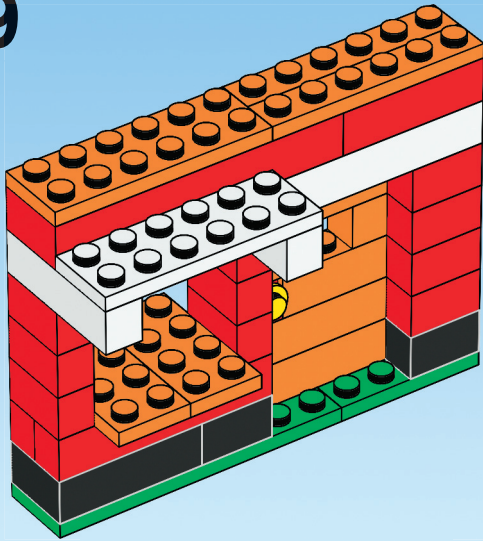

10

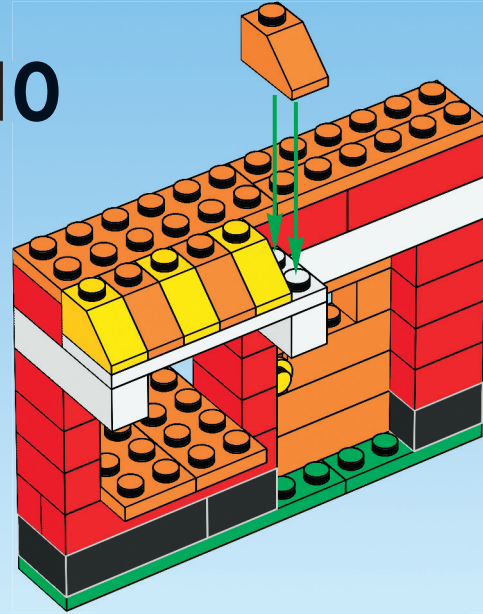

11

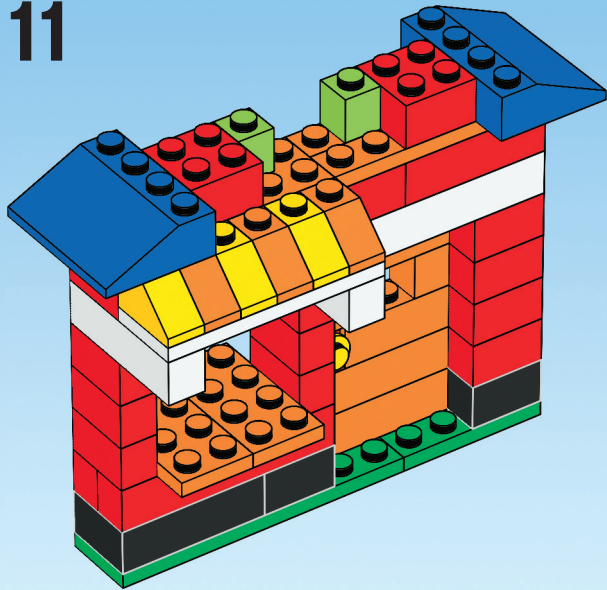

12

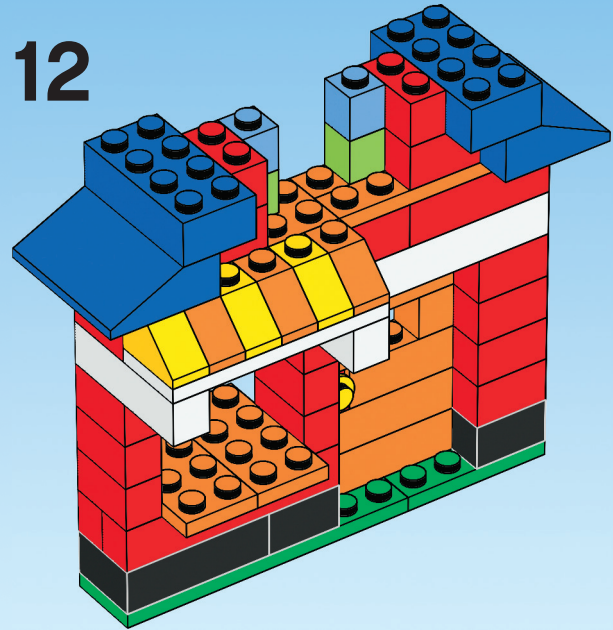

10



13

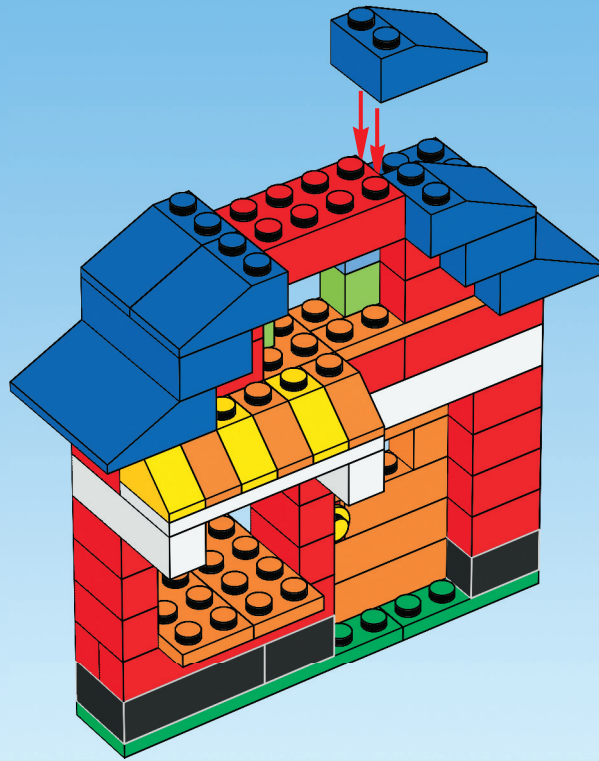

1

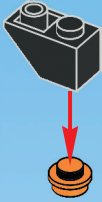

2



3

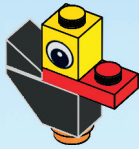

14

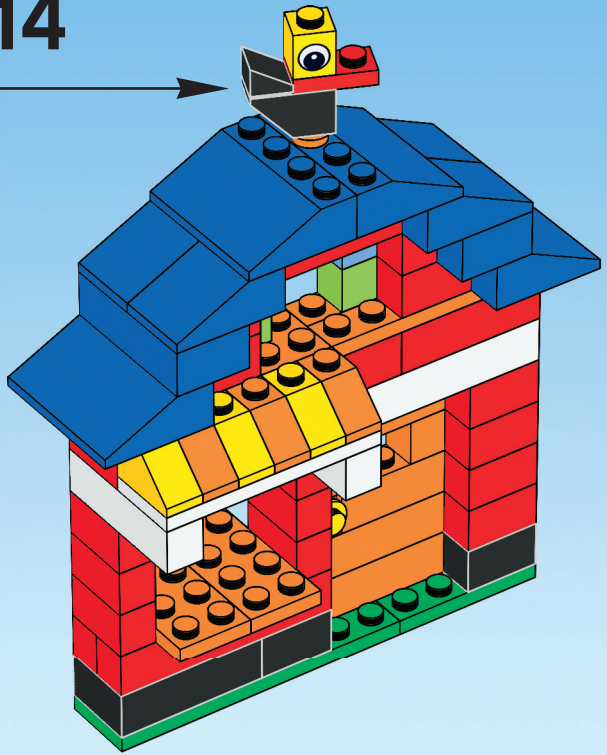

15

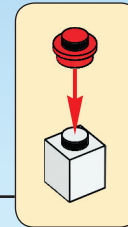
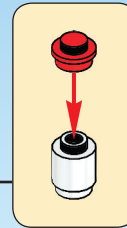
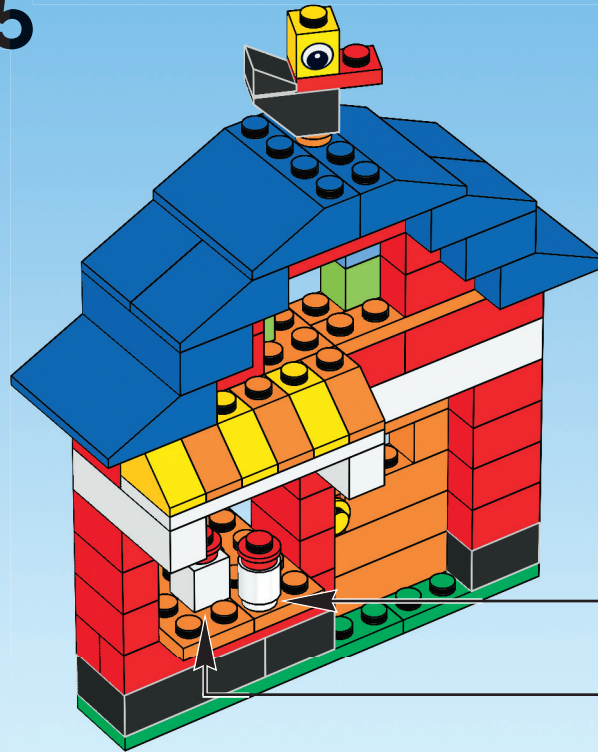

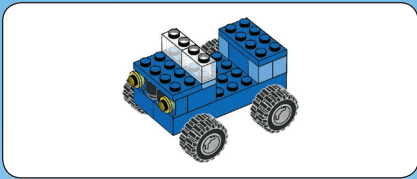

1

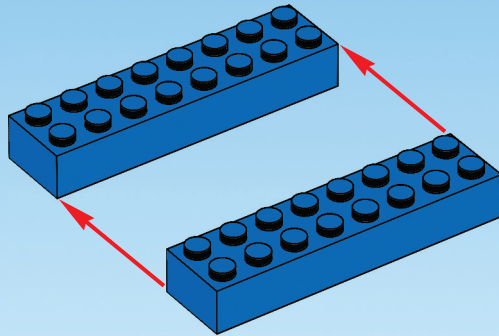



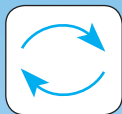

**2**

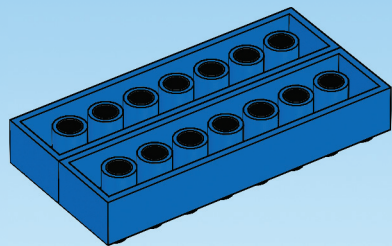

**3**

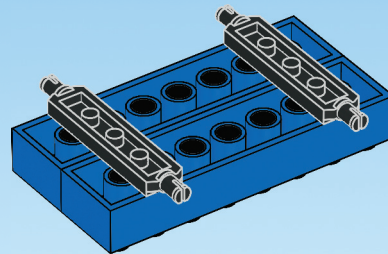



4

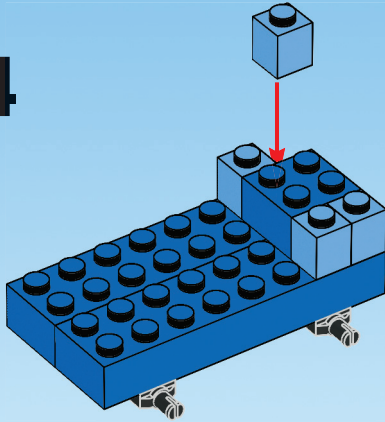

5

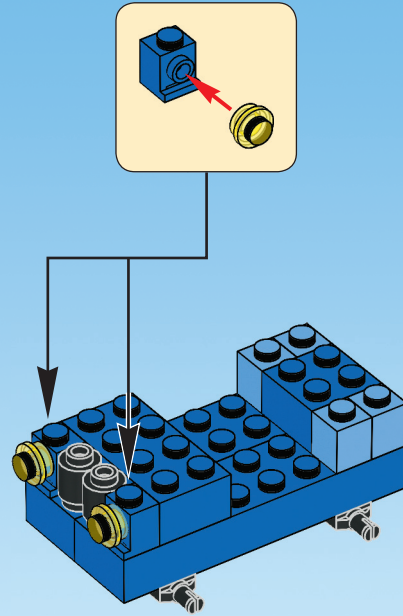

6

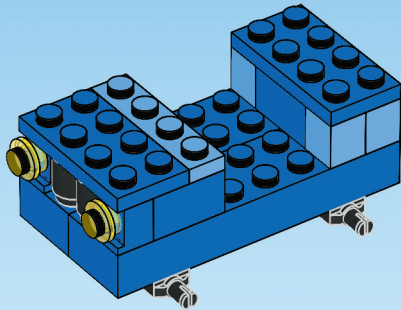

7

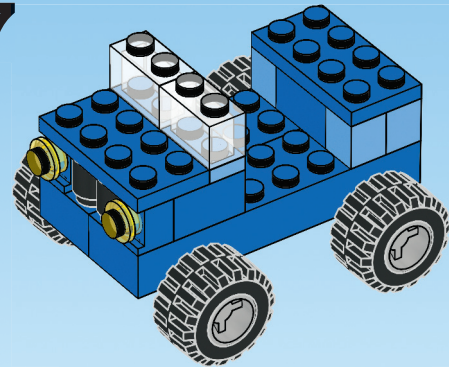







**LEGO** CITY



5+

**EASY BUILD  
INSTANT PLAY**



EINFACH ZU BAUEN – SOFORTIGER SPIELSPASS  
CONSTRUCTION FACILE – JEU IMMEDIAT  
FÁCIL DE CONSTRUIR – DIVERSIÓN INSTANTÁNEA  
CONSTRUÇÃO FÁCIL – DIVERSÃO IMEDIATA  
KÖNNYEN MEGÉPÍTHETED – AZONNAL JÁTSZHATSZ





4636



4637



4635



4625



4626



6166

1:1



4+



2-5



626



6177



**A unique system of compatible bricks**  
A few bricks are not compatible

**Ein einzigartiges System kompatibler Steine**  
Einige Steine sind nicht kompatibel

**Un système unique de briques compatibles**  
Quelques briques ne sont pas compatibles

**Un sistema único de ladrillos compatibles**  
Algunos ladrillos no son compatibles

**Um sistema único de peças compatíveis**  
Algumas peças não são compatíveis

**Összeépíthető elemek egyedülálló rendszerben**  
Van néhány elem, amely nem mindegyik elemhez illik





2x  
4569080



8x  
300501



12x  
300401



1x  
4181142



28x  
300301



4x  
362201



6x  
300201

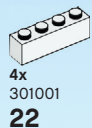

4x  
301001

**22**



8x  
300101

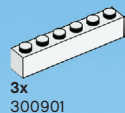

3x  
300901



2x  
4181142

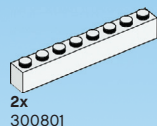

2x  
300801

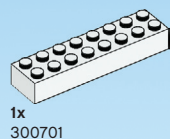

1x  
300701



3x  
306201



2x  
4520970



2x  
302301



1x  
379501



1x  
4611700



4x  
614101



8x  
300521



12x  
300421



28x  
300321



4x  
362221



6x  
300221

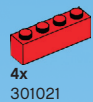

4x  
301021



8x  
300121

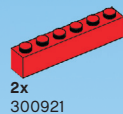

2x  
300921

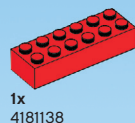

1x  
4181138

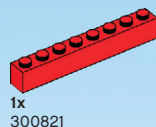

1x  
300821

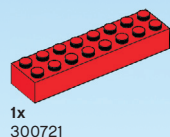

1x  
300721



4x  
407021



4x  
366521



4x  
4121934



4x  
303921



4x  
366021



2x  
609121



4x  
302321



2x  
302221



4x  
242021



1x  
371021



4x  
614121



8x  
300523



12x  
300423



28x  
300323



4x  
362223



6x  
300223



4x  
301023



8x  
300123

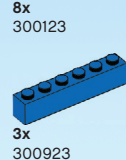

3x  
300923

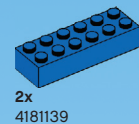

2x  
4181139

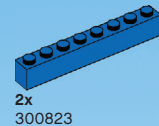

2x  
300823

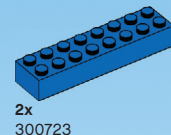

2x  
300723



2x  
407023



2x  
366523



4x  
4121936



2x  
4509443



4x  
329823



4x  
329723



4x  
302323



1x  
302123



2x  
371023



2x  
302023



4x  
614123



8x  
300524



2x  
4569076



12x  
300424



4x  
4211764



1x  
4570442



1x  
4569078



28x  
300324



4x  
362224



6x  
300224



4x  
301024



8x  
300124



2x  
300924



4x  
614124



1x  
4181143

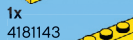

1x  
300824



1x  
4639693



2x  
4201615



3x  
4121965



2x  
371024



2x  
3005741

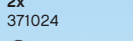

4x  
4183133

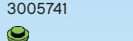

4x  
300526

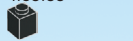

6x  
300426



12x  
300326



2x  
362226



3x  
300226



4x  
301026



4x  
300126



6x  
306226



4x  
4504382



2x  
4121966



2x  
366526



2x  
302226



1x  
302026



4x  
4568644



2x  
292626



4x  
300528



6x  
4107736



12x  
300328



2x  
4109679



3x  
4109674



4x  
4112838



4x  
4106356



4x  
4142989



4x  
4121969



2x  
302028



2x  
303428



2x  
306540



2x  
3005744



6x  
4179830



4x  
4179825



2x  
4179828



4x  
4173805



4x  
4153825



1x  
4118787



4x  
4121967



2x  
4158355



4x  
4157103



2x  
4173332



1x  
4121741



3x  
4118827



6x  
4220634



4x  
4164022



2x  
4220632



2x  
4164037



4x  
4211199



4x  
4211242



2x  
4211149



3x  
4211210



2x  
4211225



1x  
4211252



4x  
4211222



4x  
4211221



**Customer Service**  
**Kundenservice**  
**Service Consommateurs**  
**Servicio Al Consumidor**

[www.lego.com/service](http://www.lego.com/service) or dial



: 00800 5346 5555

: 1-800-422-5346





# WIN!

Go to [www.LEGOsurvey.com/product](http://www.LEGOsurvey.com/product)  
to fill out a survey for a chance  
to win a cool LEGO® Product.

No purchase necessary.

Open to all residents where not prohibited.

## [www.LEGOsurvey.com/product](http://www.LEGOsurvey.com/product)

### GEWINNE!

Nimm an der Umfrage auf  
[www.LEGOsurvey.com/product](http://www.LEGOsurvey.com/product)  
teil und hab die Chance ein cooles  
LEGO® Produkt zu gewinnen!  
Die Teilnahme am Gewinnspiel führt zu keinerlei  
Kaufverpflichtungen. Teilnahme in allen nicht  
ausgeschlossenen Ländern möglich.

### WIN!

Ga naar [www.LEGOsurvey.com/product](http://www.LEGOsurvey.com/product),  
vul een enquêteformulier  
in en maak kans op een  
cool LEGO® product.  
Geen aankoopverplichting.  
Iedereen mag deelnemen, uitgezonderd  
ingezetenden van landen waar een  
enquêteverbod geldt.

### GAGNE!

Visite [www.LEGOsurvey.com/product](http://www.LEGOsurvey.com/product)  
pour répondre à un  
questionnaire et avoir une  
chance de gagner un produit  
LEGO® très cool!  
Aucune obligation d'achat.  
Ouvert à tous les résidents des pays  
autorisés.

### 当てよう!

[www.LEGOsurvey.com/product](http://www.LEGOsurvey.com/product)  
にアクセスして、  
アンケートにご記入ください。  
当選者にはレゴ®製品を  
差し上げます。  
お買い上げの必要はありません。  
禁止されていない限り、すべての皆様にご利用いただけます。

 [www.LEGO.com](http://www.LEGO.com)

4668514

LEGO and the LEGO logo are trademarks of the LEGO Group. ©2012 The LEGO Group.