



# ALIEN CONQUEST

7066



1

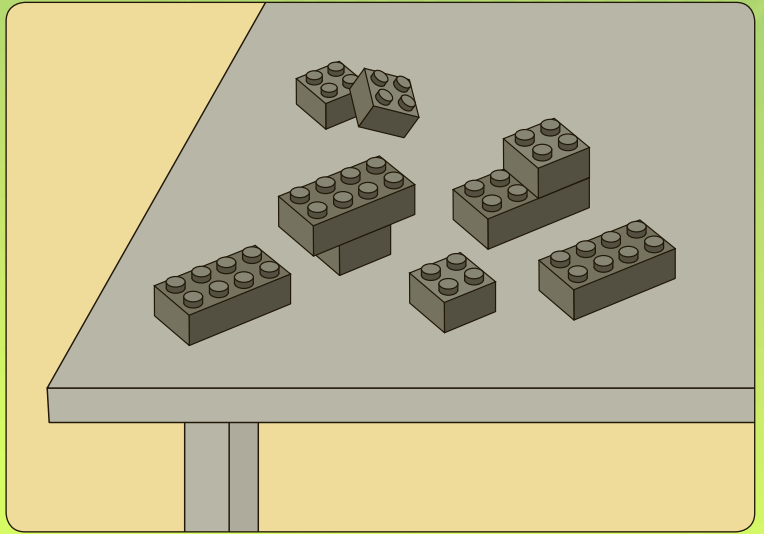
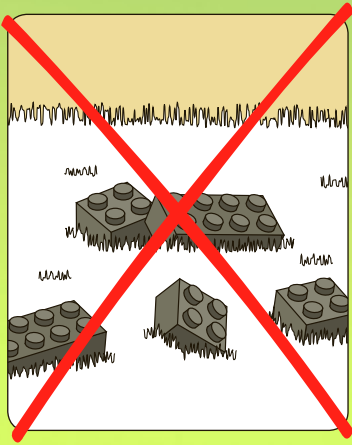

2





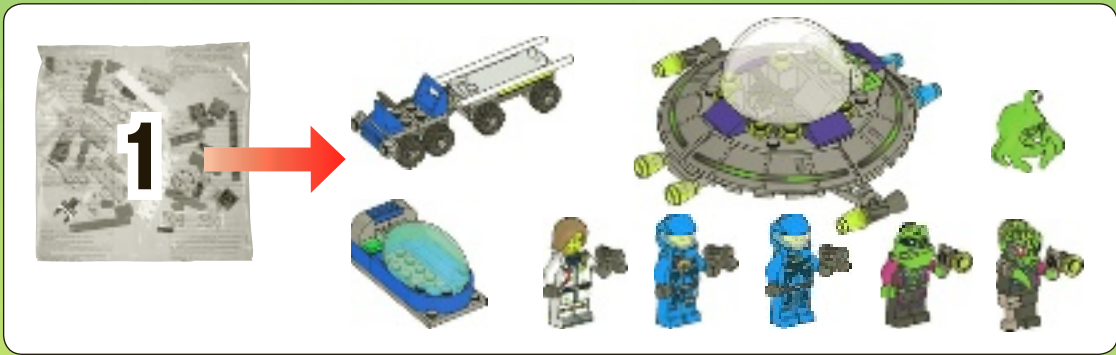

+



=



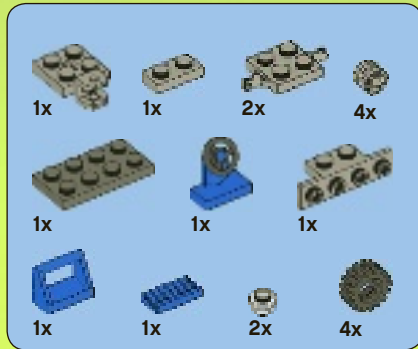

1

1

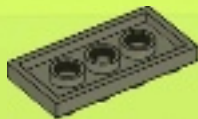

2



3

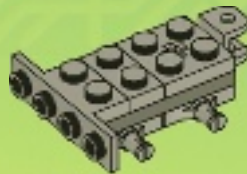

4



5

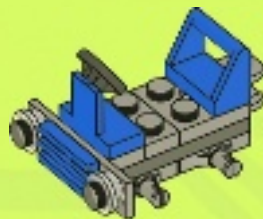

6

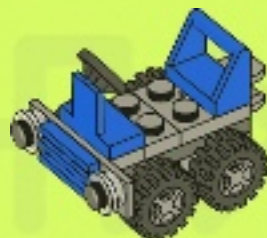



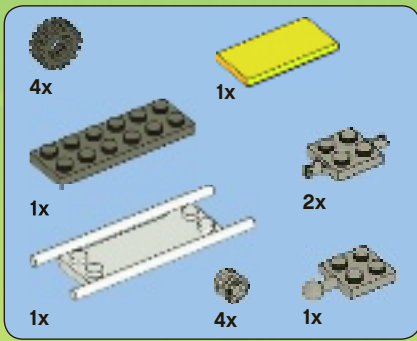

**2**

**1**

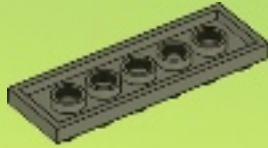

**2**

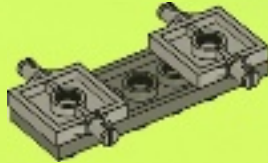

**3**

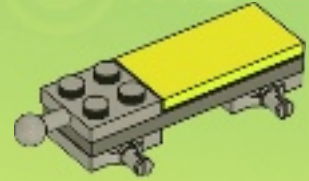

**4**

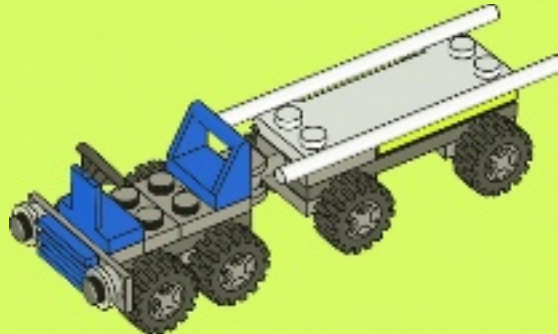
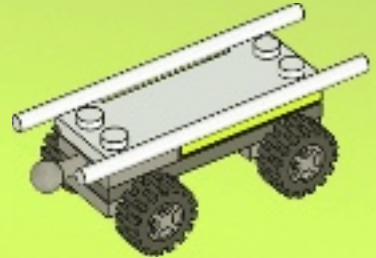

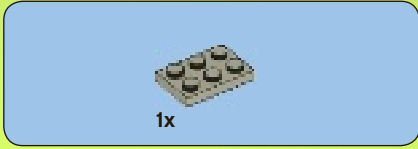

1

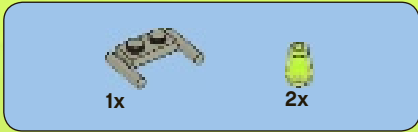

2

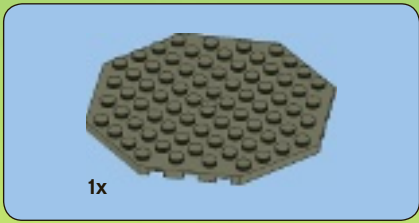
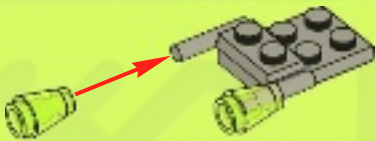

3

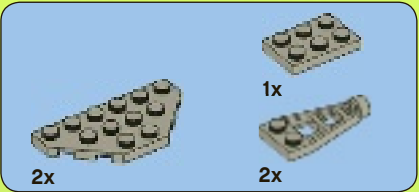

4

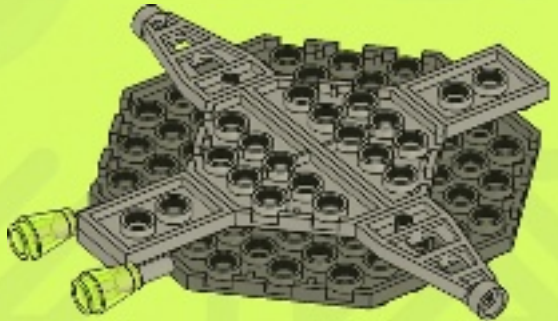



4x

5

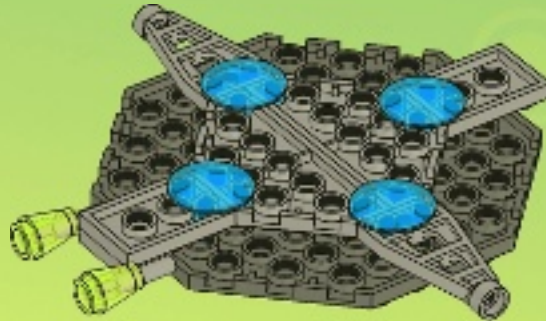

2x



2x

6

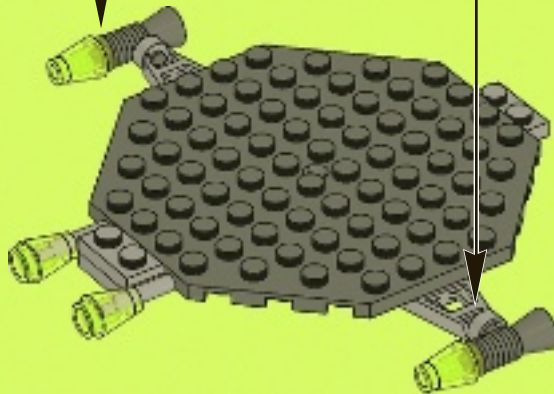
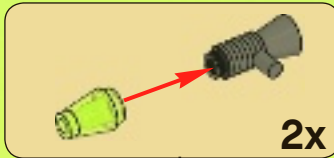



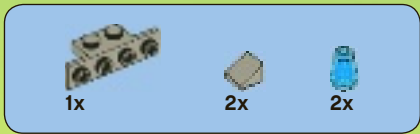

7

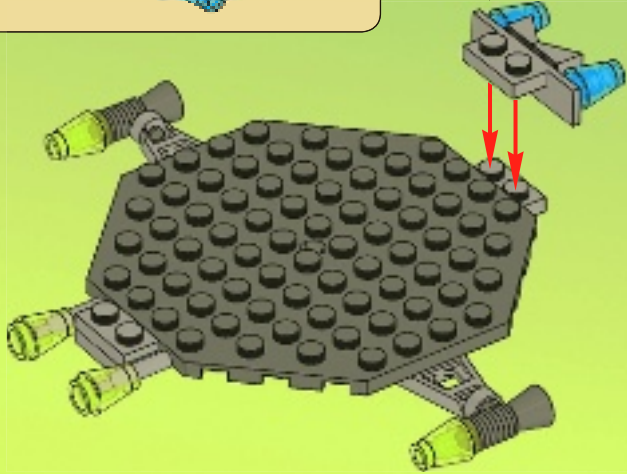

8

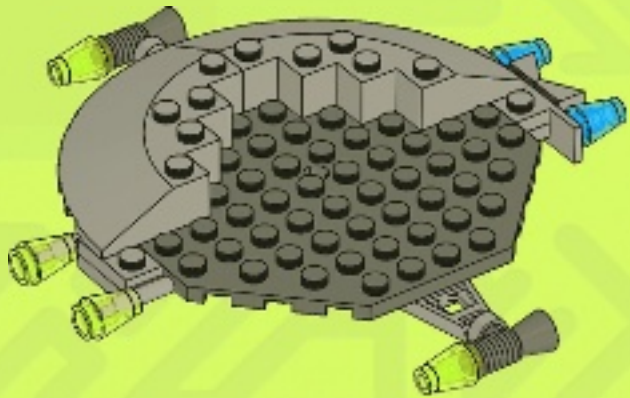



1x



1x

# 9

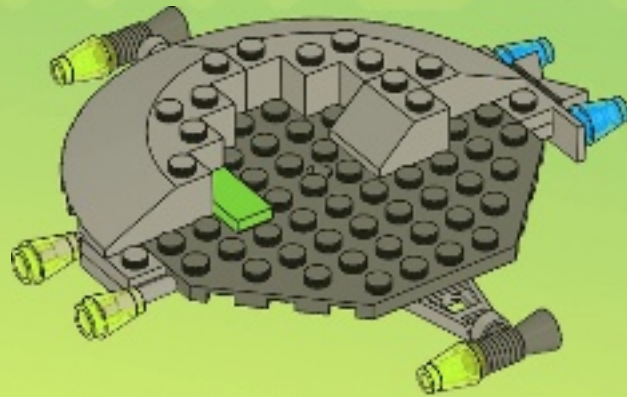

1x



1x



1x



2x

# 10

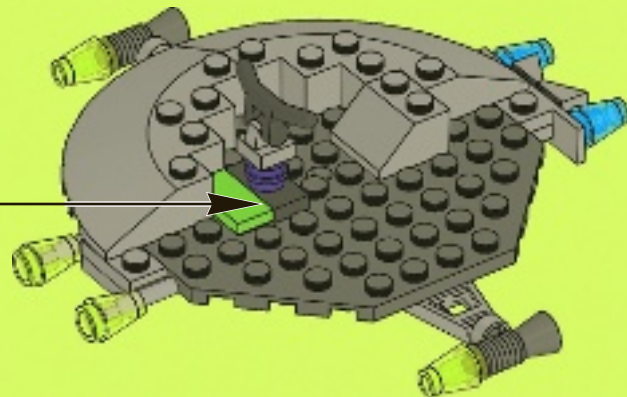

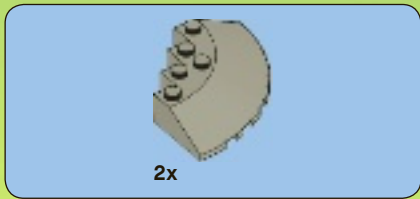

11

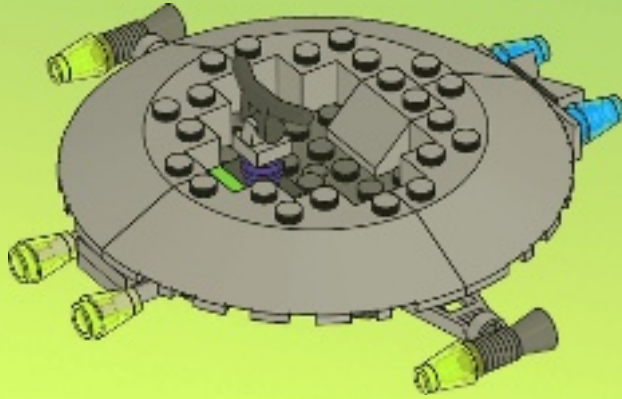

12

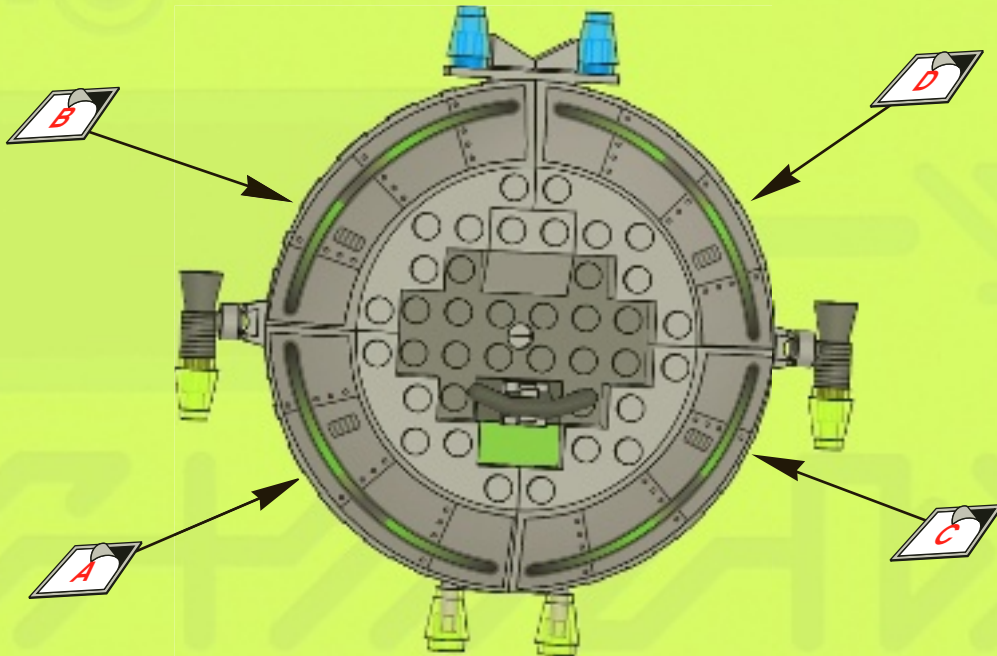



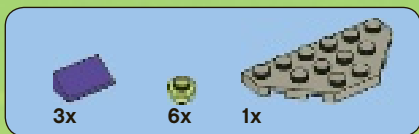

13

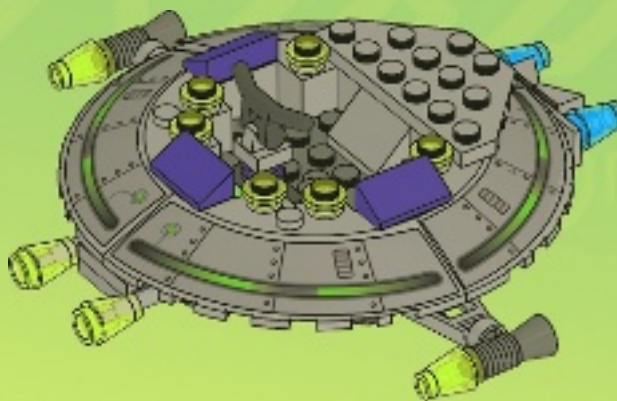

14

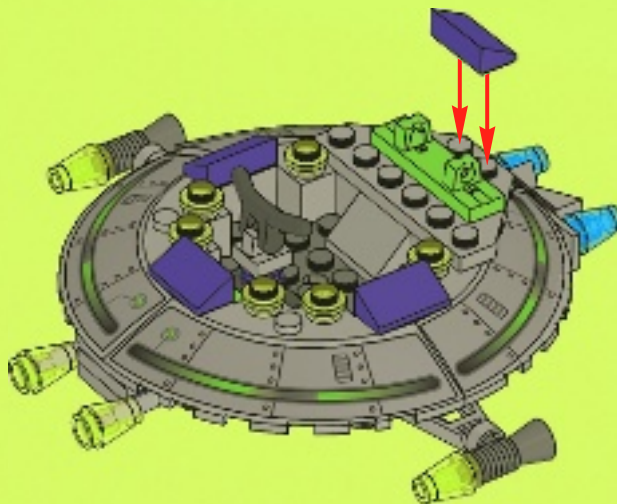

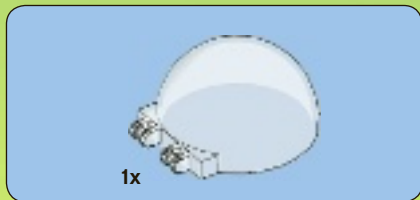

15

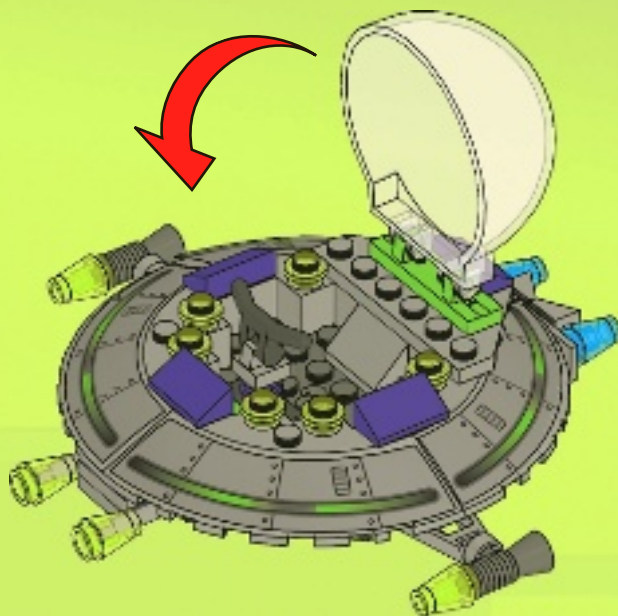



1x

1

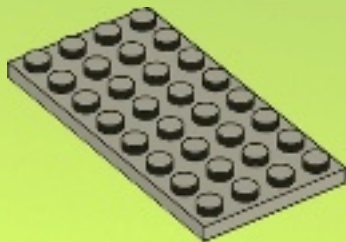

3x

2

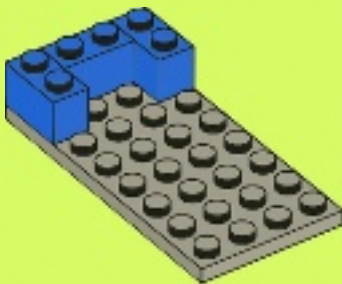

2x

2x

3

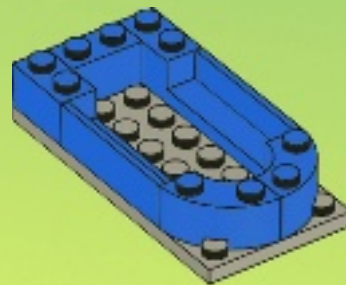

1x

1x

4

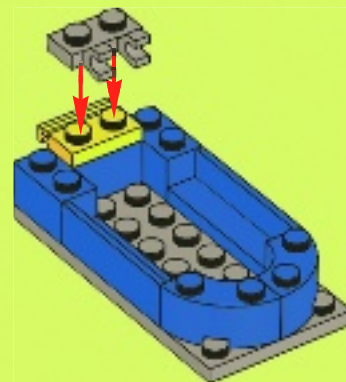



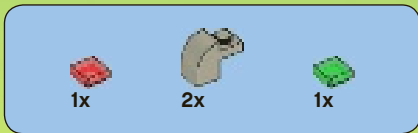

5

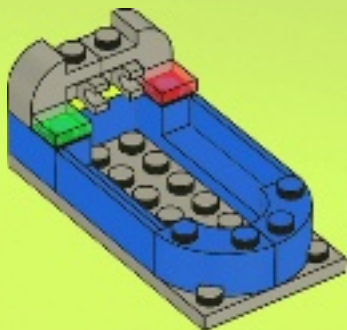

6

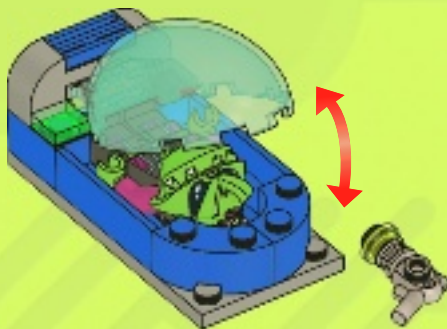
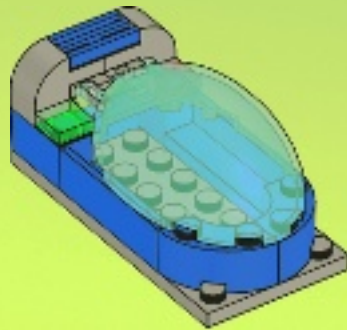

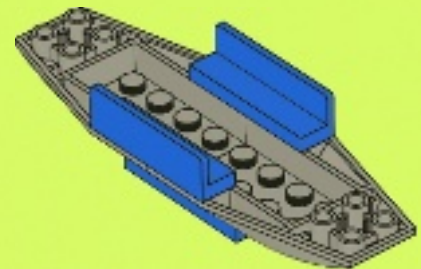
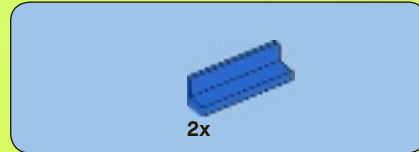
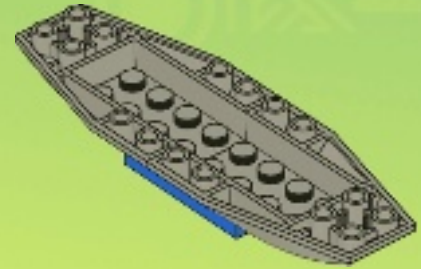
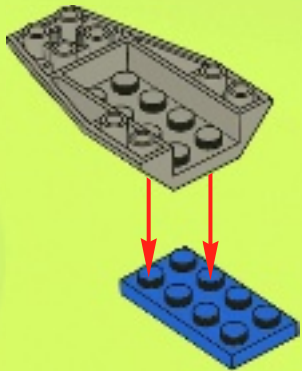
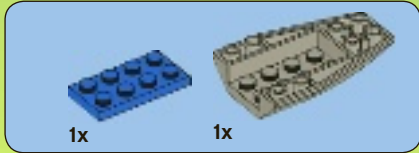
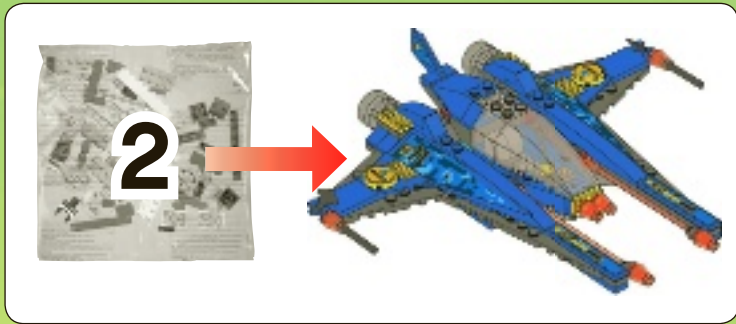



2x

4

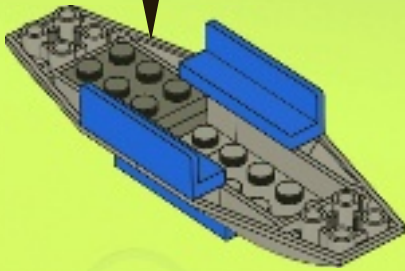

1x



2x



2x

6

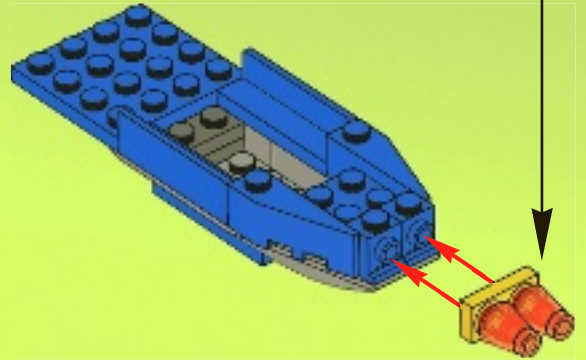

1x



1x

5

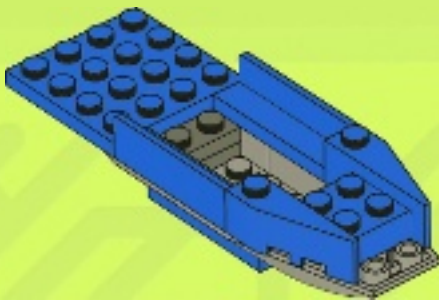

1x



1x

7

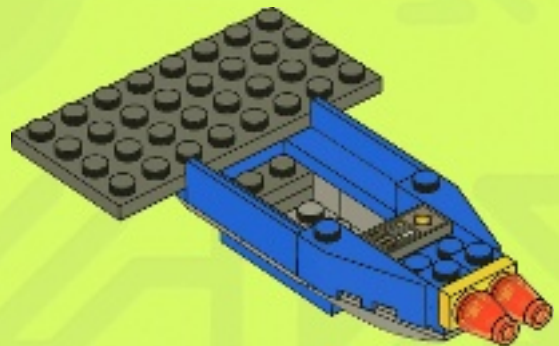





8

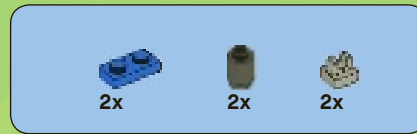
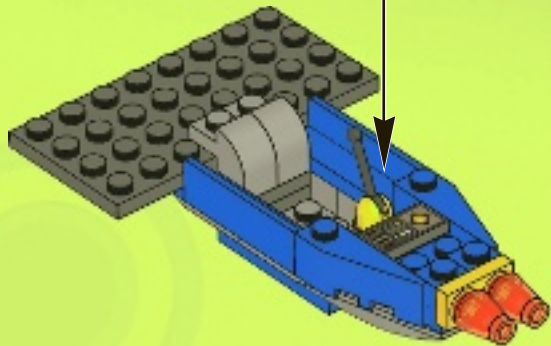
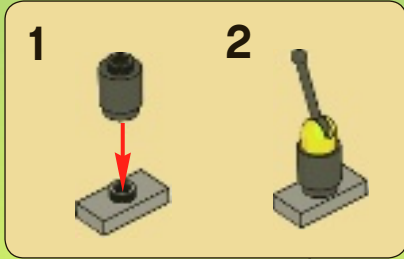

9

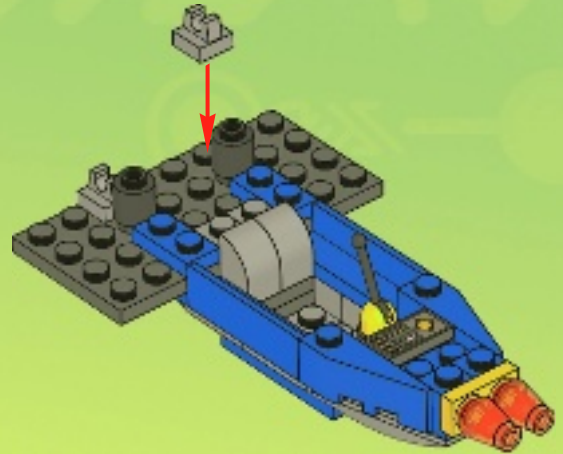

10

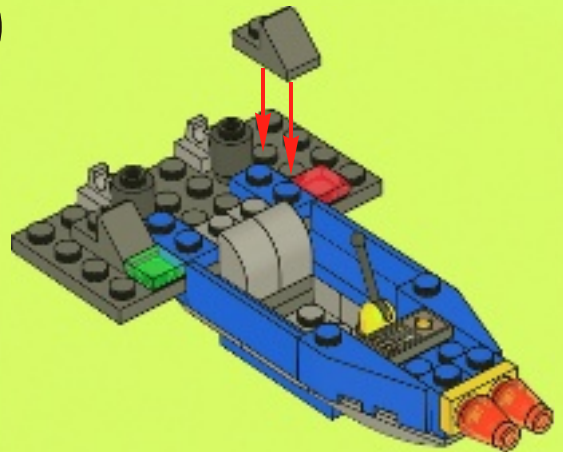

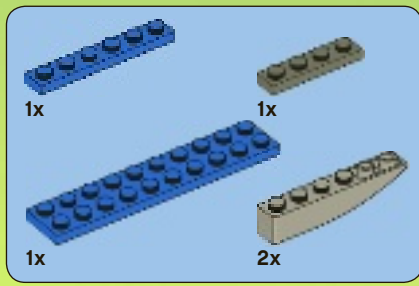

# 11

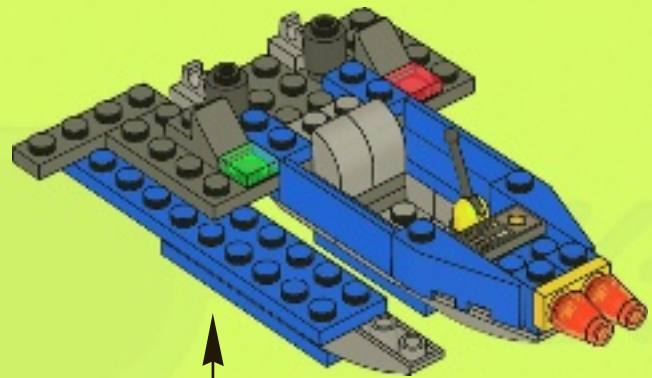
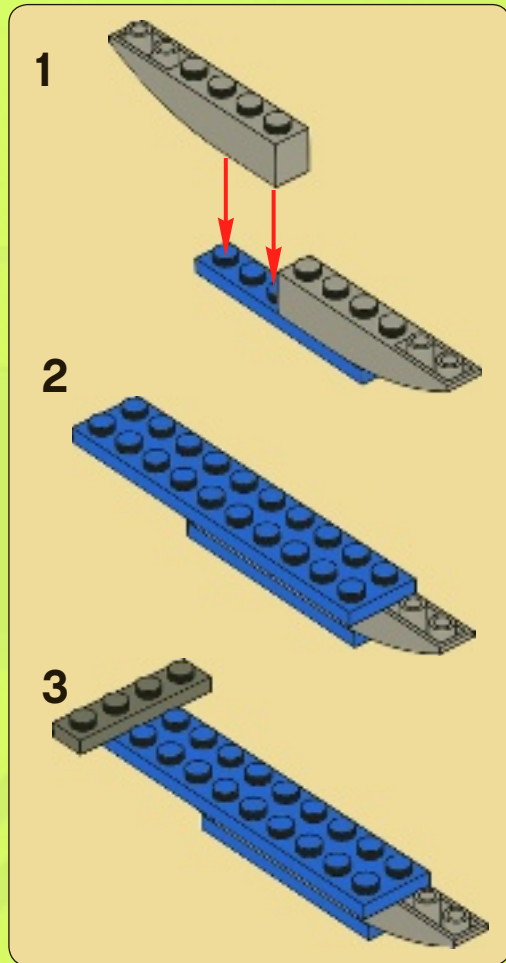

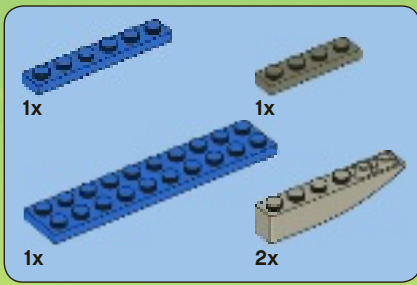

# 12

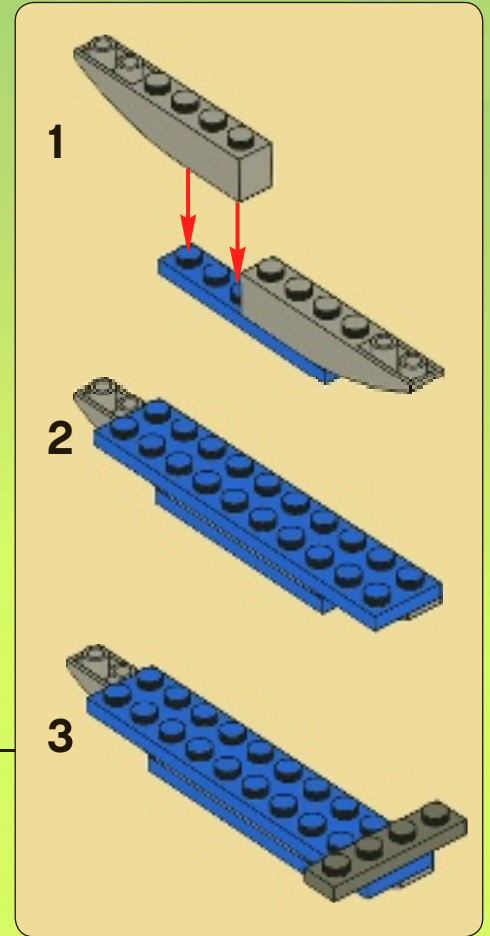
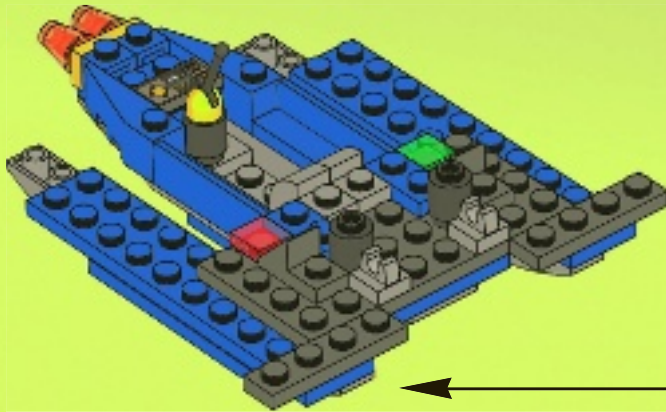

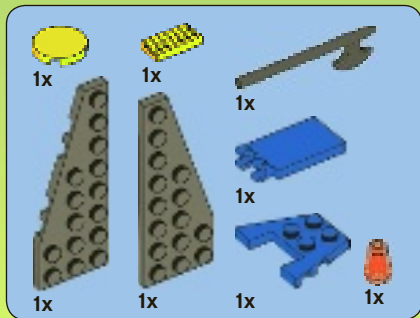

13

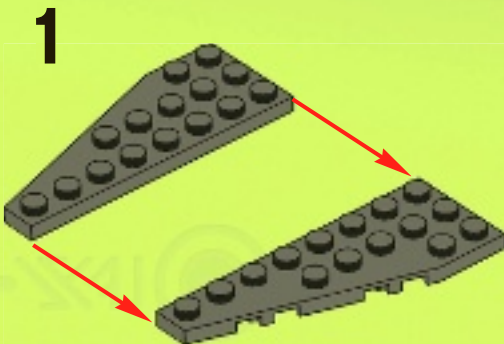

2

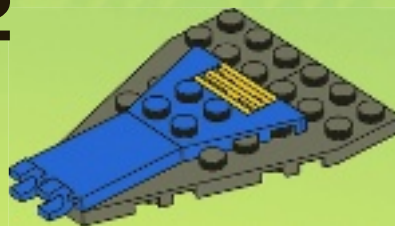

3

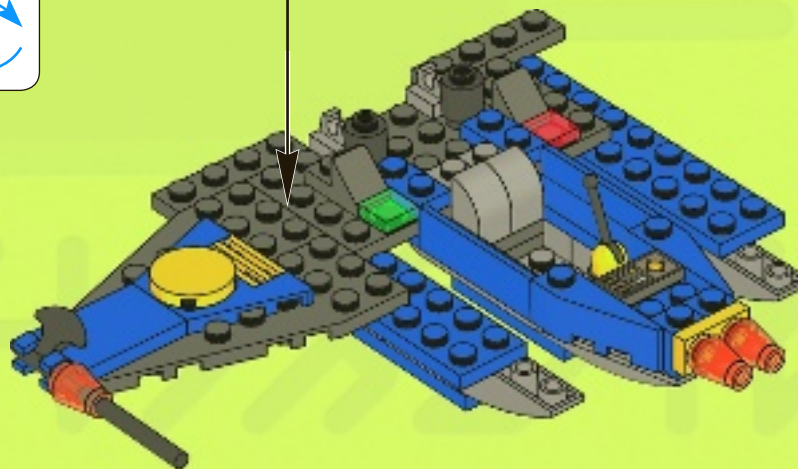
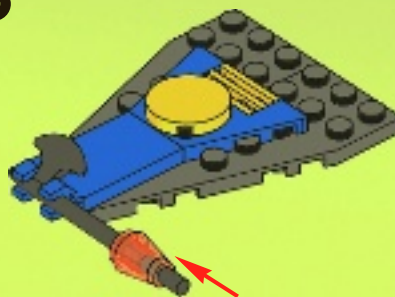



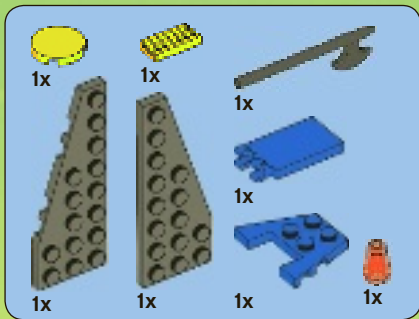

14

1

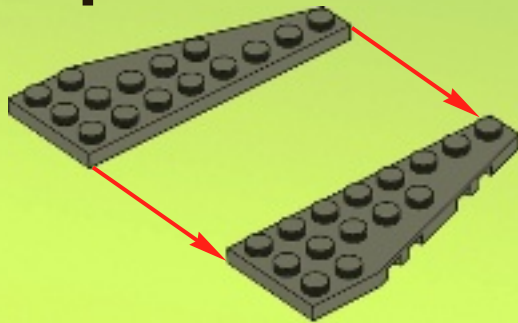

2

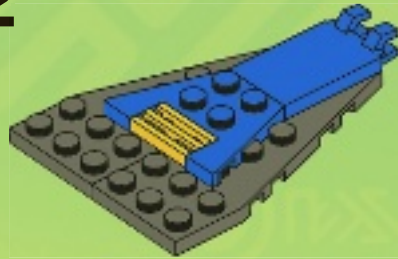

3

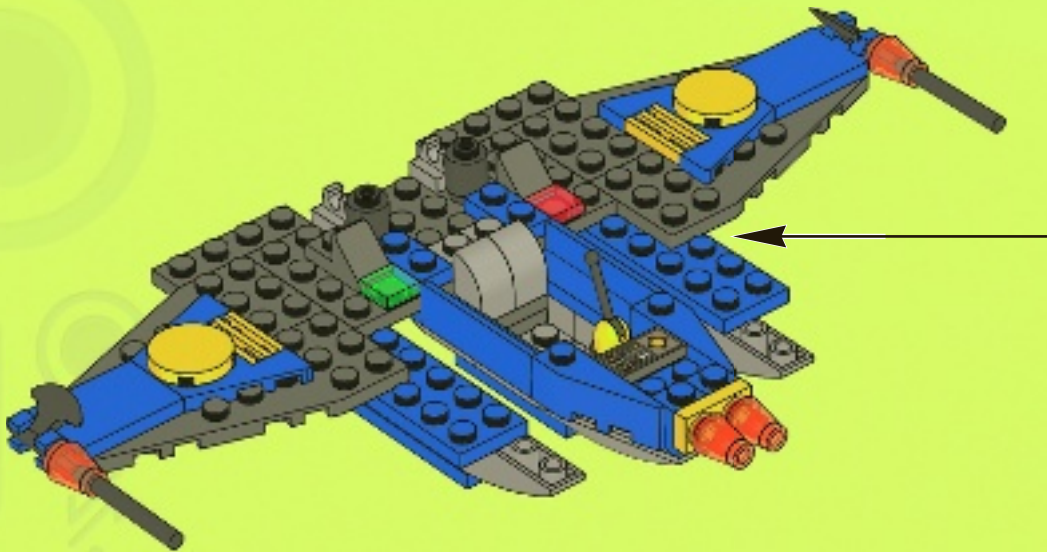
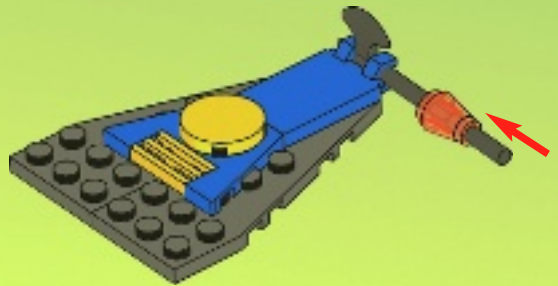

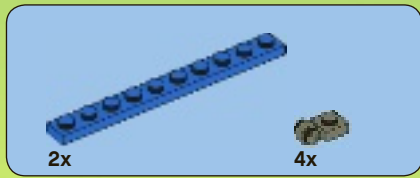

15

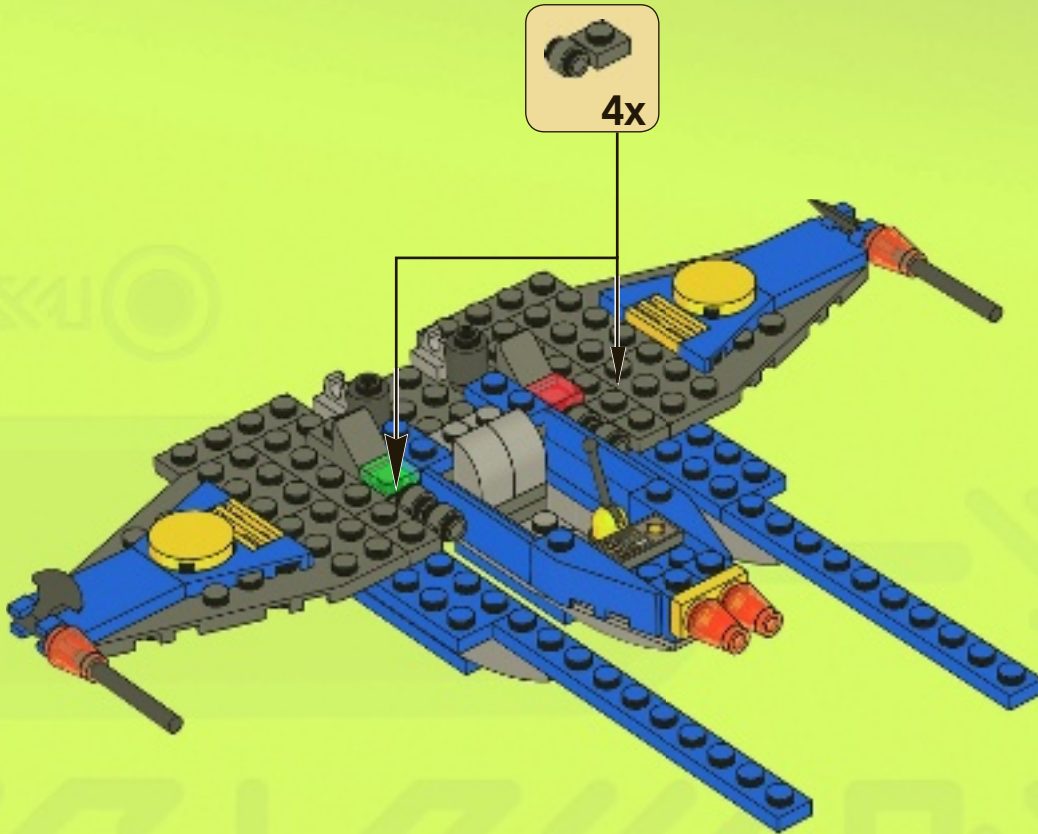

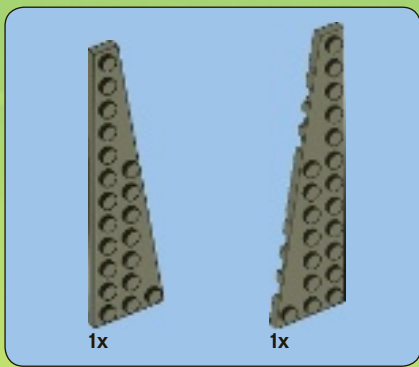

16

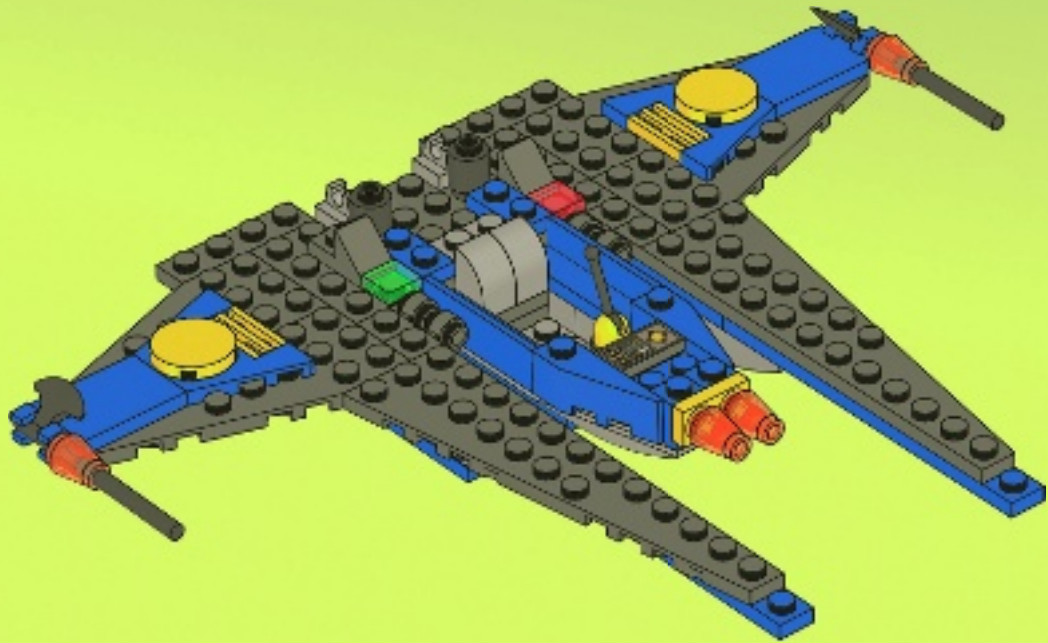

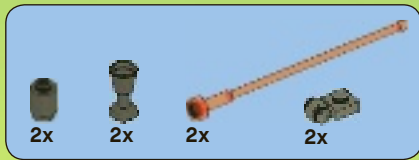

17

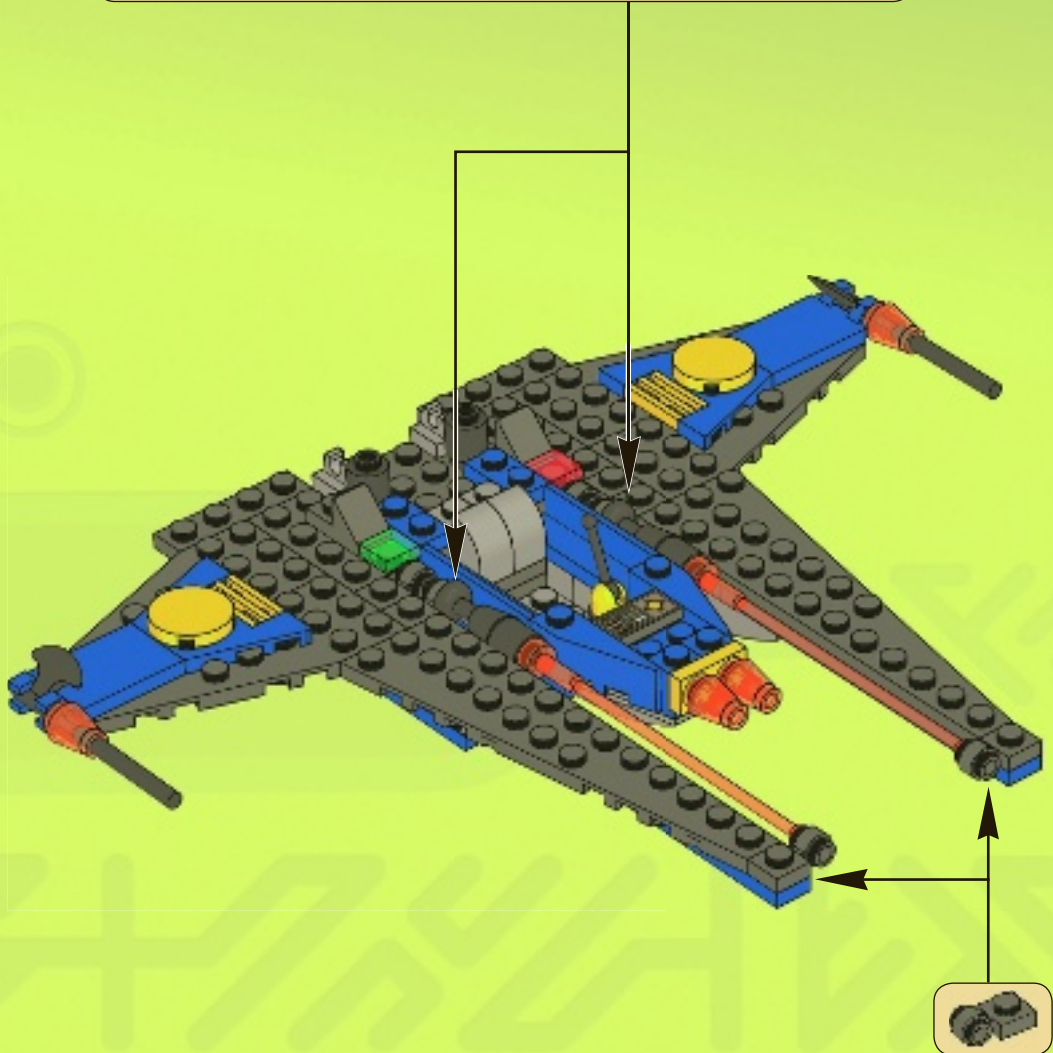
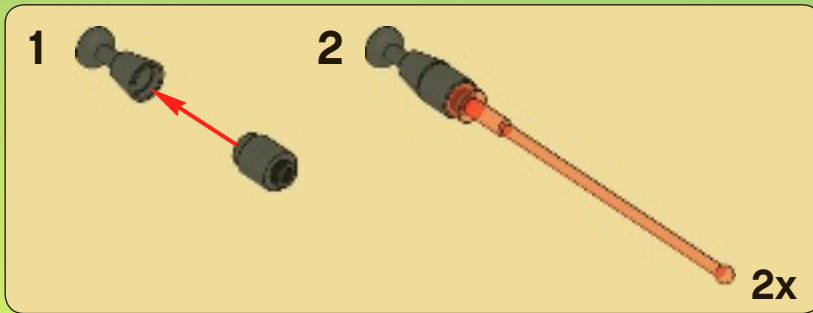



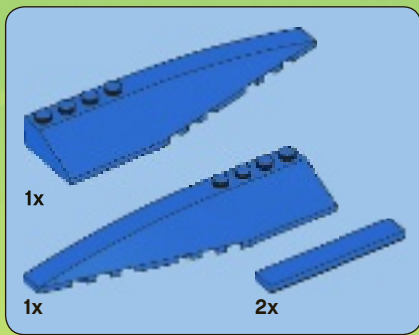

18

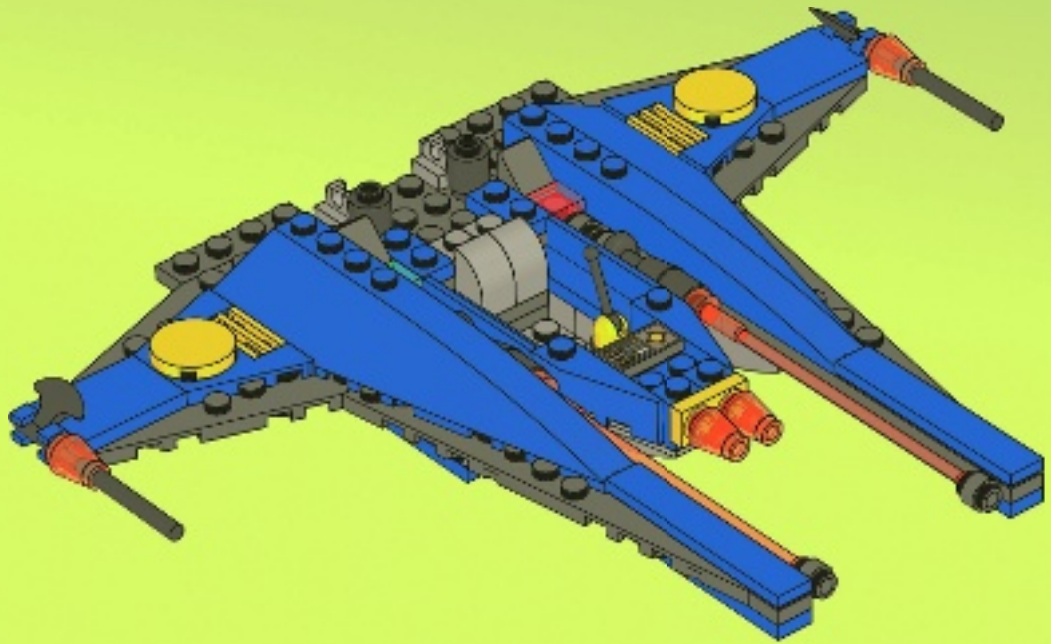

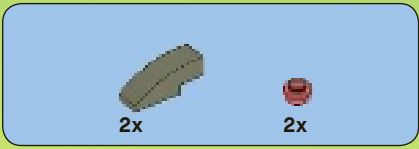

19

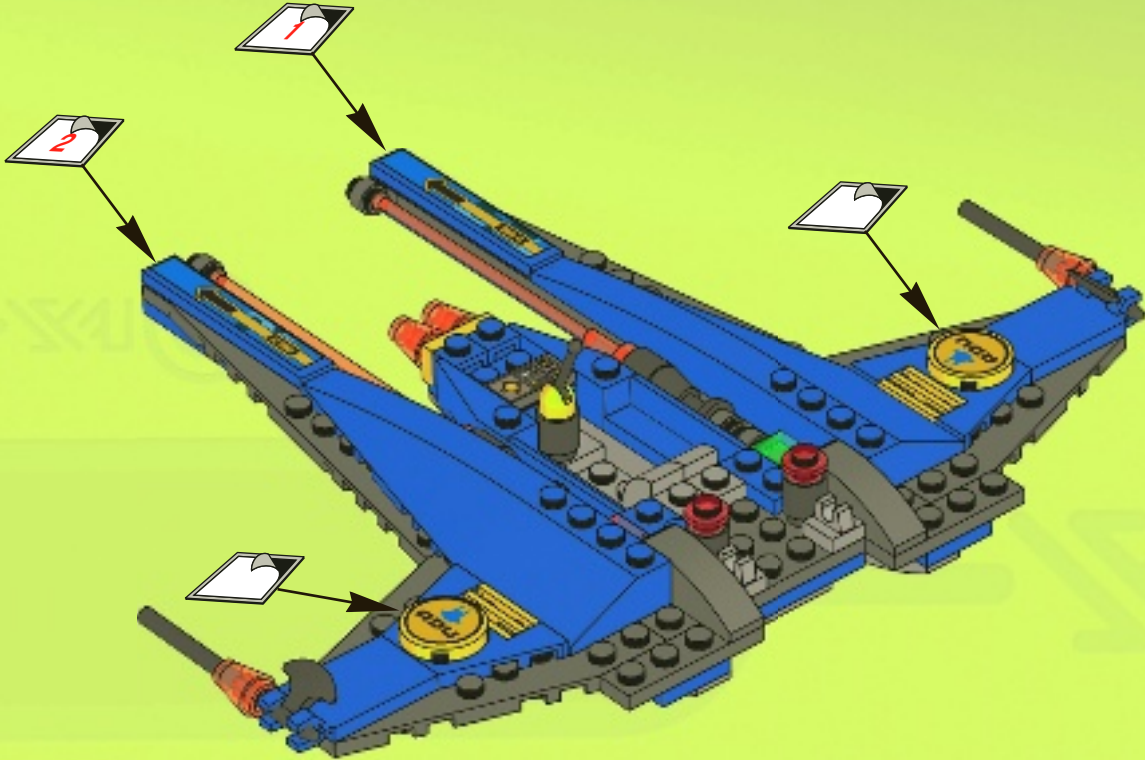

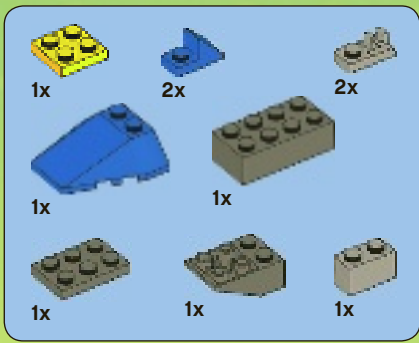

**20**

**1**



**2**



**3**

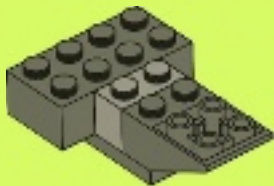

**4**



**5**

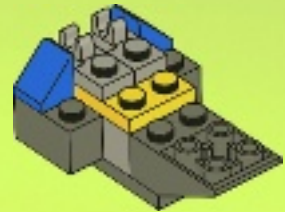

**6**



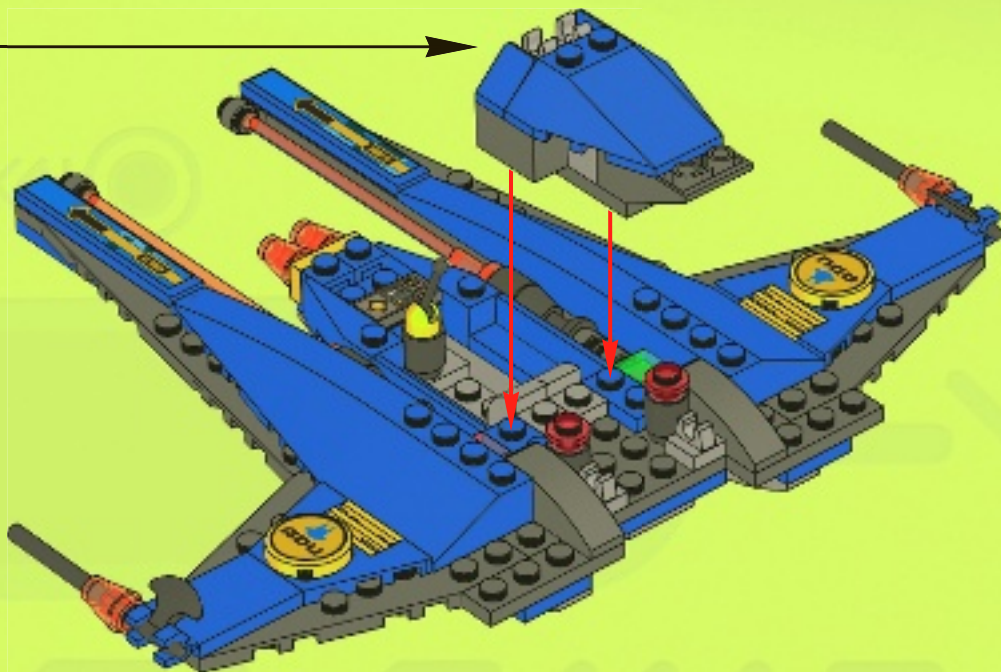



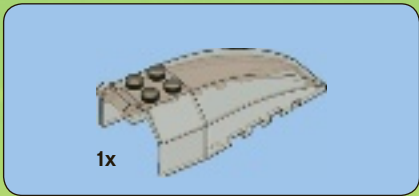

21

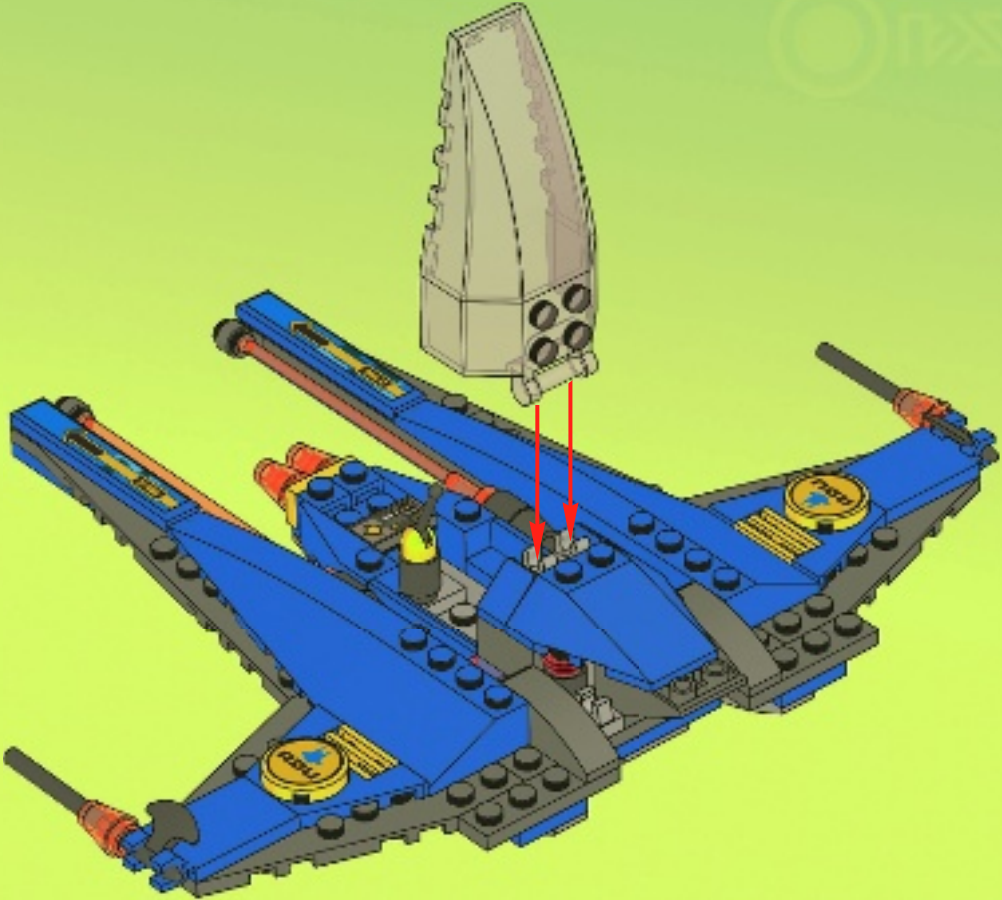



2x



2x

# 22

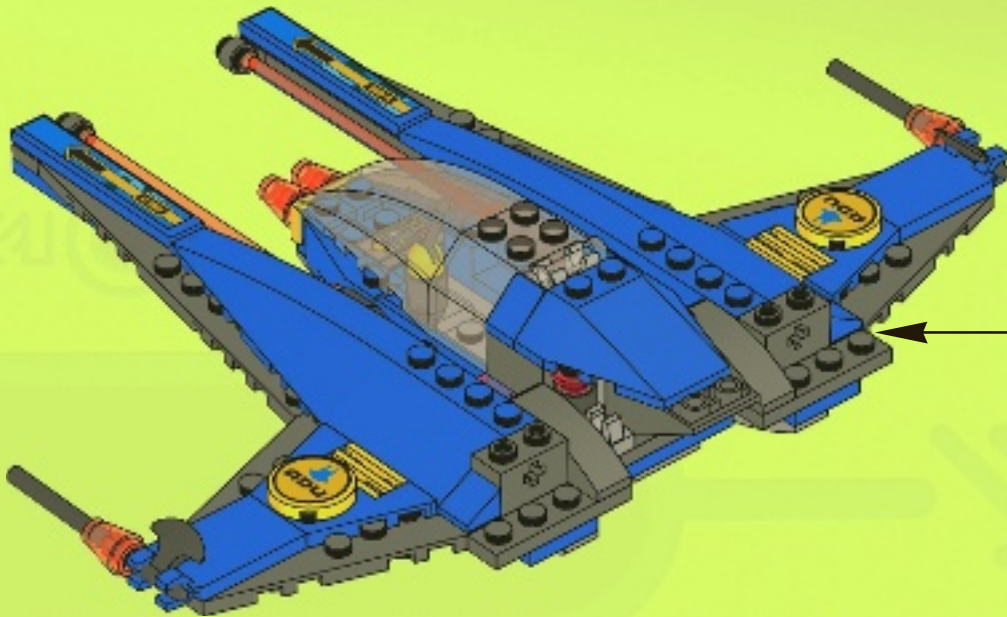



2x



2x



1x

# 23

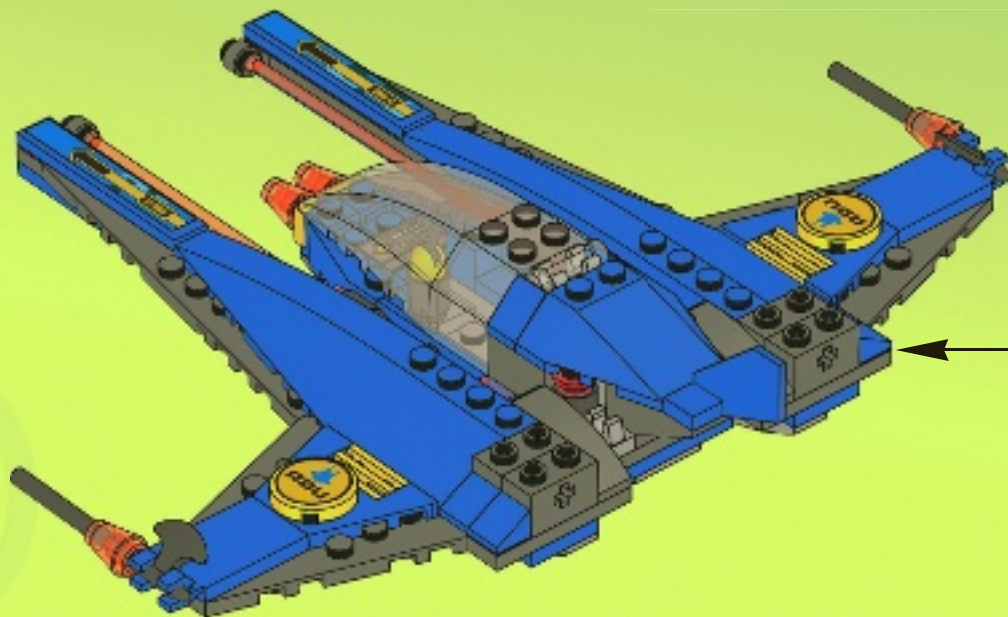



2x



2x

# 24

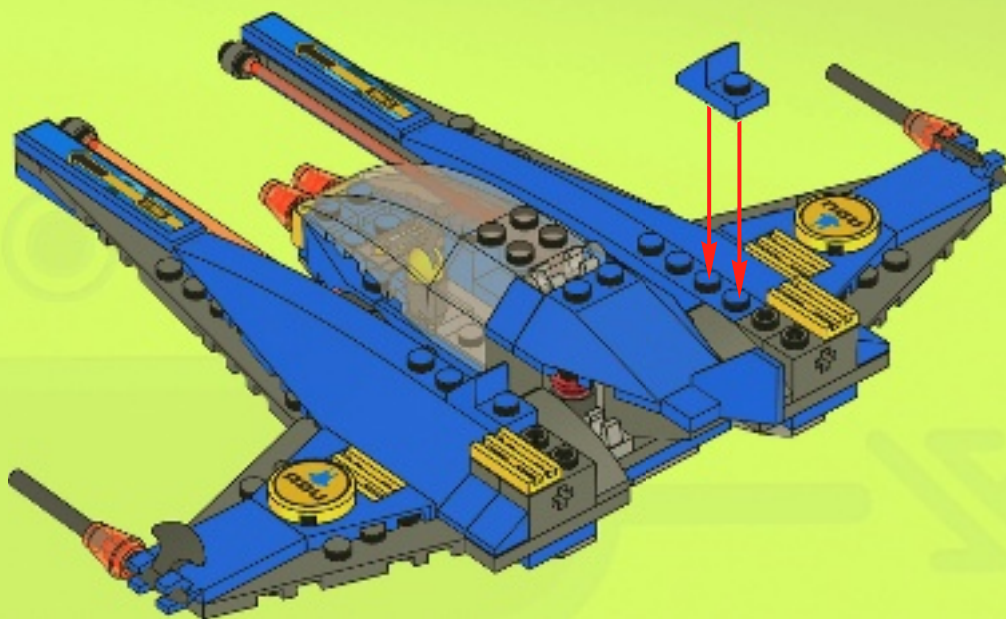





2x

# 25

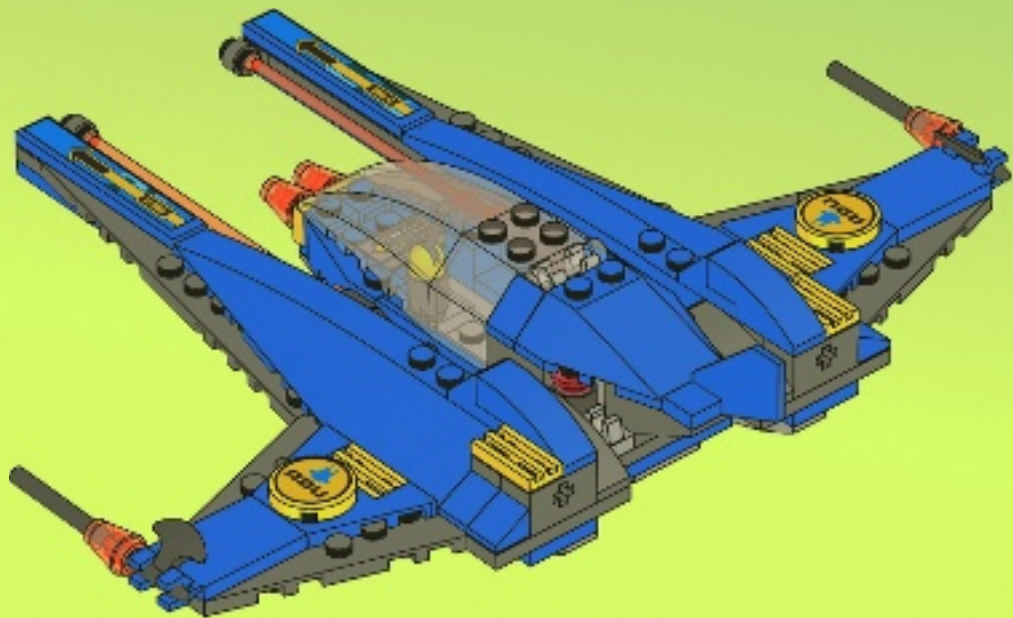

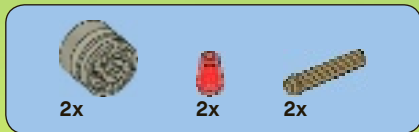

26

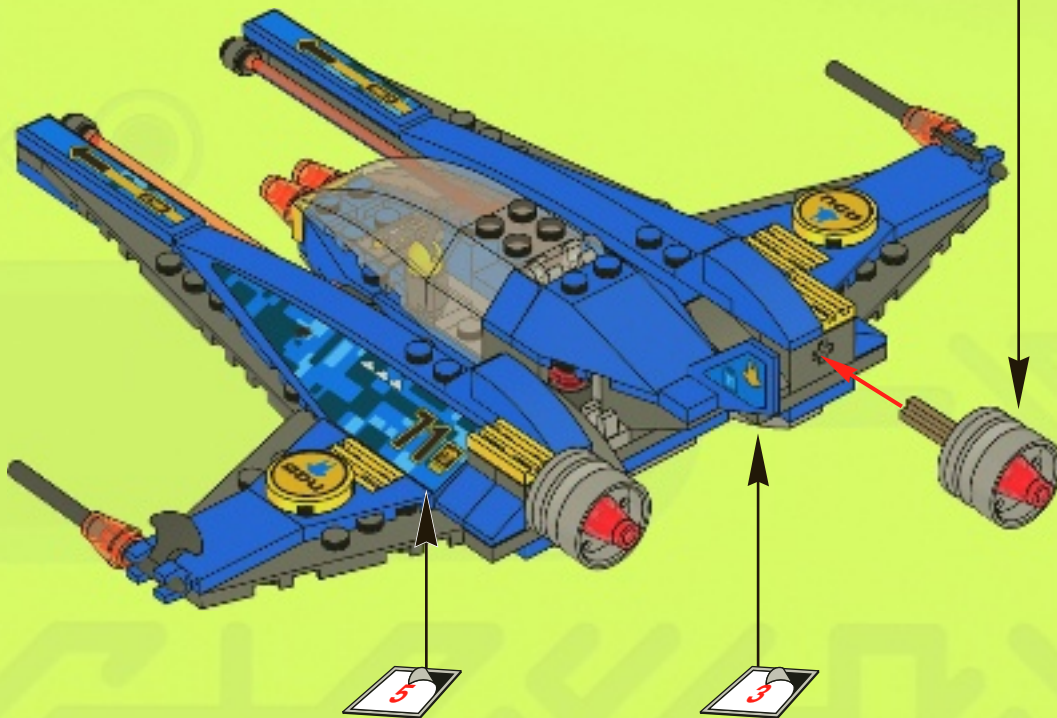
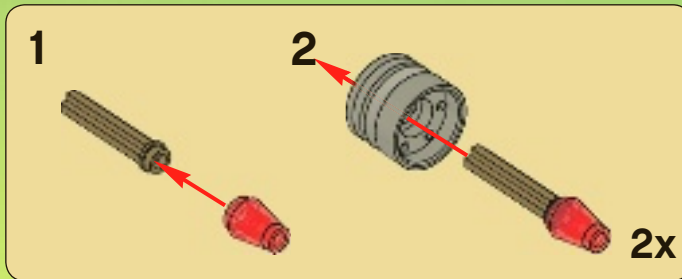



2x

# 27

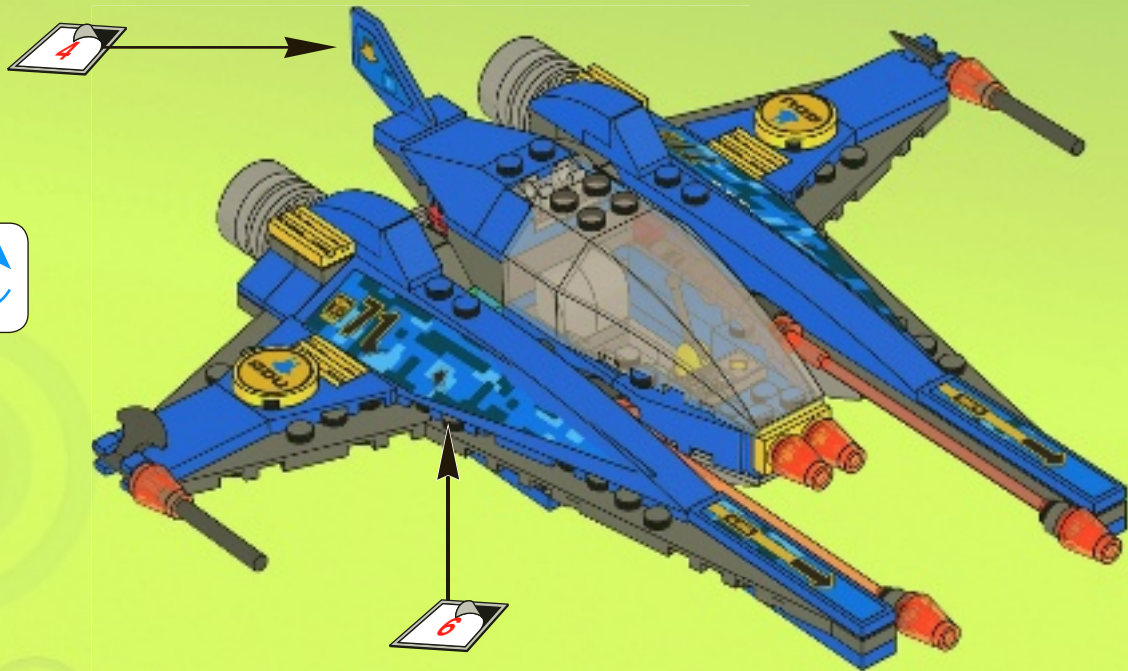

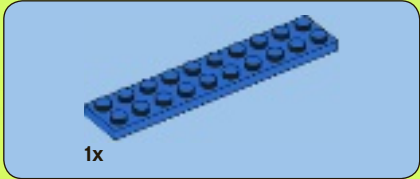
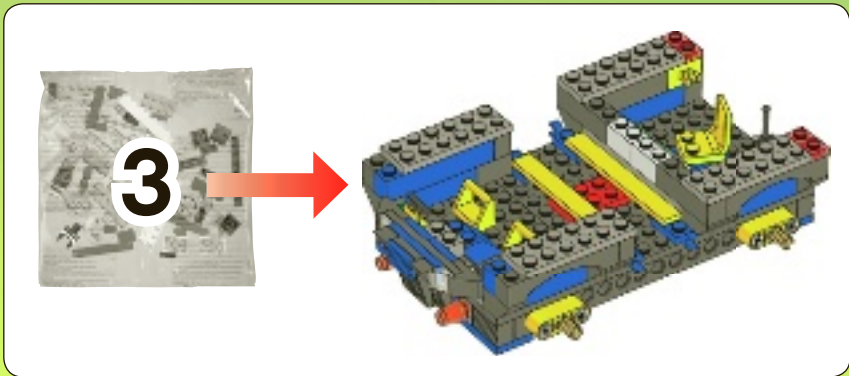

1

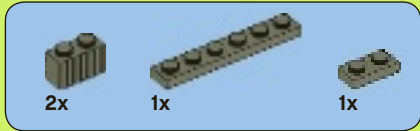

2

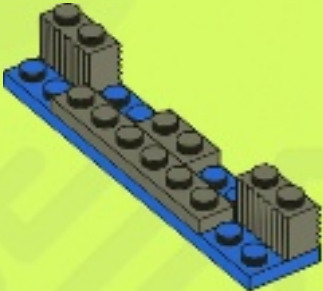





3

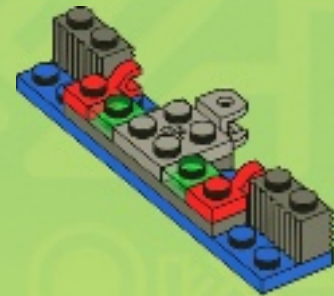

4

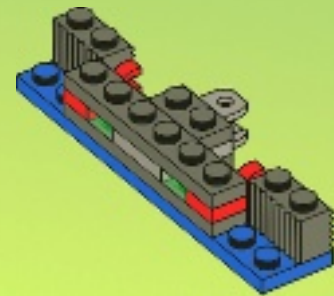

5

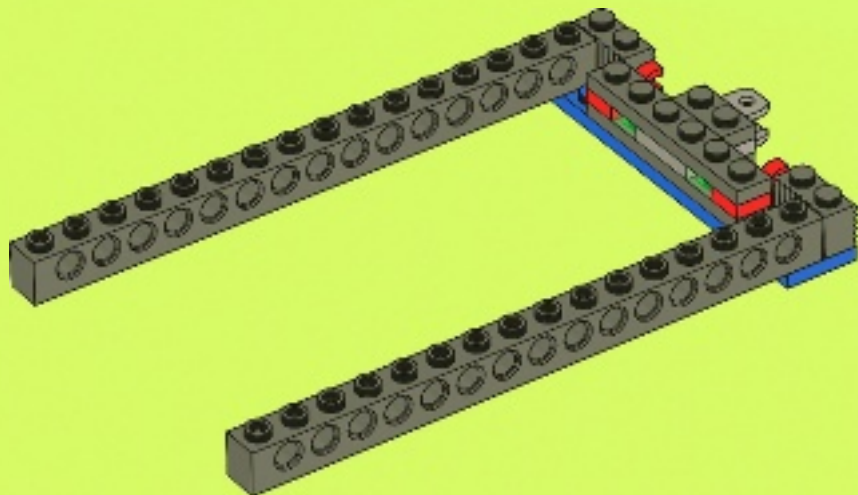



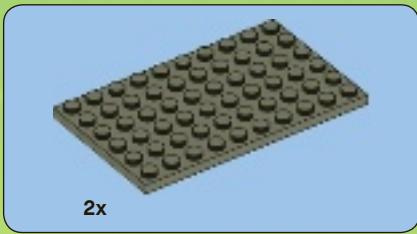

8

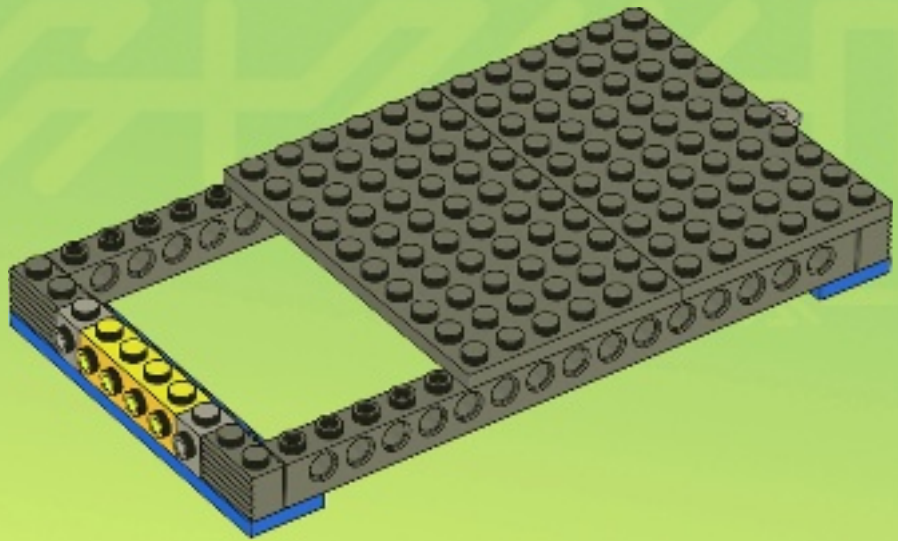

9

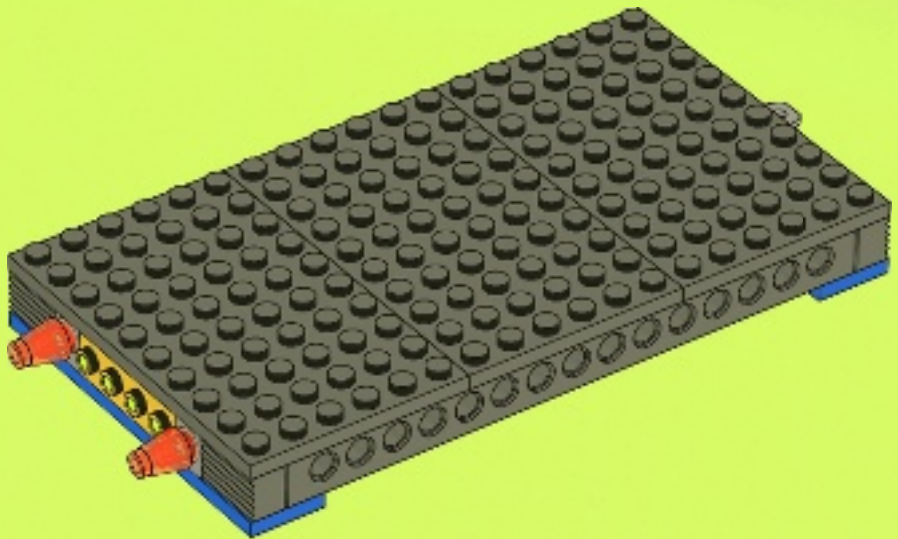

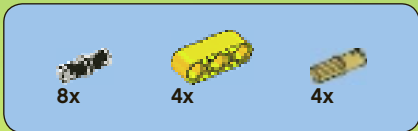

10

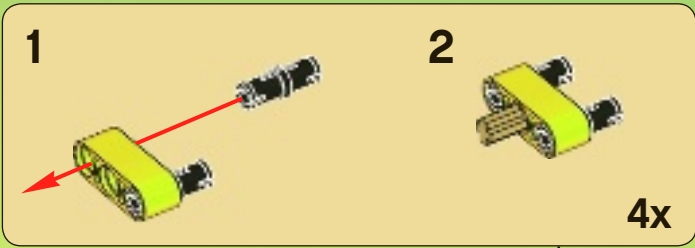

2

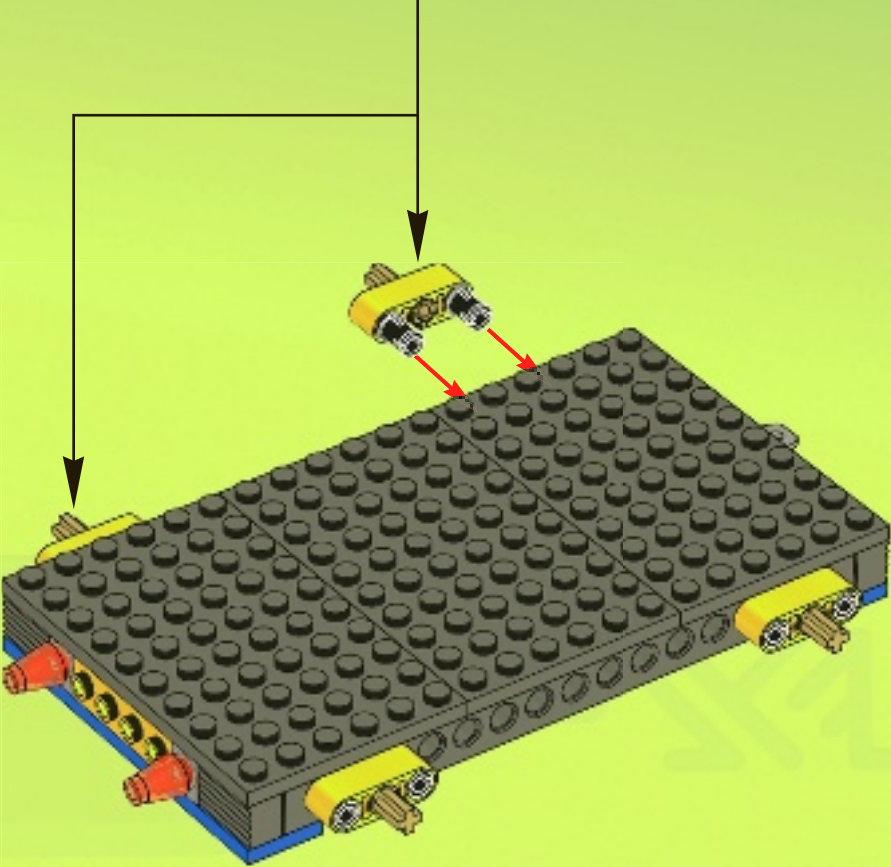



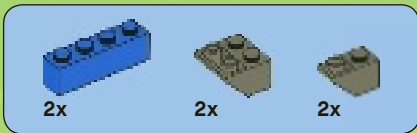

11

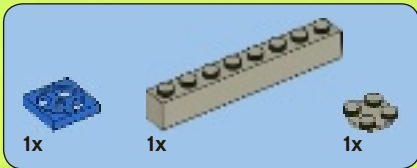
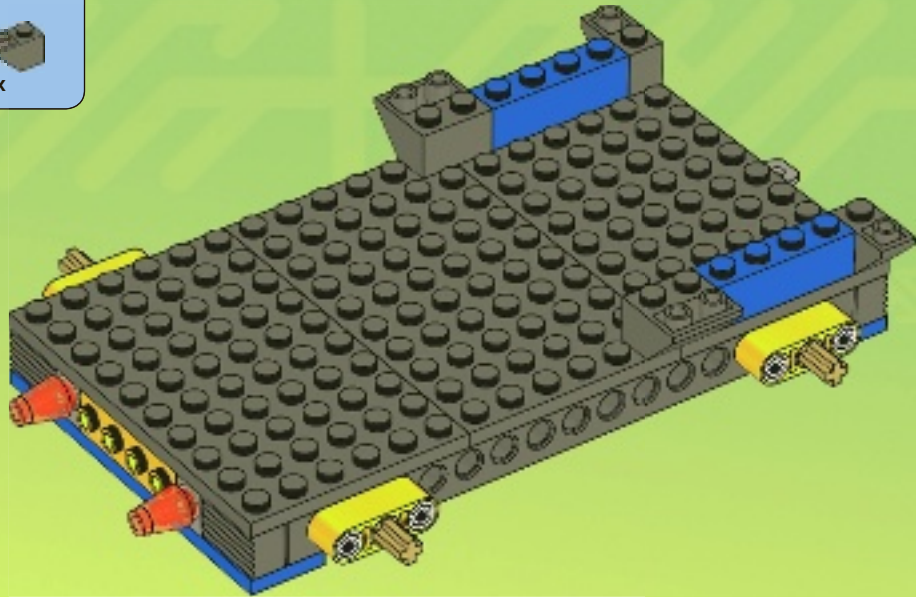

12

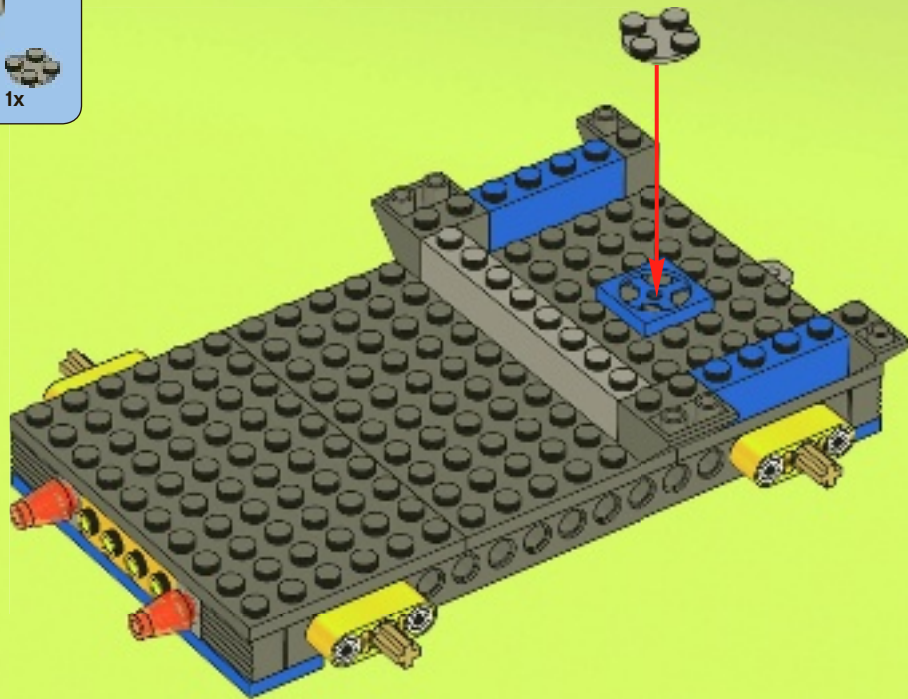



13

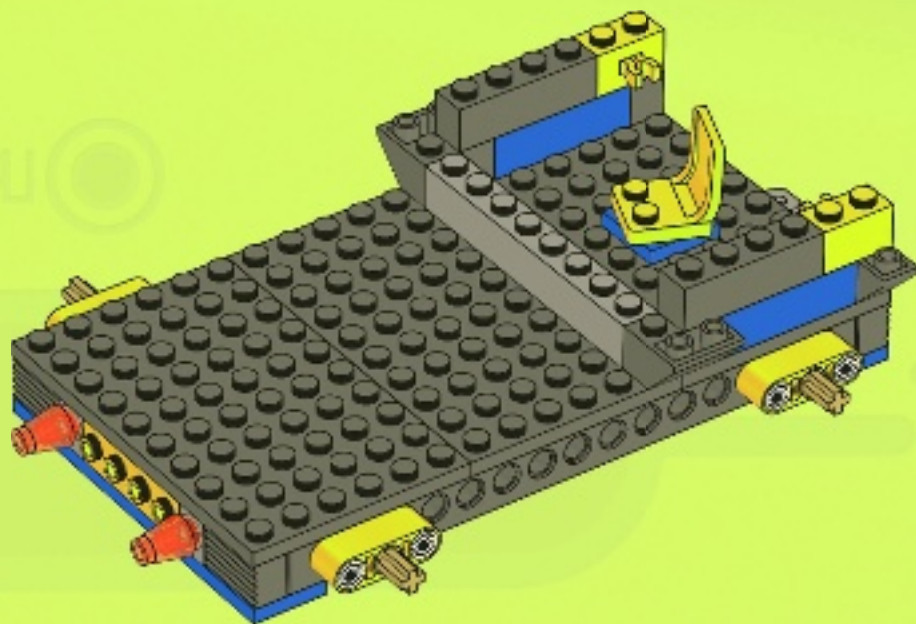



14

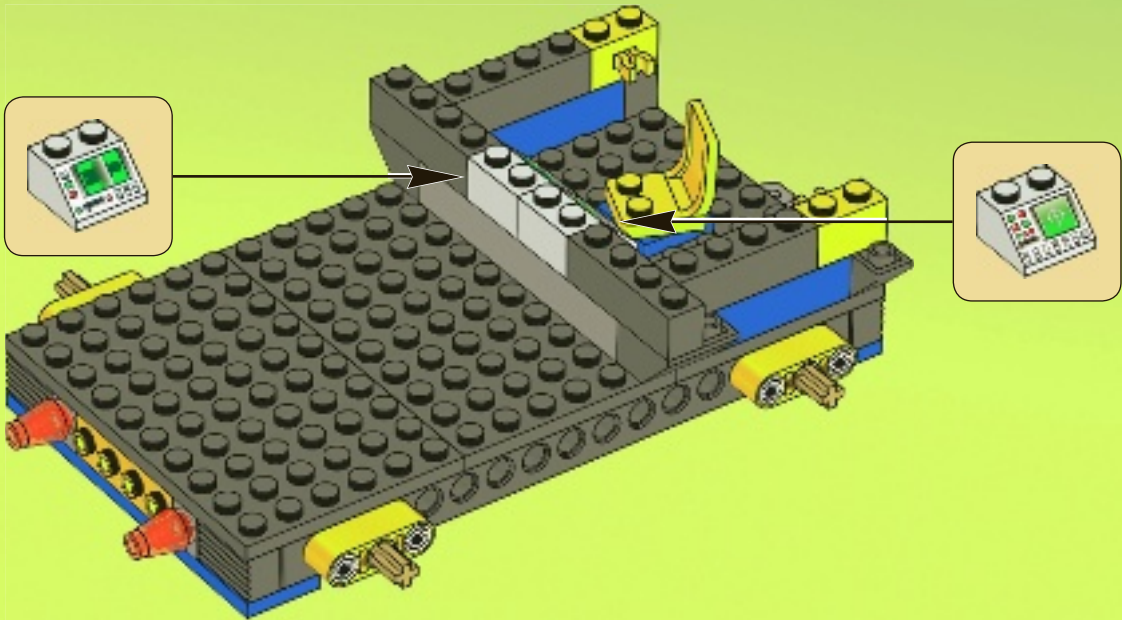

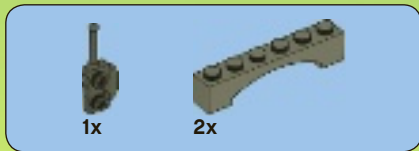

15

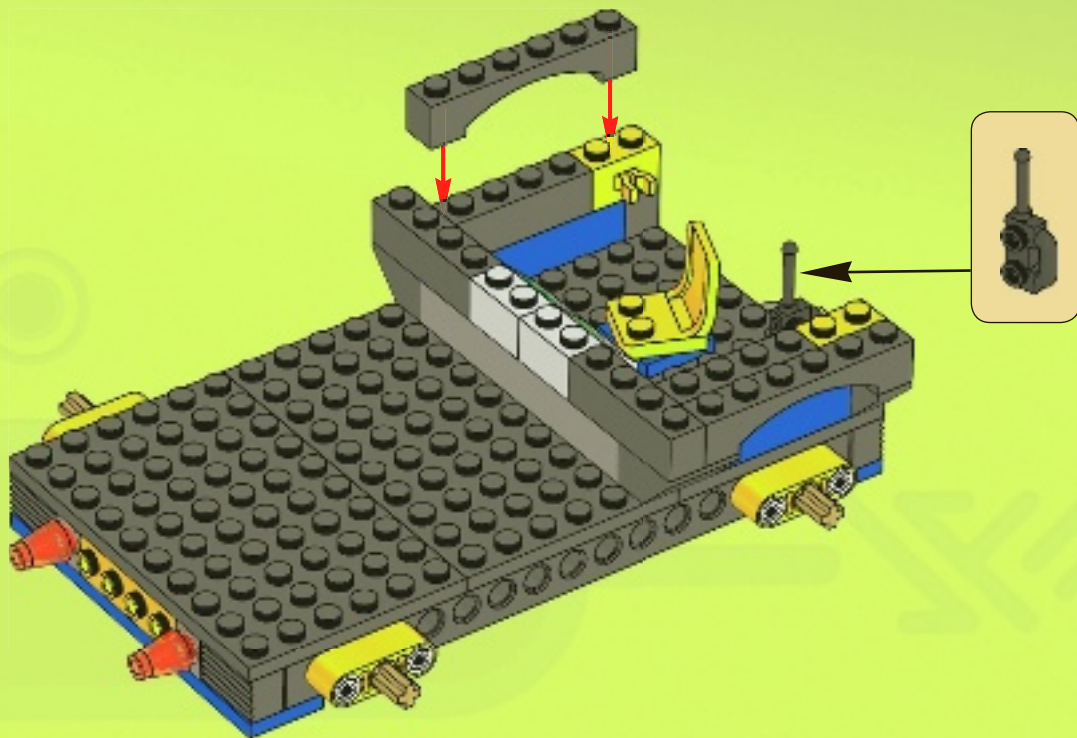



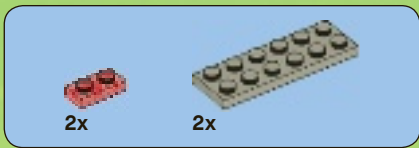

16

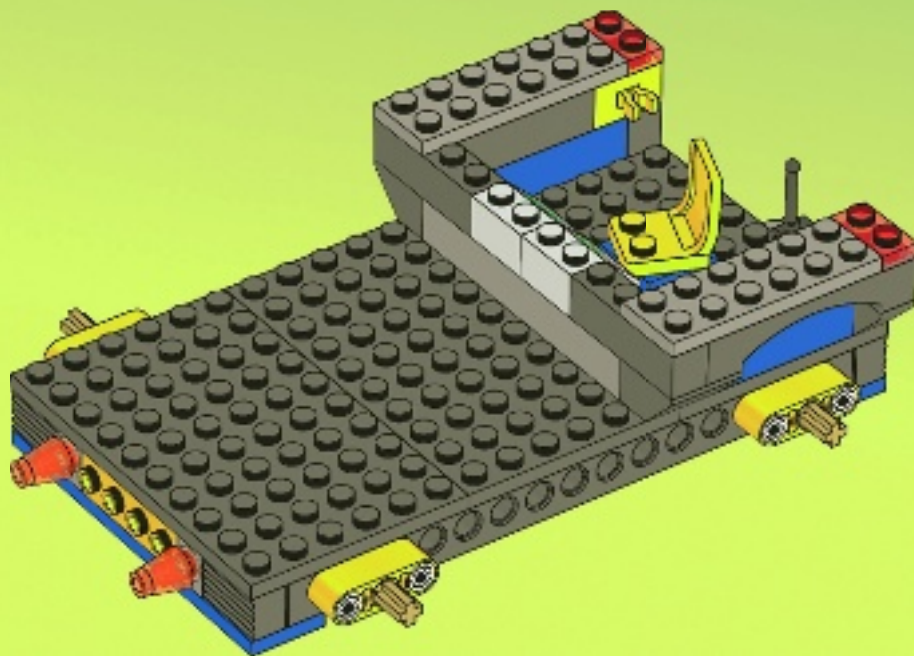



1x



4x

# 17

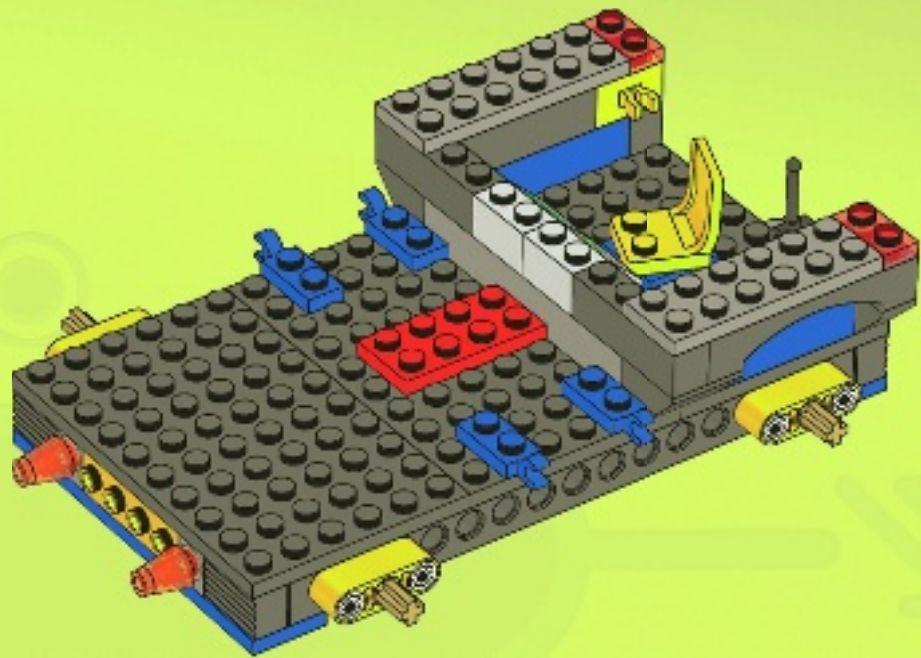

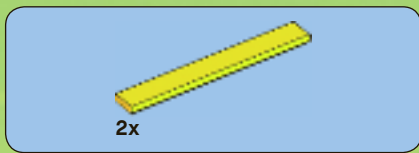

18

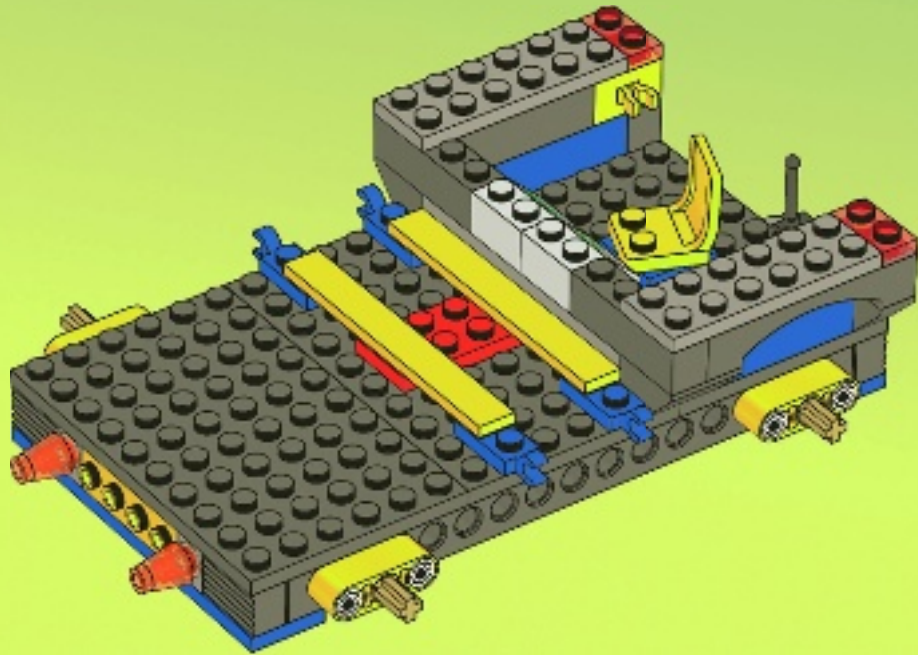



2x



2x



2x

# 19

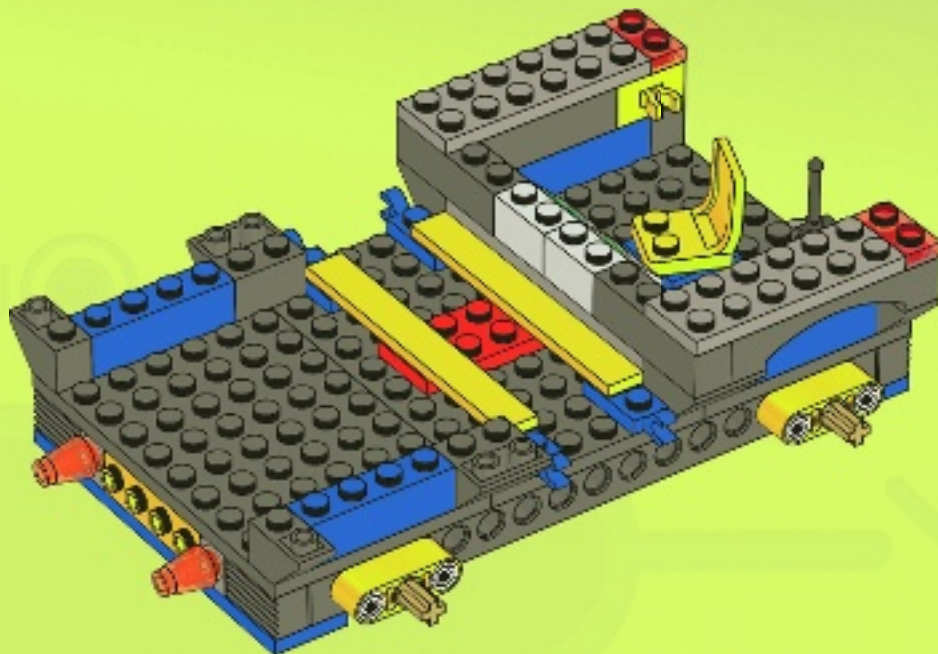



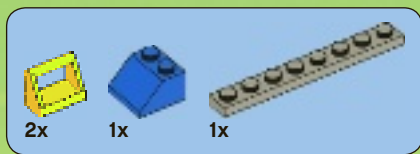

20

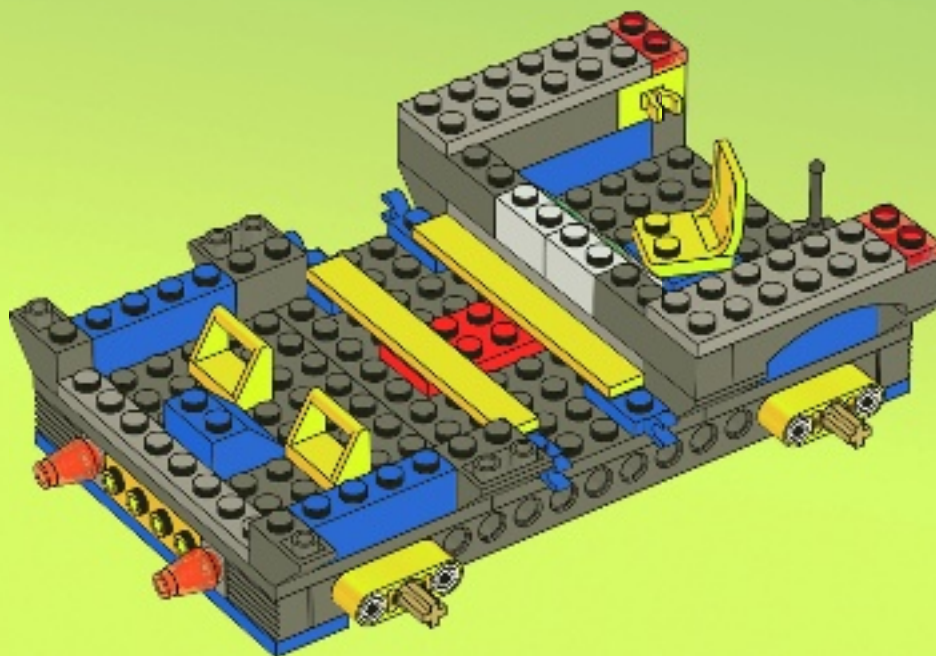



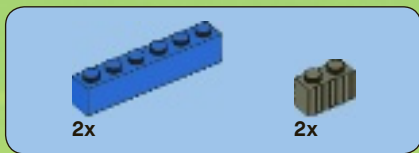

22

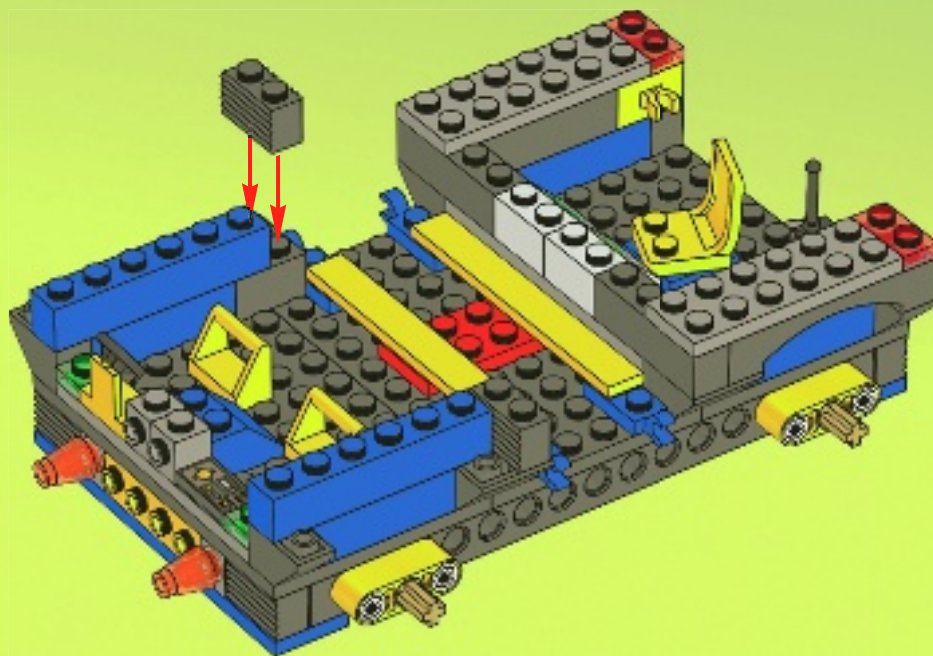



2x

# 23

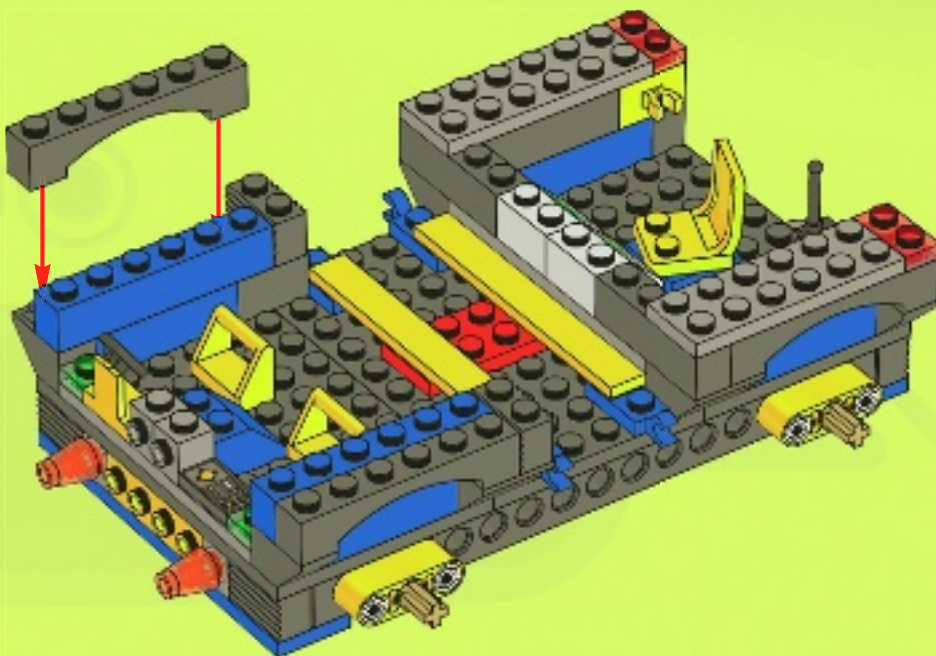





2x

# 24

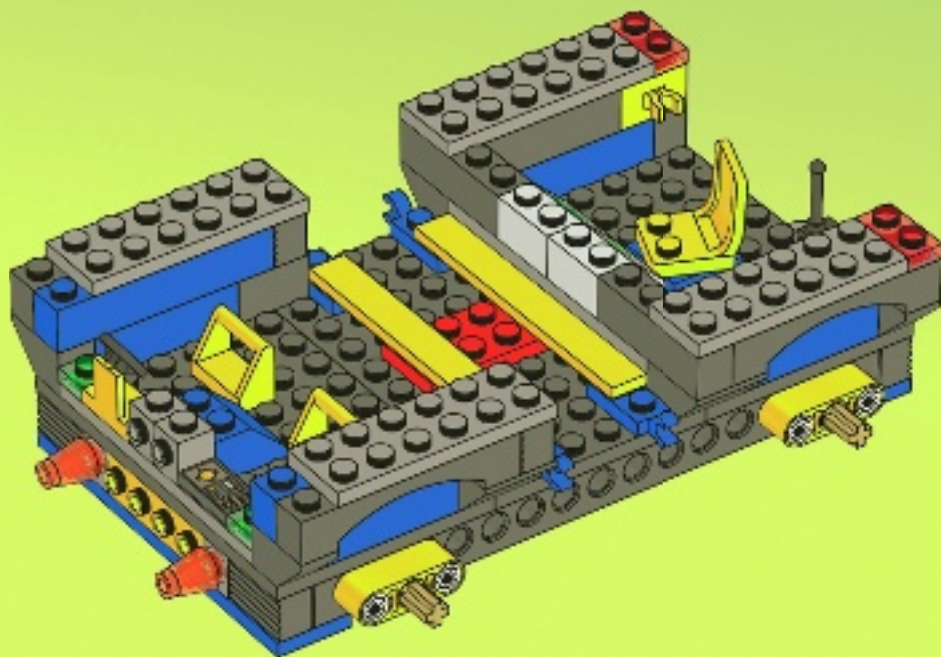

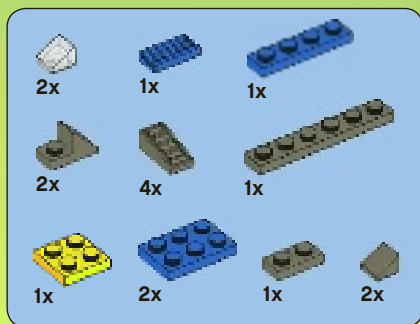

# 25

1

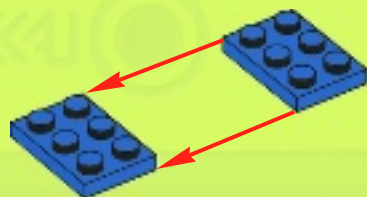

2



3

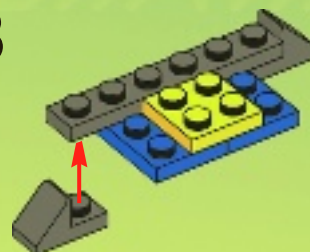

4

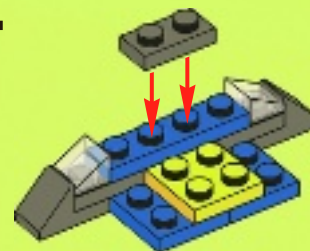

5



6

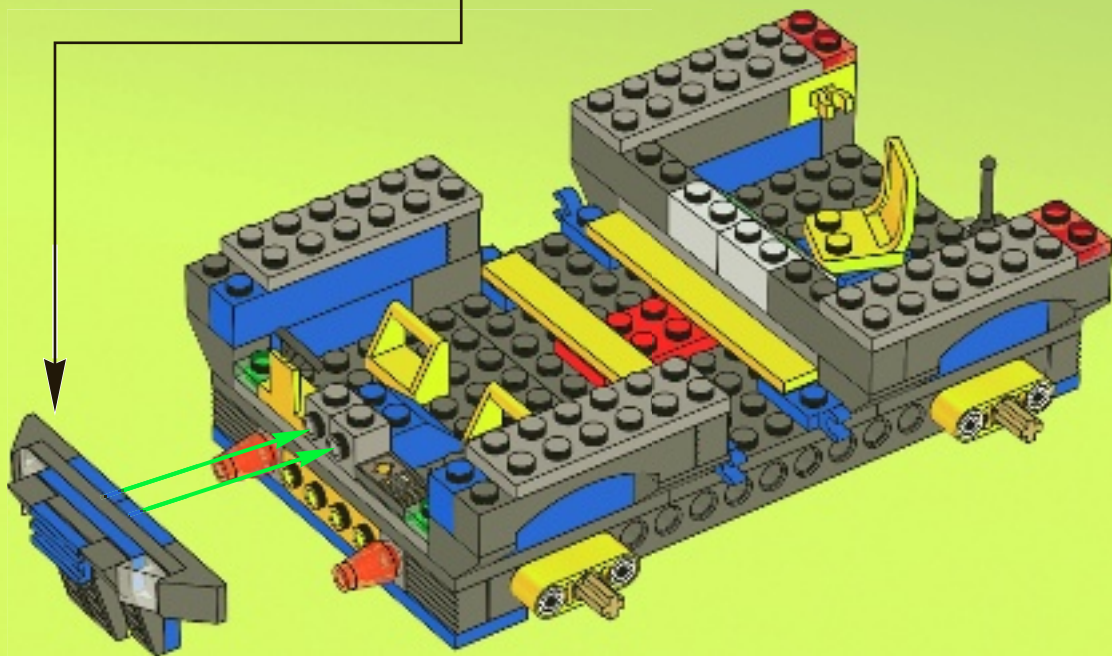
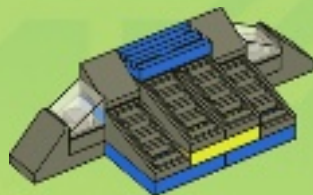

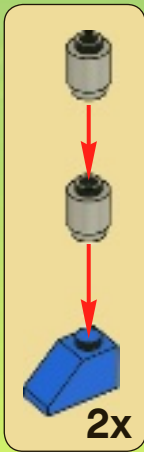
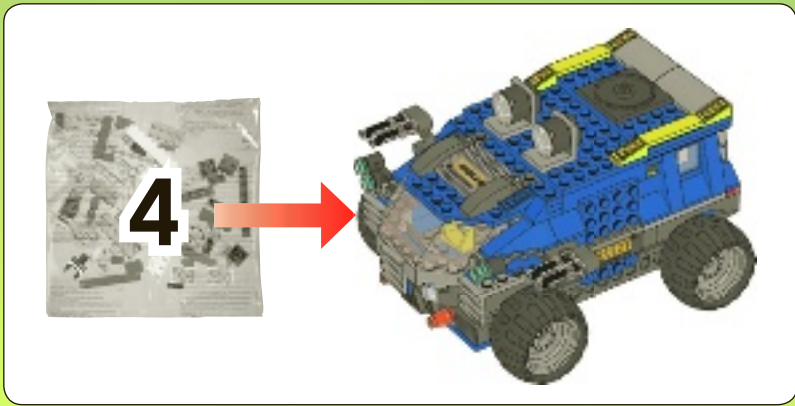

26

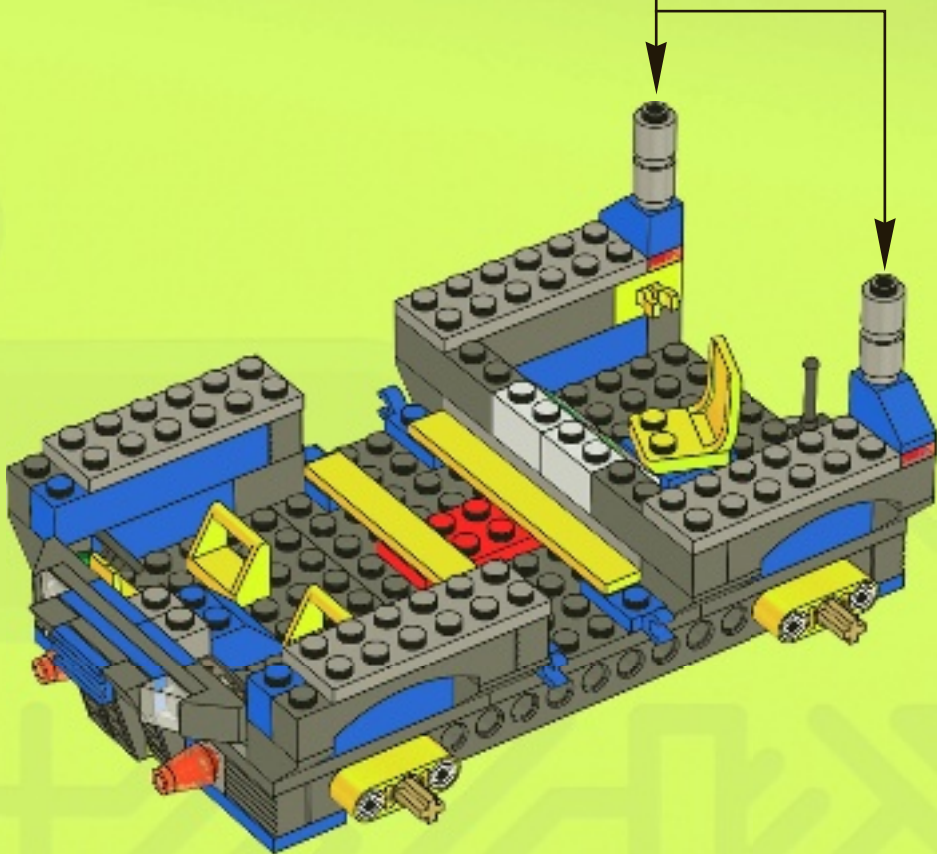



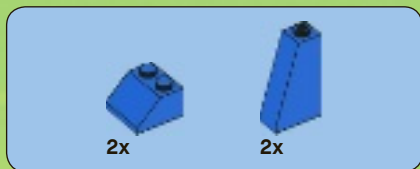

27

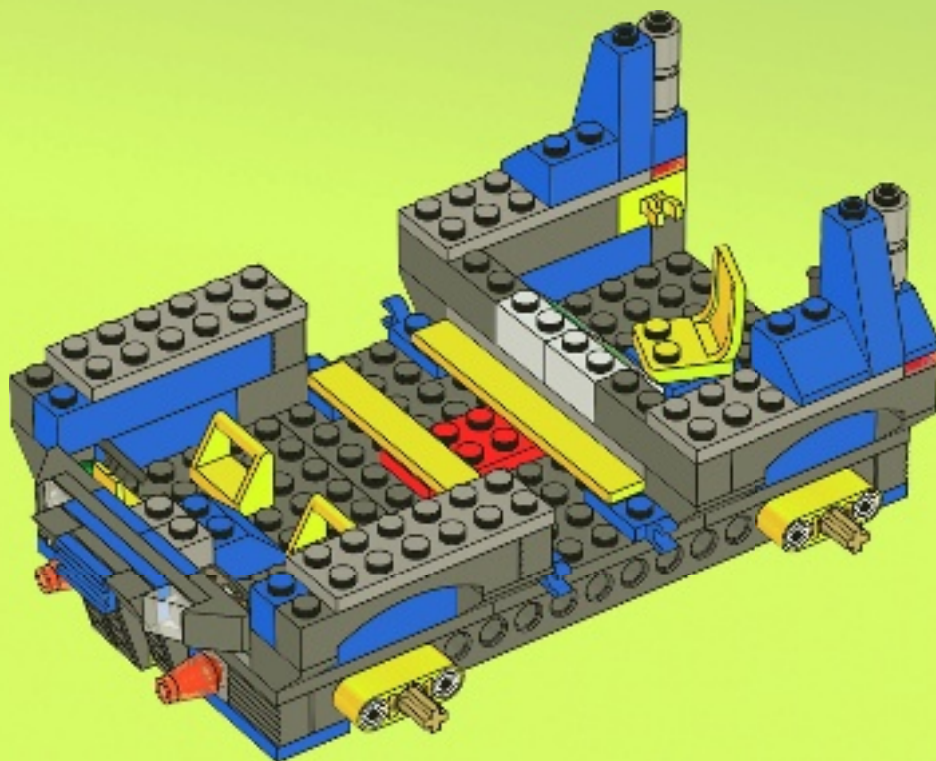



2x



2x

# 28

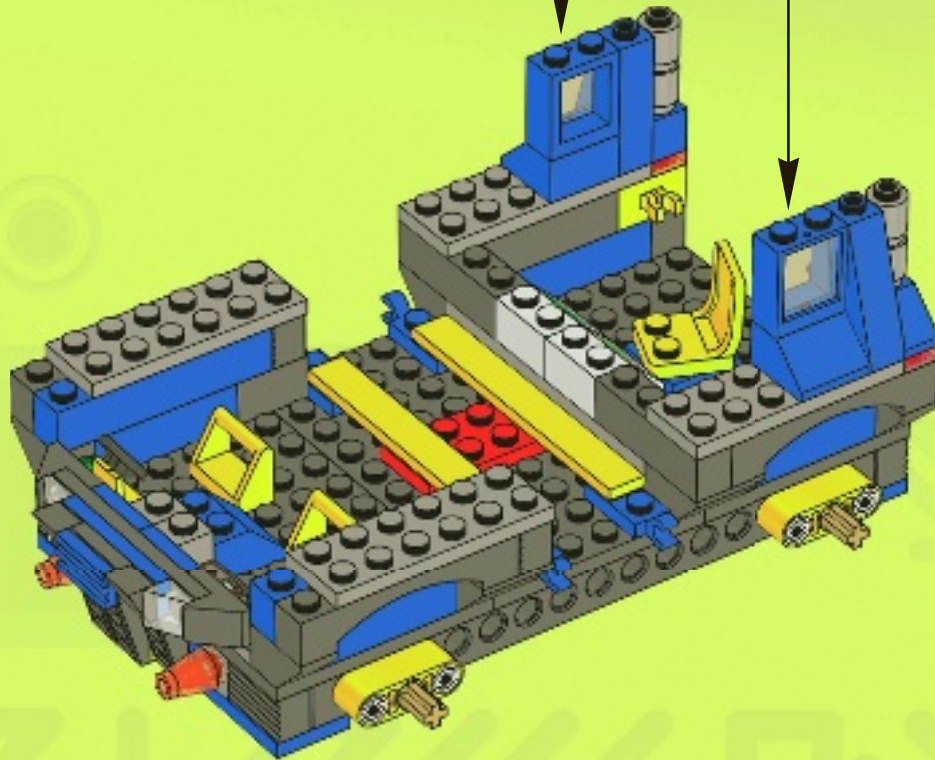
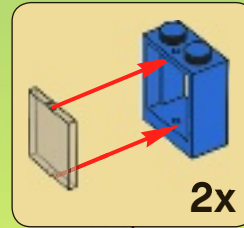



2x



2x

# 29

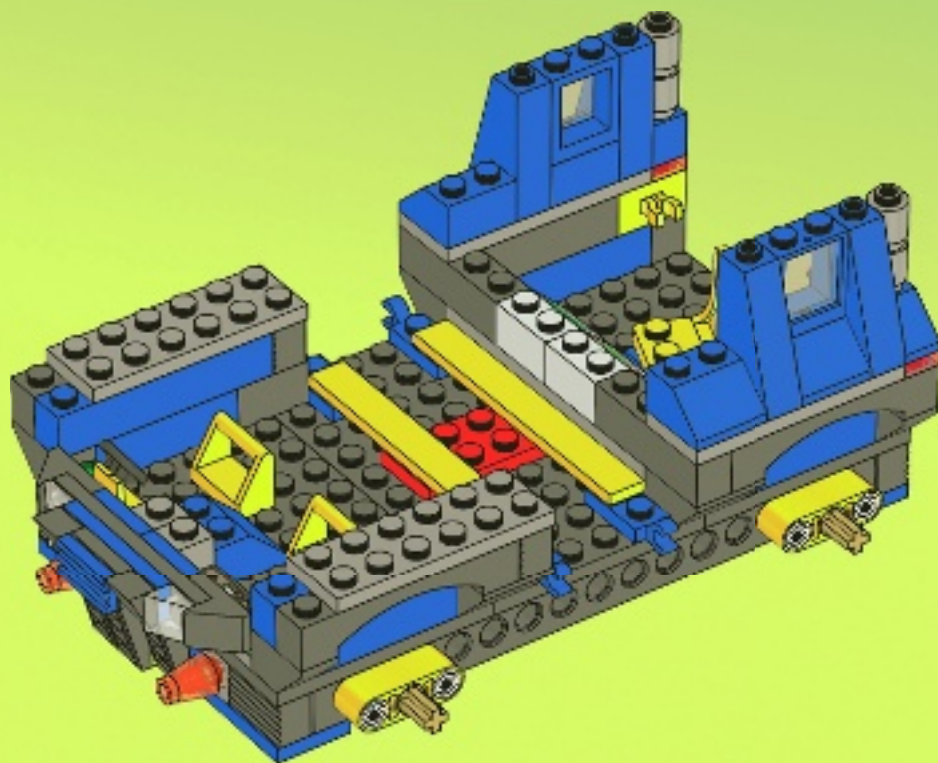

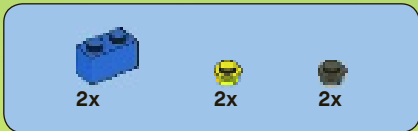

# 30

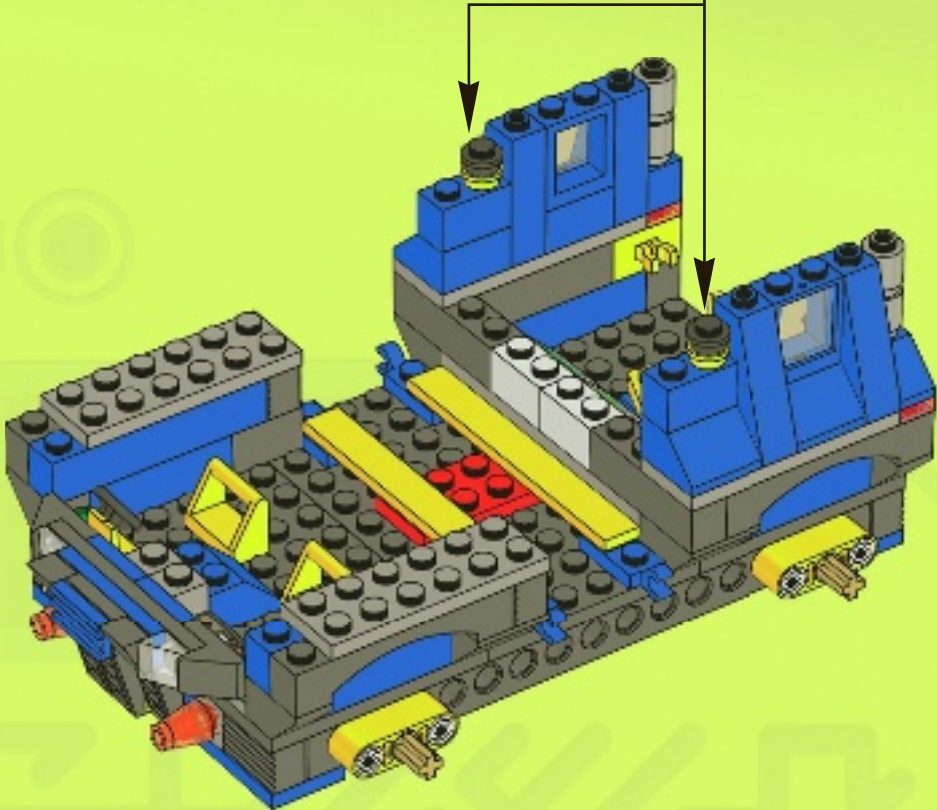





2x

# 31

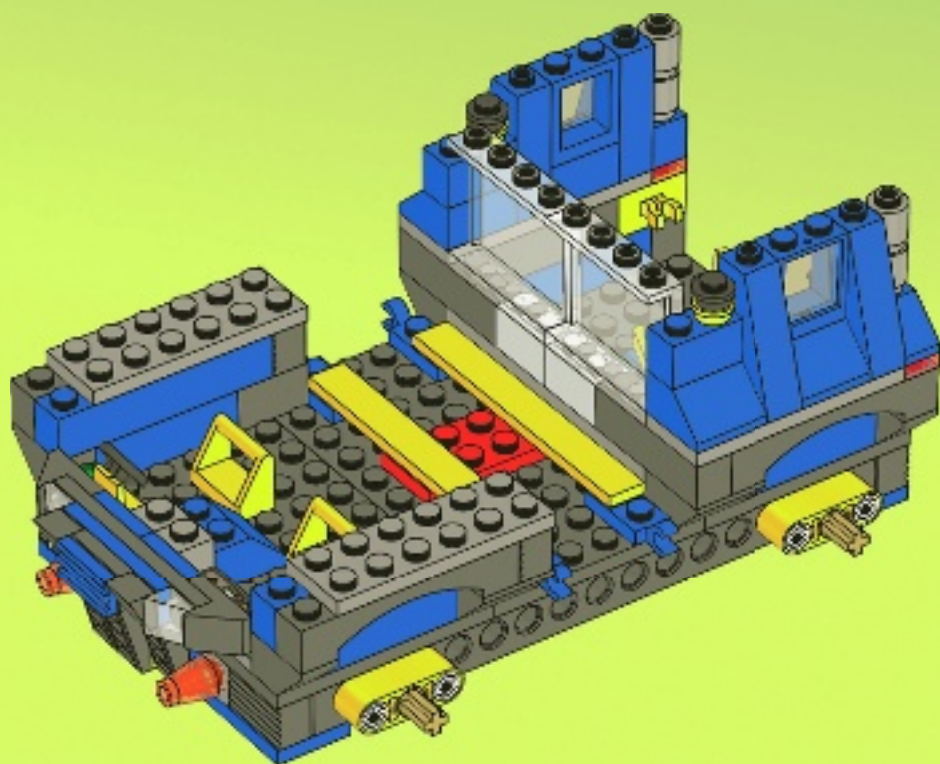



2x



1x

# 32

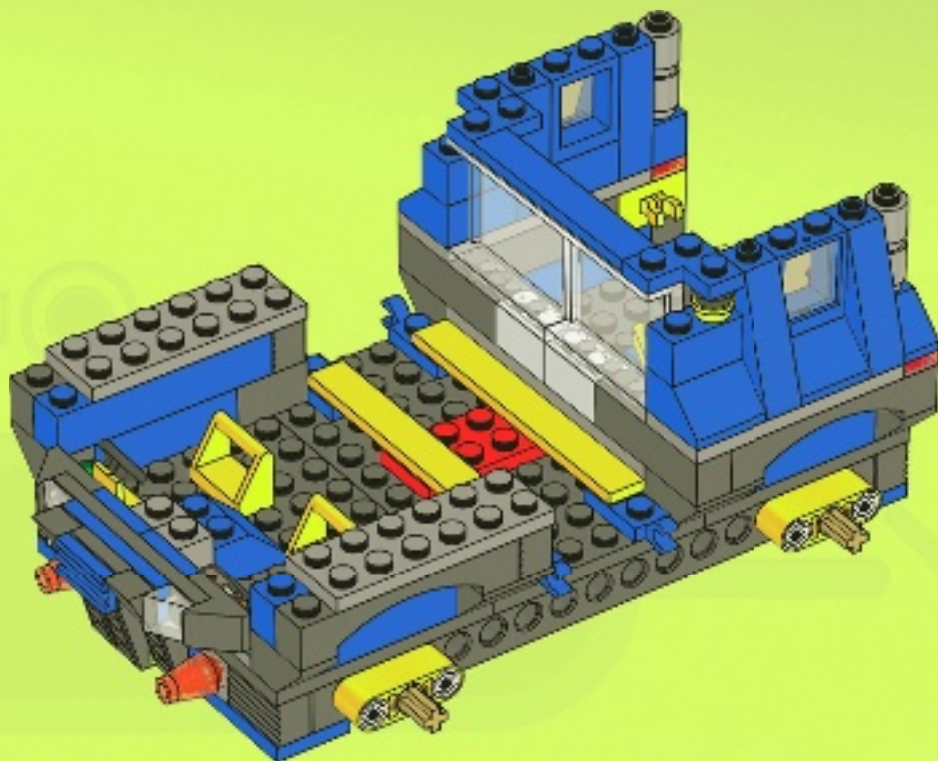



# 33

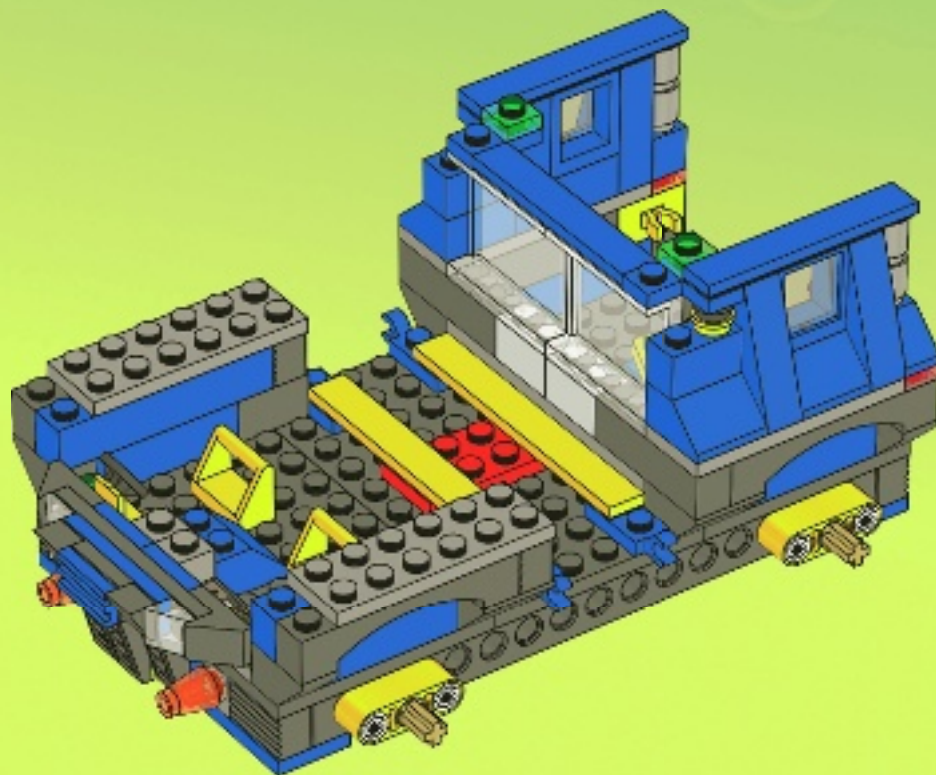

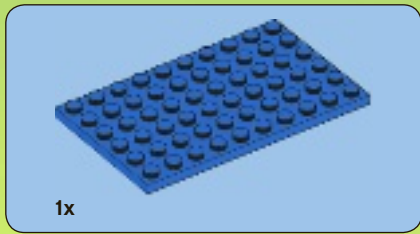

1

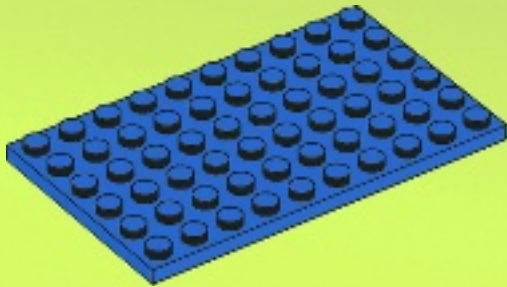

2

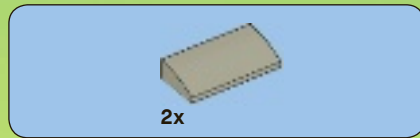
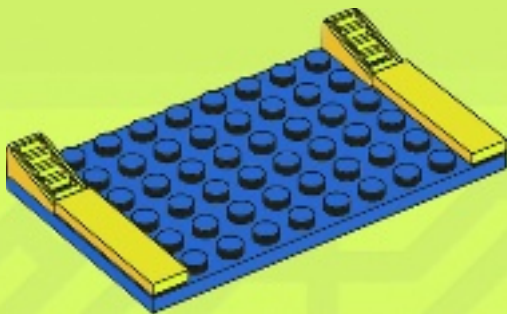

3

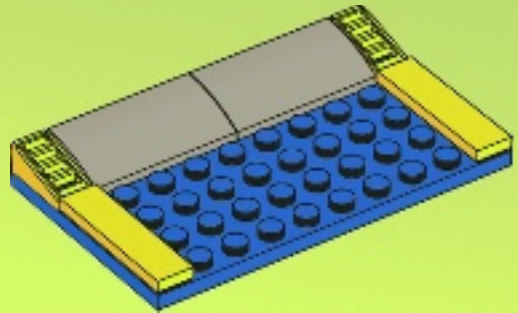

4

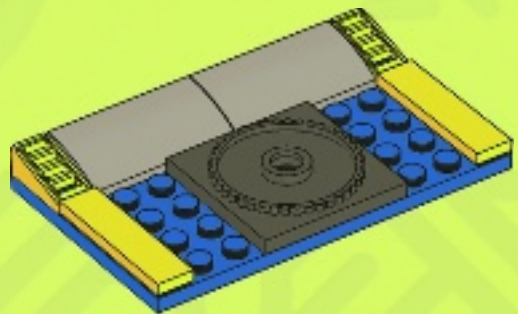



34

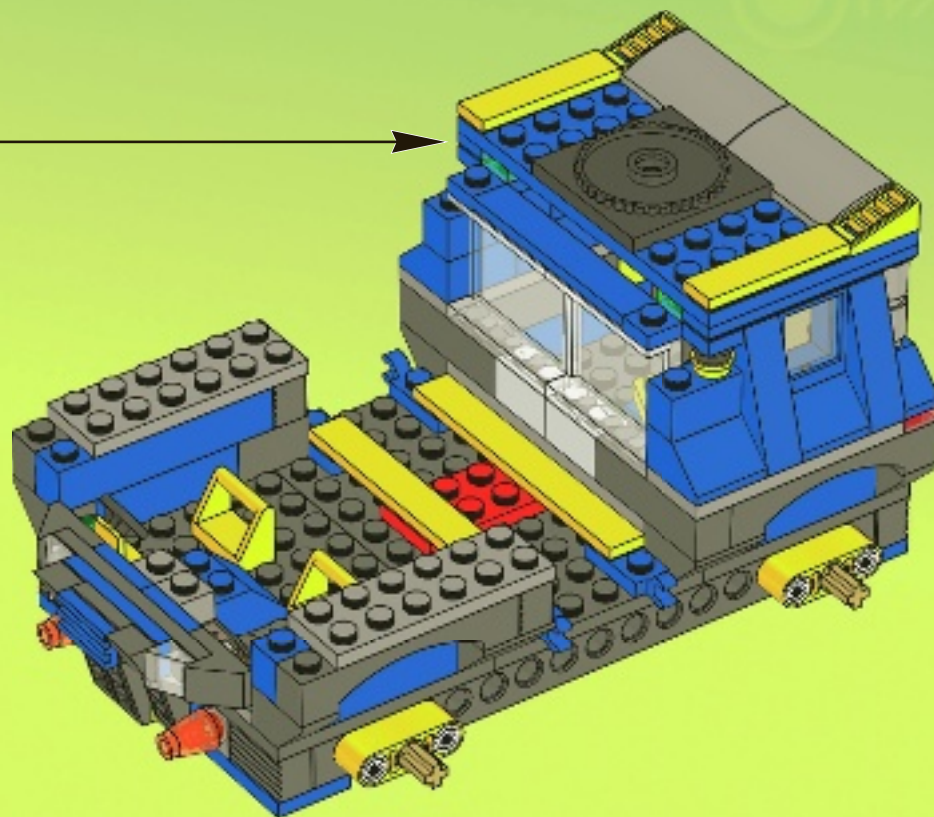

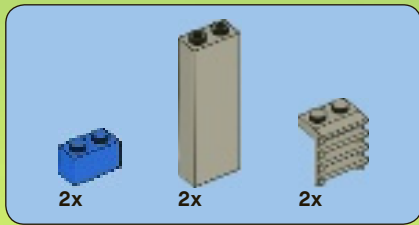

35

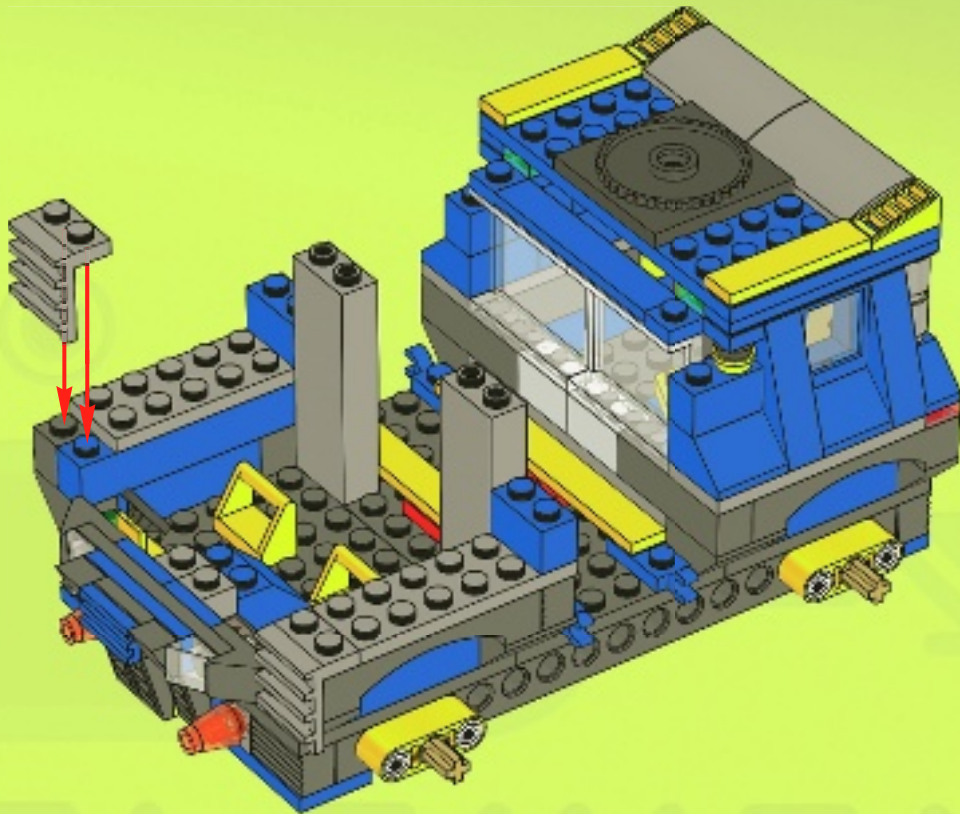

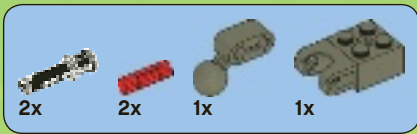

36

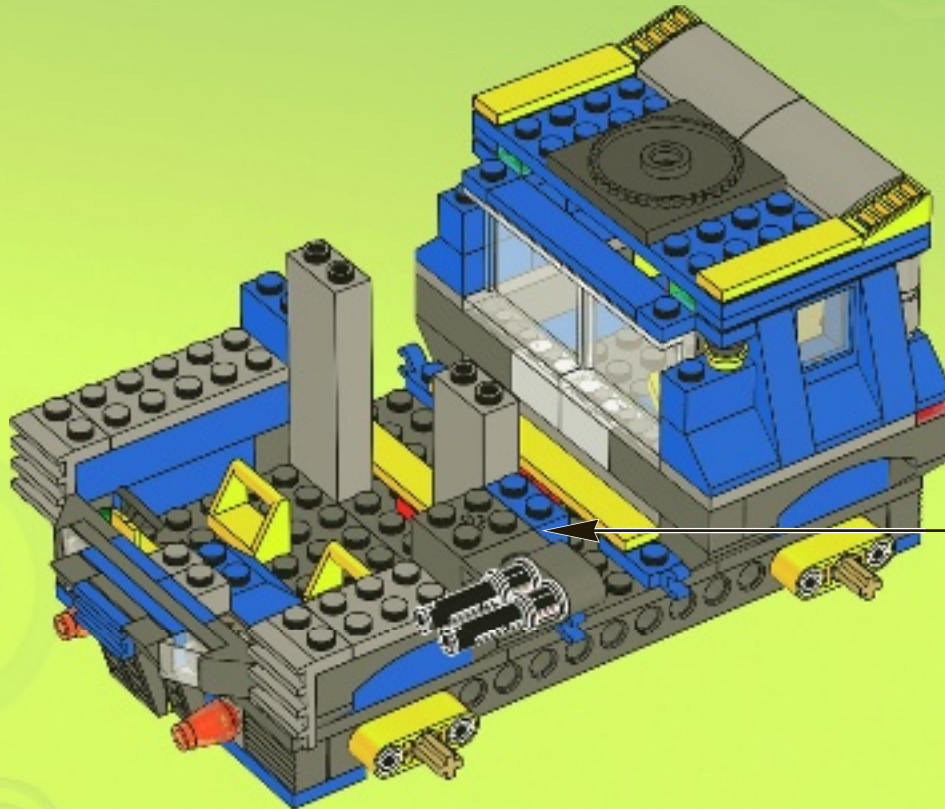
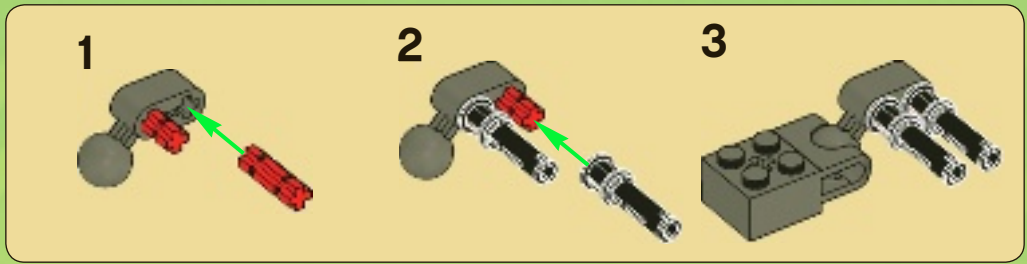



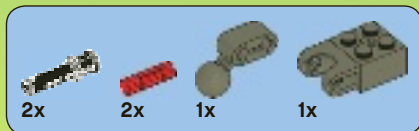

# 37

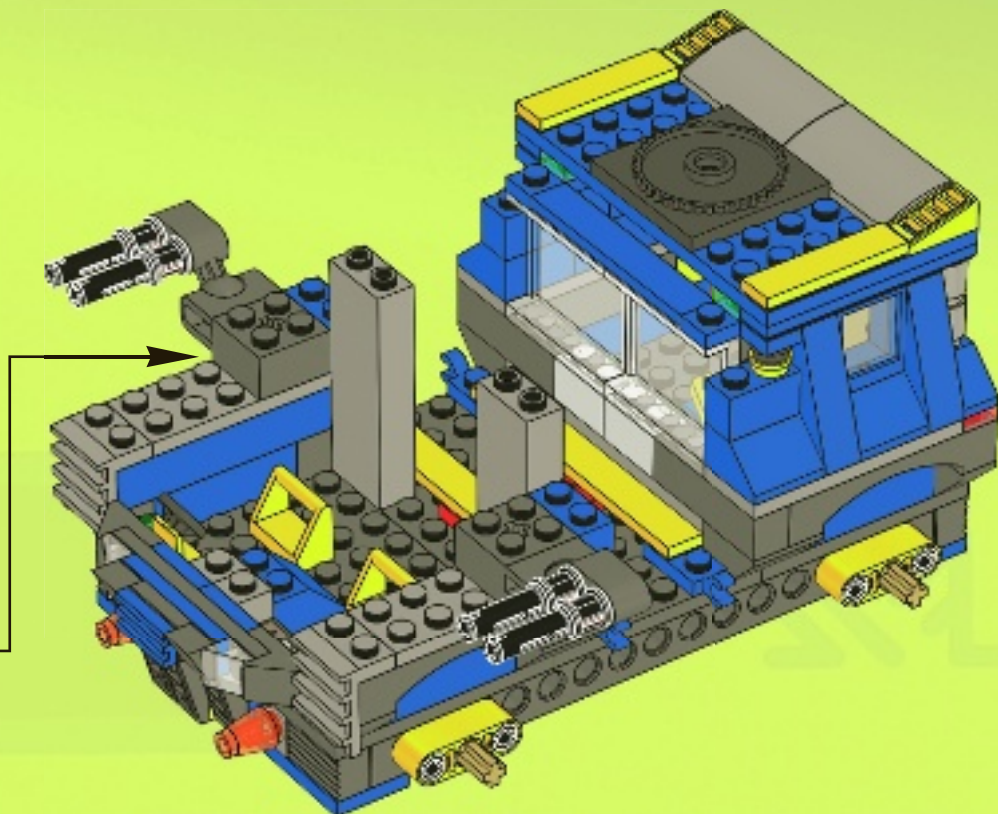
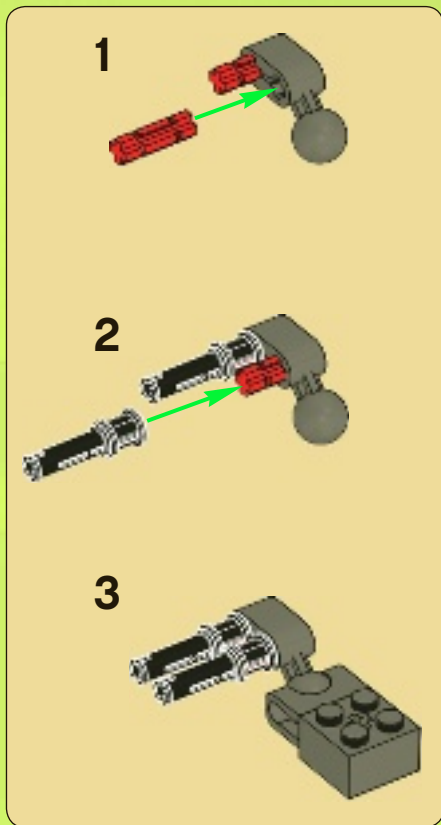





# 38

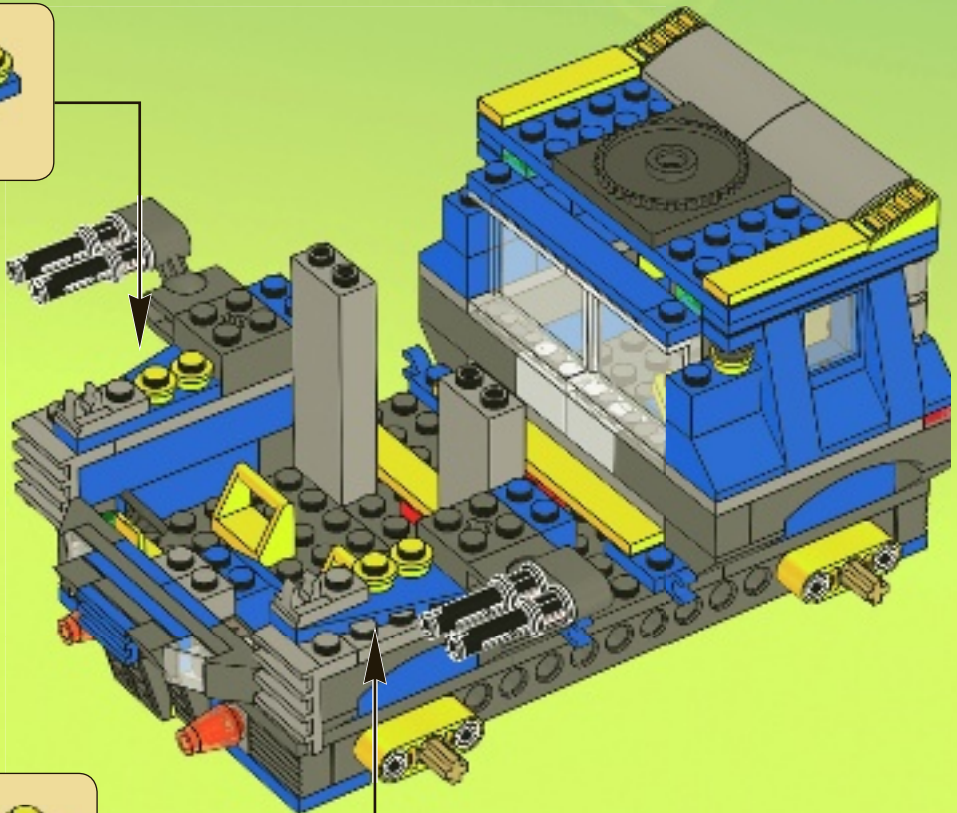



1x



1x

# 39

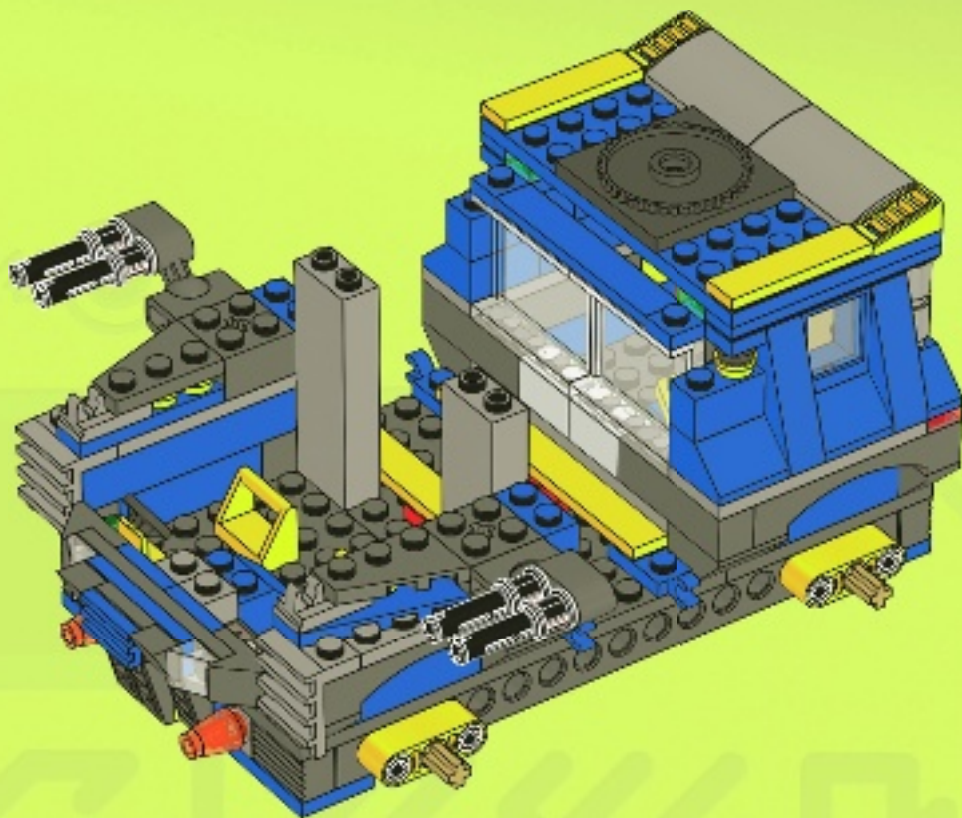



40

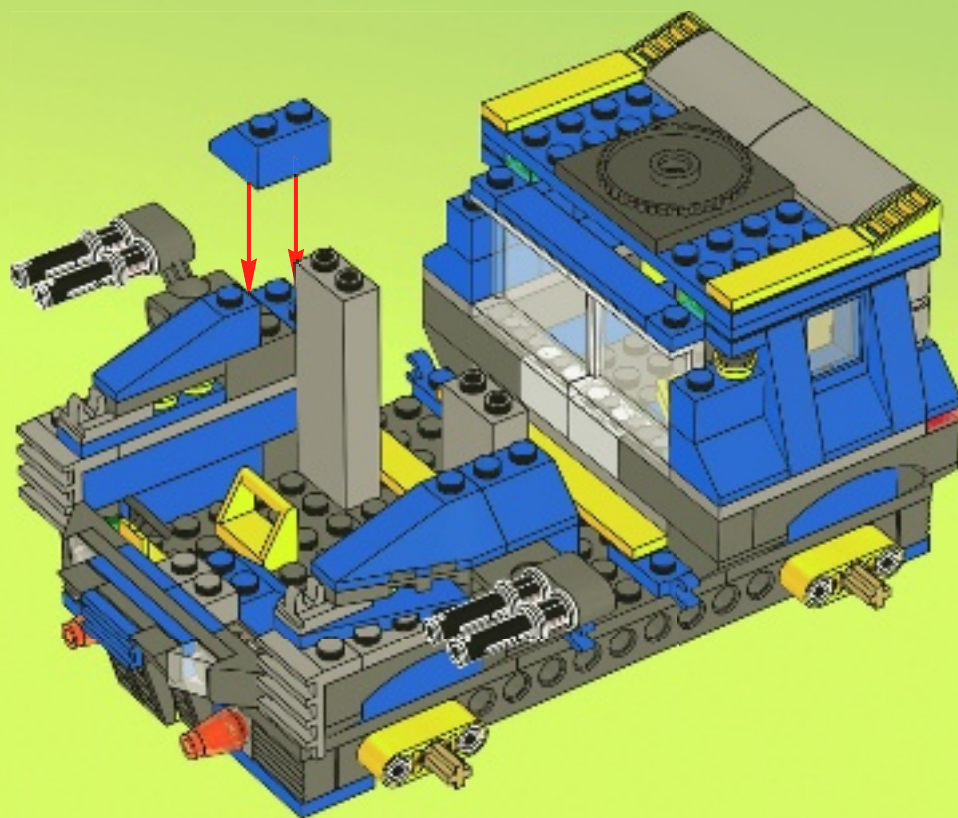



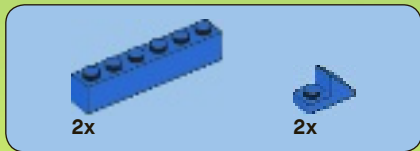

# 41

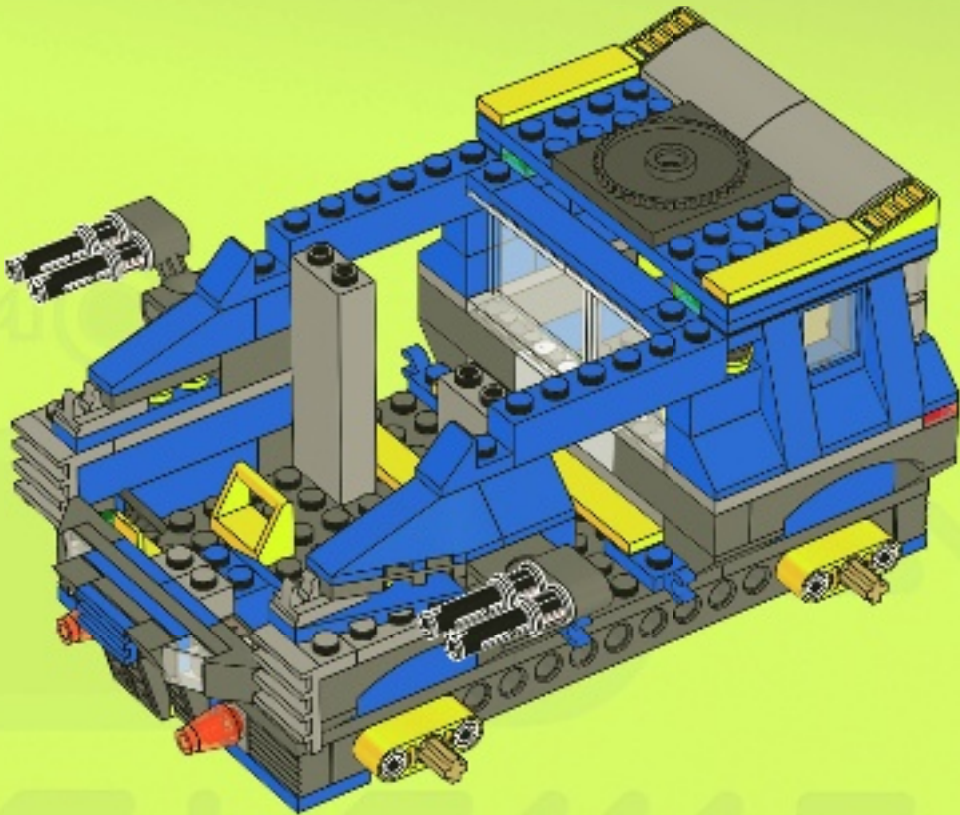





42

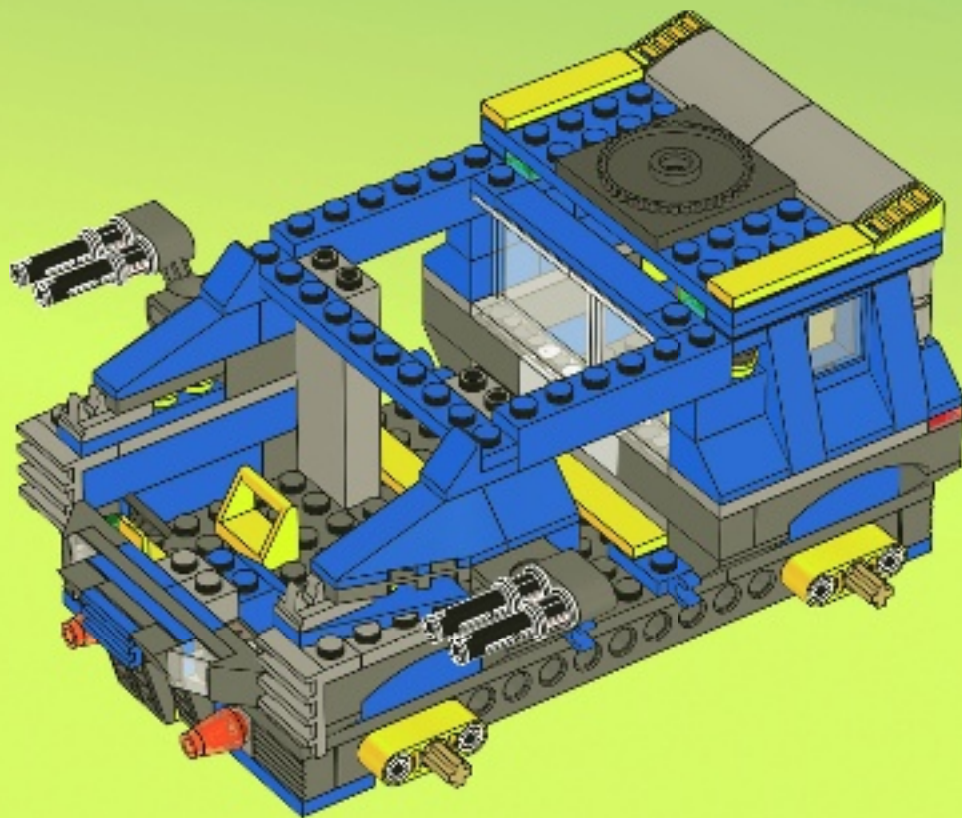



2x



1x



2x

# 43

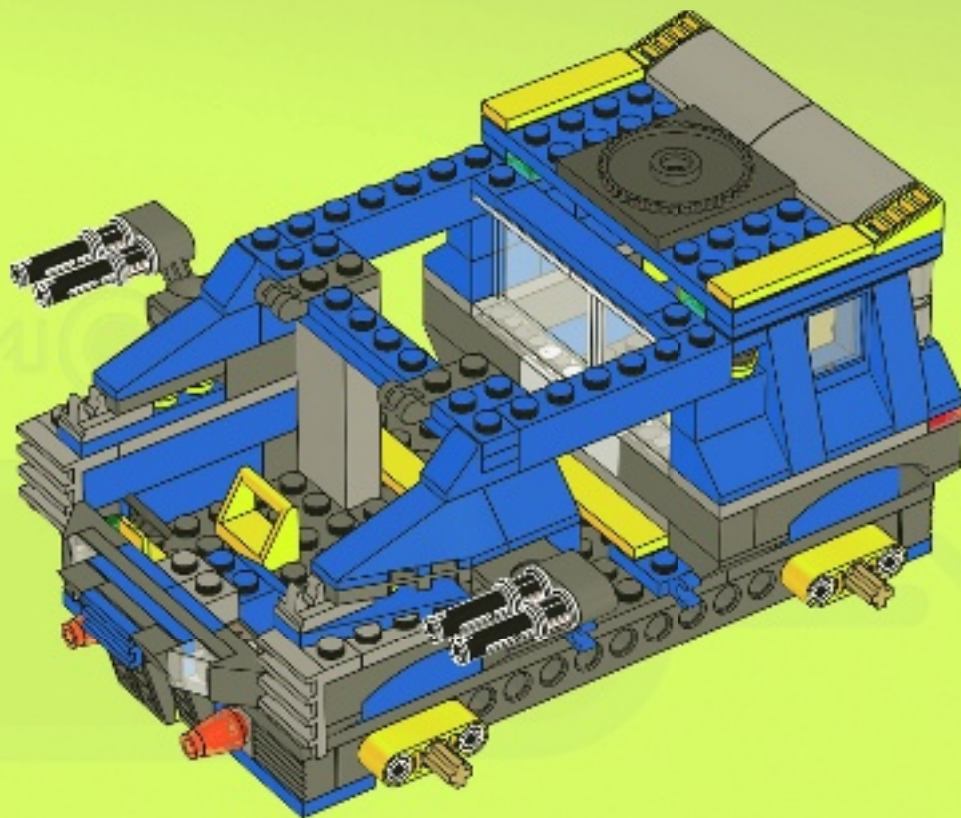

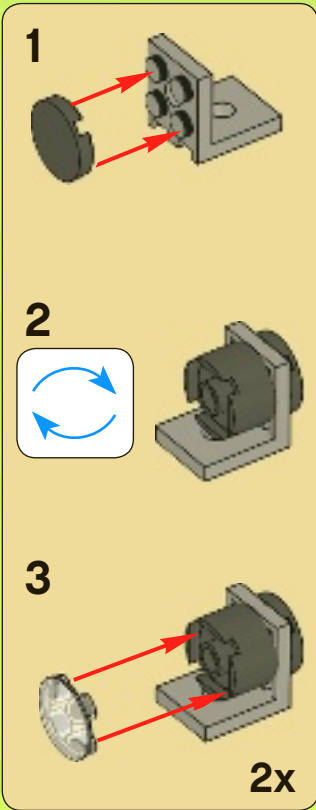
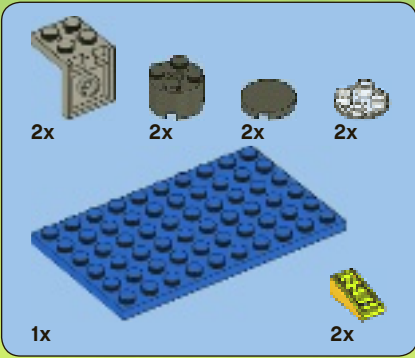

1

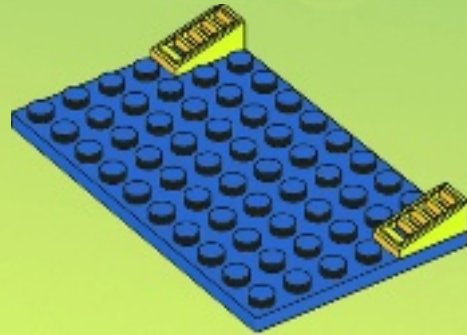

2

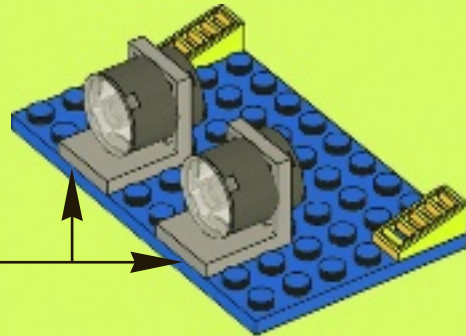

44

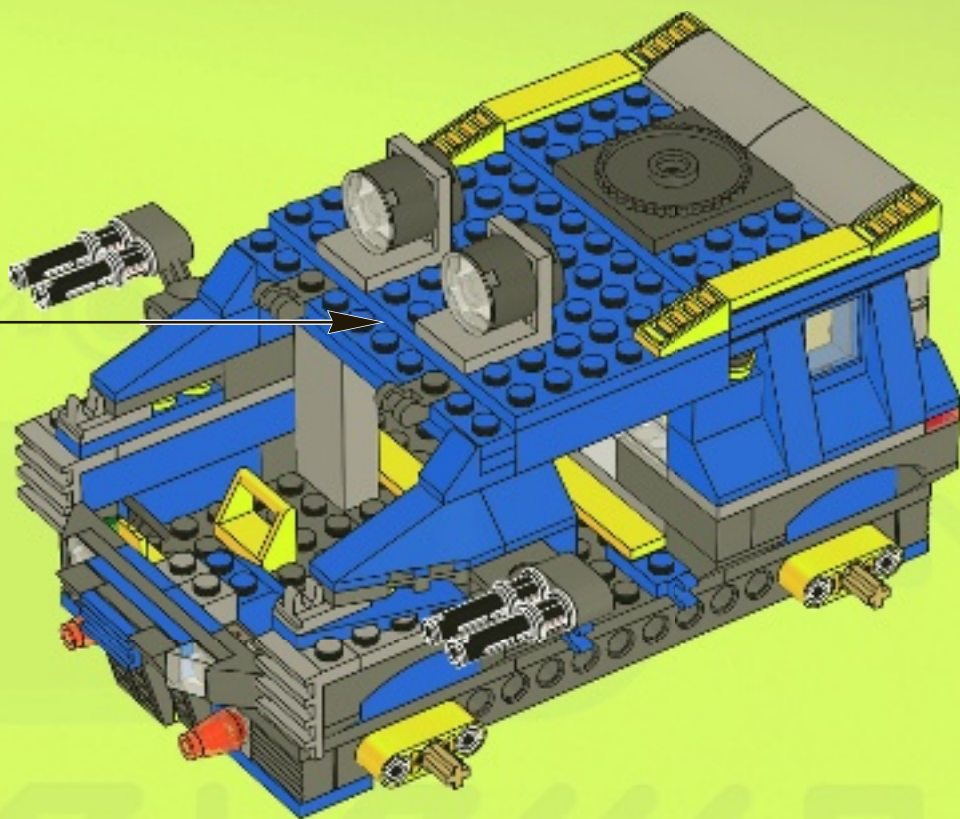



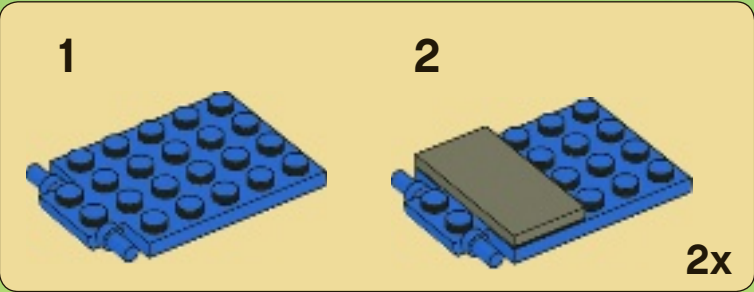
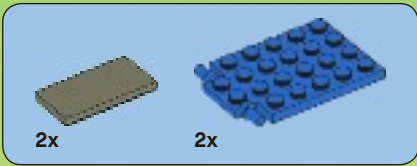

45

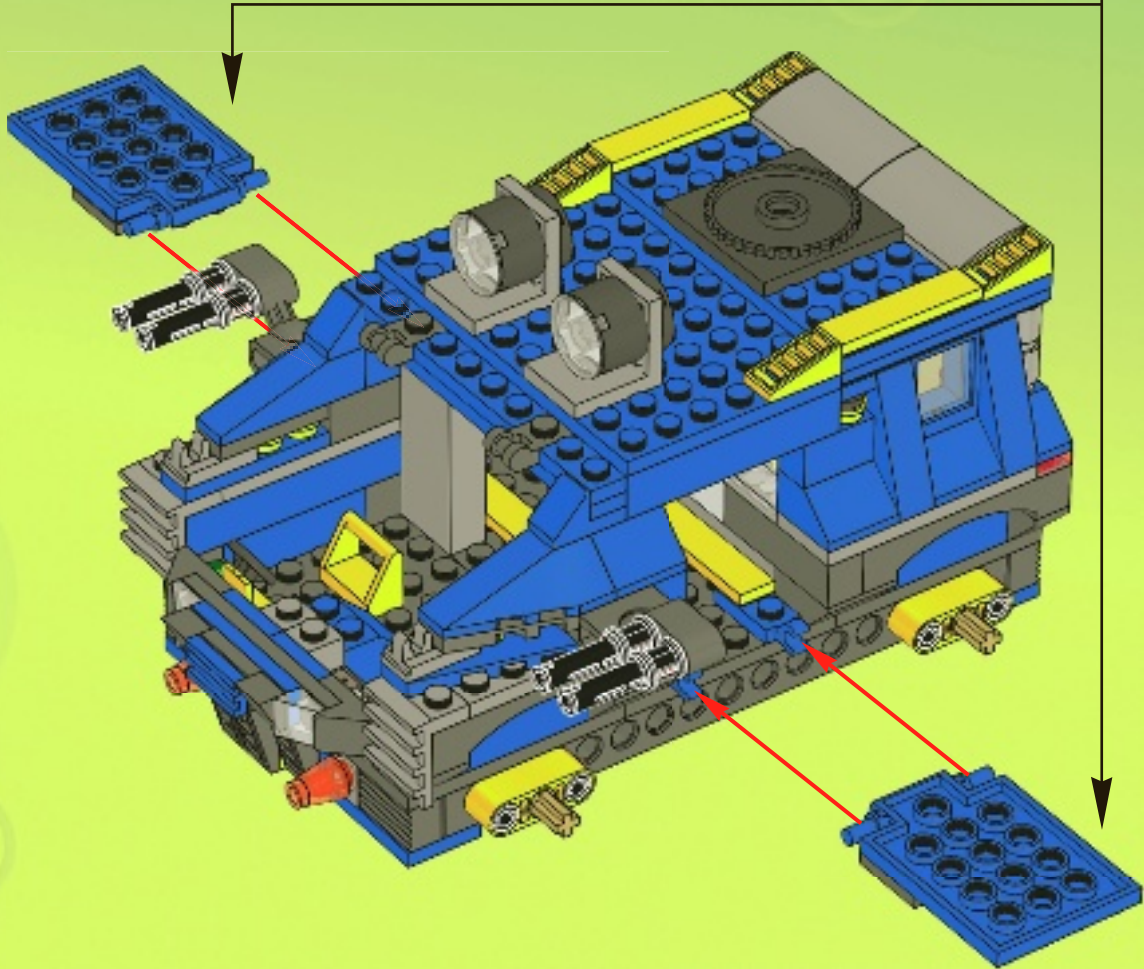

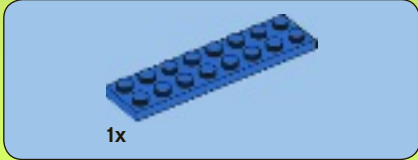

1



2

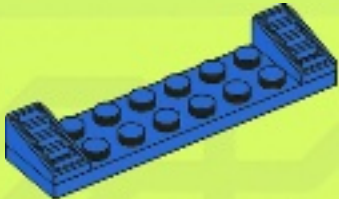

3

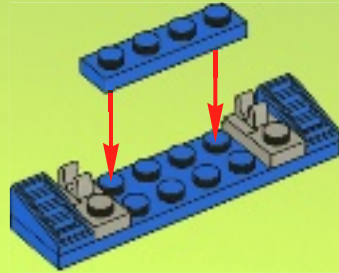

4

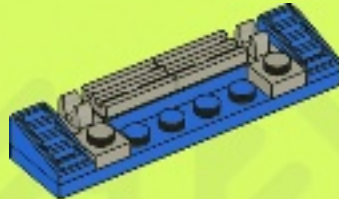



5

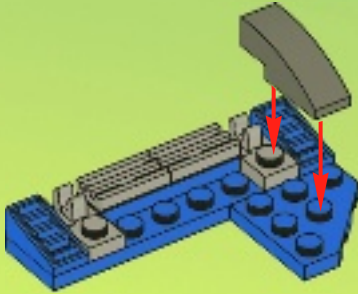

6

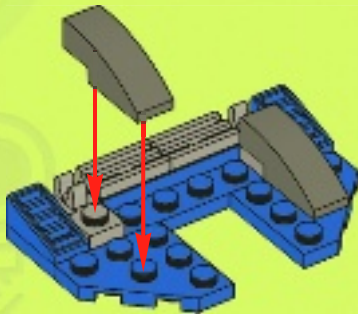

7

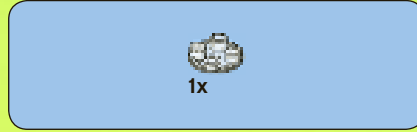
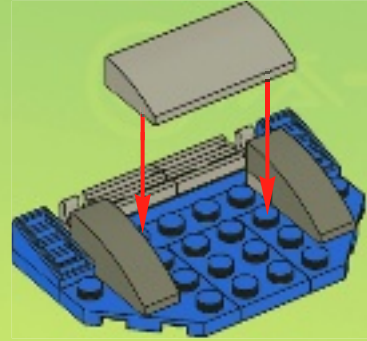

8

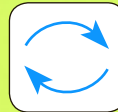



9

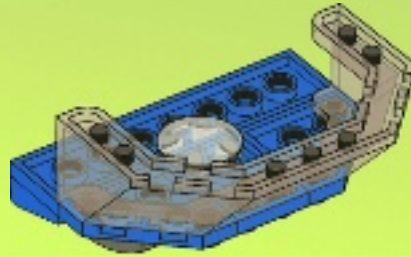

10

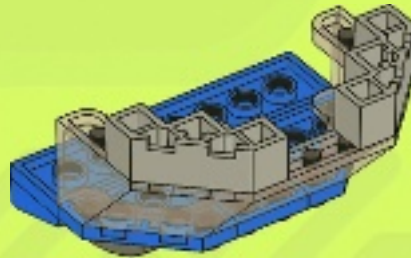



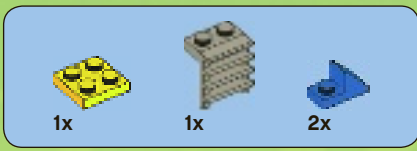

11

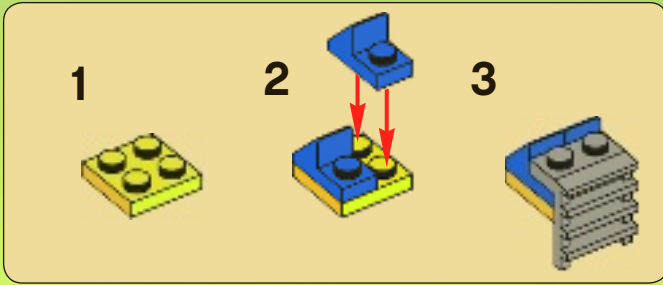
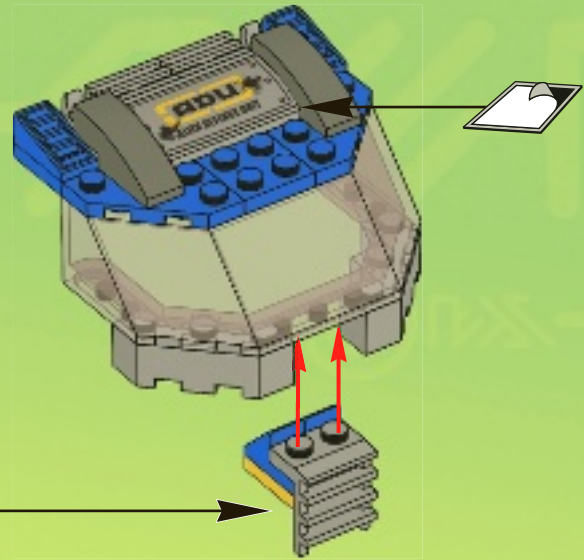

46

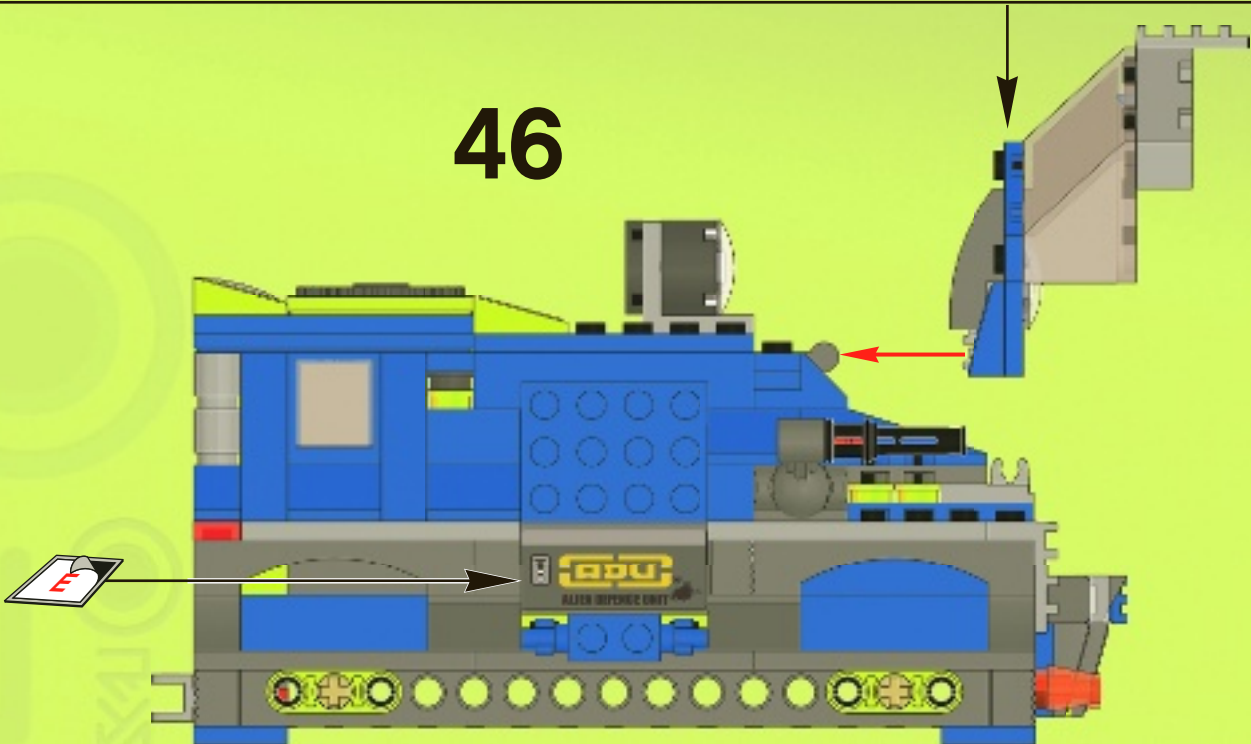

4x  2x 

# 47

1  2 

1  2 

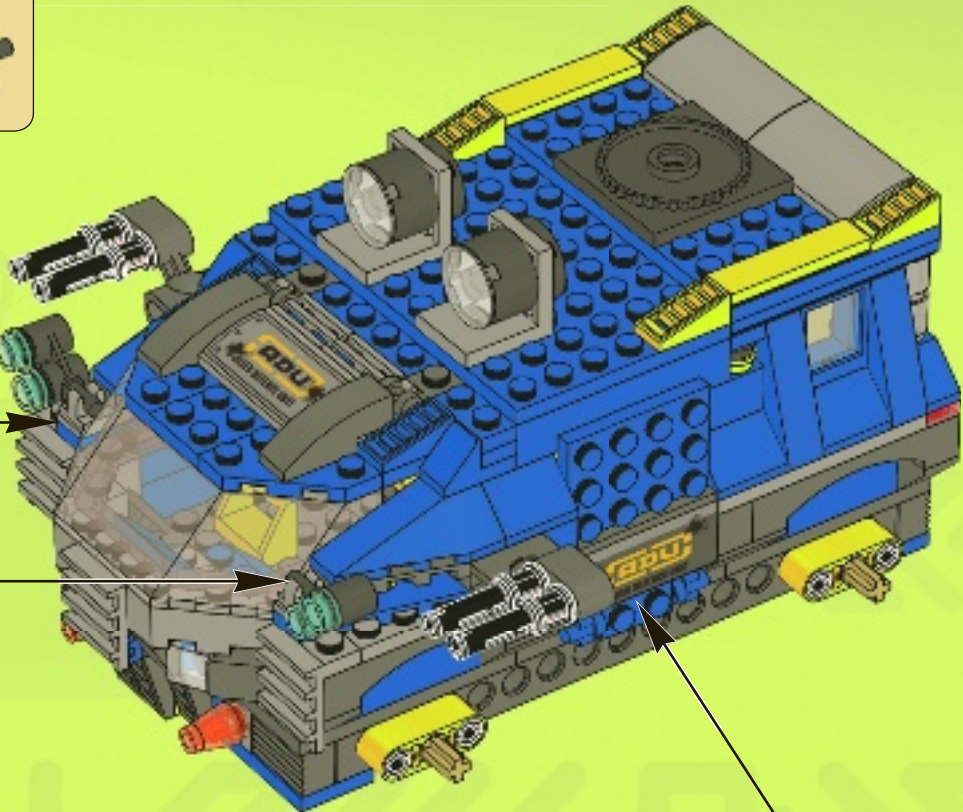

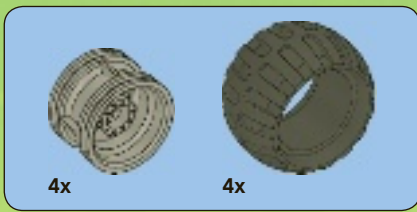

48

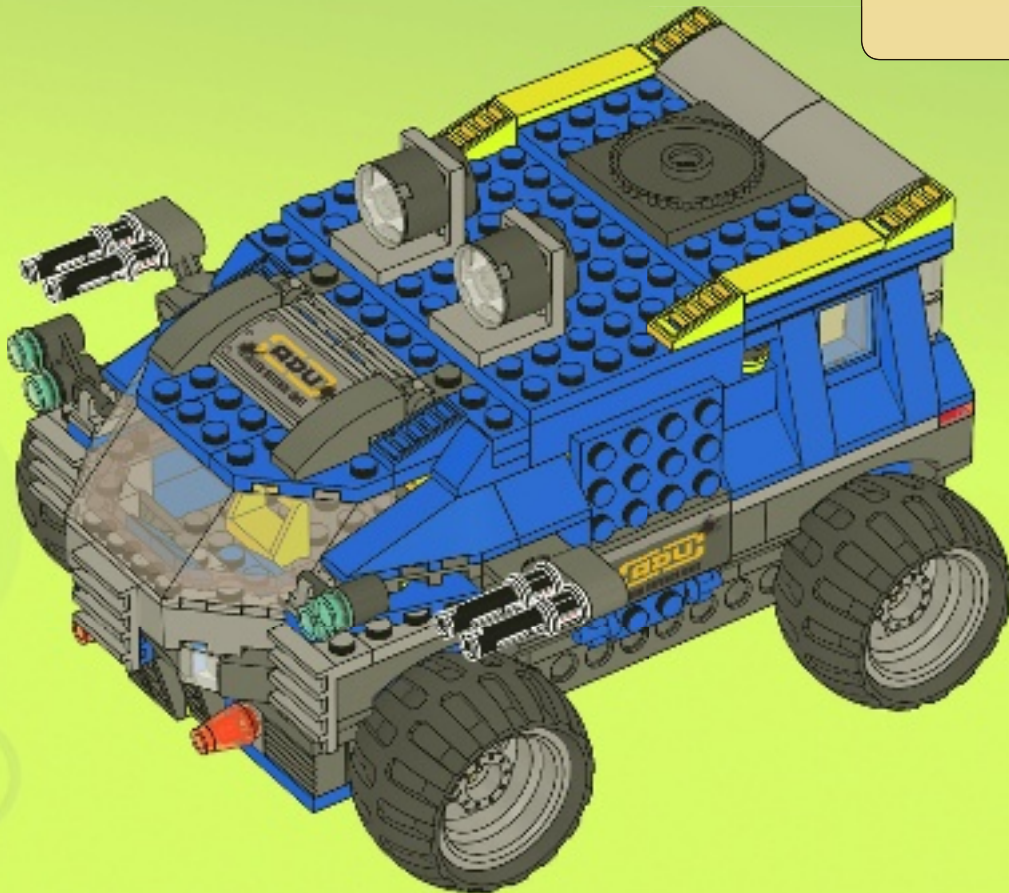
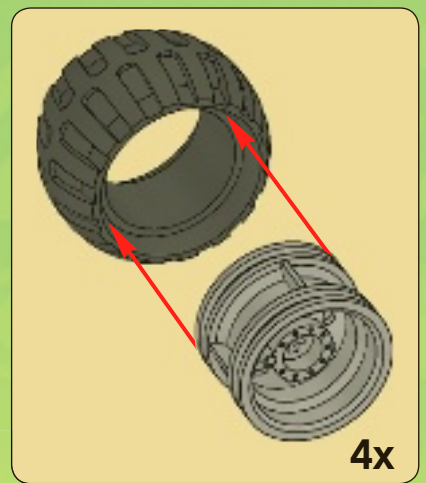



The LEGO logo is positioned in the top left corner, featuring the word "LEGO" in white, bold, sans-serif font with a black outline, set against a red square background.

# ALIEN CONQUEST



www.LEGO.com

LEGO and the LEGO logo are trademarks of the/sont des marques de commerce de/son marcas registradas de LEGO Group.©2011 The LEGO Group. 4645673 / 4645674

# ALIENCONQUEST.LEGO.COM







# ALIEN CONQUEST

7066



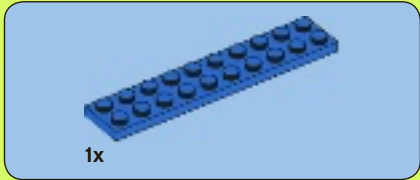
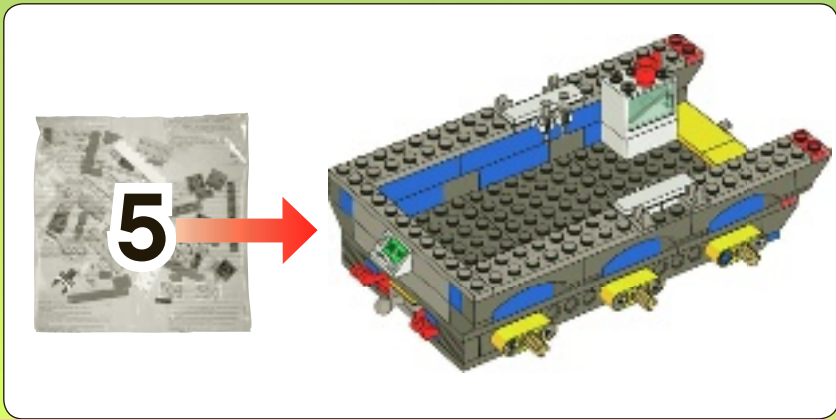

1



2

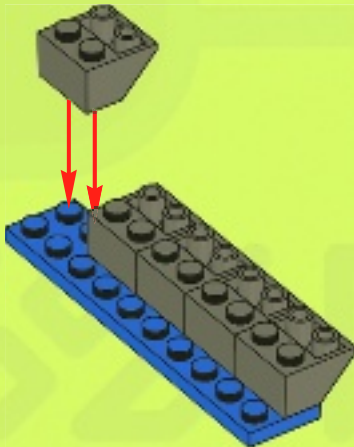

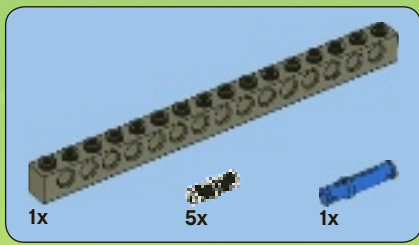

3

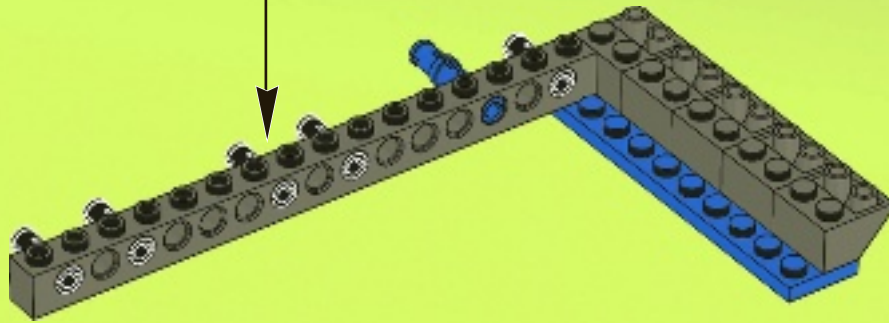
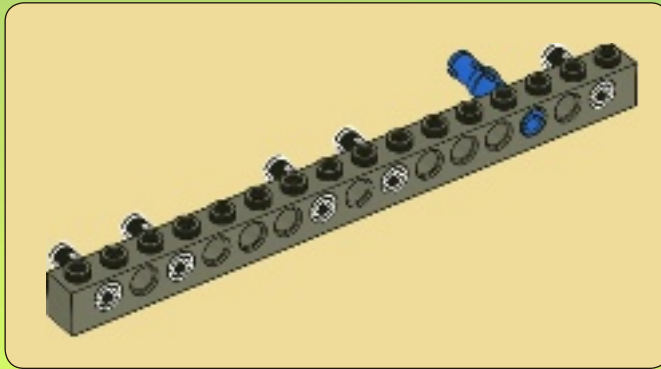



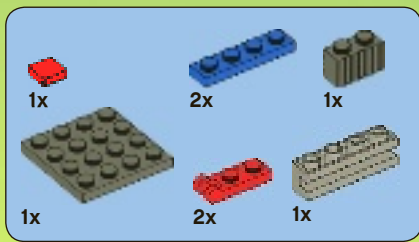

4

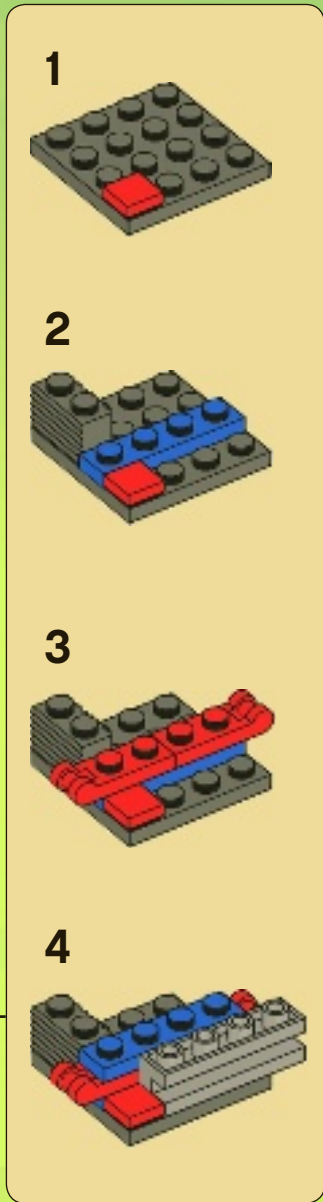
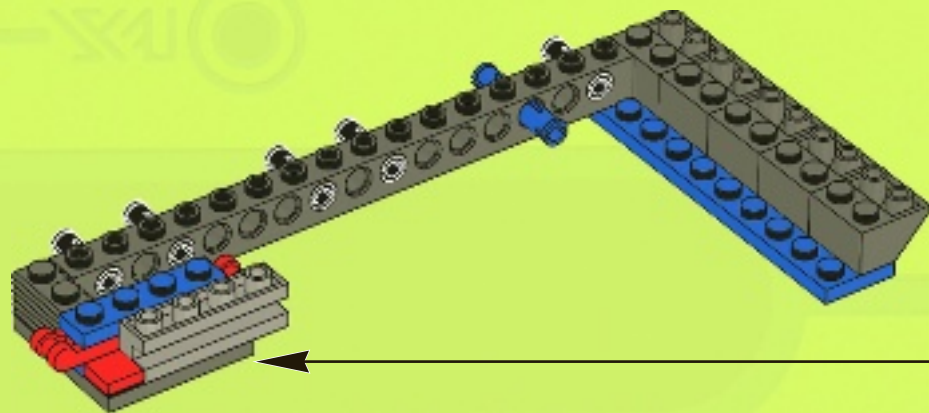



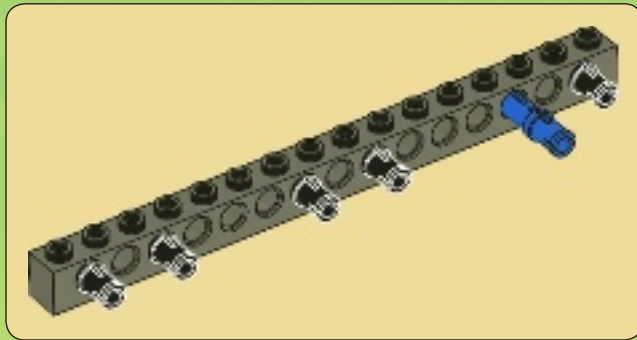
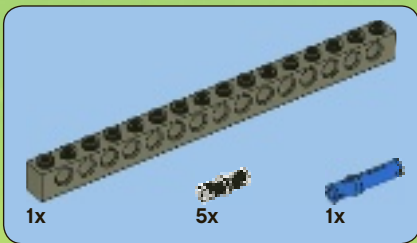

5

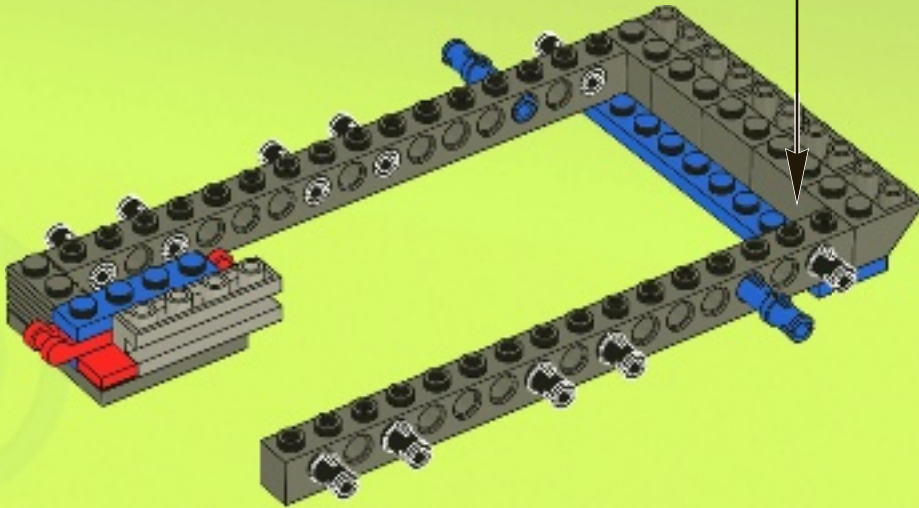

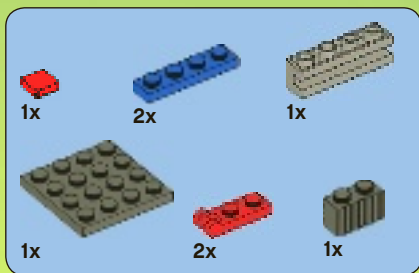

6

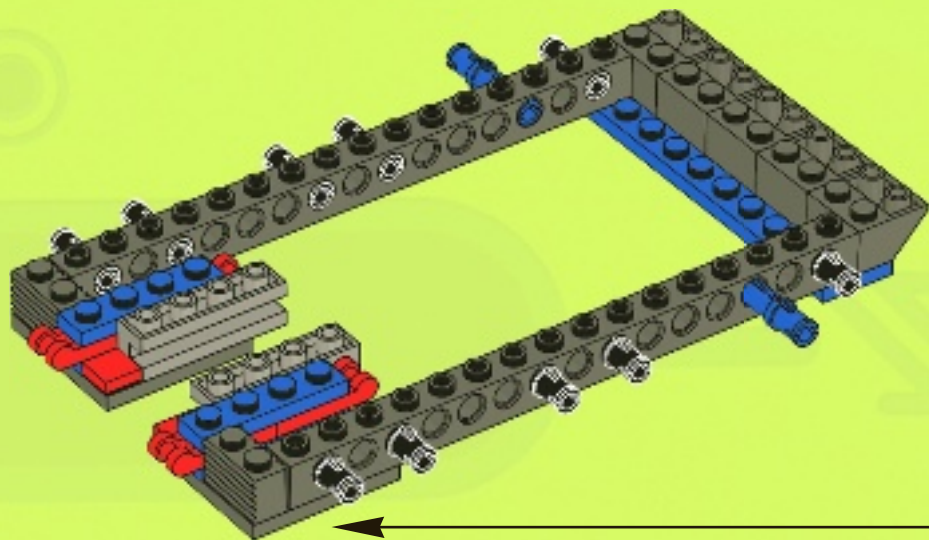
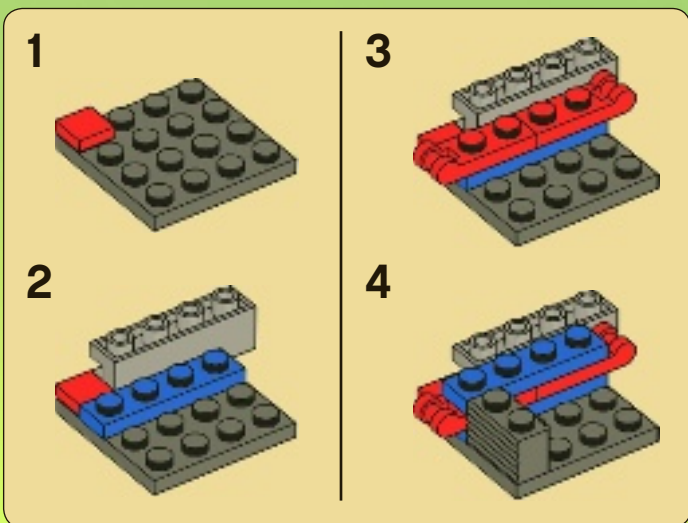

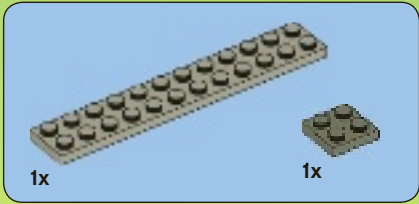
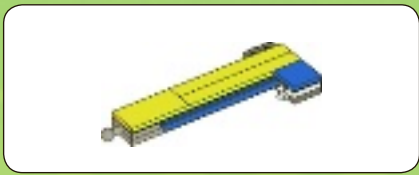

1

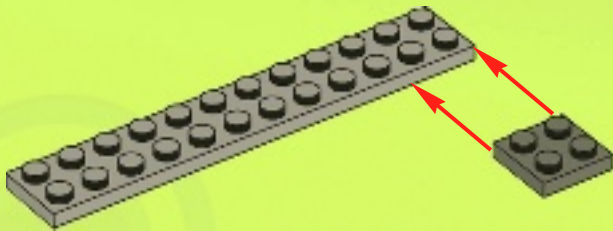

2

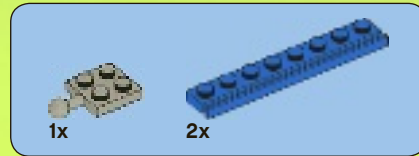
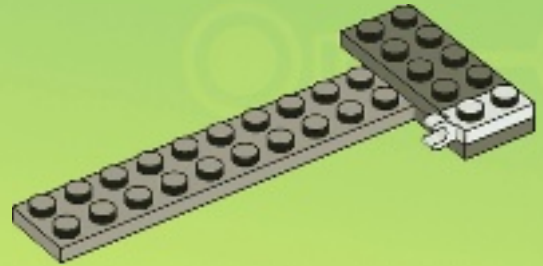

3

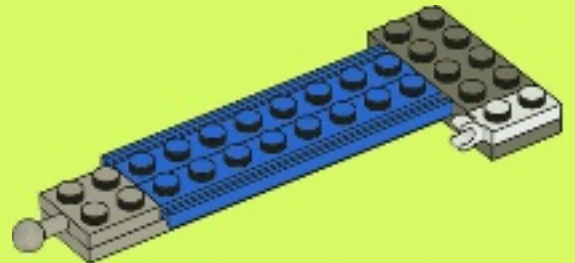

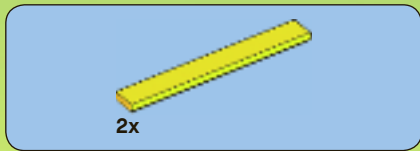

4

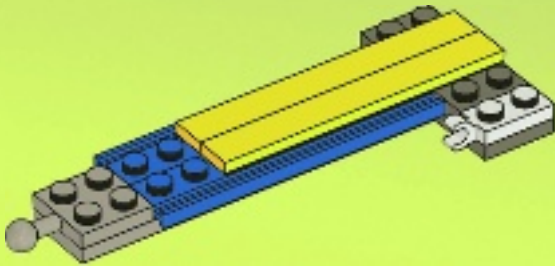

5

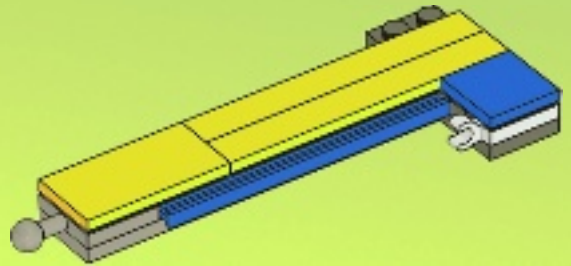

7

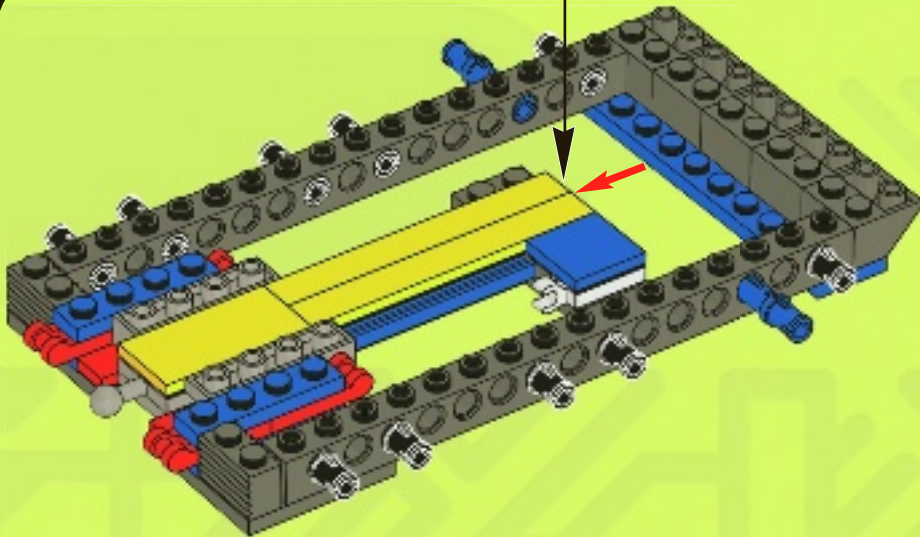





3x



4x

# 8

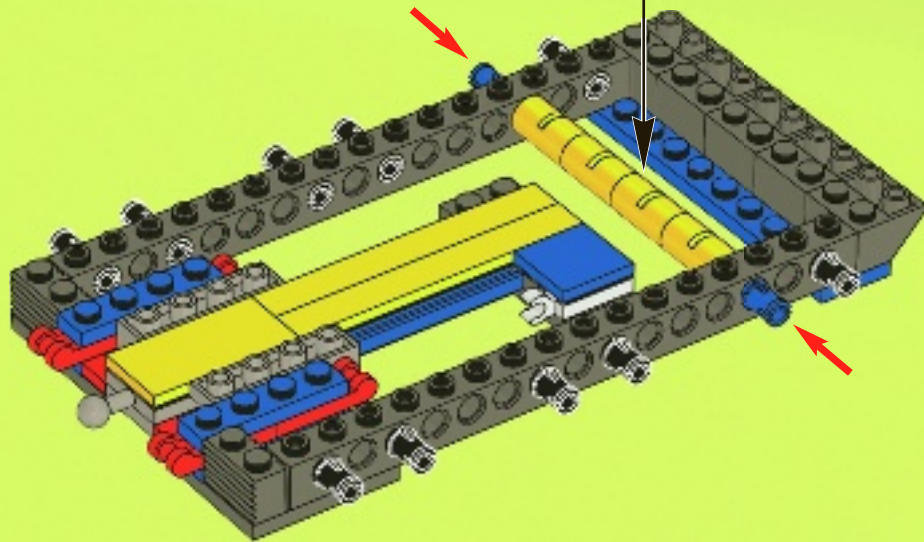
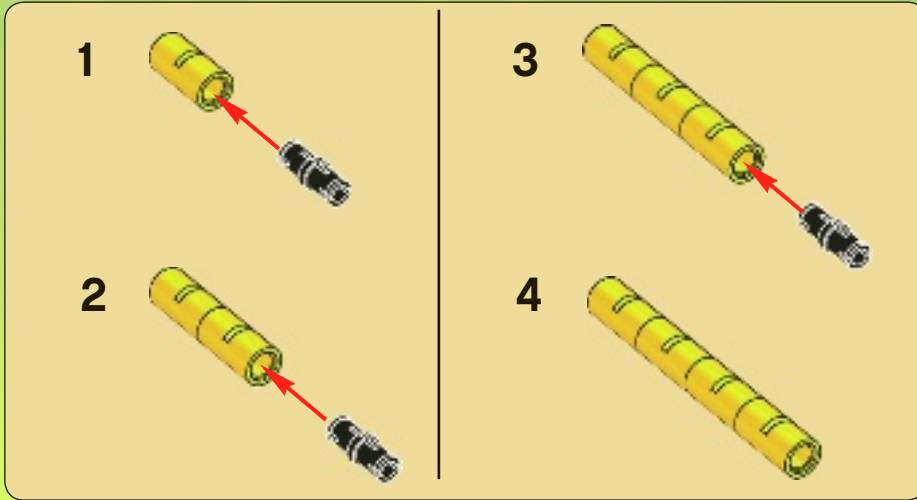

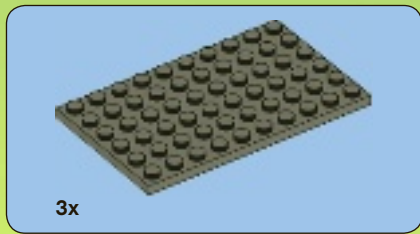

9

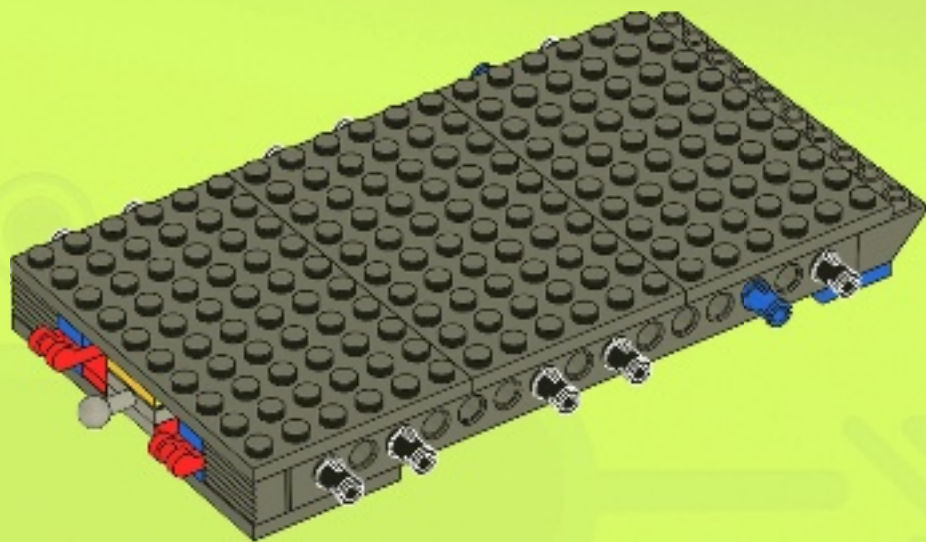



3x



2x



2x

# 10

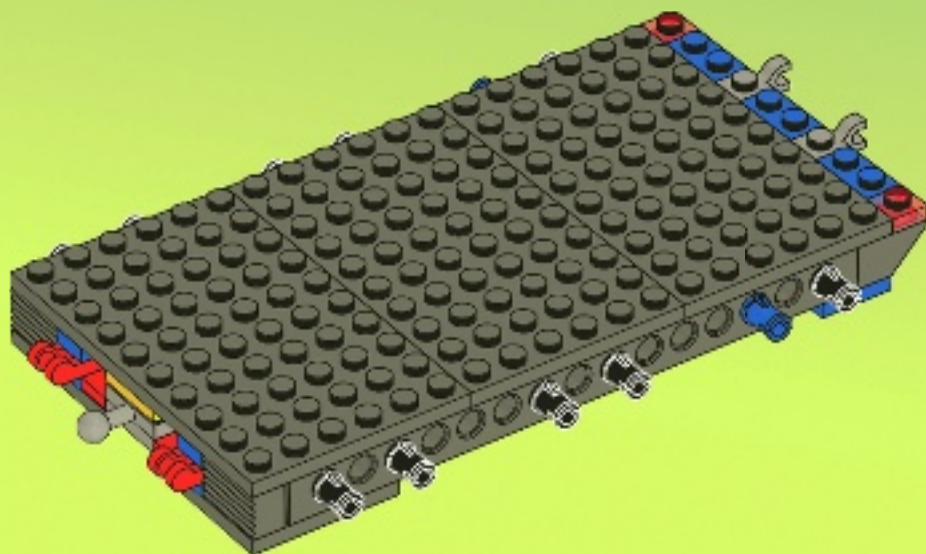



# 11

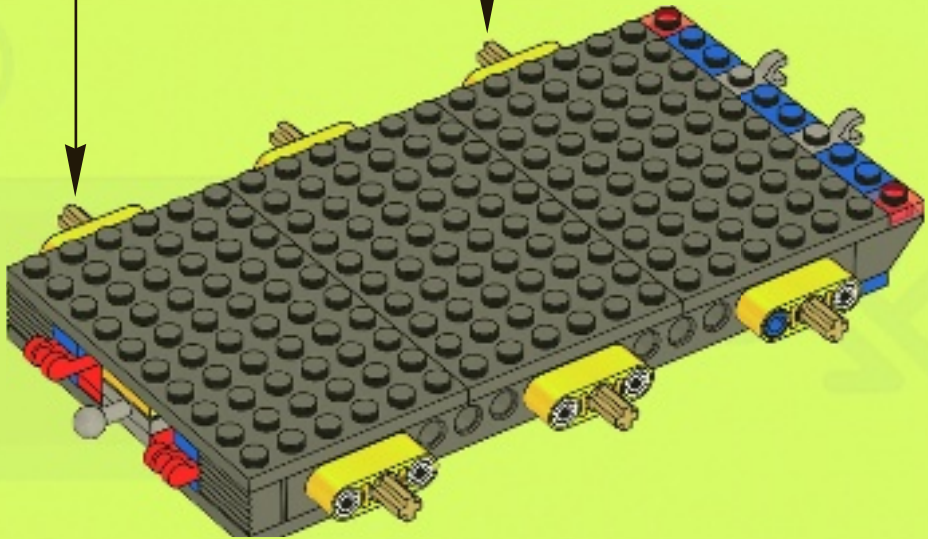
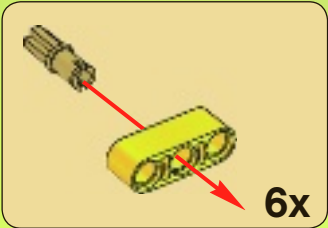



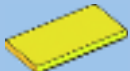

2x

12

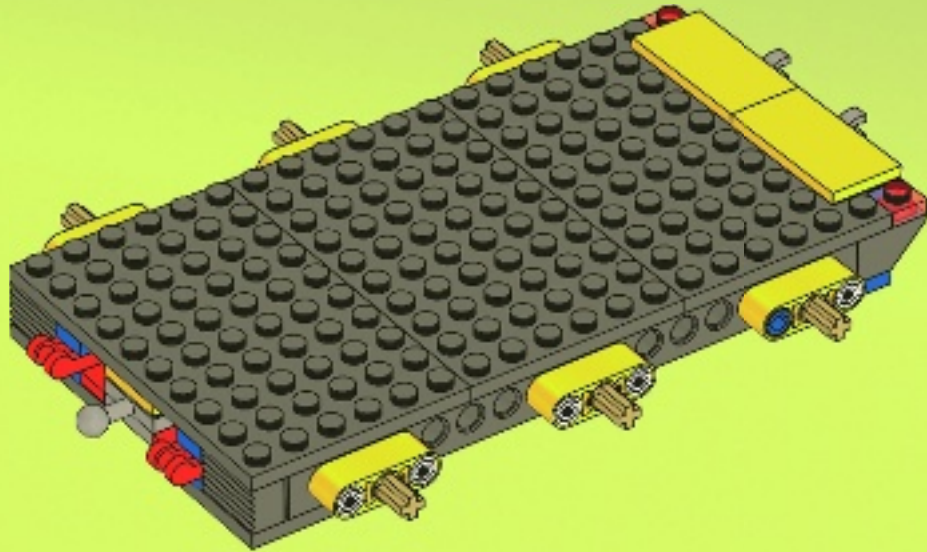



# 13

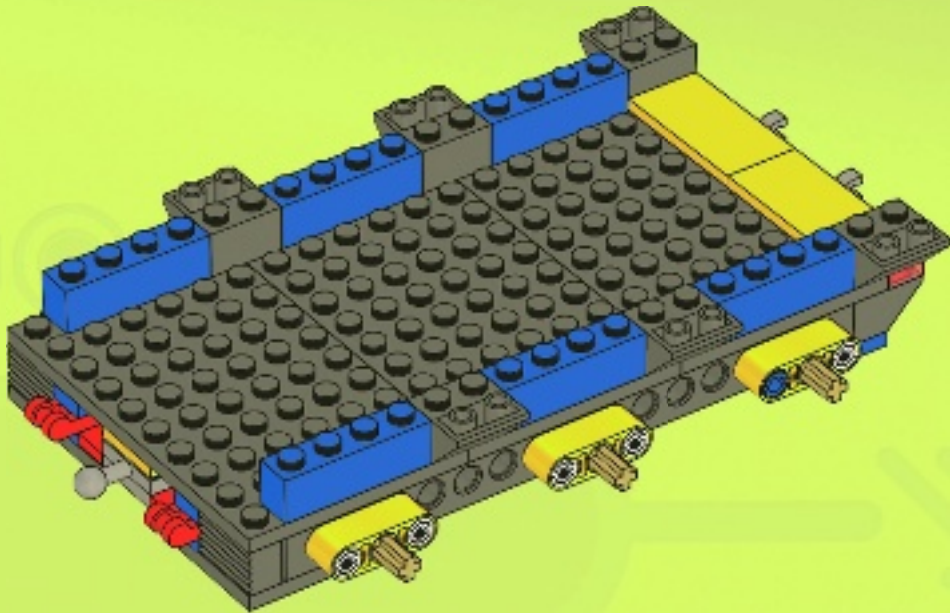

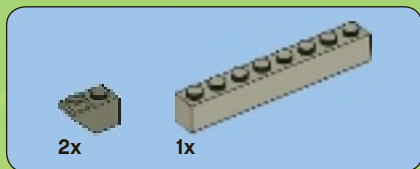

14

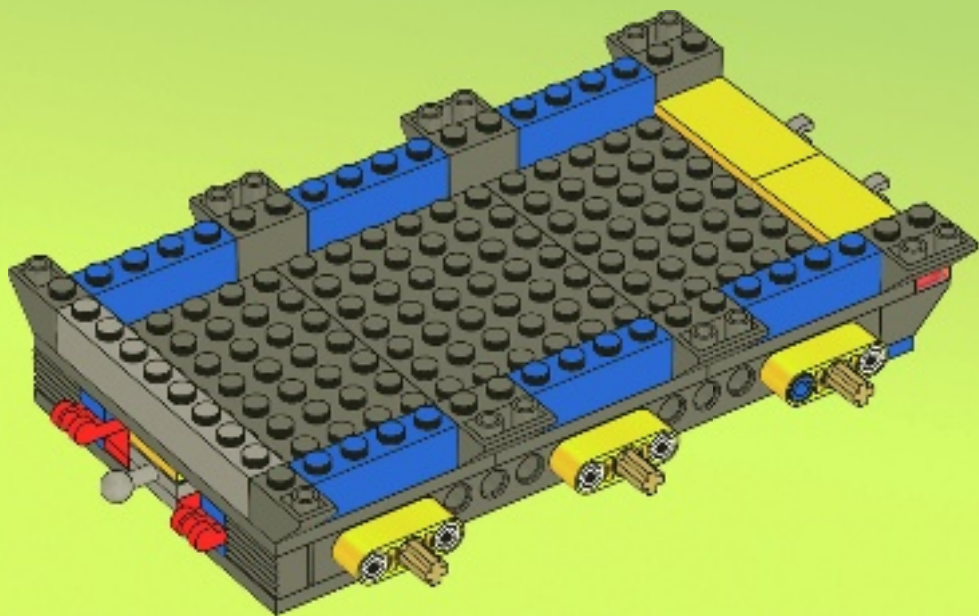

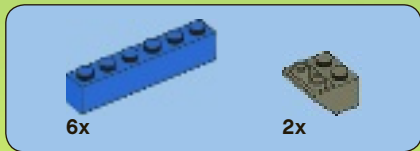

15

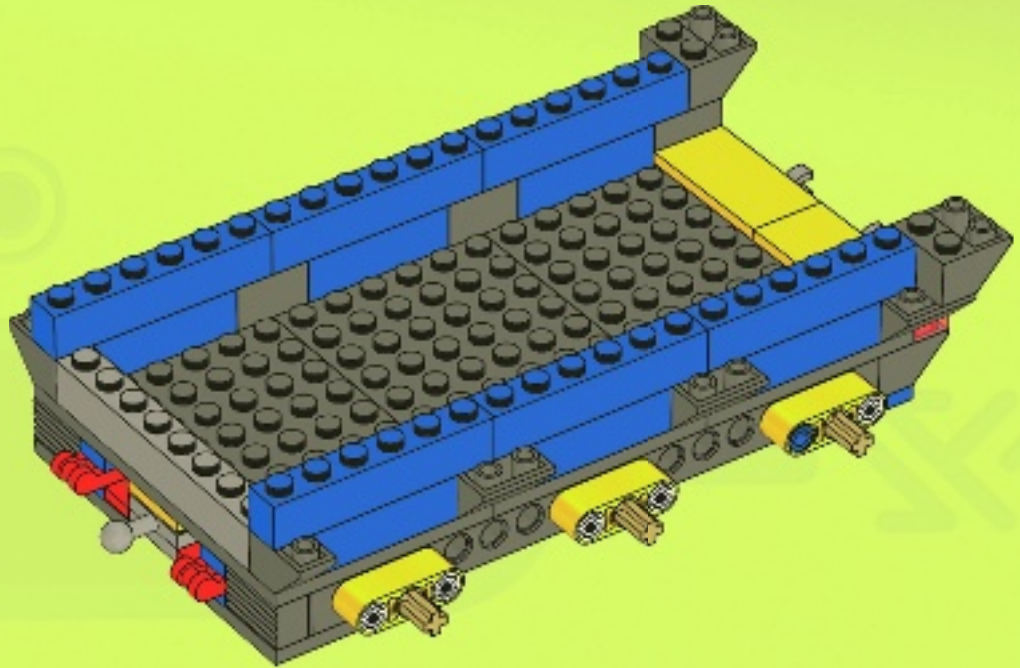





6x

# 16

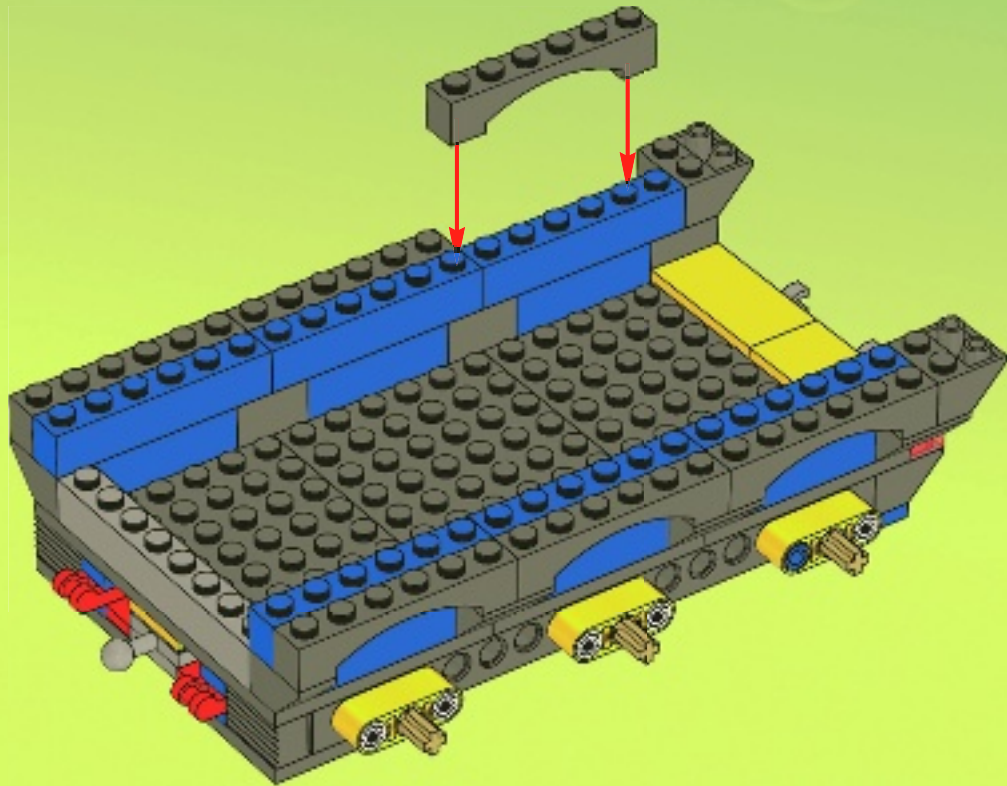



1x



2x

# 17

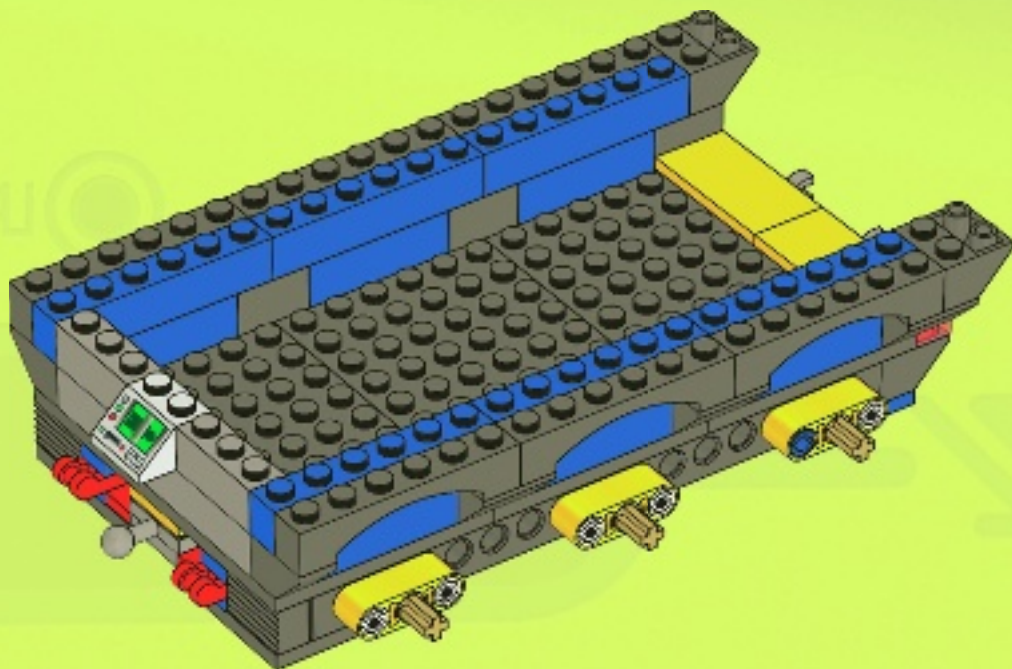

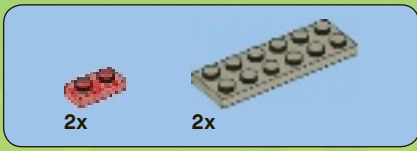

18

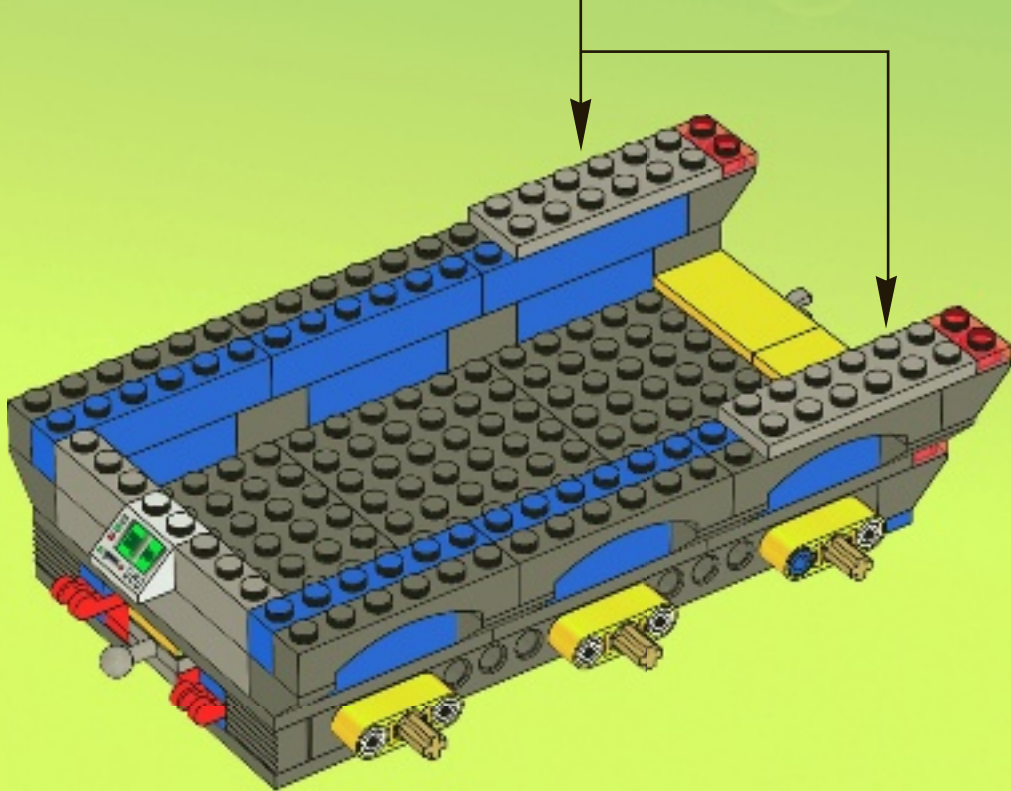
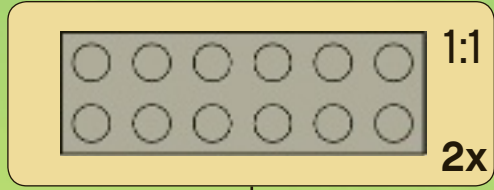



4x



4x

# 19

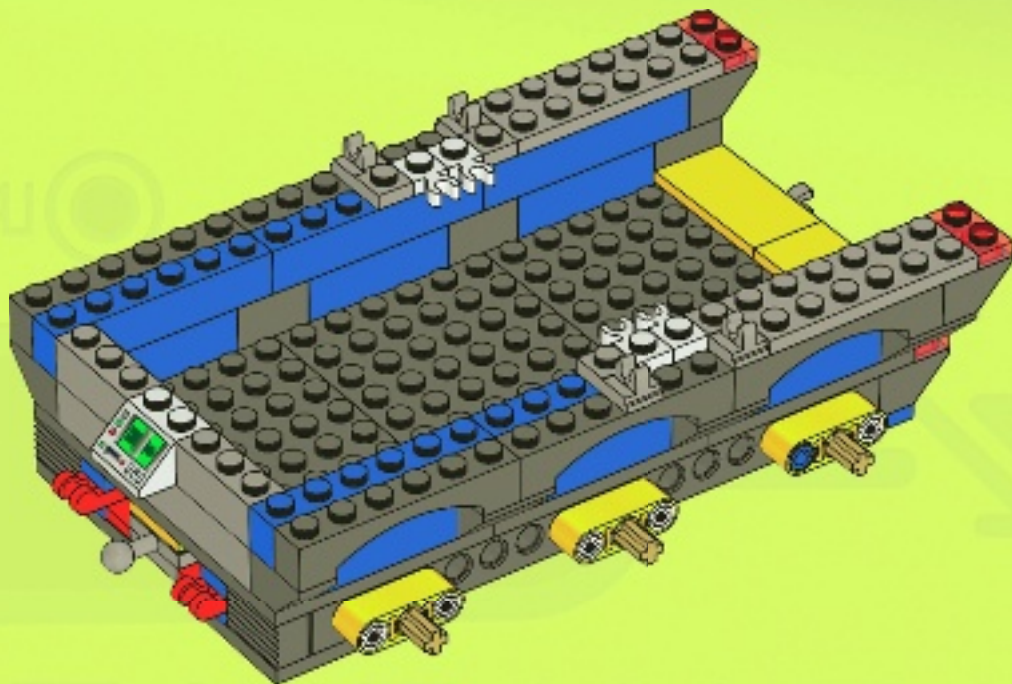



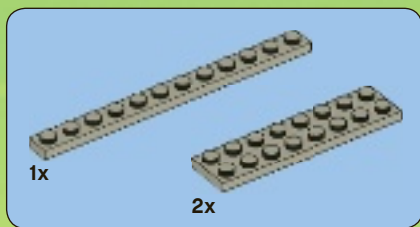

20

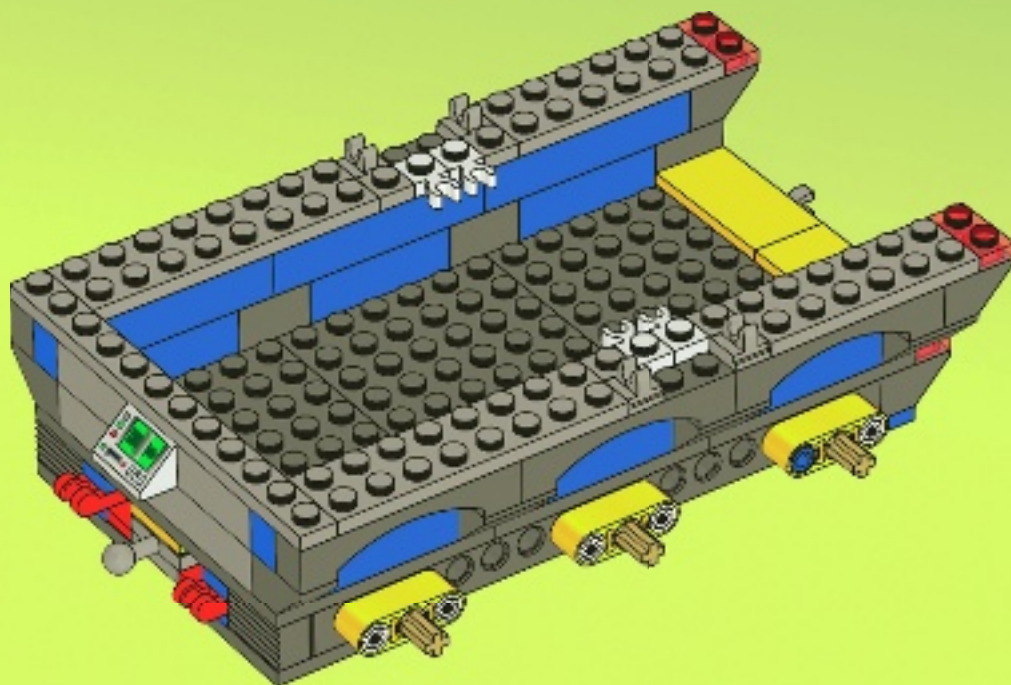



2x



1x

# 21

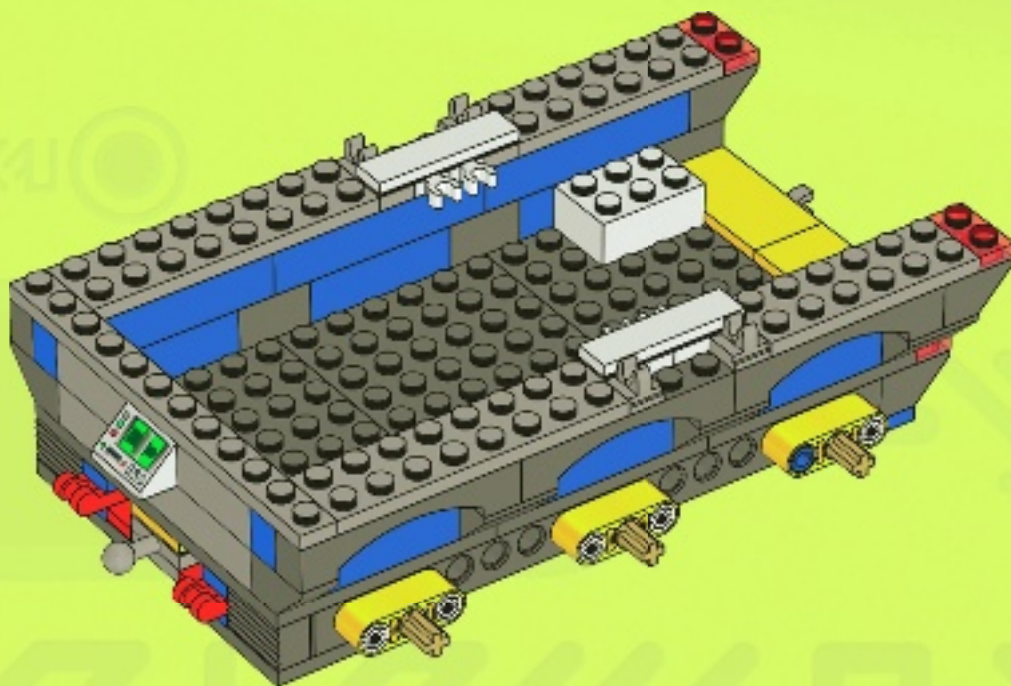

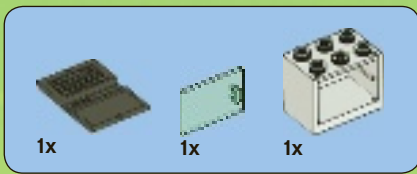

22

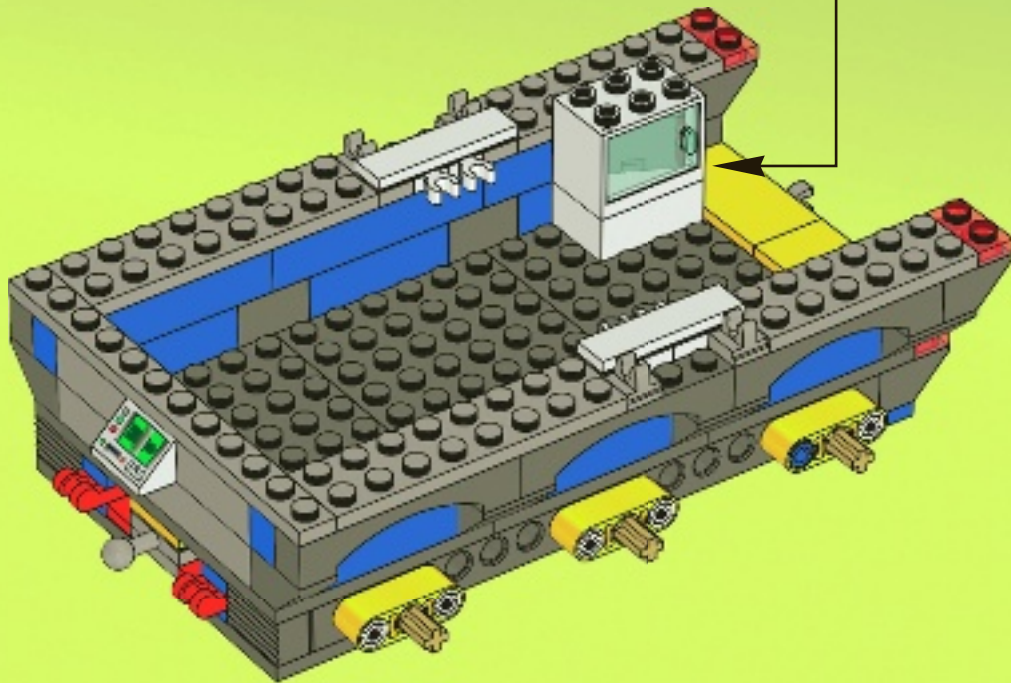
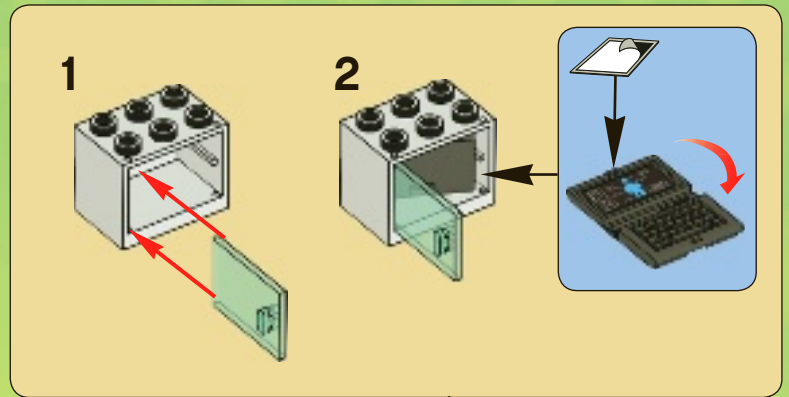



1x



2x

# 23

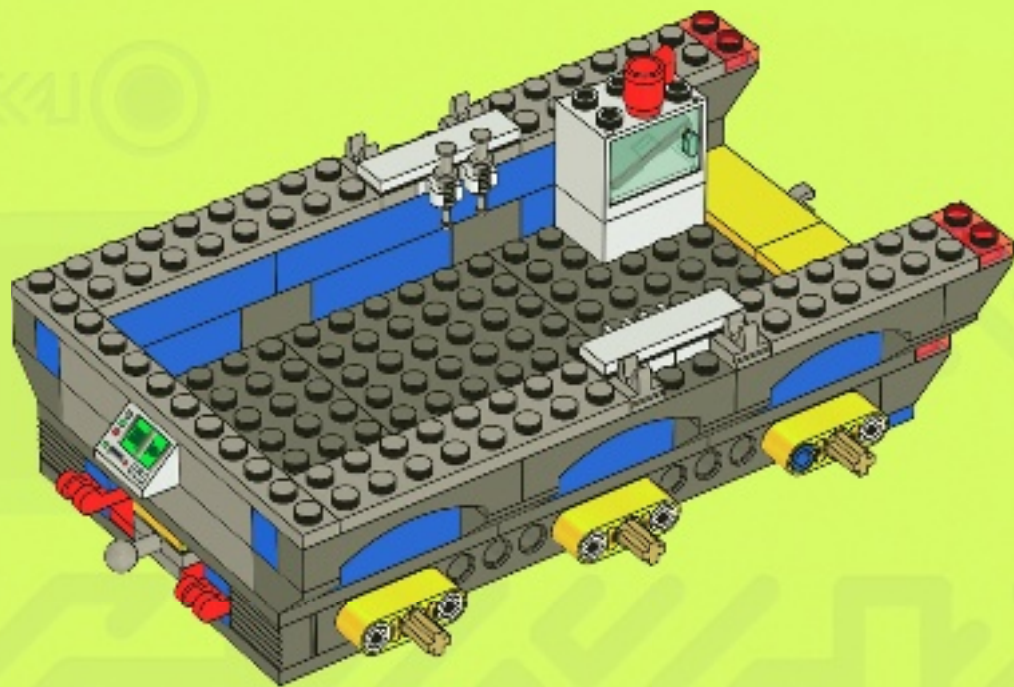



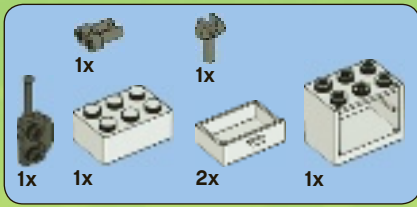

24

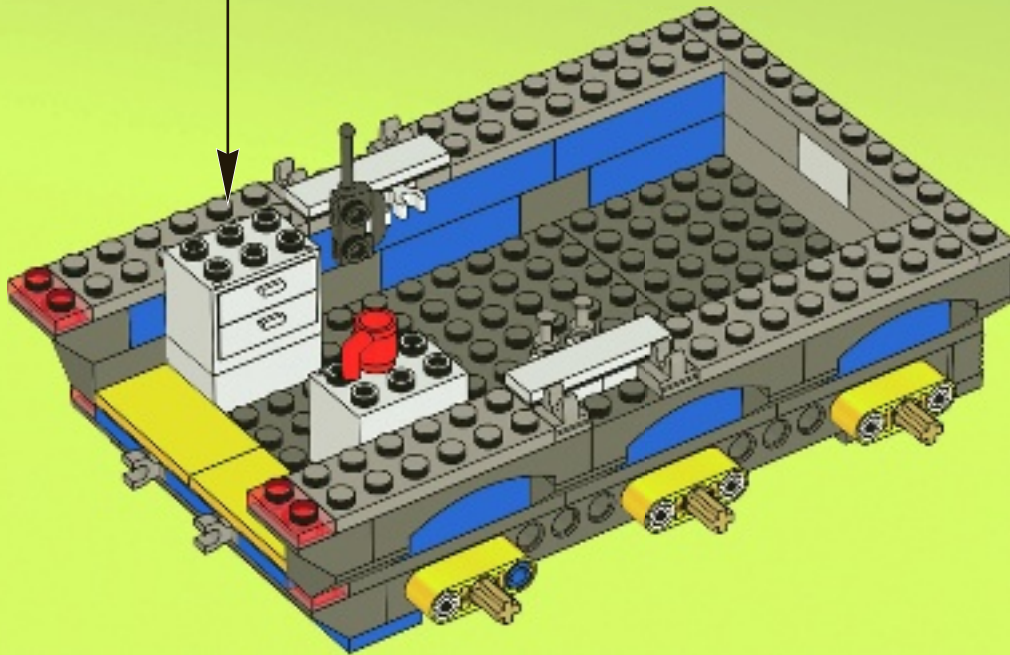
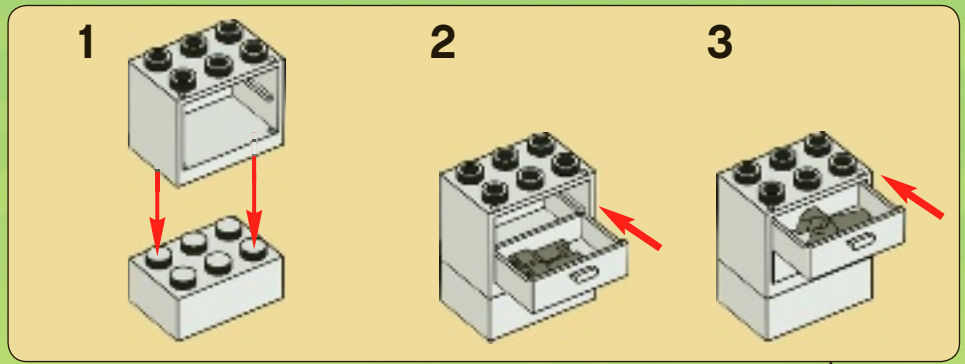



2x



2x

# 25

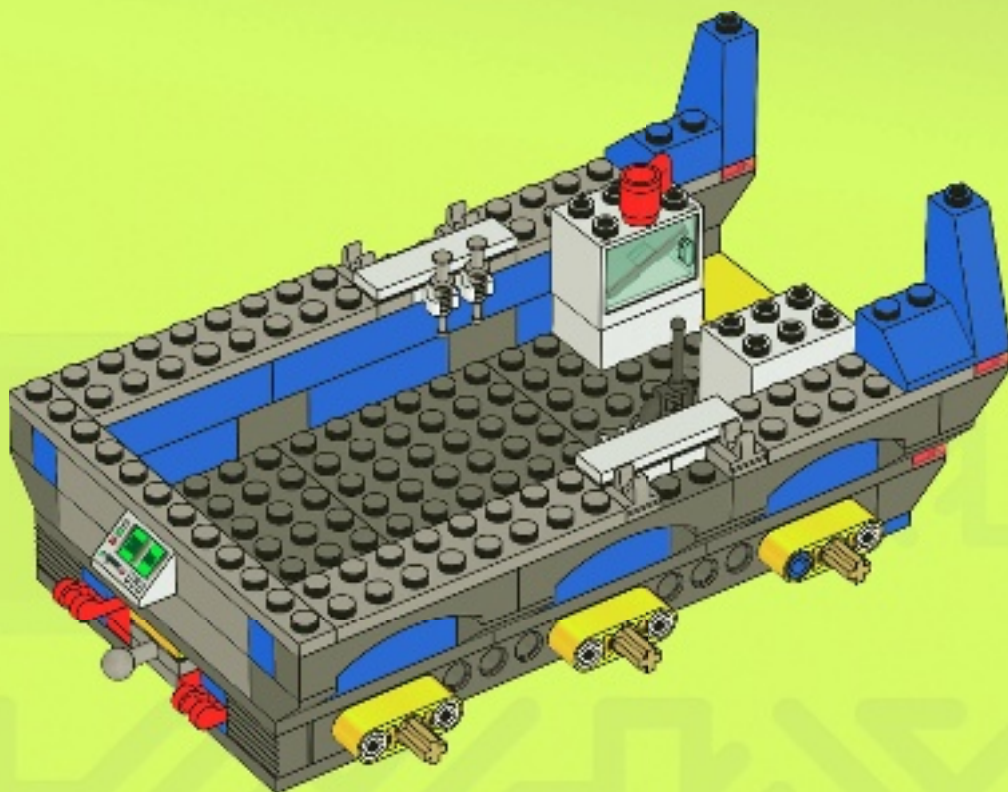

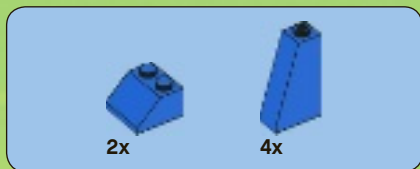

26

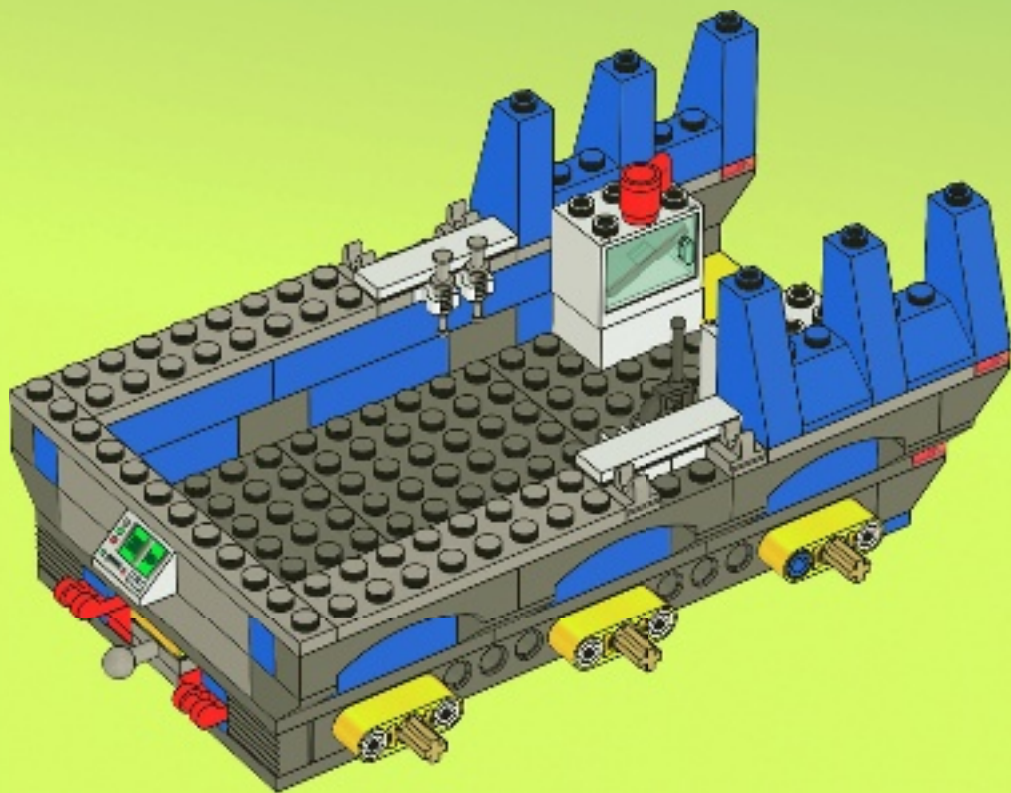





4x

27

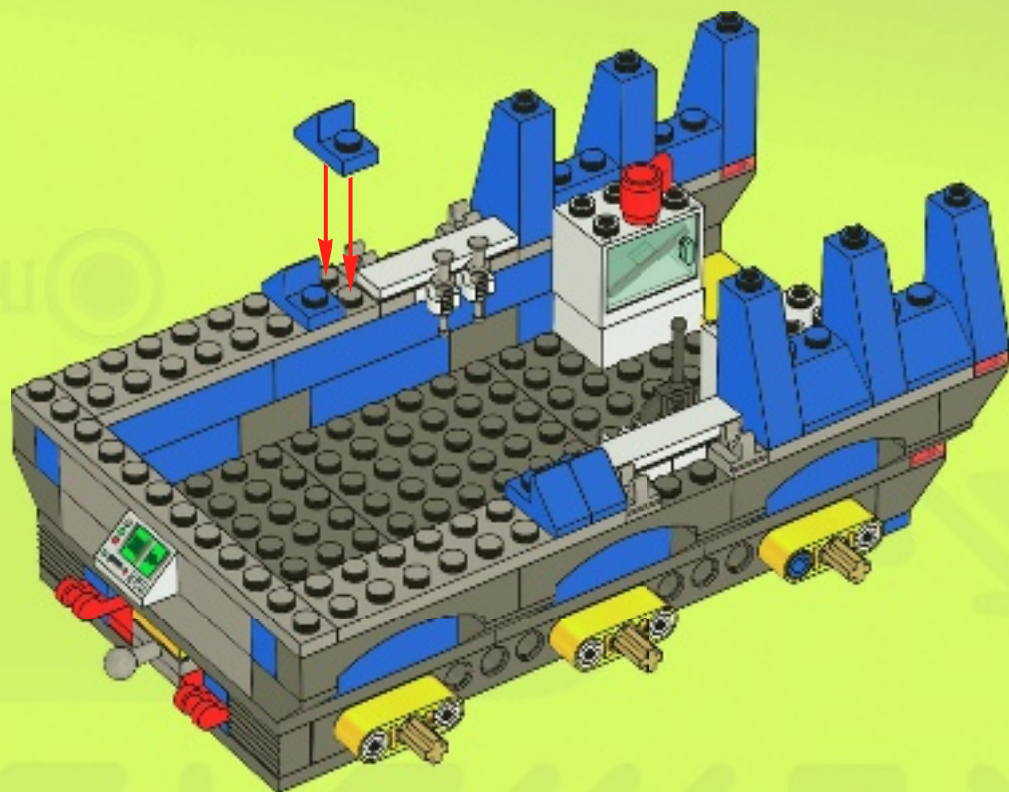





4x



4x

# 28

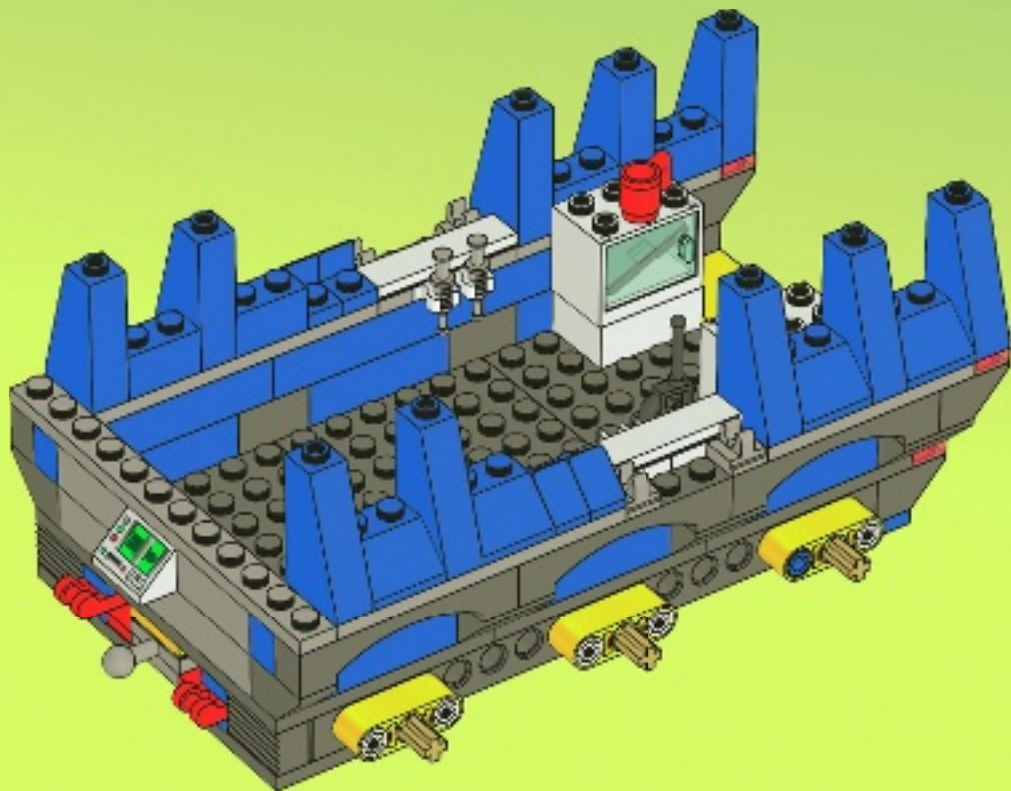



8x



8x

# 29

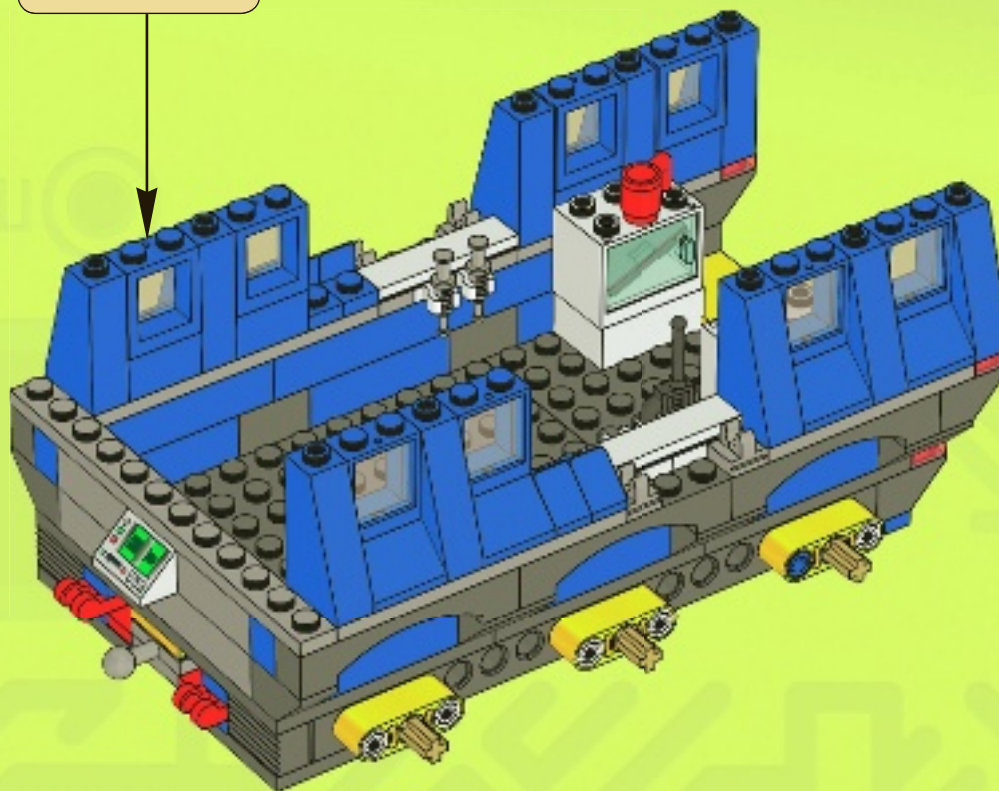
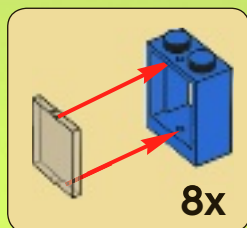

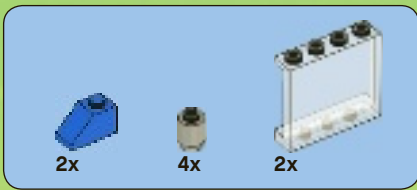

# 30

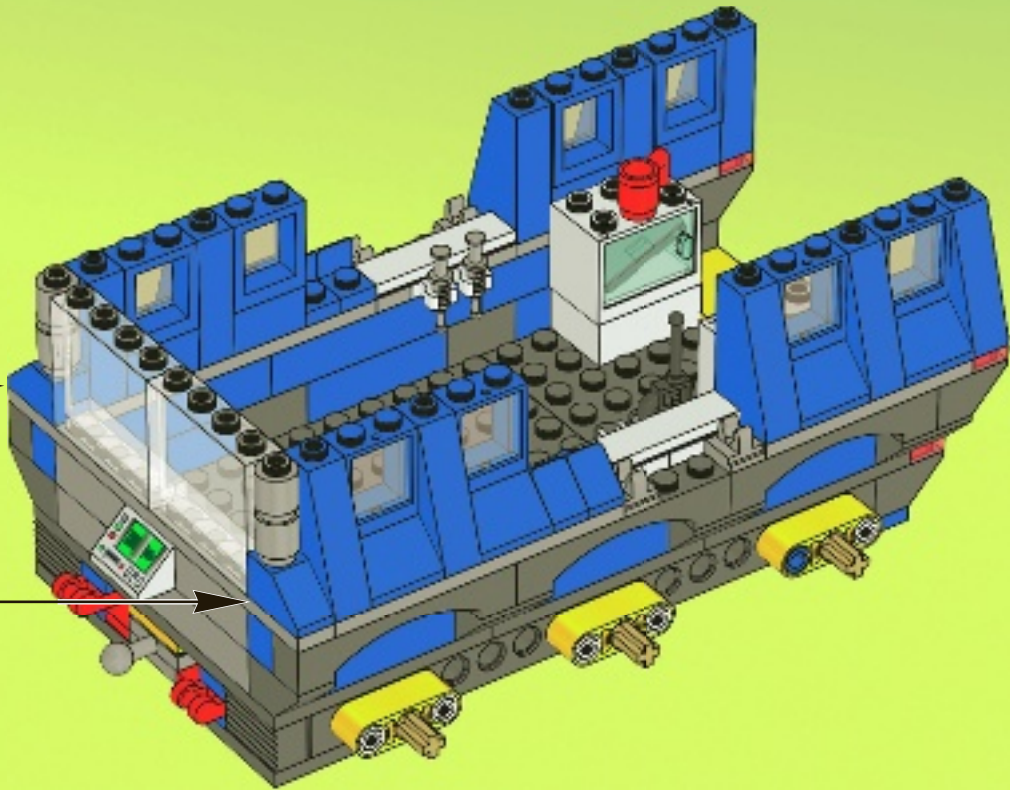
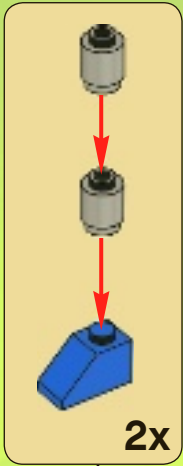

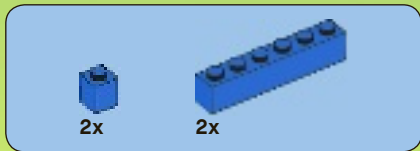

# 31

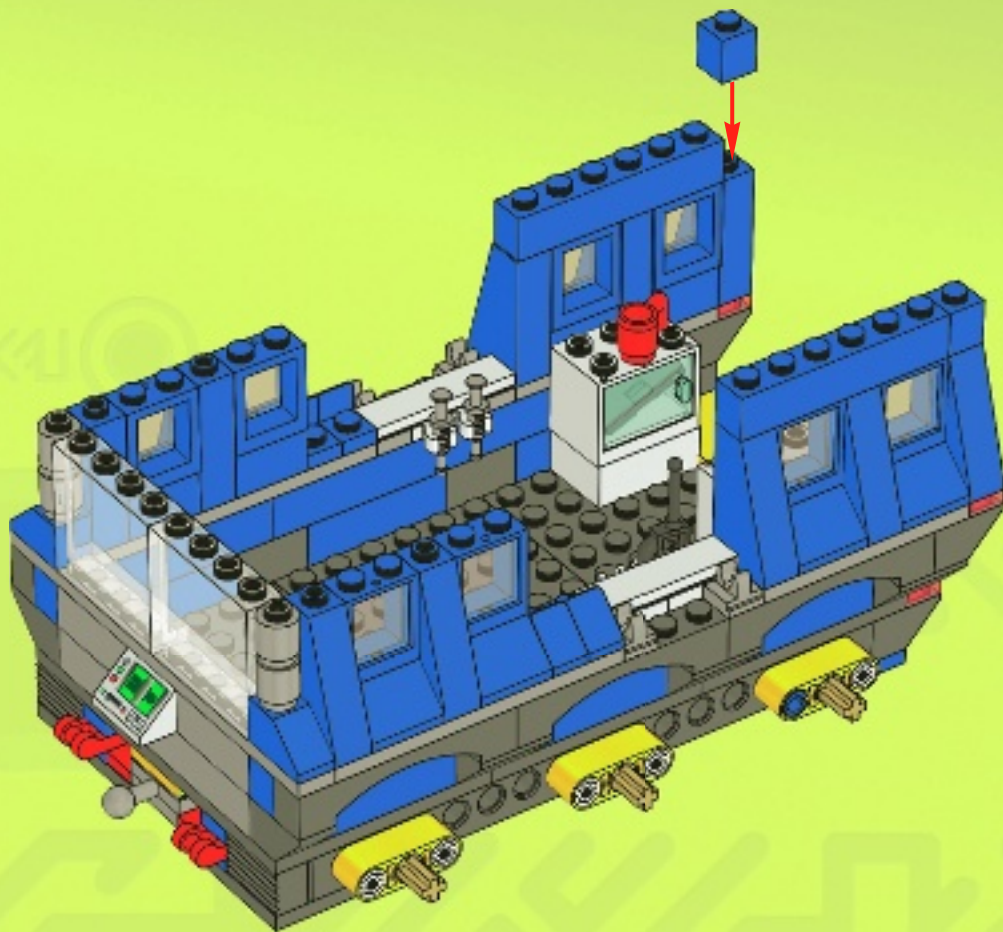



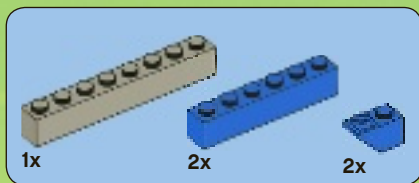

32

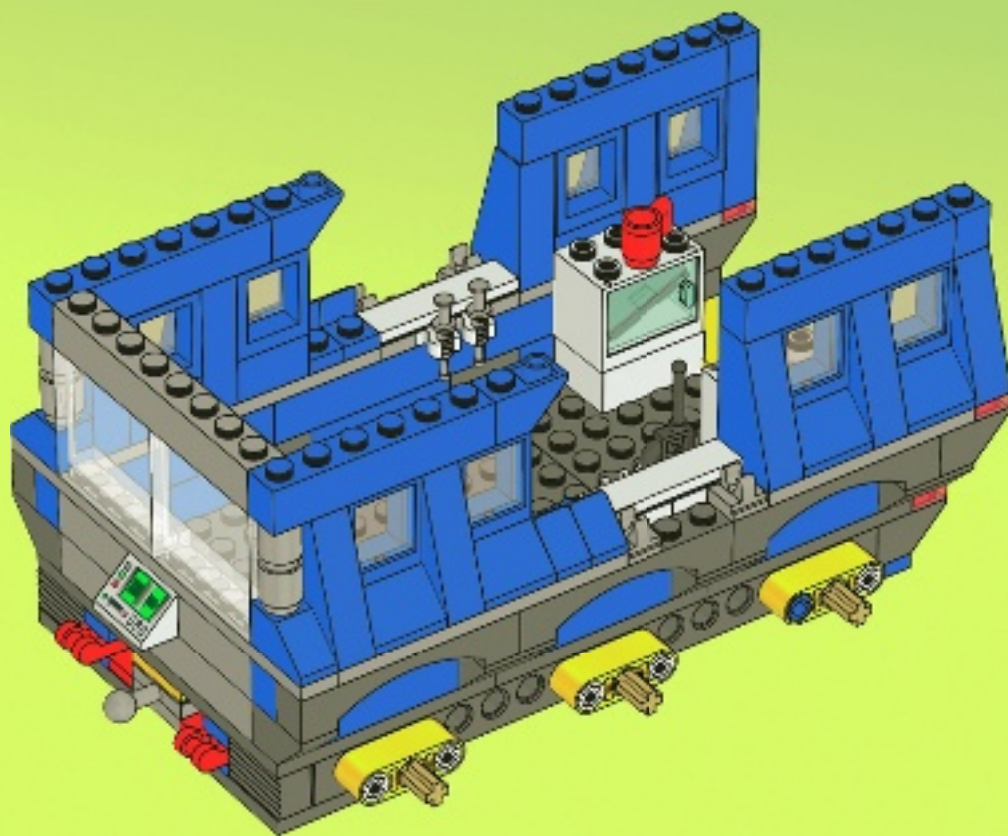



3x



2x

# 33

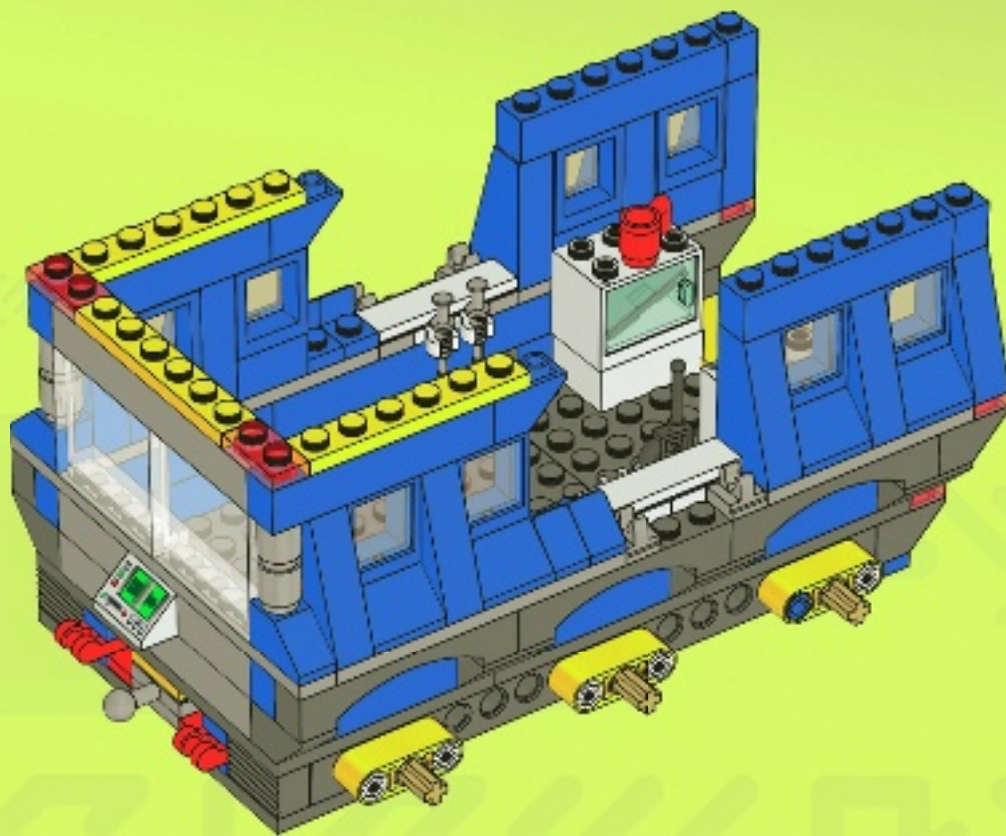

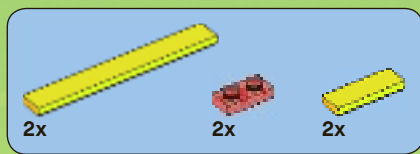

34

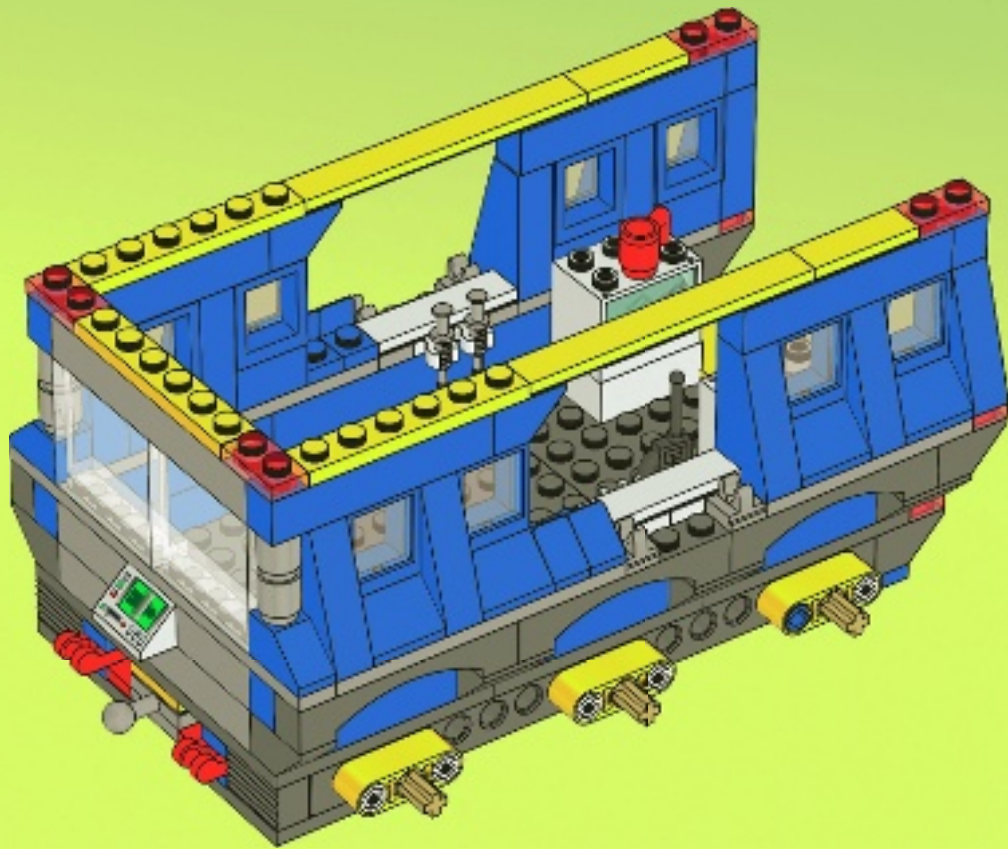

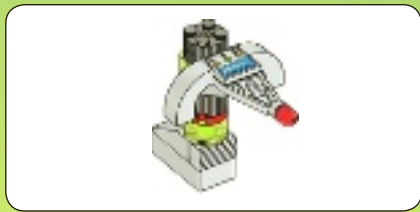

1

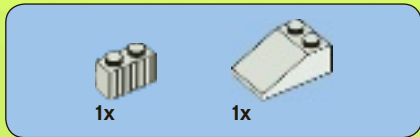
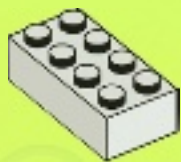

2

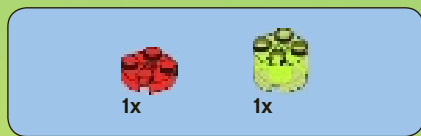
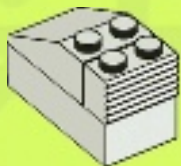

3



4

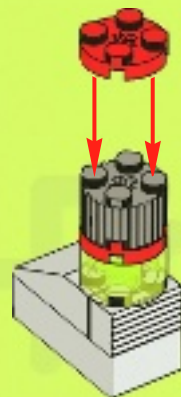





2x



1x

5

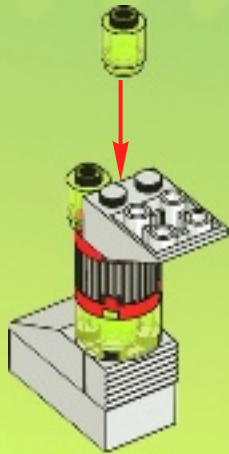

1x



2x

7

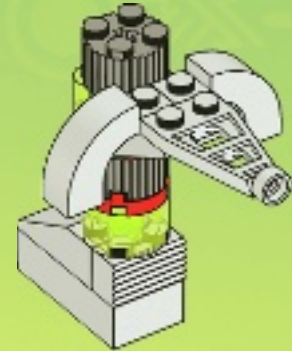

1x

6



1x



1x

8

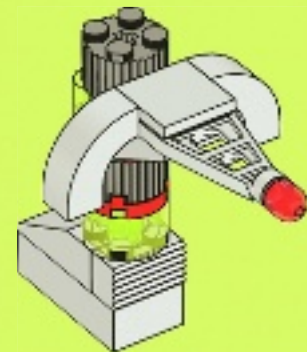

9

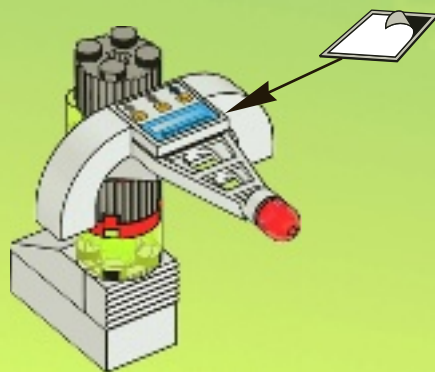

35

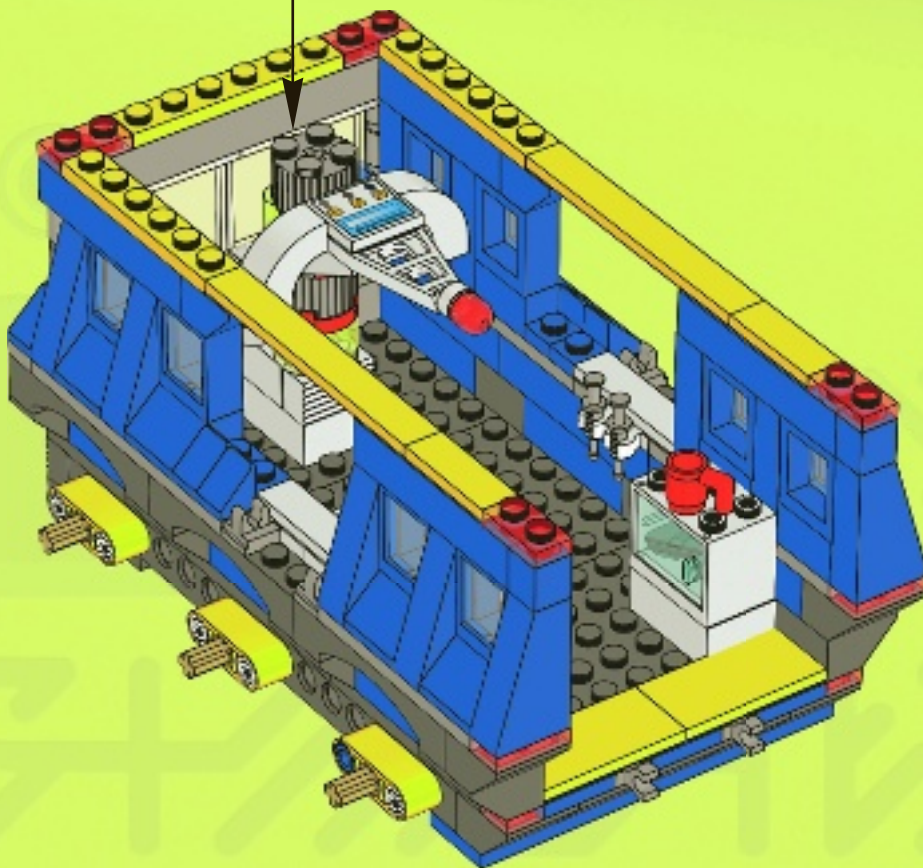

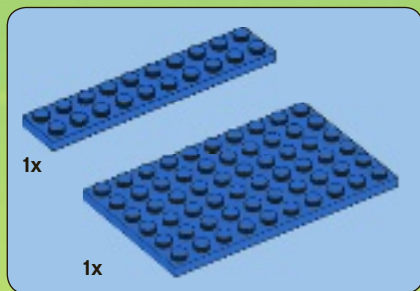

# 36

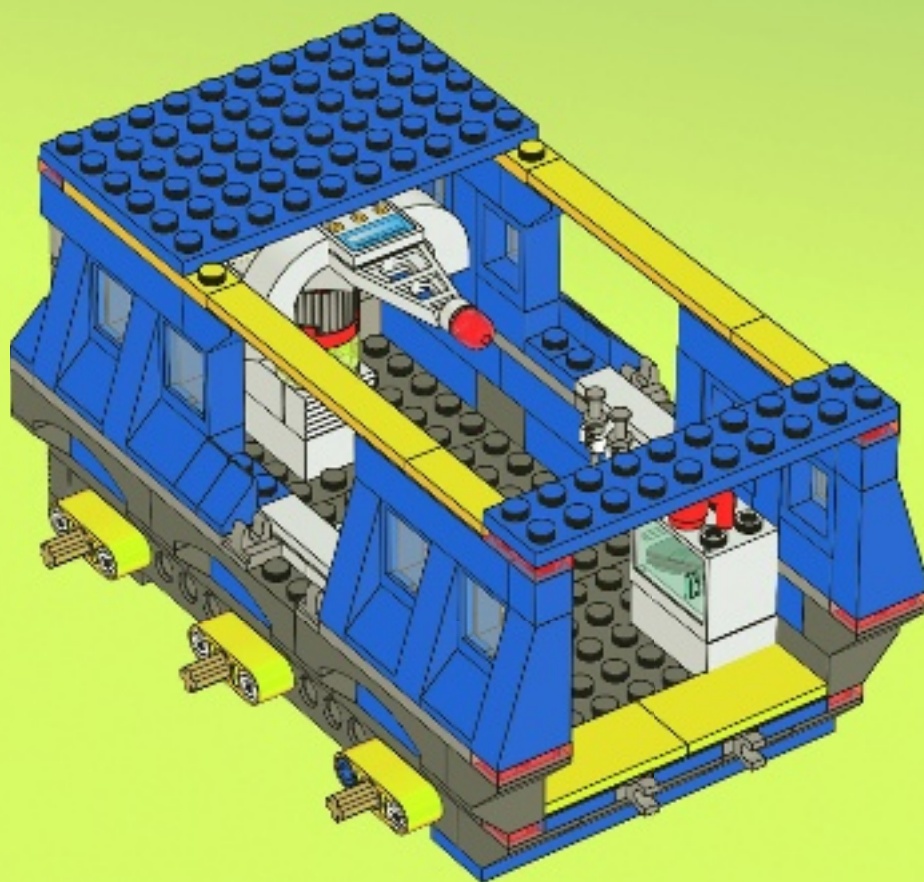



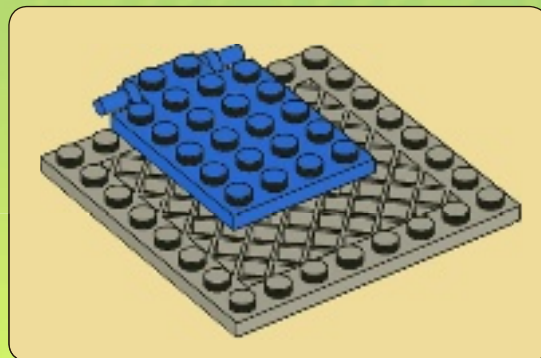
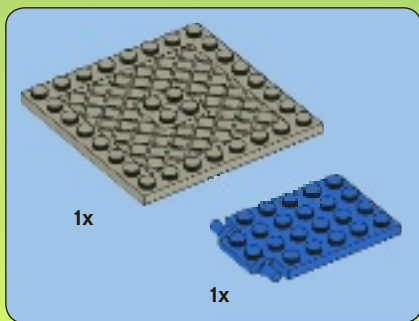

37

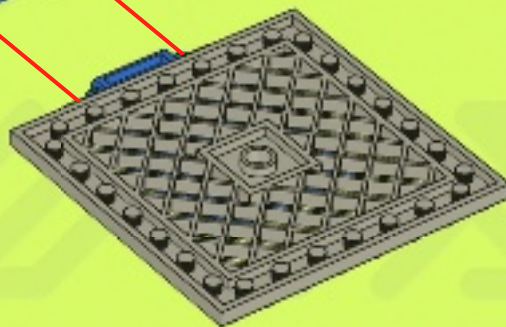
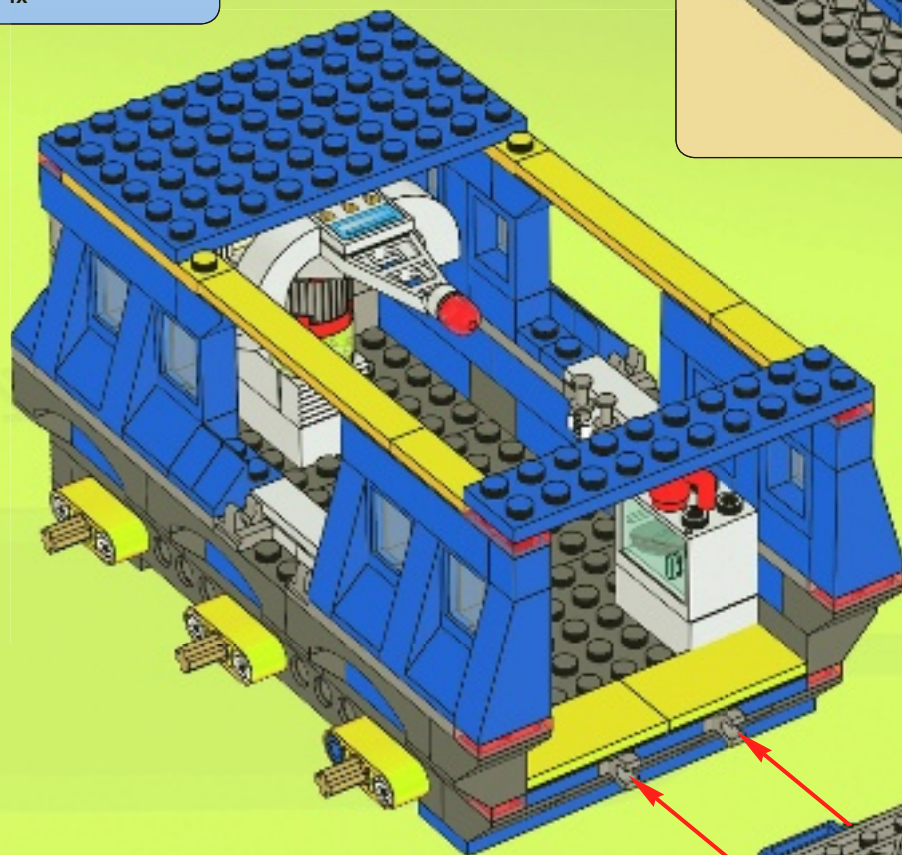



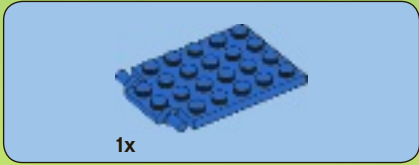

1

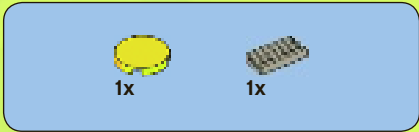
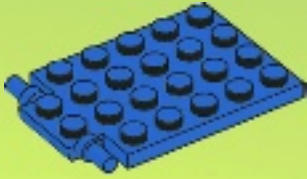

2

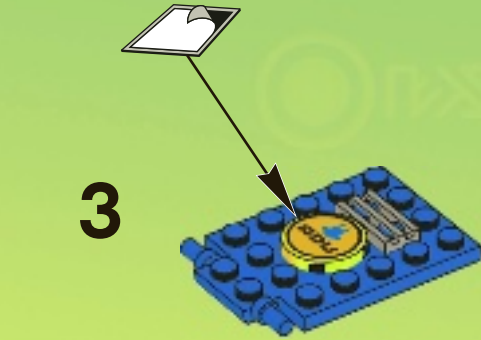
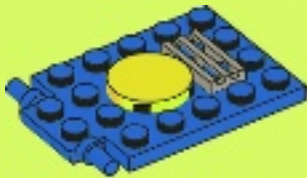

4

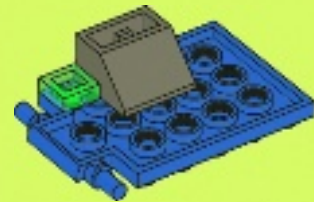



5

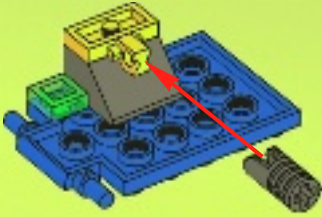

6

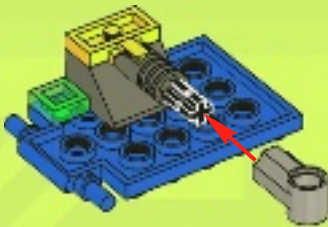

8

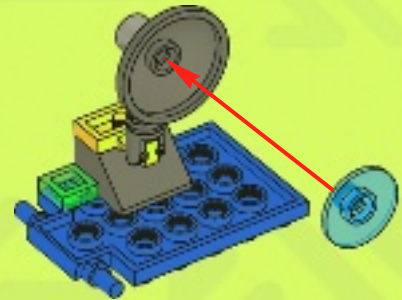

7

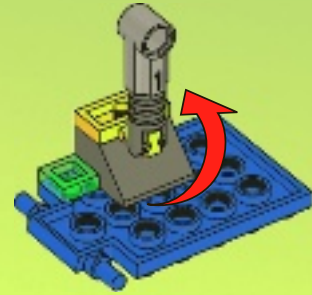

38

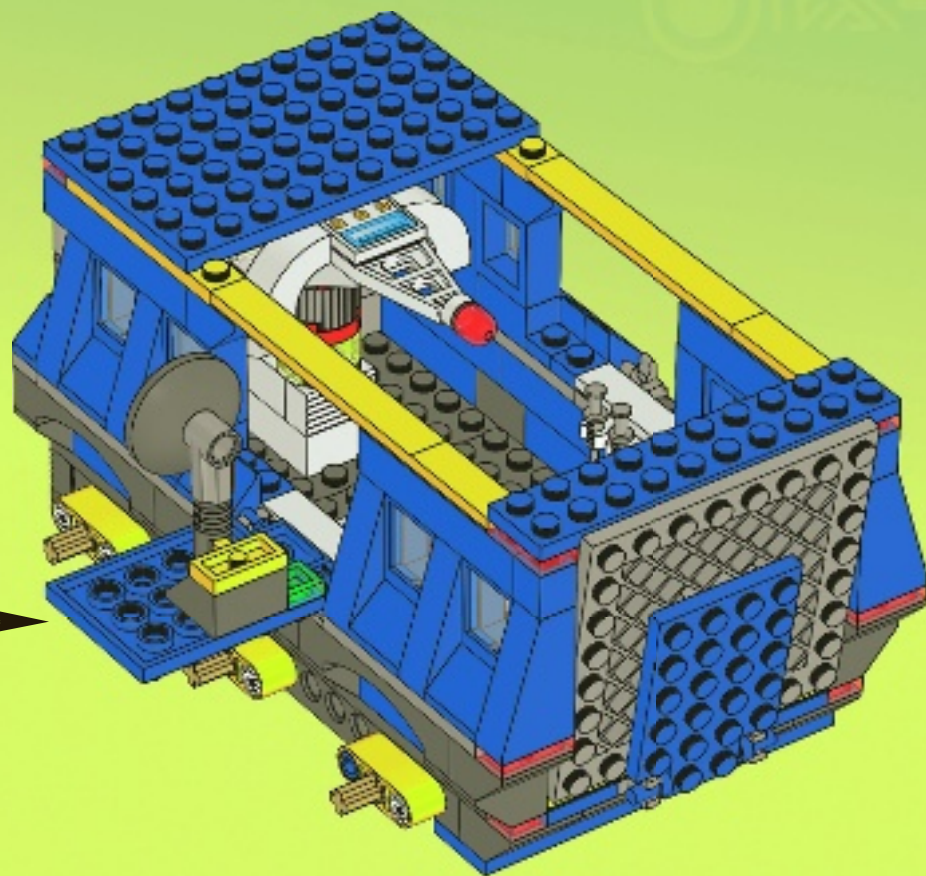

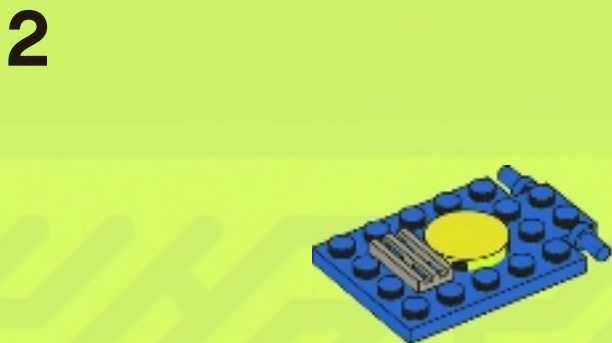

3

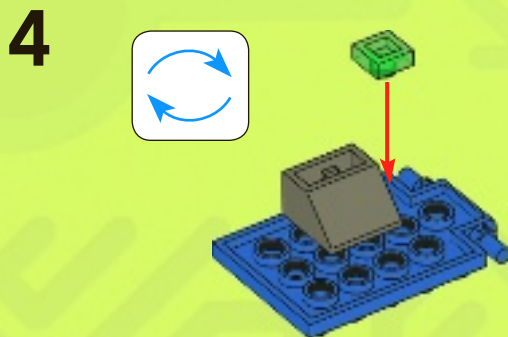
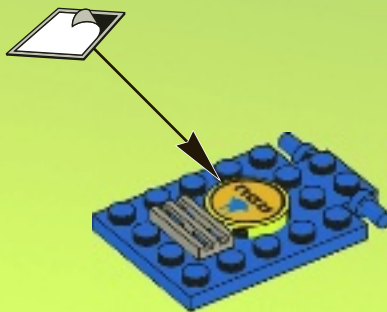





1x



1x

5

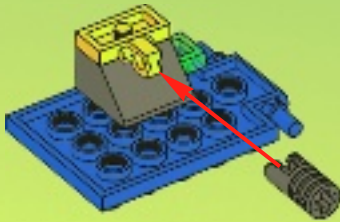

1x



1x

6

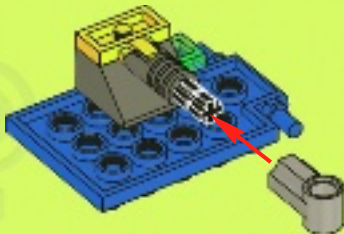

1x



1x

8

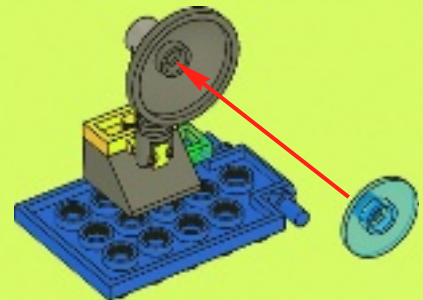

7

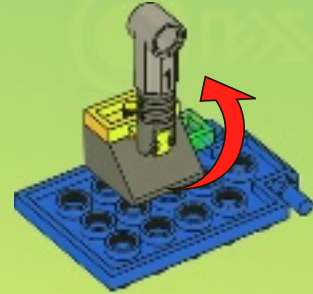

# 39

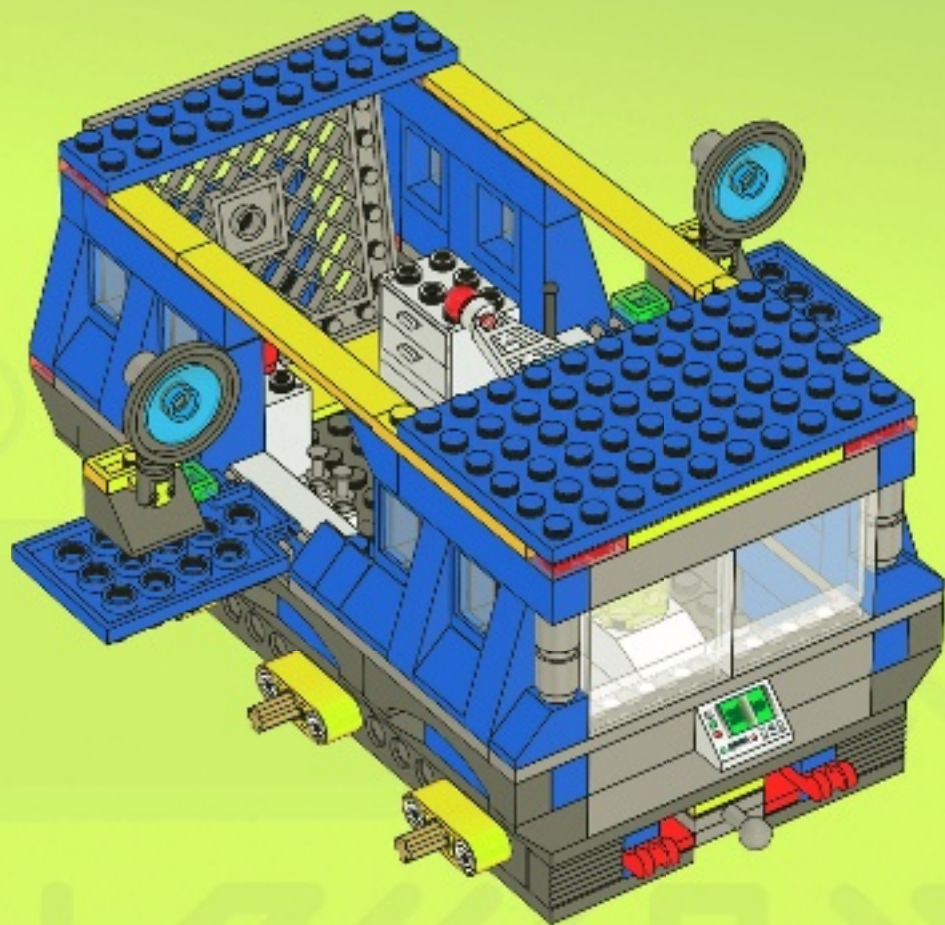

1

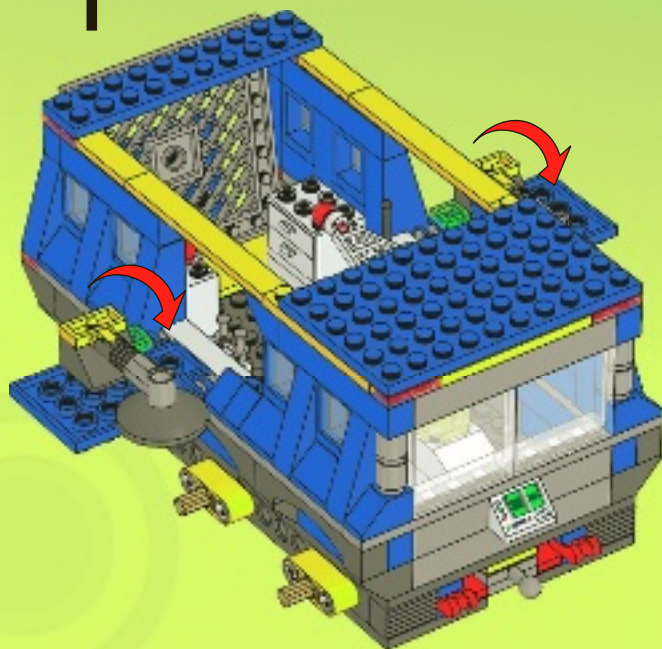

2

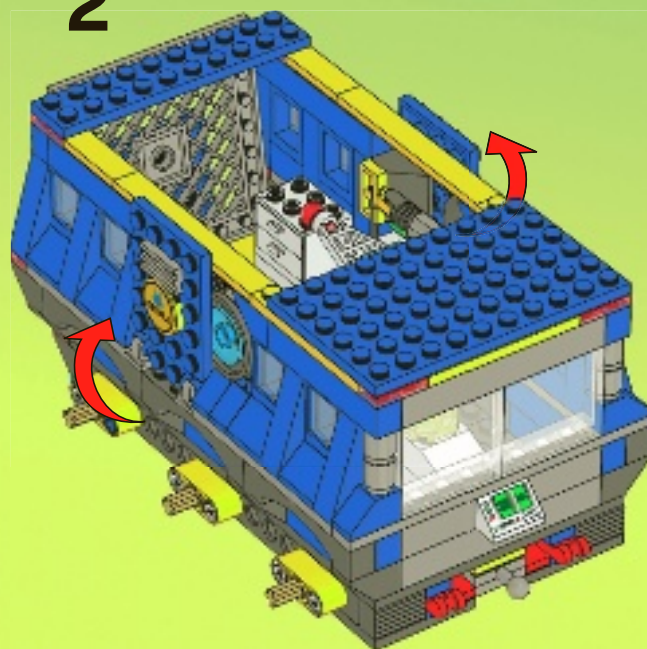



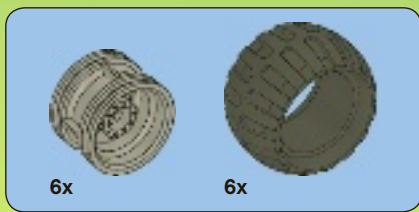

40

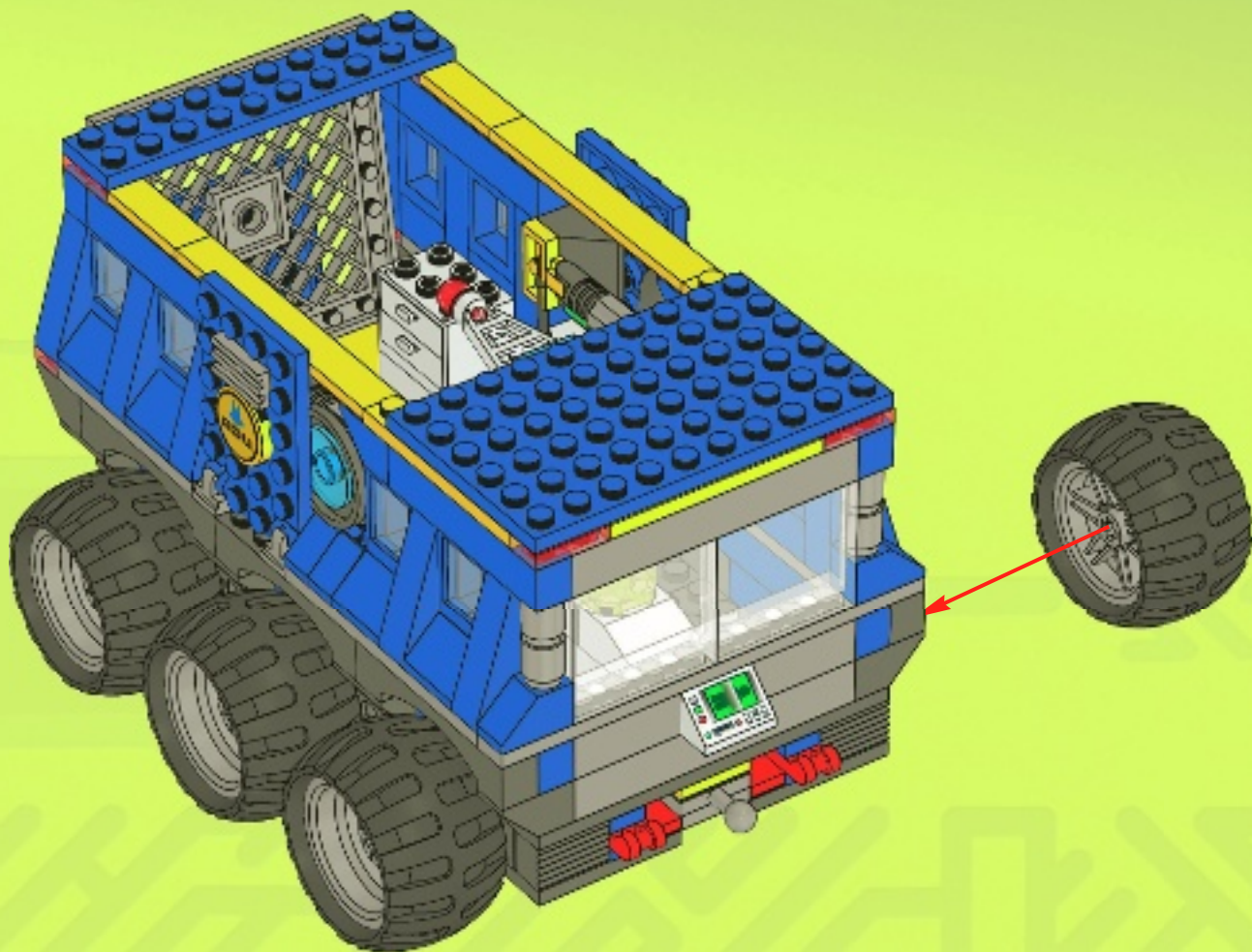





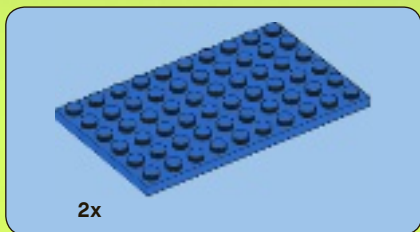
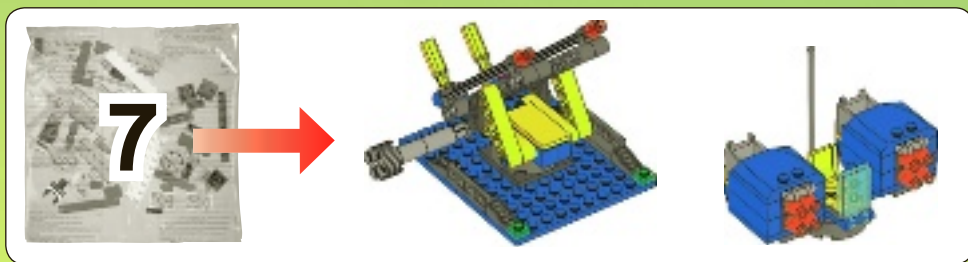

1

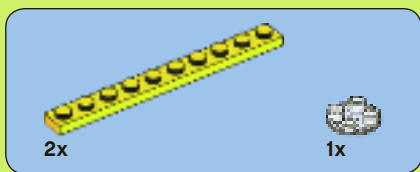
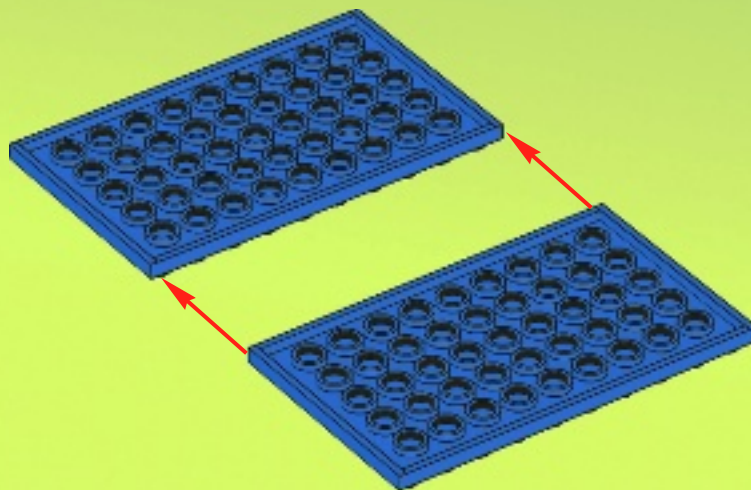

2

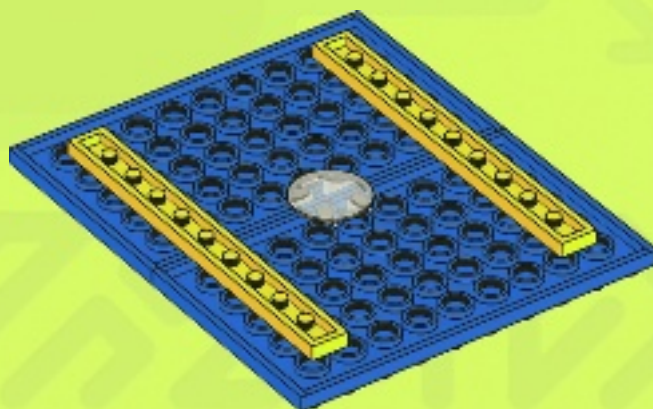

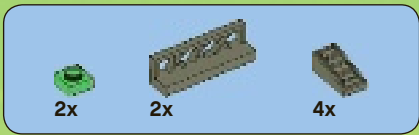

3



4

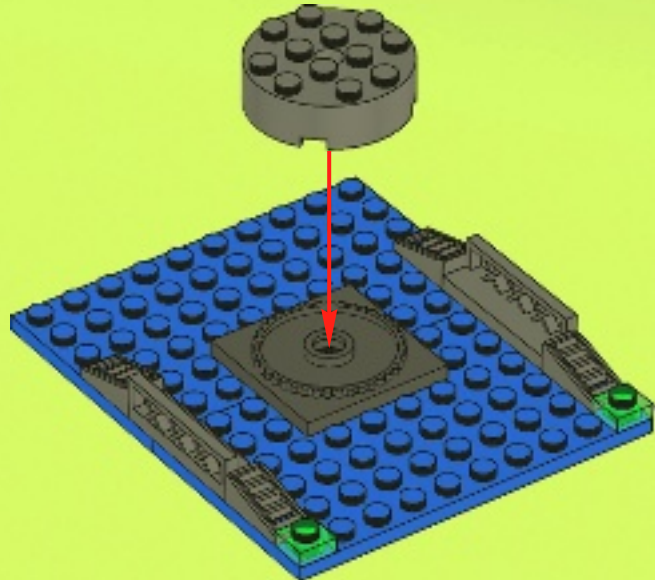





2x

5

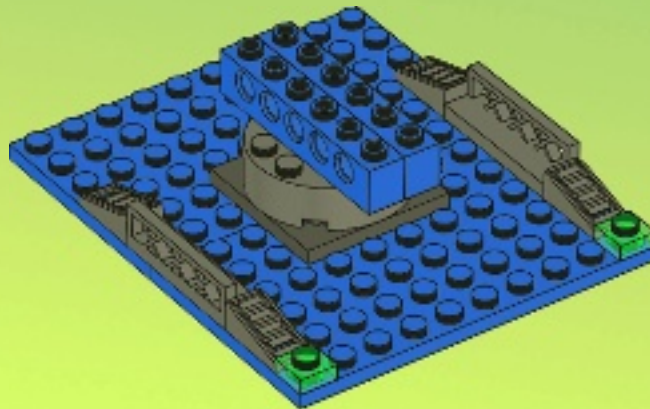

1x

6







2x

7

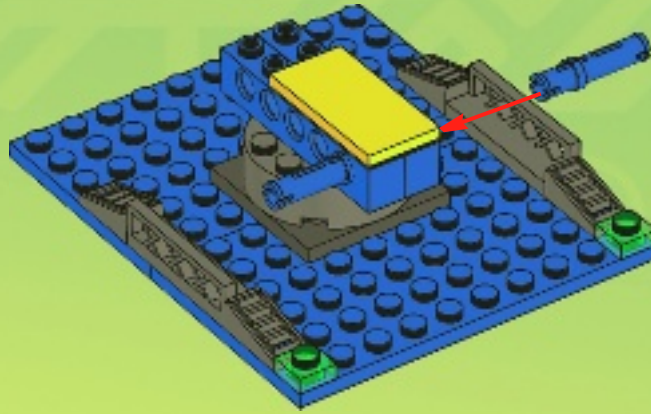

2x

8

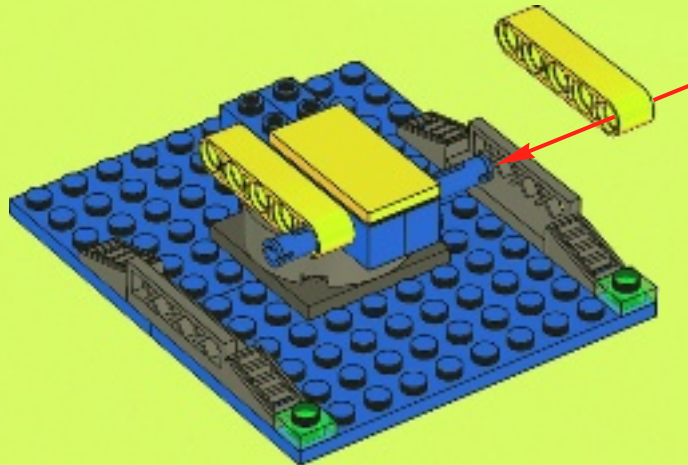

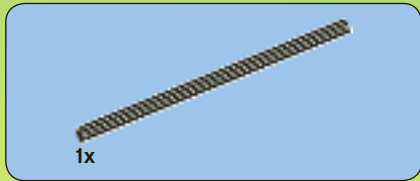

9

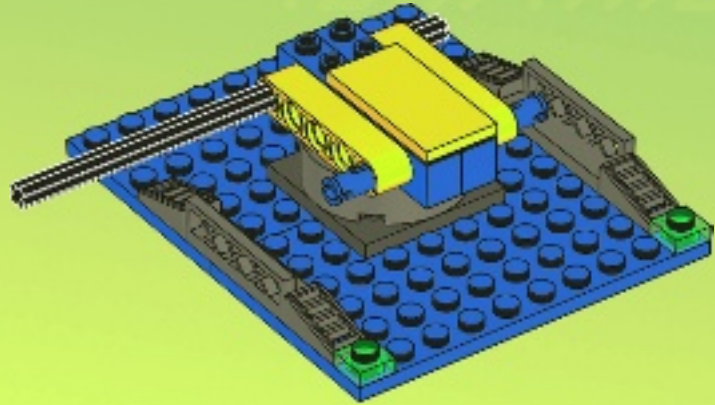

10

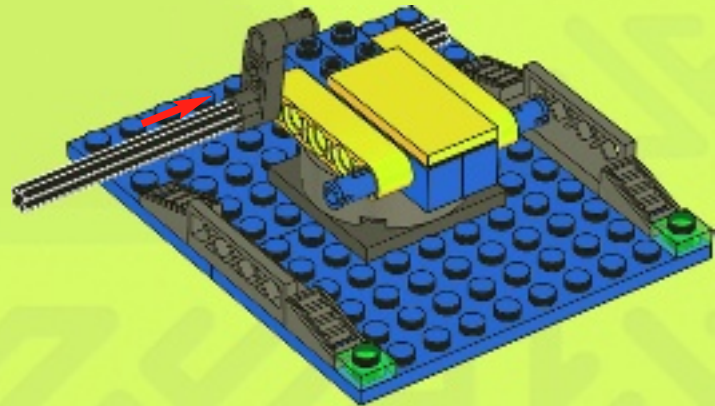

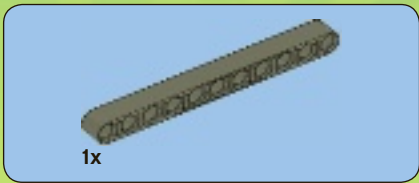

1

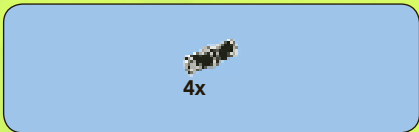

2

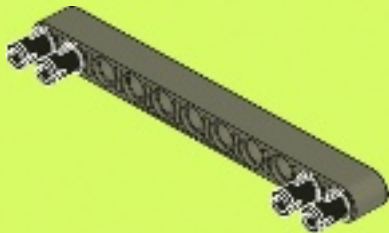

3

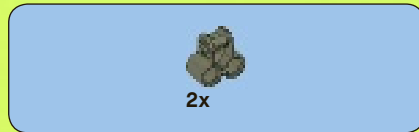
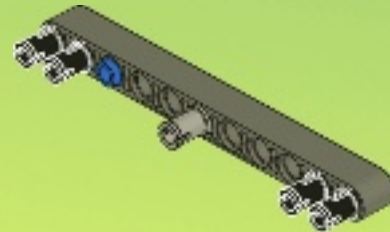

4

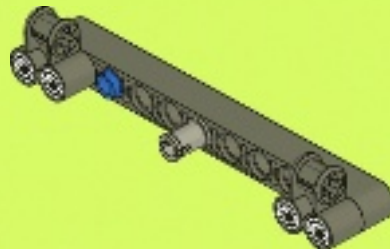

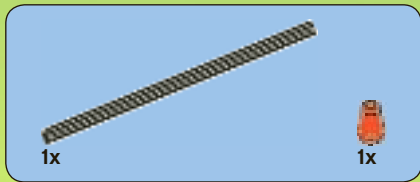

5

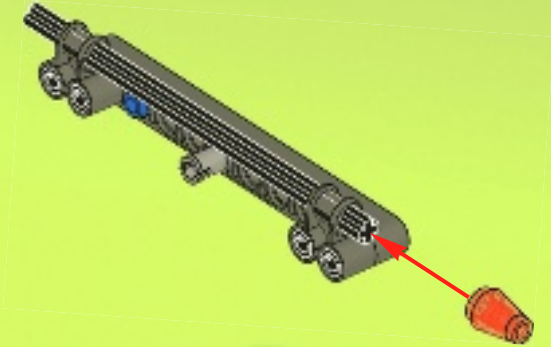

6

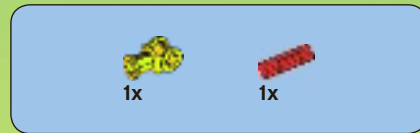
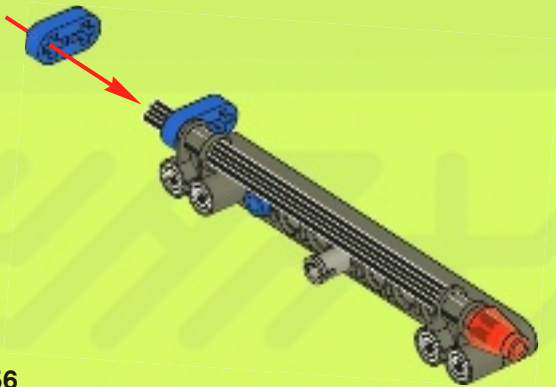

7

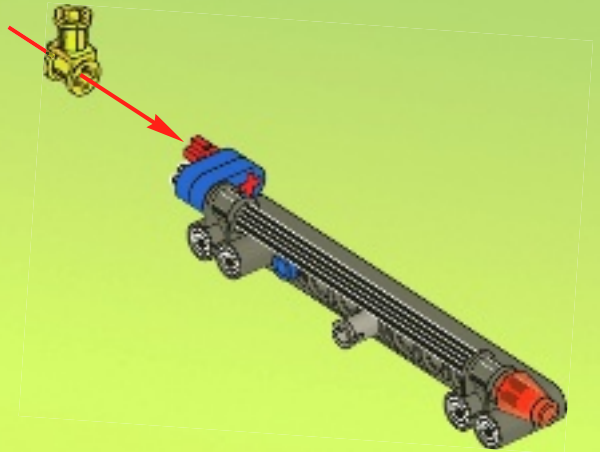

8

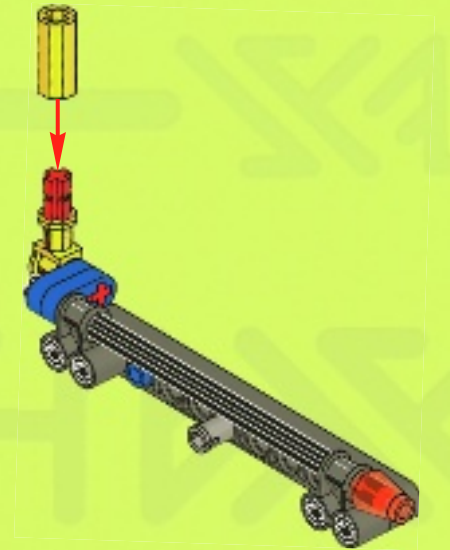



11

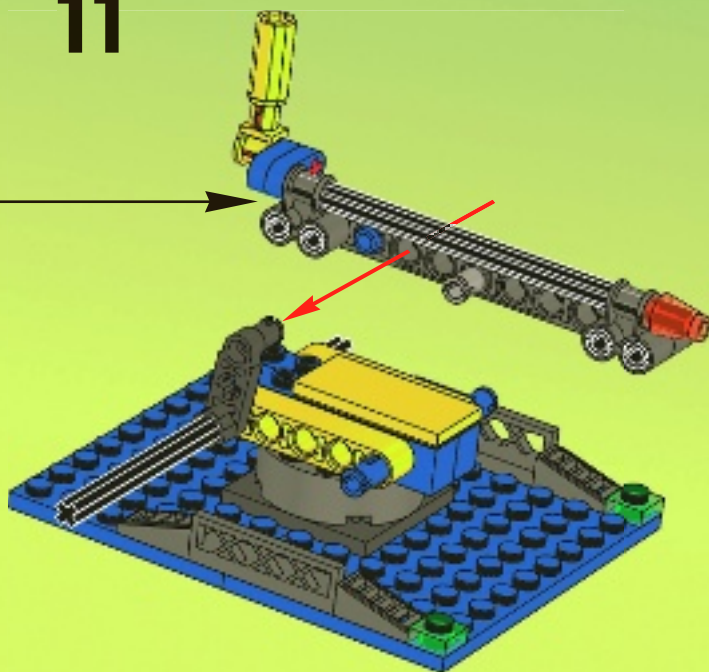

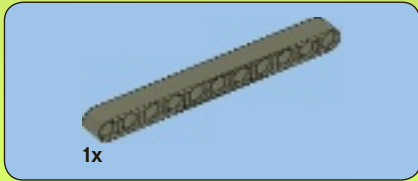

1

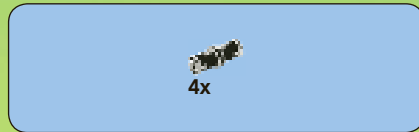

2

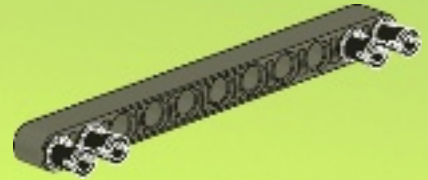

3

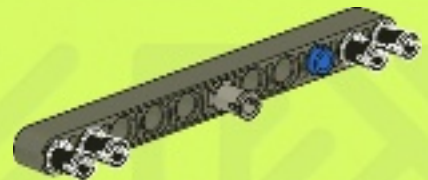



2x

4

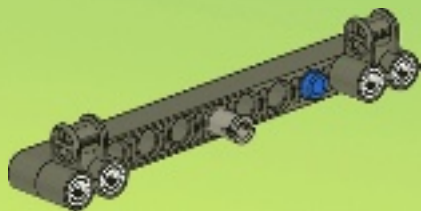

1x



1x

5

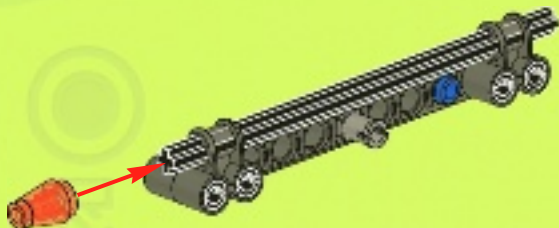

2x

6

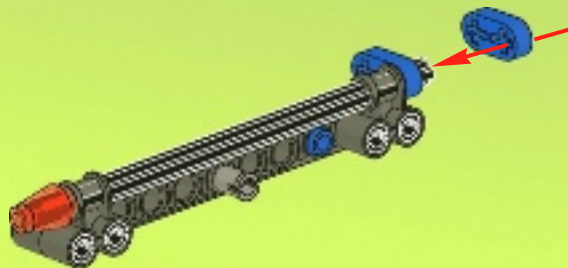



1x



1x

7

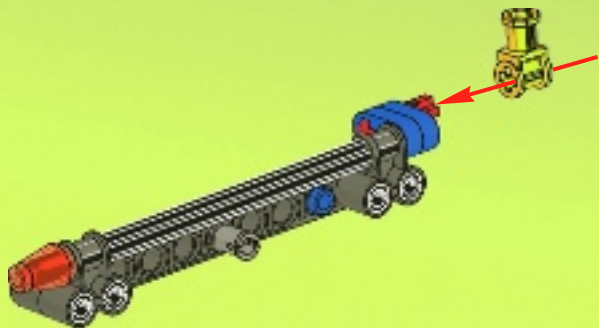

1x



1x

8

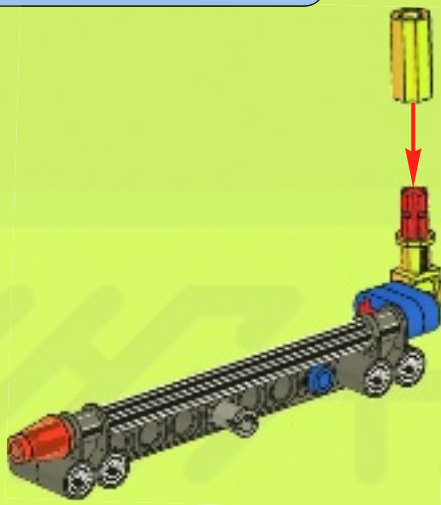

1x

9

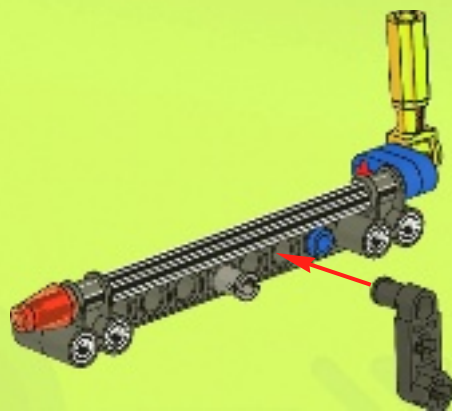



# 10

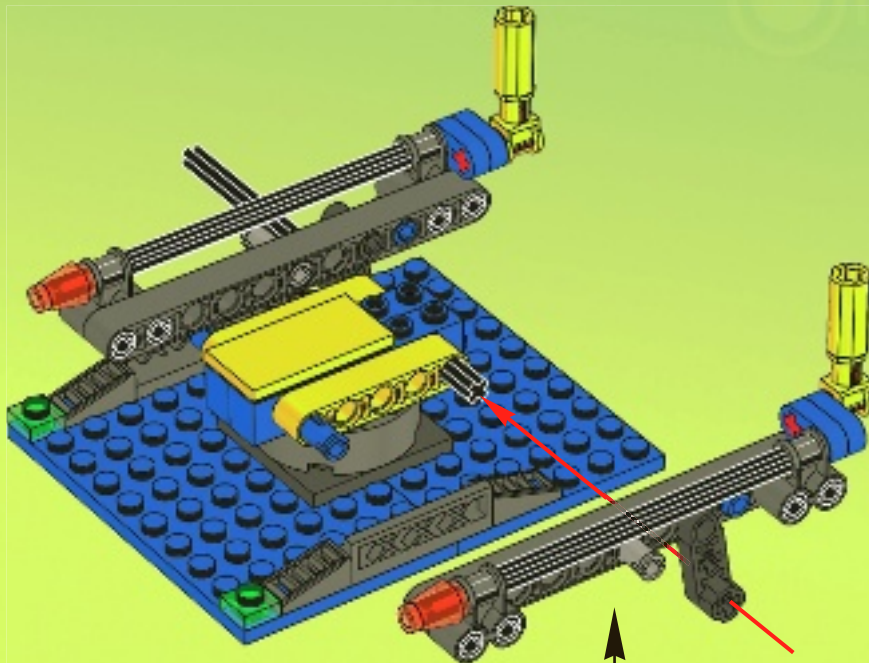

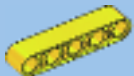

2x

# 11

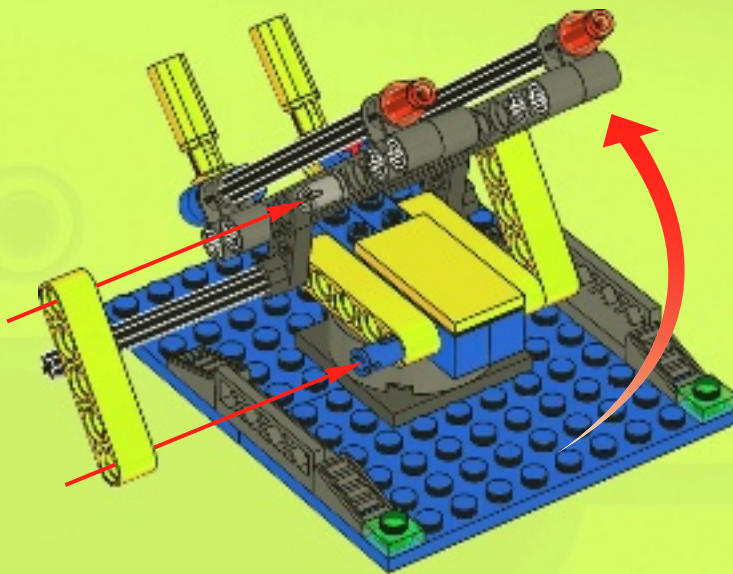



1x



1x

# 12

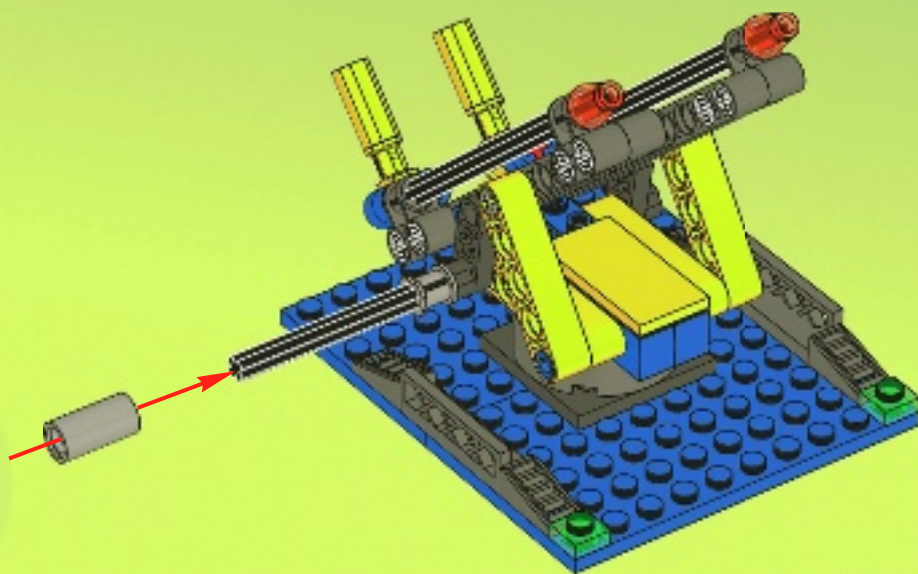

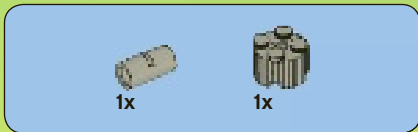

13

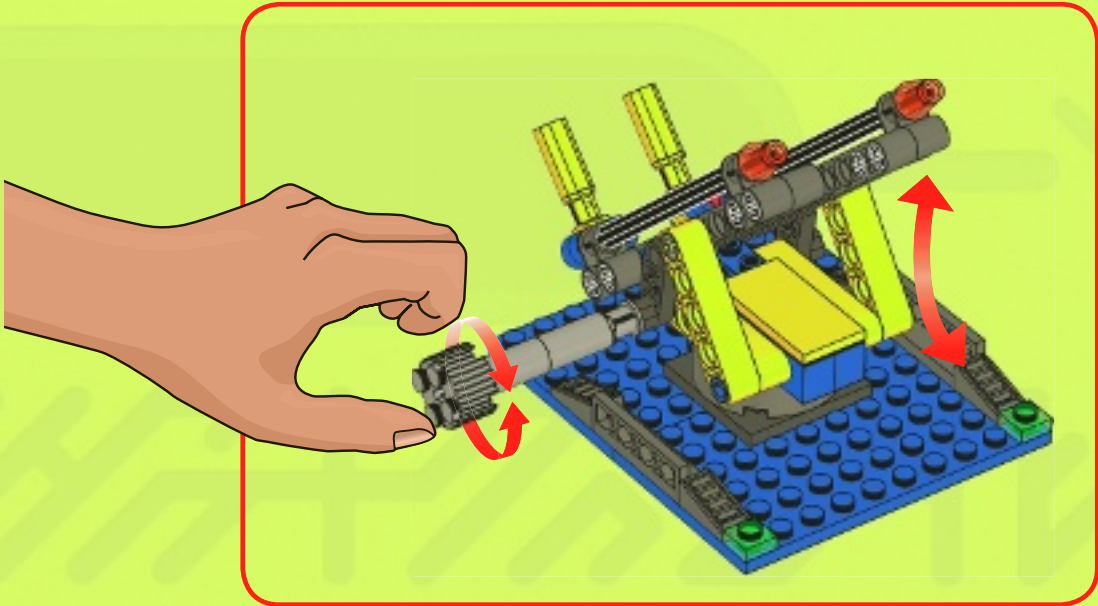
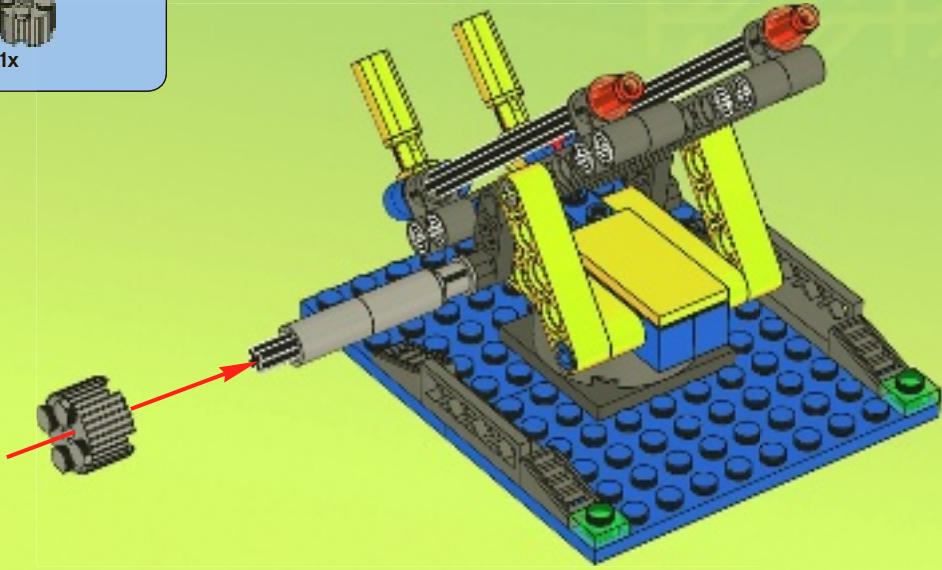



41

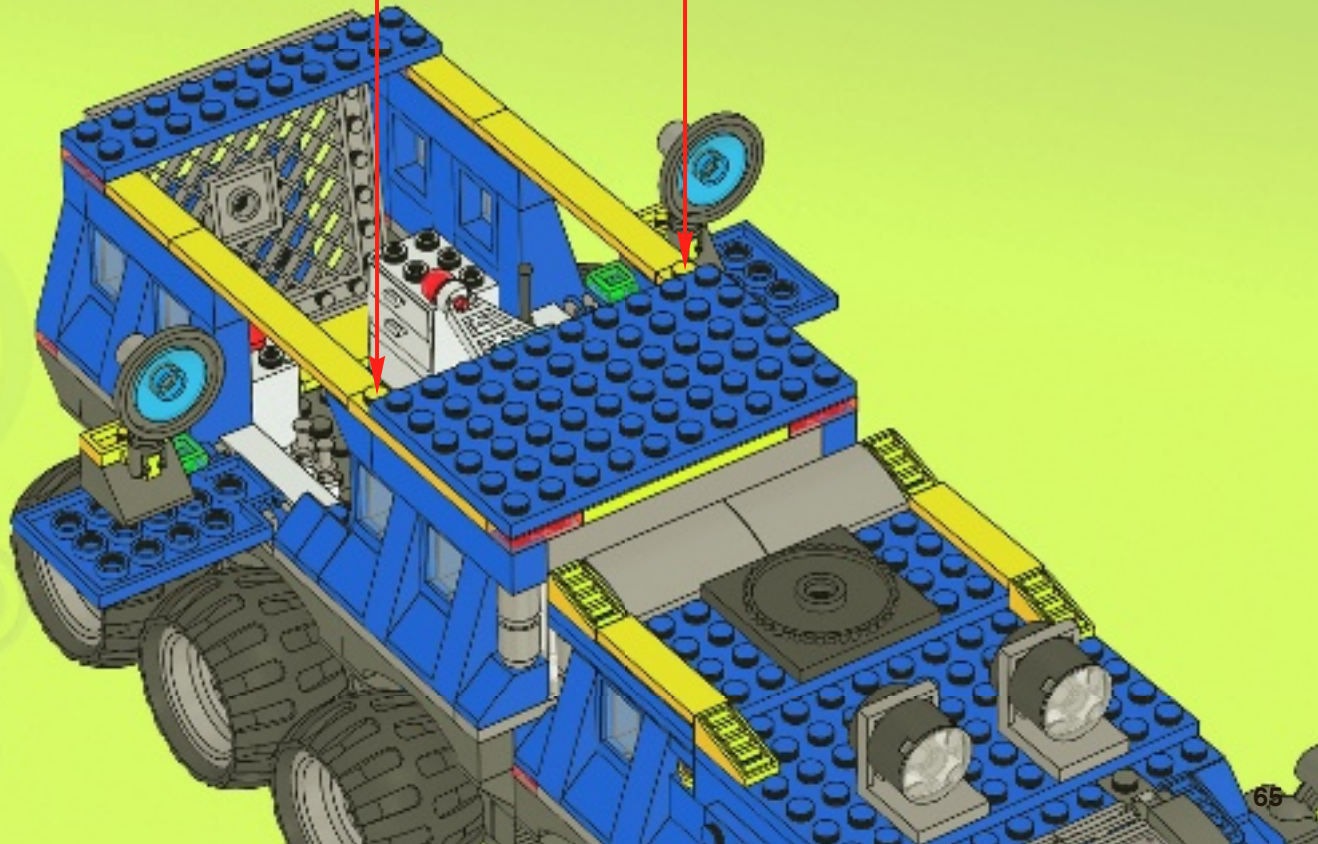
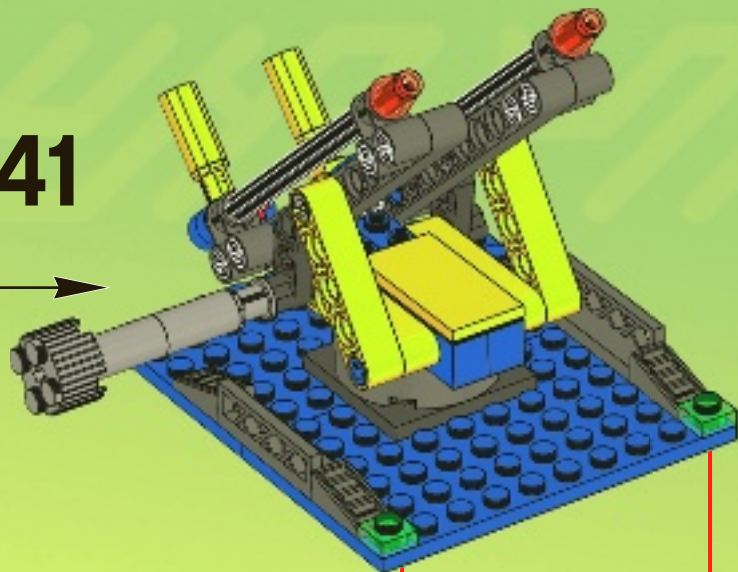

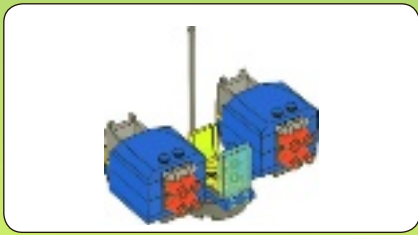

1

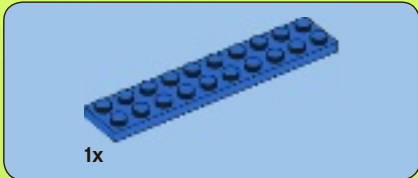

2



3

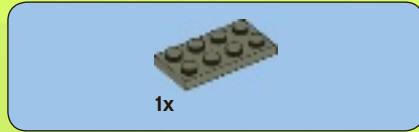

4





4x

5

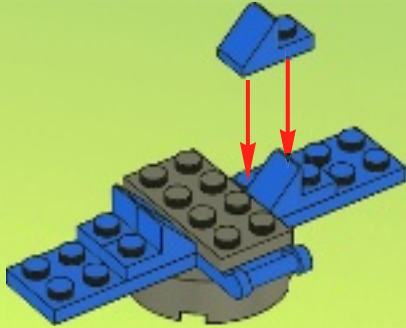

1x

7



2x



1x

6



1x

8

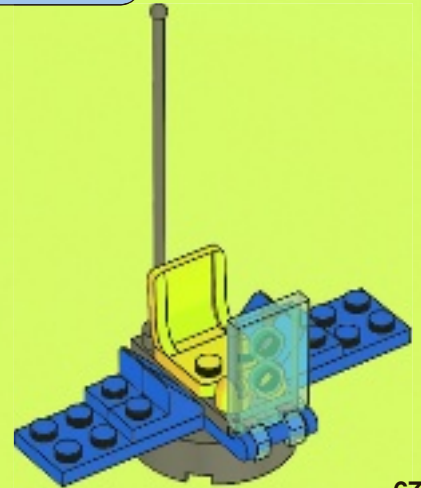

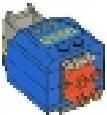

2x



1x

1



1x



1x

2



1x



1x

3

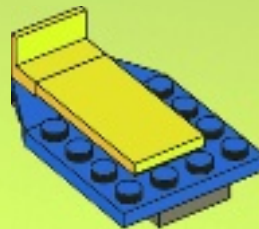

2x



1x

4

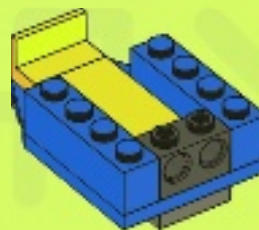





5

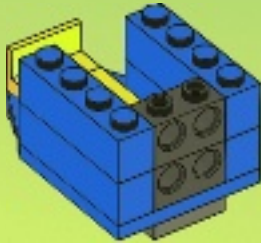

7

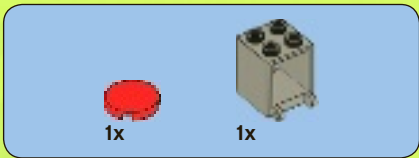
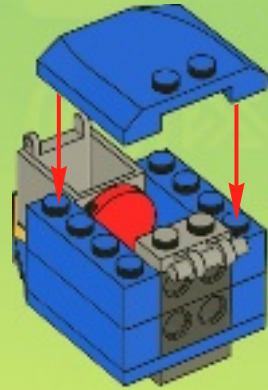

6

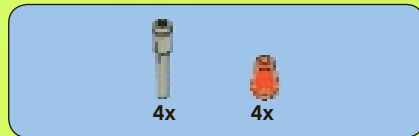
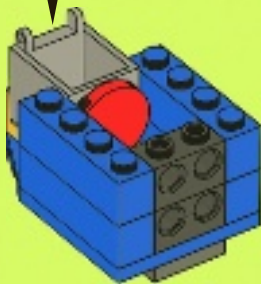
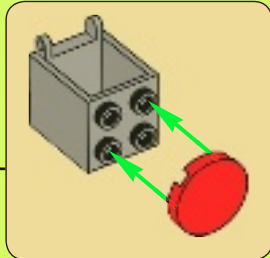

8

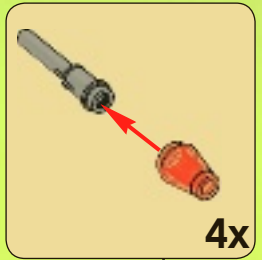

4x

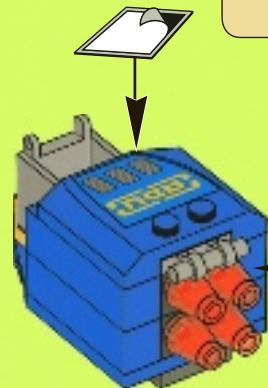

2x

9

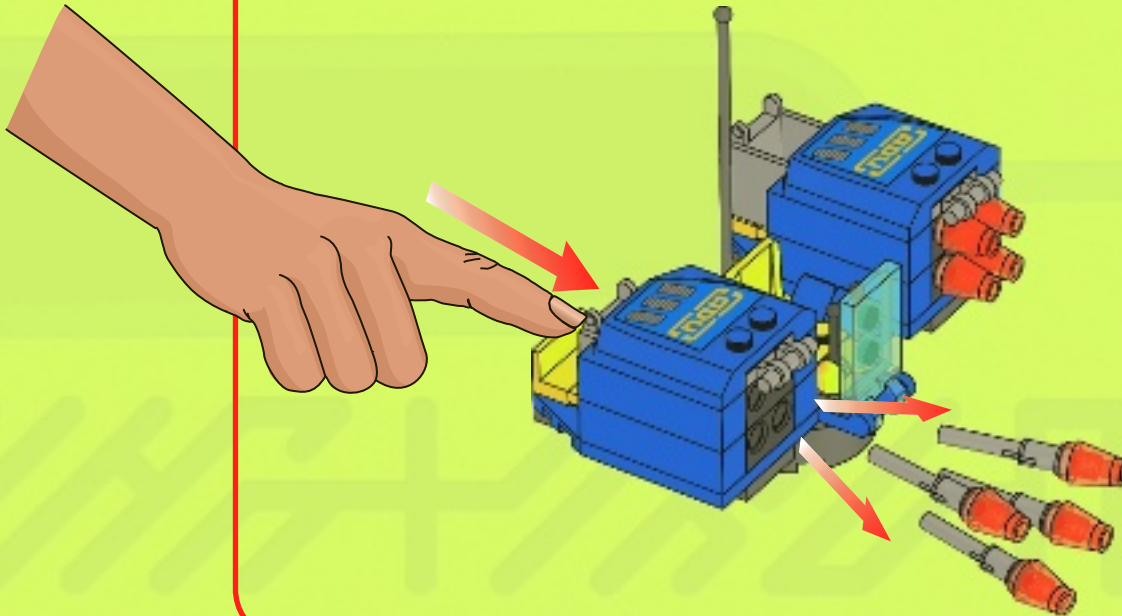
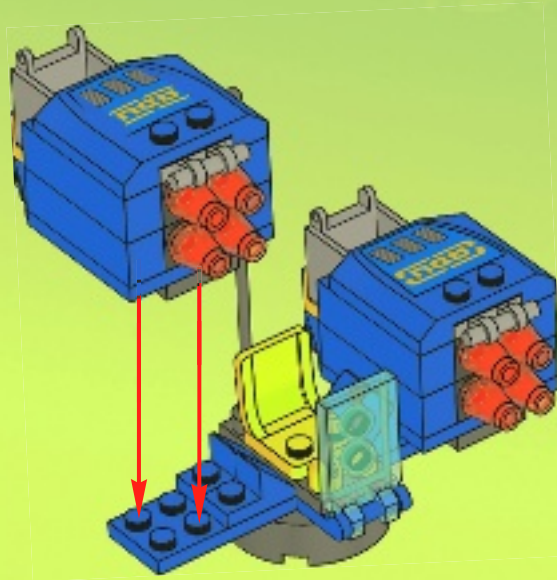

42

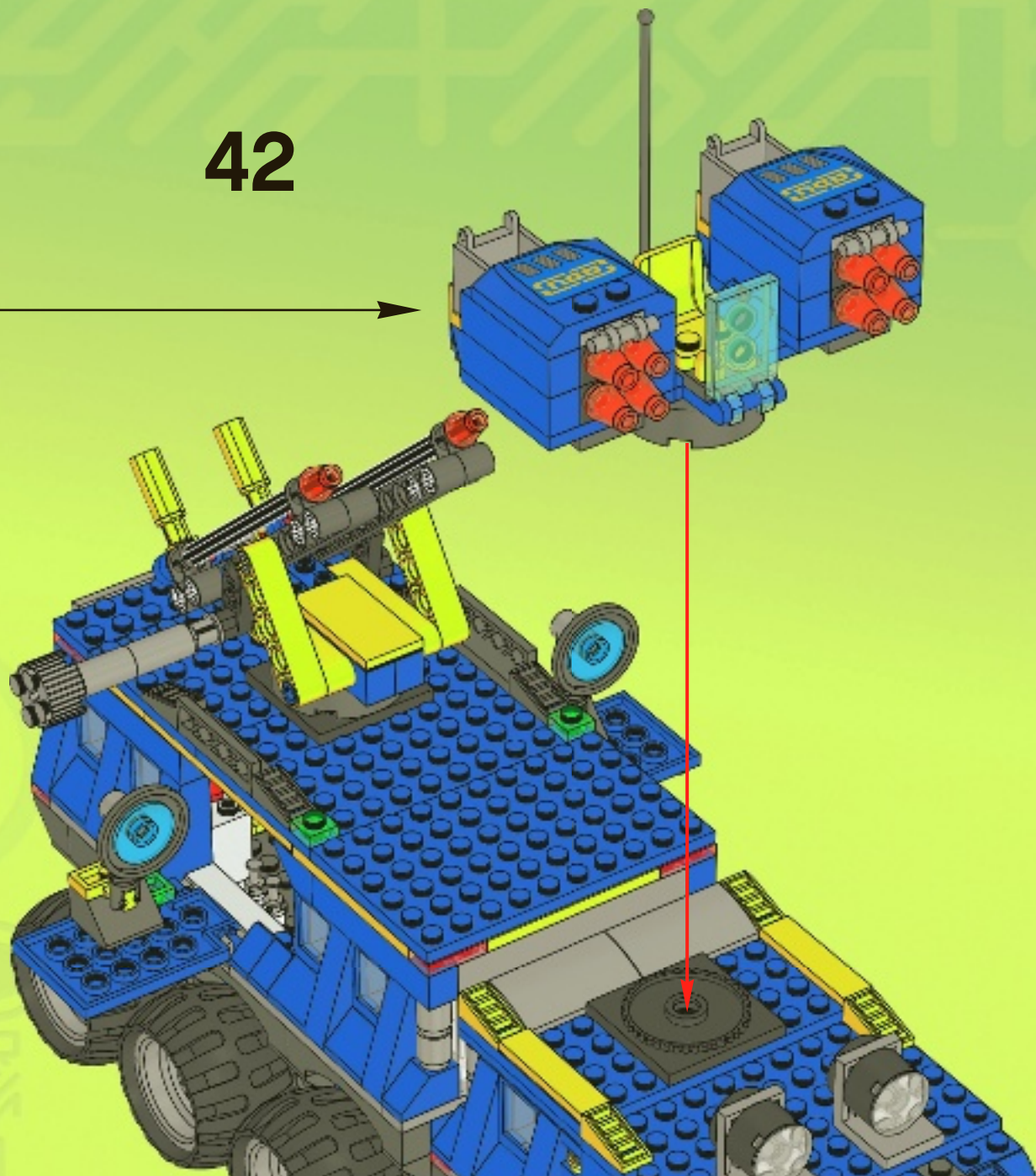



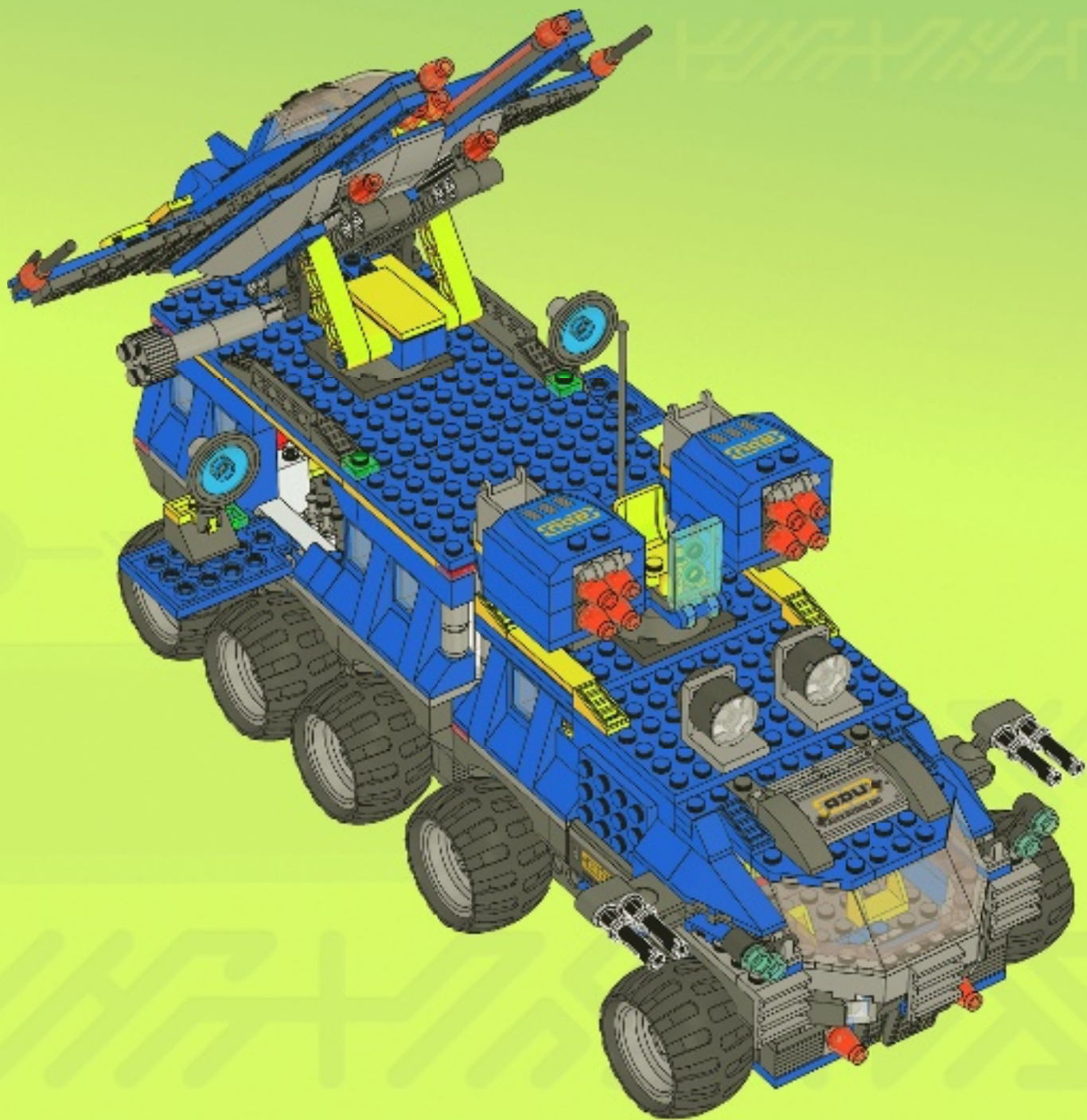





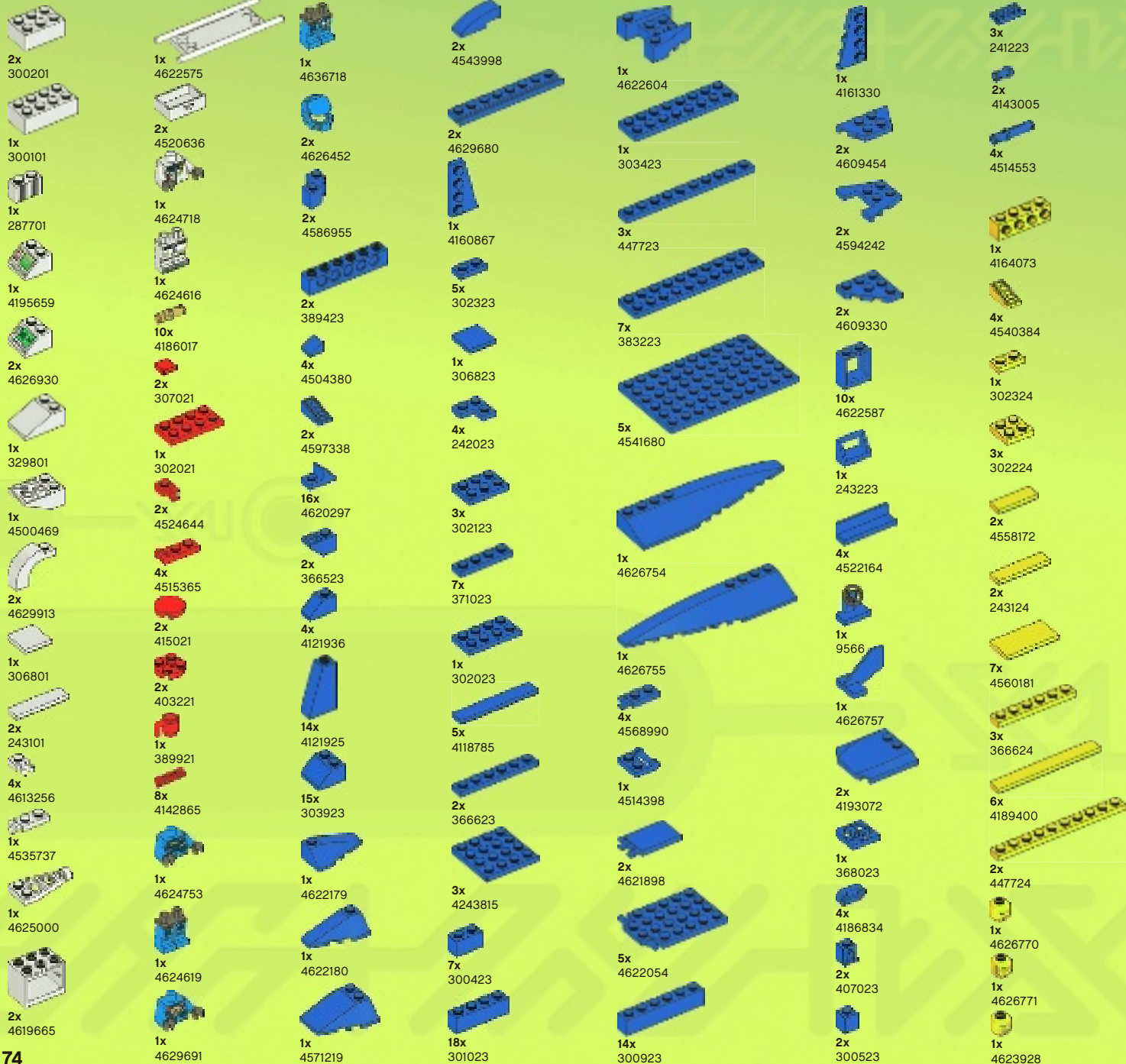







1x  
4211407



2x  
4211406



1x  
4211410



4x  
4622336



4x  
4211519



2x  
4180464



1x  
4211398



4x  
4211731



2x  
4211632



2x  
4211396



6x  
4211452



1x  
4211425



2x  
4521921



1x  
4514846



1x  
4211360



3x  
4211369



2x  
4541978



4x  
4211350



10x  
4598526



1x  
4556157



2x  
4530469



2x  
4211472



1x  
4571078



1x  
4218499



1x  
4603191



4x  
4163917



1x  
4626724



2x  
4244362



2x  
3005740



4x  
4278412



1x  
4623609



1x  
4624825



1x  
4624618



1x  
4623600



8x  
4540386



6x  
4211096



4x  
4621917



19x  
4211000



1x  
4211064



4x  
4246896



10x  
4620760



3x  
4211063



2x  
4221879



1x  
4211094



3x  
4211043



2x  
4211001



2x  
4560184



3x  
4211065



3x  
4211056



2x  
4529727



2x  
4529728

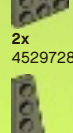

1x  
4209014



1x  
4586562



2x  
4219725



6x  
4632574



1x  
4211051



1x  
4211051



2x  
4210698



2x  
4504378



1x  
4289542



2x  
4211187



2x  
4210865



3x  
4623236



2x  
4210695



4x  
4211103



1x  
4211085



8x  
4210636



4x  
4210935



2x  
4619760



2x  
4558959



4x  
4210655



2x  
4289258



2x  
4504378



1x  
4289542



2x  
4243831



3x  
4211002



1x  
4211061



6x  
4211114



1x  
4210642



1x  
4210872



1x  
4210869



1x  
4583688



2x  
4603472



4x  
4256828



Customer Service

Kundenservice

Service Consommateurs

Servicio Al Consumidor

[www.lego.com/service](http://www.lego.com/service) or dial



00800 5346 5555 :



1-800-422-5346 :







# ALIEN CONQUEST



7067

7065

7050

7051

7049

7066

7052

[ALIENCONQUEST.LEGO.COM](http://ALIENCONQUEST.LEGO.COM)





# ALIEN CONQUEST



[ALIENCONQUEST.LEGO.COM](http://ALIENCONQUEST.LEGO.COM)







[www.LEGOclub.com](http://www.LEGOclub.com)



LEGO® Club Email

**LEGO club**™

**FREE! GRATIS! GRATUIT!**



LEGO® Club Magazine

**SIGN UP ONLINE!**

**[www.LEGOclub.com](http://www.LEGOclub.com)**



**00800 5346 5555\***



**1-866-534-6258 • 1-877-518-5346**

US & Canada only

Canada seulement

\* Freephone. Mobile charges may apply.  
\* Numéro sans frais. Des frais peuvent s'appliquer avec les téléphones cellulaires.  
\* Gebührenfrei, Kosten für Anrufe aus Mobilfunknetzen können abweichen.  
\* Gratis telefonnummer vanaf vaste lijn.  
\* Det er et gratis nummer, når du ringer fra fasttelefon.  
\* Det är gratis, när du ringer från en fast telefon.  
\* Numéro sans frais. Des frais peuvent s'appliquer avec les téléphones portables.



# WIN!

Go to [www.LEGOsurvey.com/product](http://www.LEGOsurvey.com/product) to fill out a survey for a chance to win a cool LEGO® Product. No purchase necessary. Open to all residents where not prohibited.

 [www.LEGO.com](http://www.LEGO.com)



## [www.LEGOsurvey.com/product](http://www.LEGOsurvey.com/product)

### GEWINNE! WIN!

Nimm an der Umfrage auf [www.LEGOsurvey.com/product](http://www.LEGOsurvey.com/product) teil und hab die Chance ein cooles LEGO® Produkt zu gewinnen!  
Die Teilnahme am Gewinnspiel führt zu keinerlei Kaufverpflichtungen. Teilnahme in allen nicht ausgeschlossenen Ländern möglich.

Ga naar [www.LEGOsurvey.com/product](http://www.LEGOsurvey.com/product), vul een enquêteformulier in en maak kans op een cool LEGO® product.  
Geen aankoopverplichting. Iedereen mag deelnemen, uitgezonderd ingezetenden van landen waar een enquêteverbod geldt.

### GAGNE! 当てよう!

Visite [www.LEGOsurvey.com/product](http://www.LEGOsurvey.com/product) pour répondre à un questionnaire et avoir une chance de gagner un produit LEGO® très cool!  
Aucune obligation d'achat. Ouvert à tous les résidents des pays autorisés.

[www.LEGOsurvey.com/product](http://www.LEGOsurvey.com/product) にアクセスして、アンケートにご記入ください。当選者にはレゴ®製品を差し上げます。  
お買い上げの必要はありません。  
禁止されていない限り、すべての皆様にご利用いただけます。