



DINO



5885



1

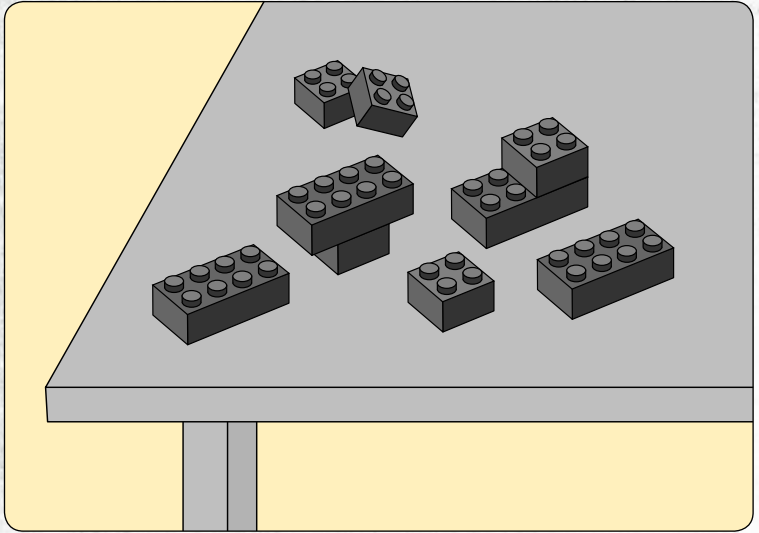
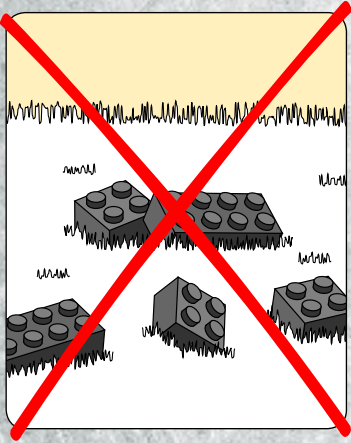

2

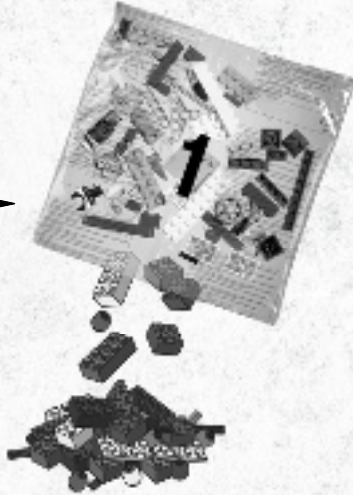

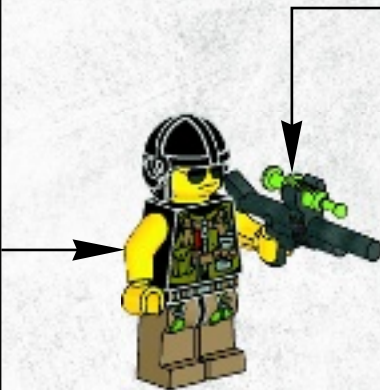
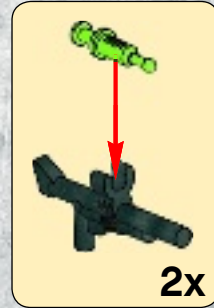
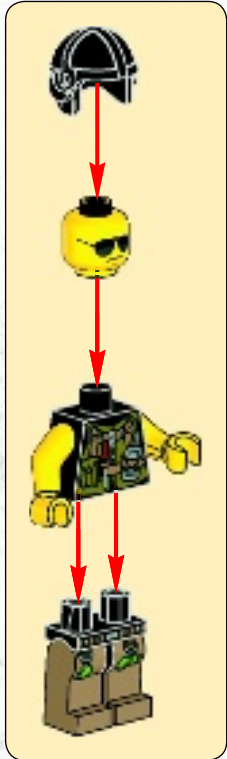
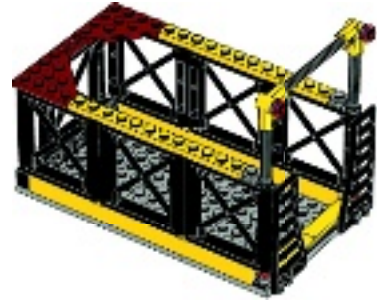

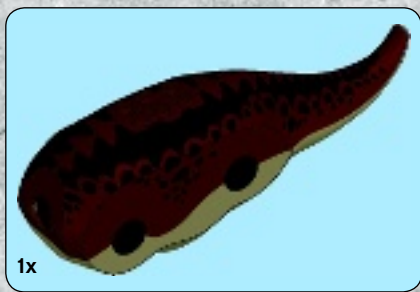

1



2



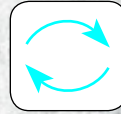
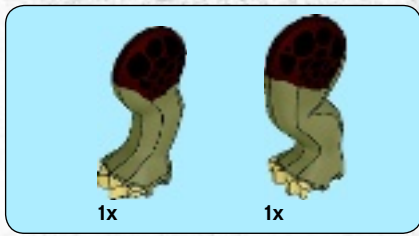

3

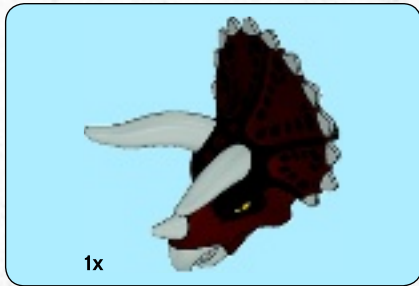

4



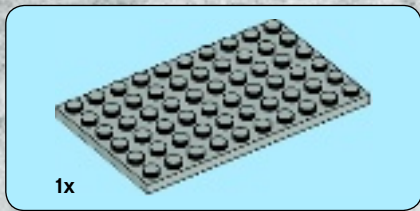
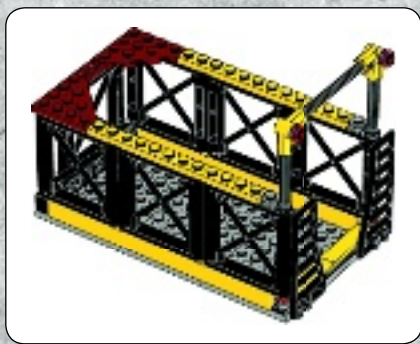

1

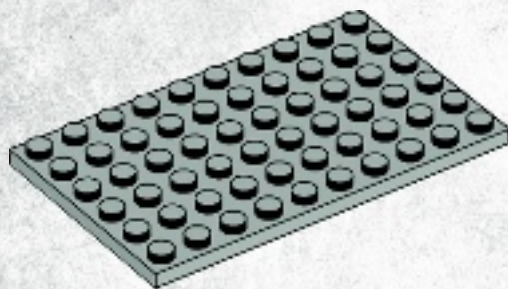

2

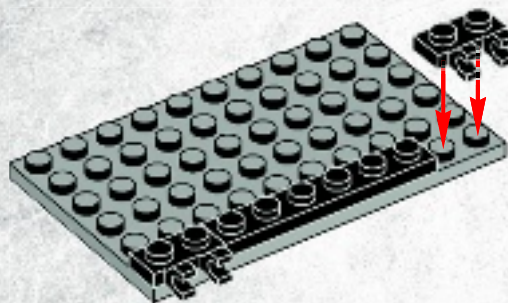



3

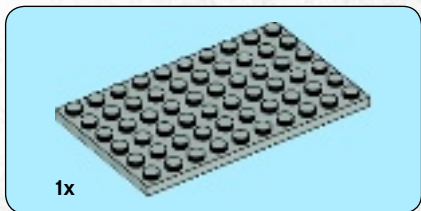
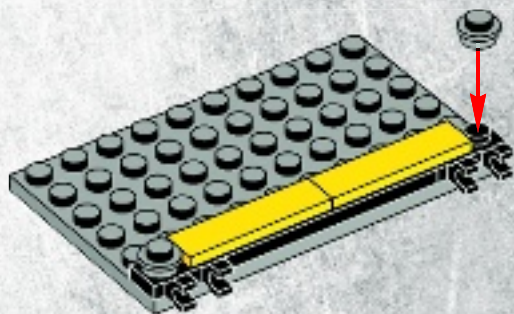

4

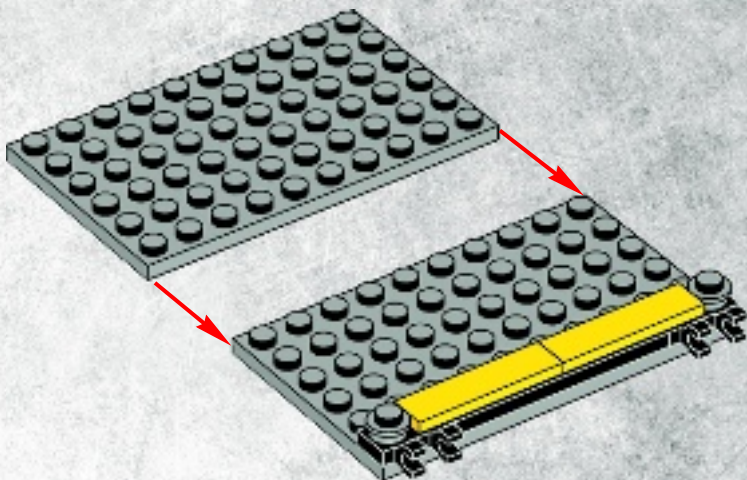

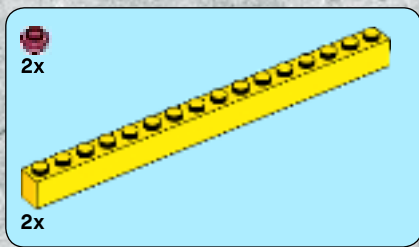

5

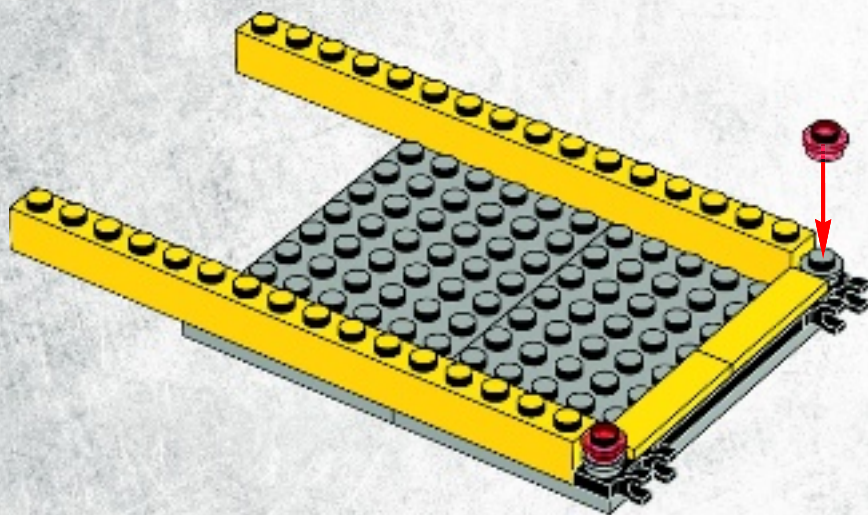

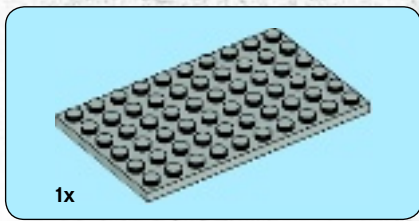

6

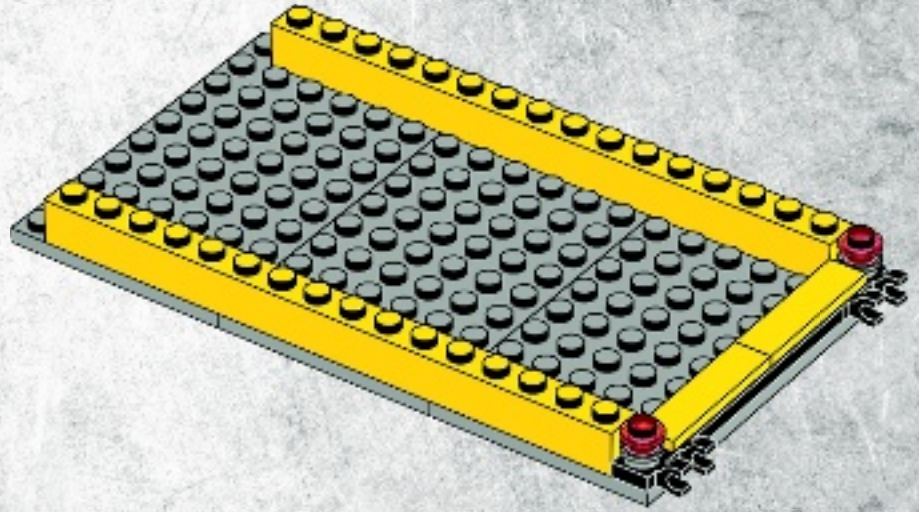

7

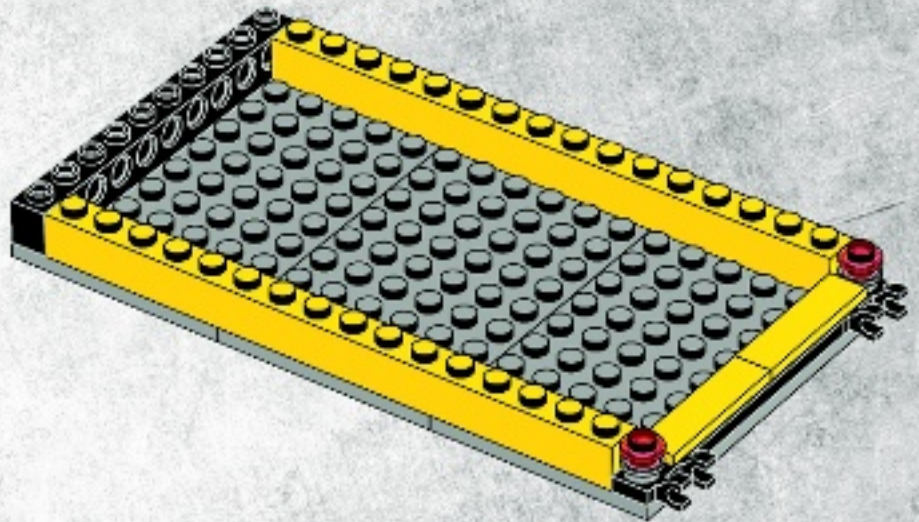

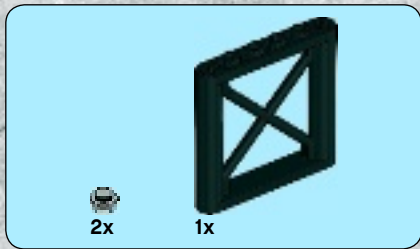

8

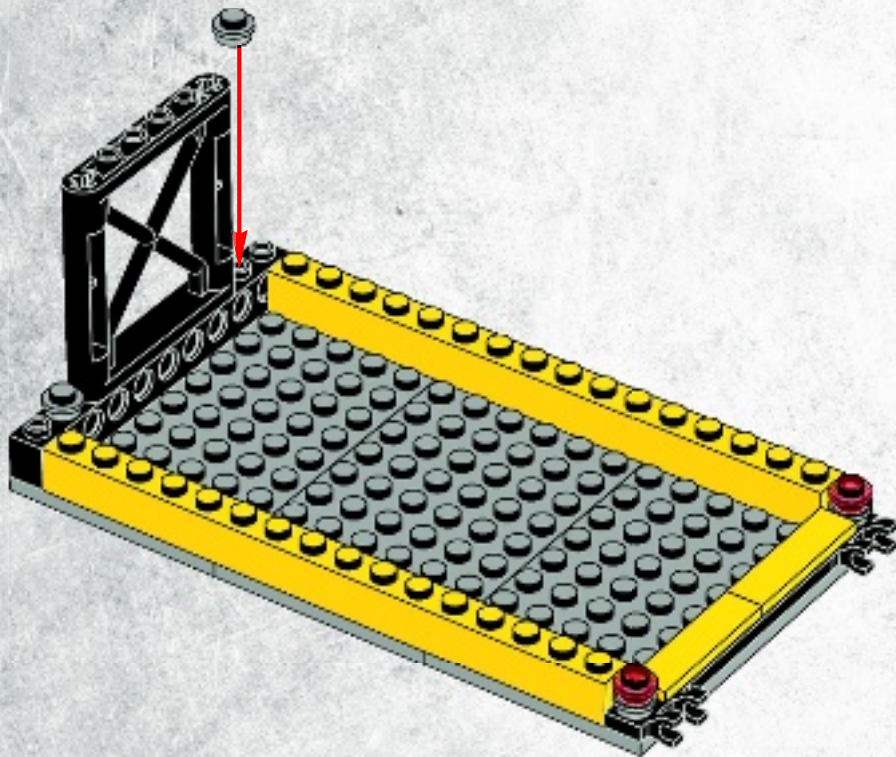



9

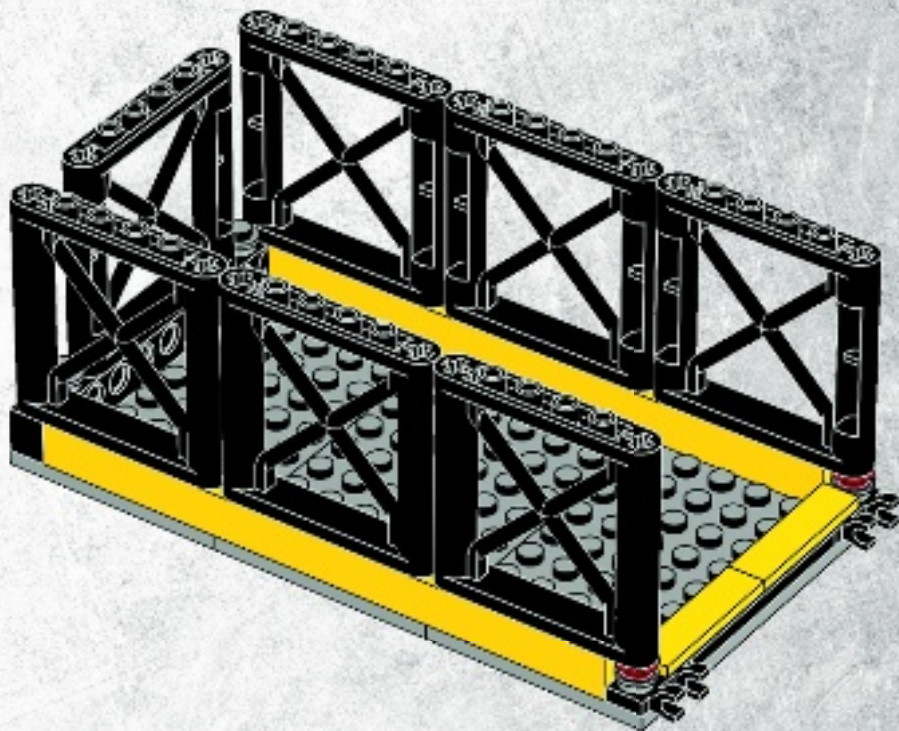



10

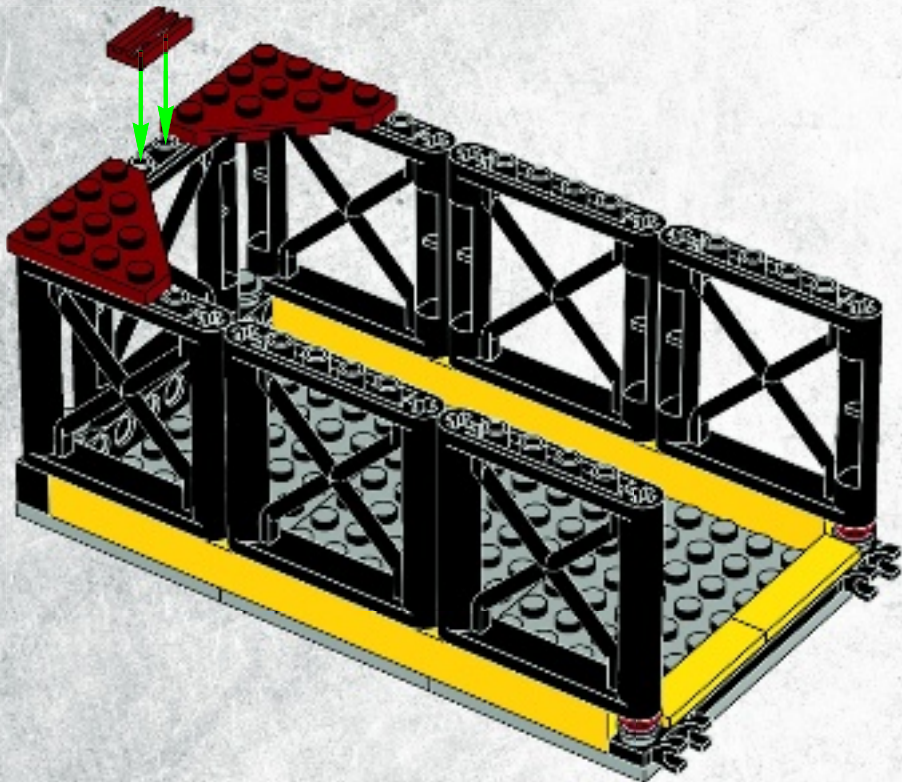

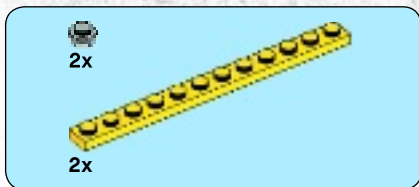

11

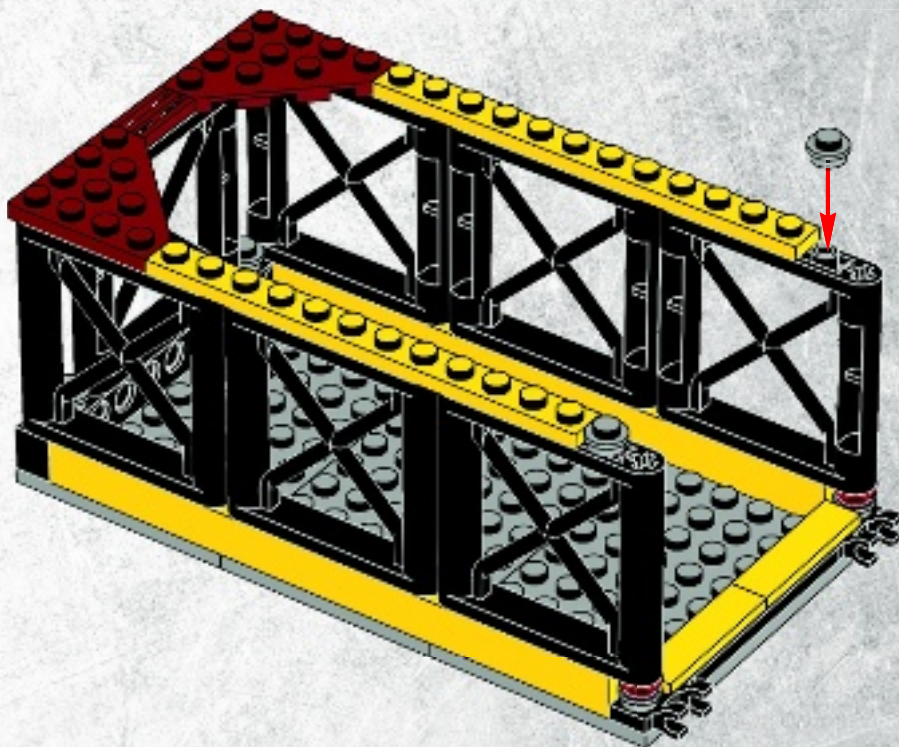



2x

12

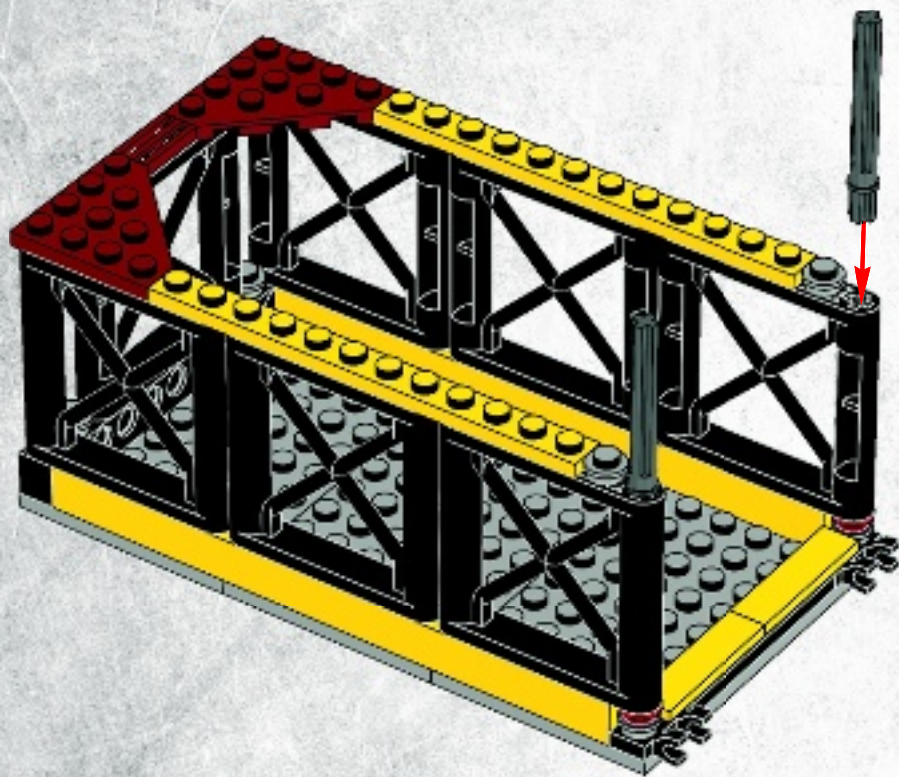

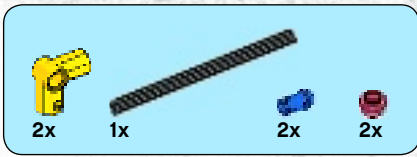

13

1



2

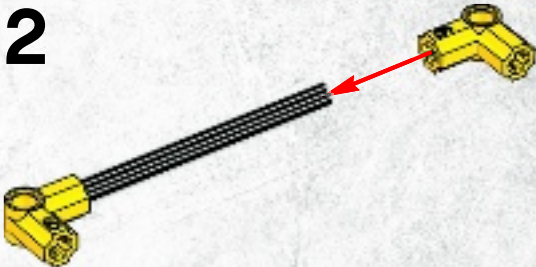

3

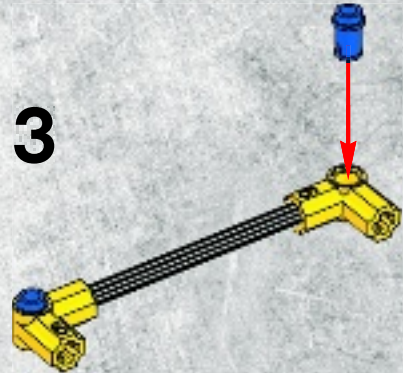

4

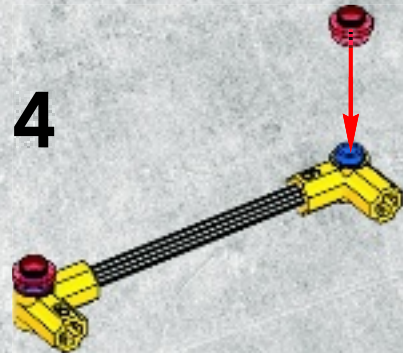

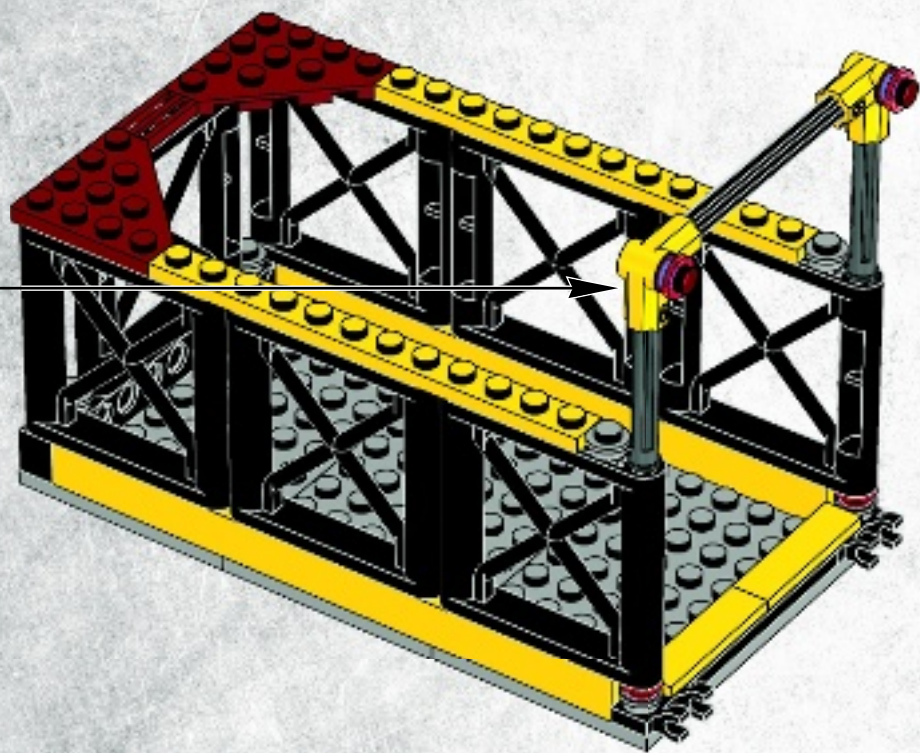



2x

14

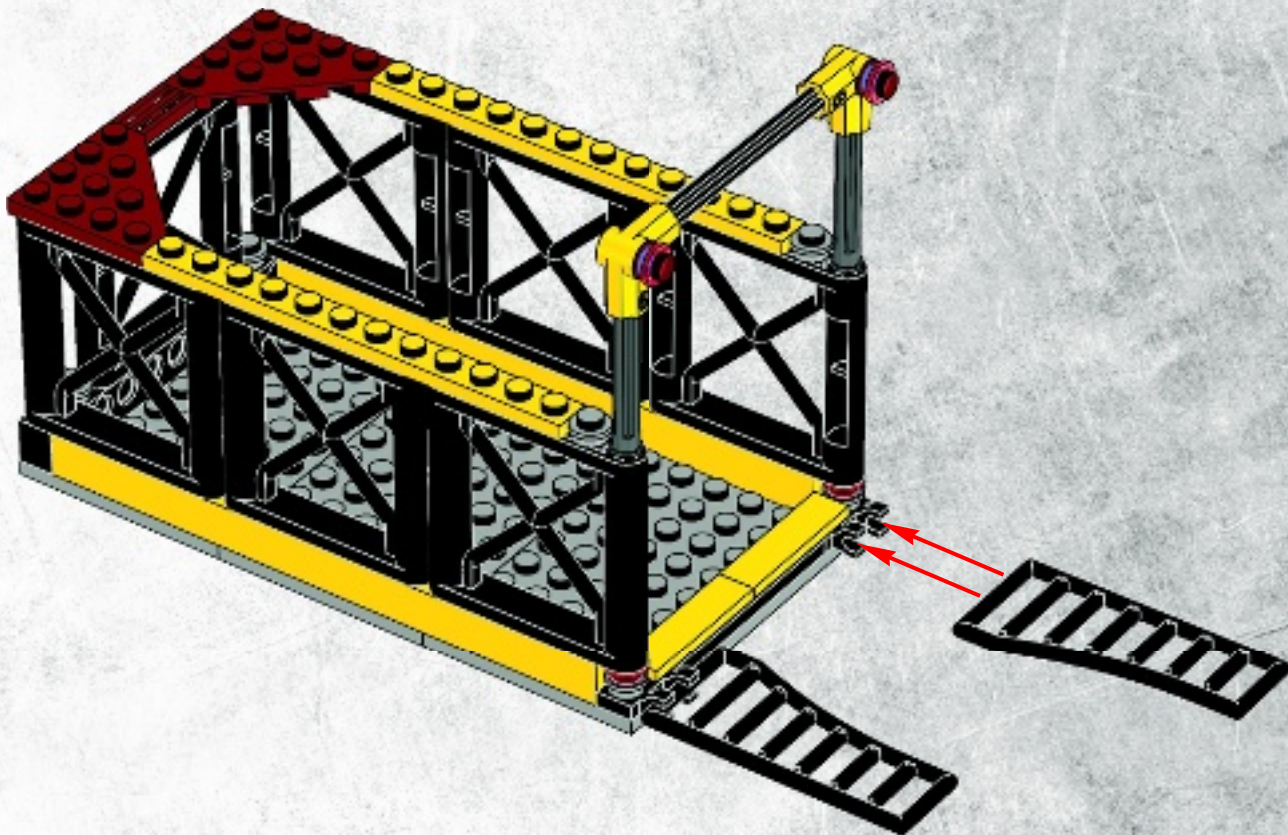

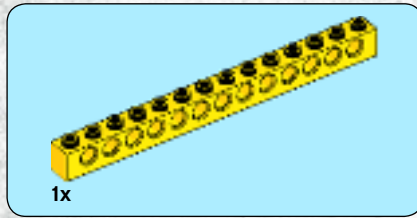

1

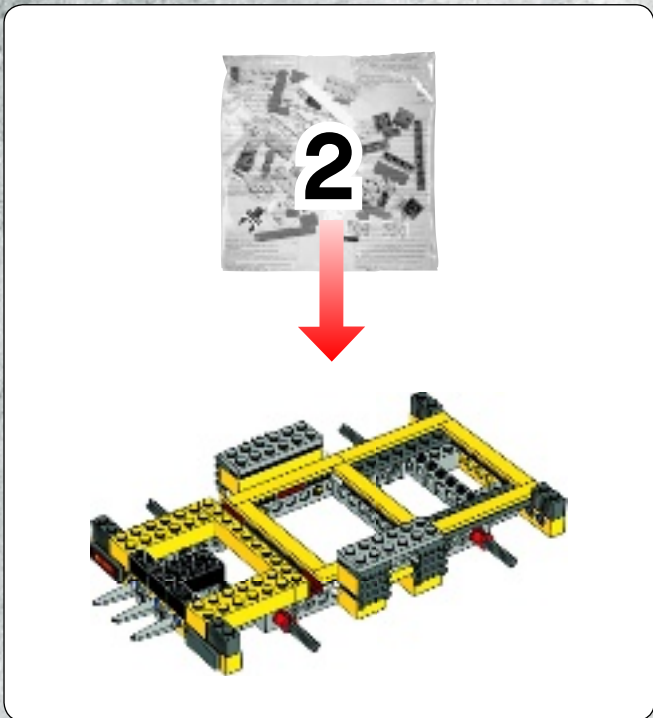
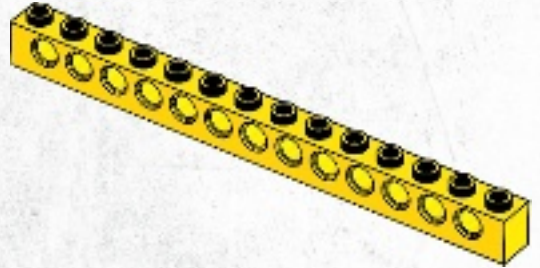

2

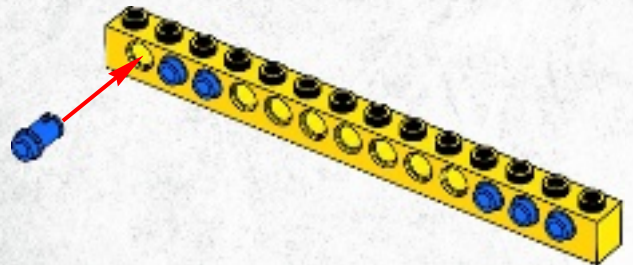



3

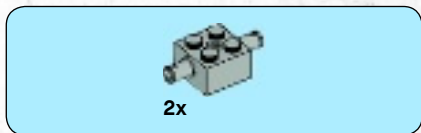
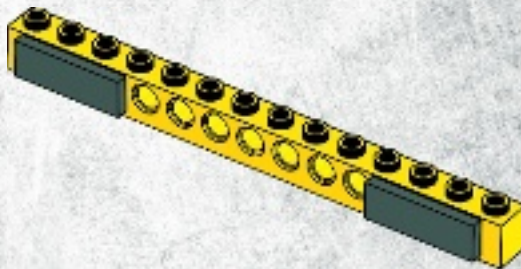

4

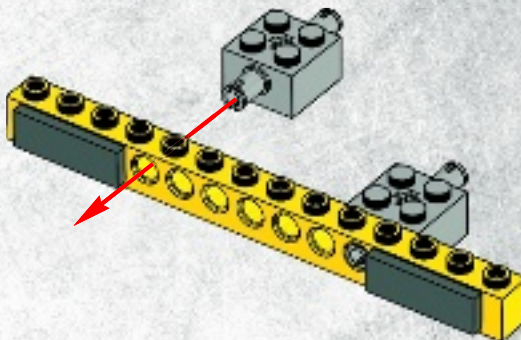



5x

5

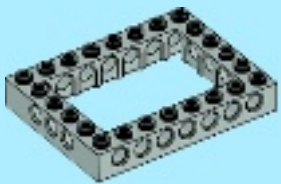
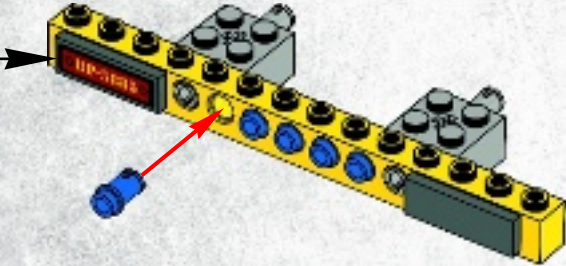

1x

6

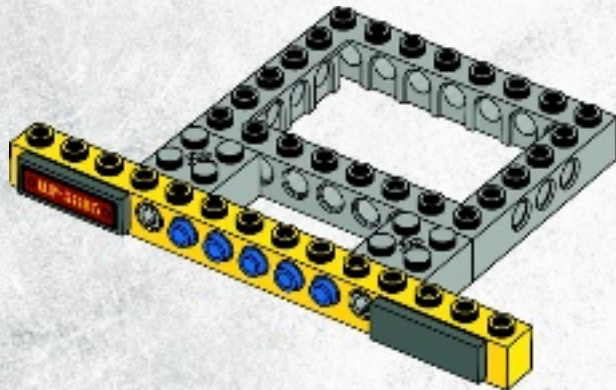



2x



3x

7

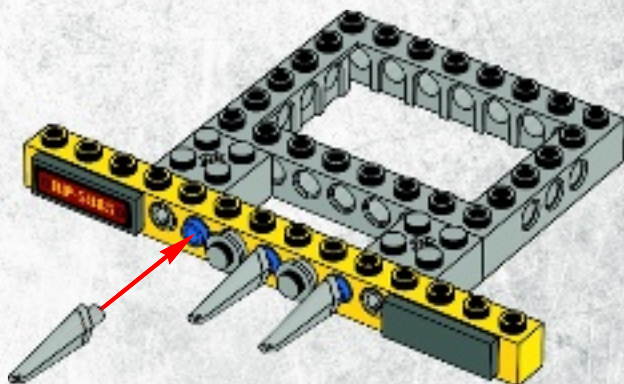

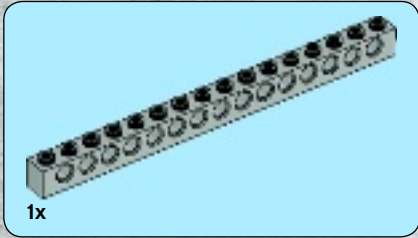

1

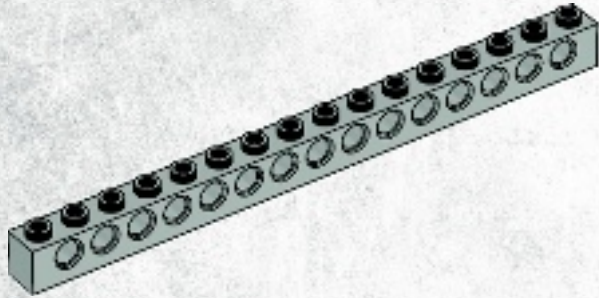

2

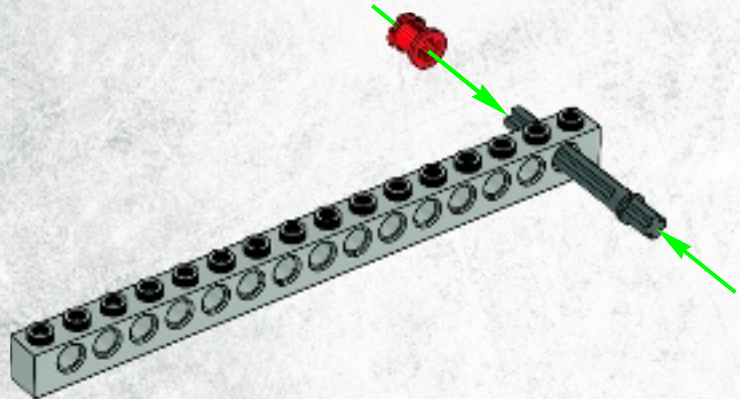

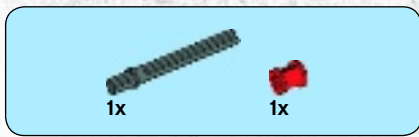

3

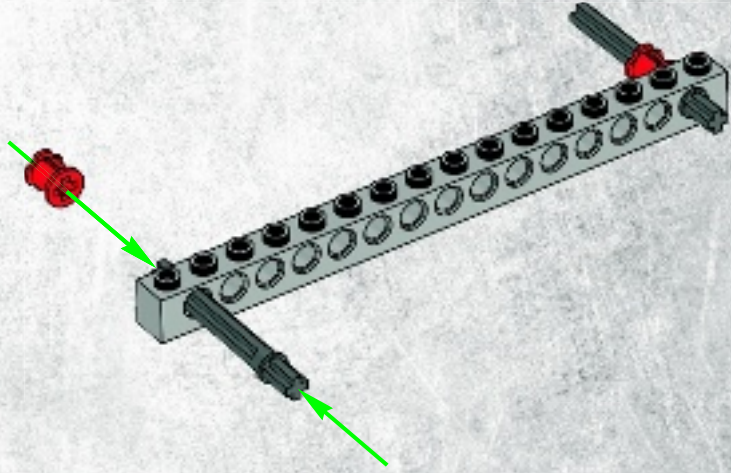

4



8

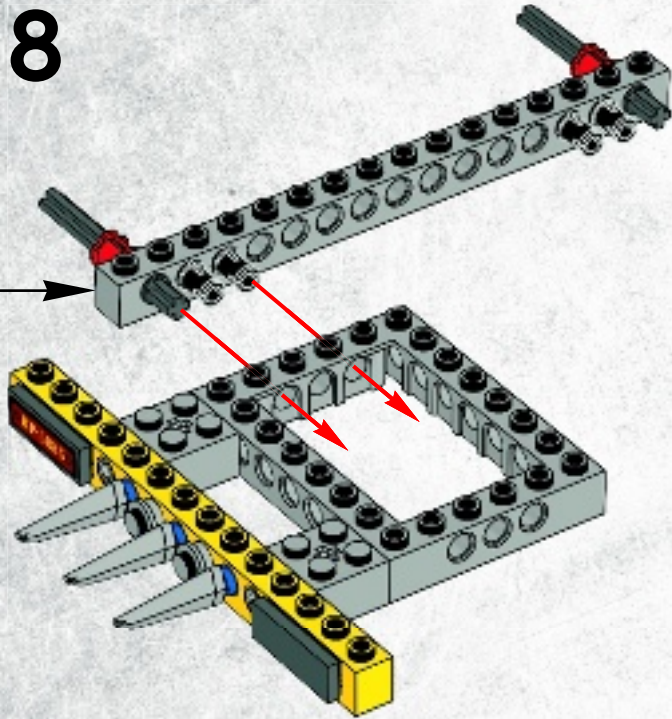

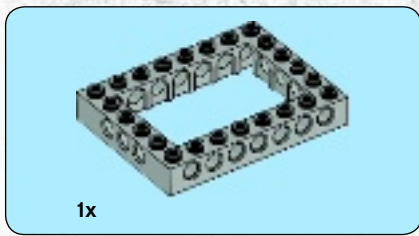

9

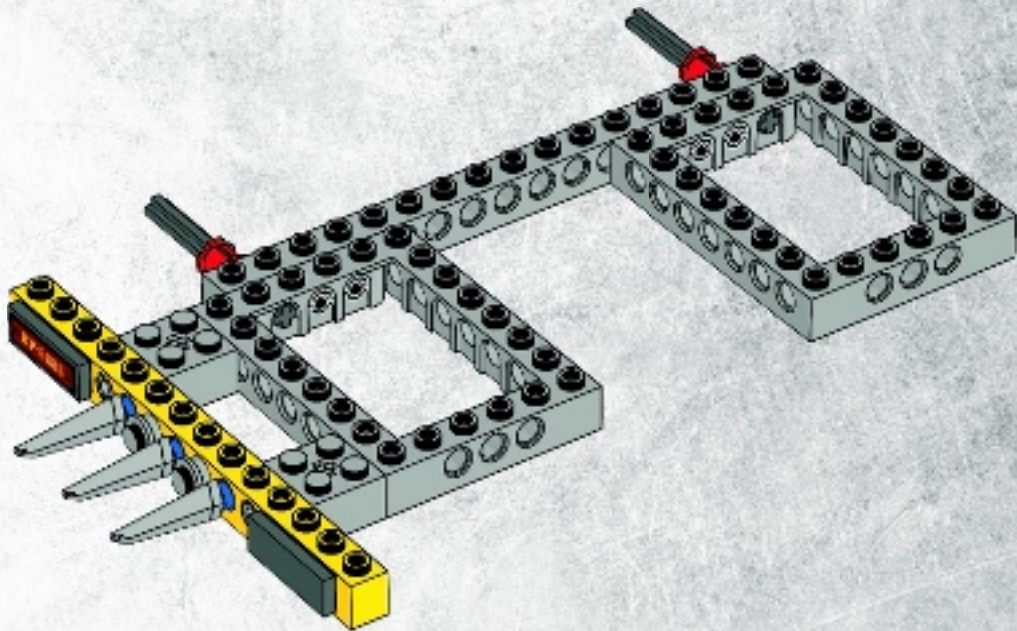

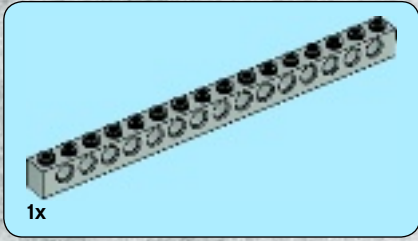

1

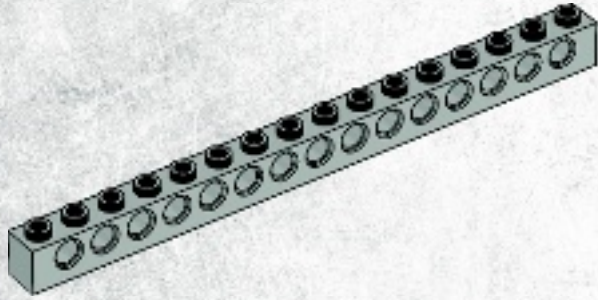

2

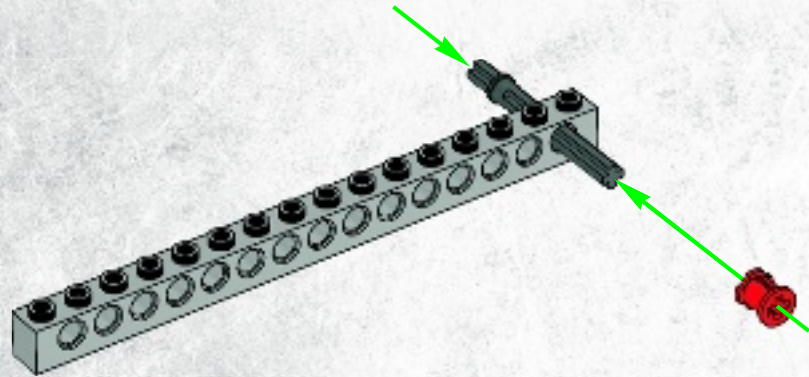

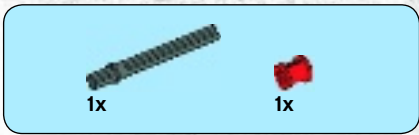

3

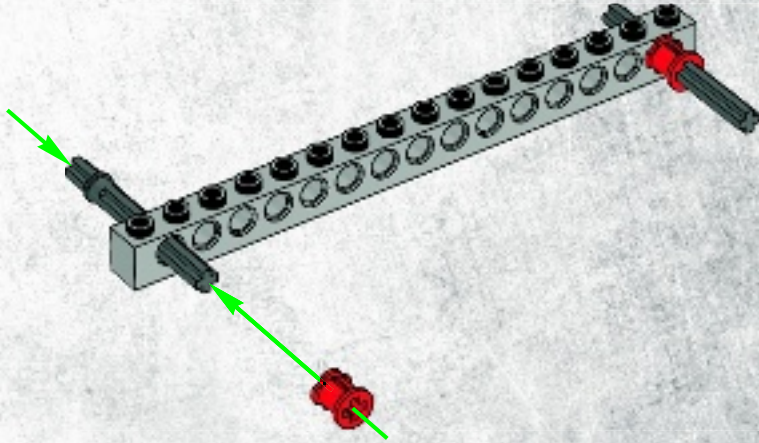

4

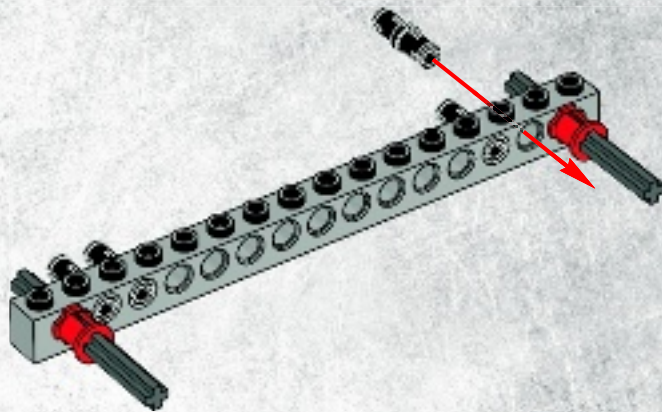

10

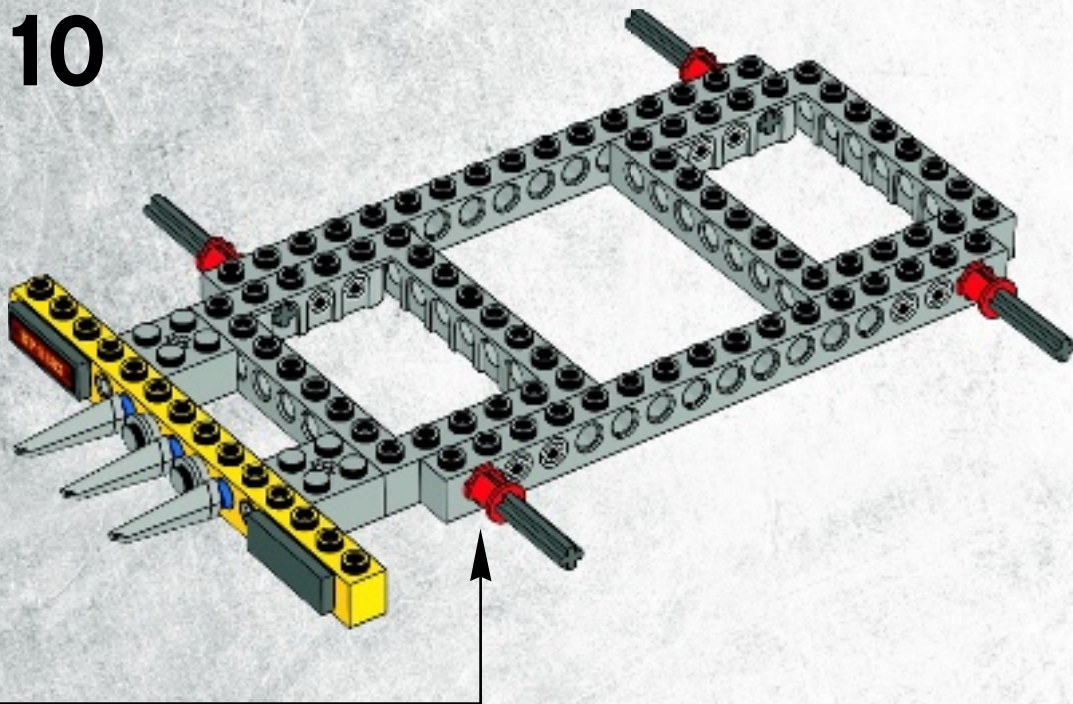

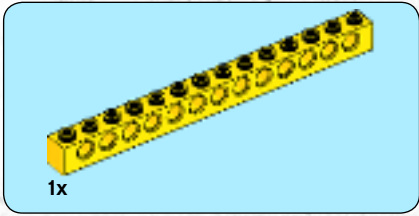
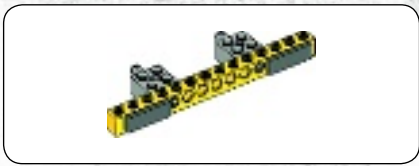

1

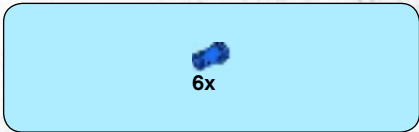

2





2x

3

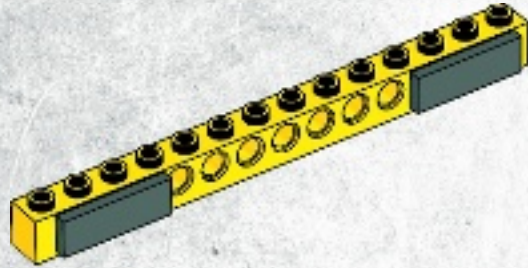

2x

4

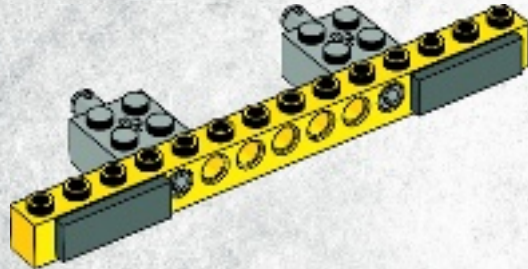

11

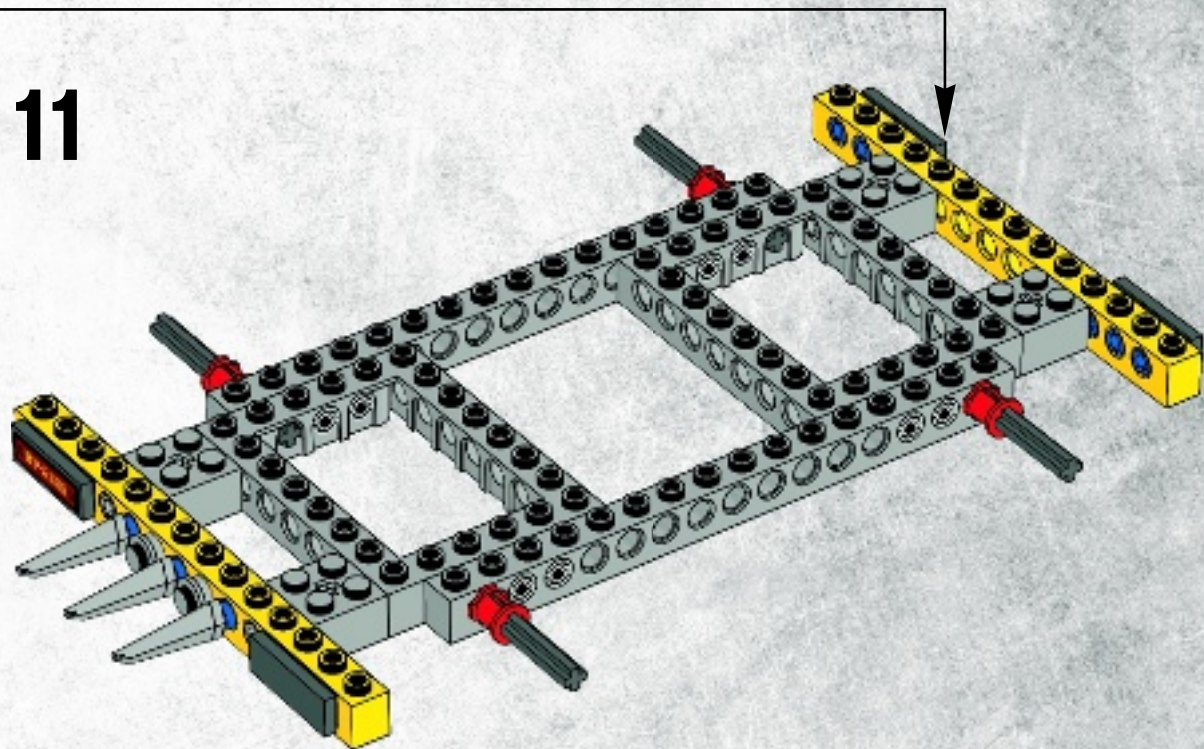

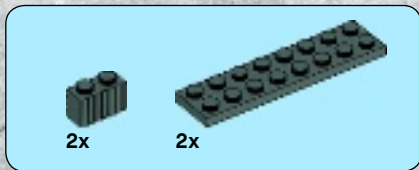

12

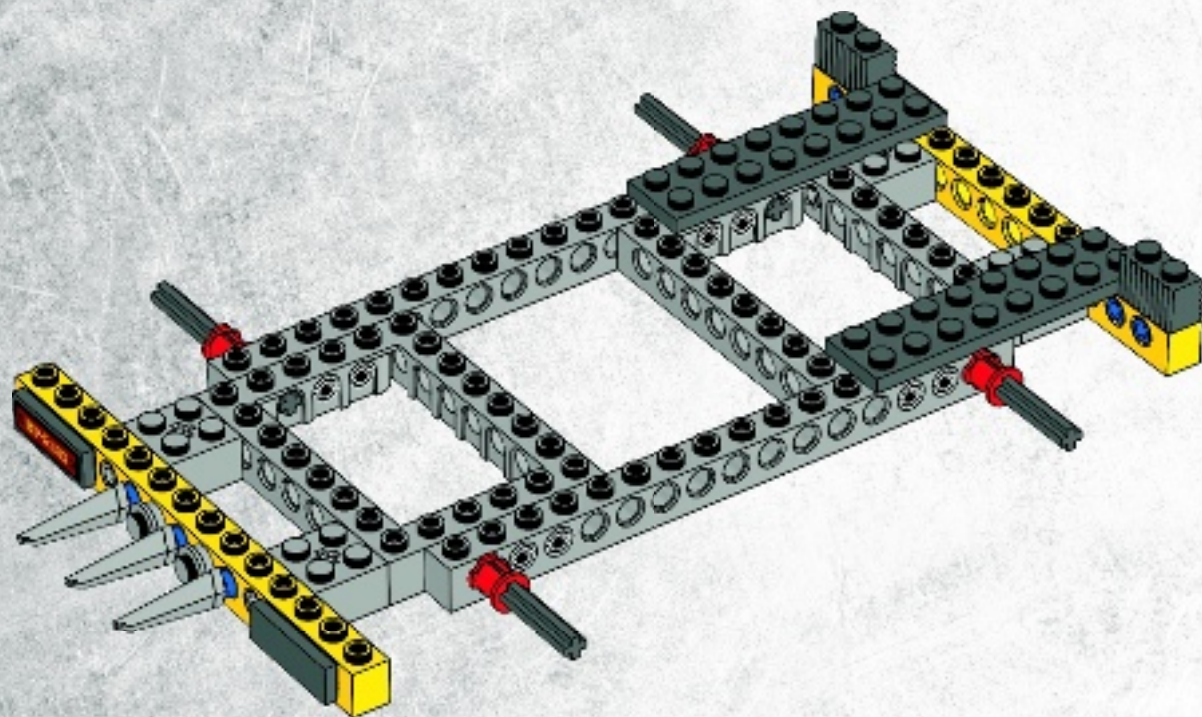



13

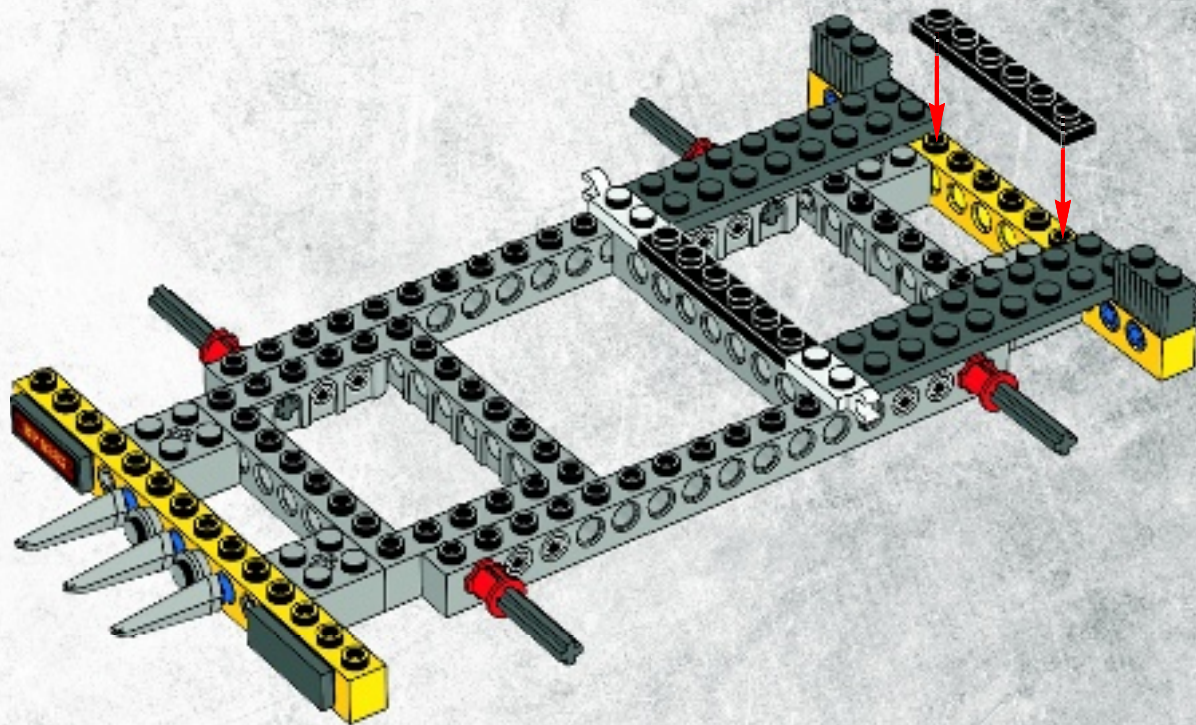



2x

14

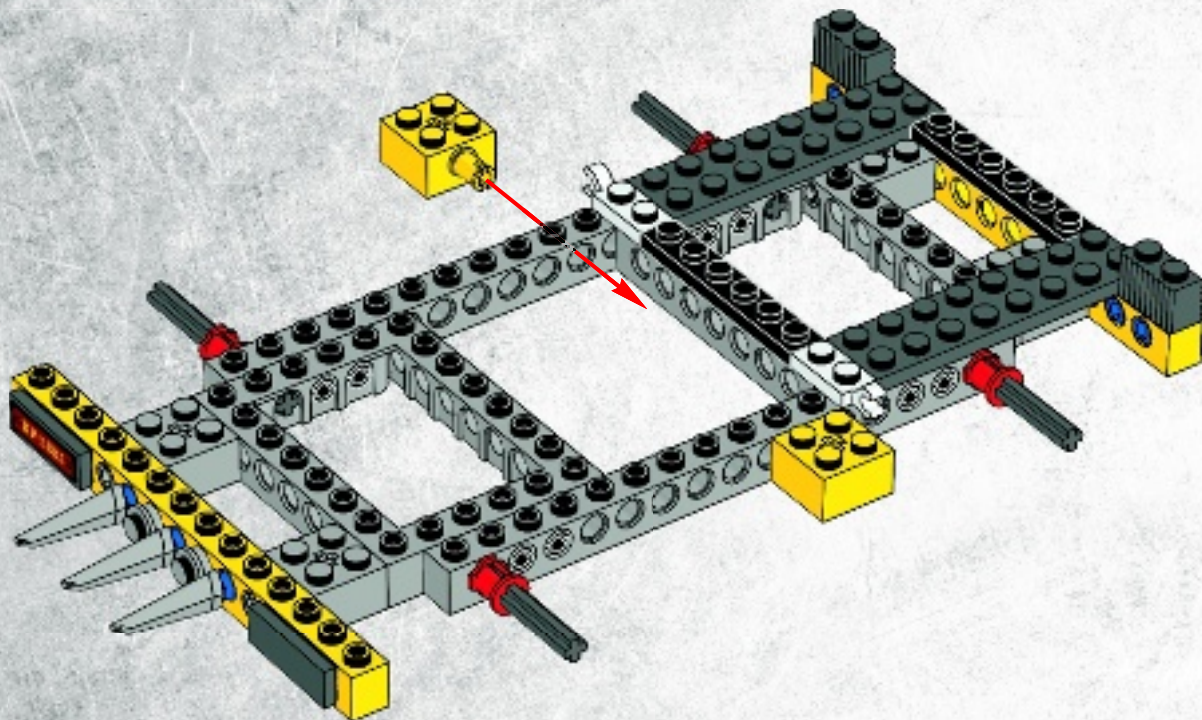



15

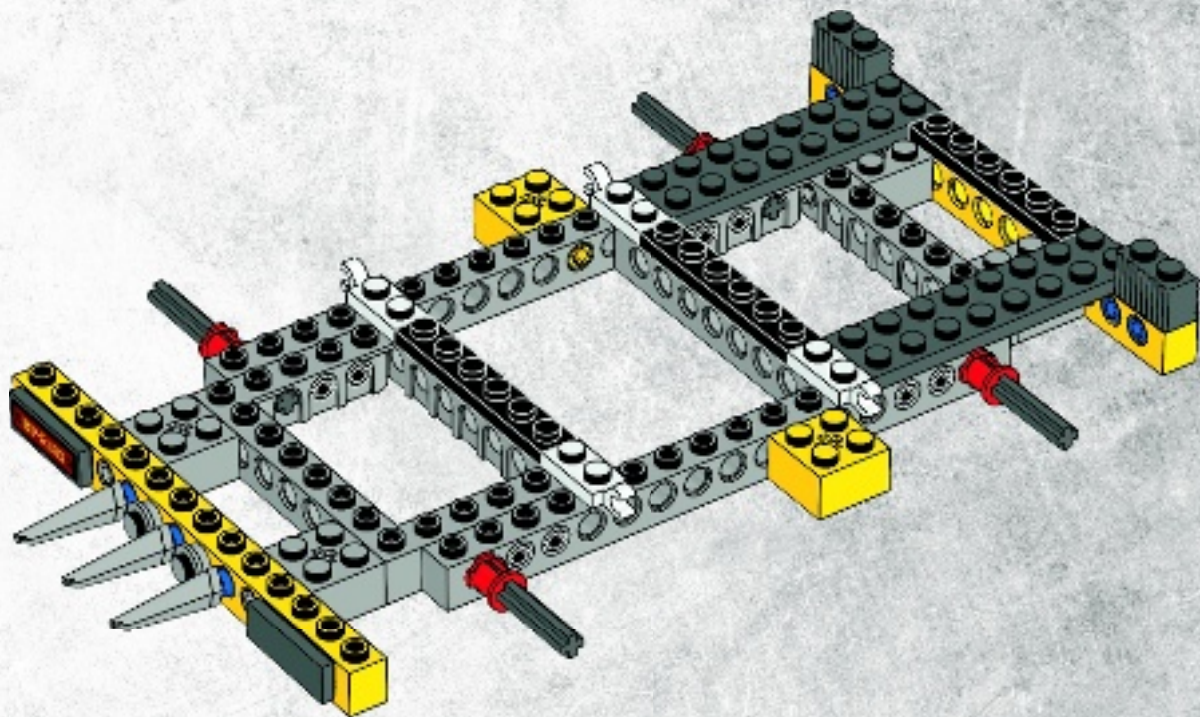



2x



2x

16

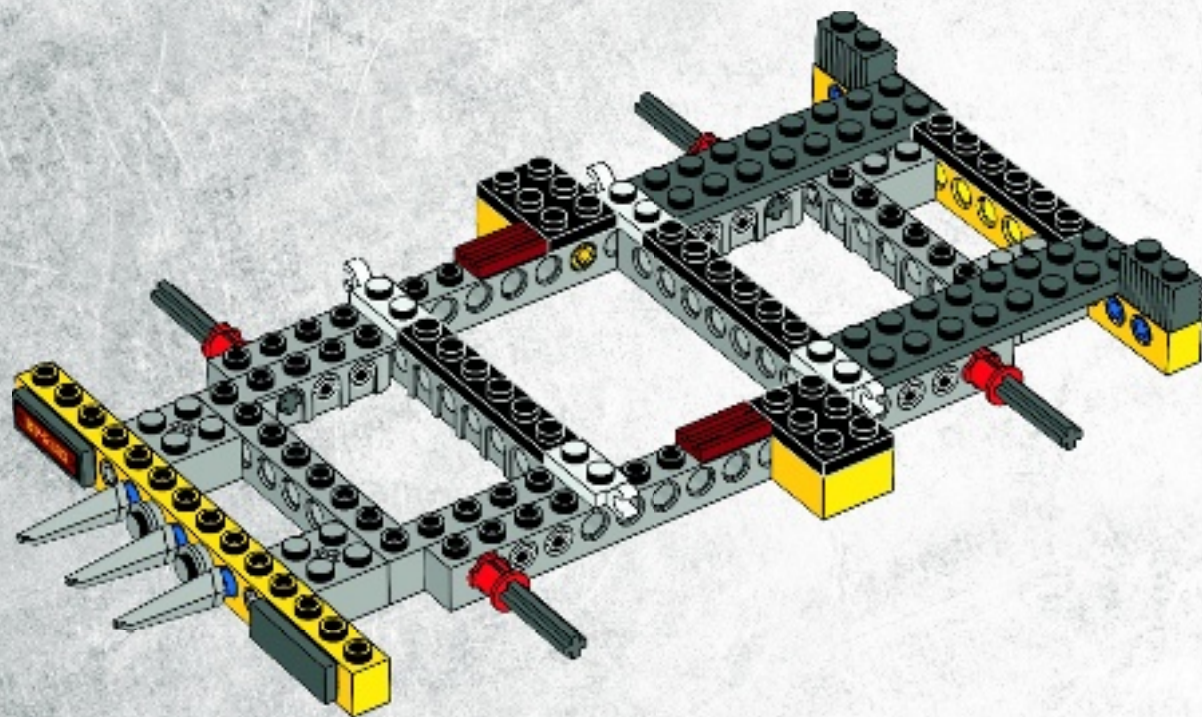



2x

17

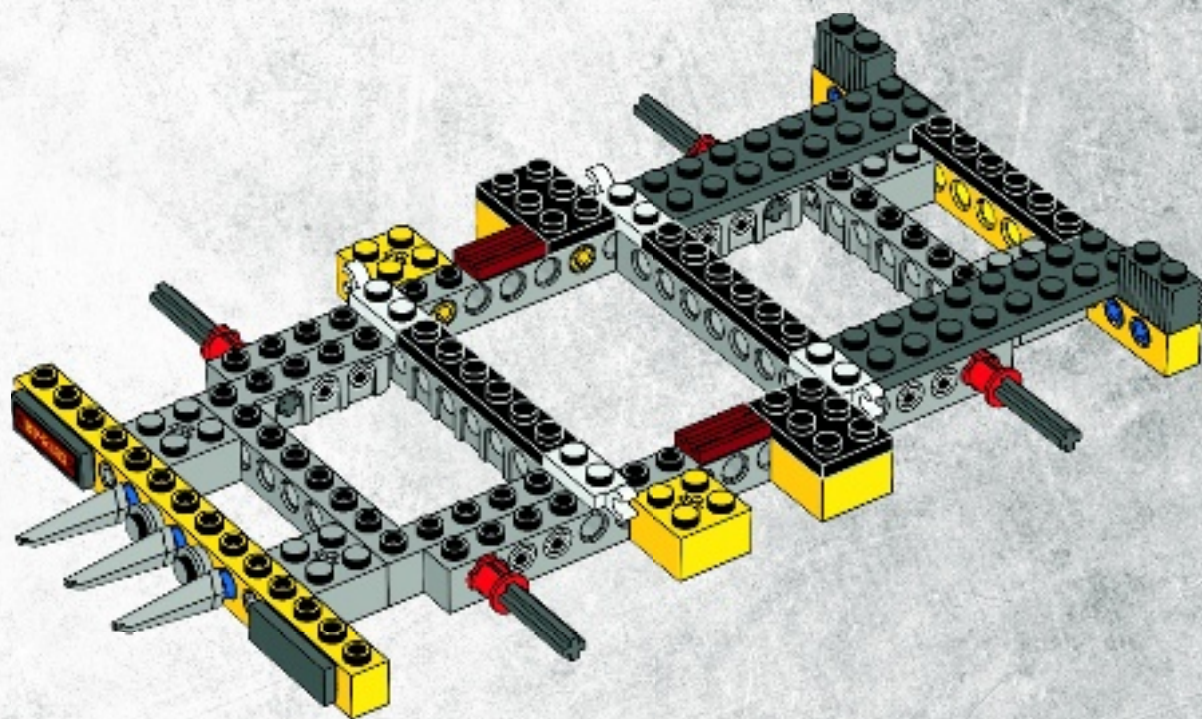



2x

18

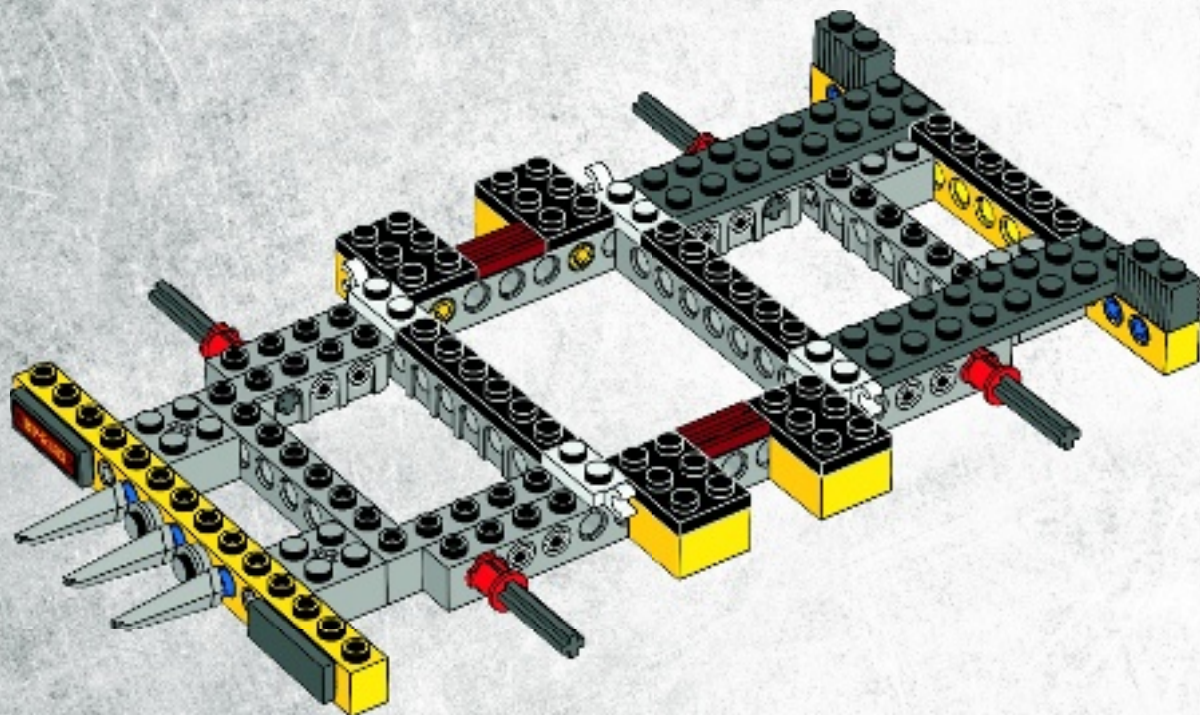

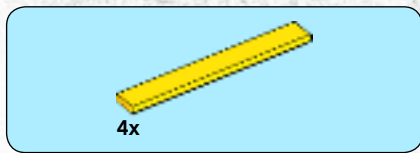

19

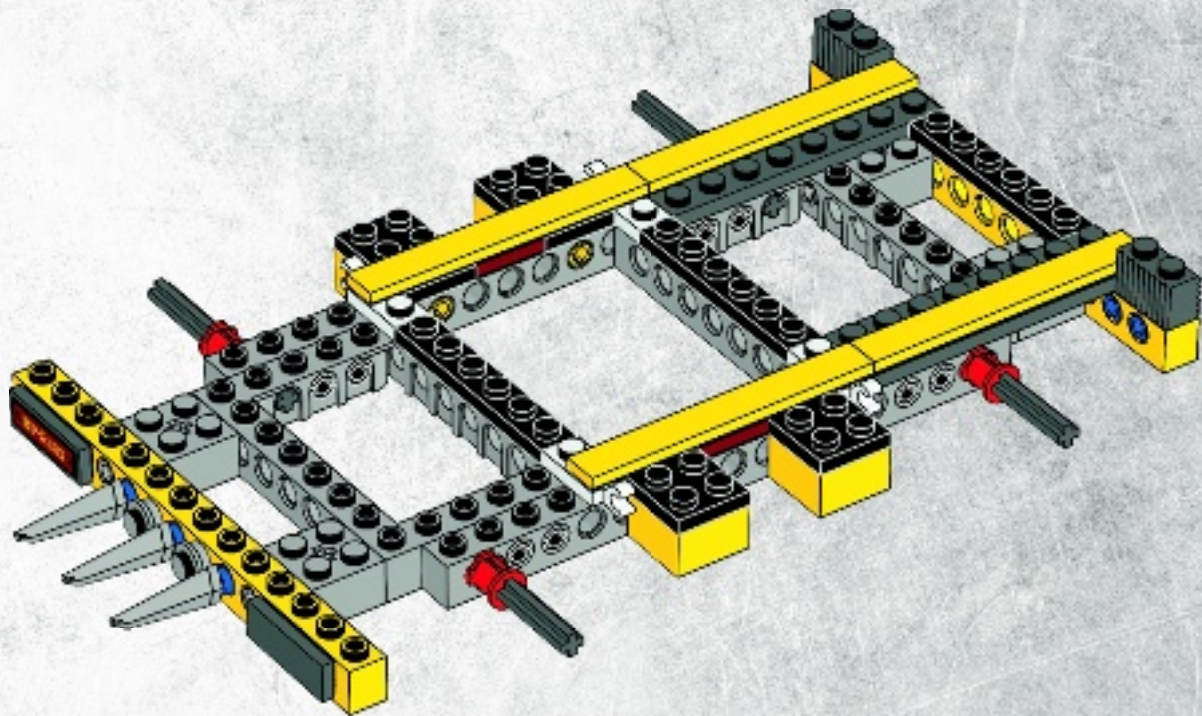

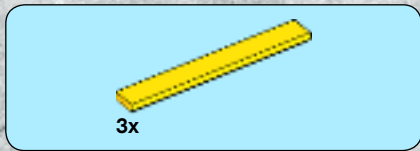

20

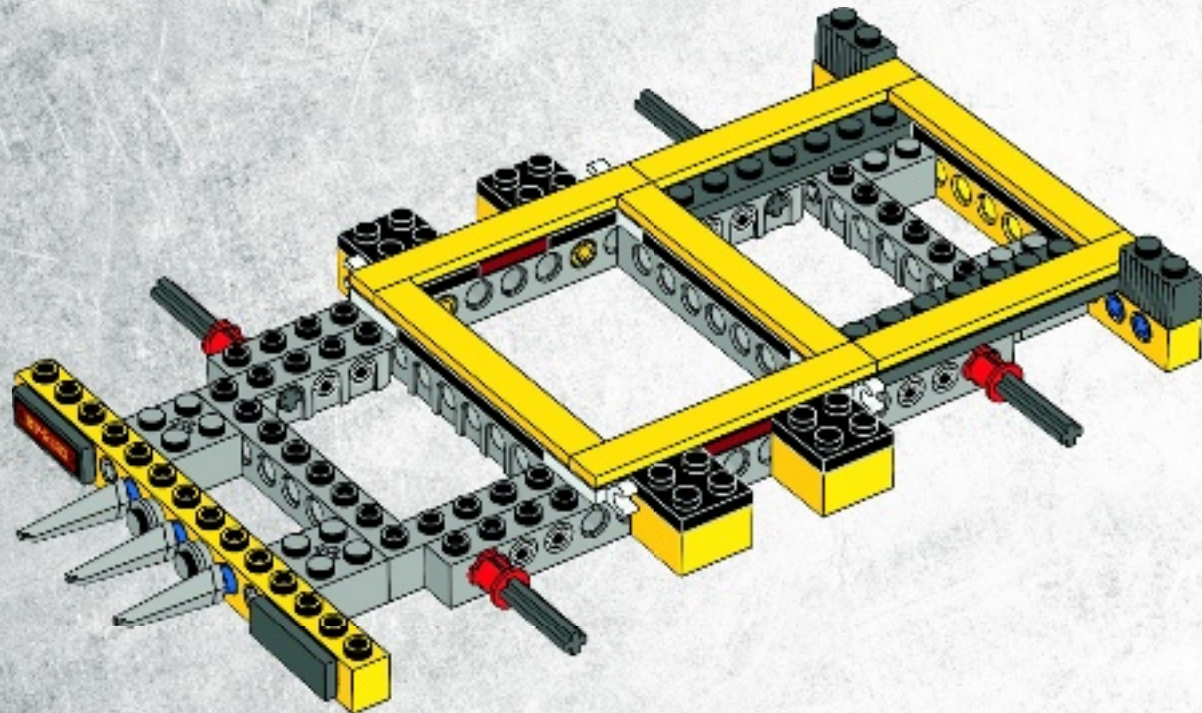



2x



2x

21

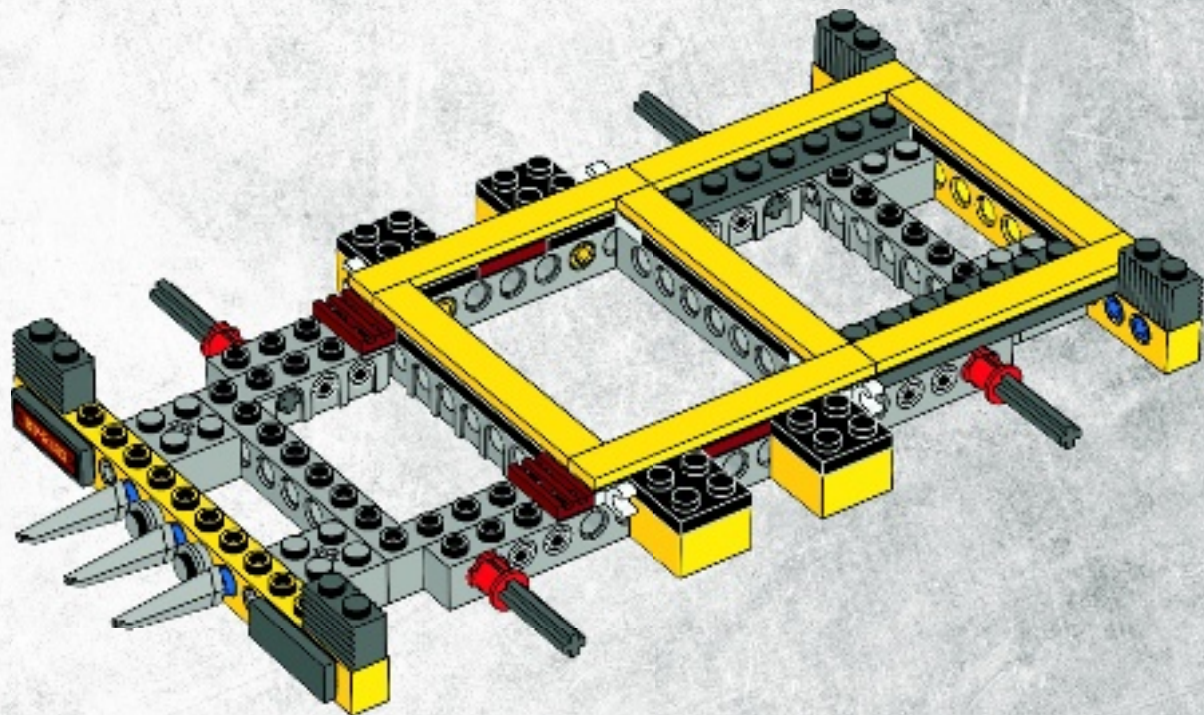

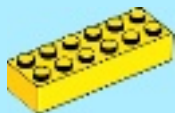

2x

22

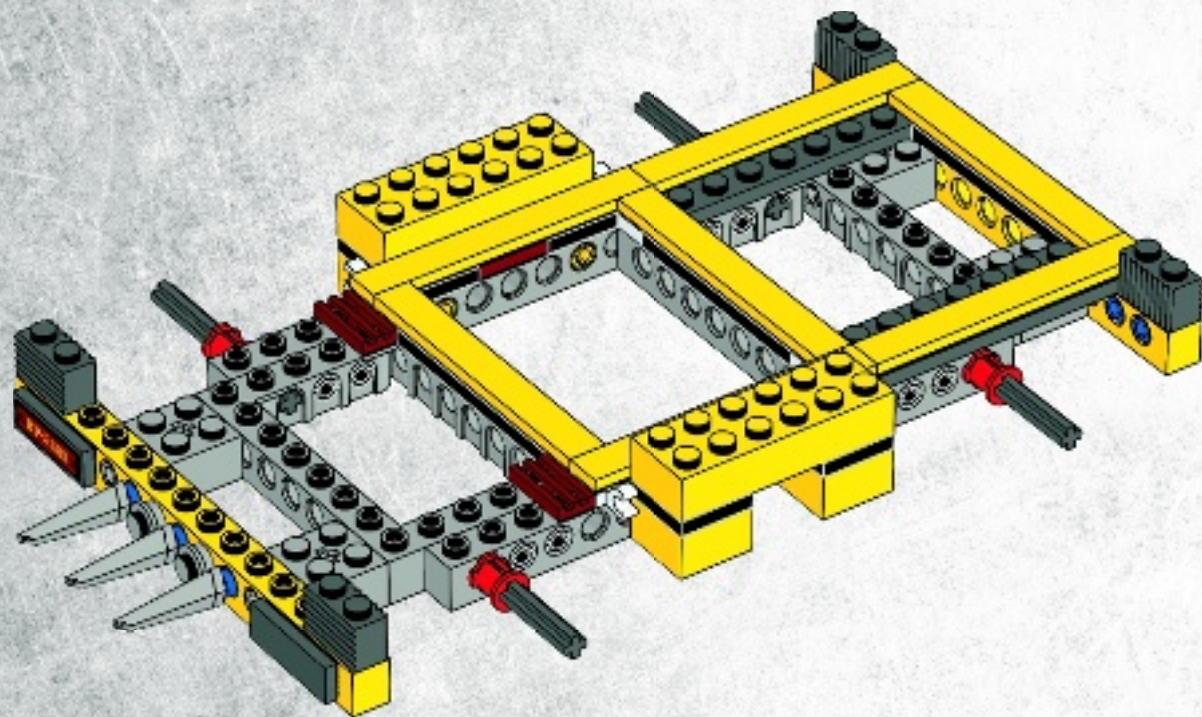



4x

23

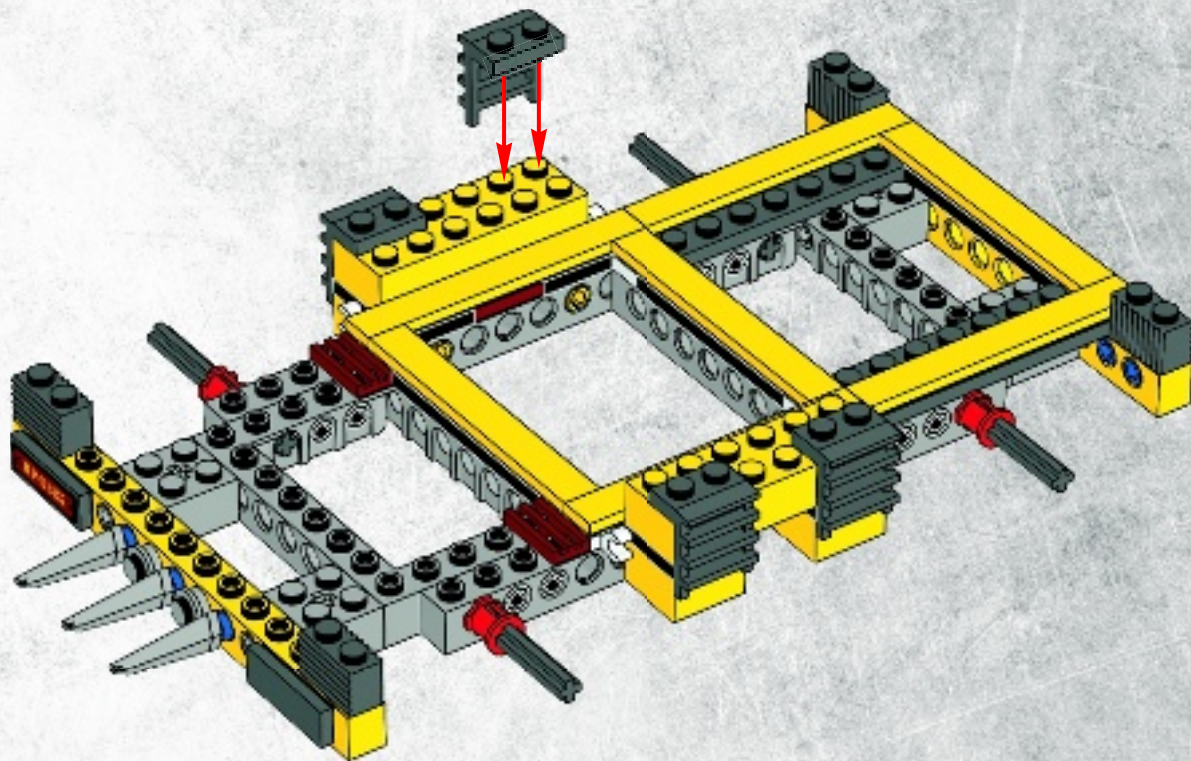



2x



4x

24

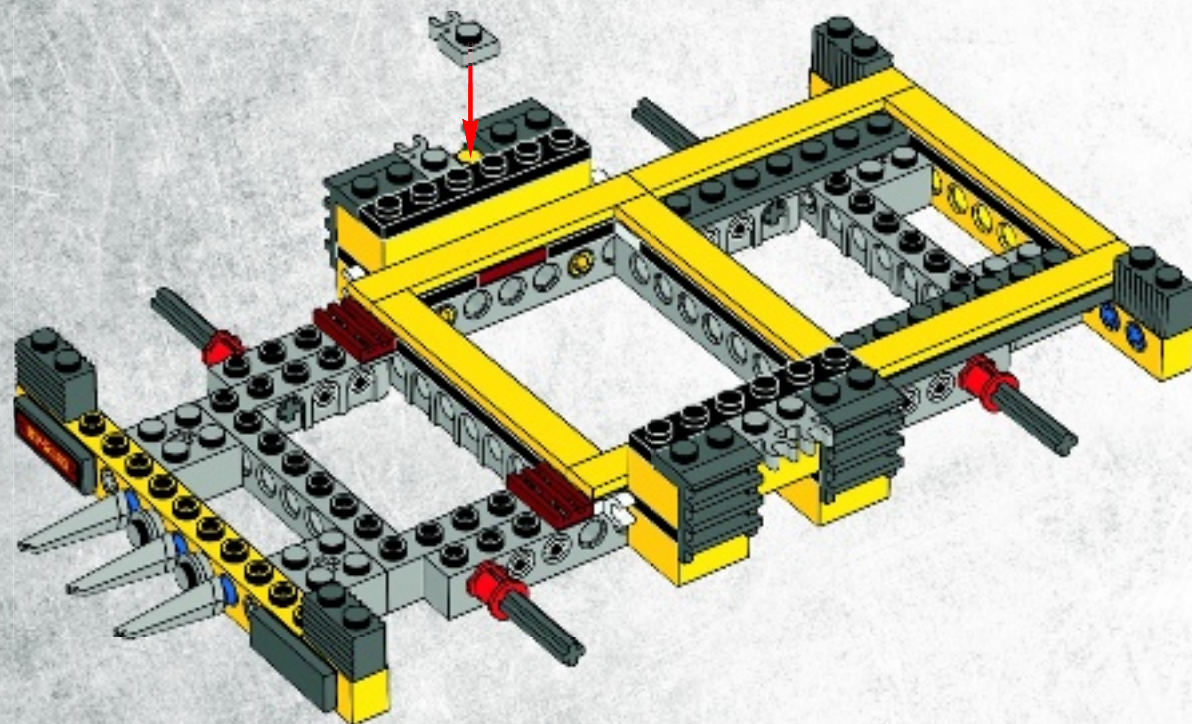



2x

25

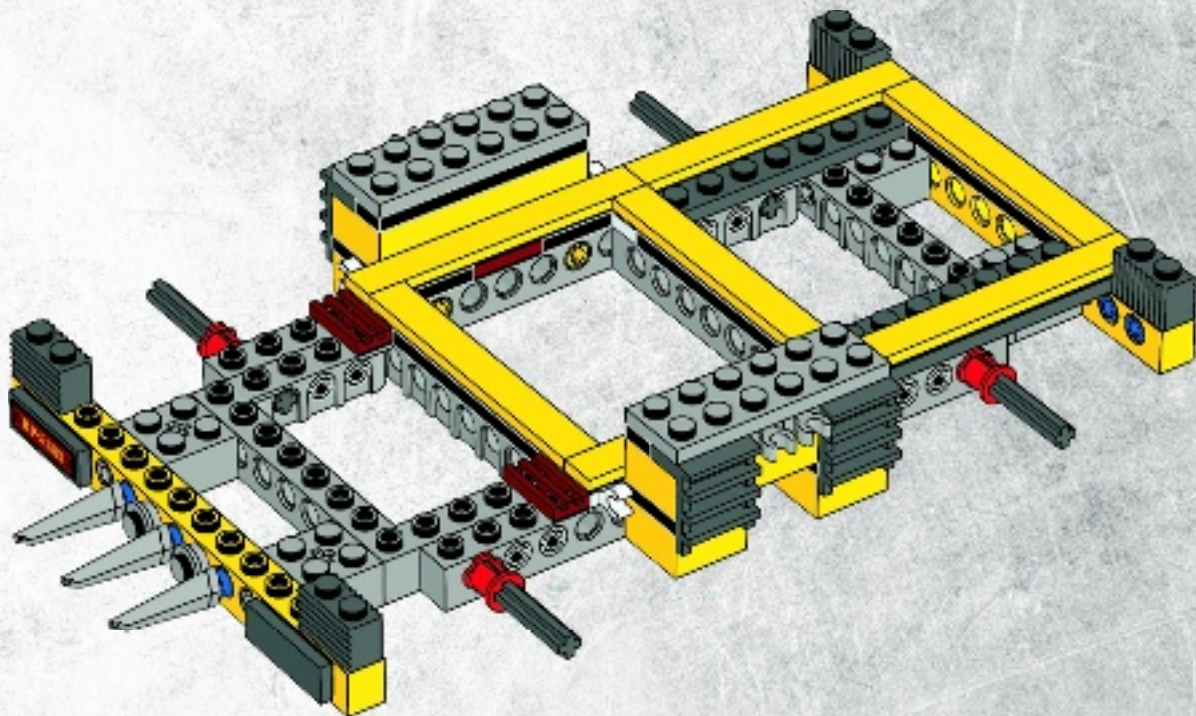

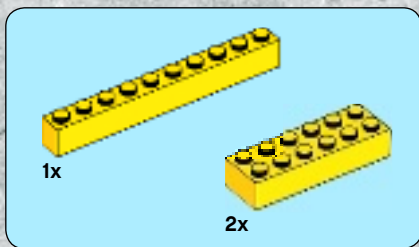

26

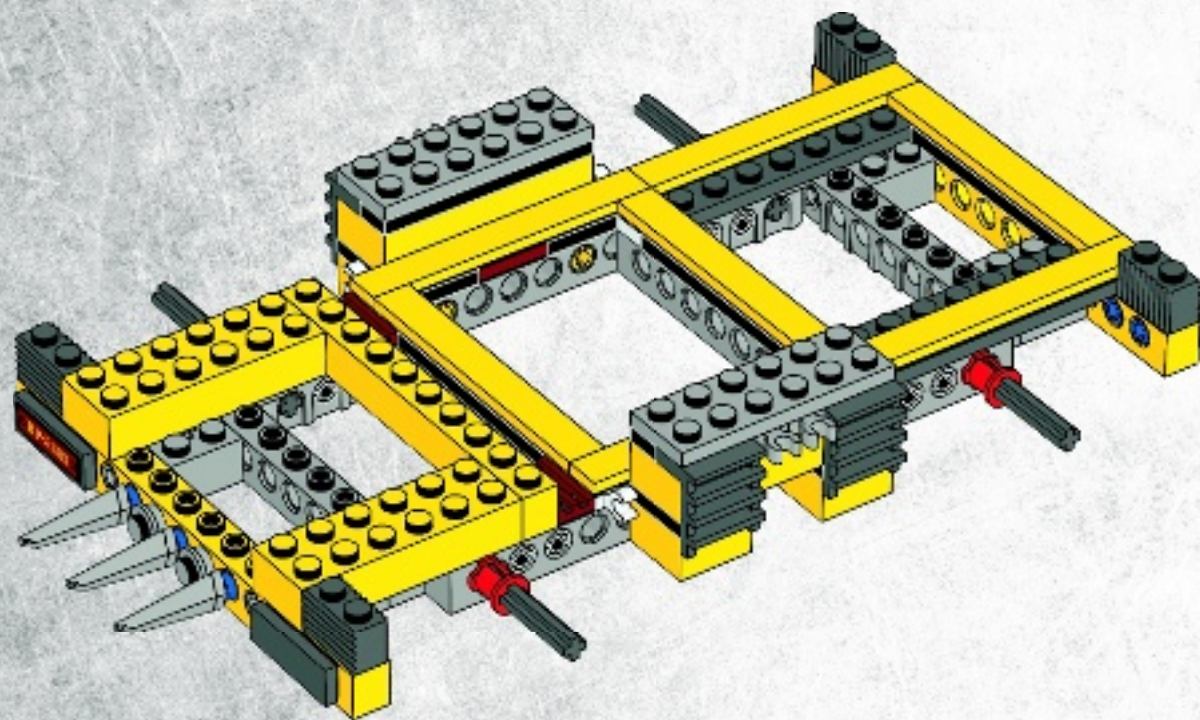



27

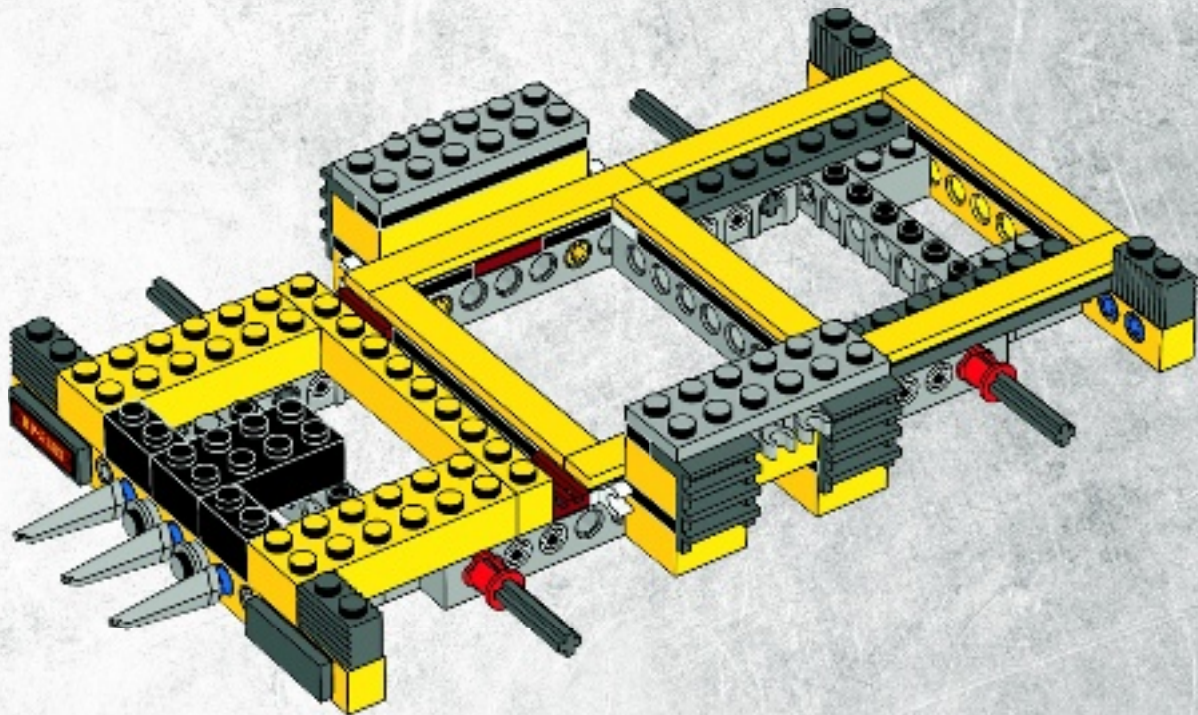

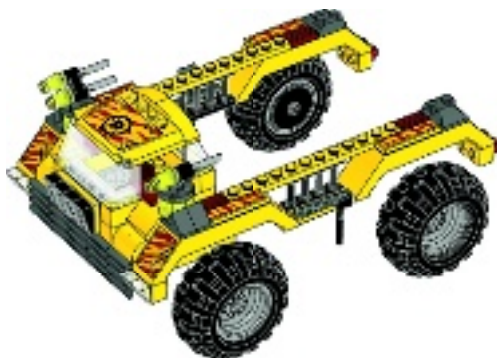

1x



1x

28

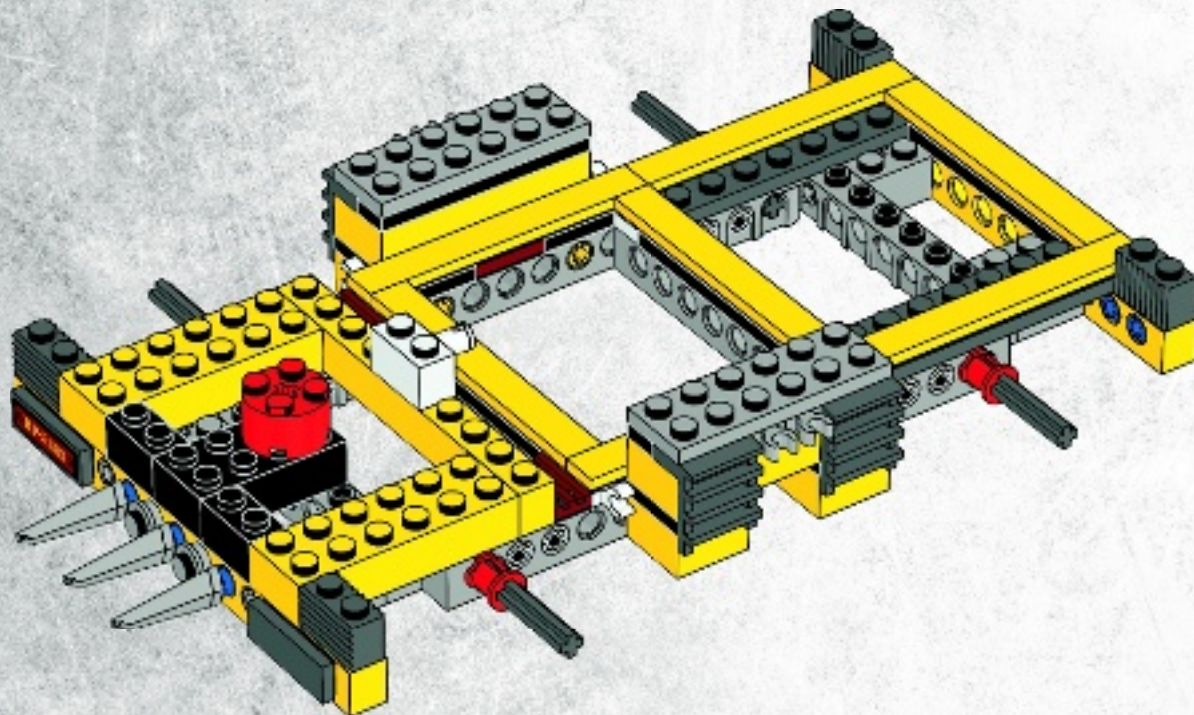

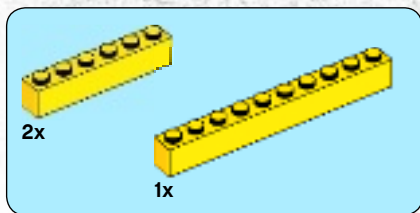

29

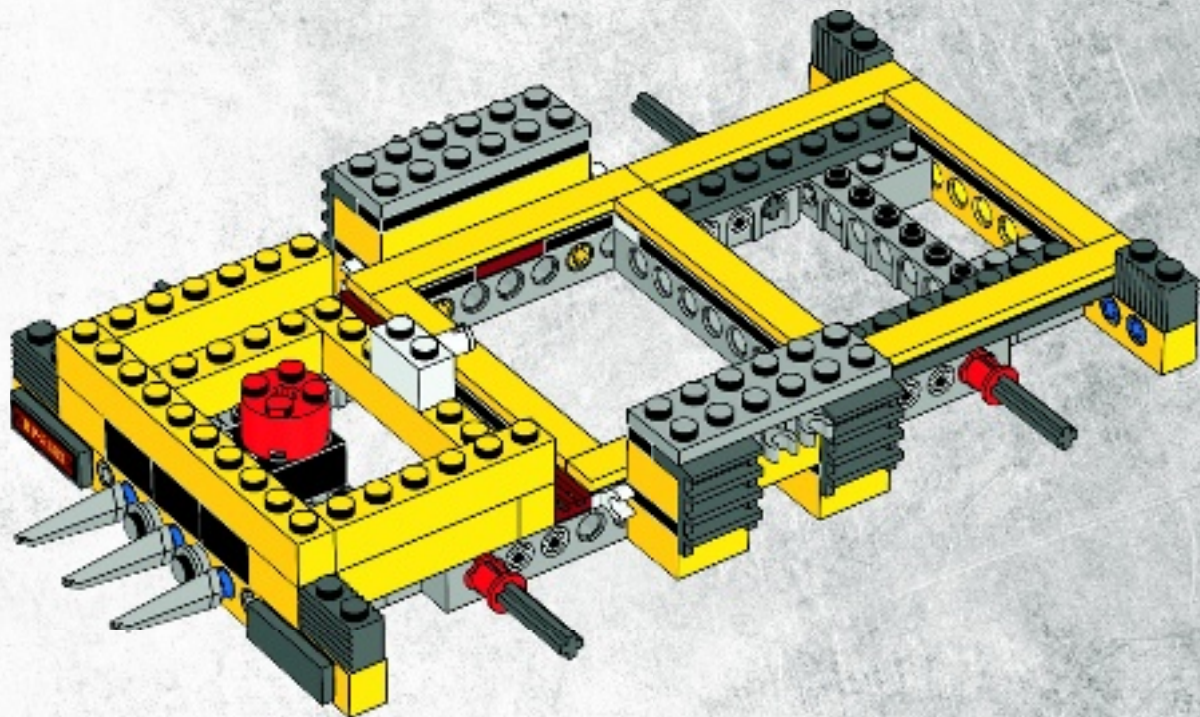



4x



2x

30

1



2



2x

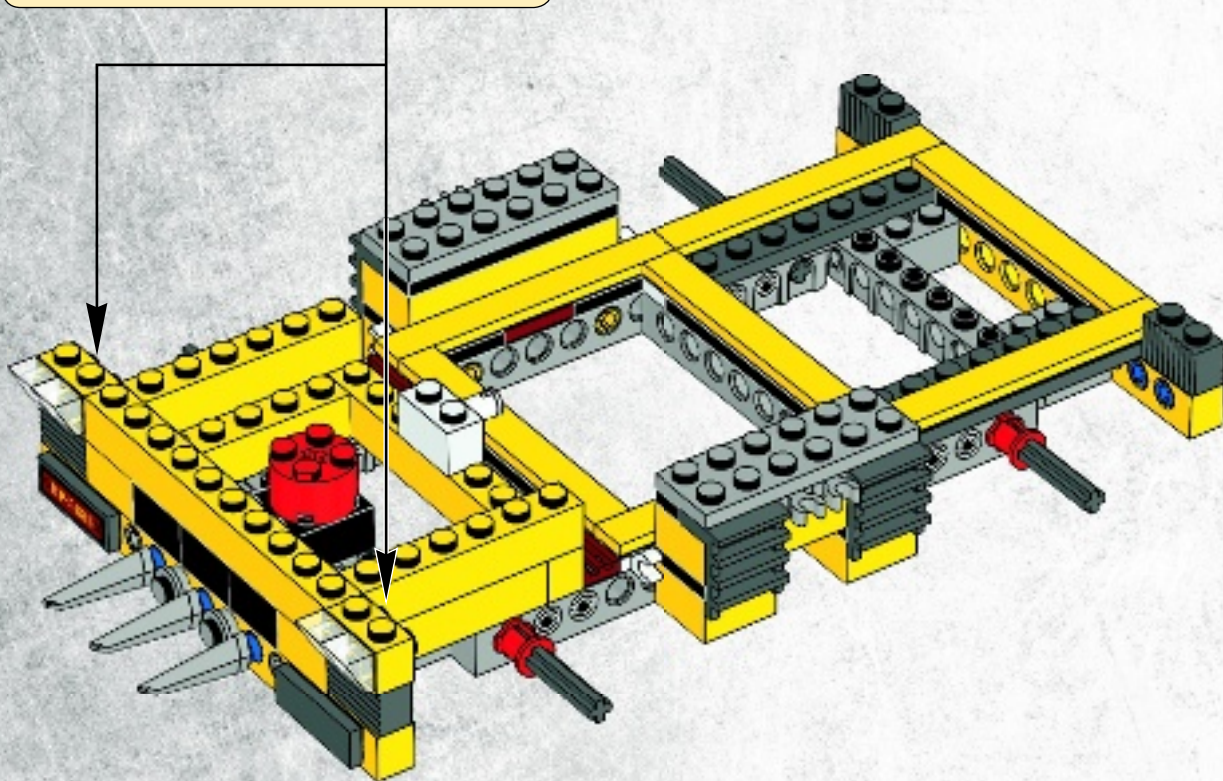



5x

31

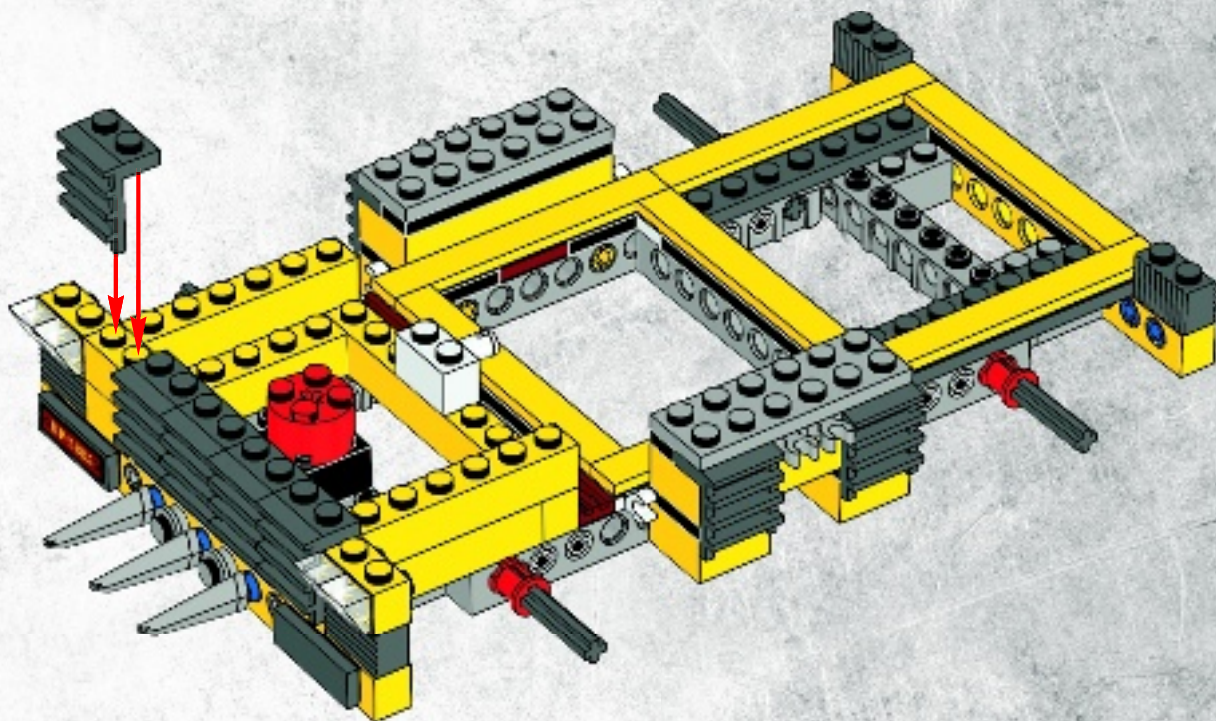

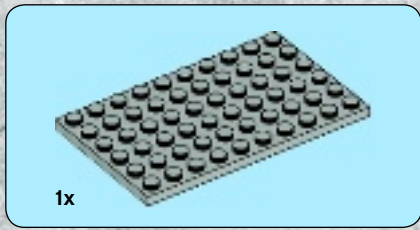

32

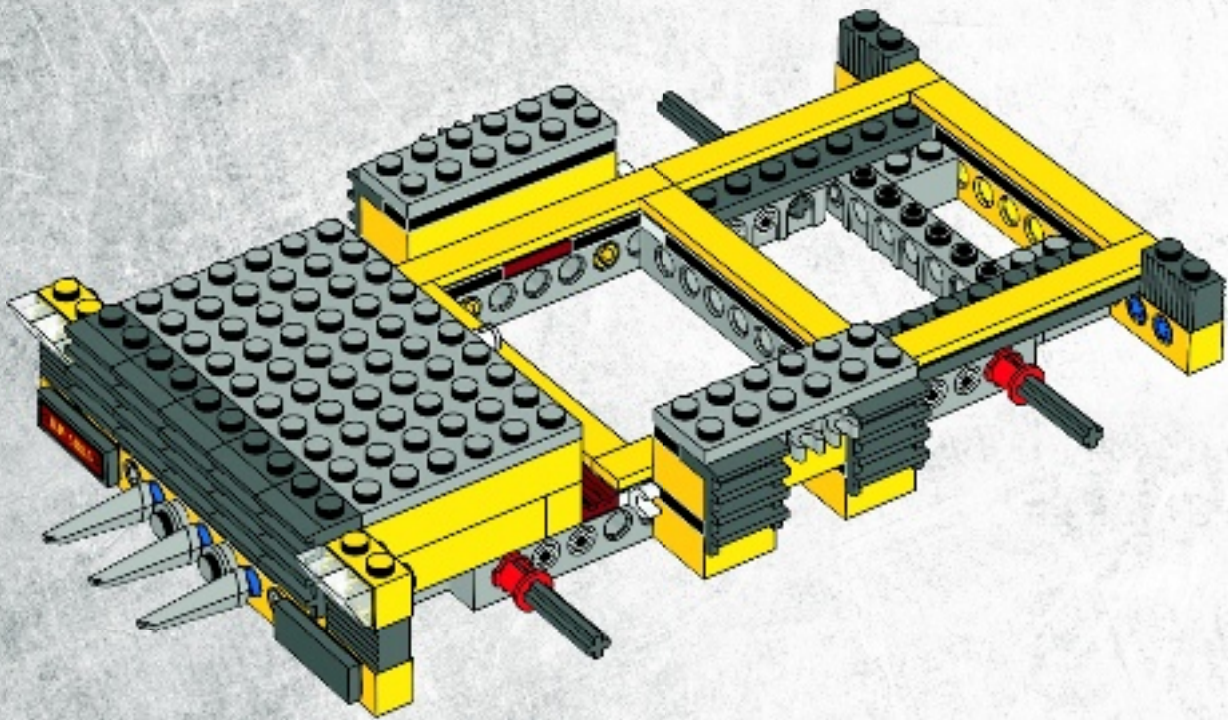

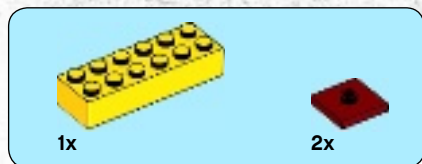

33

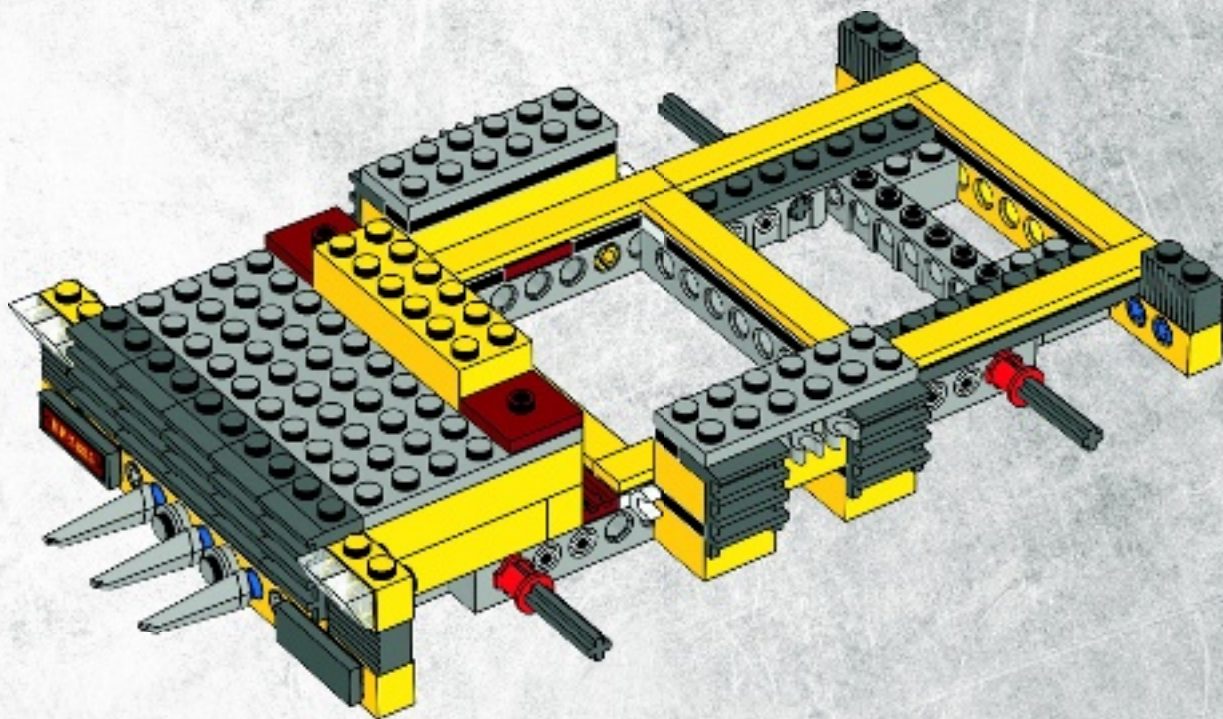



34

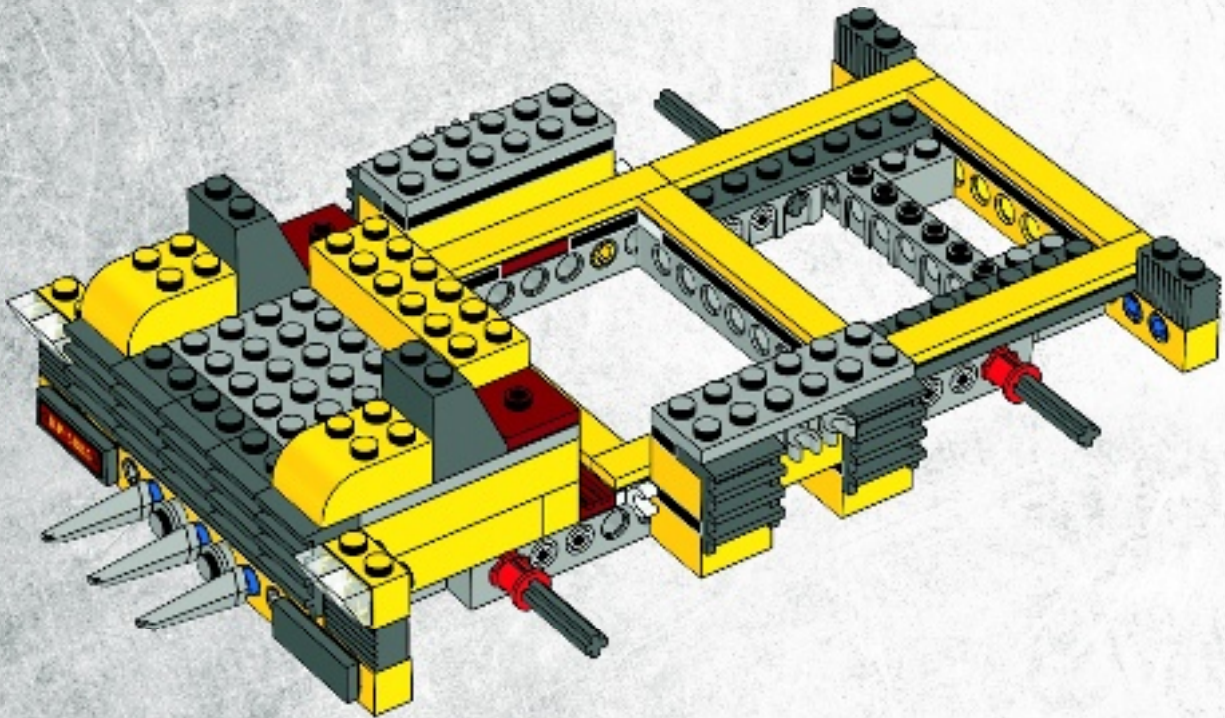



35

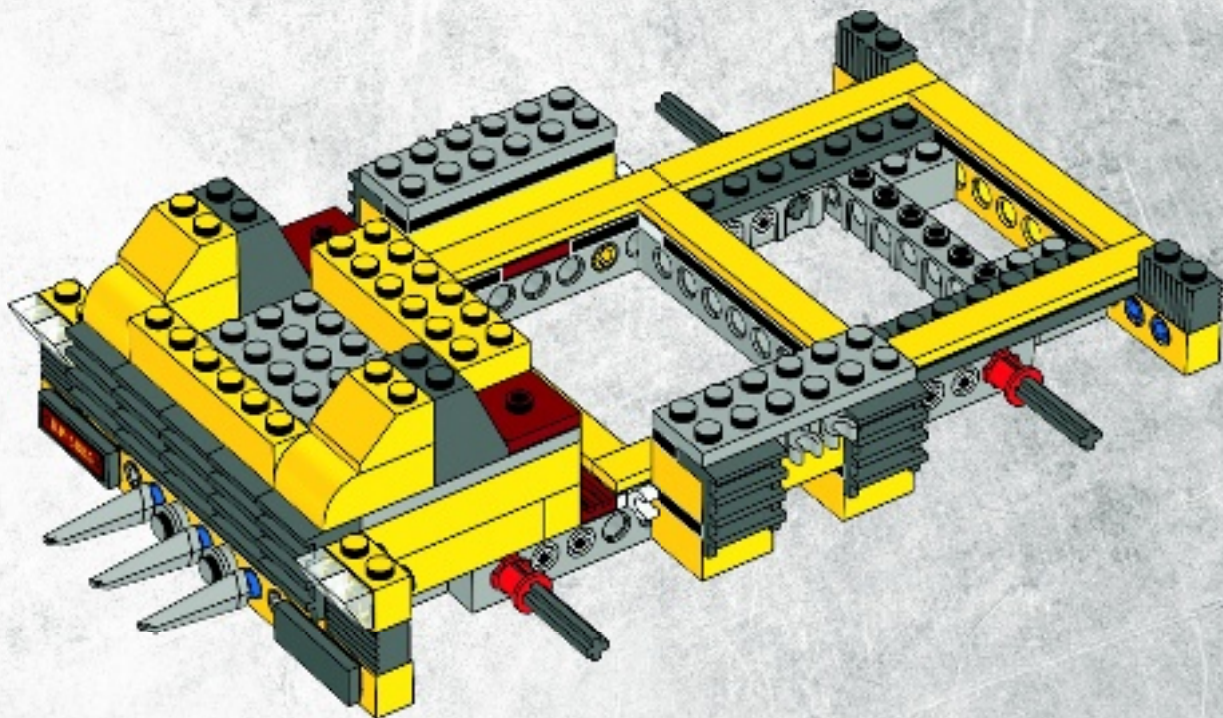



1x



1x

36

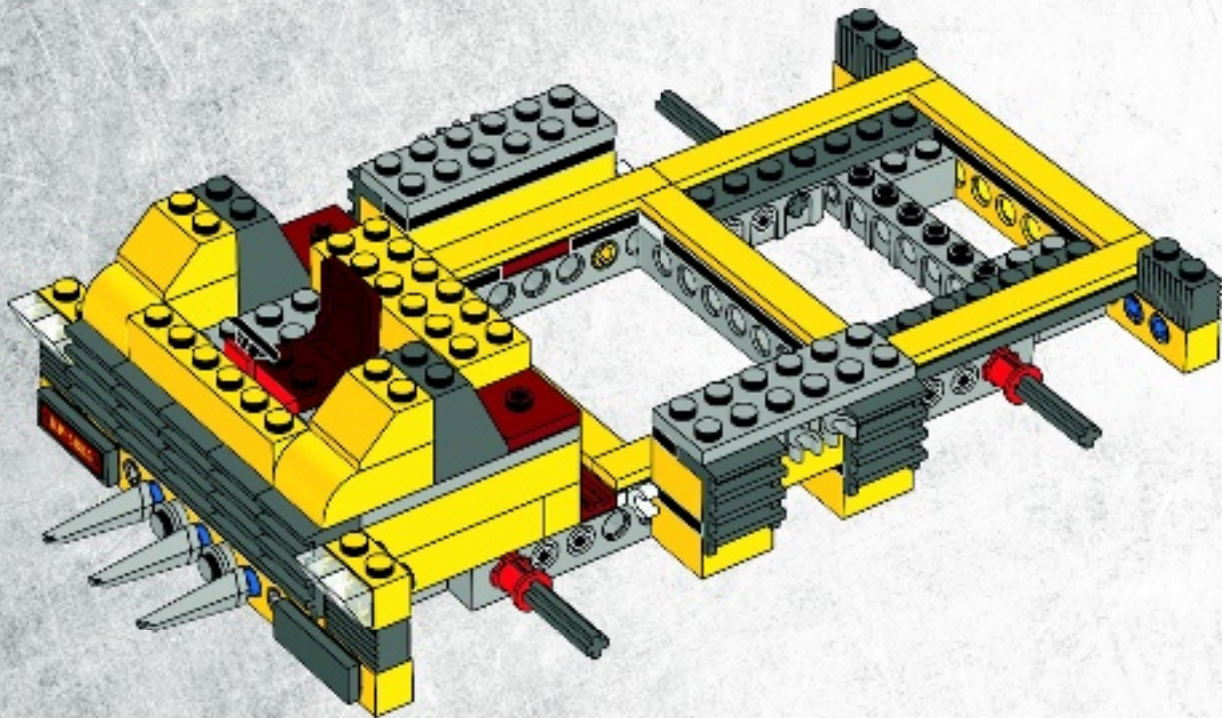



3x

37

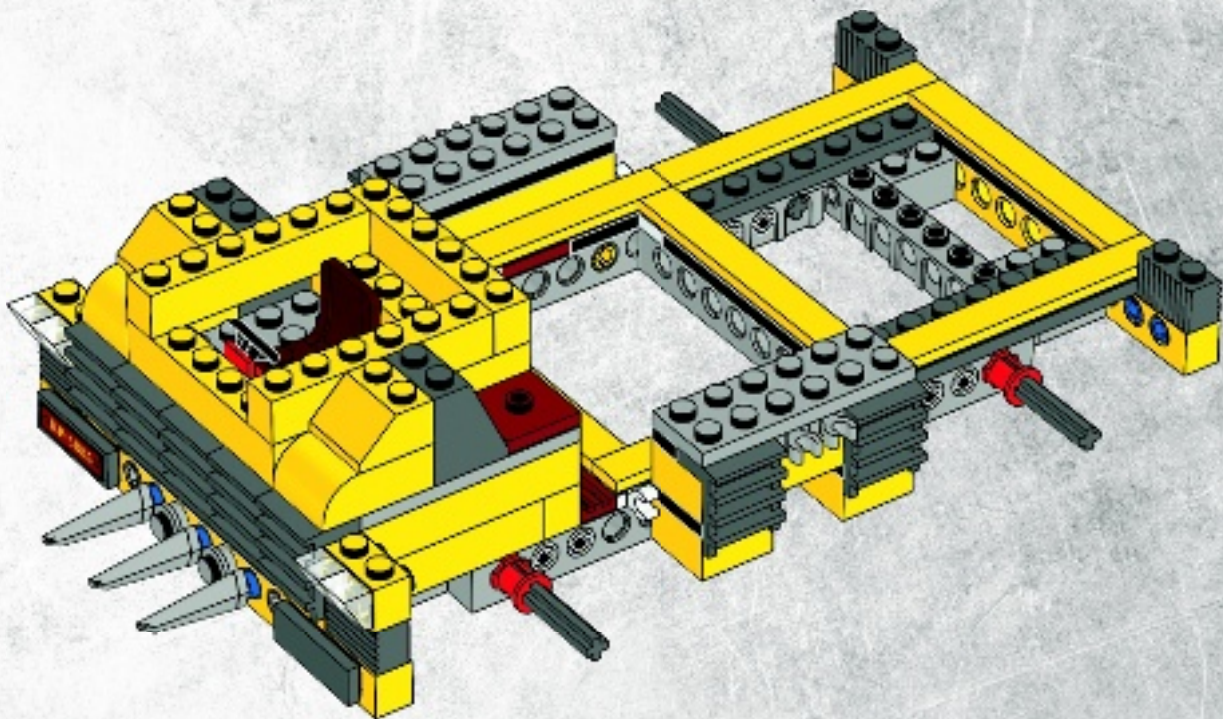



1x

38

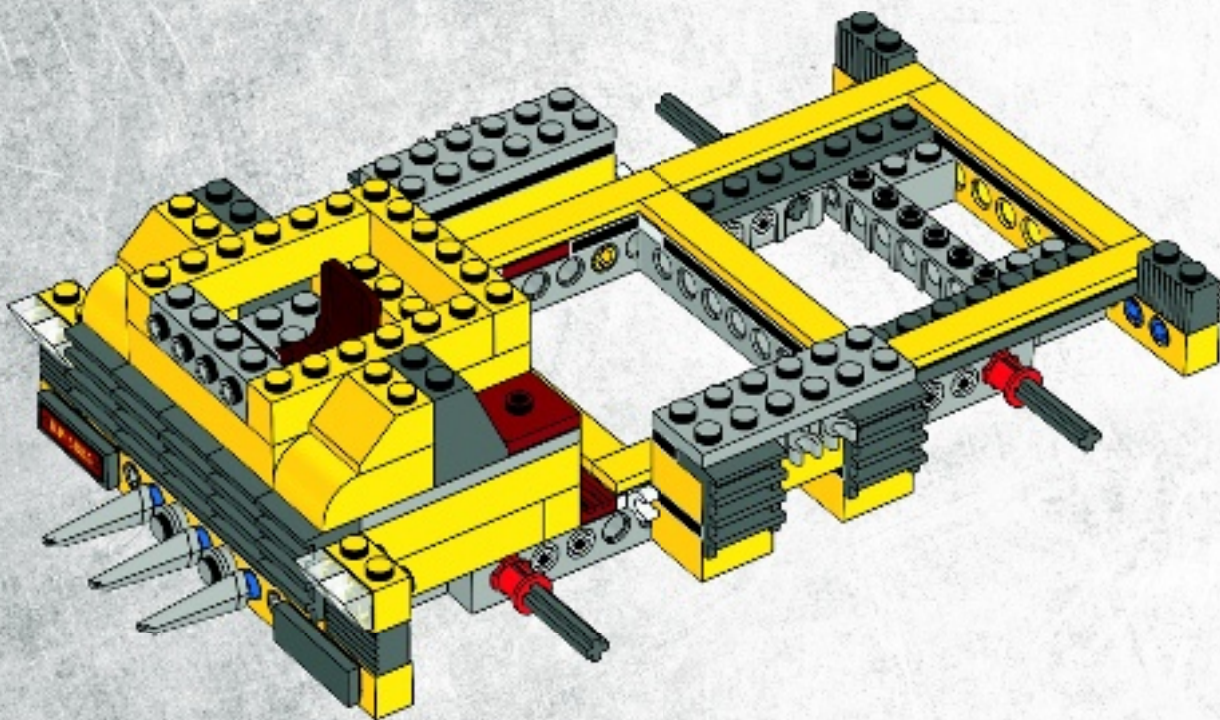



4x



2x

39

1



2



2x

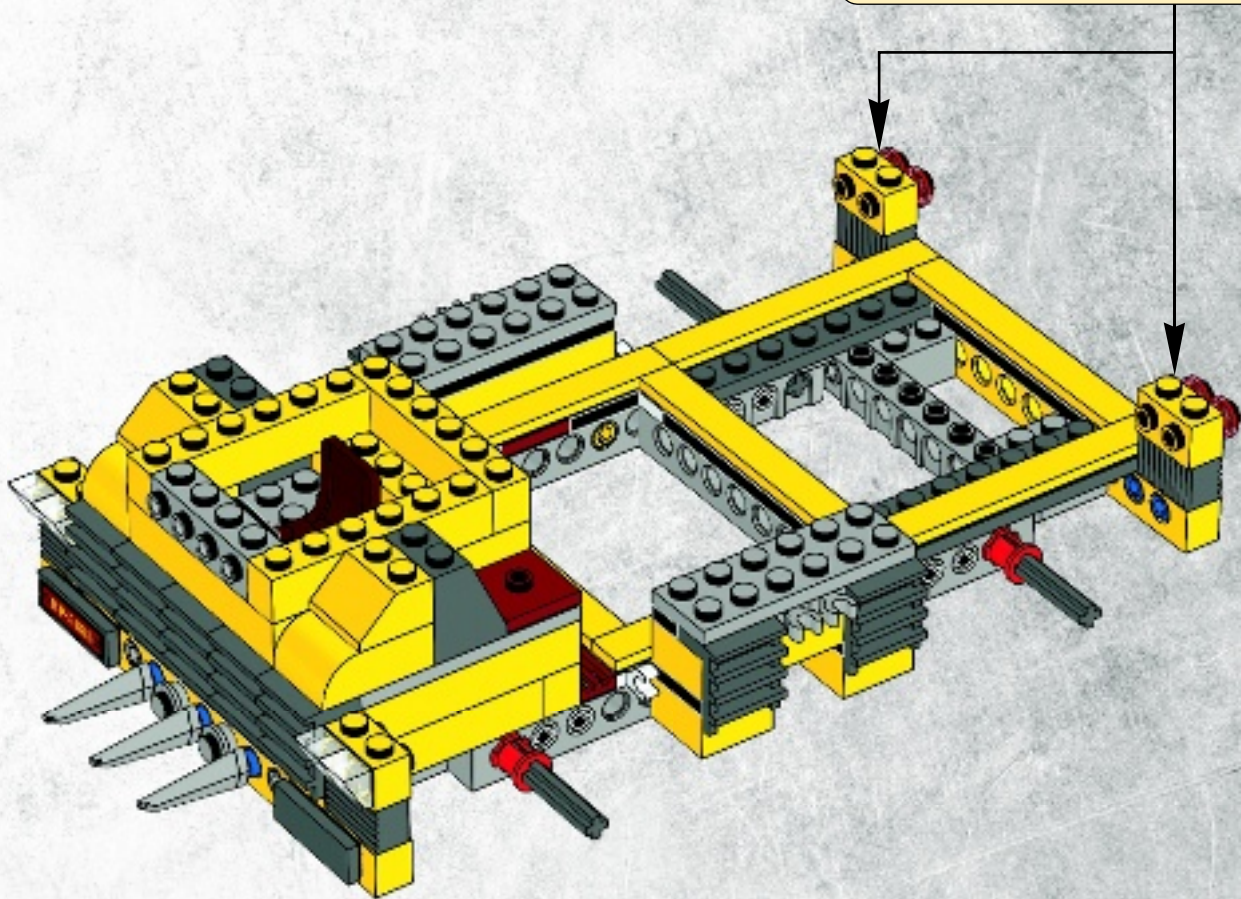

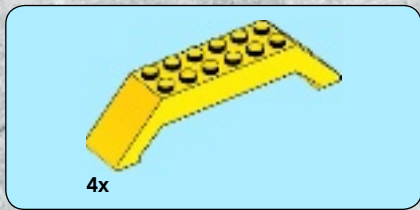

40

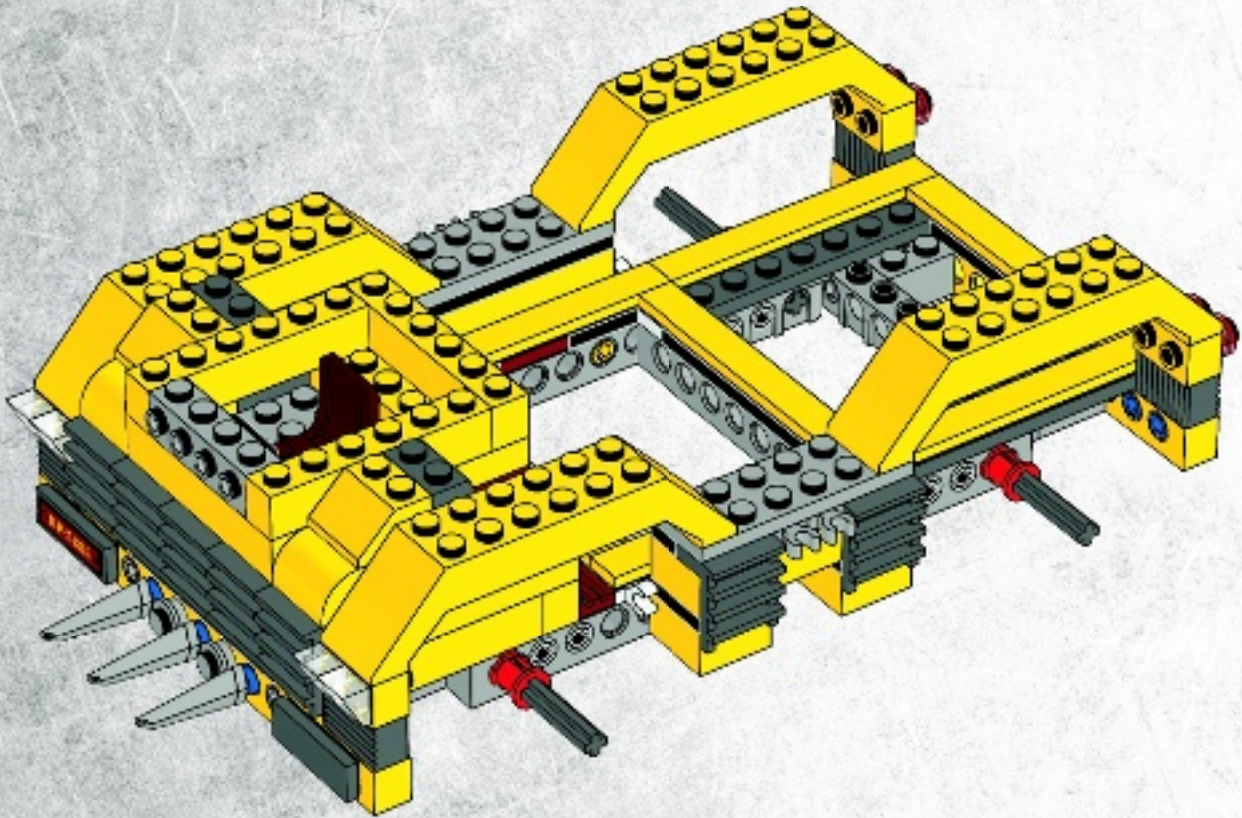

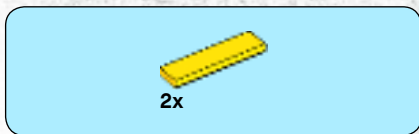

41

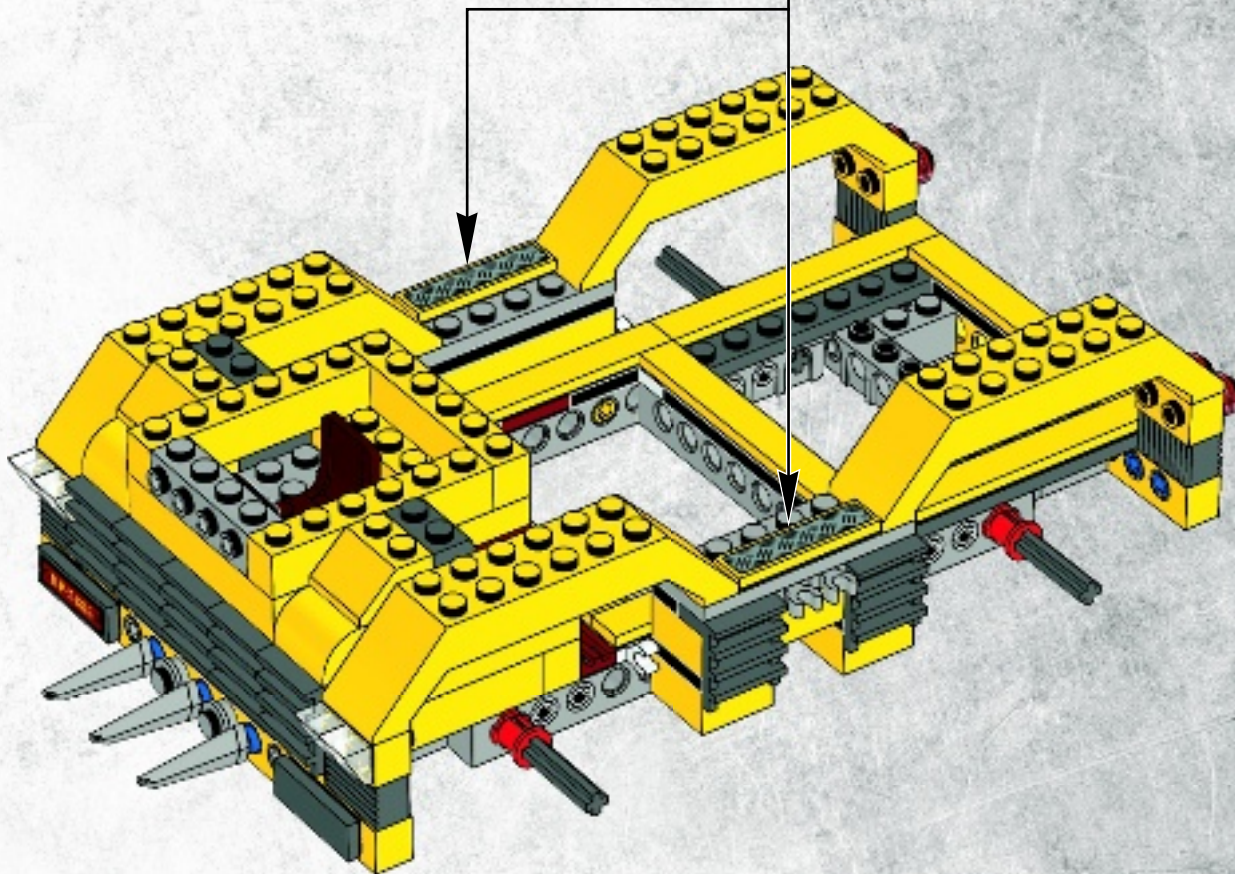
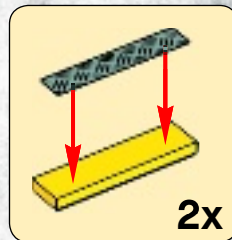



42

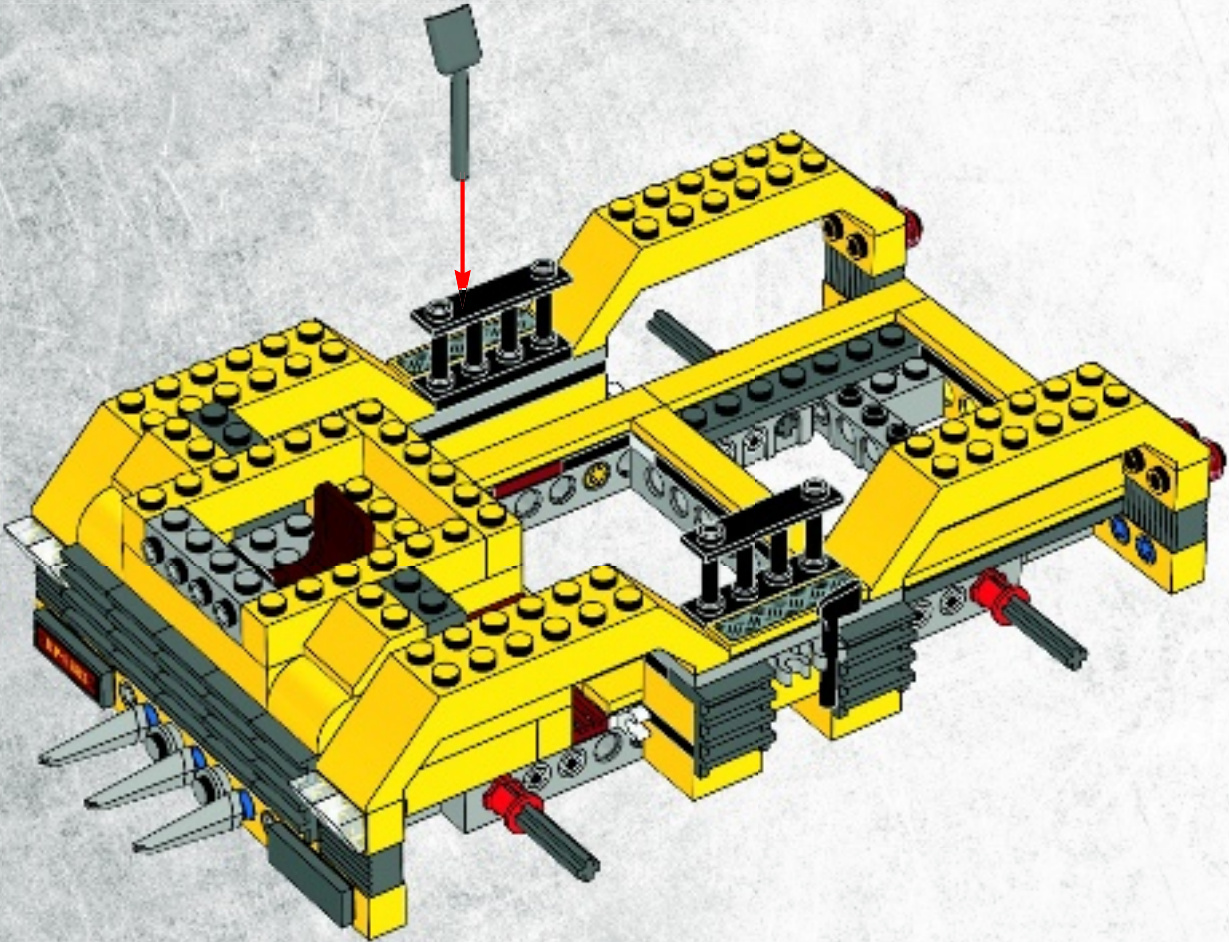



2x



2x

43

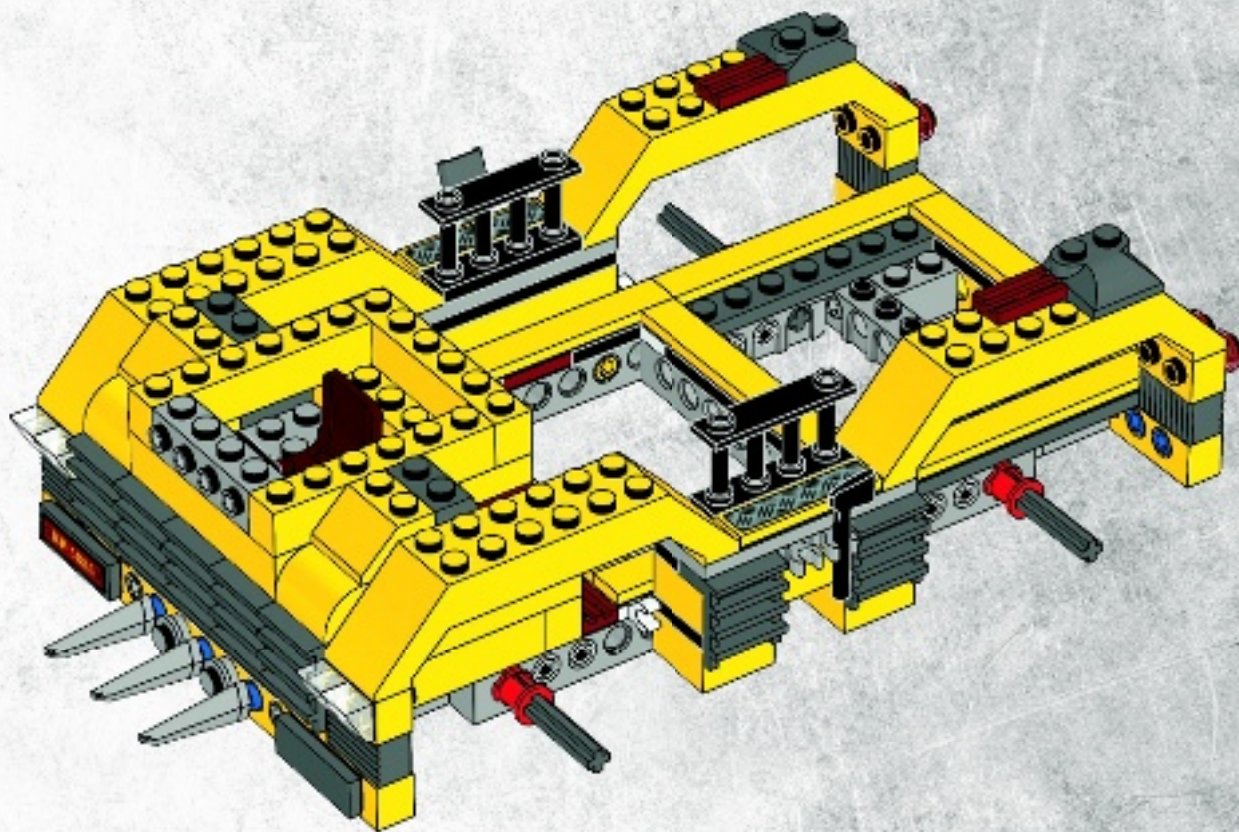

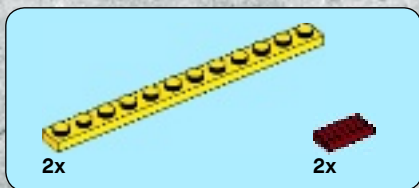

44

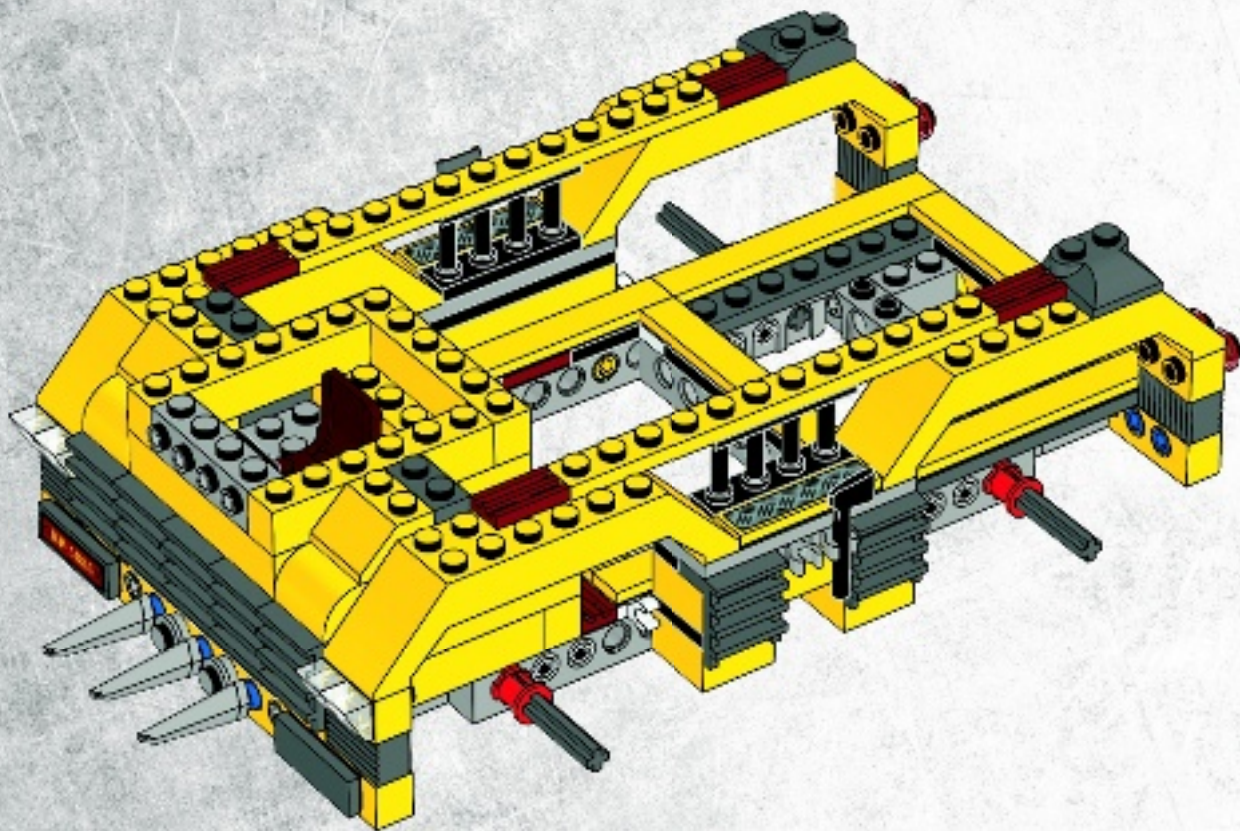



4x

45

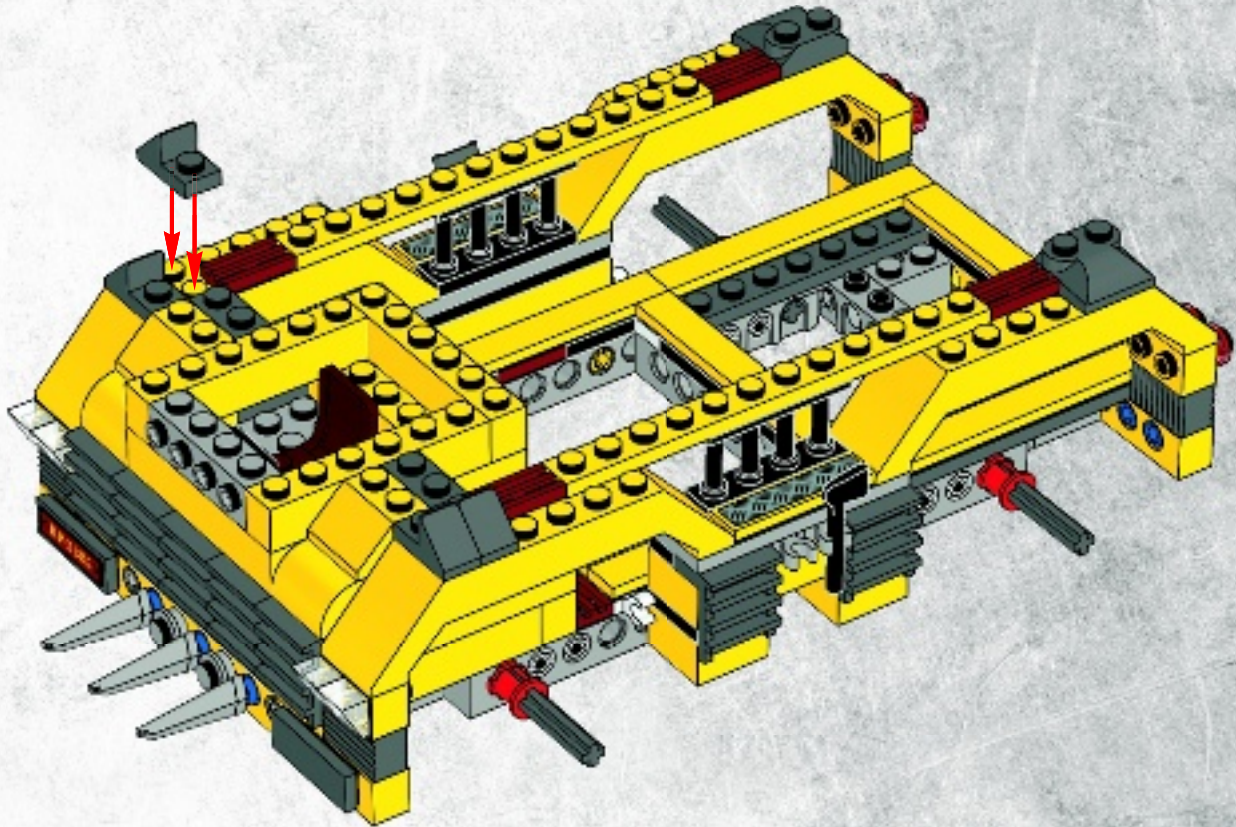



46

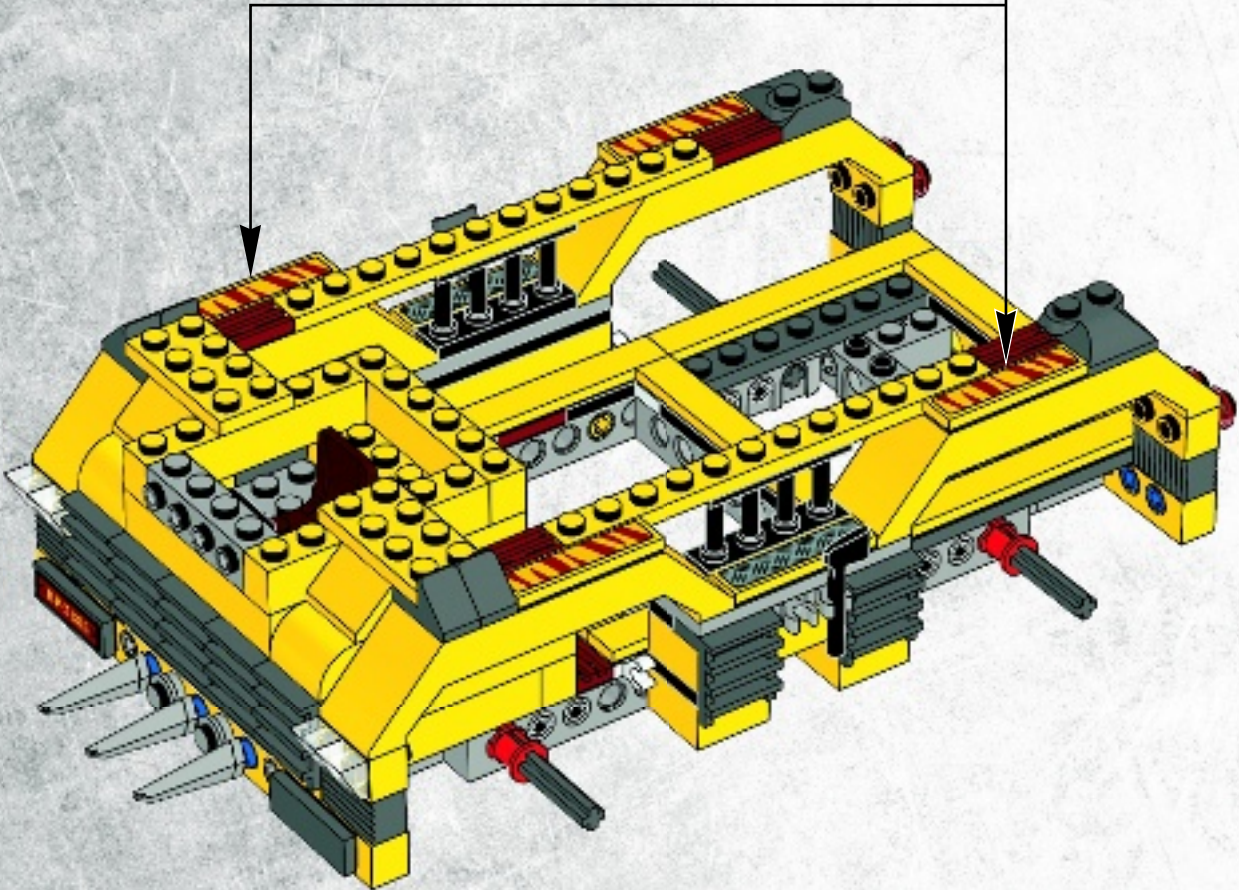
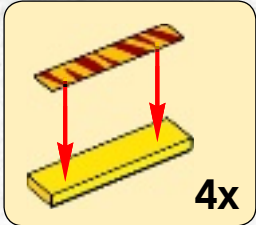



2x



2x

47

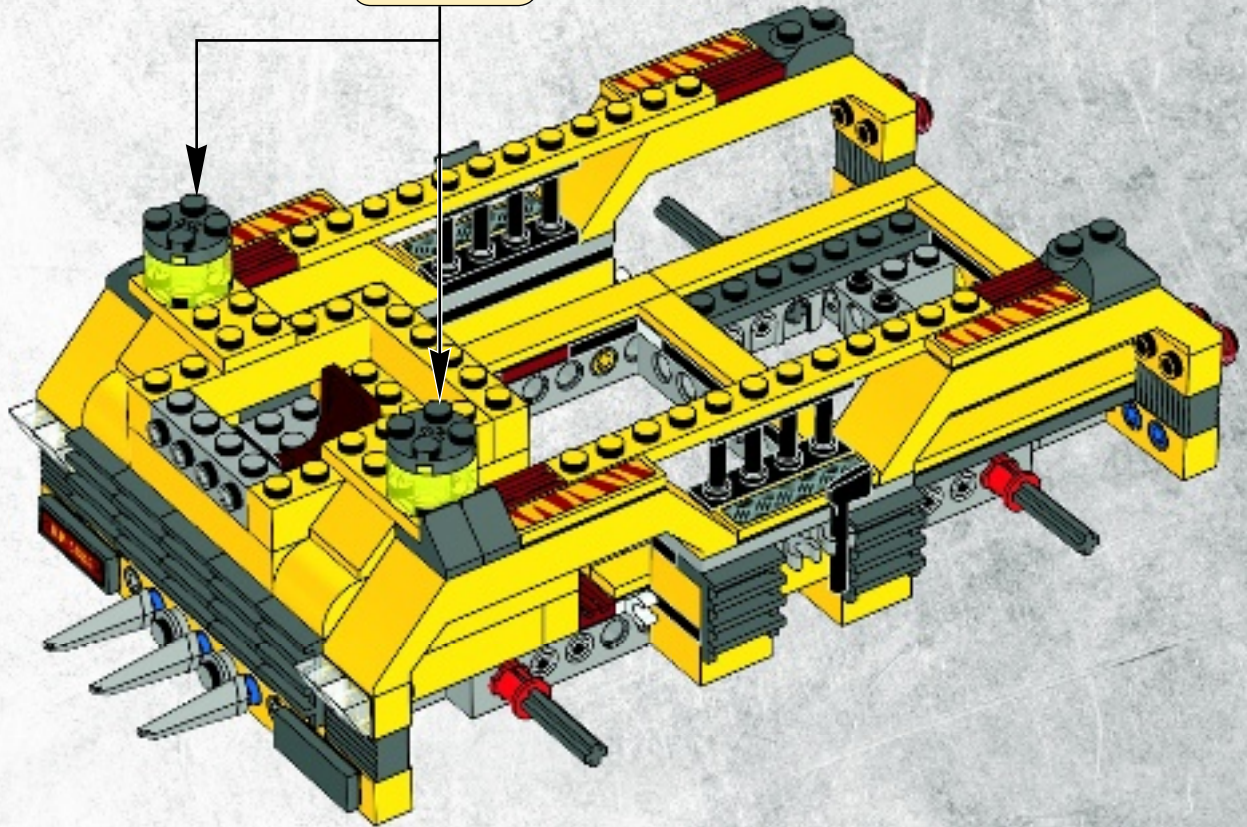
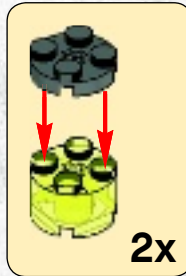



2x

48



2x

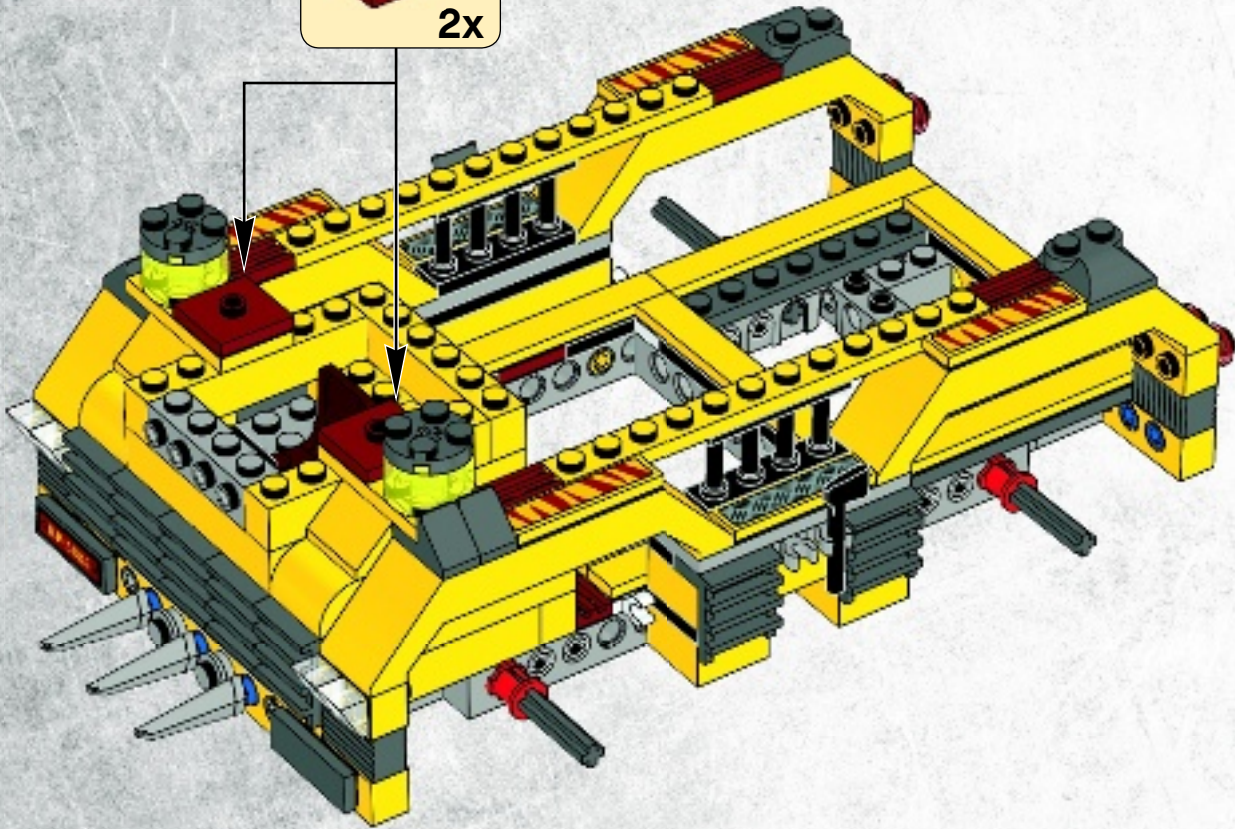

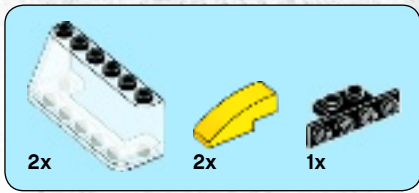

49

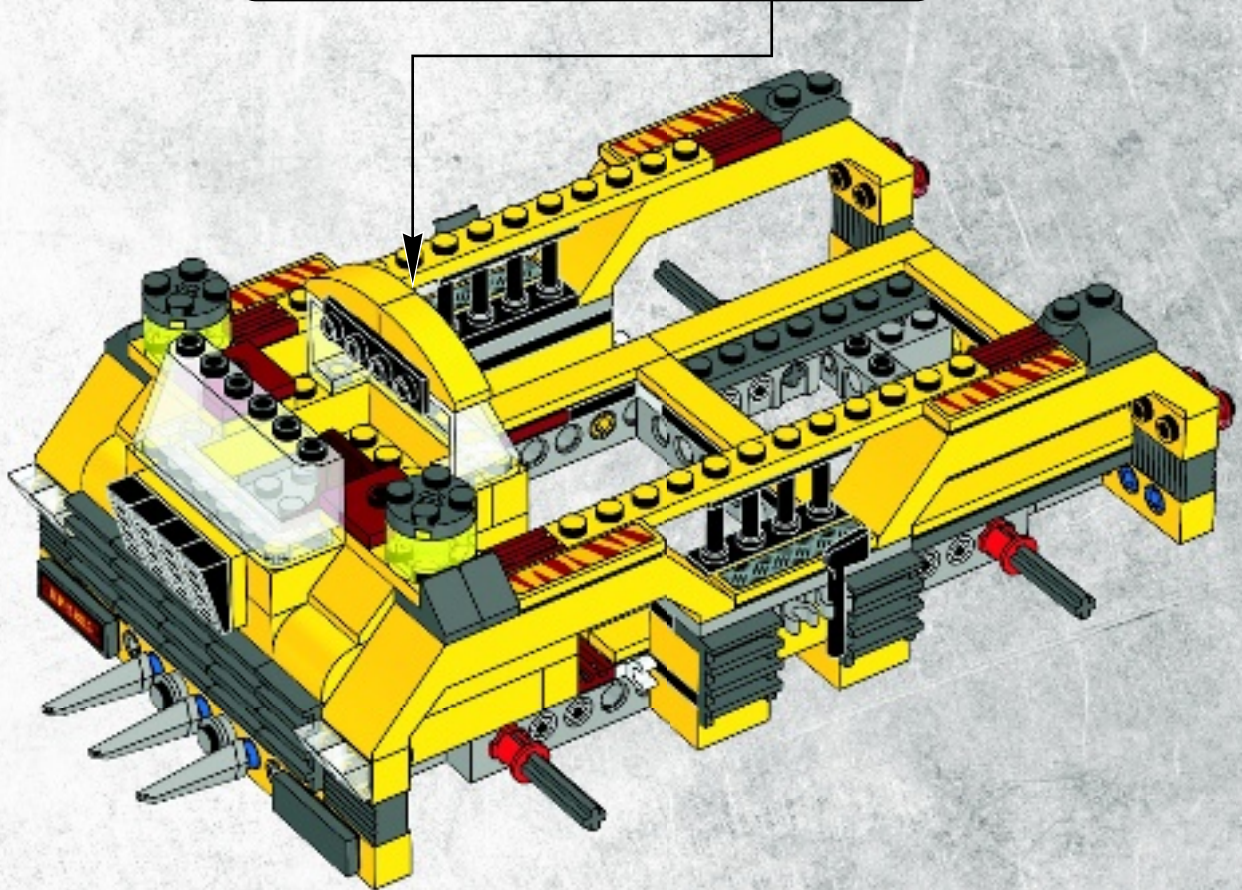
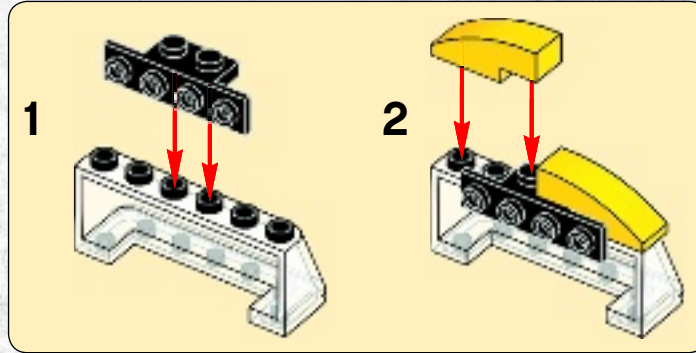



50

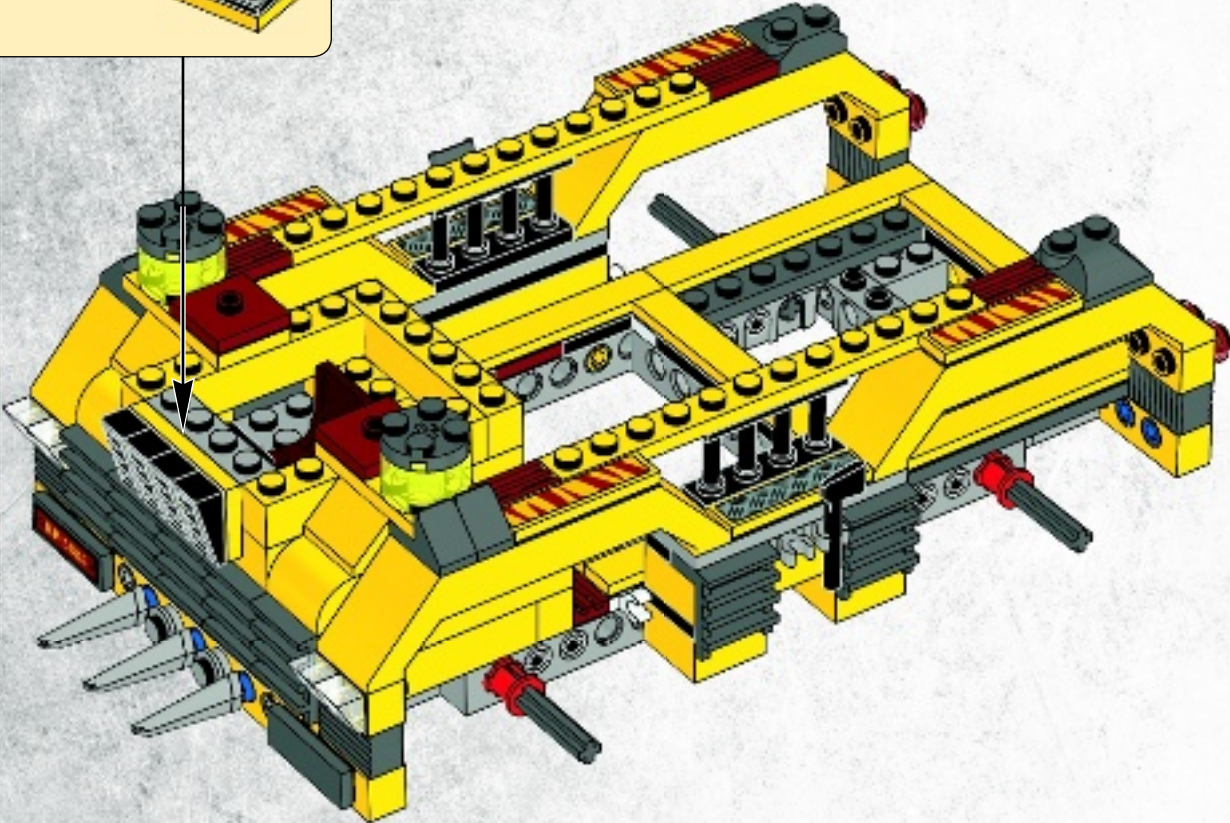
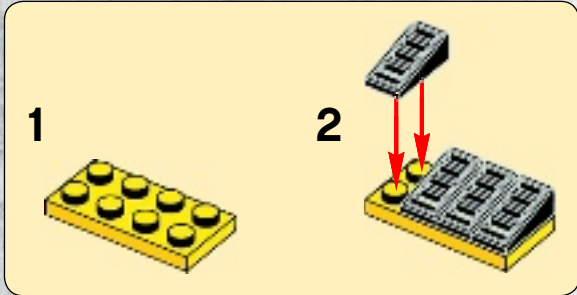



1x

51

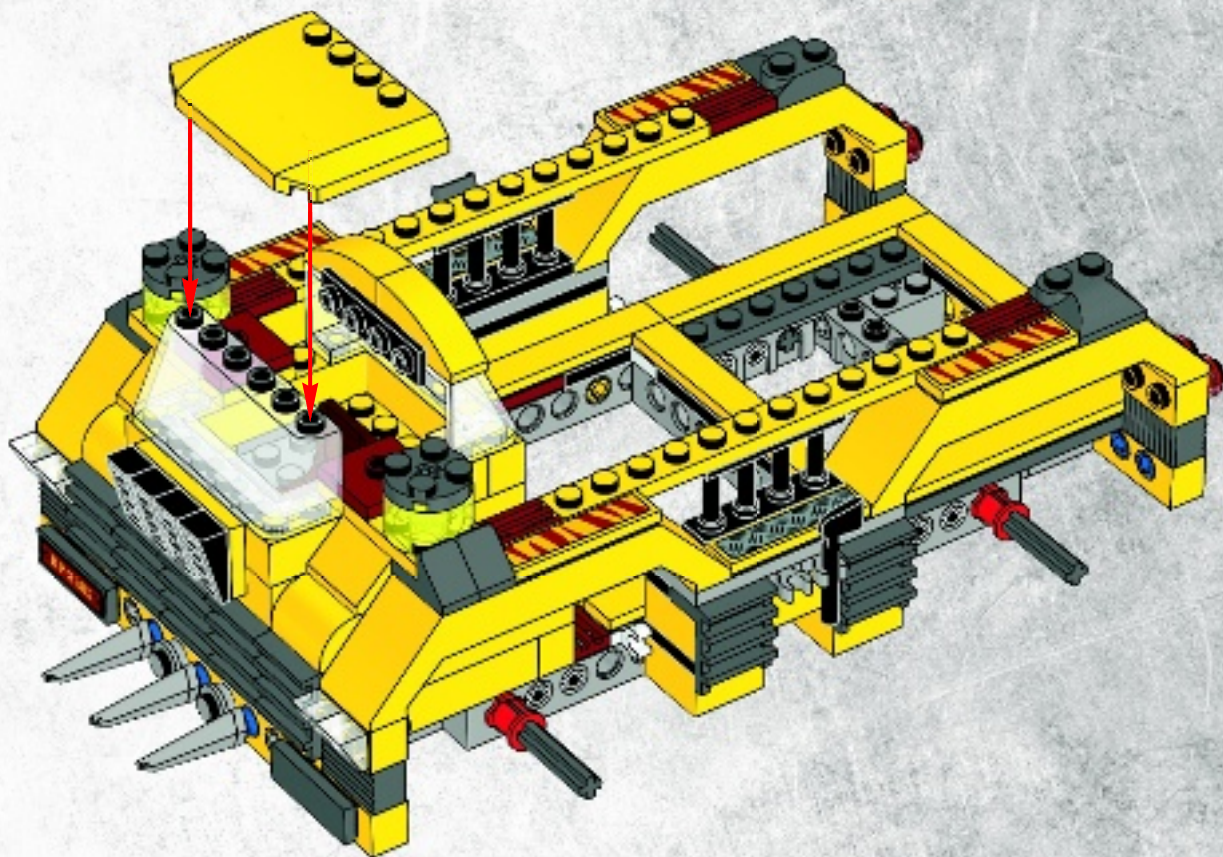



2x

52

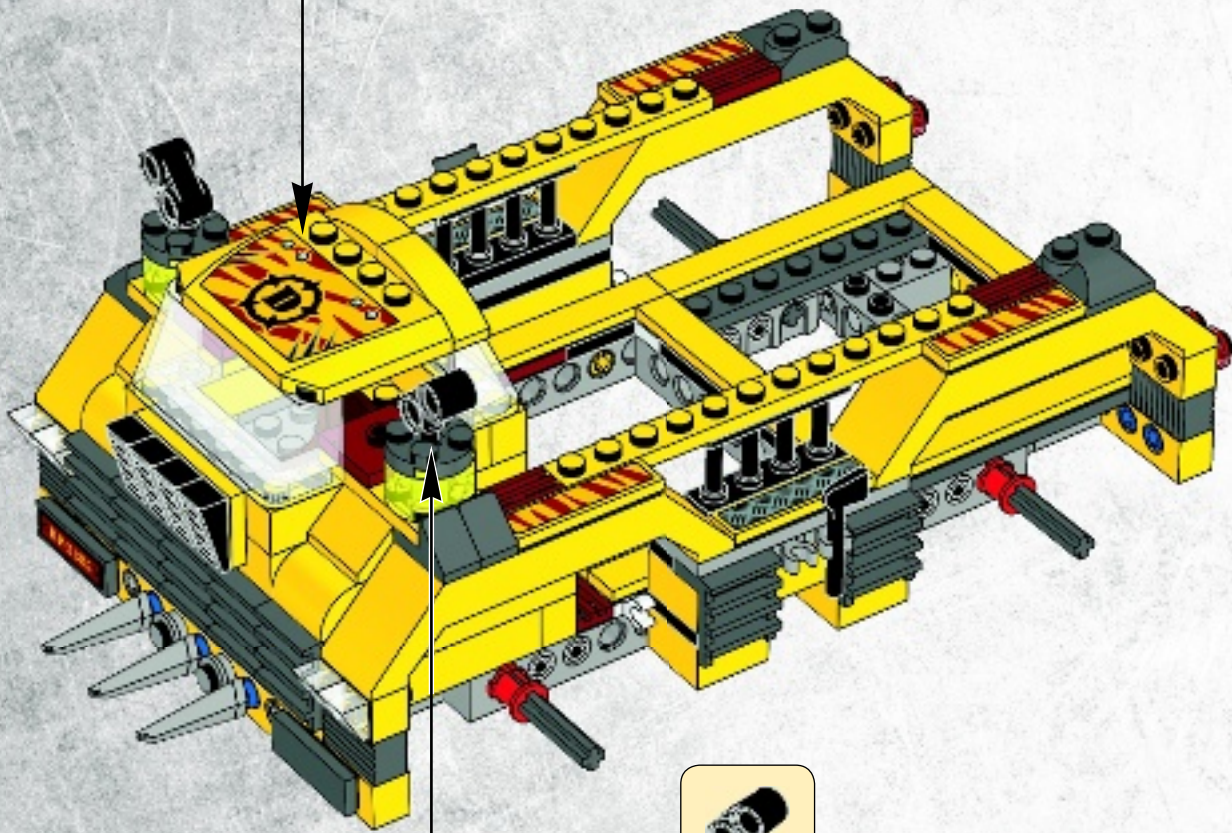



4x

53



4x

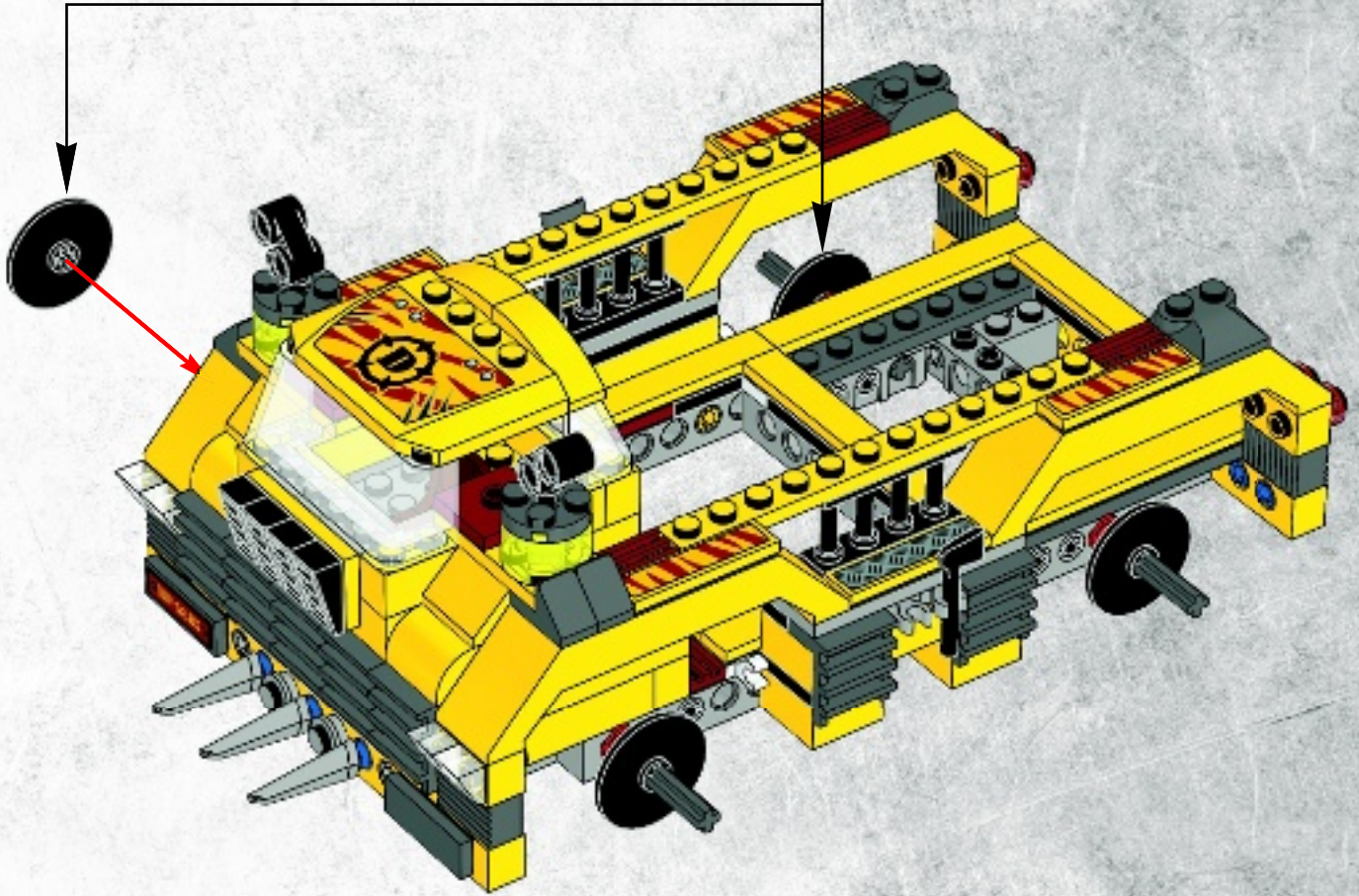

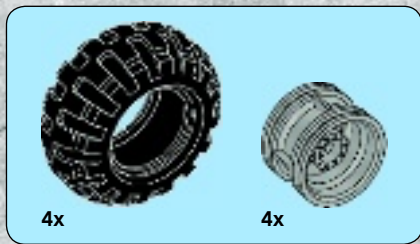

54

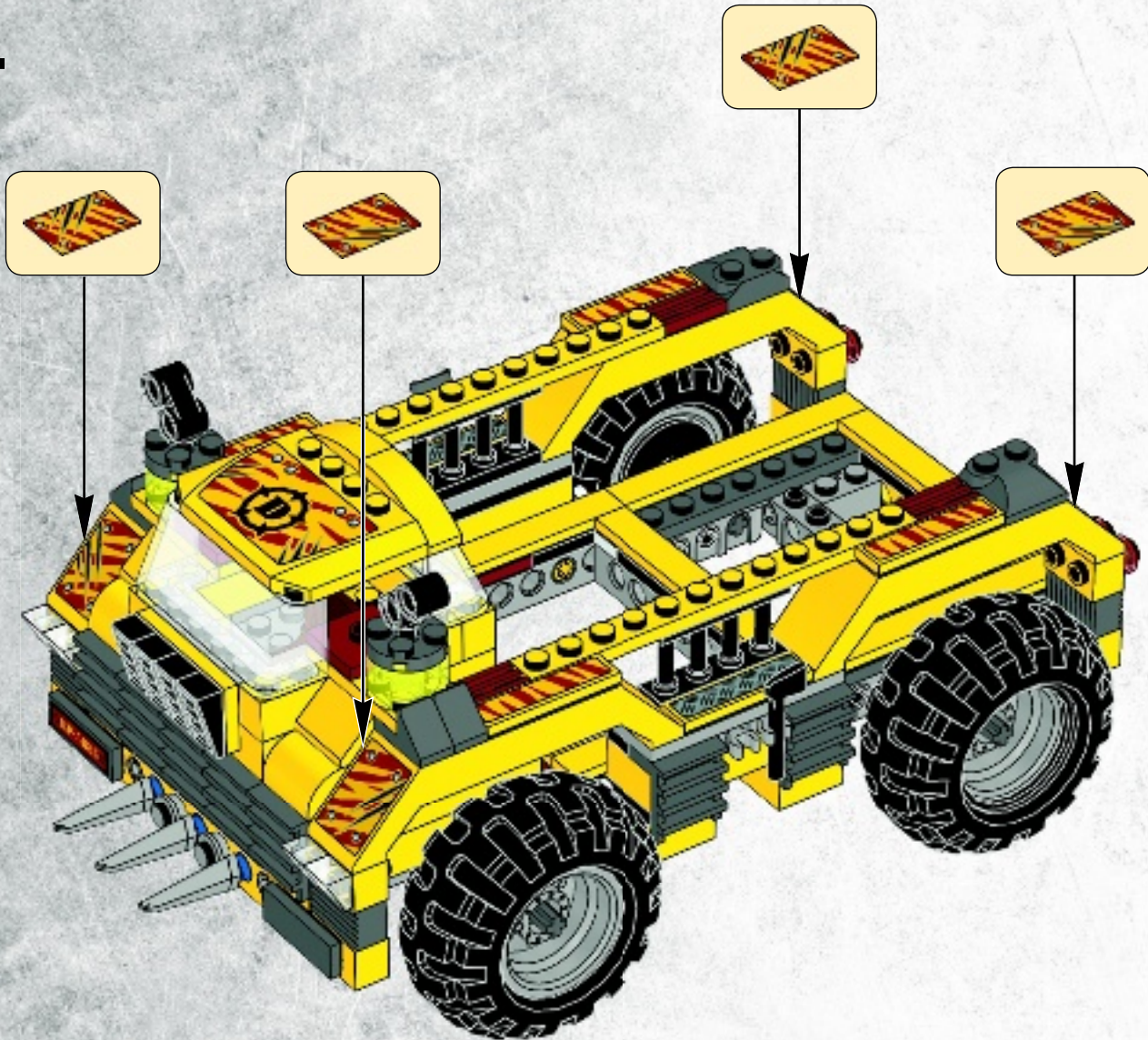

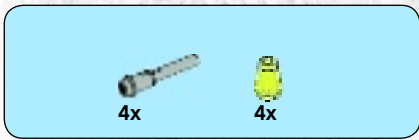

55

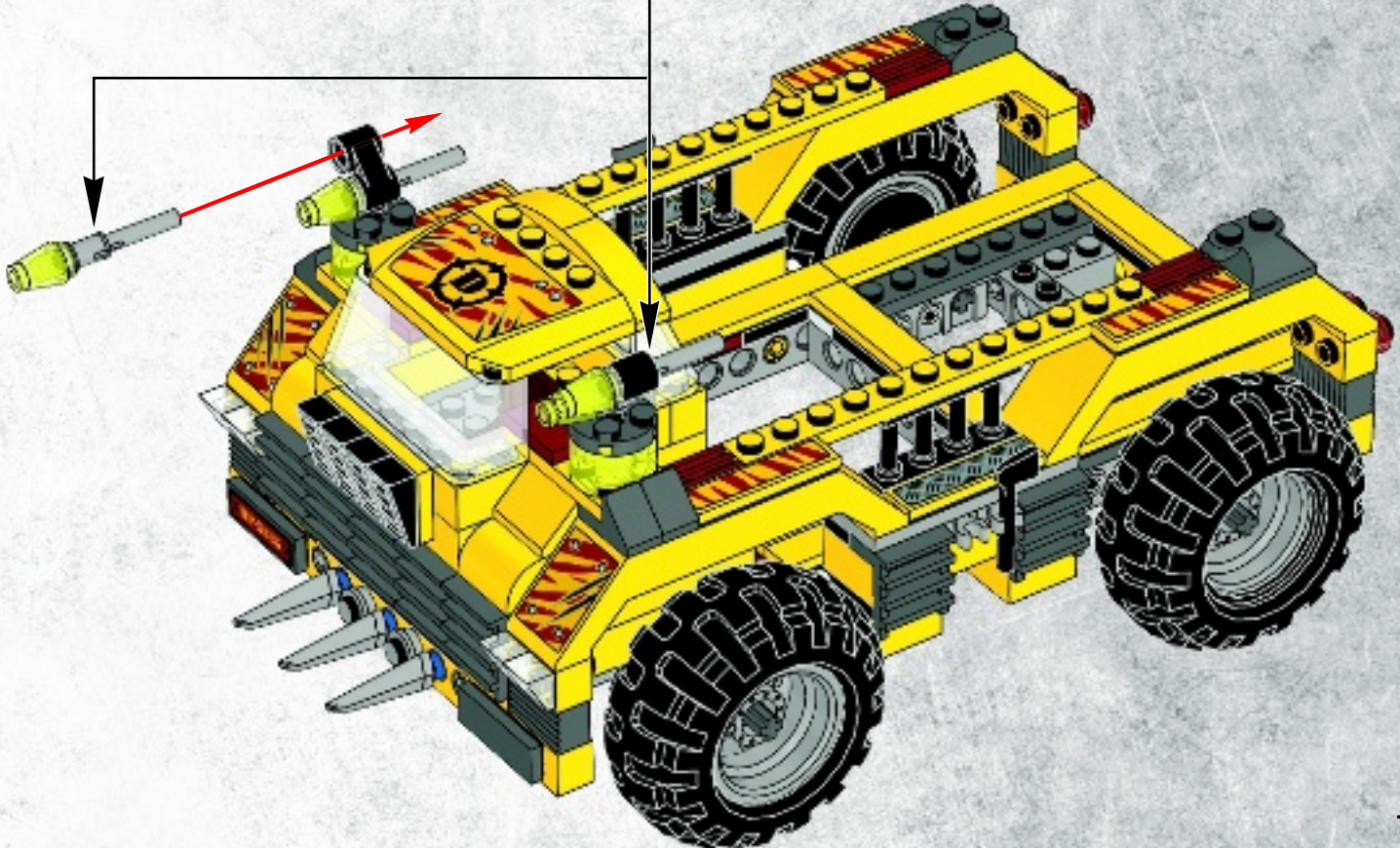
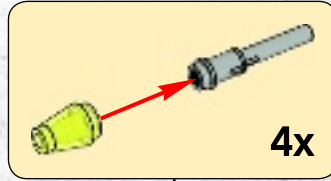
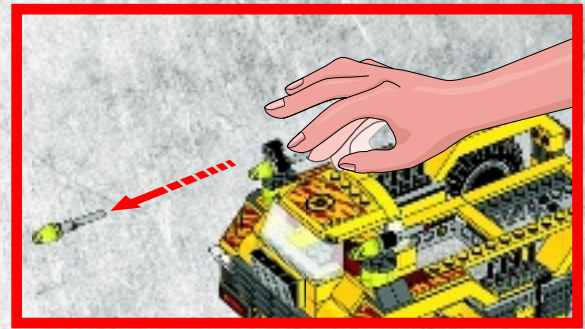

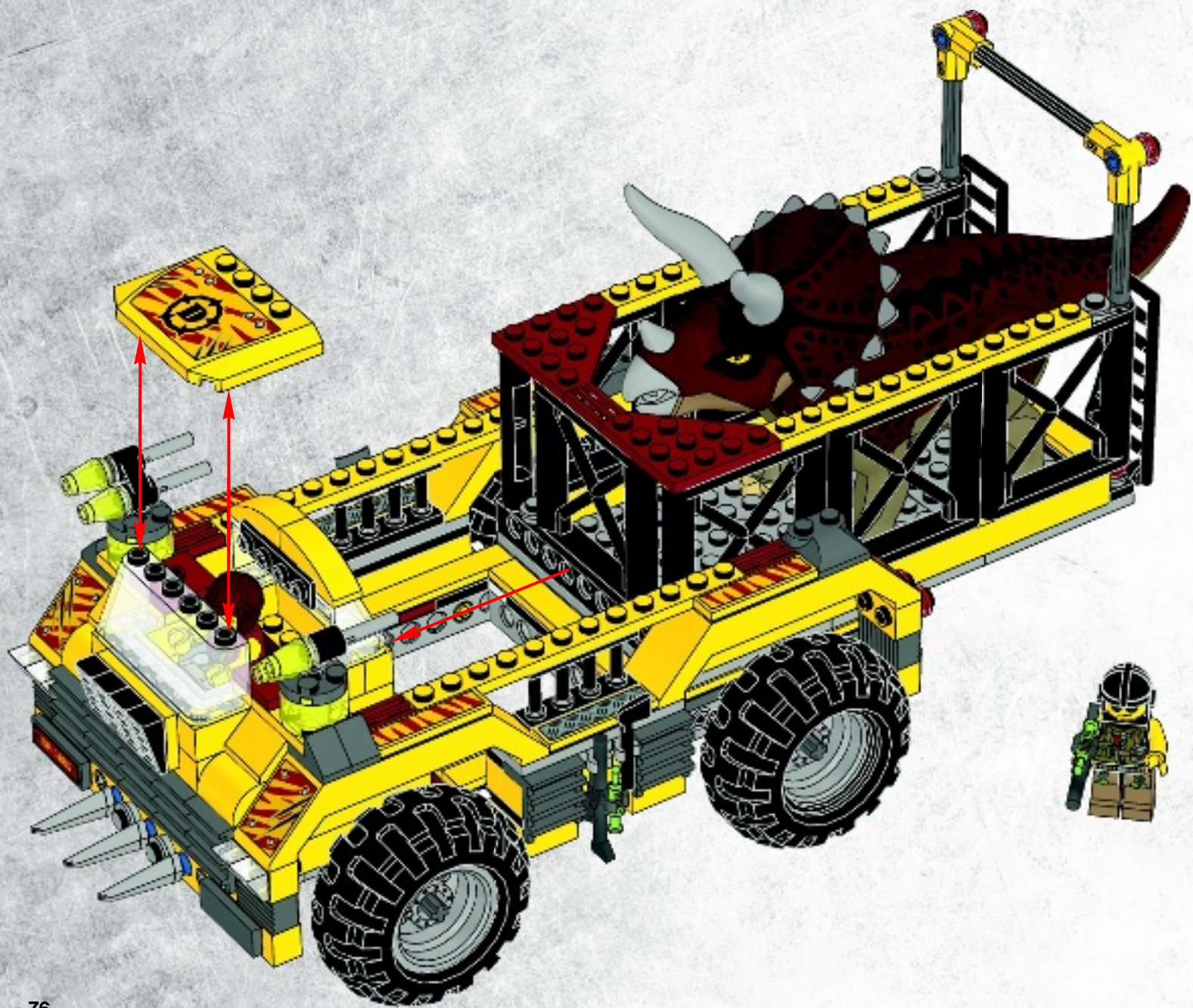

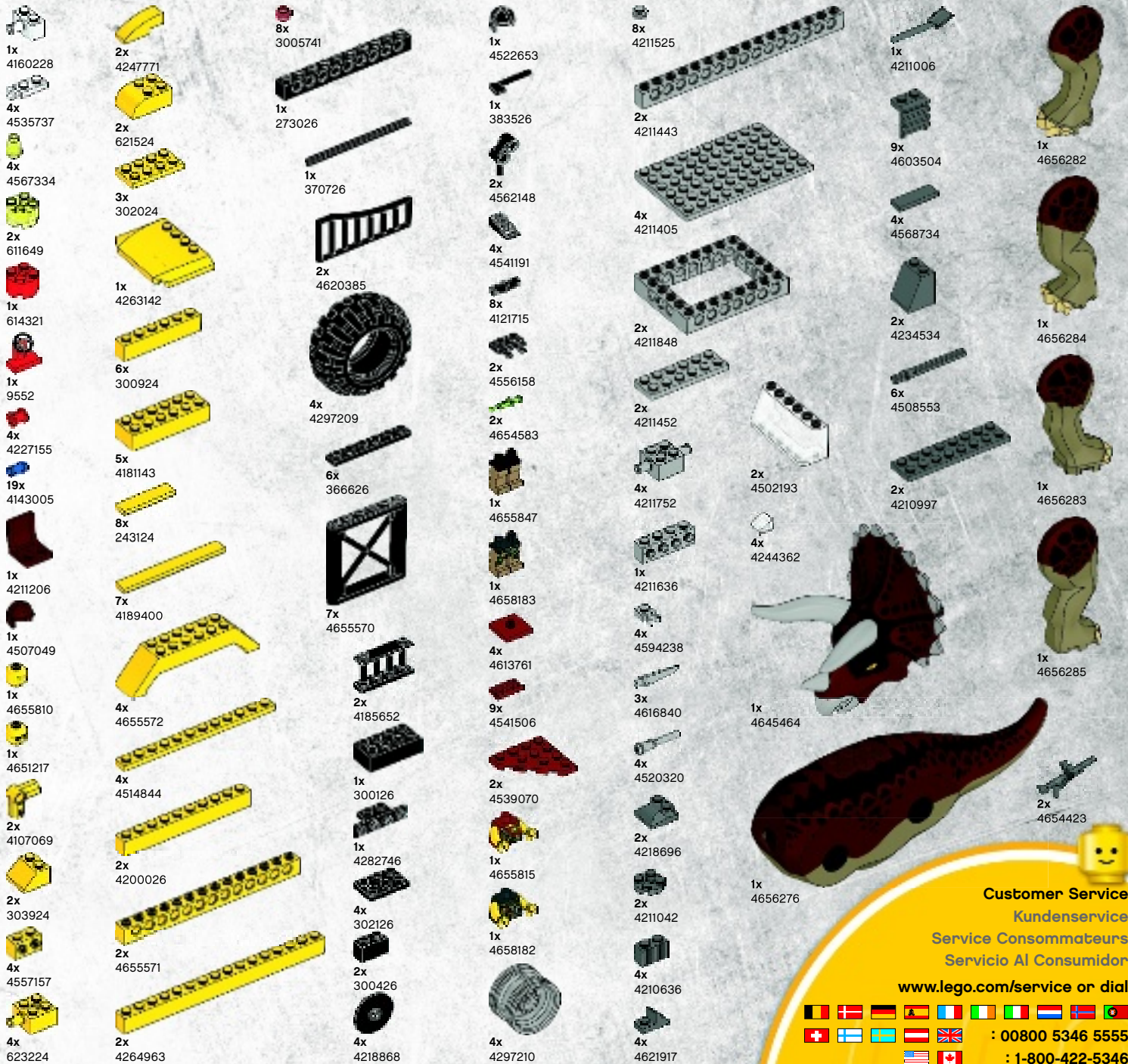

1x
4160228

4x
4535737

4x
4567334

2x
611649

1x
614321

1x
9552

4x
4227155

19x
4143005

1x
4211206

1x
4507049

1x
4655810

1x
4651217

2x
4107069

2x
303924

4x
4557157

4x
623224

2x
4247771

2x
621524

3x
302024

1x
4263142

6x
300924

5x
4181143

8x
243124

7x
4189400

4x
4655572

4x
4514844

2x
4200026

2x
4655571

2x
4264963

8x
3005741

1x
273026

1x
370726

2x
4620385

4x
4297209

6x
366626

7x
4655570

2x
4185652

1x
300126

1x
4282746

4x
302126

2x
300426

4x
4218868

1x
4522653

1x
383526

2x
4562148

4x
4541191

8x
4121715

2x
4556158

2x
4654583

1x
4655847

1x
4658183

4x
4613761

9x
4541506

2x
4539070

1x
4655815

1x
4658182

4x
4297210

8x
4211525

2x
4211443

4x
4211405

2x
4211848

2x
4211452

4x
4211752

1x
4211636

4x
4594238

3x
4616840

4x
4520320

2x
4218696

2x
4211042

4x
4210636

4x
4621917

1x
4211006

9x
4603504

4x
4568734

2x
4234534

6x
4508553

2x
4210997

4x
4244362

1x
4656276

2x
4654423

1x
4656282

1x
4656284

1x
4656283

1x
4656285

1x
4656285

1x
4656285

1x
4656285

1x
4656285

1x
4656285

1x
4656285

1x
4656285

1x
4656285

1x
4656285

1x
4656285

1x
4656285

1x
4656285

1x
4656285

1x
4656285

1x
4656285

1x
4656285

1x
4656285

1x
4656285

1x
4656285

1x
4656285

1x
4656285

1x
4656285

1x
4656285

1x
4656285

1x
4656285

1x
4656285

Customer Service

Kundenservice

Service Consommateurs

Servicio Al Consumidor

www.lego.com/service or dial

: 00800 5346 5555

: 1-800-422-5346

5882



5884



5883



5885



5886



5887





www.LEGOclub.com



LEGO® Club Email

LEGO club™

FREE! GRATIS! GRATUIT!



LEGO® Club Magazine

SIGN UP ONLINE!

www.LEGOclub.com



00800 5346 5555*



1-866-534-6258 • 1-877-518-5346

US & Canada only

Canada seulement

* Freephone. Mobile charges may apply.
* Numéro sans frais. Des frais peuvent s'appliquer avec les téléphones cellulaires.
* Gebührenfrei, Kosten für Anrufe aus Mobilfunknetzen können abweichen.
* Gratis telefonnummer vanaf vaste lijn.
* Det är gratis nummer, när du ringer fra fasttelefon.
* Det är gratis, när du ringer från en fast telefon.
* Numéro sans frais. Des frais peuvent s'appliquer avec les téléphones portables.



WIN!

Go to www.LEGOsurvey.com/product to fill out a survey for a chance to win a cool LEGO® Product.

No purchase necessary.

Open to all residents where not prohibited.



www.LEGO.com



www.LEGOsurvey.com/product

GEWINNE! WIN!

Nimm an der Umfrage auf www.LEGOsurvey.com/product teil und hab die Chance ein cooles LEGO® Produkt zu gewinnen!

Die Teilnahme am Gewinnspiel führt zu keinerlei Kaufverpflichtungen. Teilnahme in allen nicht ausgeschlossenen Ländern möglich.

Ga naar www.LEGOsurvey.com/product, vul een enquêteformulier in en maak kans op een cool LEGO® product.

Geen aankoopverplichting. Iedereen mag deelnemen, uitgezonderd ingezetenden van landen waar een enquêteverbod geldt.

GAGNE! 当てよう!

Visite www.LEGOsurvey.com/product pour répondre à un questionnaire et avoir une chance de gagner un produit LEGO® très cool!

Aucune obligation d'achat. Ouvert à tous les résidents des pays autorisés.

www.LEGOsurvey.com/product にアクセスして、アンケートにご記入ください。当選者にはレゴ®製品を差し上げます。

お買い上げの必要はありません。

禁止されていない限り、すべての皆様にご利用いただけます。