



# RACERS

8227



1

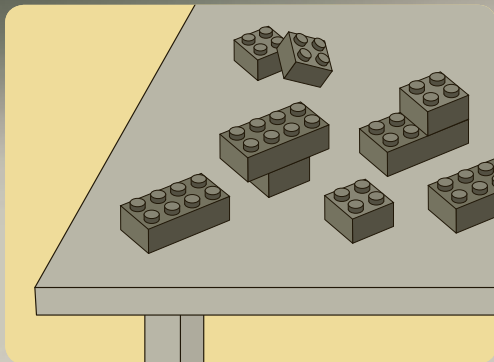
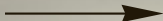

2

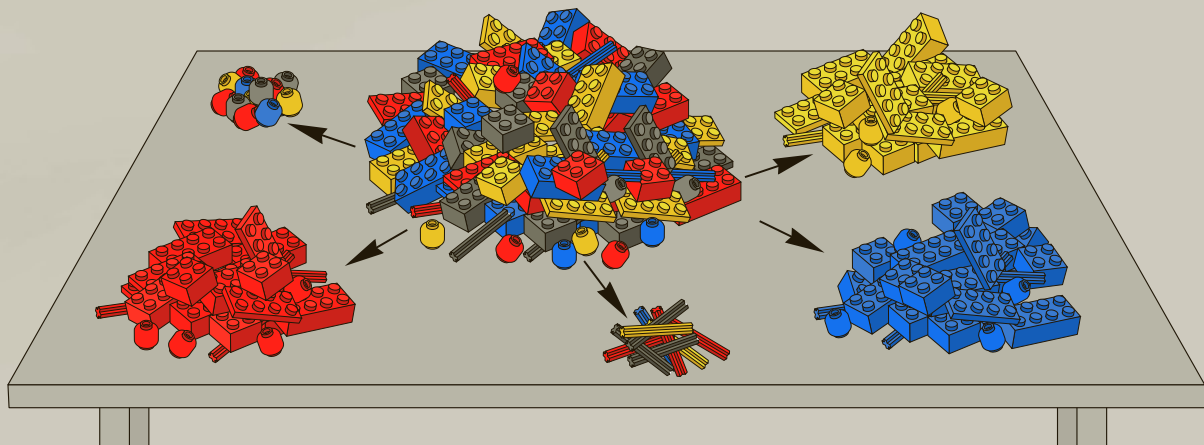

2

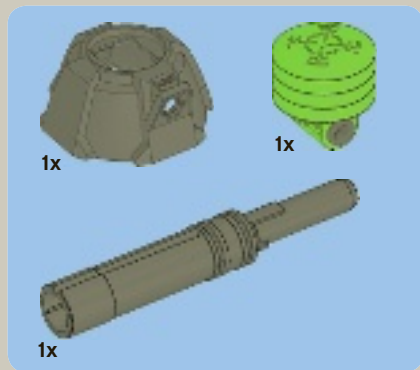

1

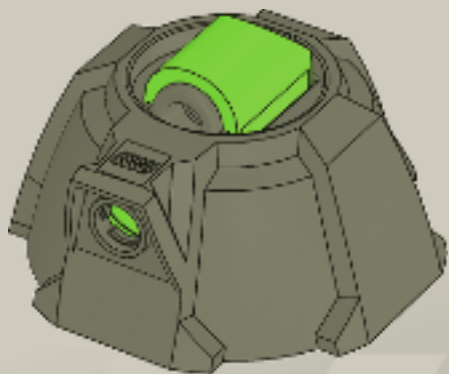

**2**

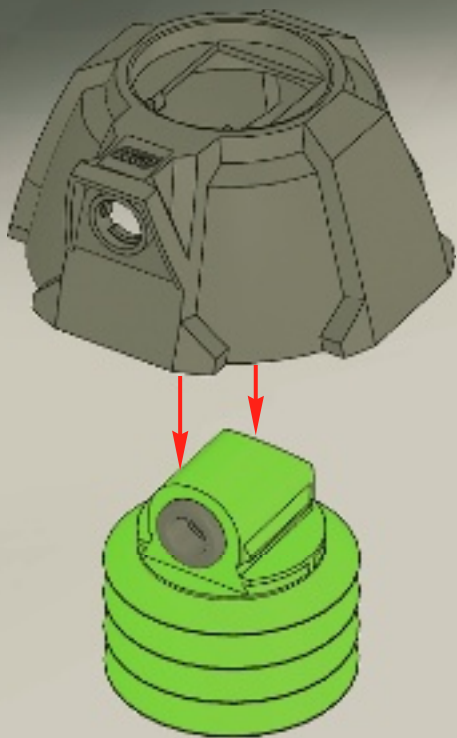

**3**

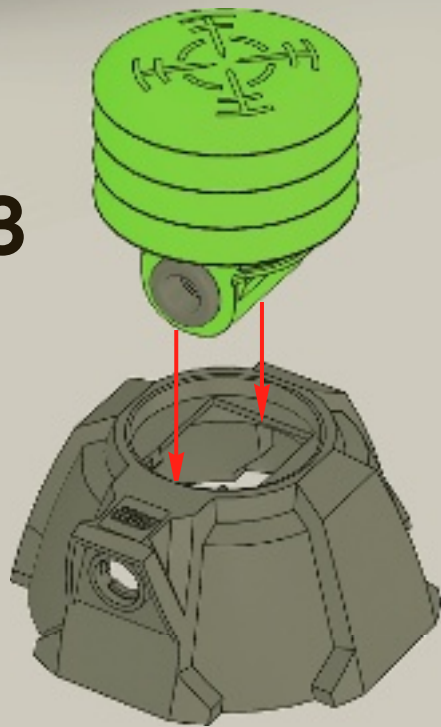

4

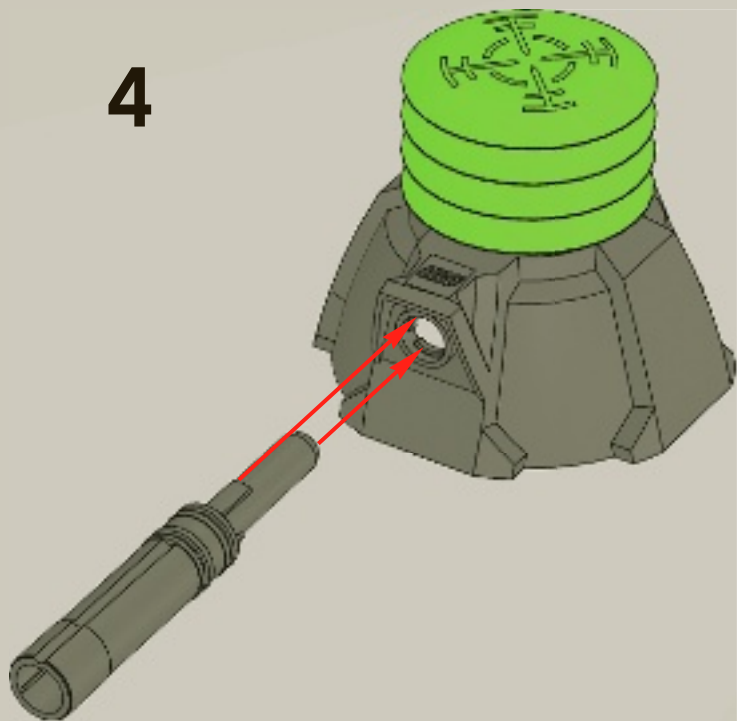

5

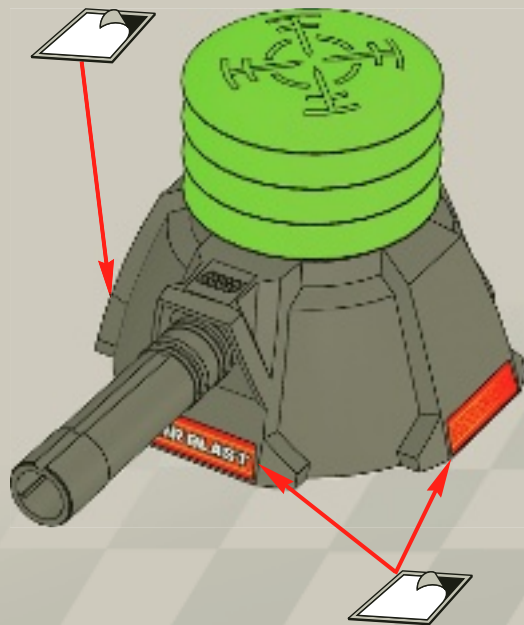



1x

1



6



2x

2

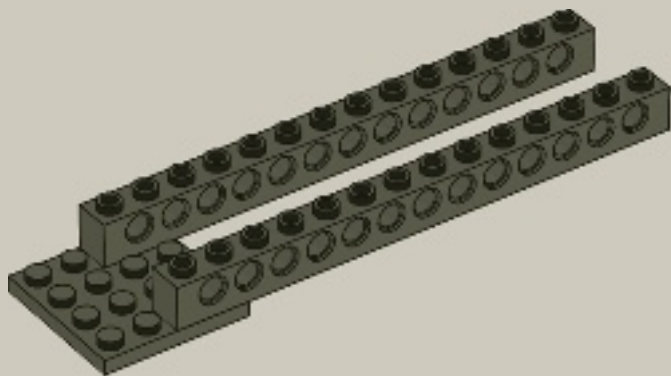



3

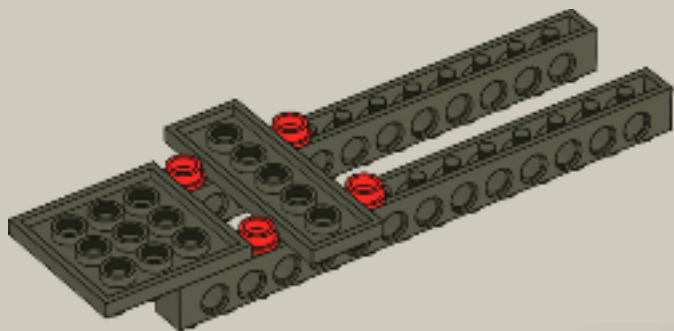

4

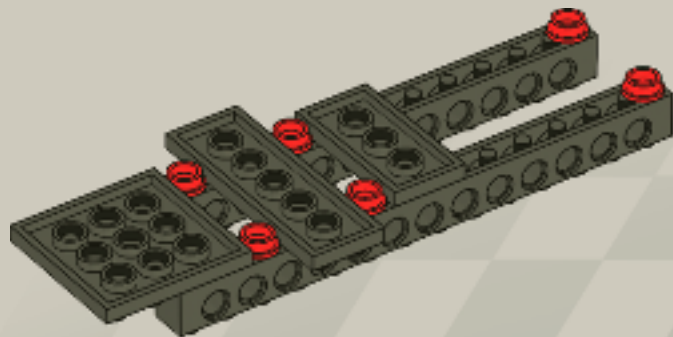





1x



2x

5



8



1x



1x

6

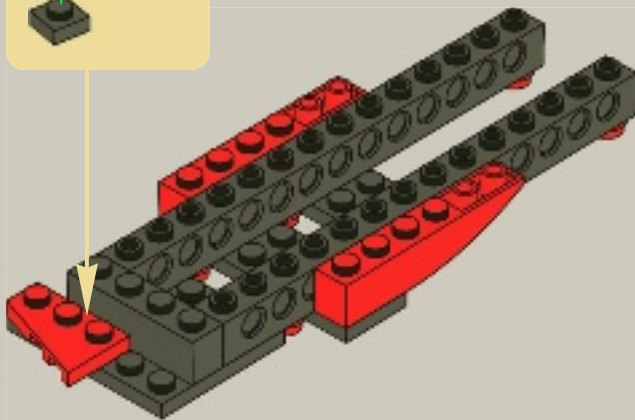





1x



1x

# 7

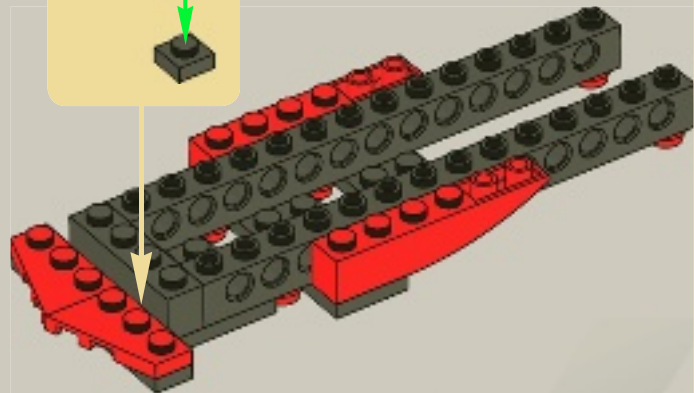
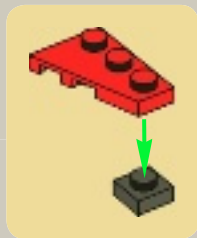

1x



2x



2x

# 8



2x

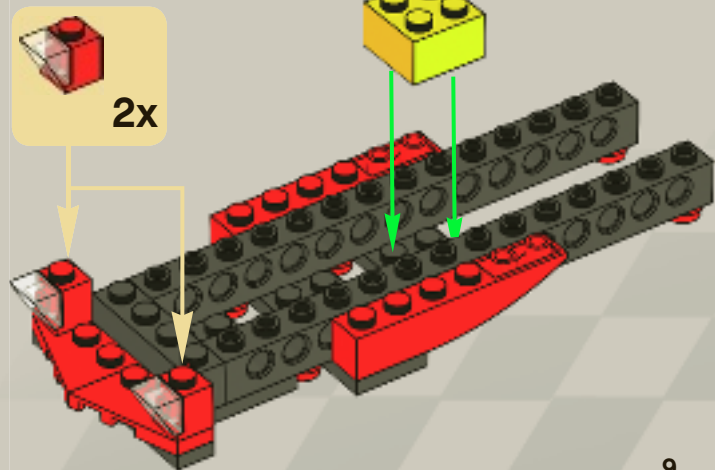

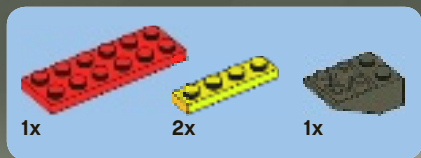

9

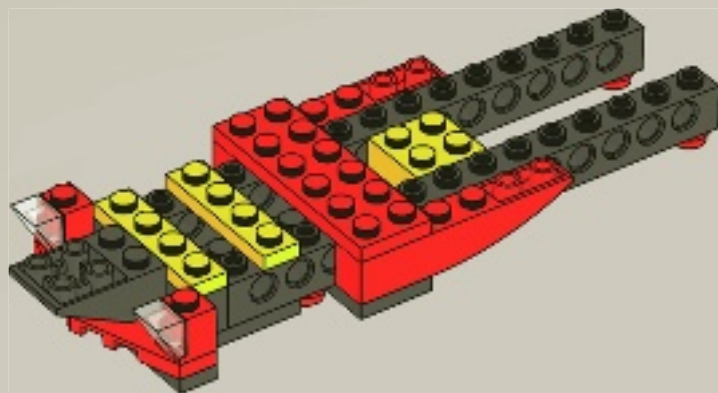



2x



2x

# 10

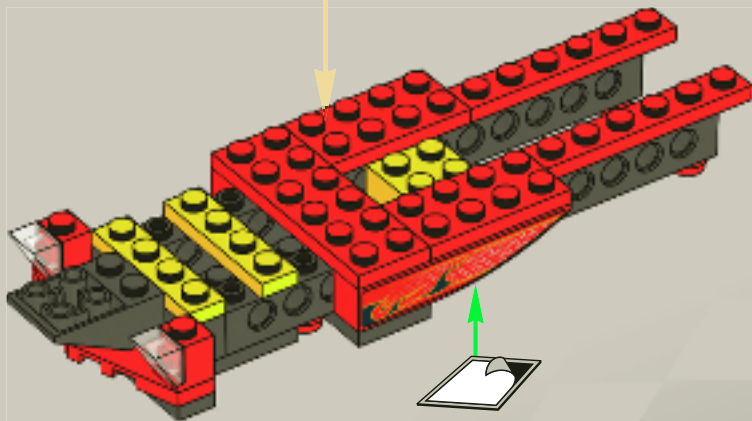

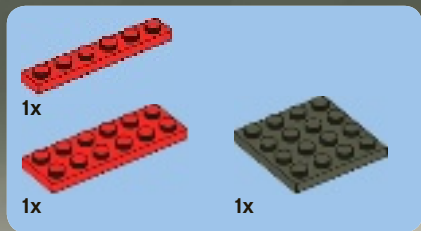

11

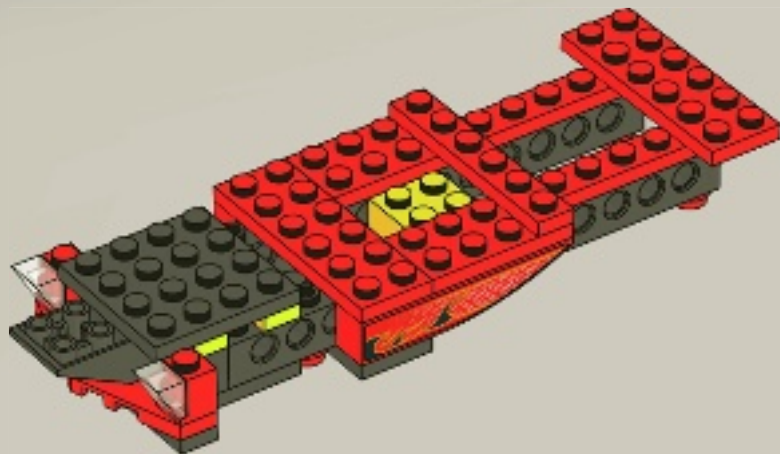



12

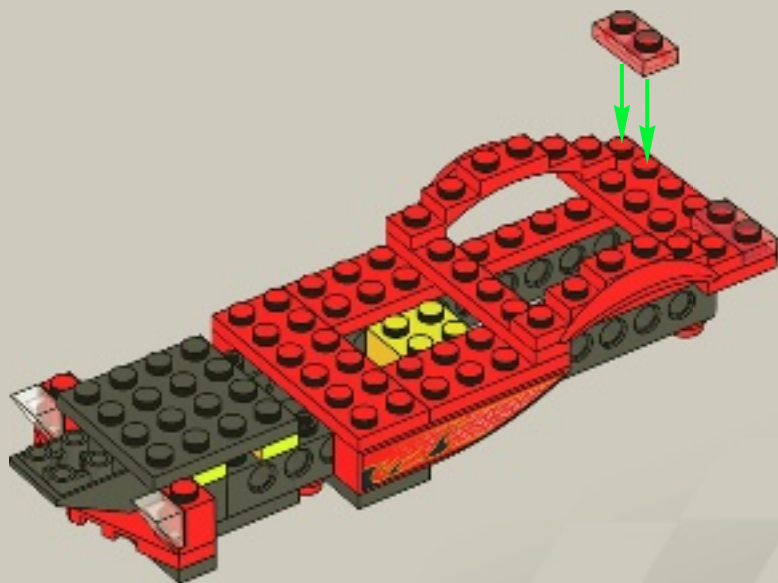



2x



2x

# 13

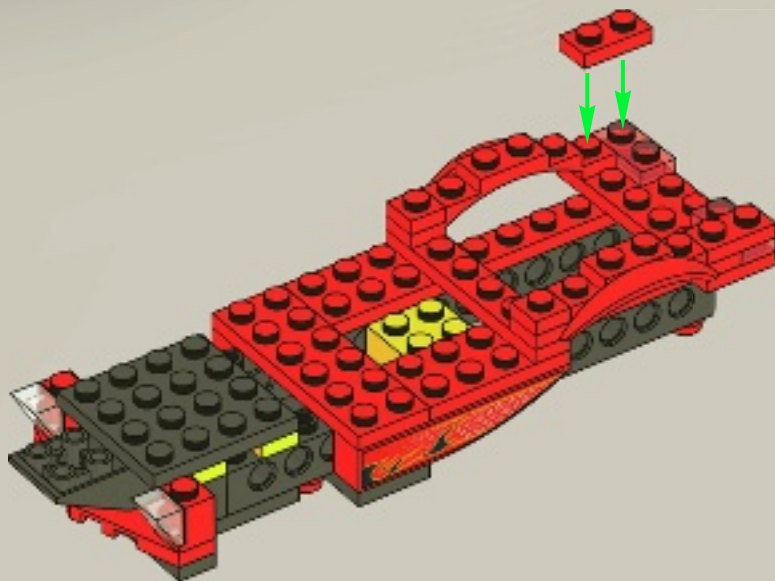

14

# 14

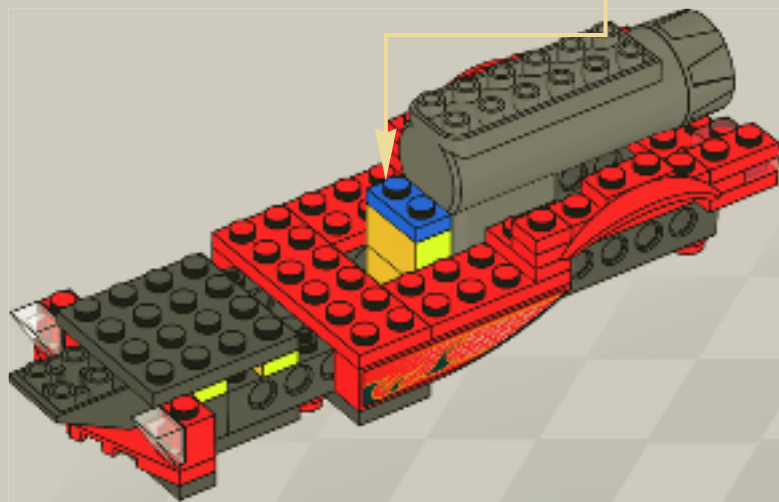
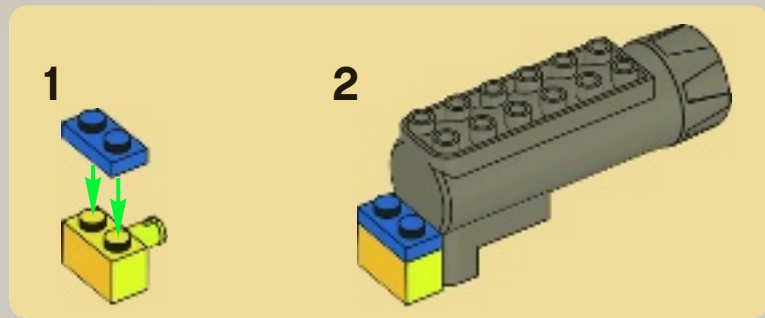
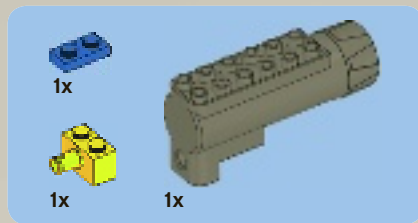





1x



2x

# 15

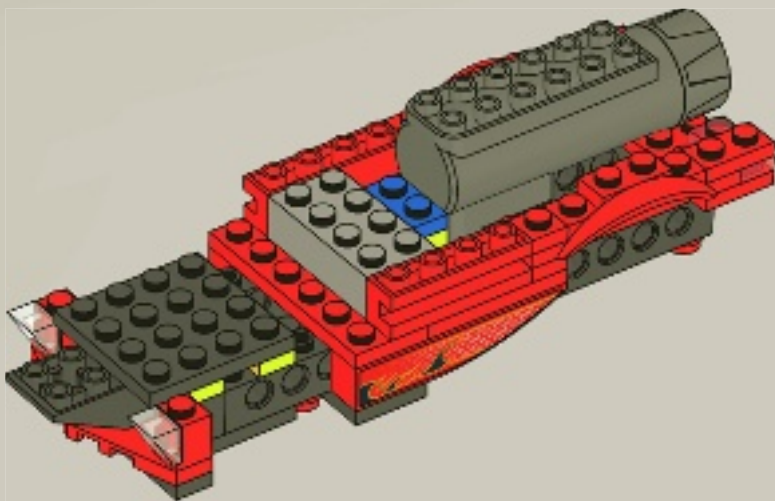

16



4x

# 16

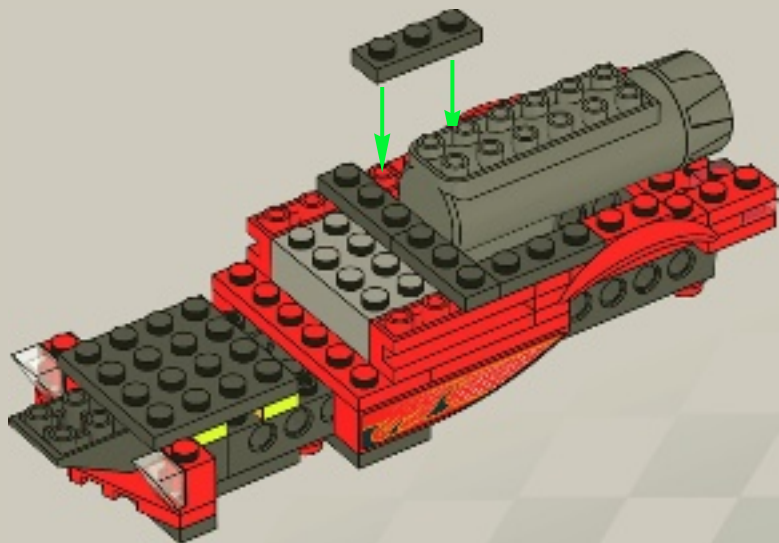



18

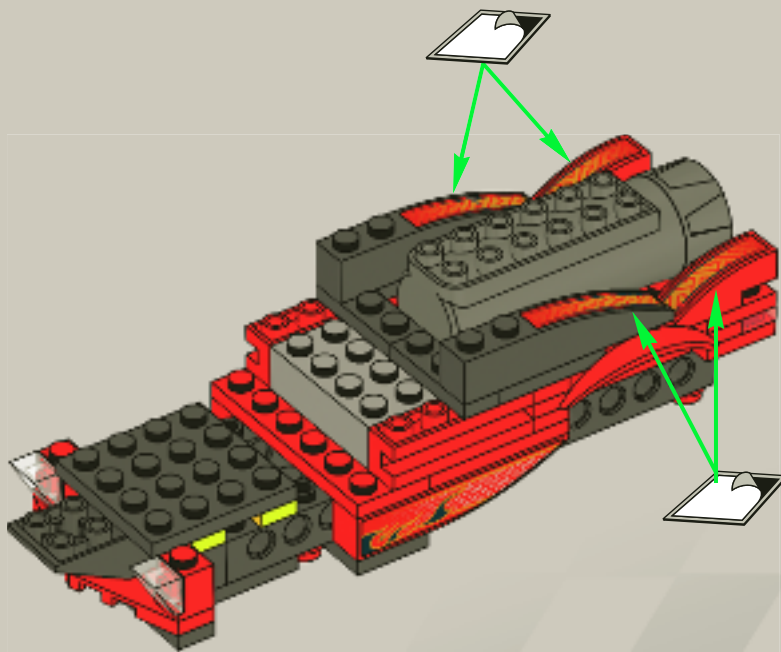



2x

19

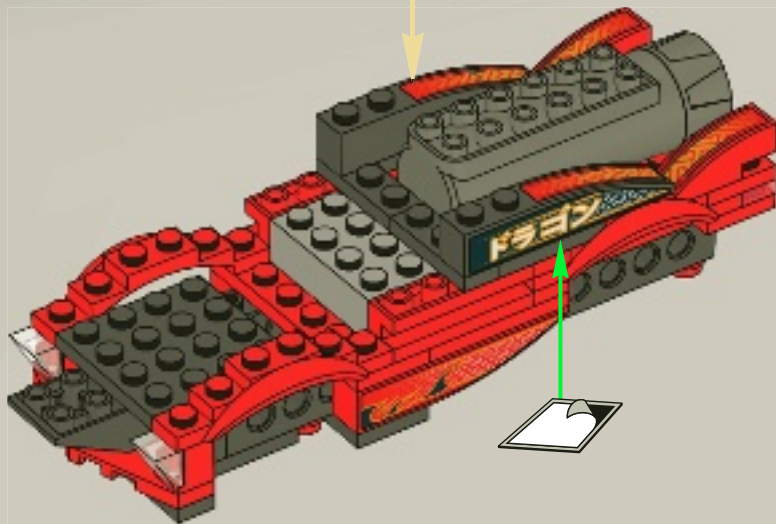

20

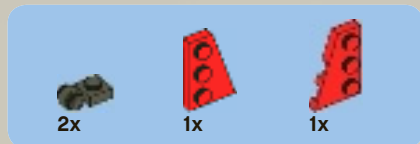

20

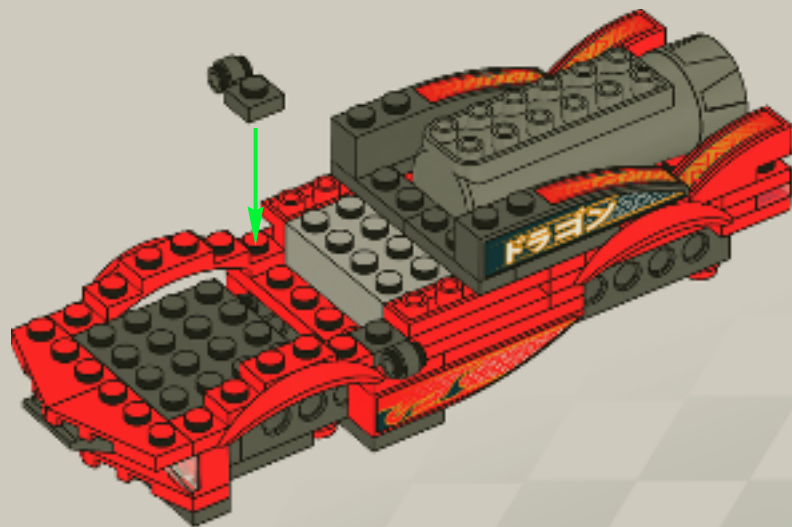



2x



1x

# 21

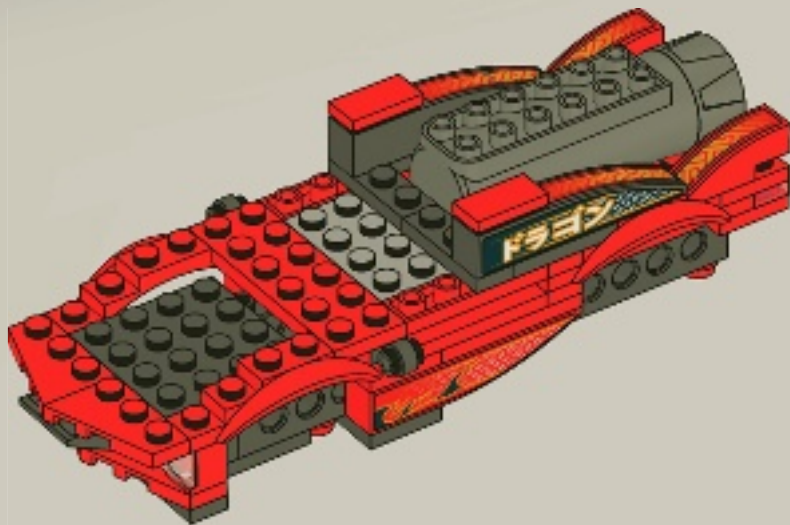

22





3x

22

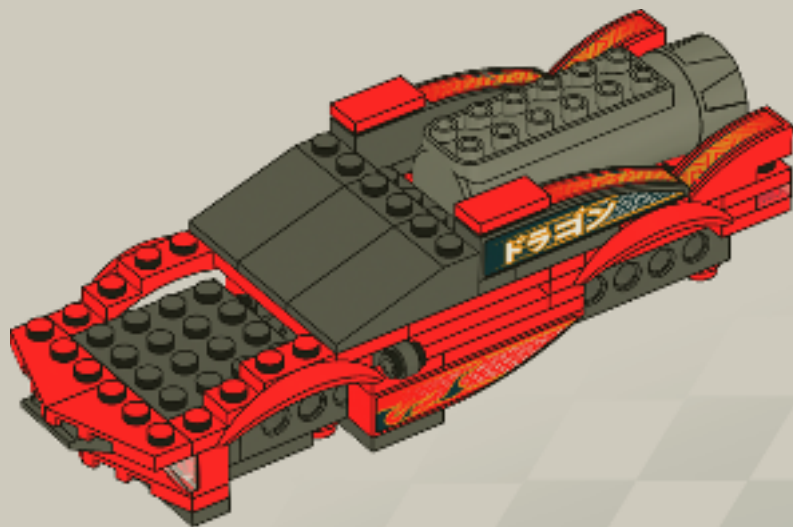



2x



1x

# 23

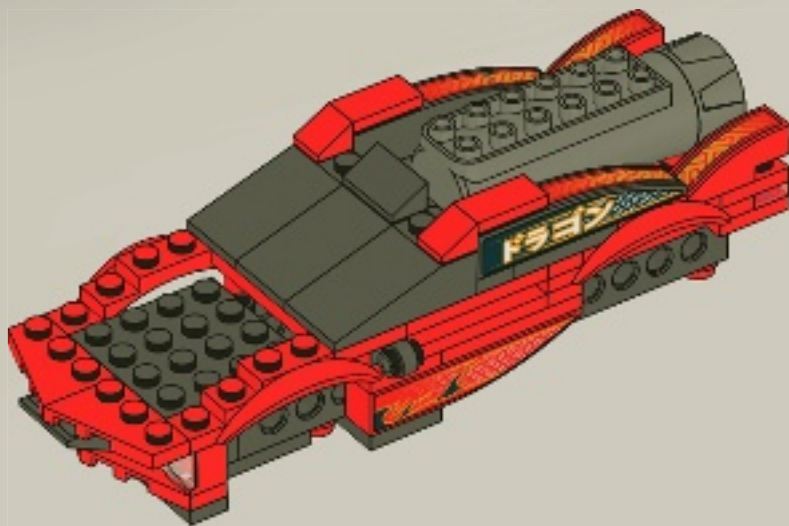

24



2x

# 24

1



2

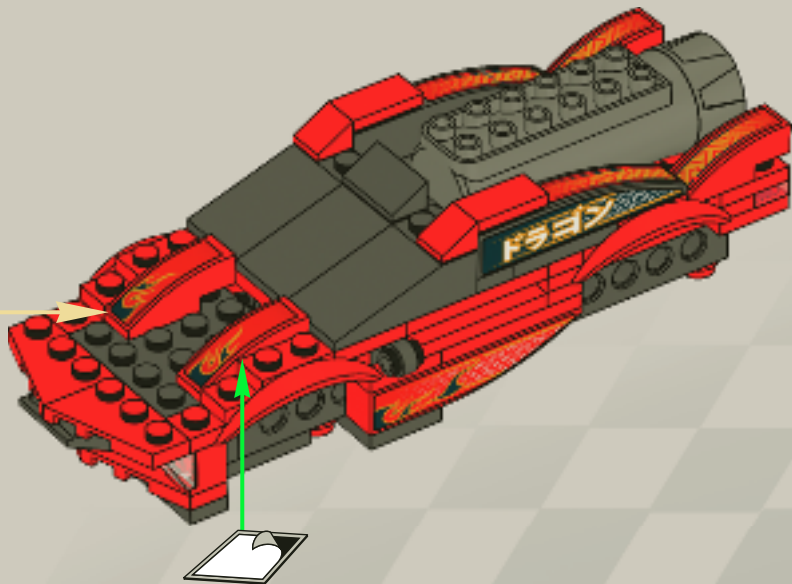



1x



2x

# 25

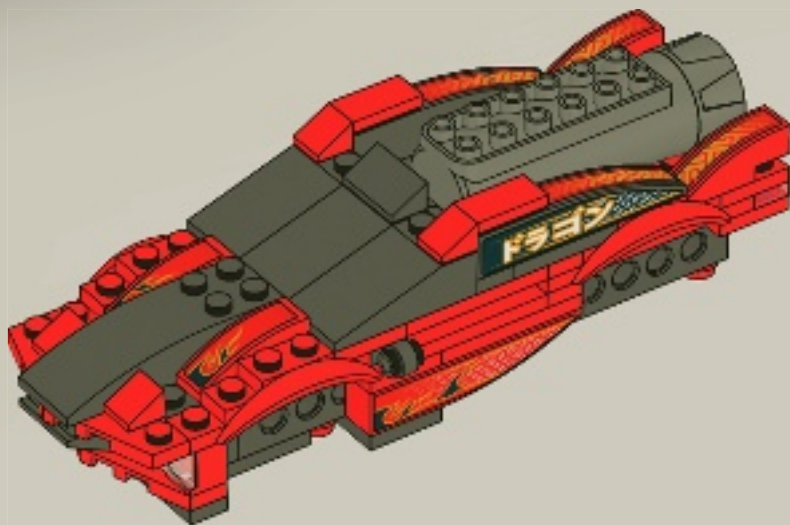

26

26

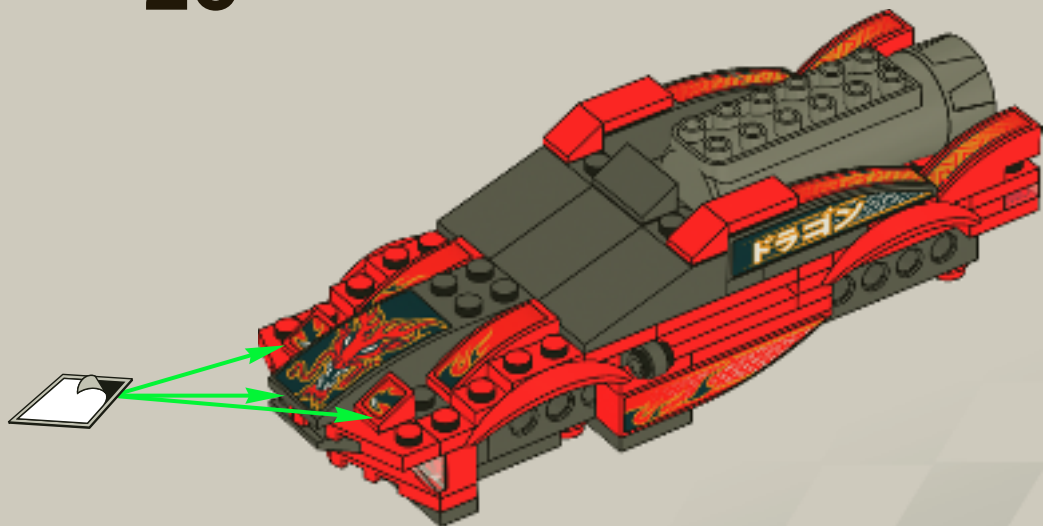



2x



2x

27

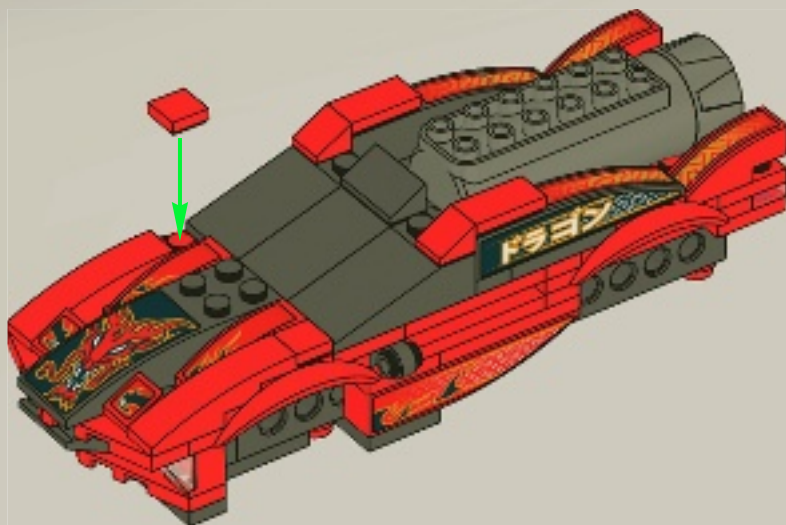

28

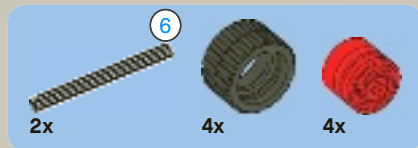

28

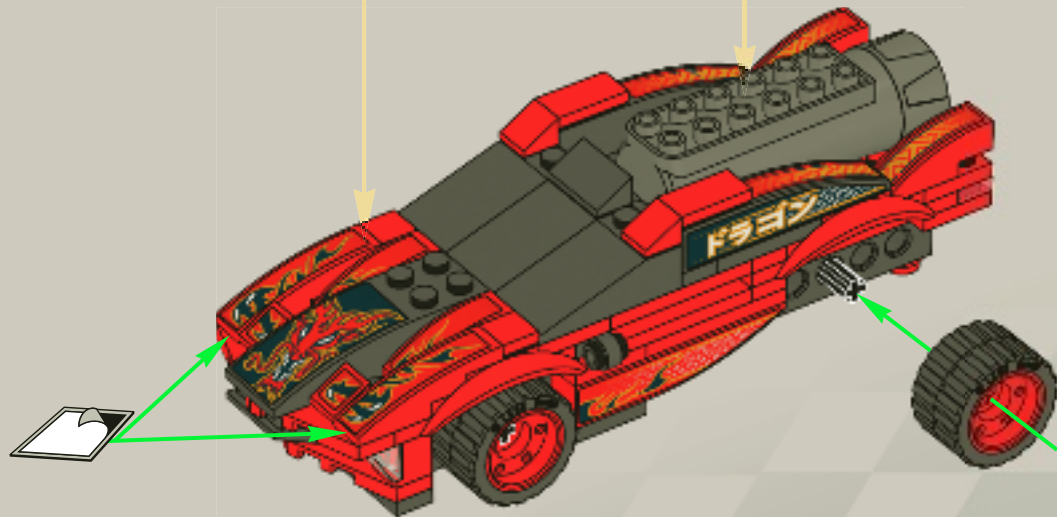
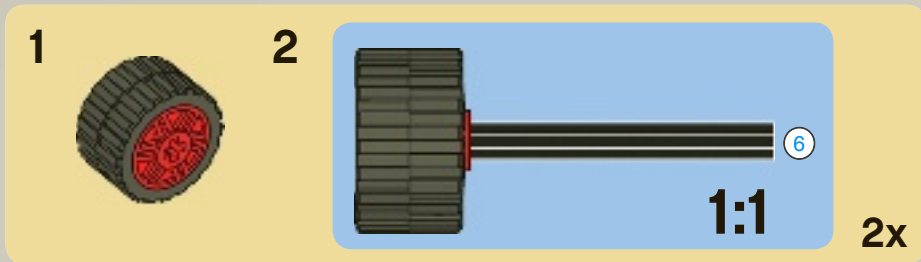



29

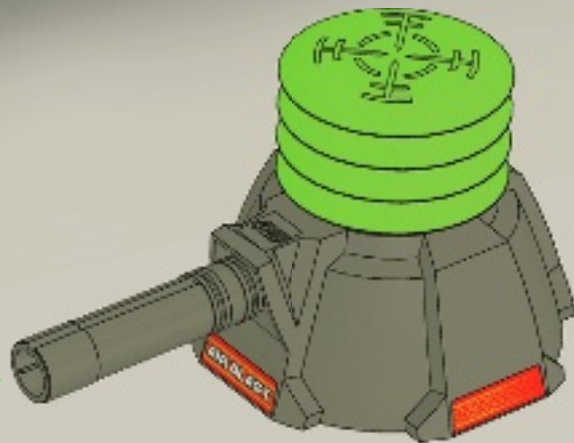
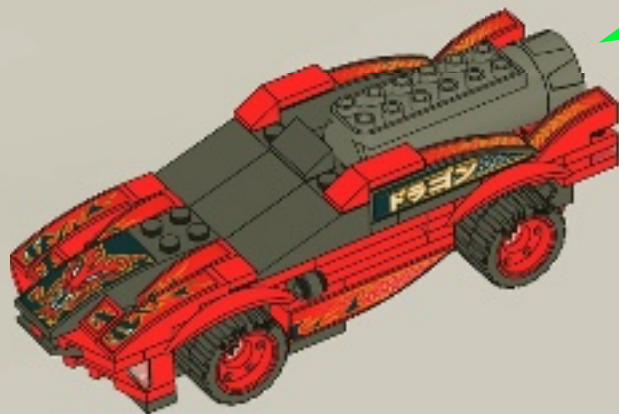



6x  
614121



2x  
407021



2x  
4568268



4x  
4504379



4x  
4251162



2x  
4520782



2x  
4160406



2x  
302421



2x  
307021



2x  
306921



2x  
302321



2x  
302021



3x  
366621



3x  
379521



2x  
4180533



2x  
4180504



4x  
4570807



4x  
4525791



1x  
302323



1x  
4211385



2x  
4201019



2x  
4244362



1x  
300324



2x  
371024



1x  
245824



1x  
379526



1x  
374726



3x  
4185583



2x  
4160393



1x  
4180548



2x  
302426



4x  
362326



1x  
302026



2x  
4107558



2x  
4243819



2x  
408126



1x  
301026



1x  
4548180



4x  
4524358



2x  
370626



1x  
4612424



1x  
4563226



1x  
4568692



1x  
4563215

6



**Customer Service**  
**Kundenservice**  
**Service Consommateurs**  
**Servicio Al Consumidor**

[www.lego.com/service](http://www.lego.com/service) or dial

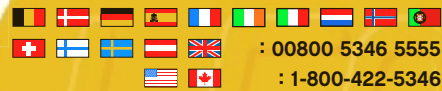

: 00800 5346 5555

: 1-800-422-5346

# WIN!

Go to [www.LEGOsurvey.com/product](http://www.LEGOsurvey.com/product) to fill out a survey for a chance to win a cool LEGO® Product.

No purchase necessary.

Open to all residents where not prohibited.

## [www.LEGOsurvey.com/product](http://www.LEGOsurvey.com/product)

### GEWINNE!

Nimm an der Umfrage auf [www.LEGOsurvey.com/product](http://www.LEGOsurvey.com/product) teil und hab die Chance ein cooles LEGO® Produkt zu gewinnen!

Die Teilnahme am Gewinnspiel führt zu keinerlei Kaufverpflichtungen. Teilnahme in allen nicht ausgeschlossenen Ländern möglich.

4614523

### WIN!

Ga naar [www.LEGOsurvey.com/product](http://www.LEGOsurvey.com/product), vul een enquêteformulier in en maak kans op een cool LEGO® product.

Geen aankoopverplichting. Iedereen mag deelnemen, uitgezonderd ingezetenden van landen waar een enquêteverbod geldt.

LEGO and the LEGO logo are trademarks of the LEGO Group. ©2011 The LEGO Group. ©2011 LucasFilm Ltd. & TM. All rights reserved.

### GAGNE!

Visite [www.LEGOsurvey.com/product](http://www.LEGOsurvey.com/product) pour répondre à un questionnaire et avoir une chance de gagner un produit LEGO® très cool!

Aucune obligation d'achat. Ouvert à tous les résidents des pays autorisés.

### 当てよう!

[www.LEGOsurvey.com/product](http://www.LEGOsurvey.com/product) にアクセスして、アンケートにご記入ください。当選者にはレゴ®製品を差し上げます。

お買い上げの必要はありません。禁止されていない限り、すべての皆様にご利用いただけます。