

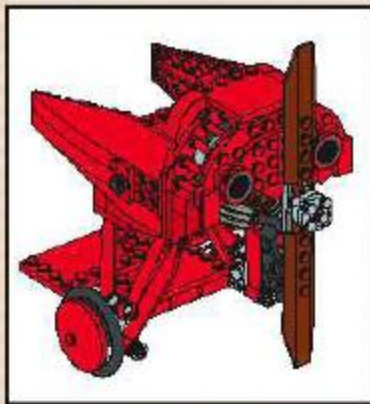

10024

# Red Baron

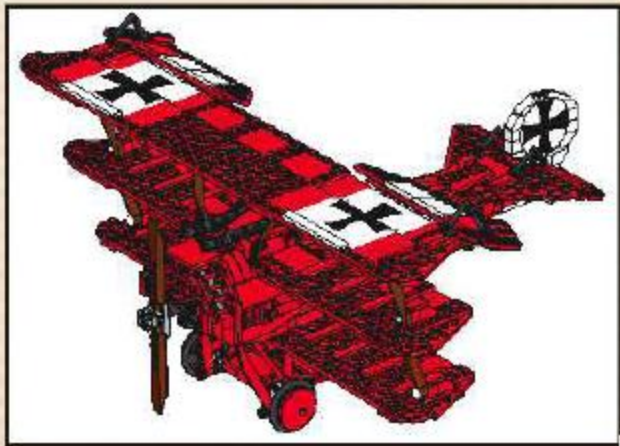



**2**

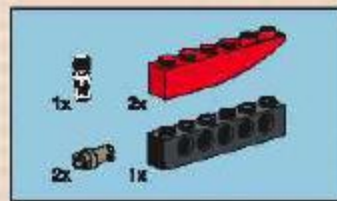
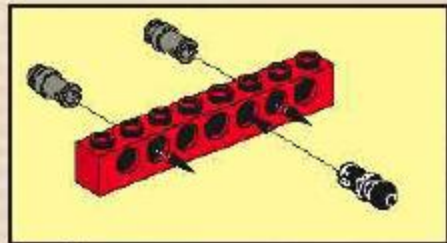

**3**

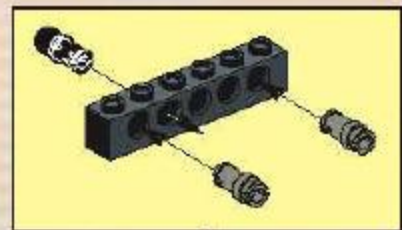



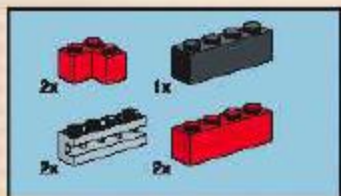

4



5

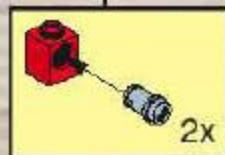
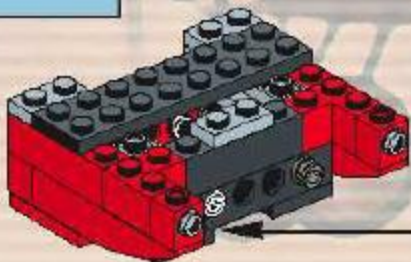

6

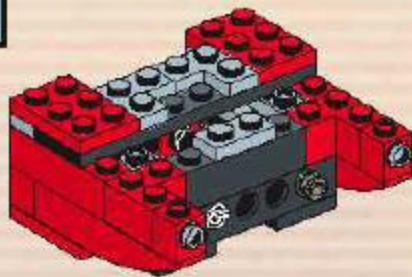

7

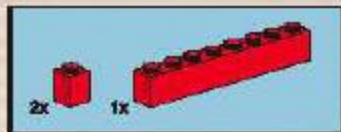
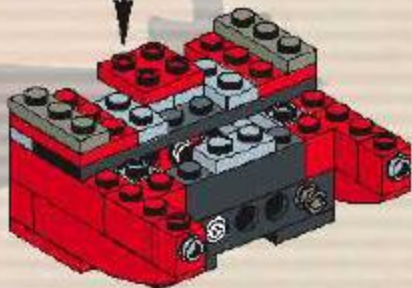

8

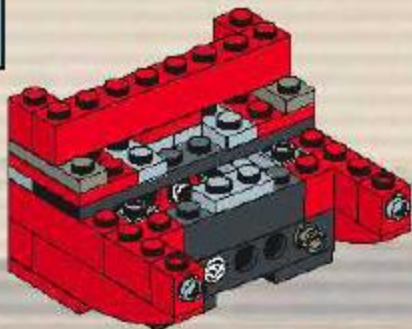

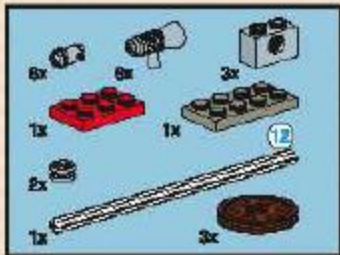

9

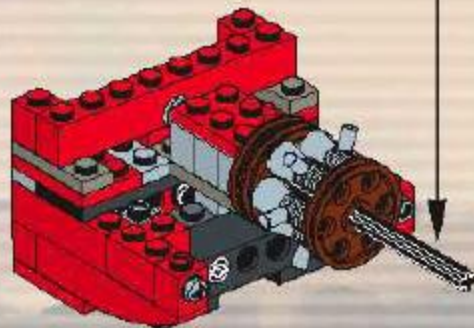
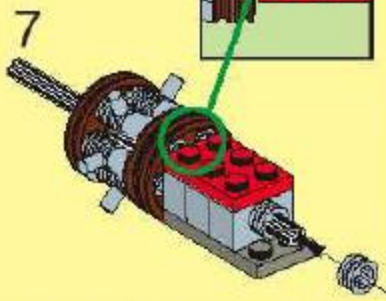
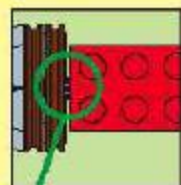
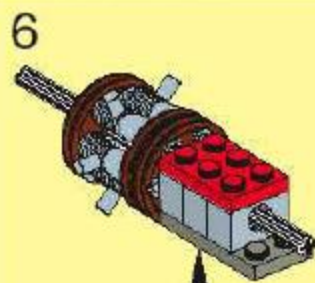
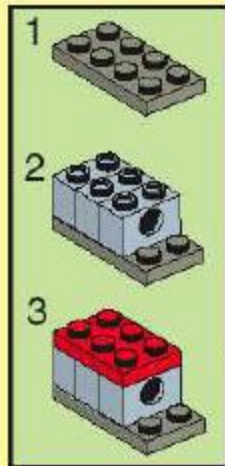
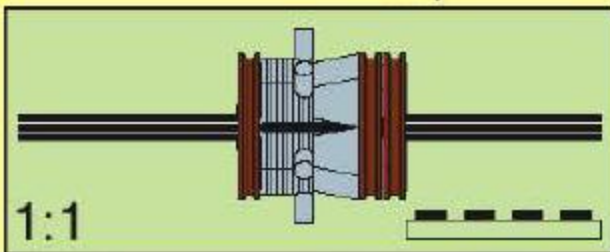
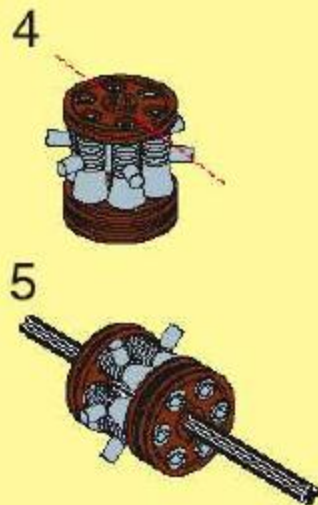





10

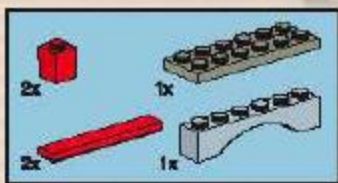
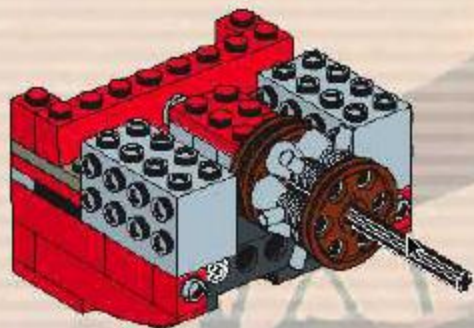

11

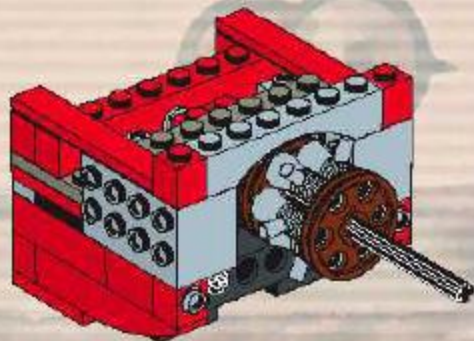

12

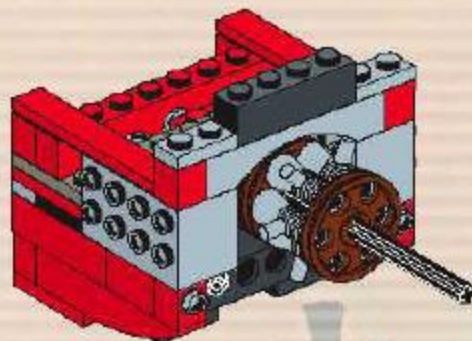

13

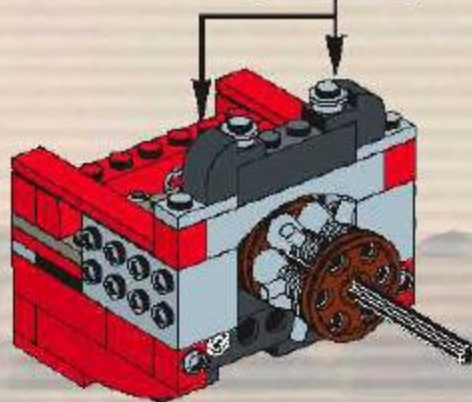



14

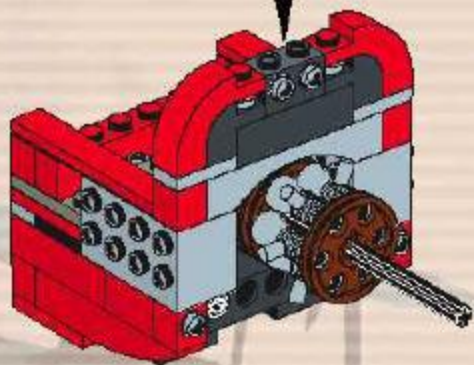
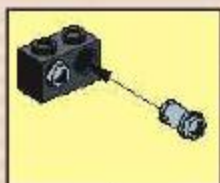

15

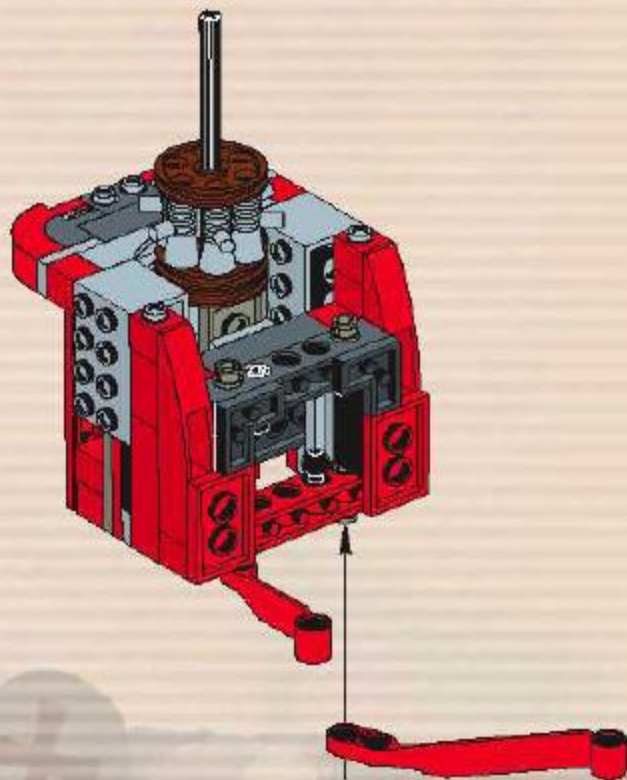



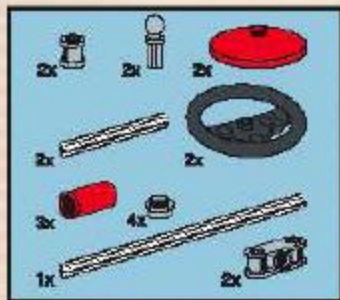

16

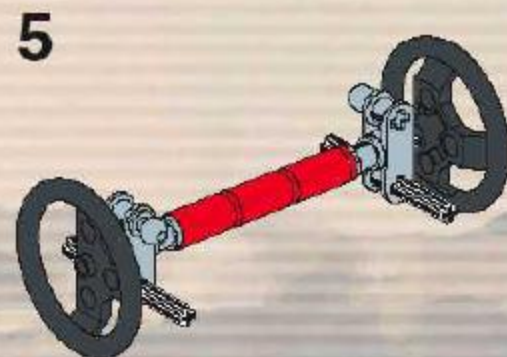
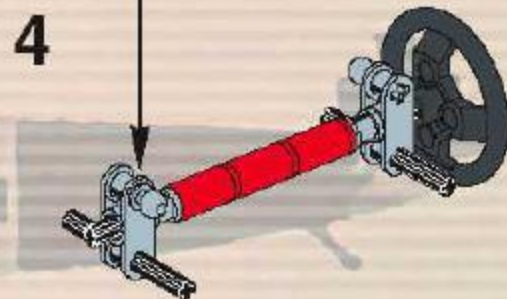
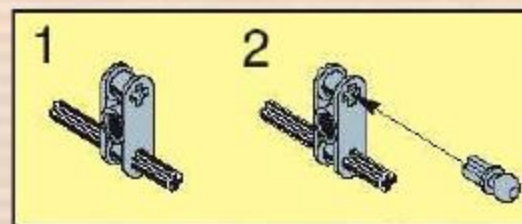
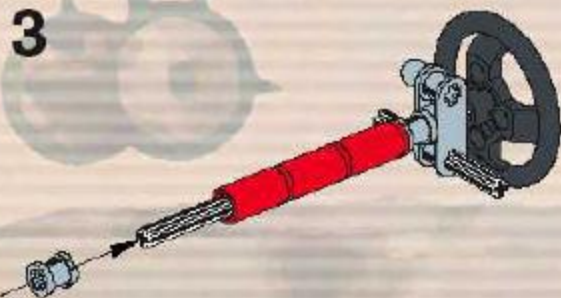
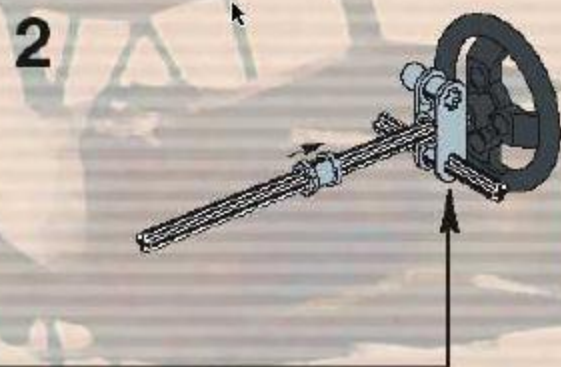
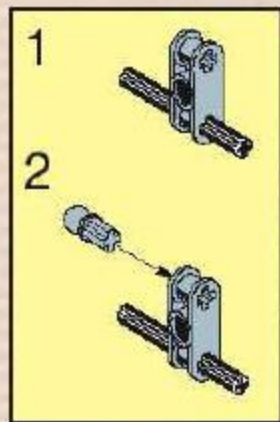

6

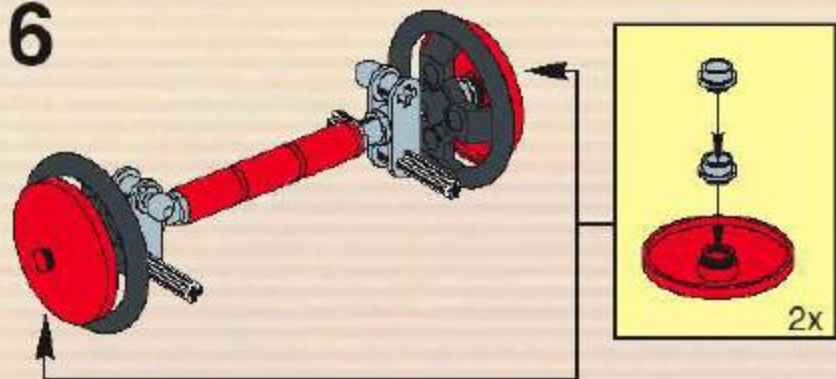

2x 

17

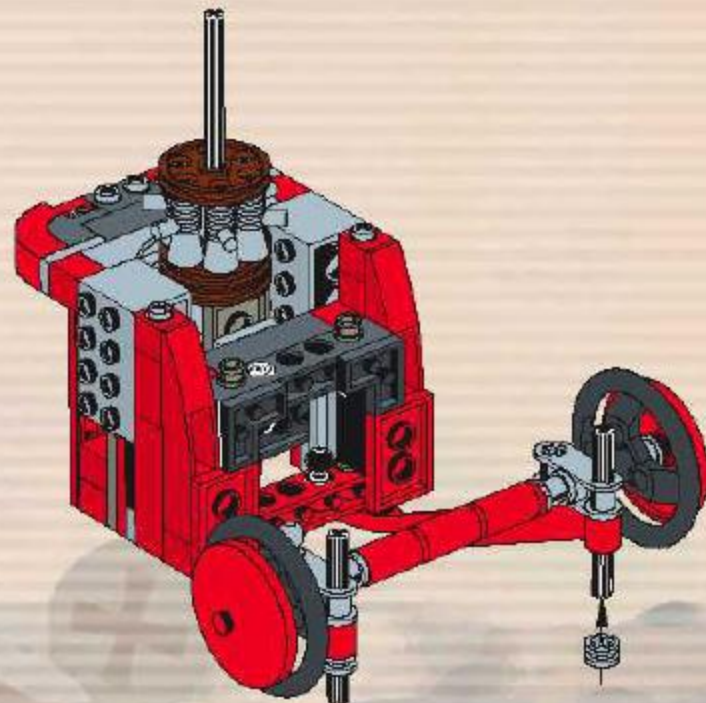
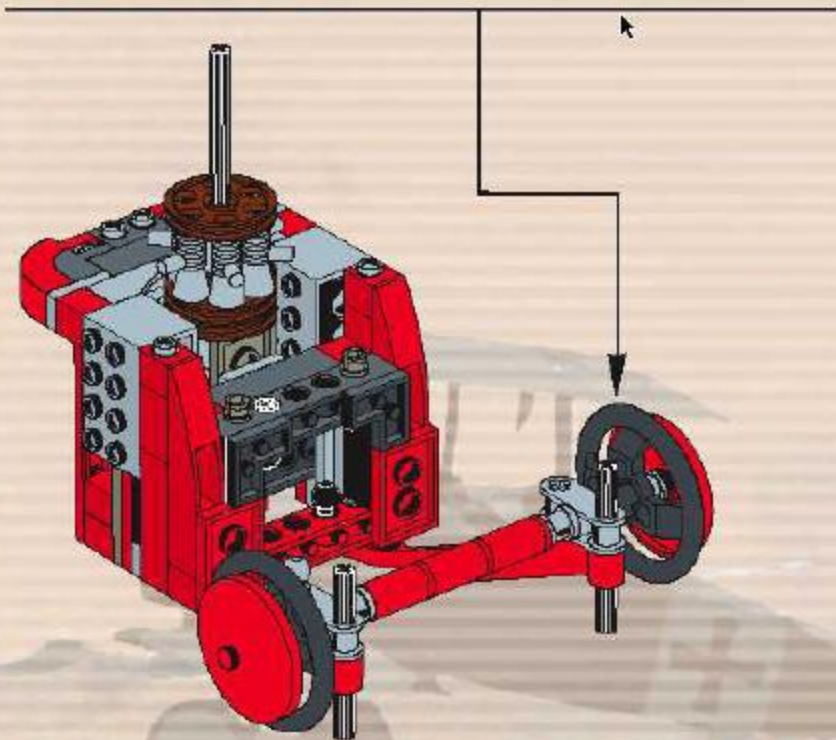





18

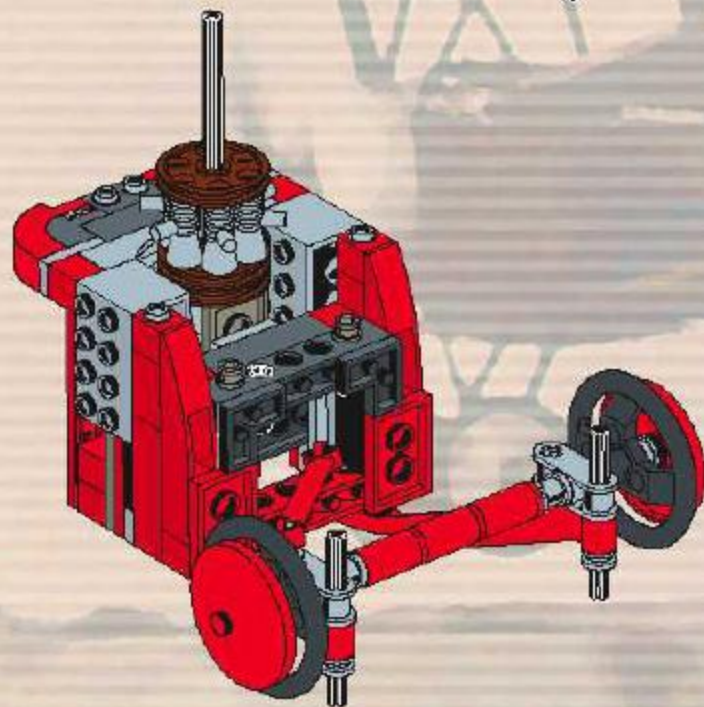

19

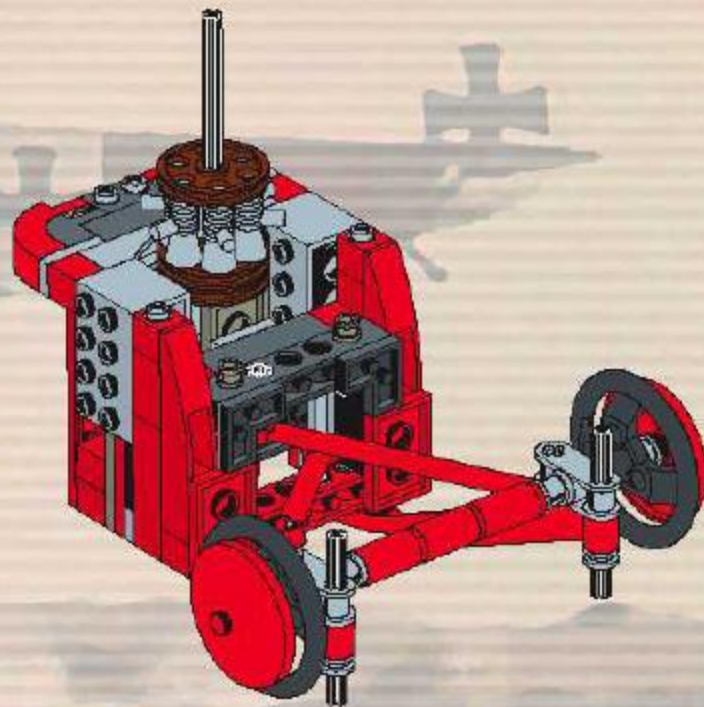

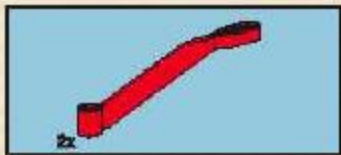

20

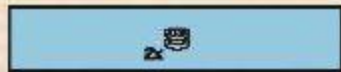
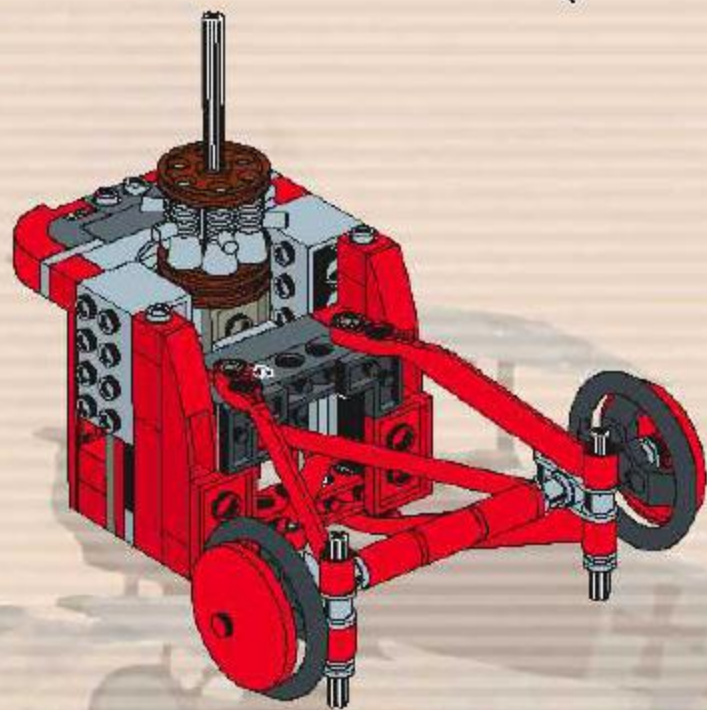

21

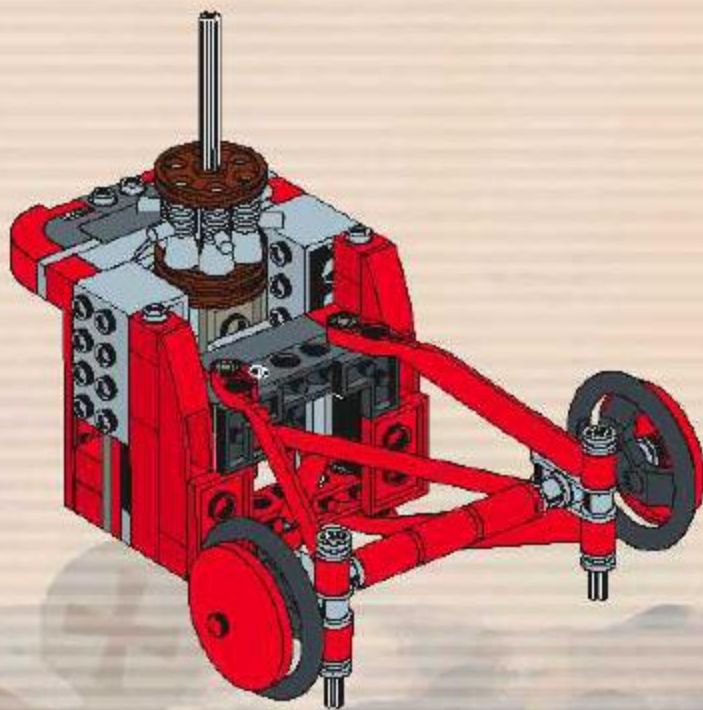



15x



22

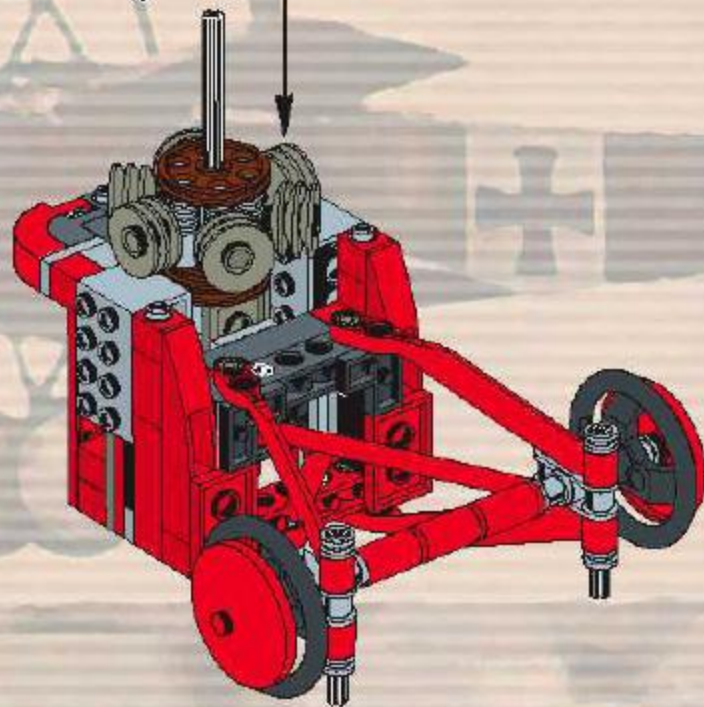
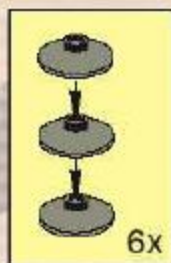

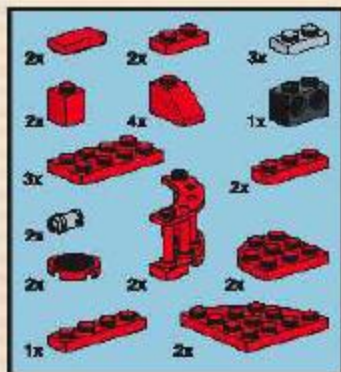

# 23

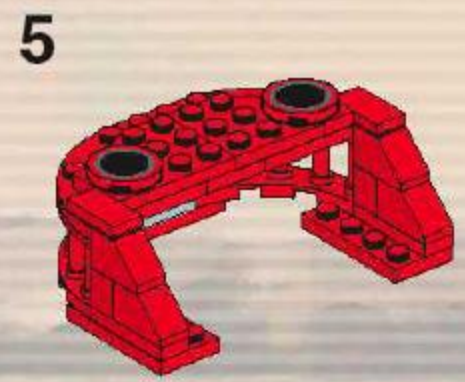
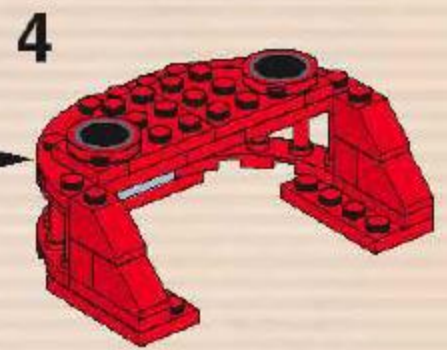
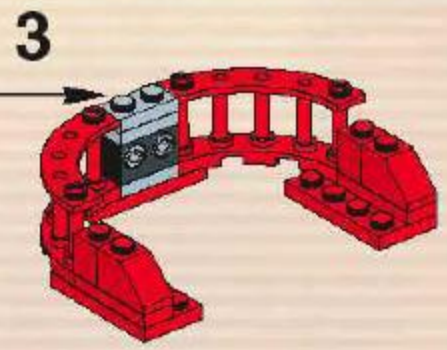
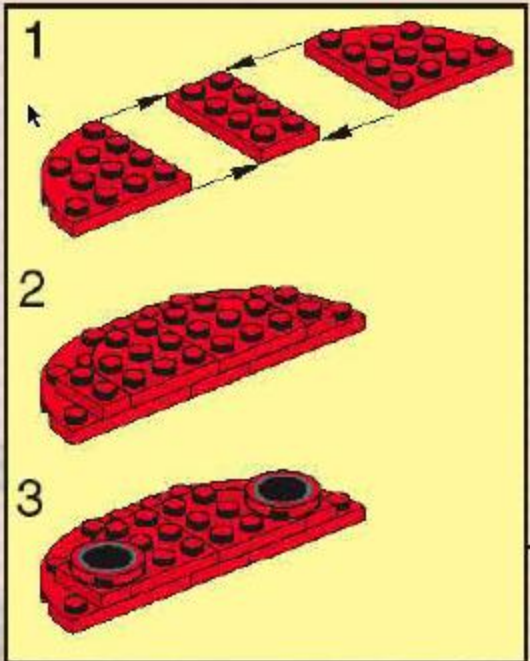
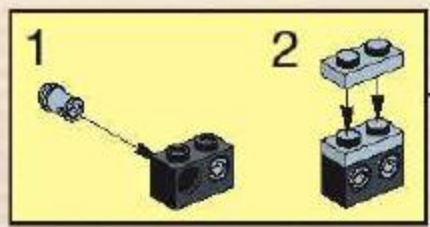



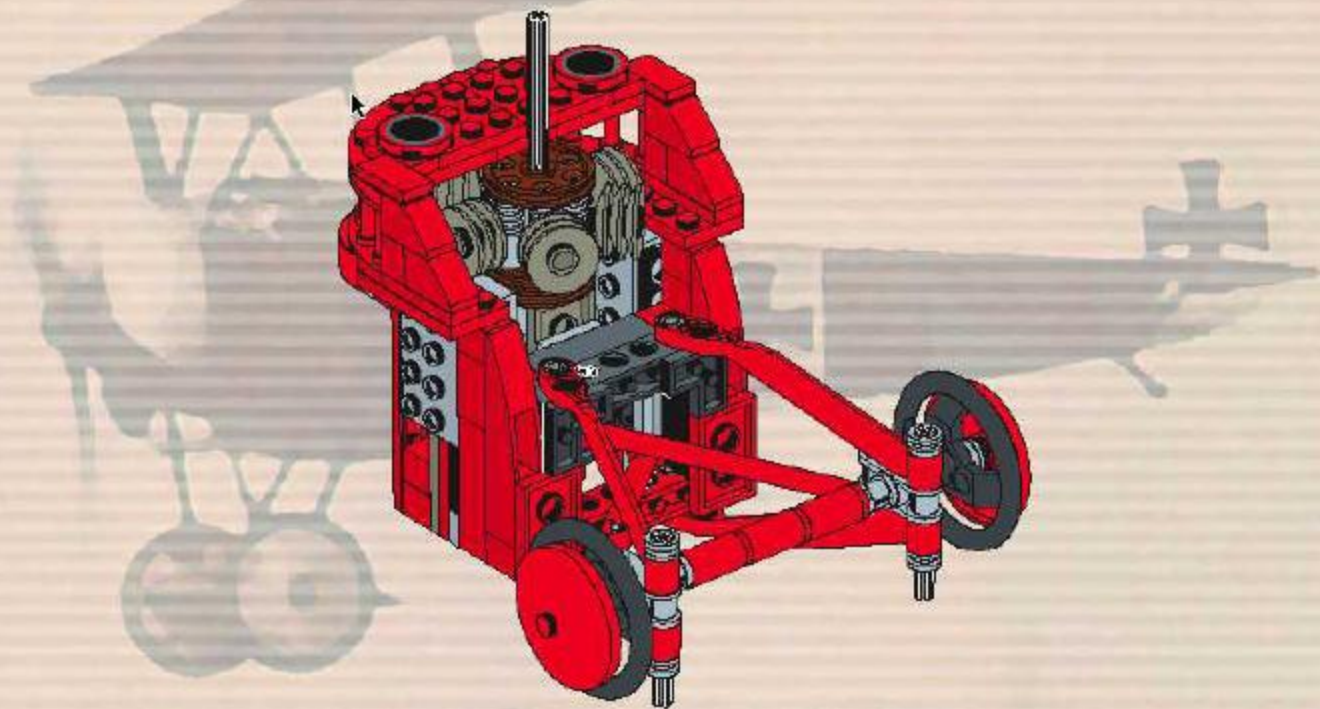

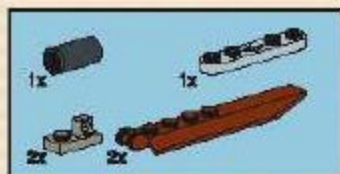

24

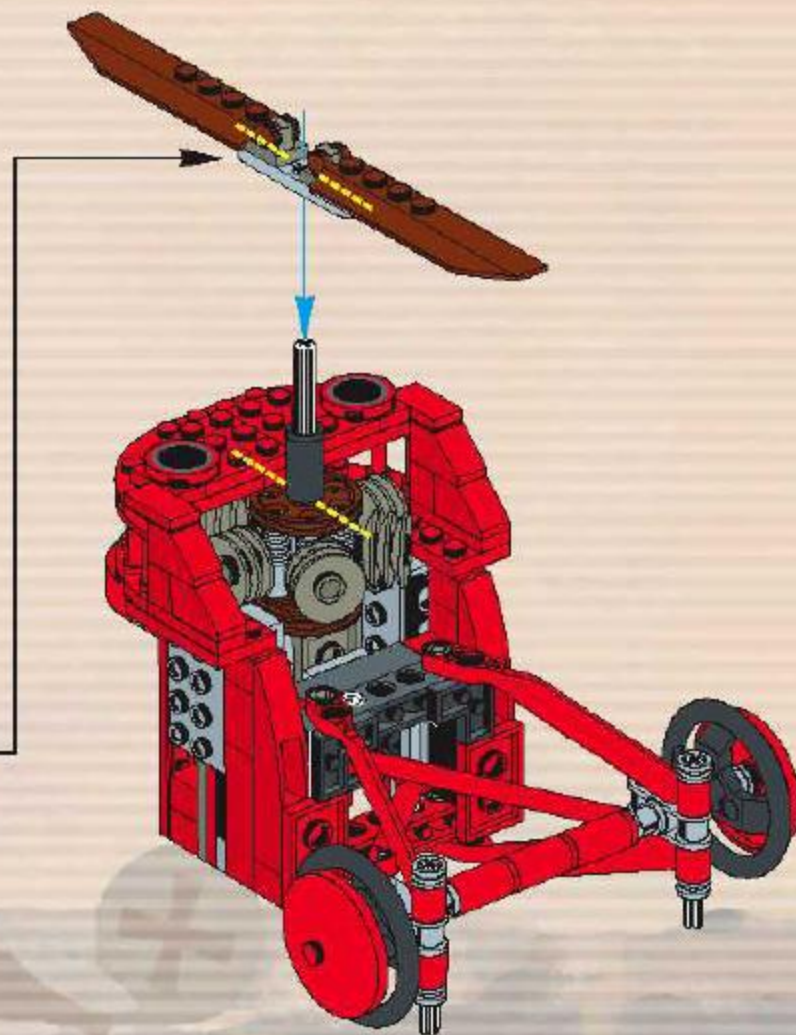
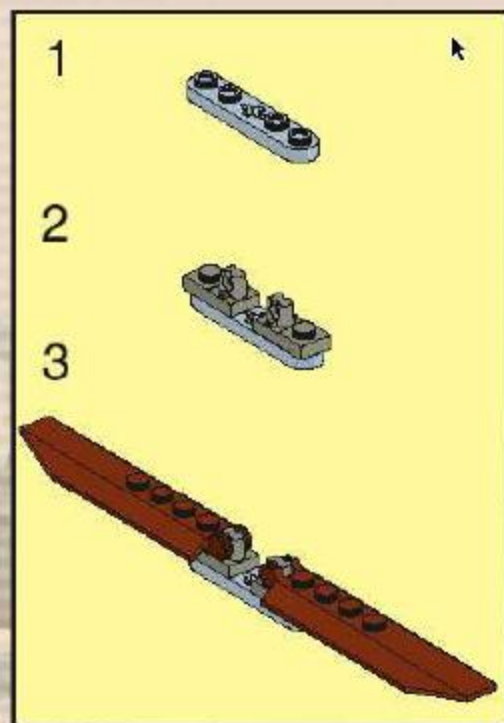





25

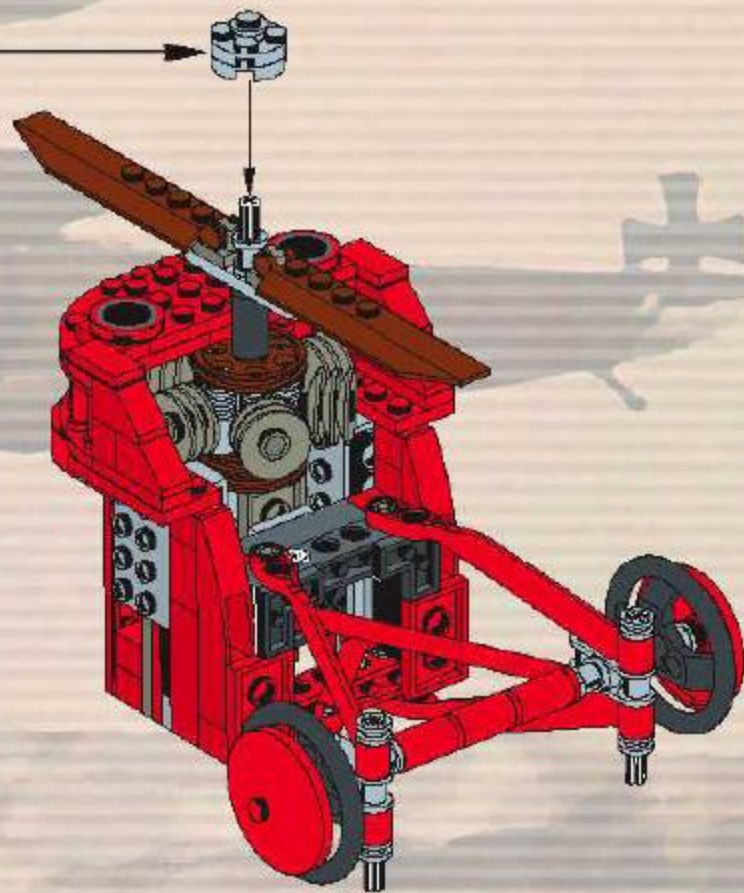
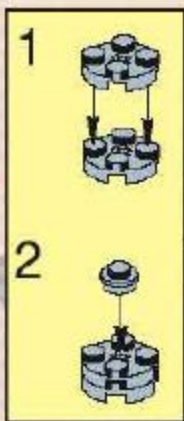

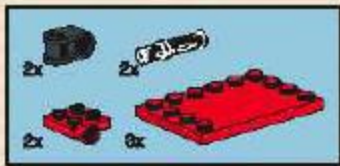

26

1



2

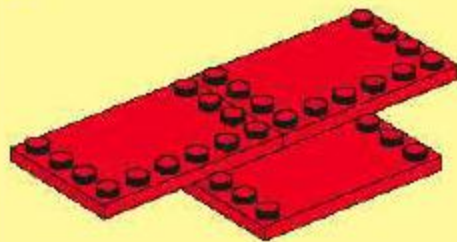

3

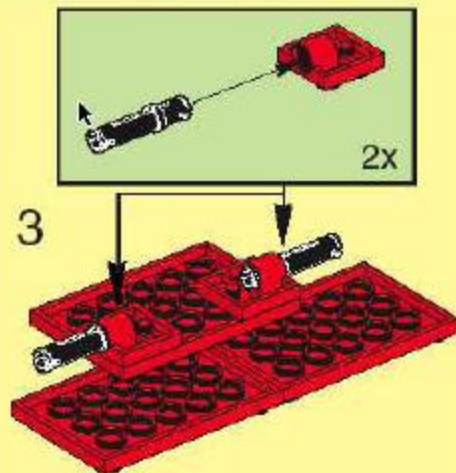

4

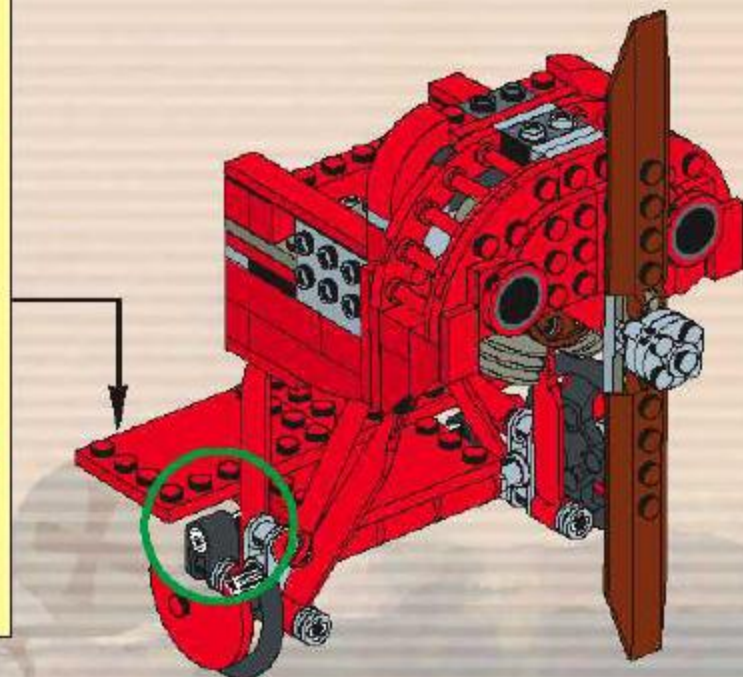
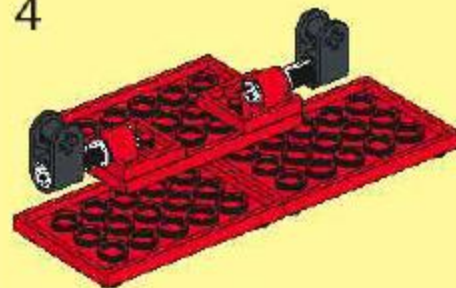



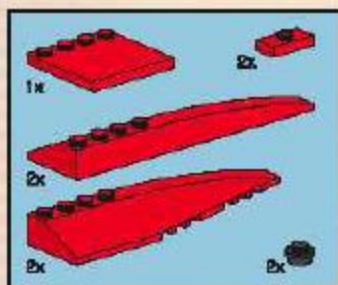

27

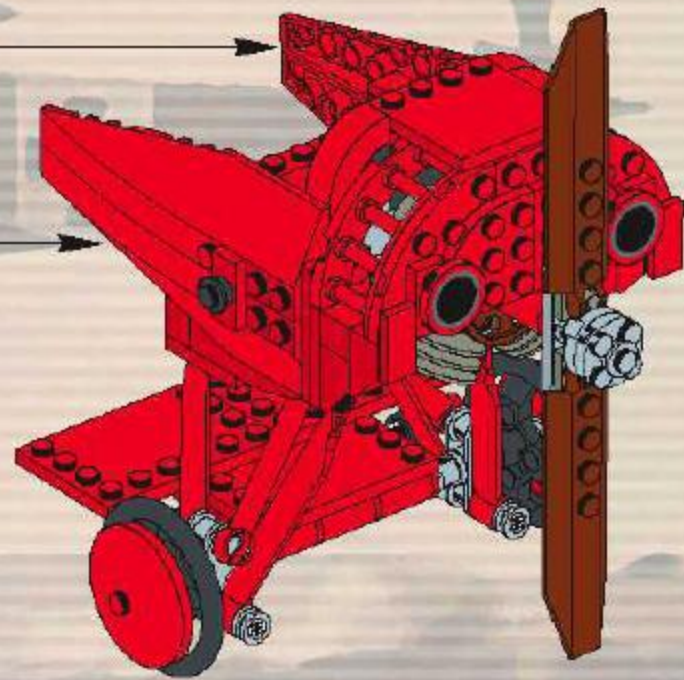
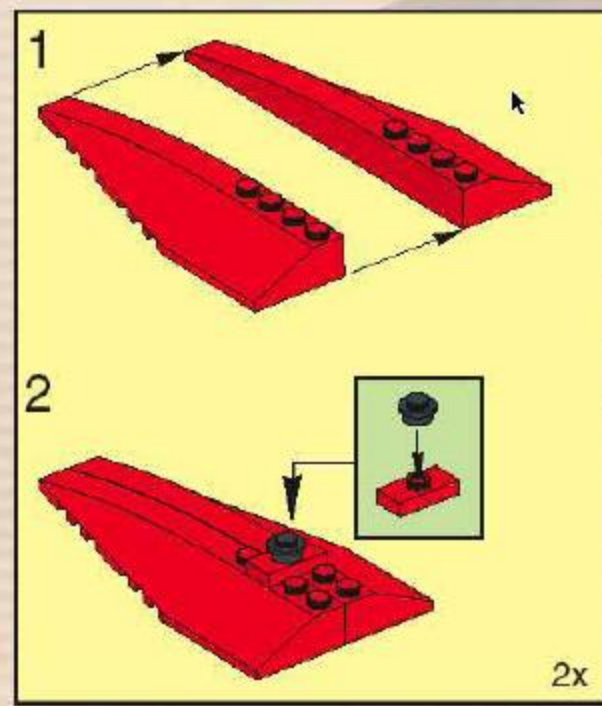

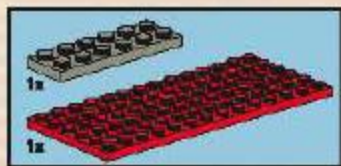
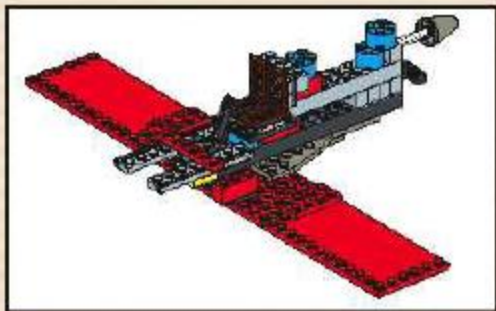

1

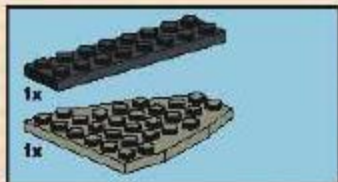

2

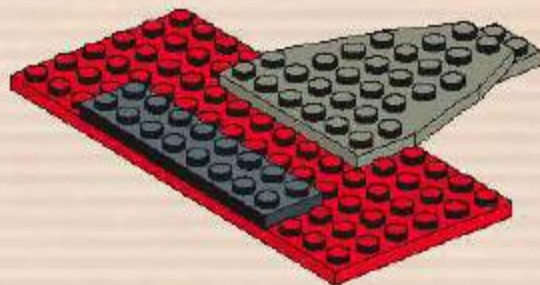

3

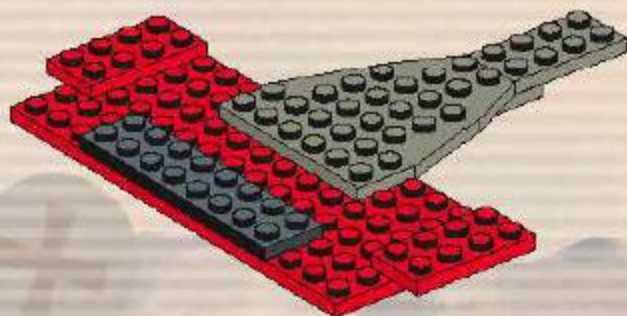



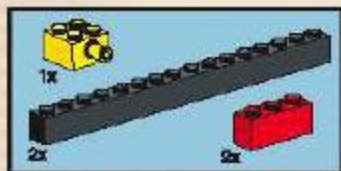

4

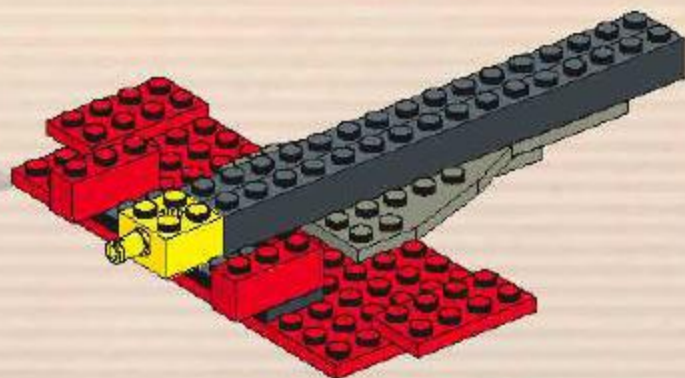

5

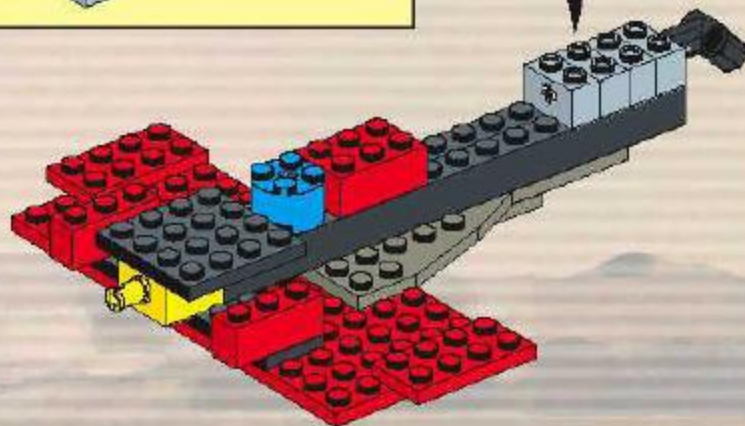
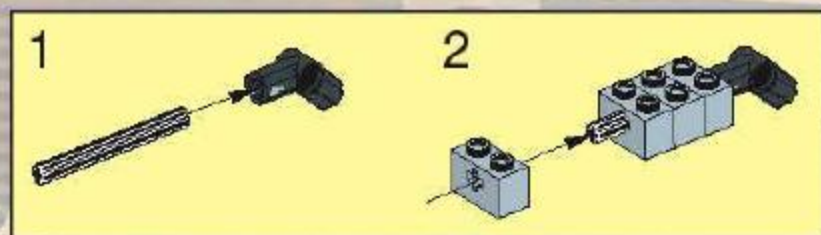

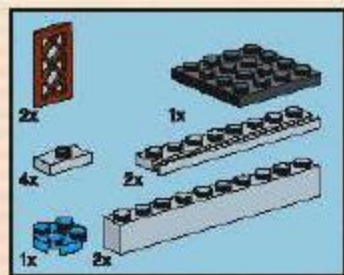

6

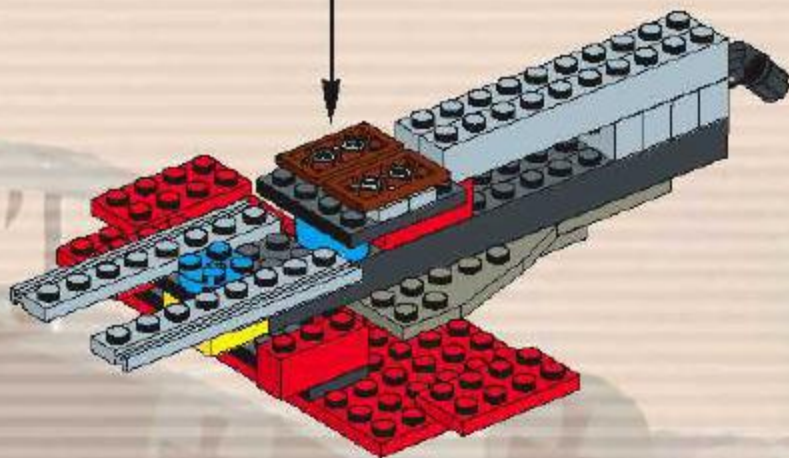



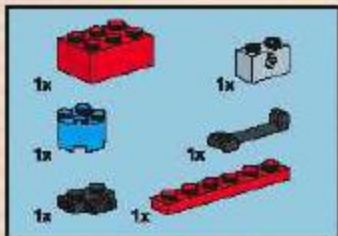

7

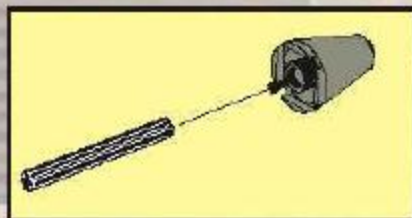
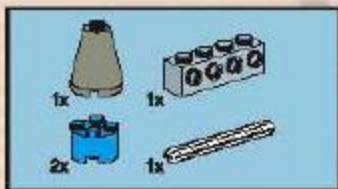
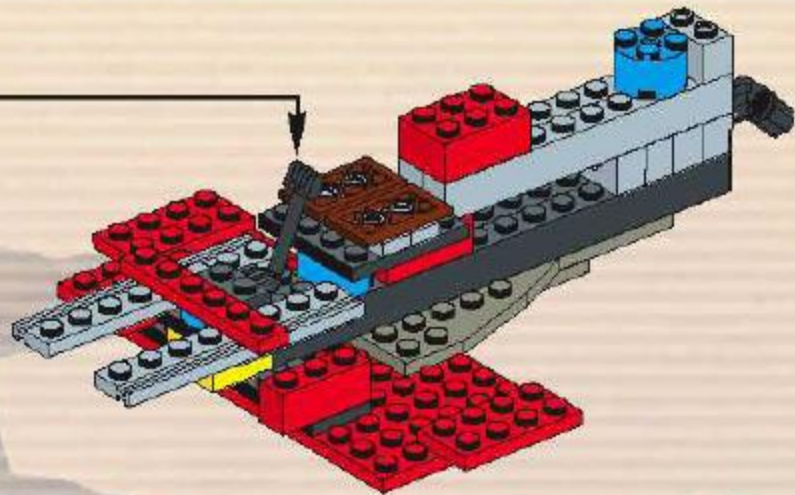

8

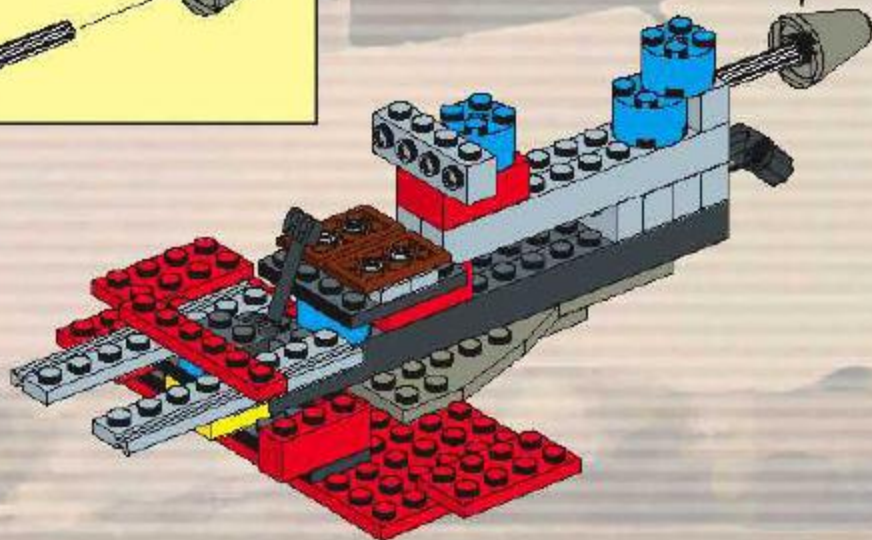

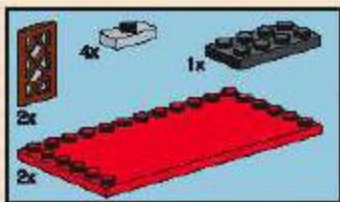

9

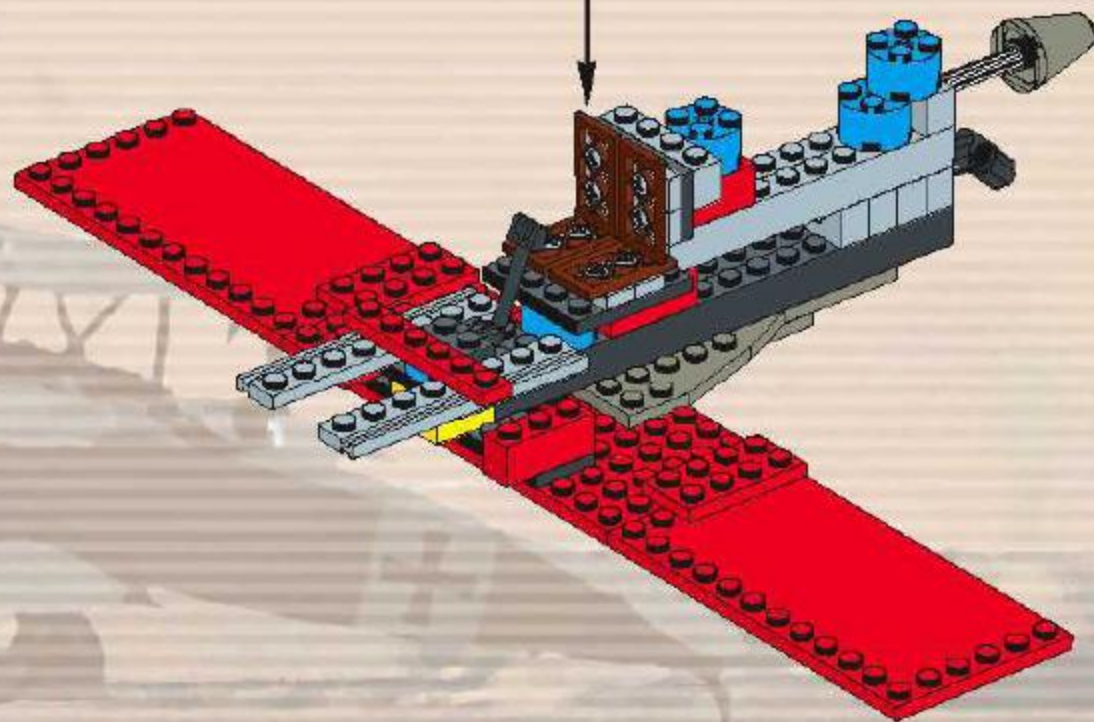
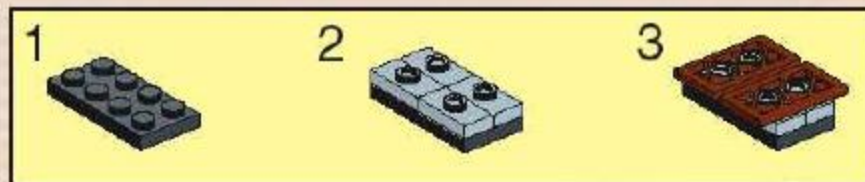



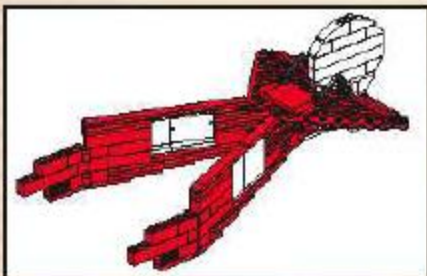

10



1



2

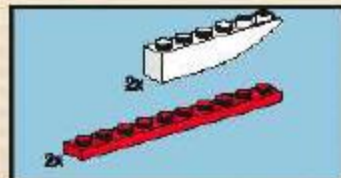
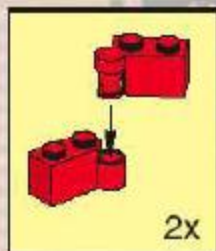

3

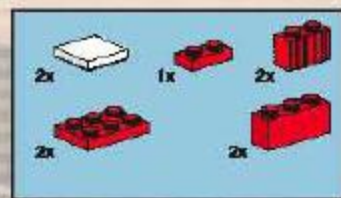
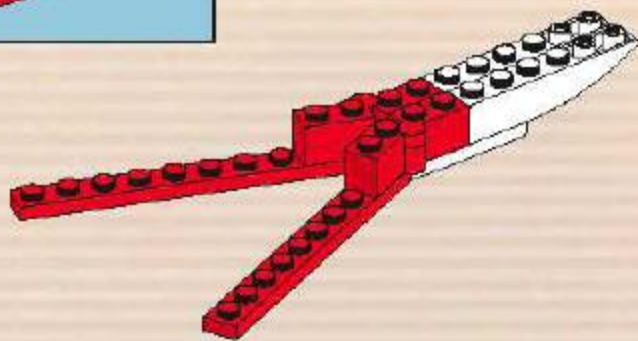

4

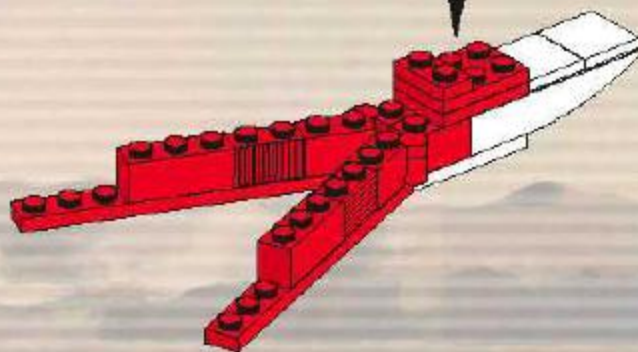
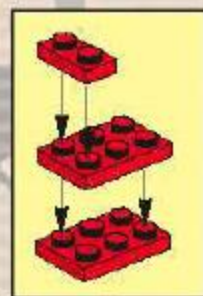

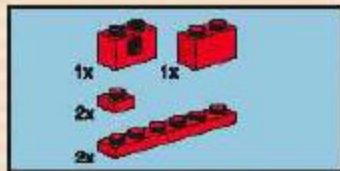

5

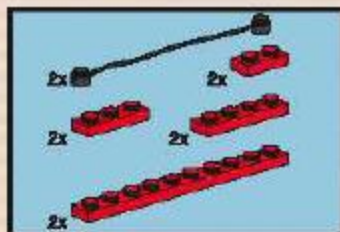
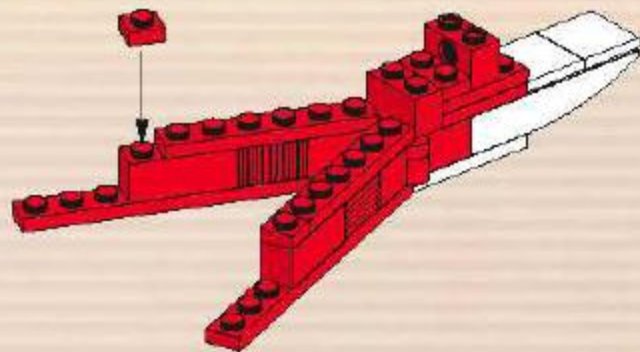

6

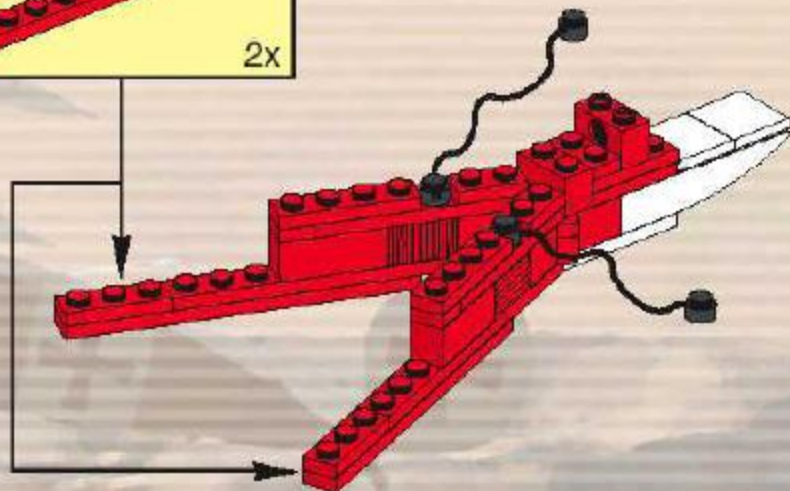
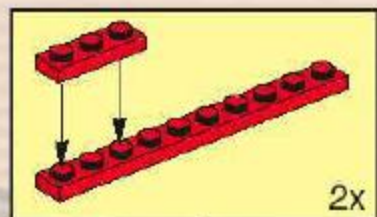



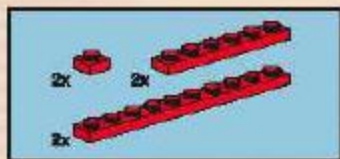

7

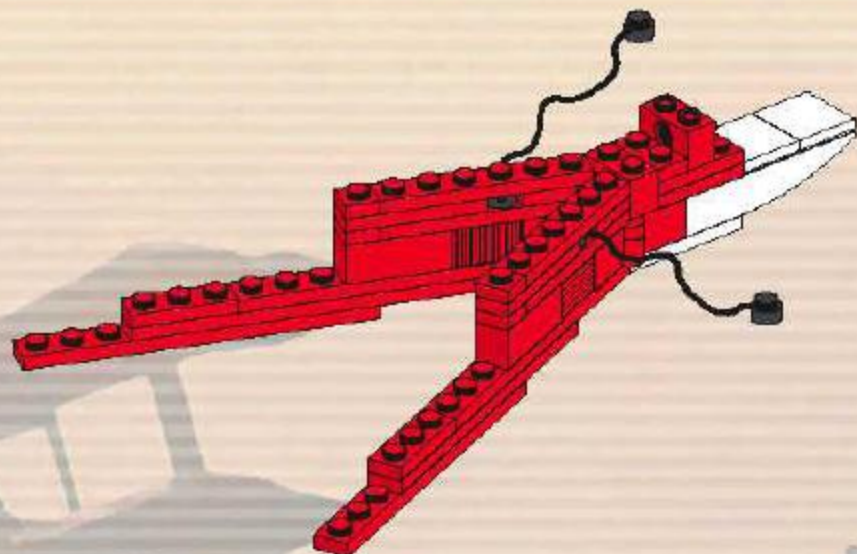

8

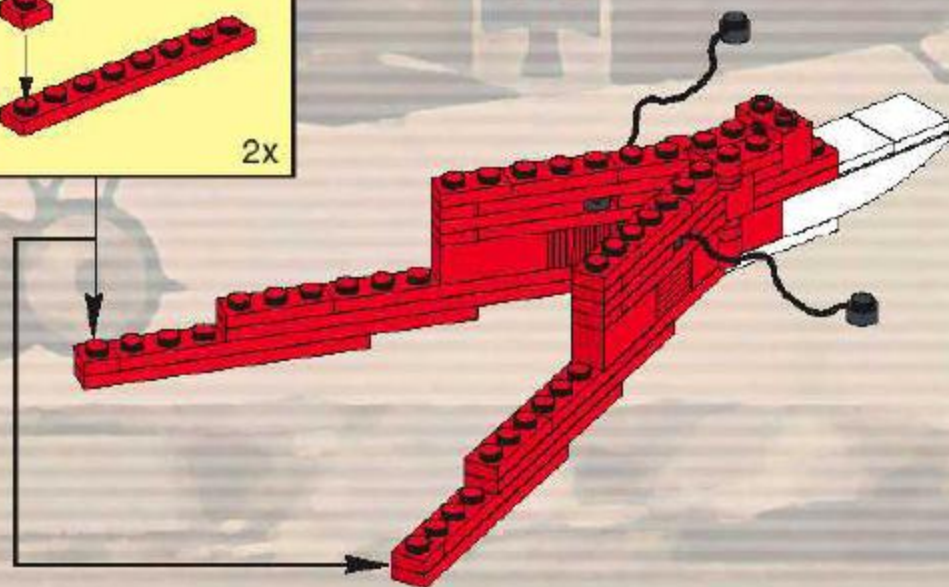
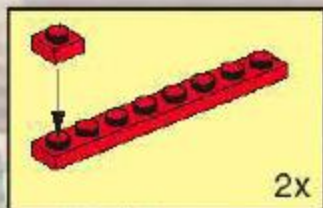

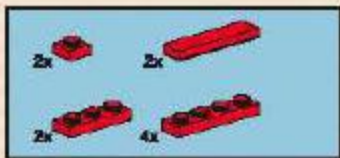

9

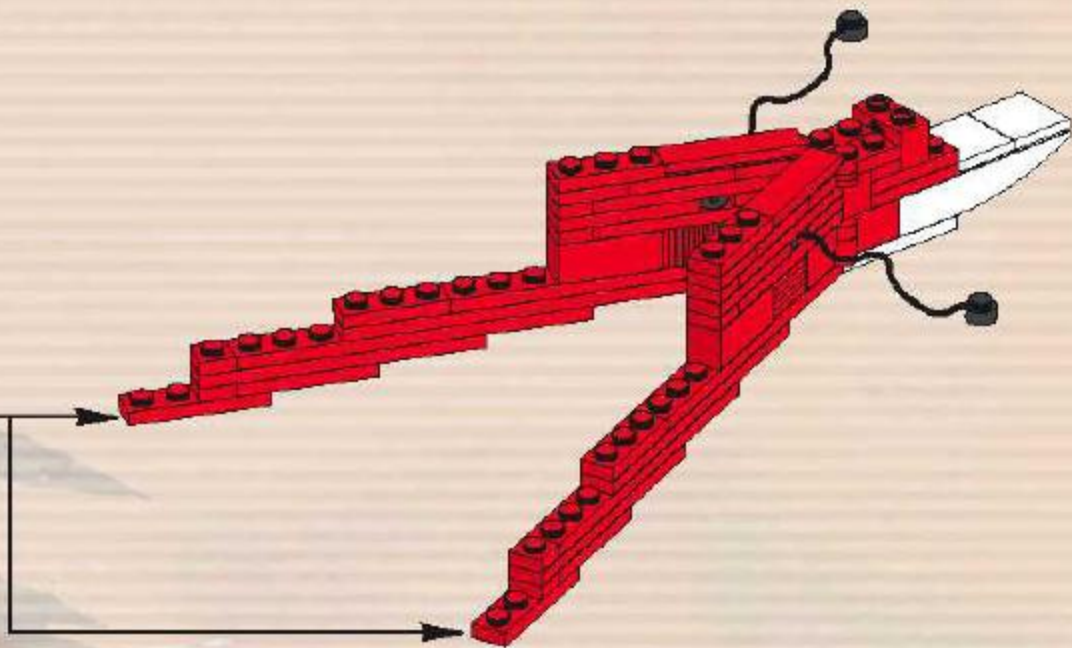
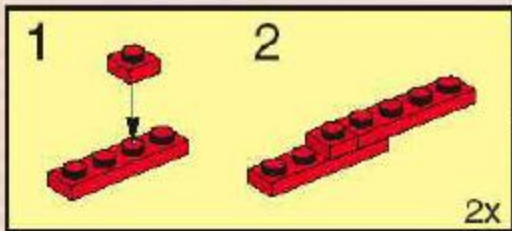



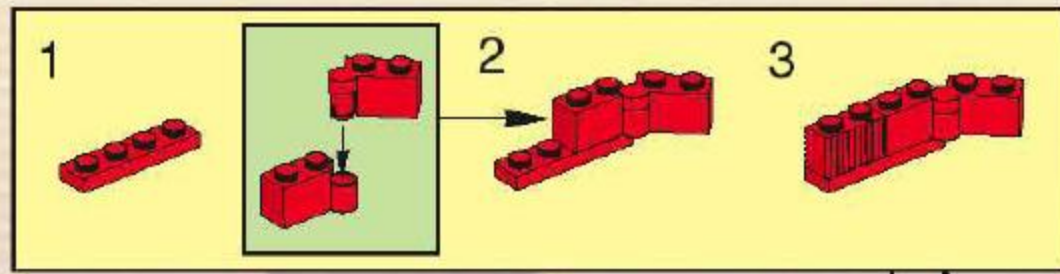
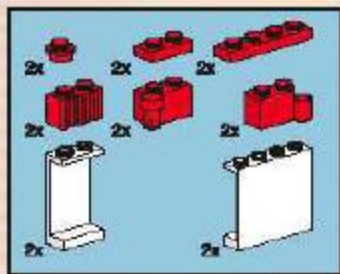

10

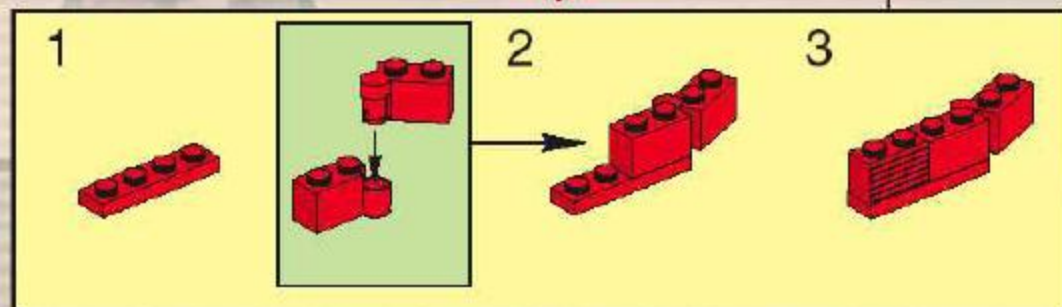
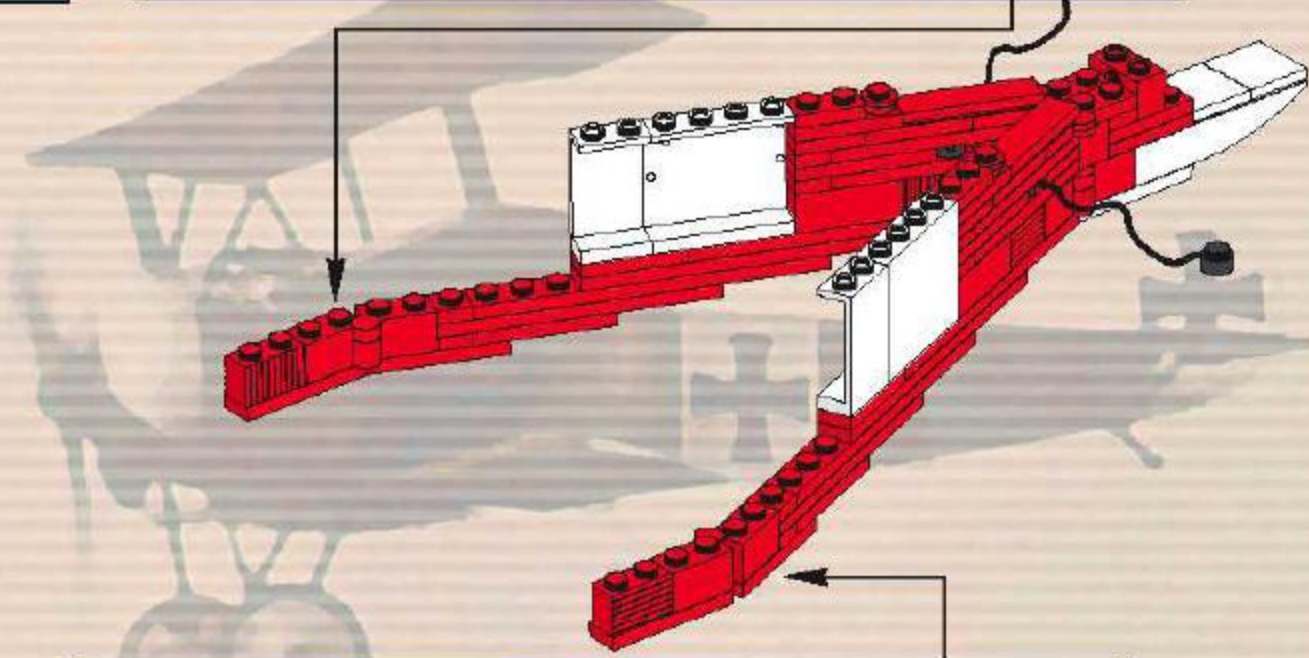

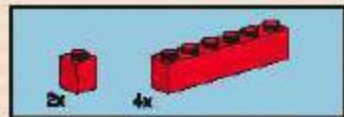

11

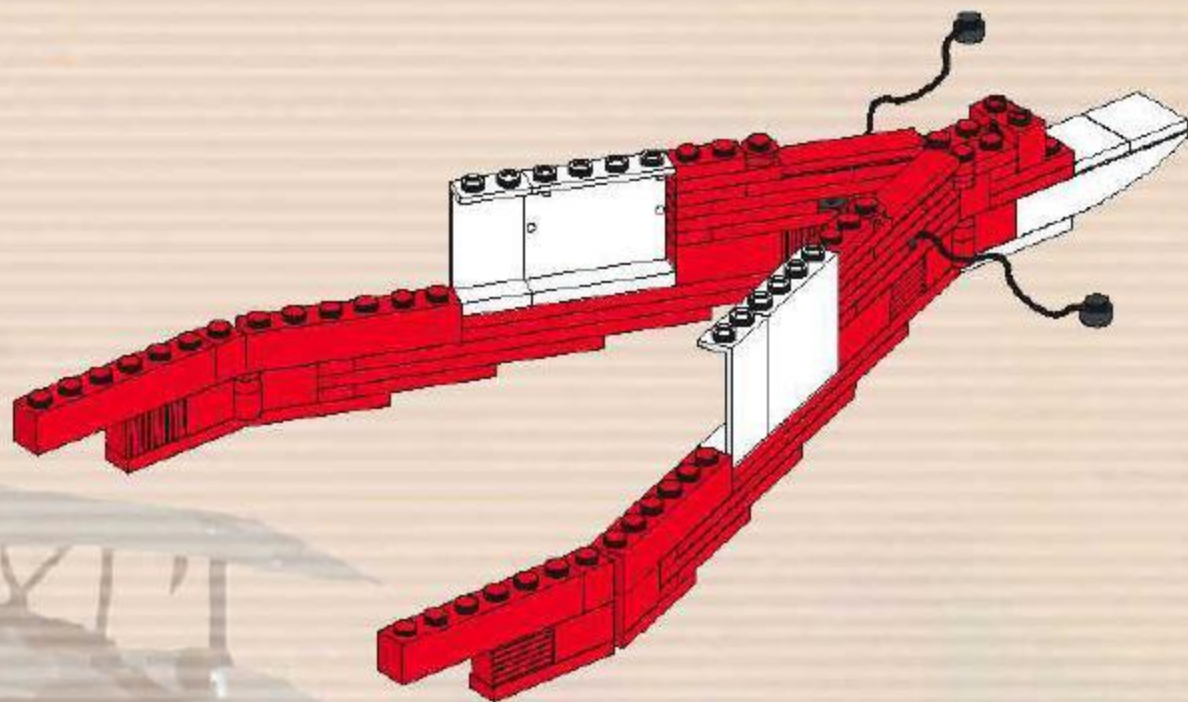



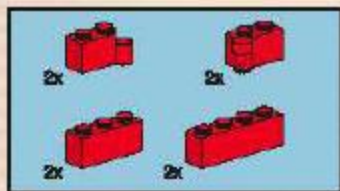

12

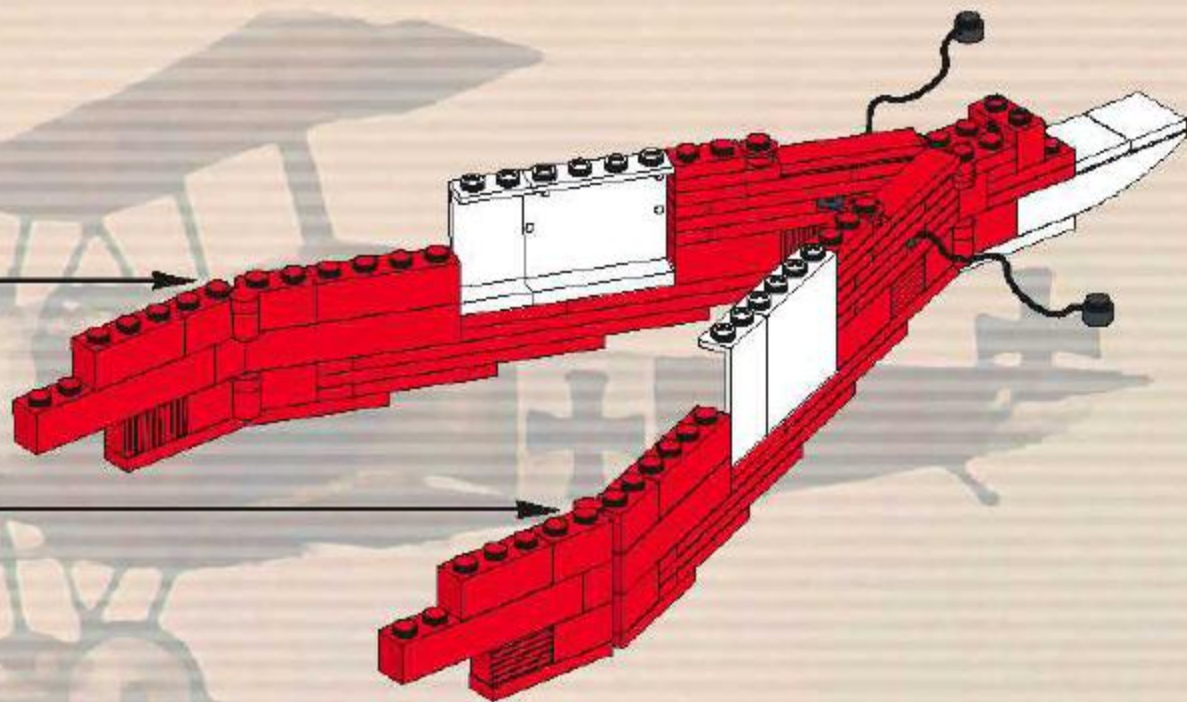
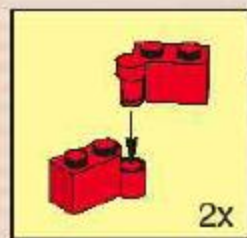

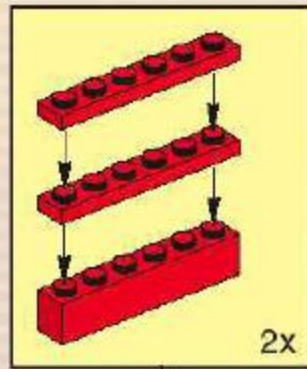
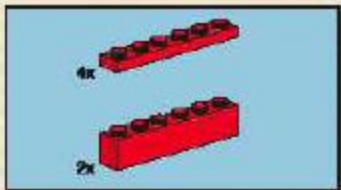

13

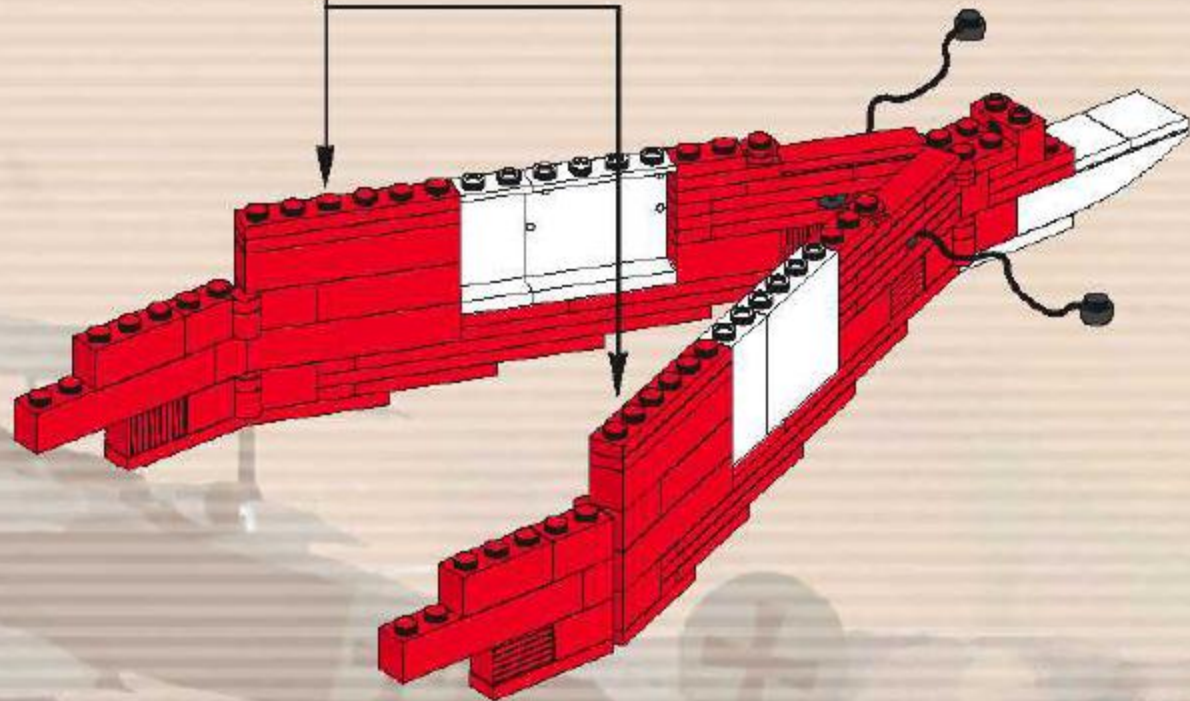





14

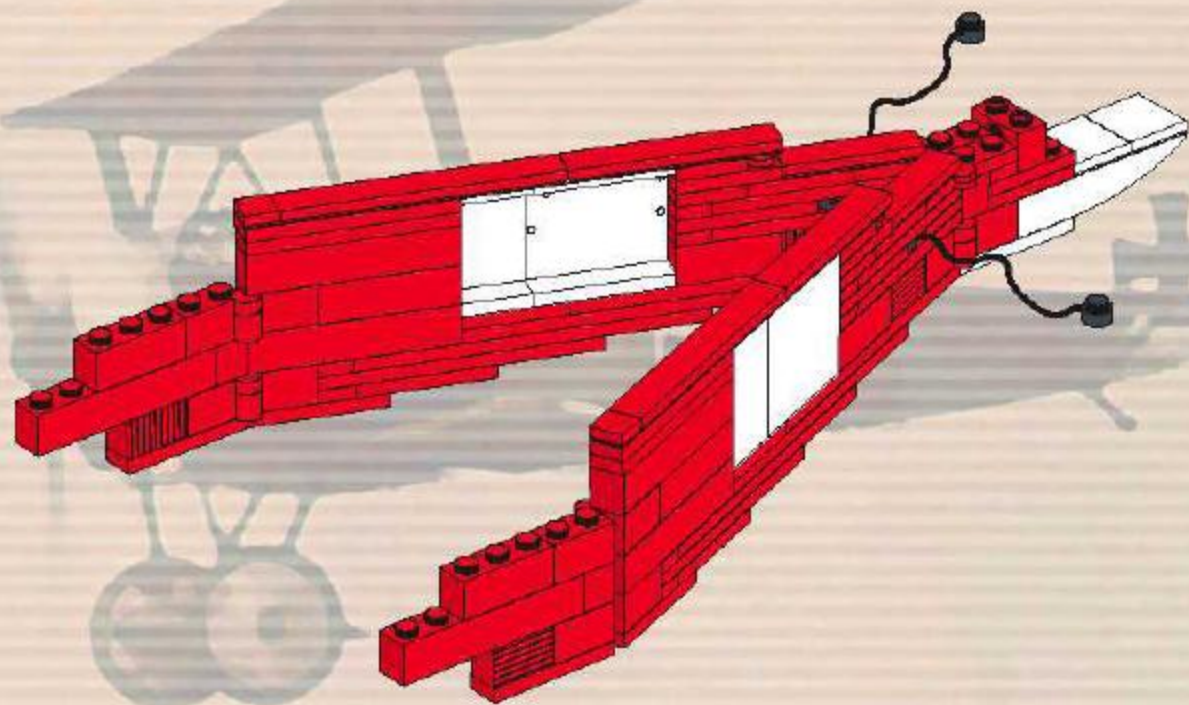

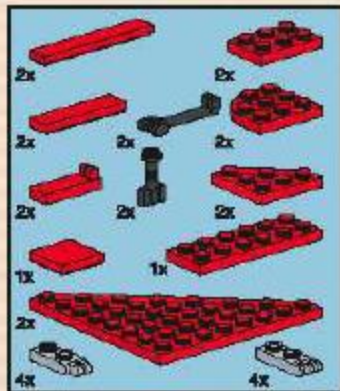

15

1

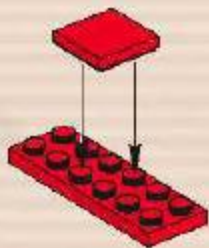

2



3

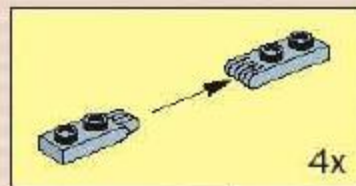
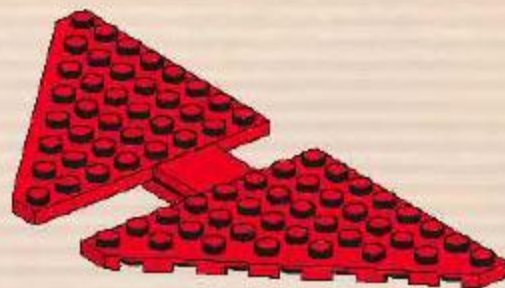

4

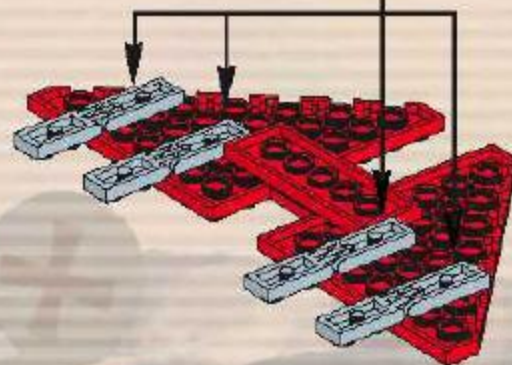



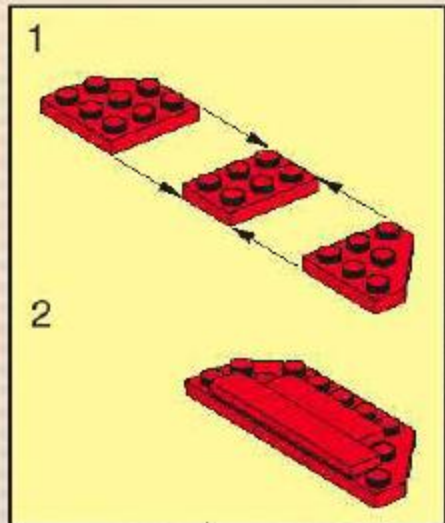

5

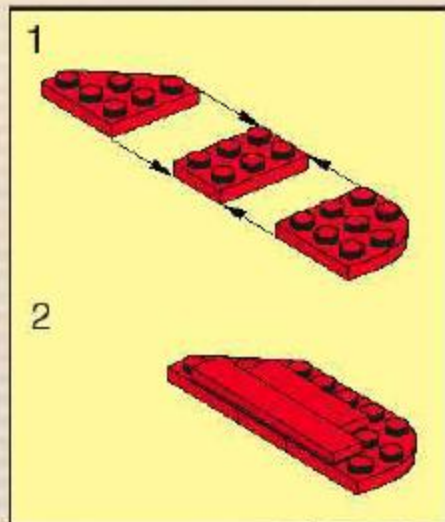

6

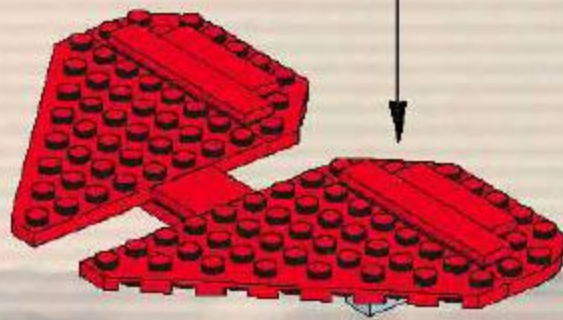

7

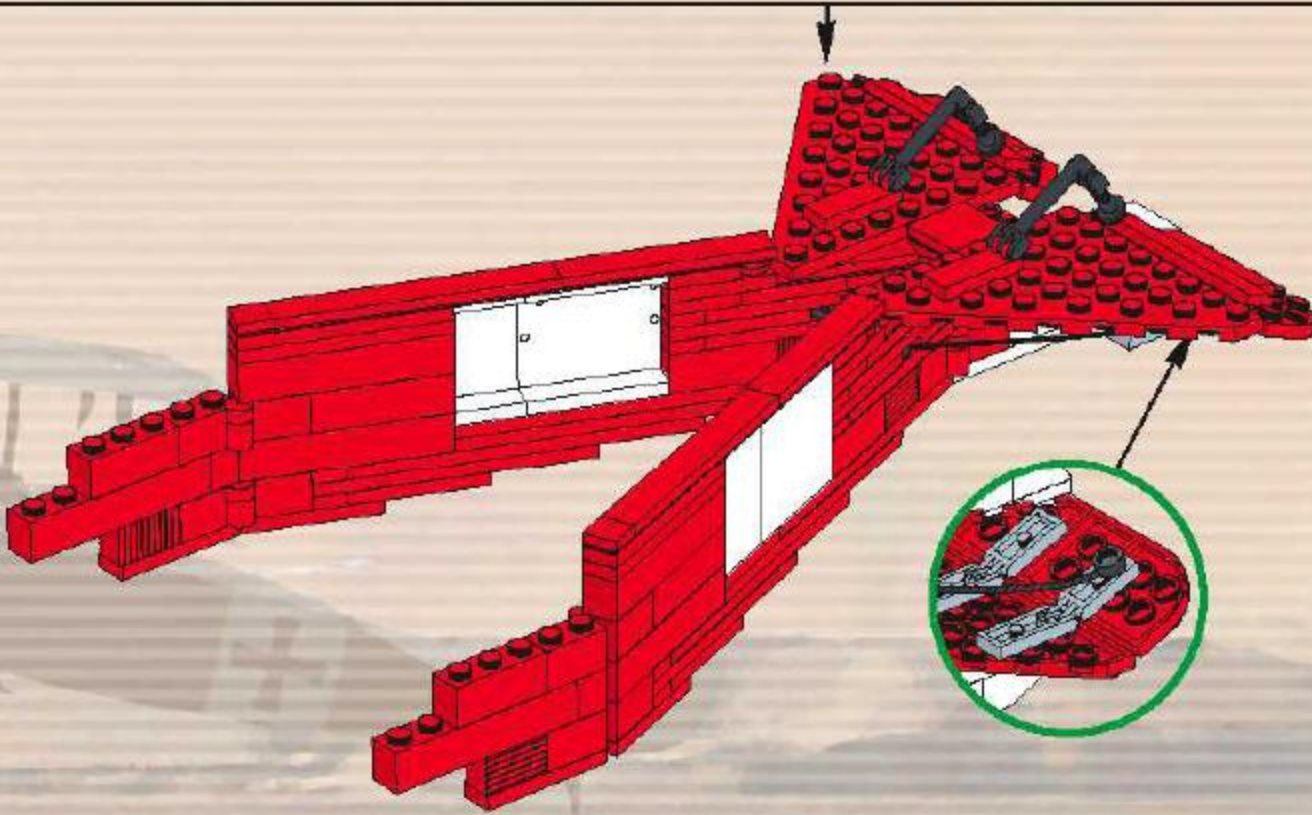
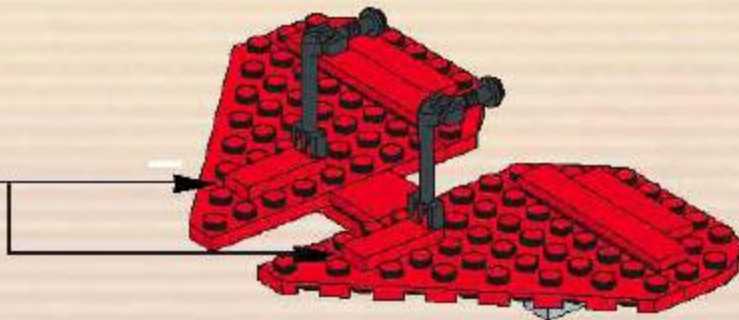
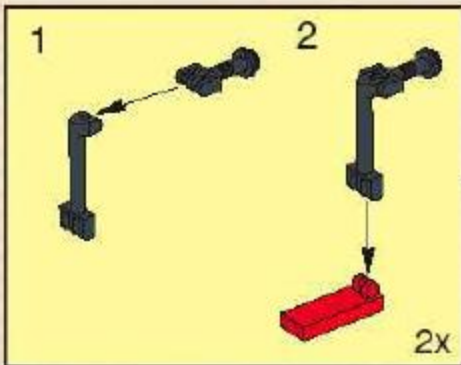





16

1

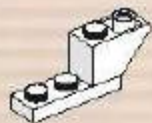

2

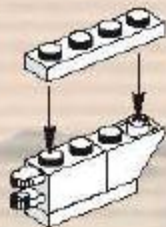

3

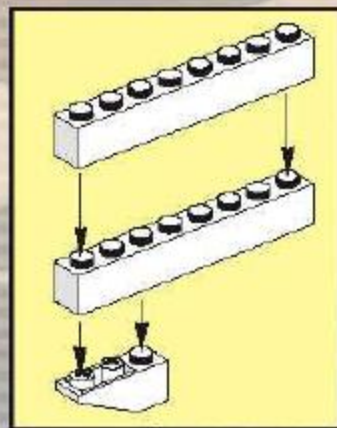
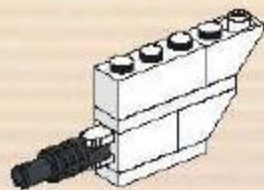

4

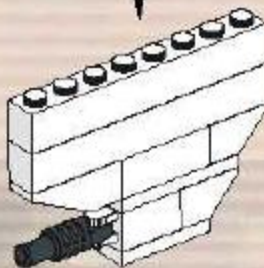

5

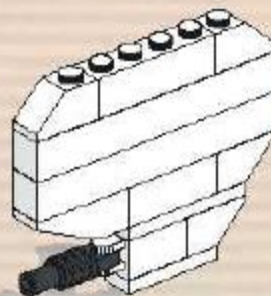

6

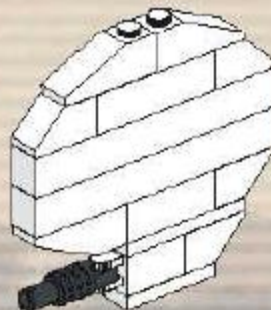

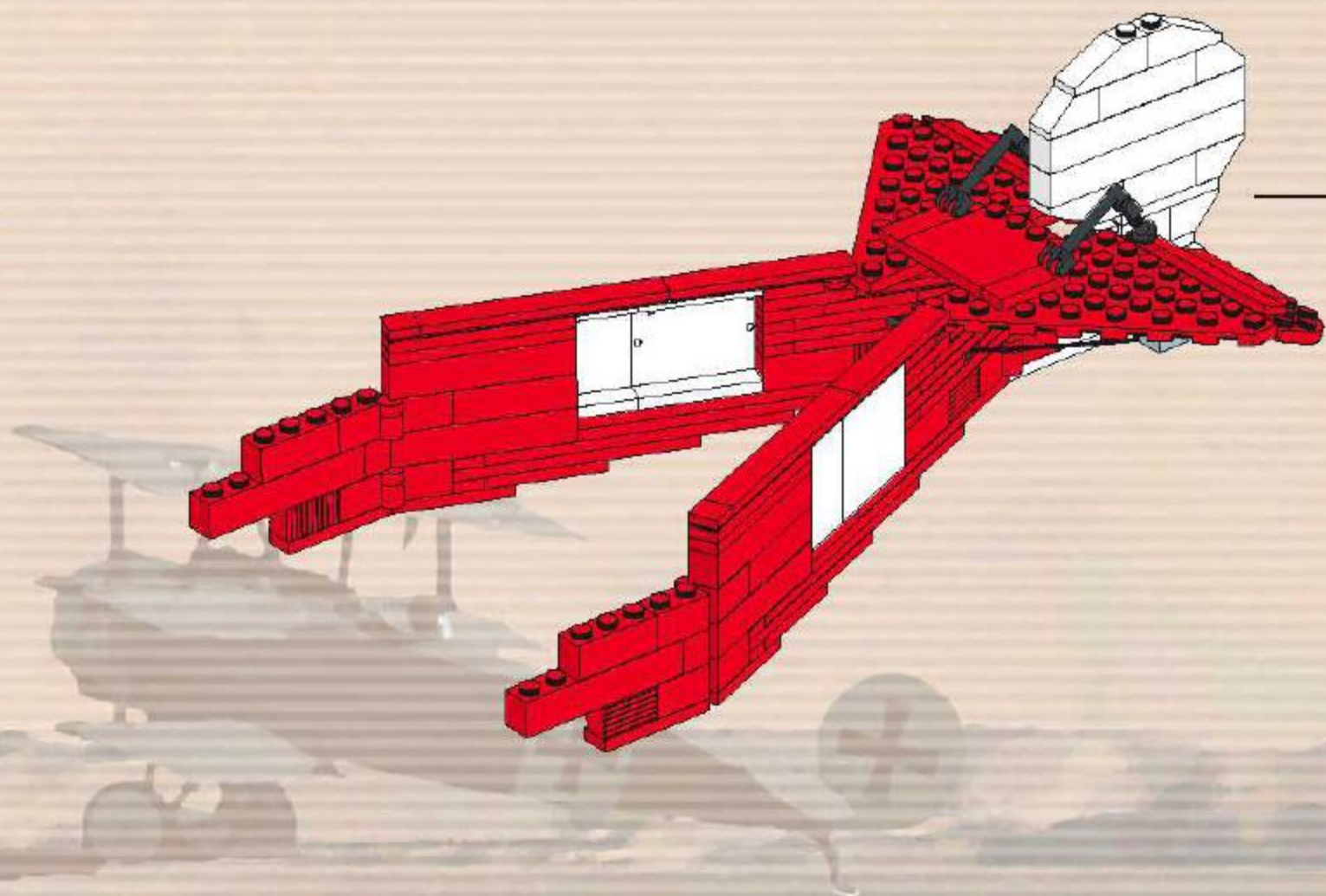



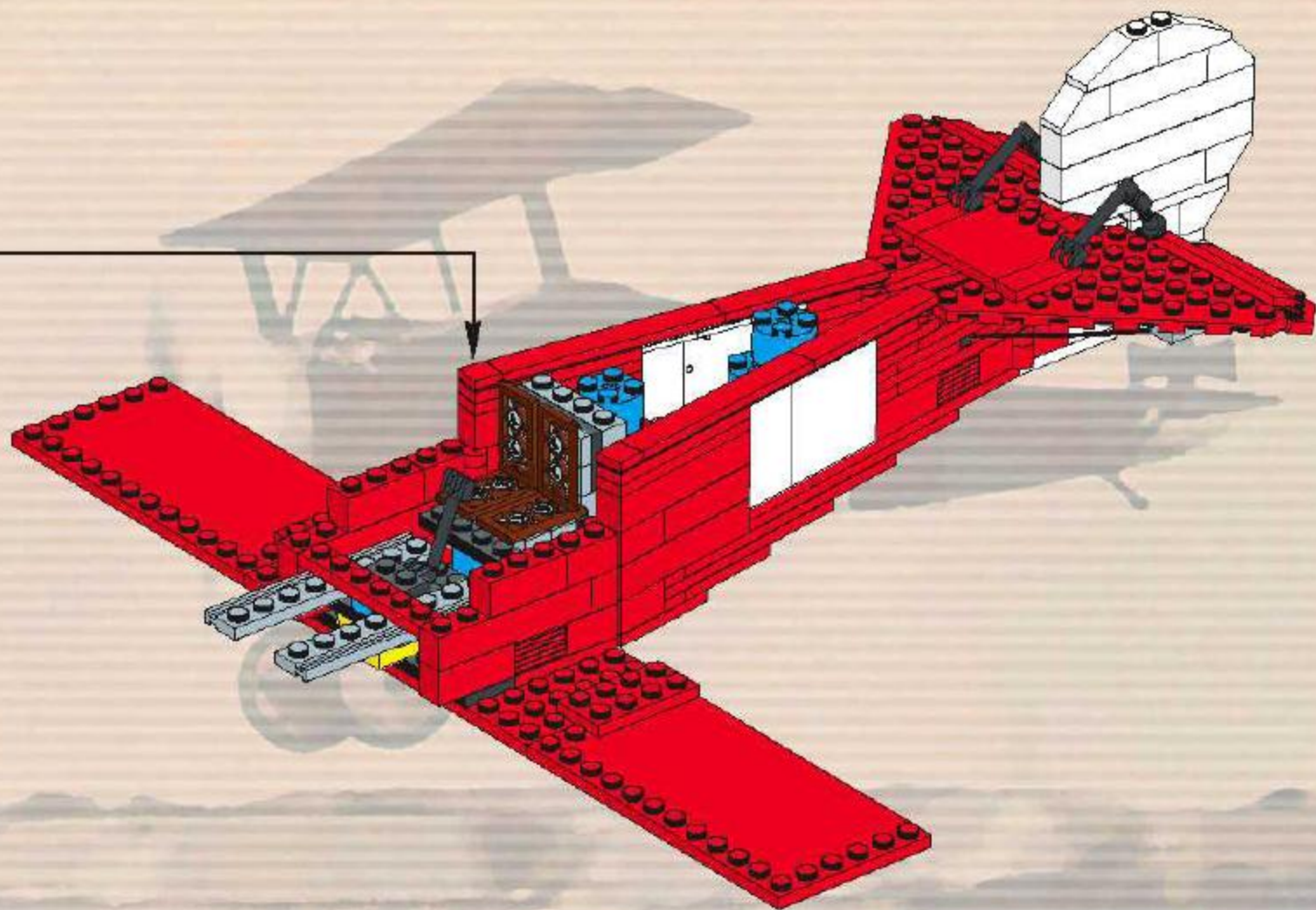



11

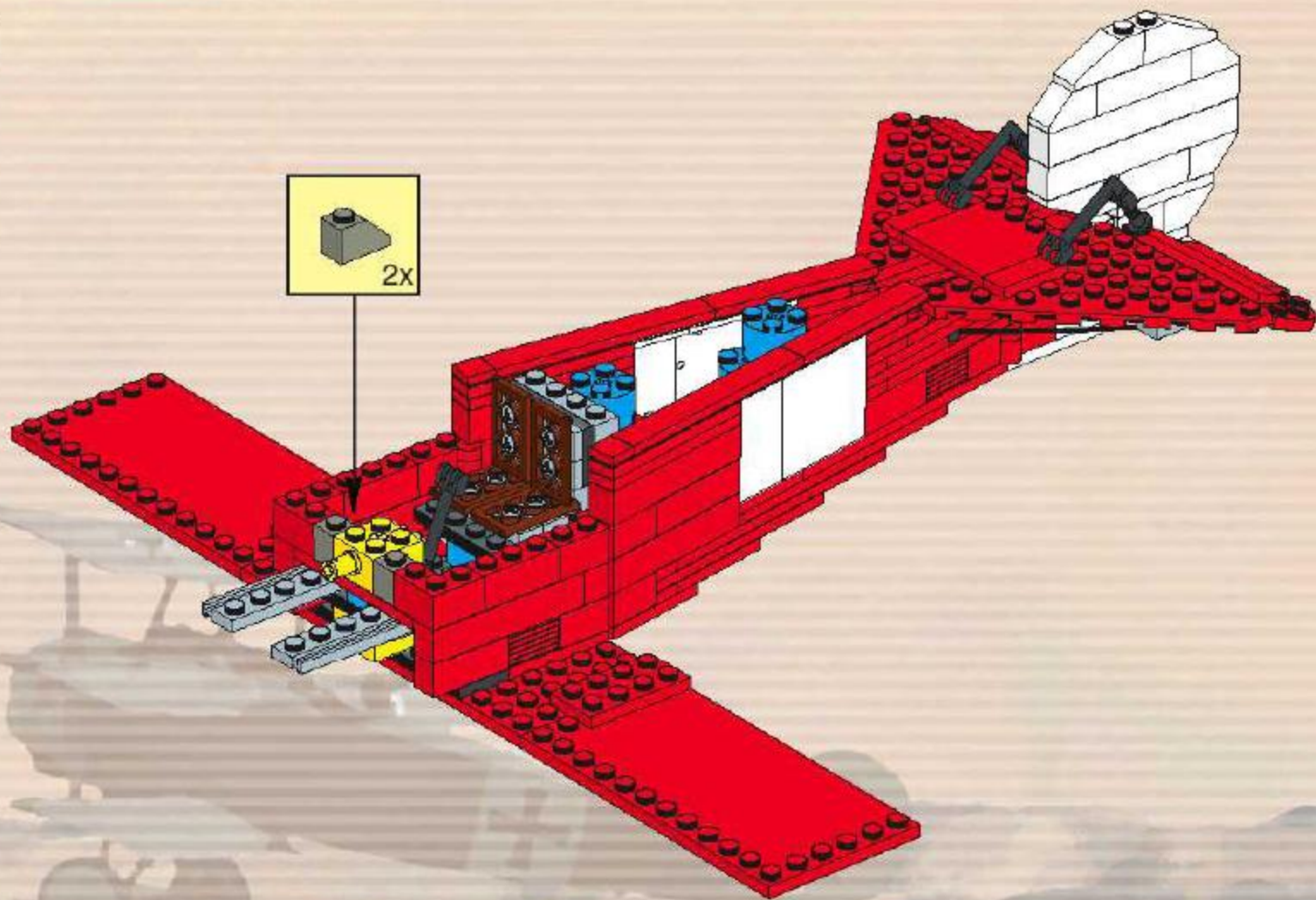



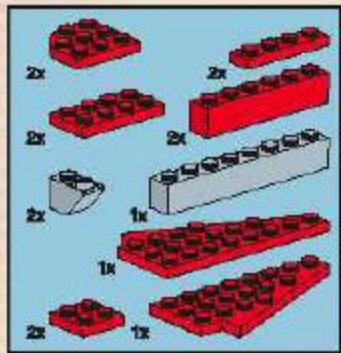

12

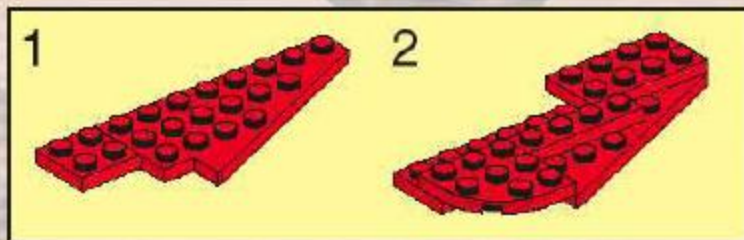
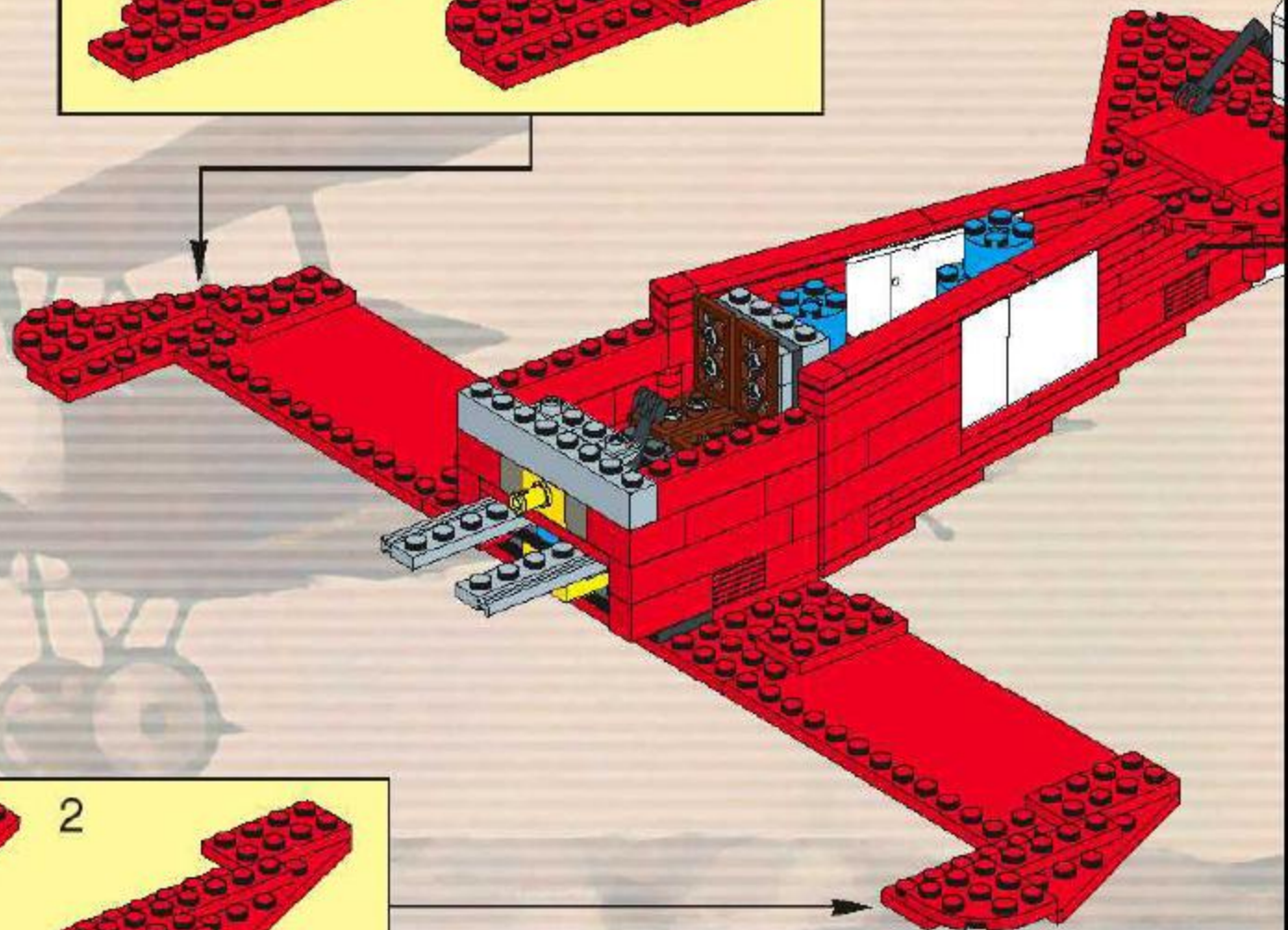
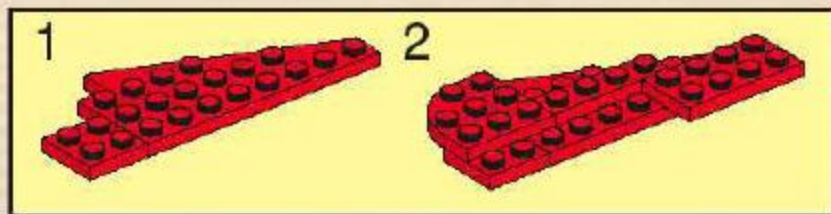

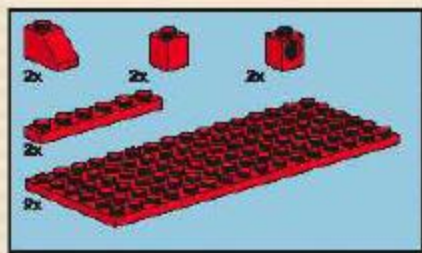

13

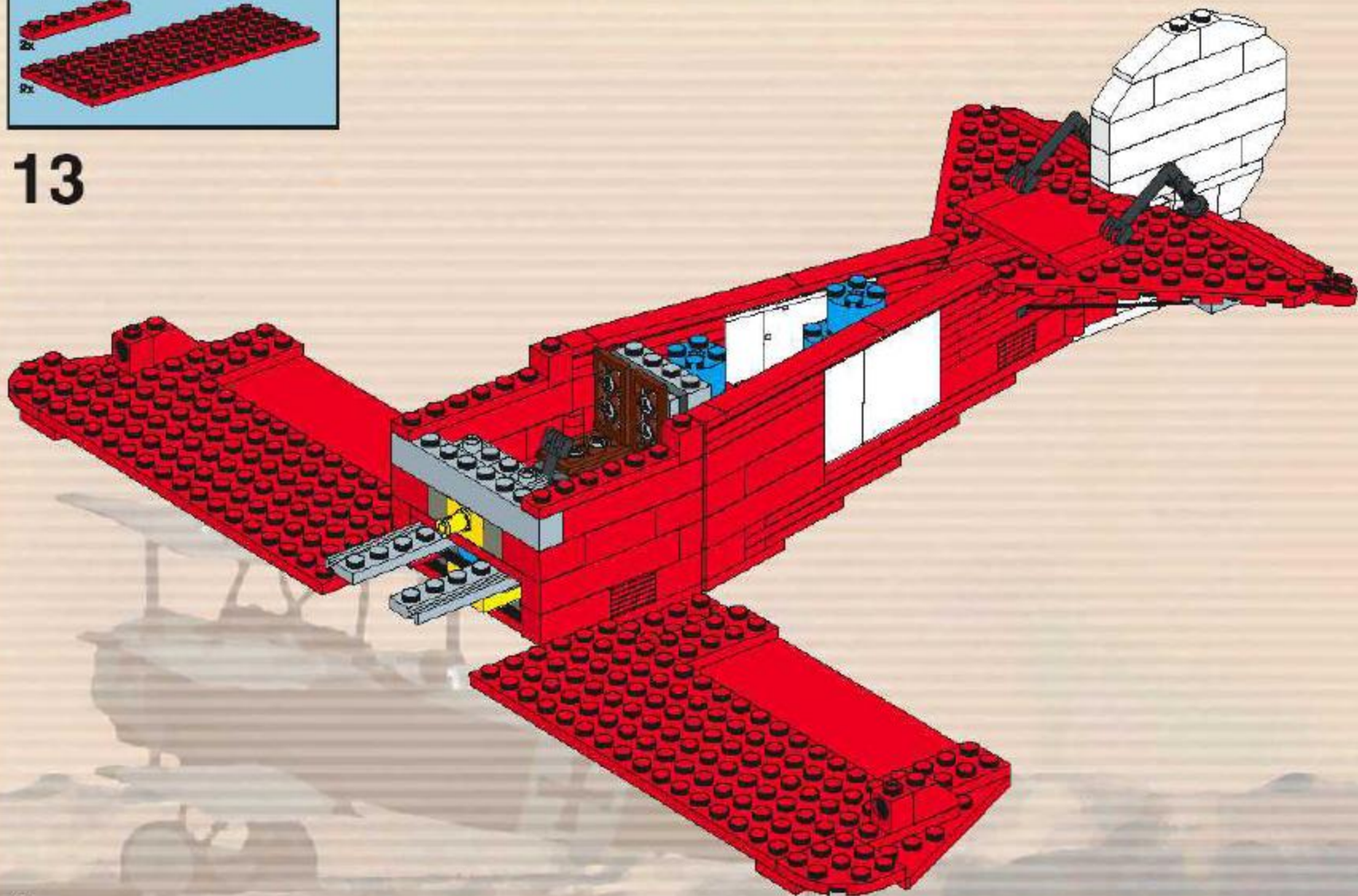



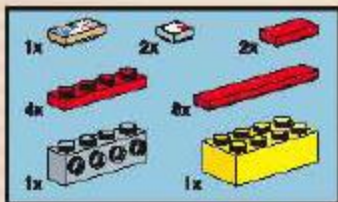

14

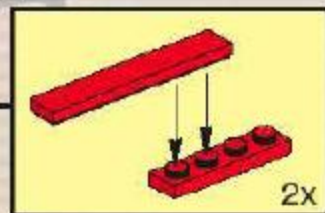
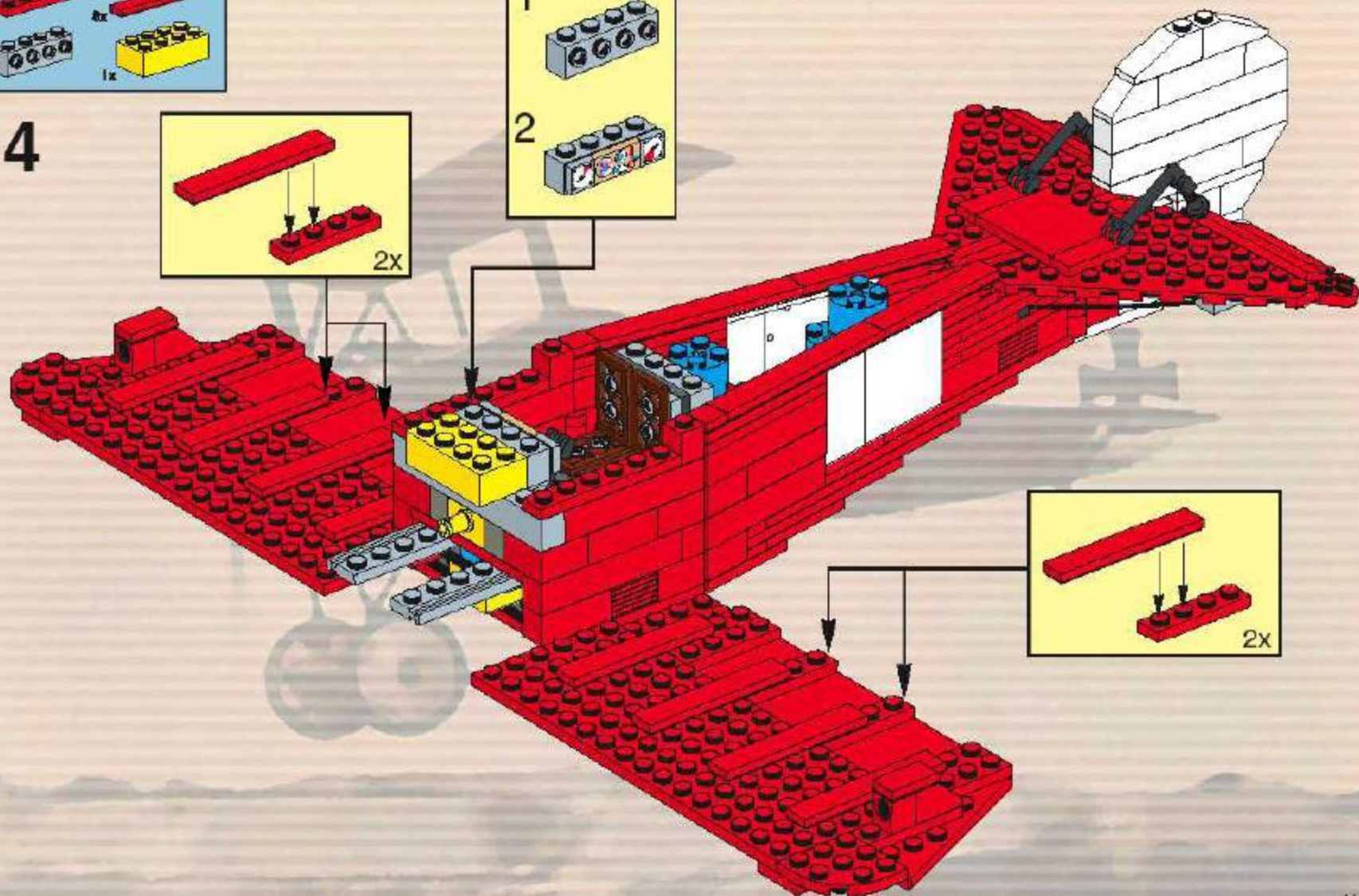
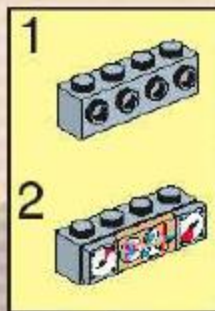
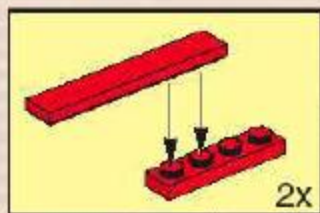

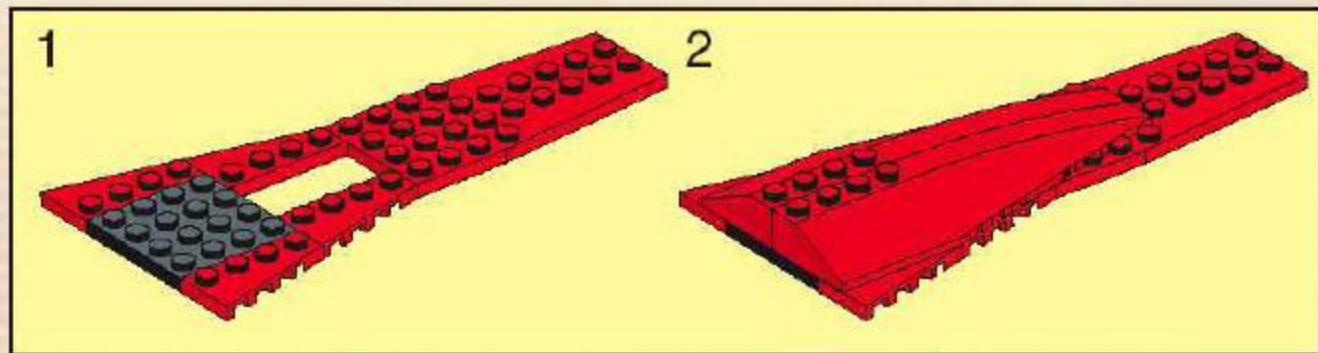
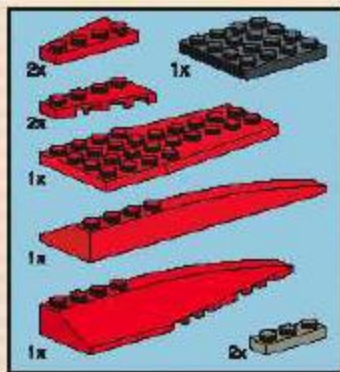

15

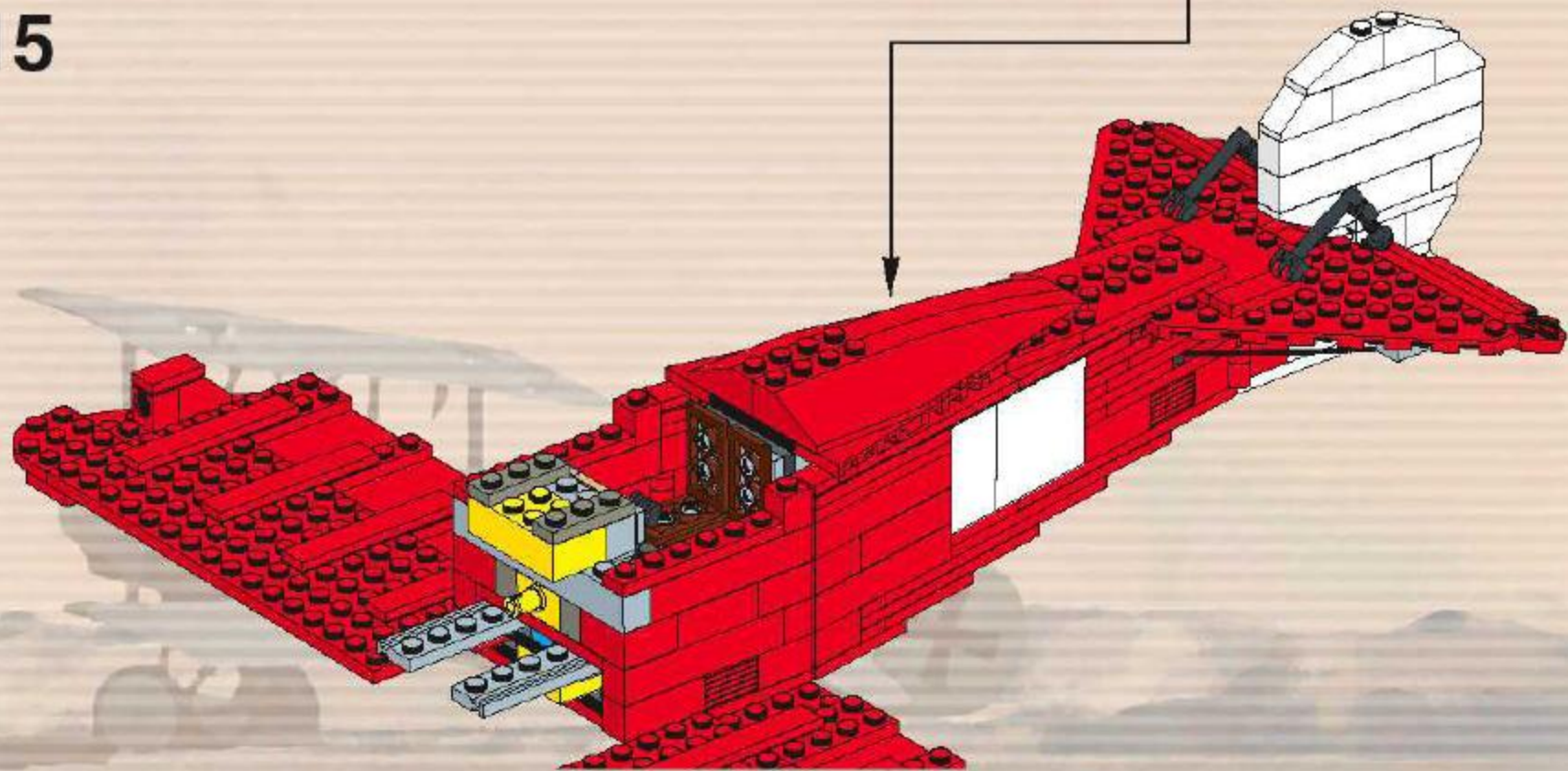



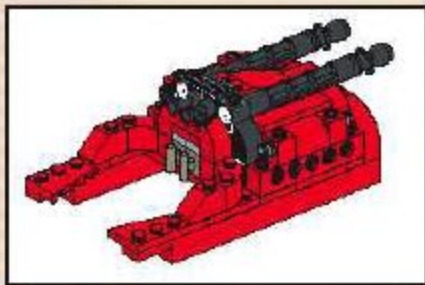

16



1

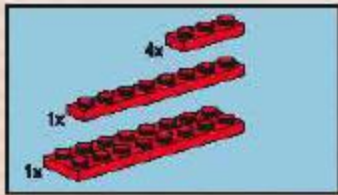
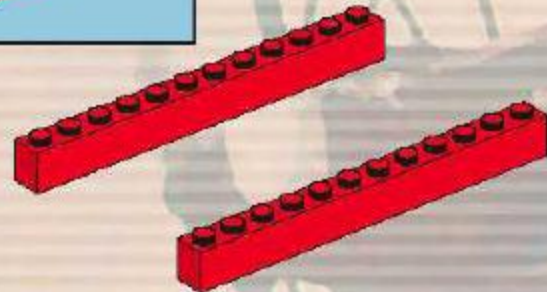

2

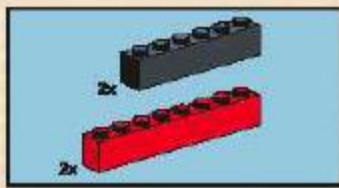
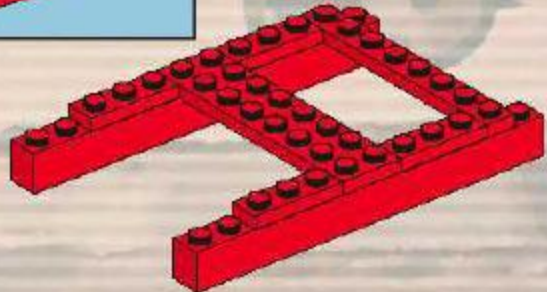

3

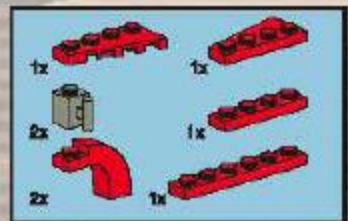
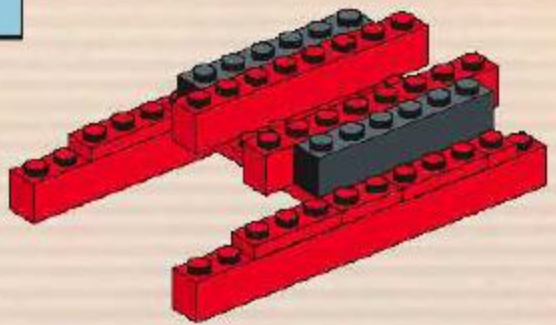

4

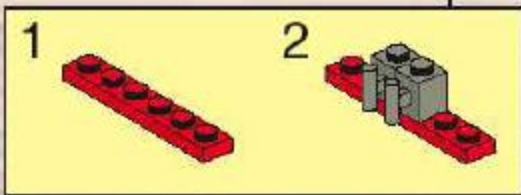
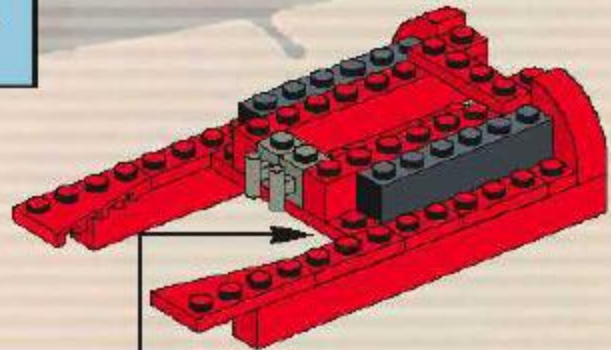

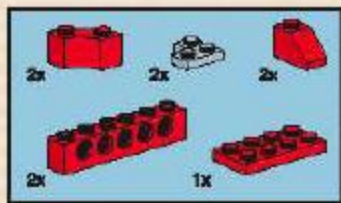

5

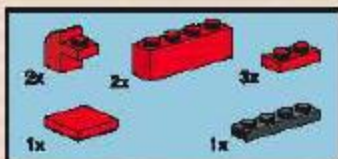
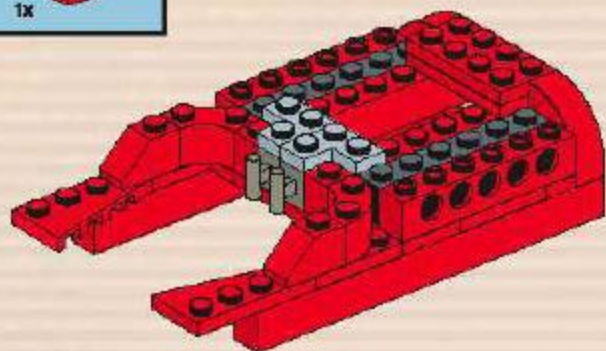

6

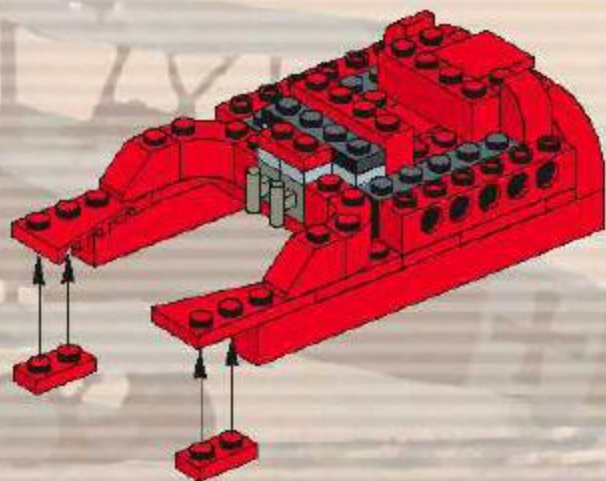

7

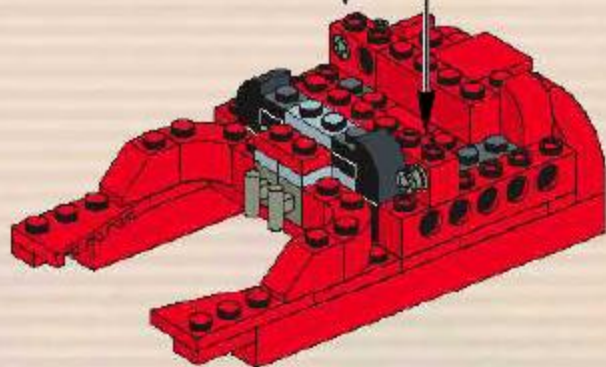
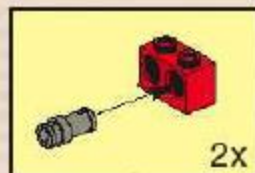



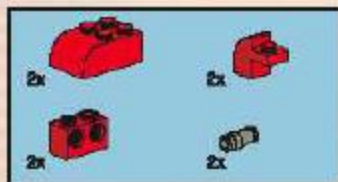

8

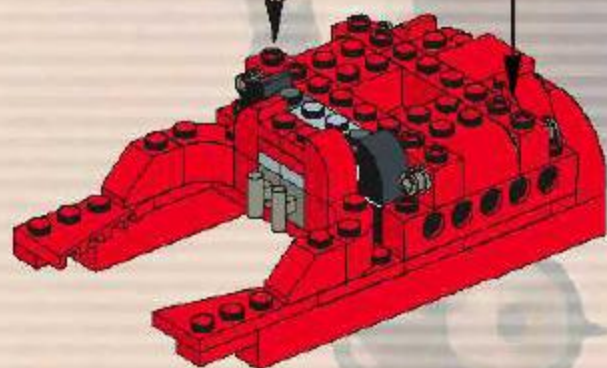
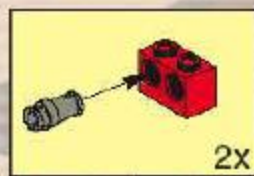

9

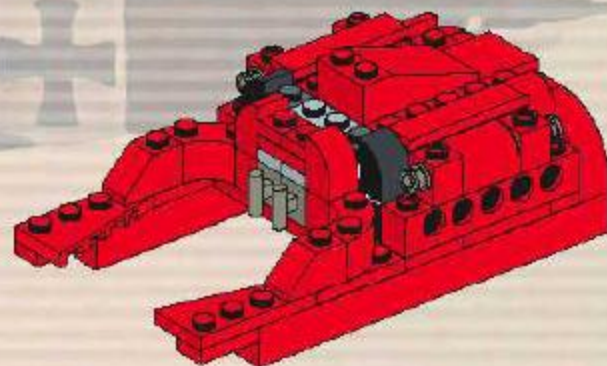



10

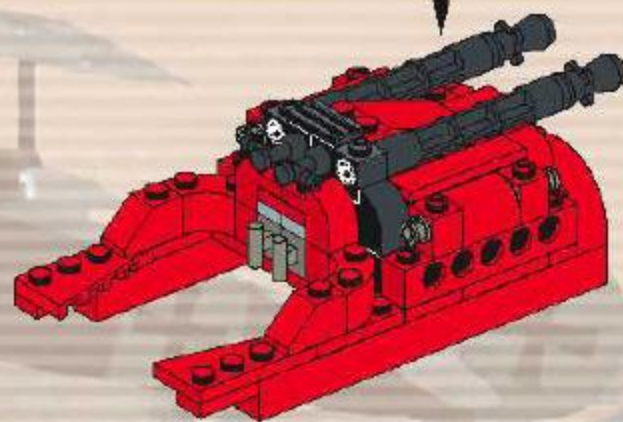
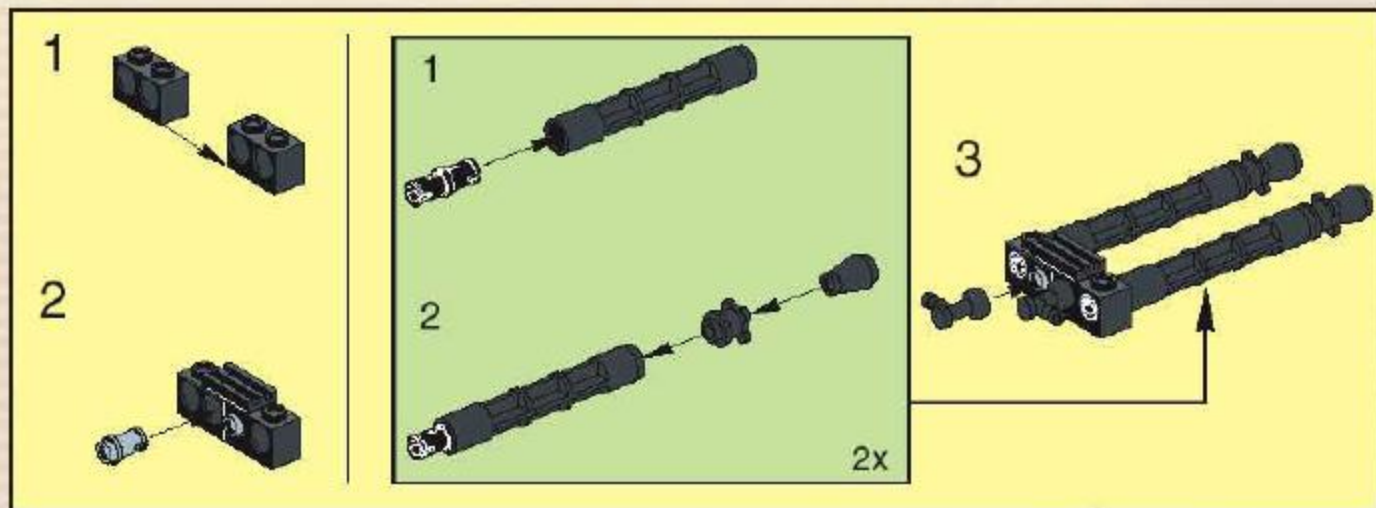



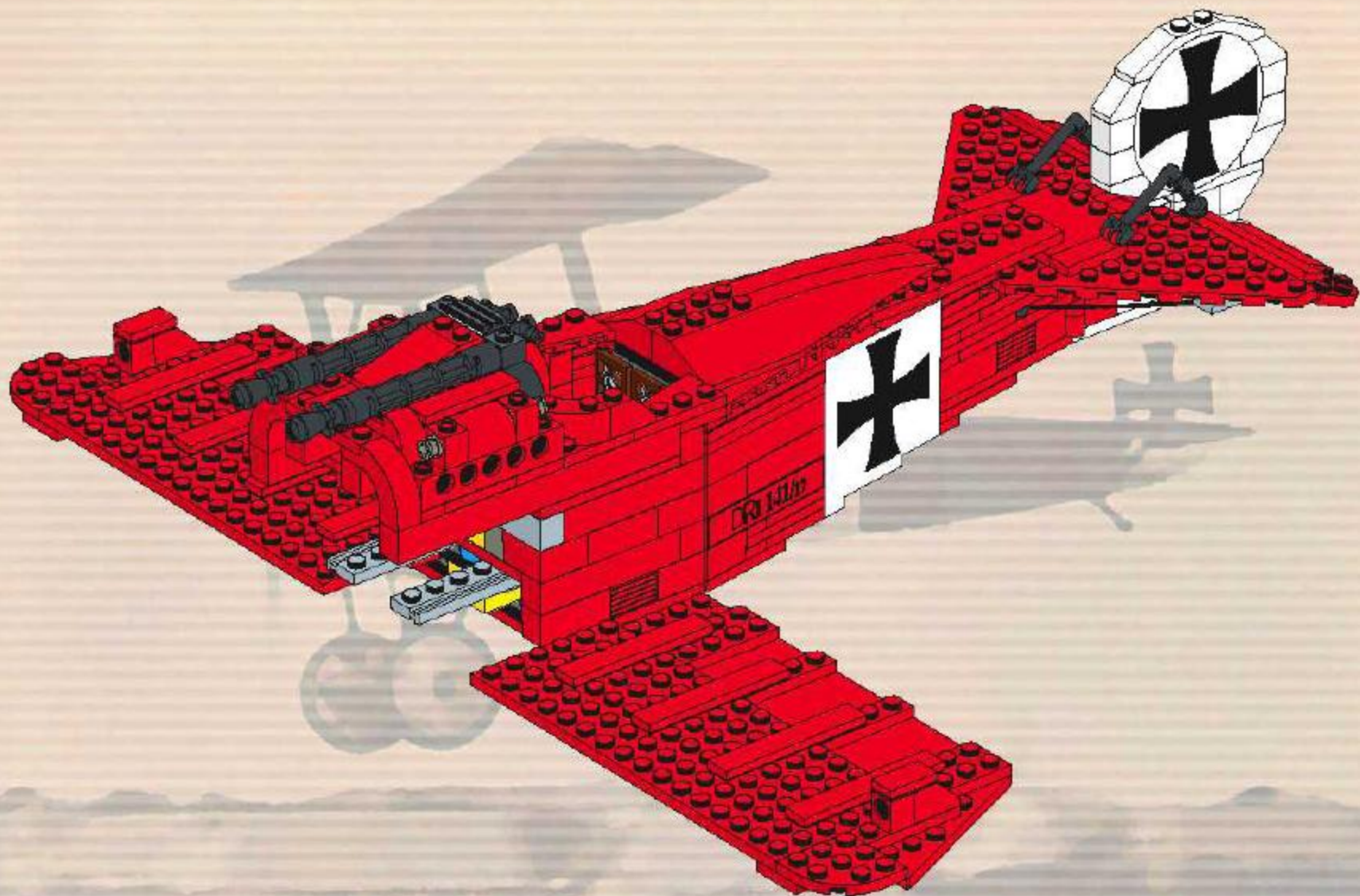

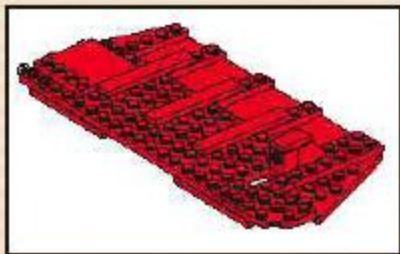

17

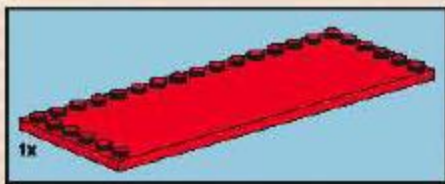

1

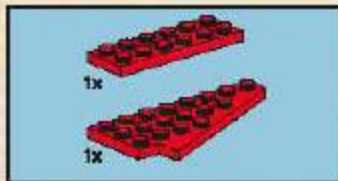
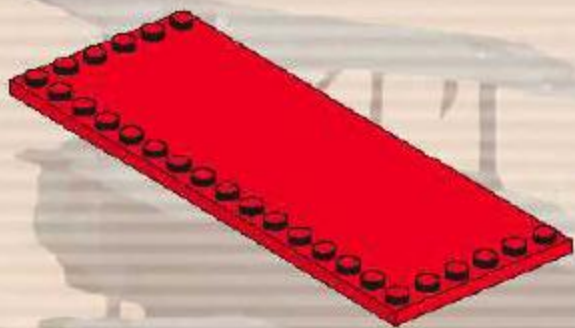

2

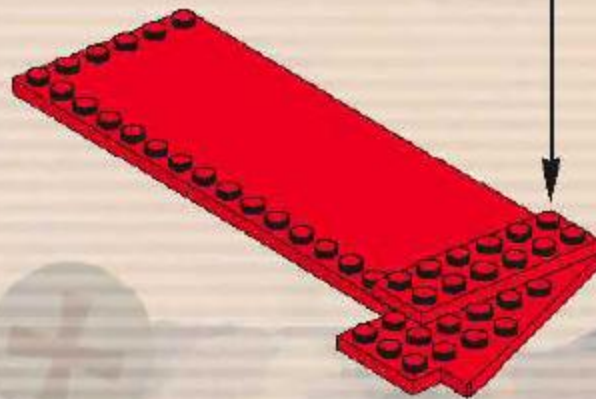
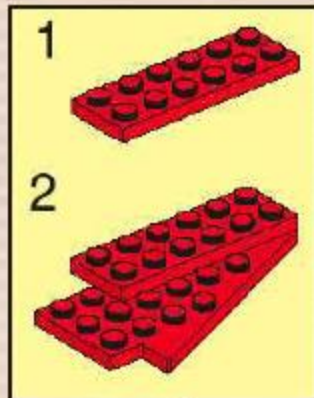



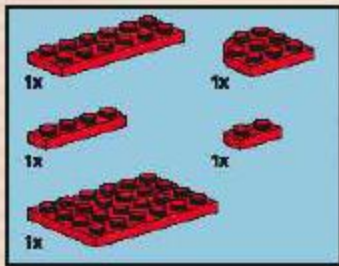

3

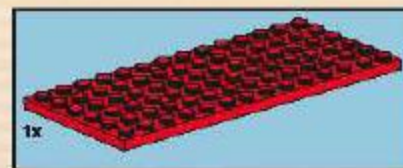
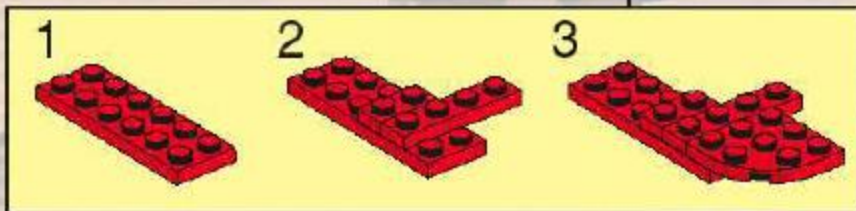
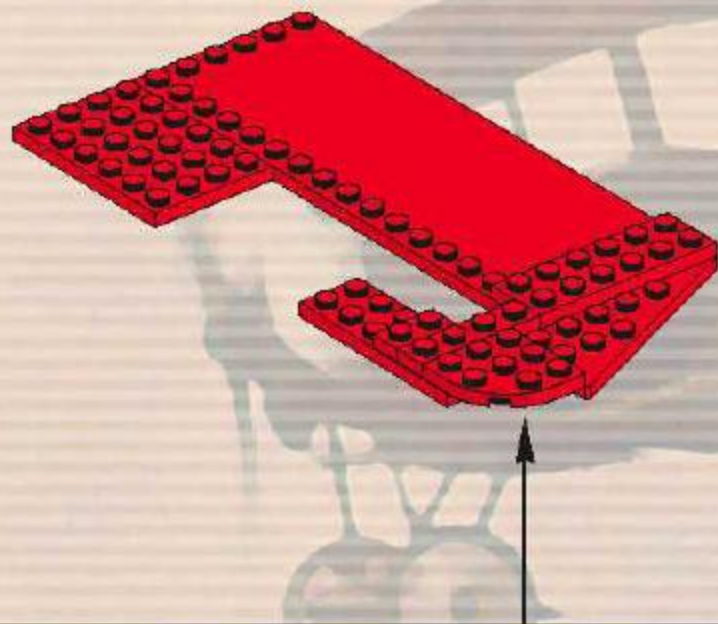

4

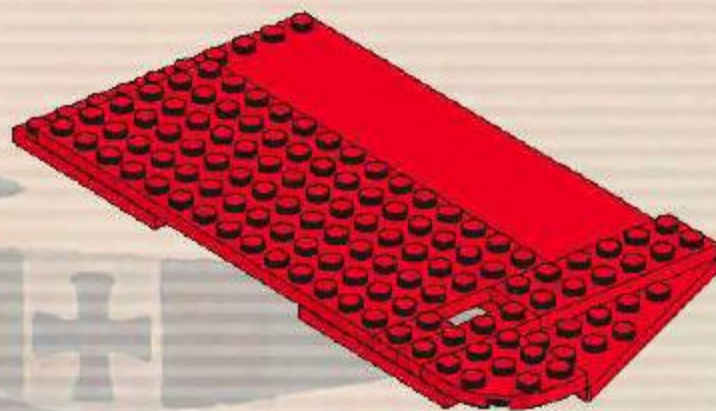



5

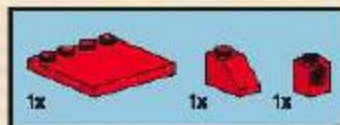
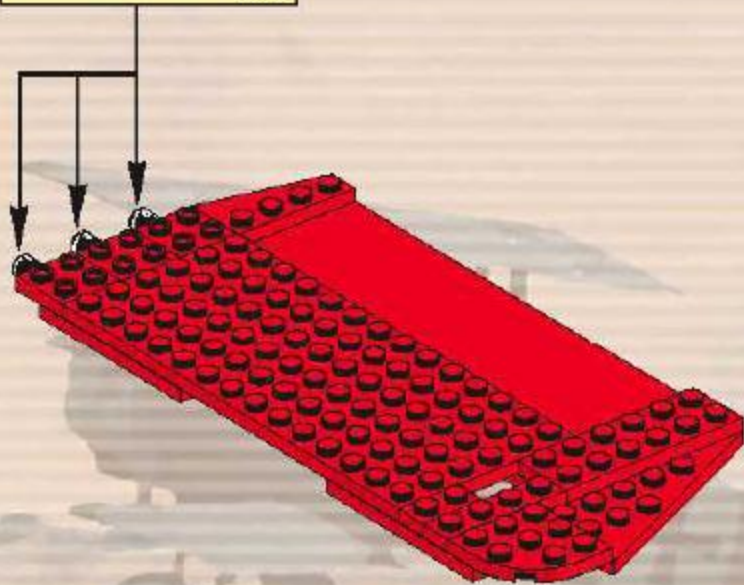
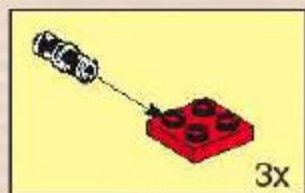

6

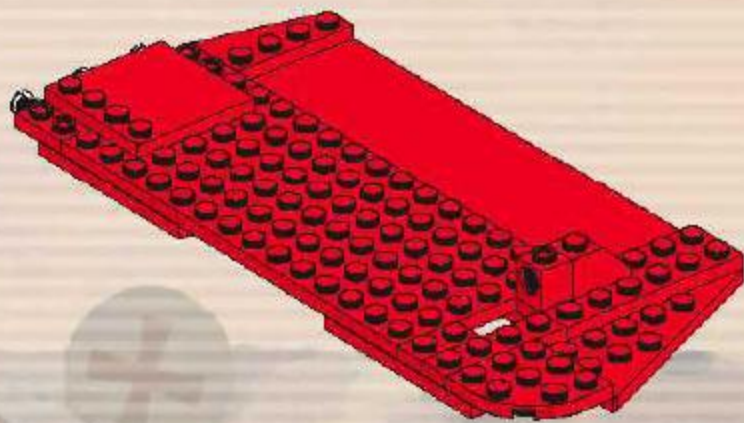



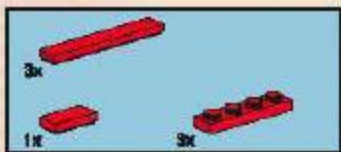

7

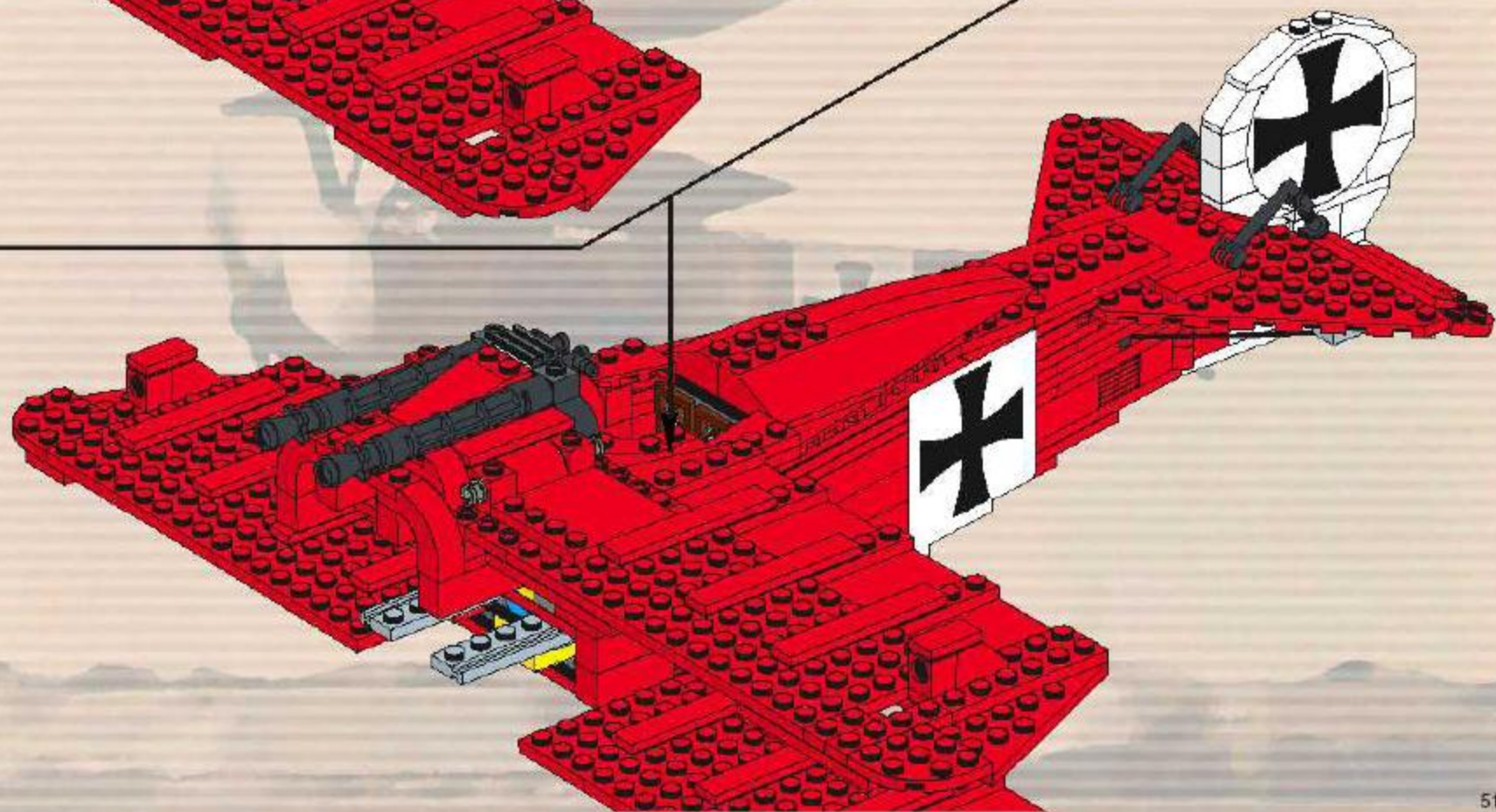
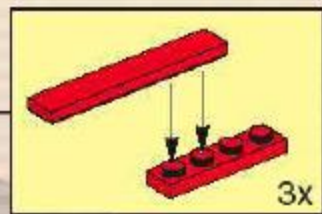

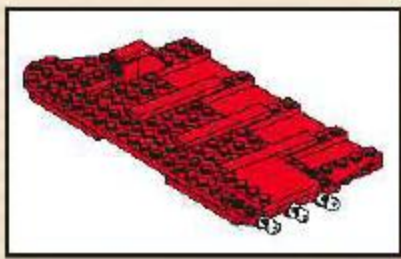

18

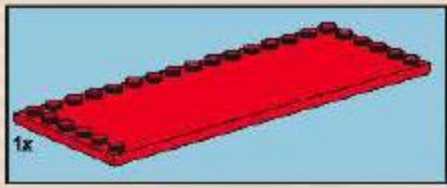

1

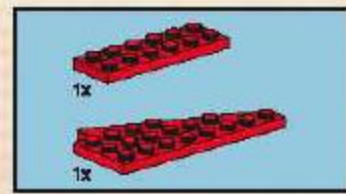

2

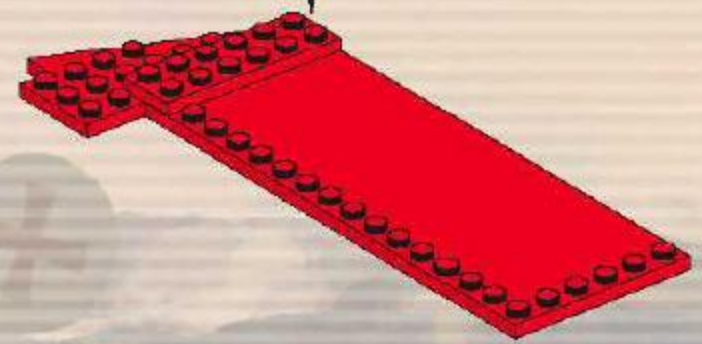
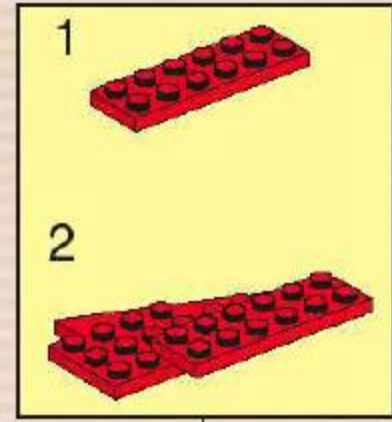



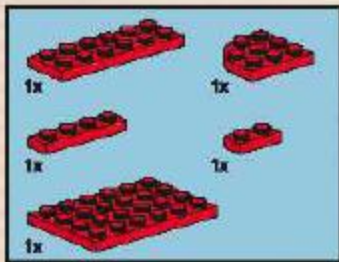

3

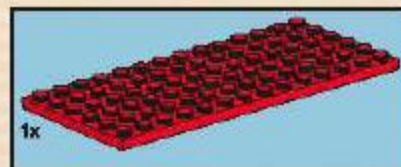
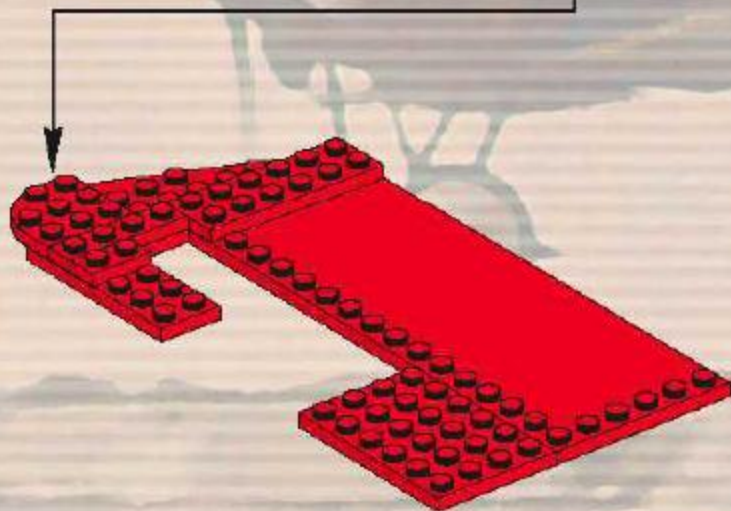
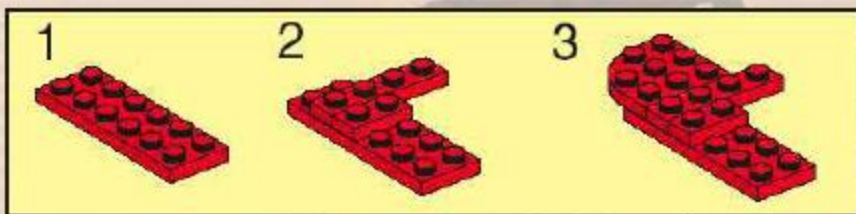

4





5

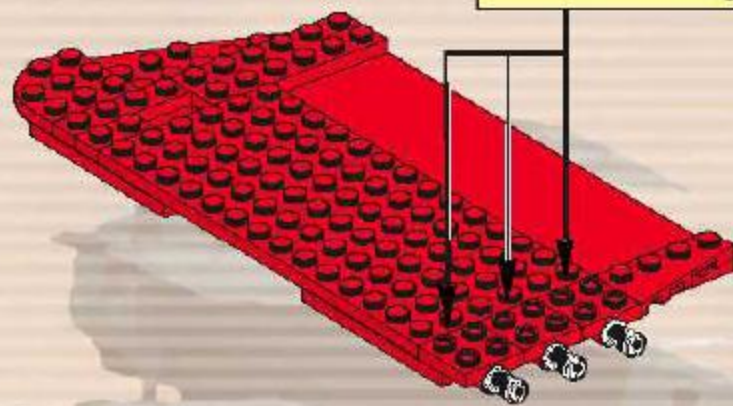

6

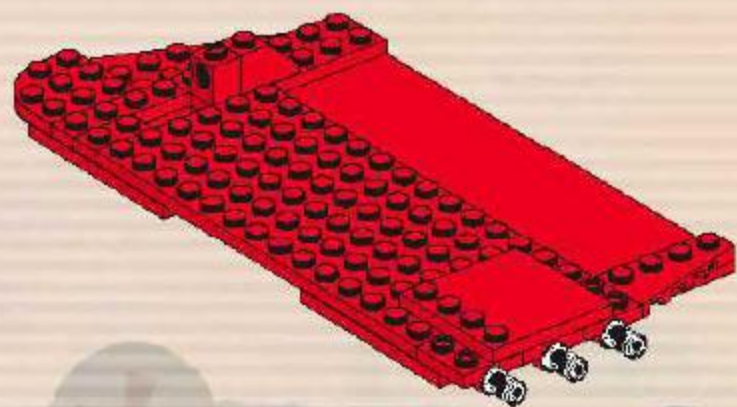



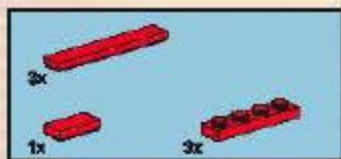

7

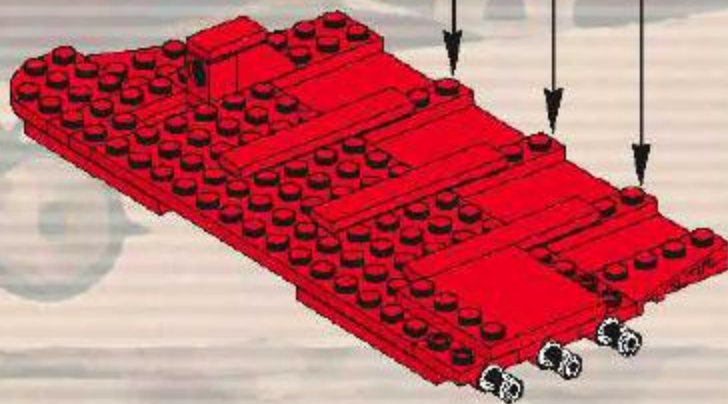
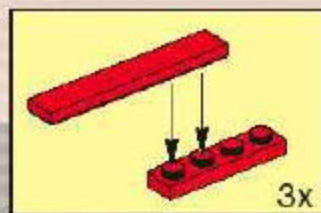

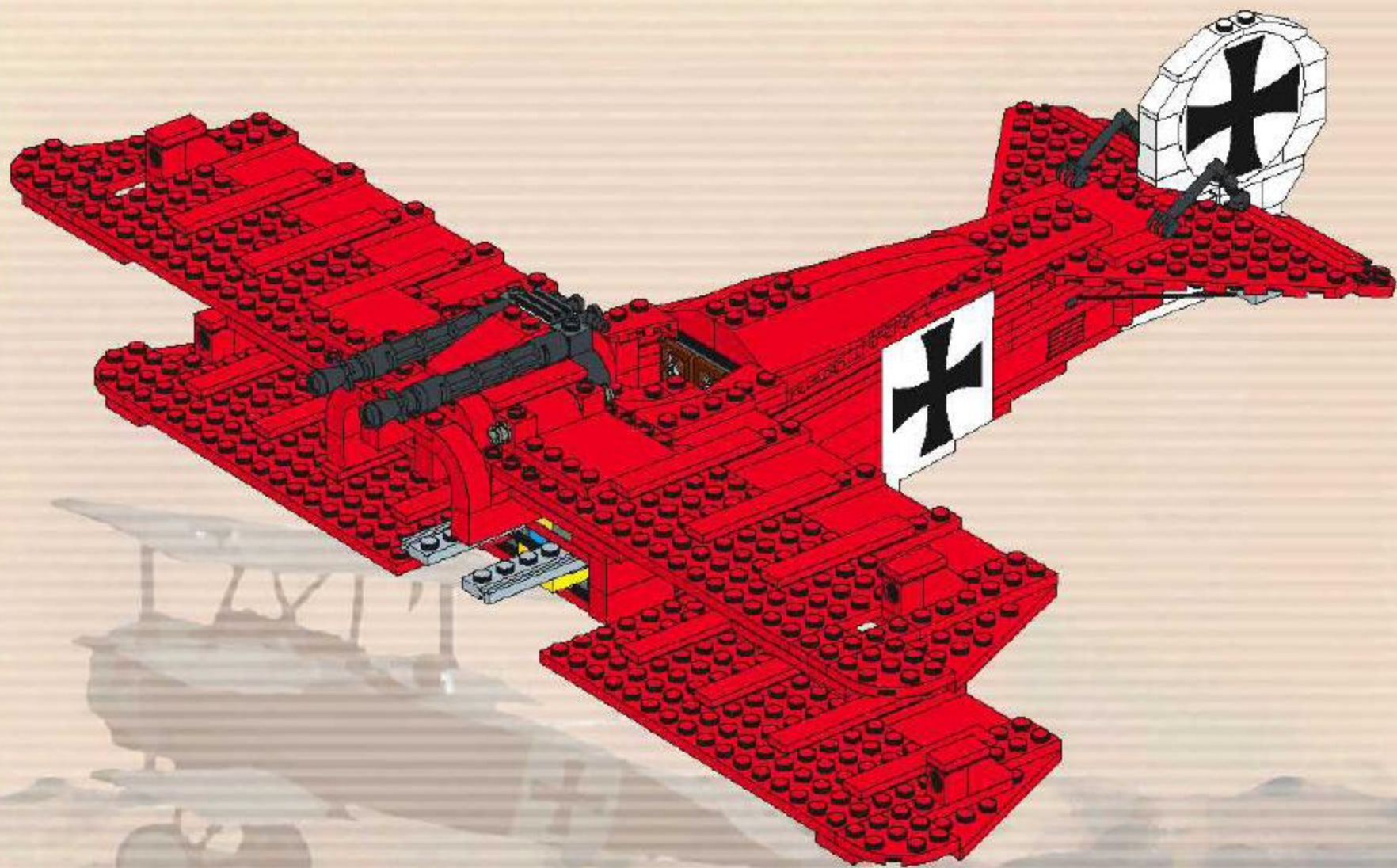





19

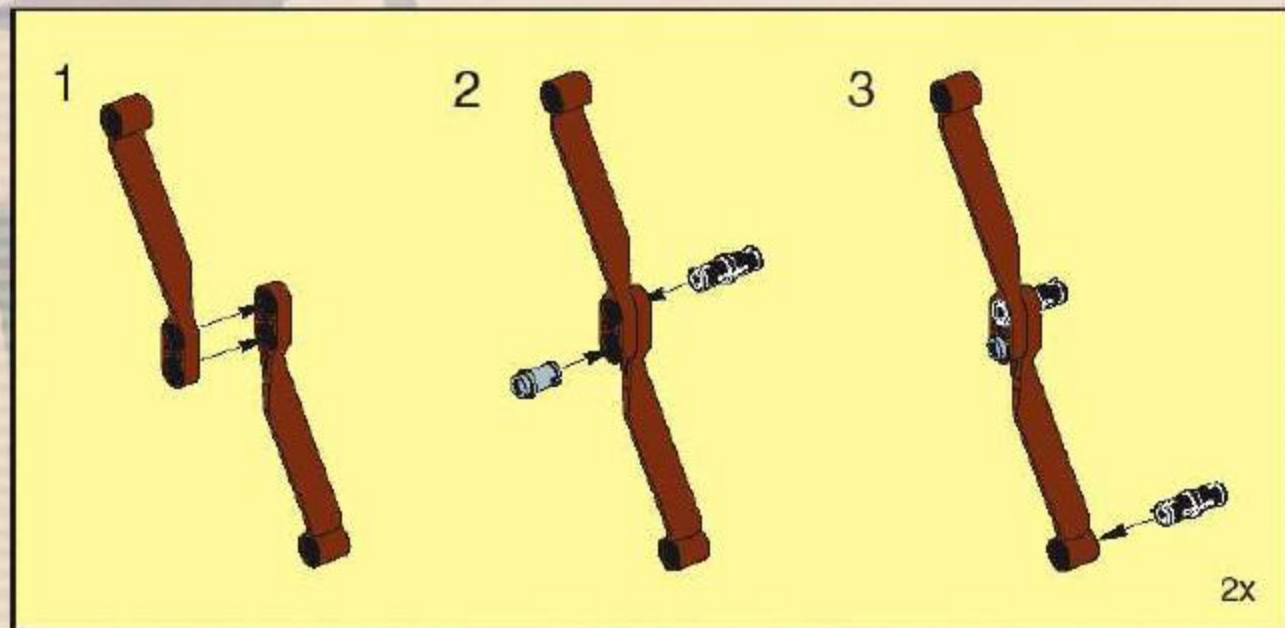

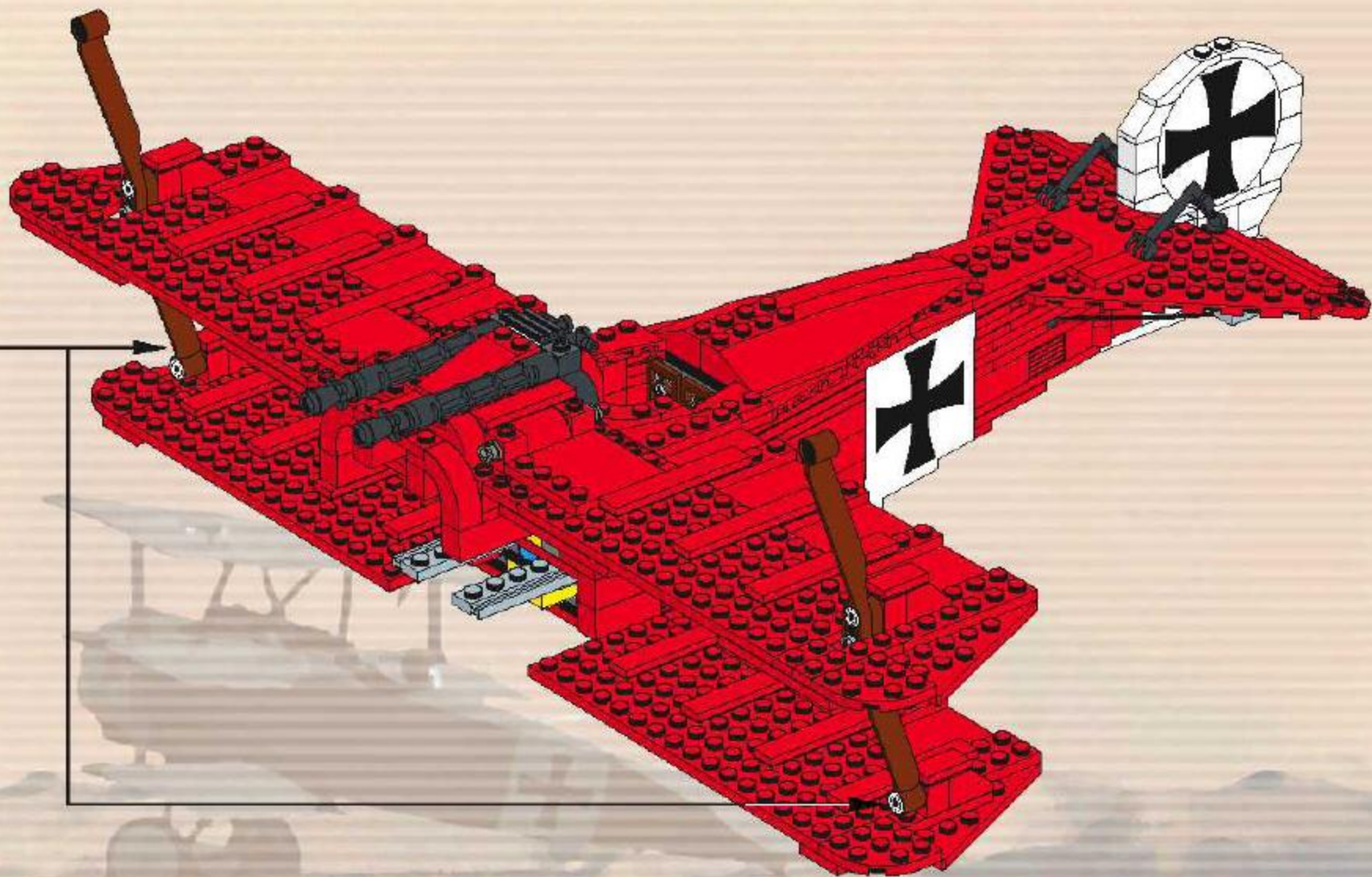



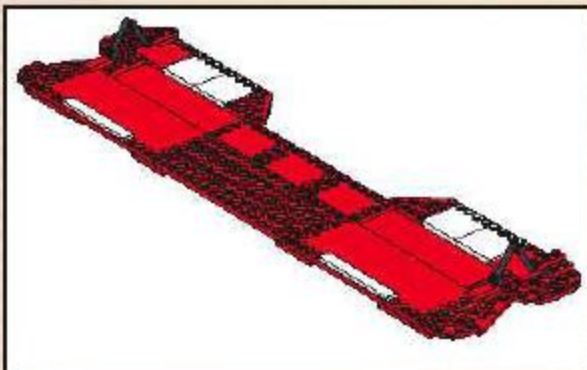

20

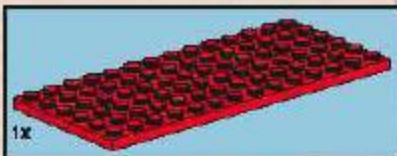

1



2

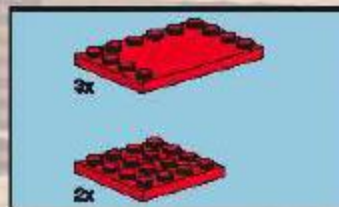

3

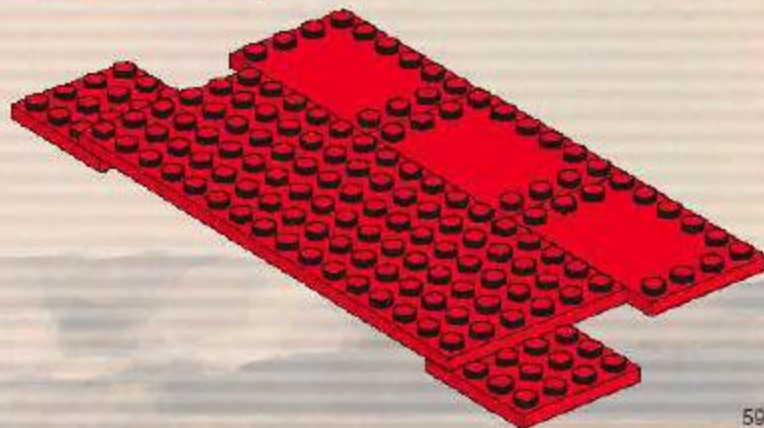

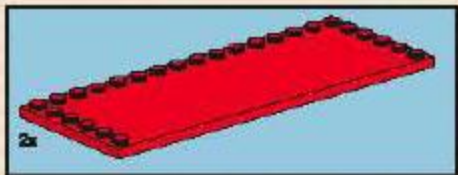

4

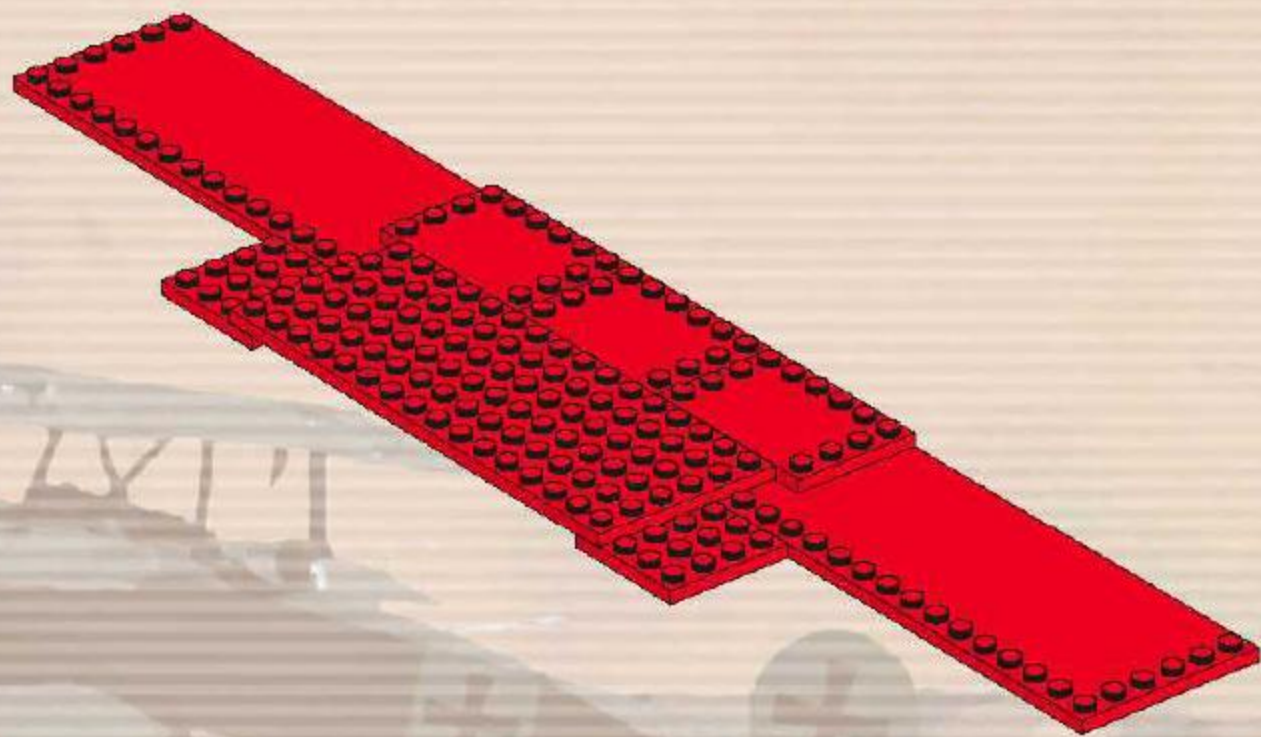



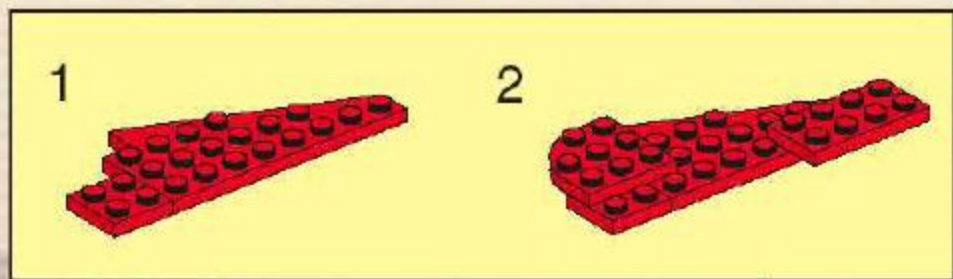
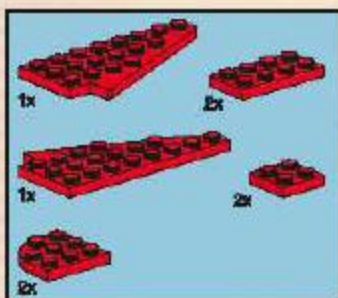

5

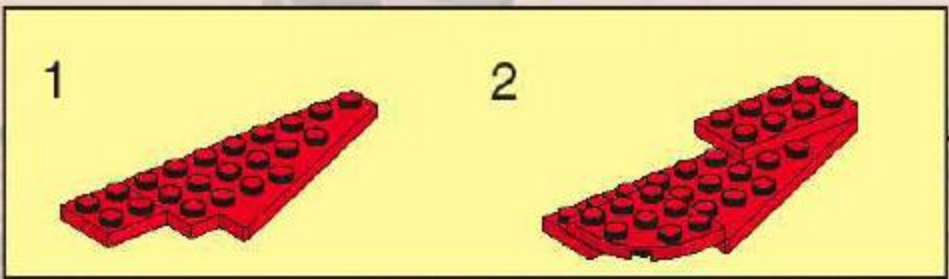
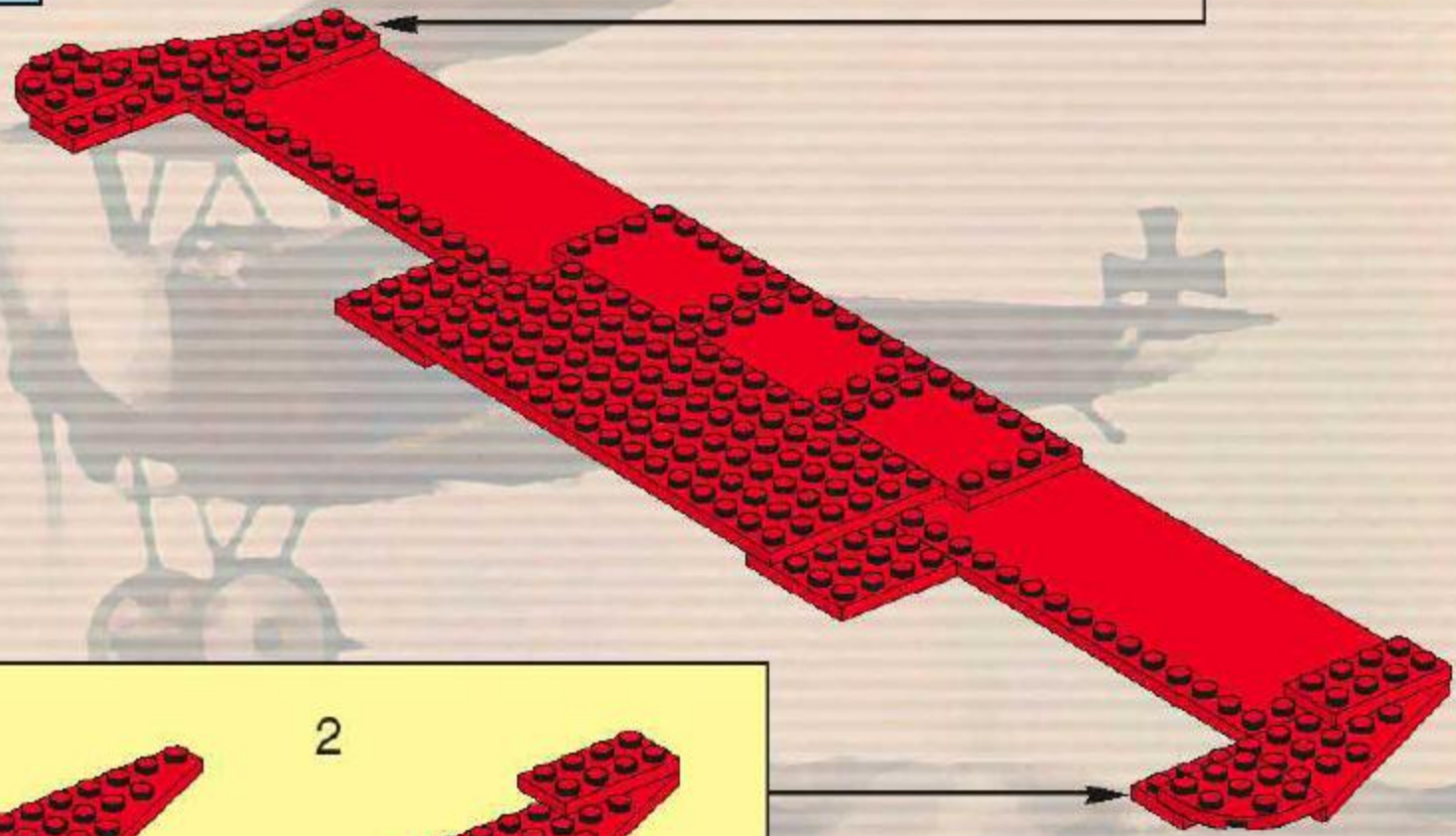

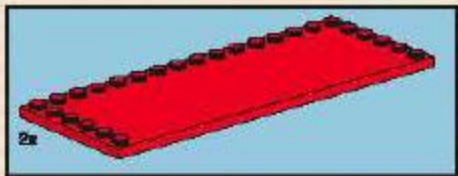

6

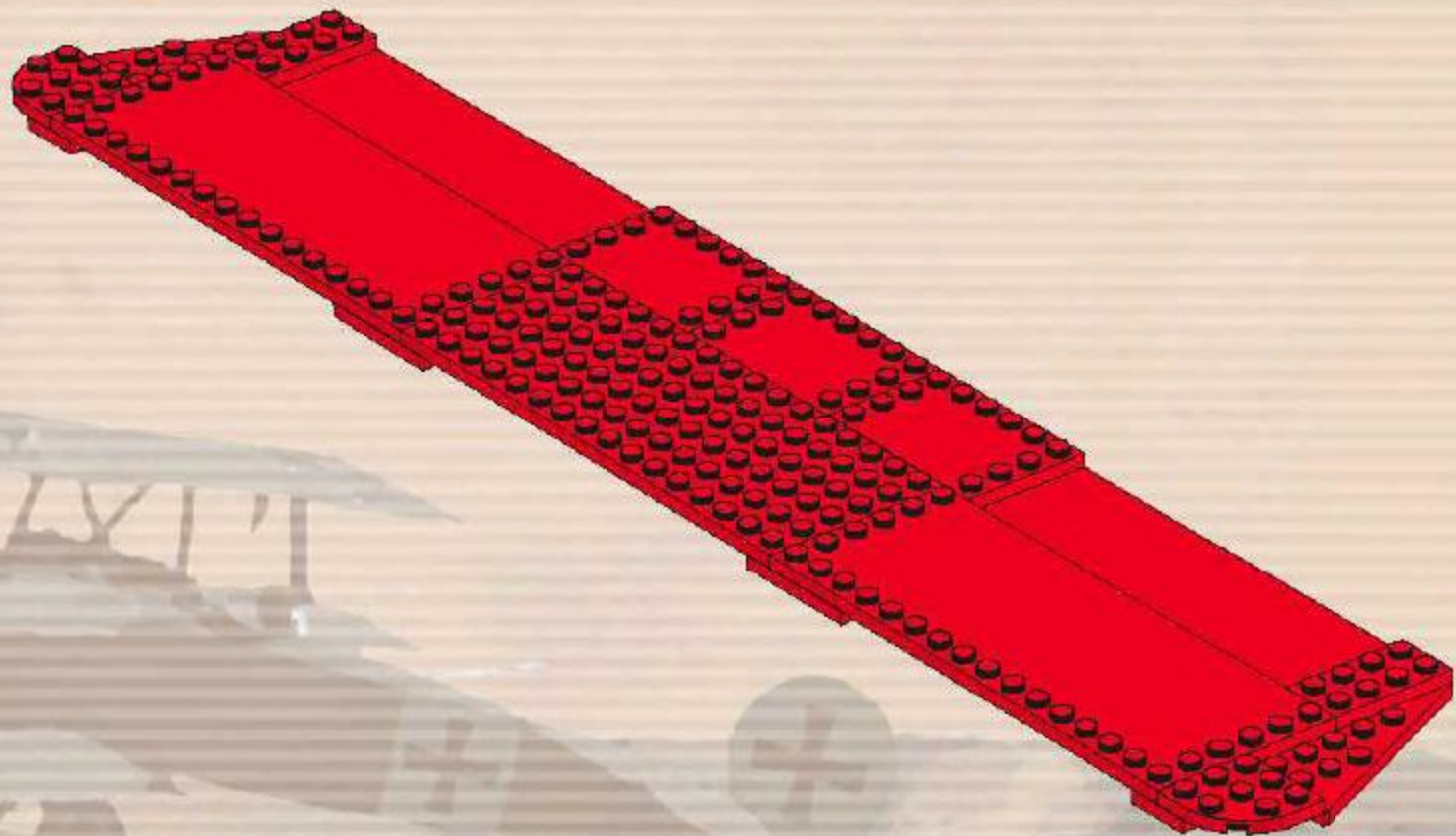



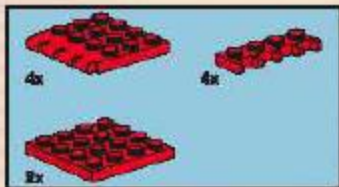

7

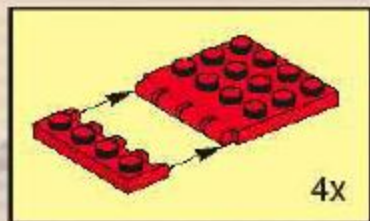
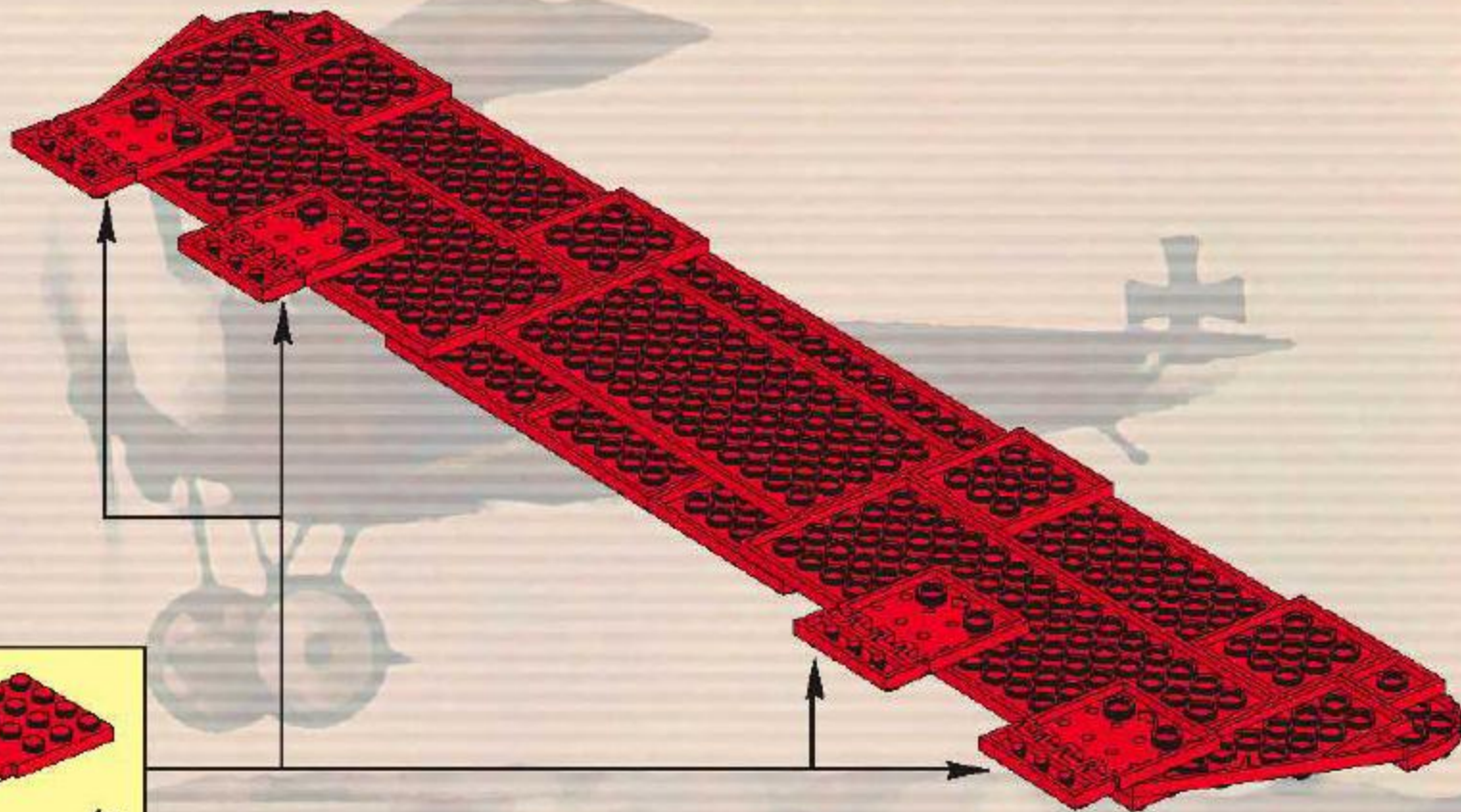

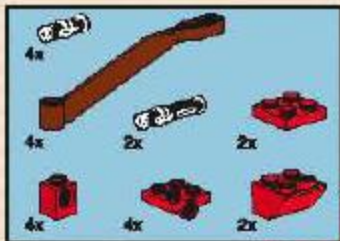

8

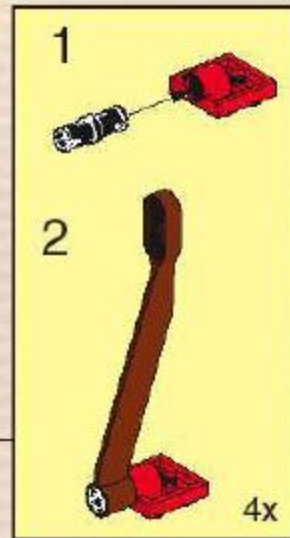
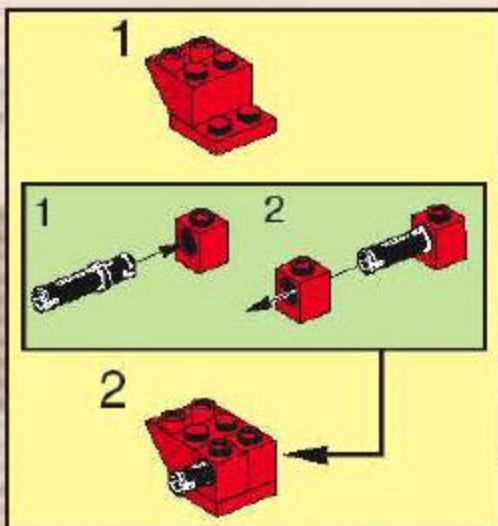
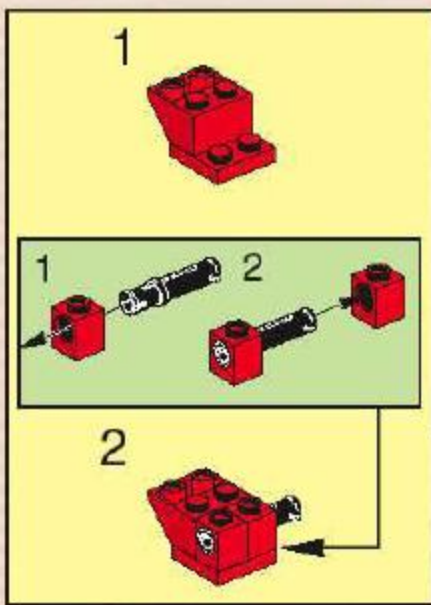



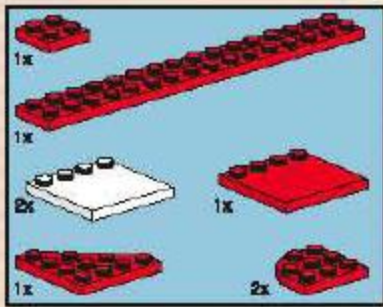

9

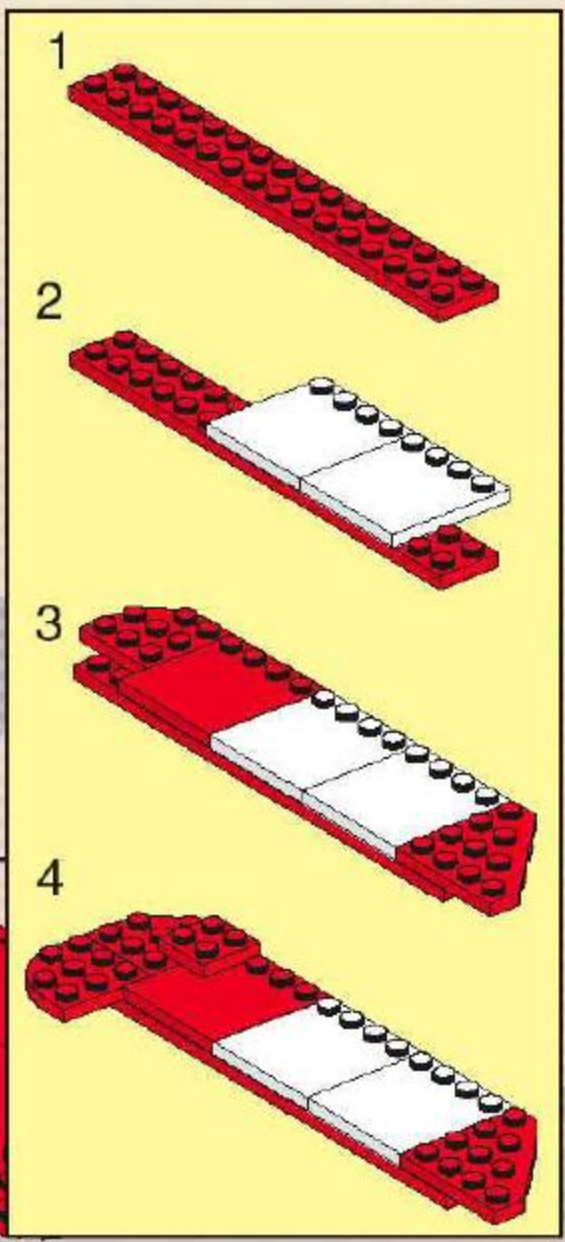
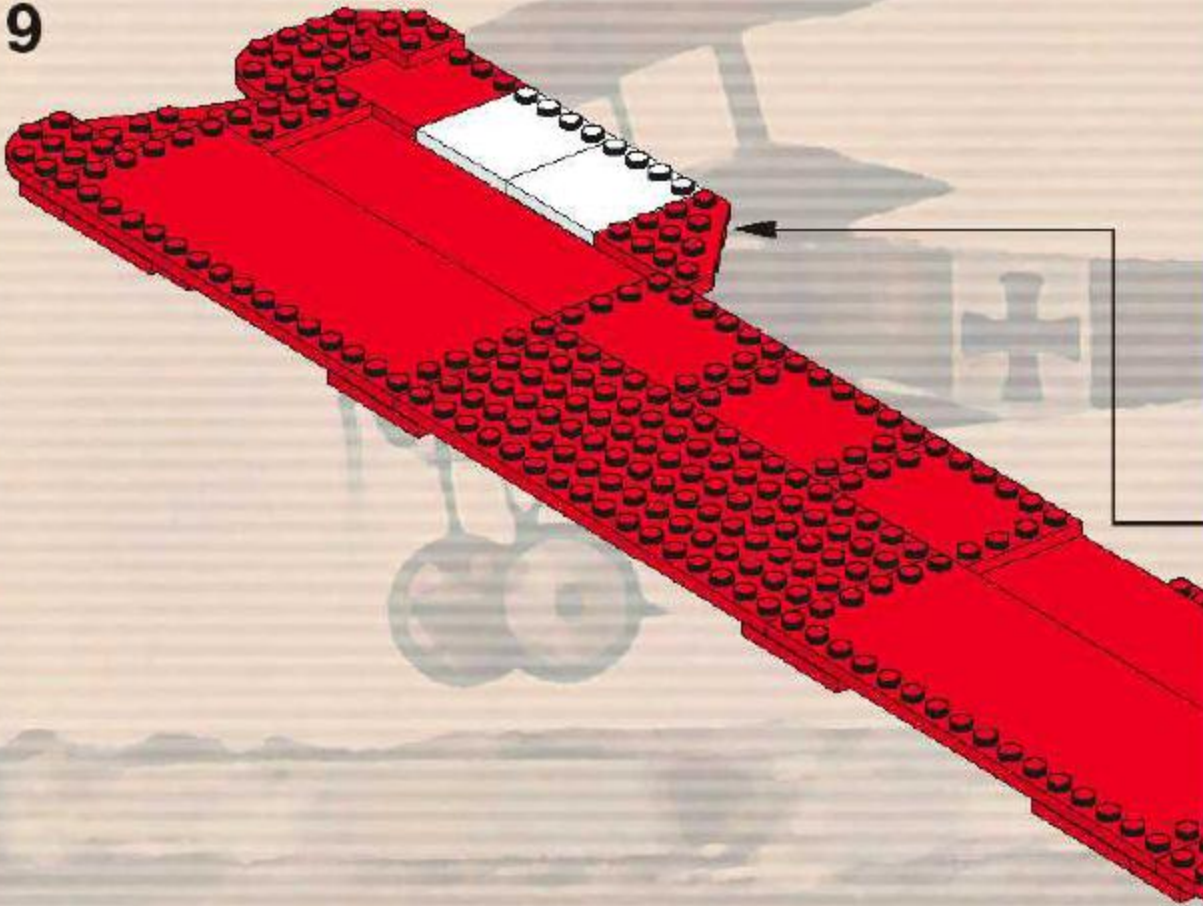

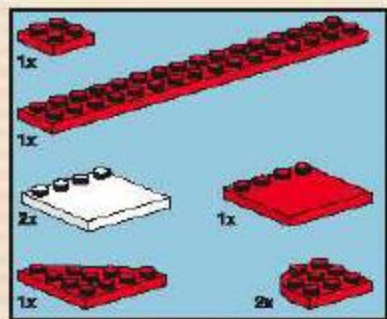

10

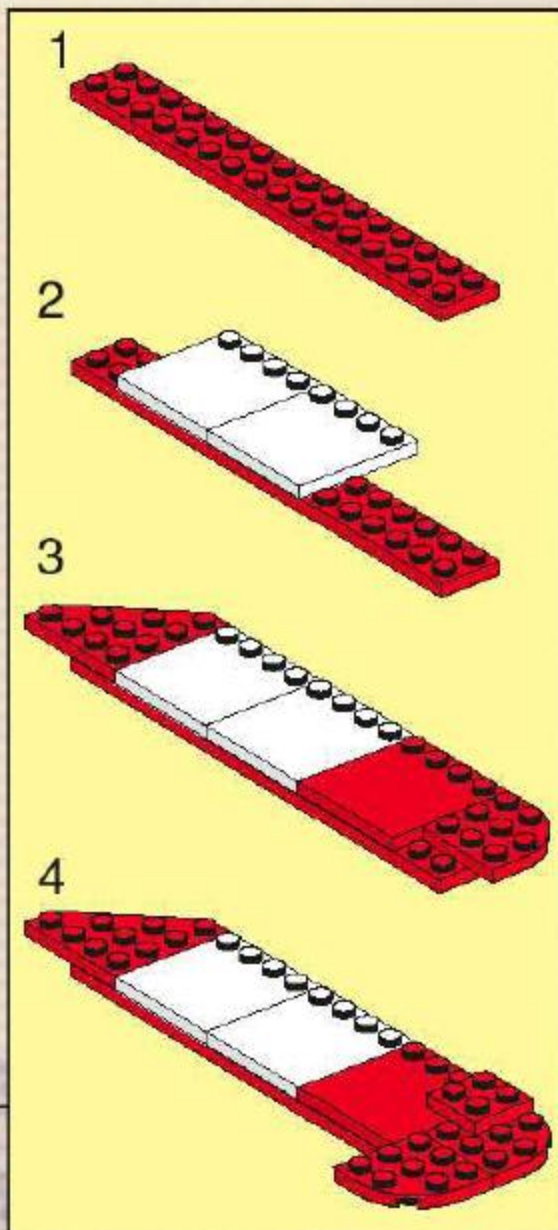
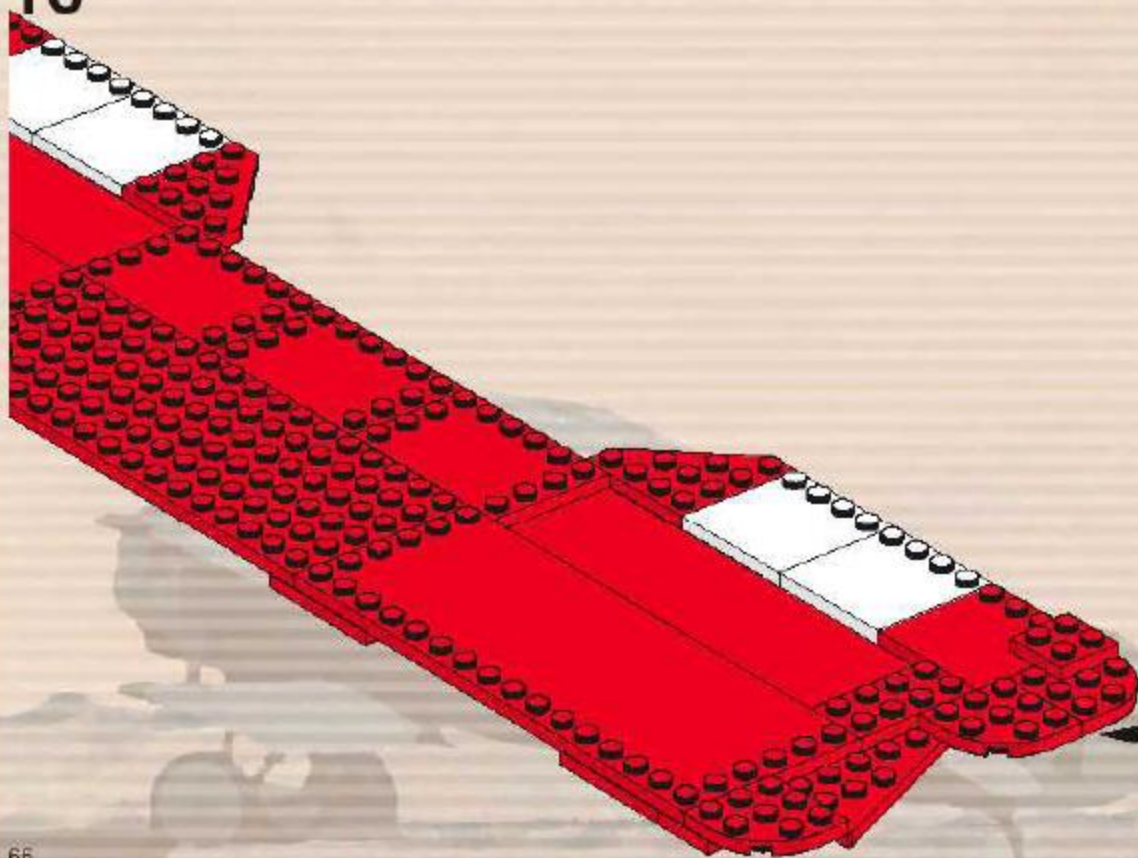



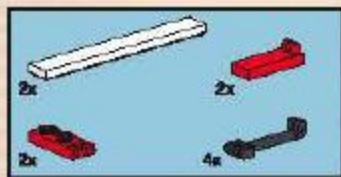

11

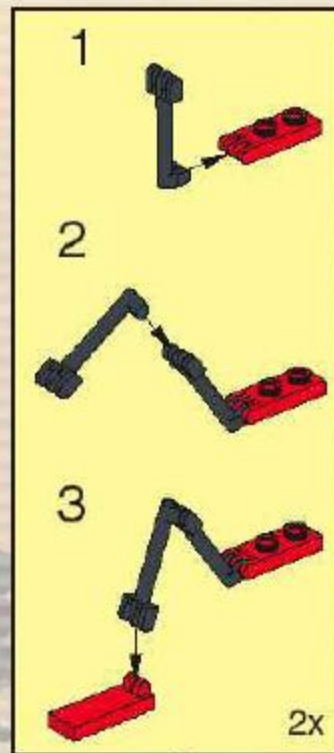
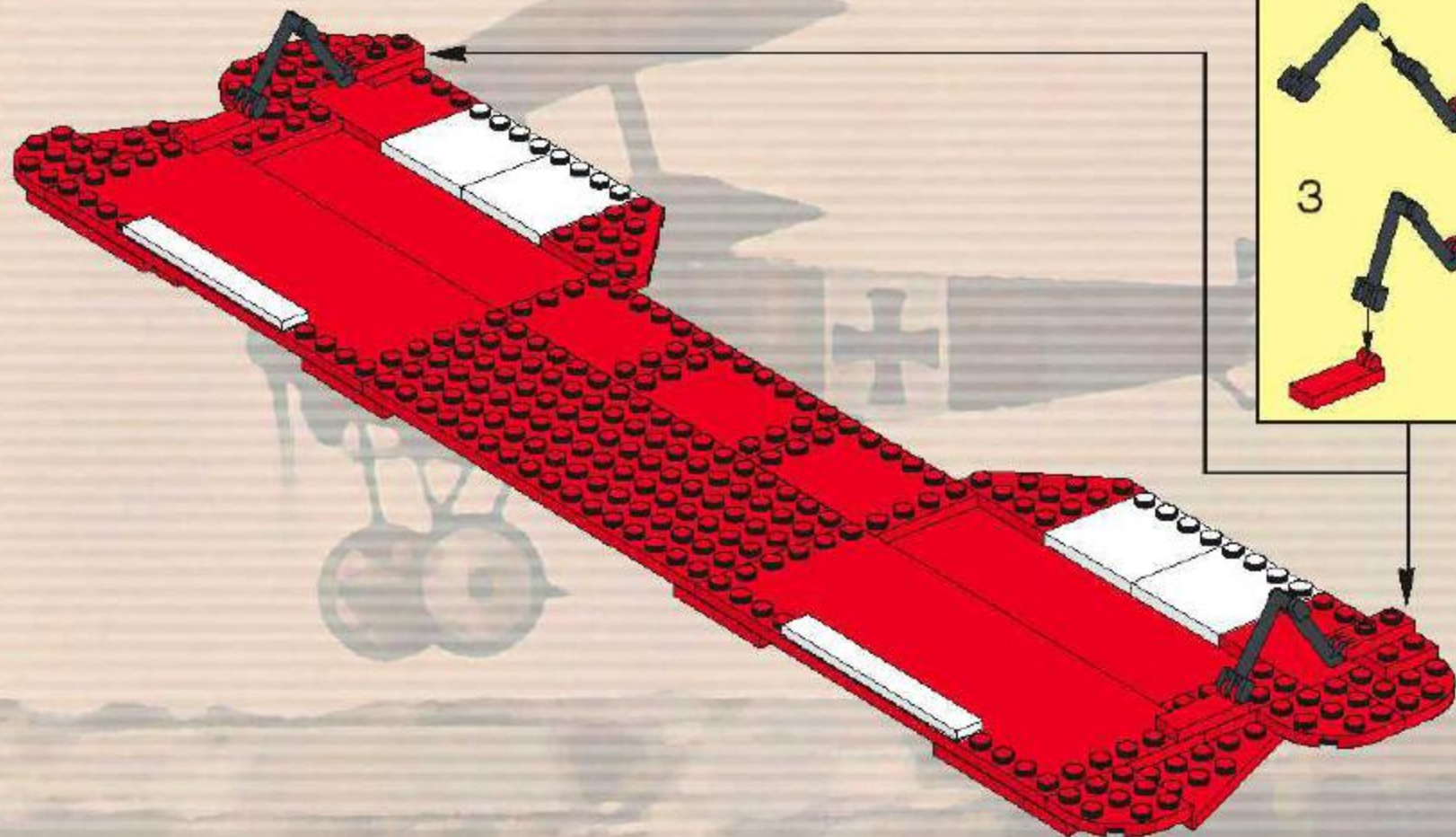

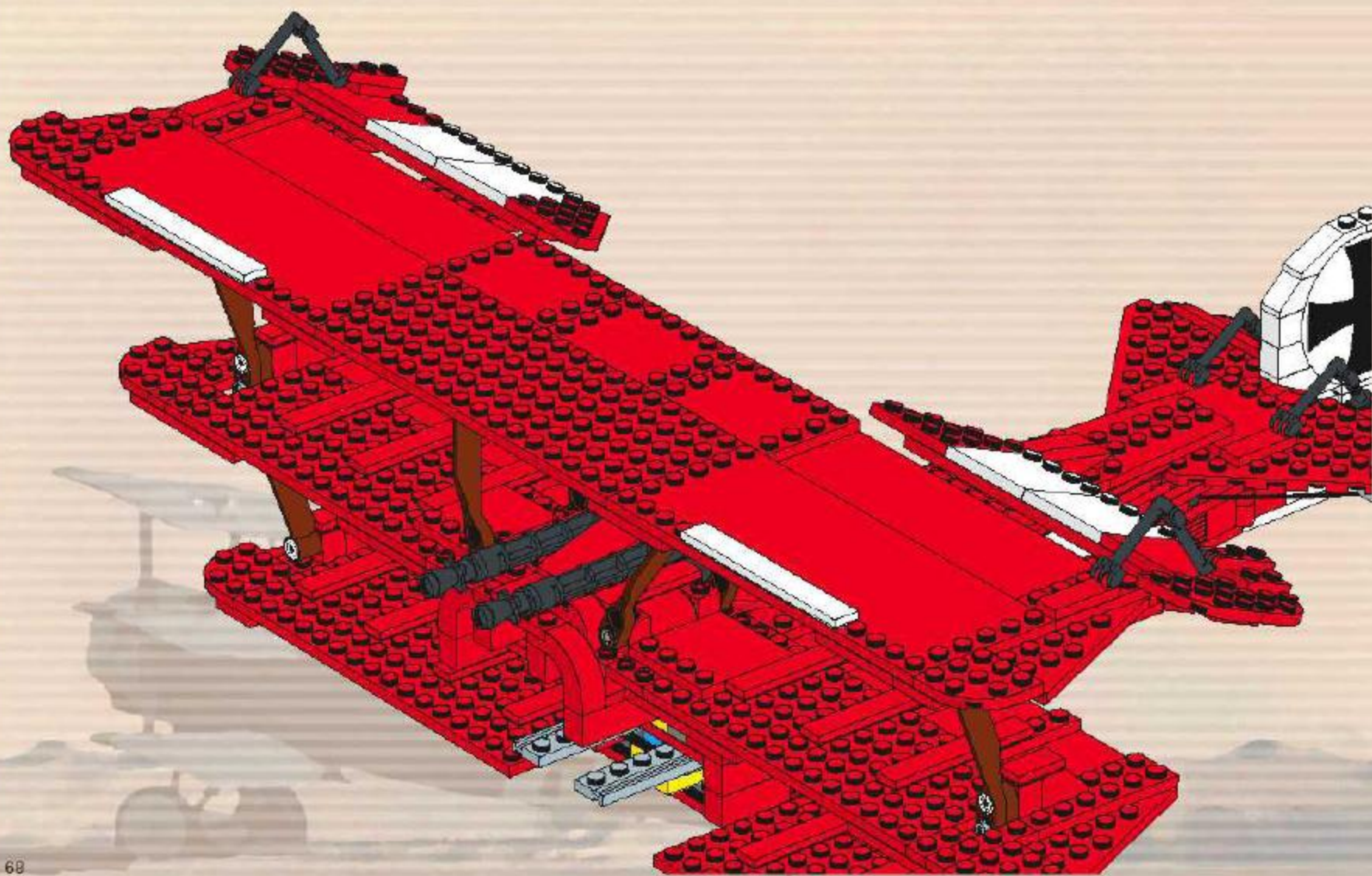





21

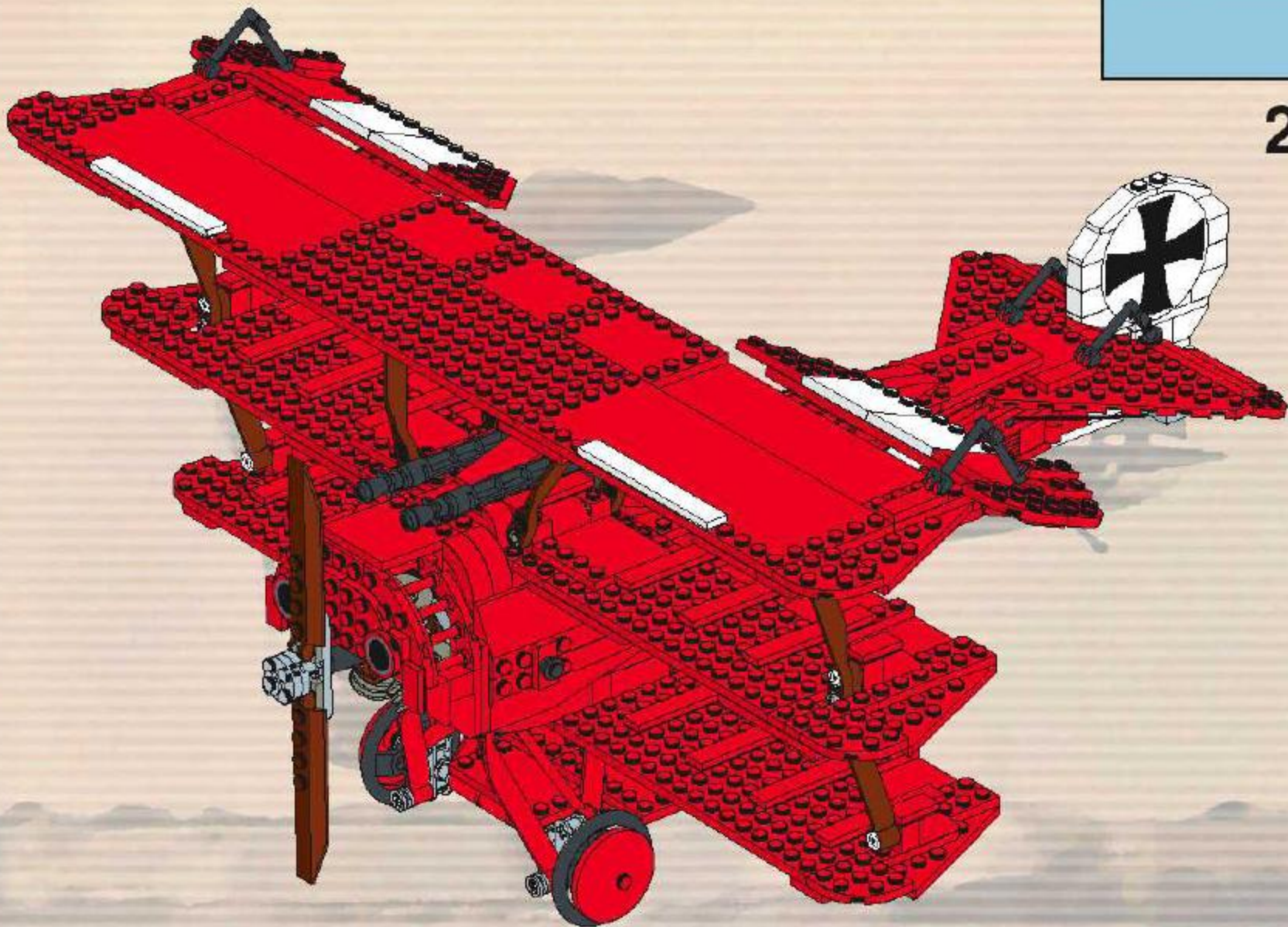

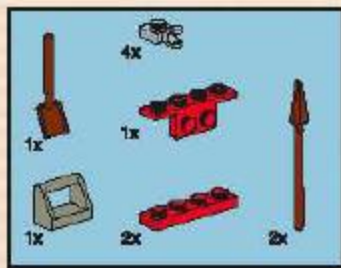

22

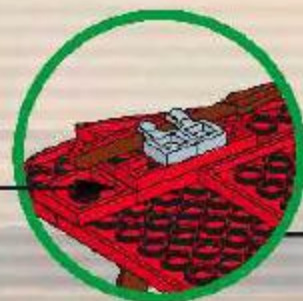
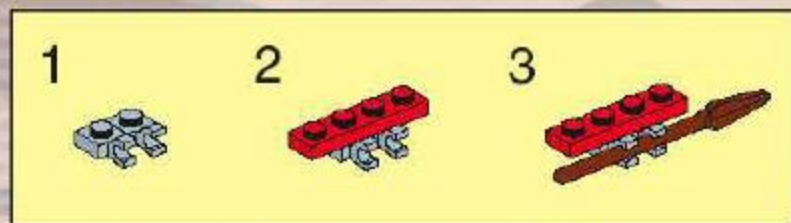
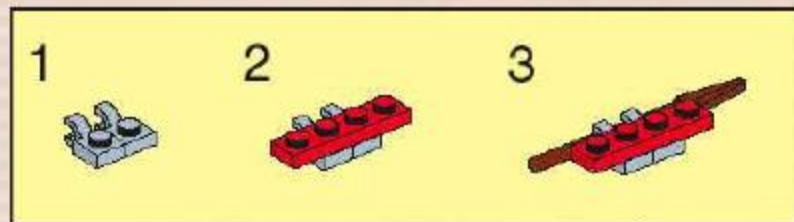



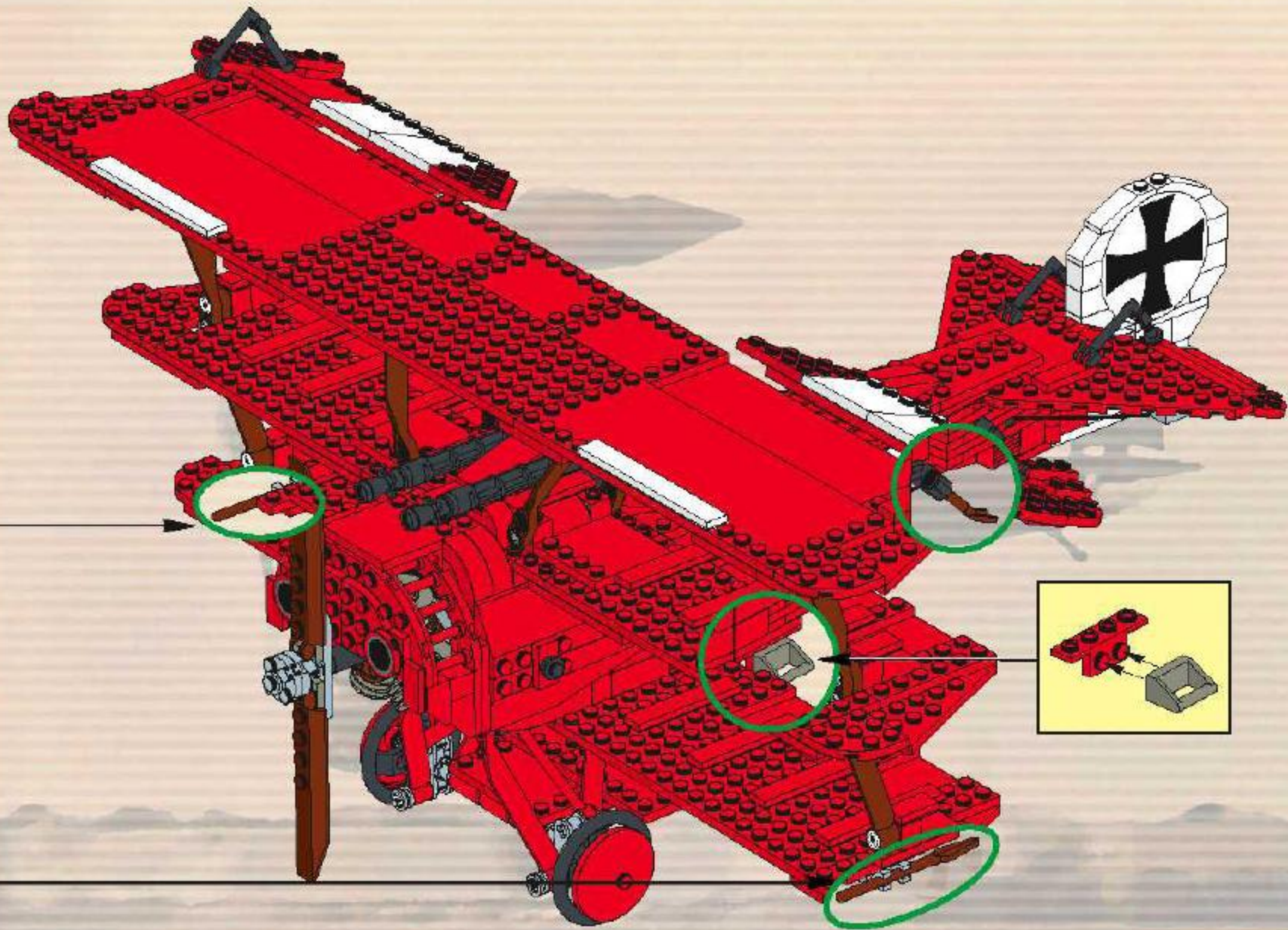





23

