

ZNAZ

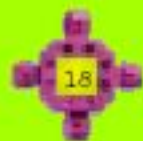

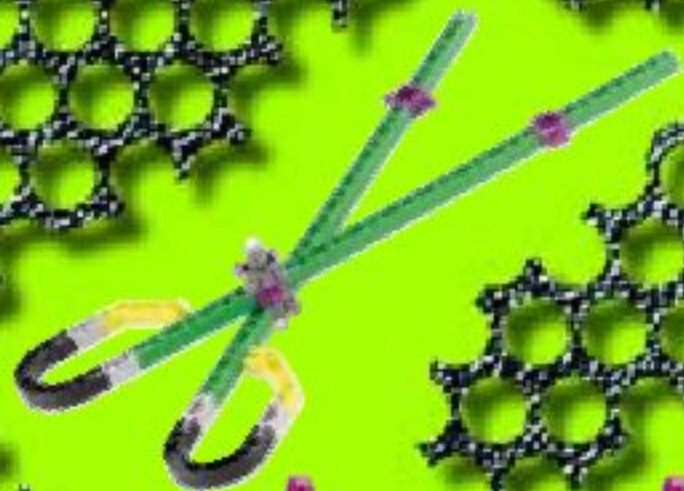

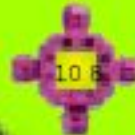

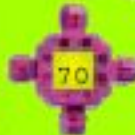
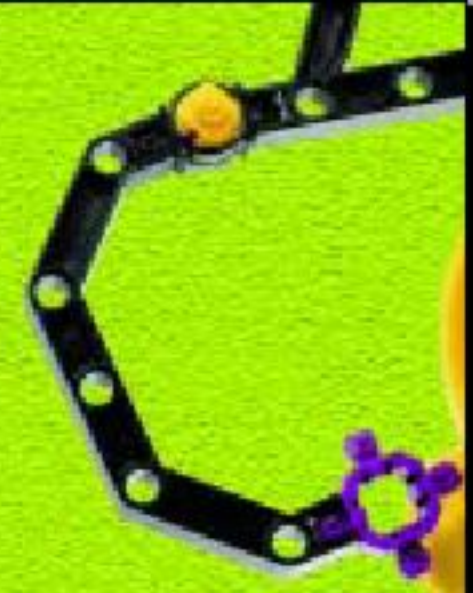

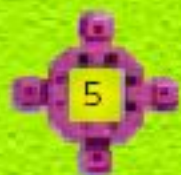

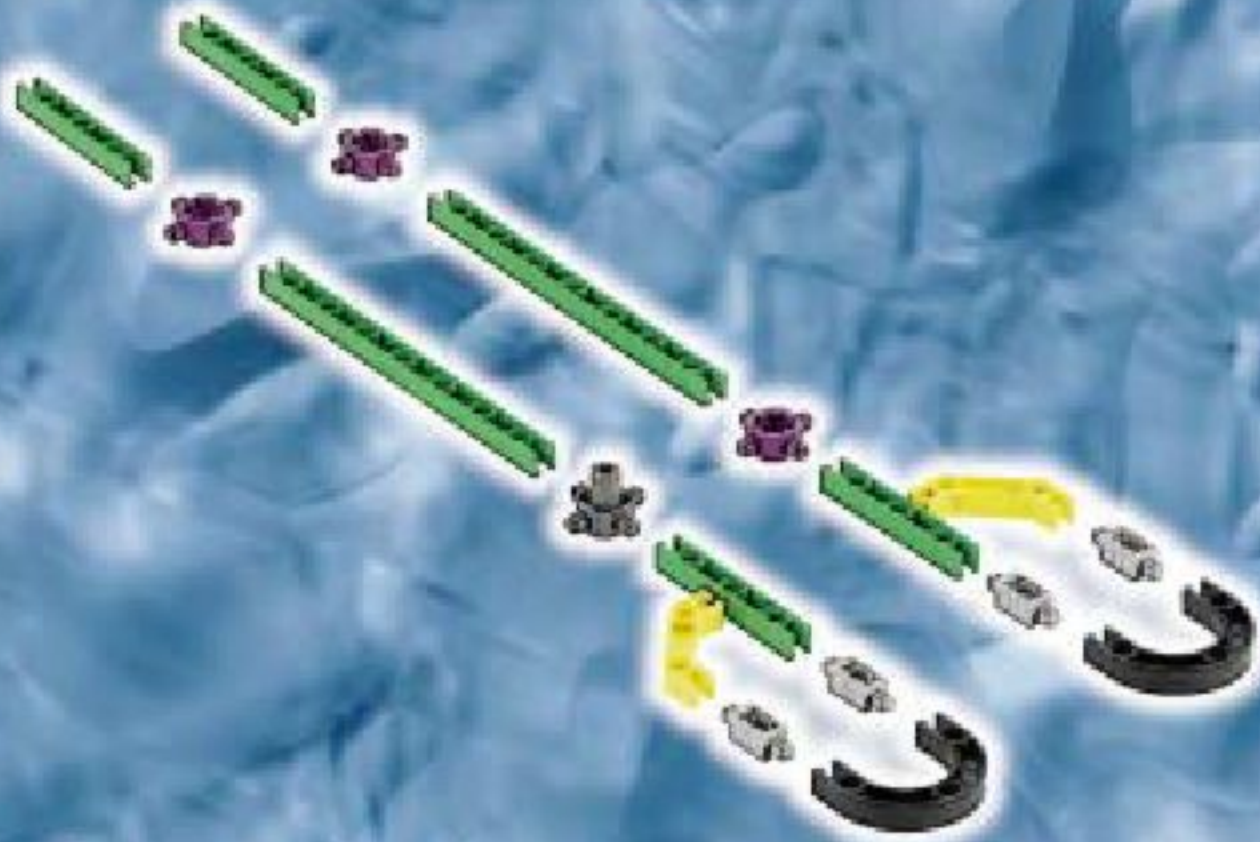

2

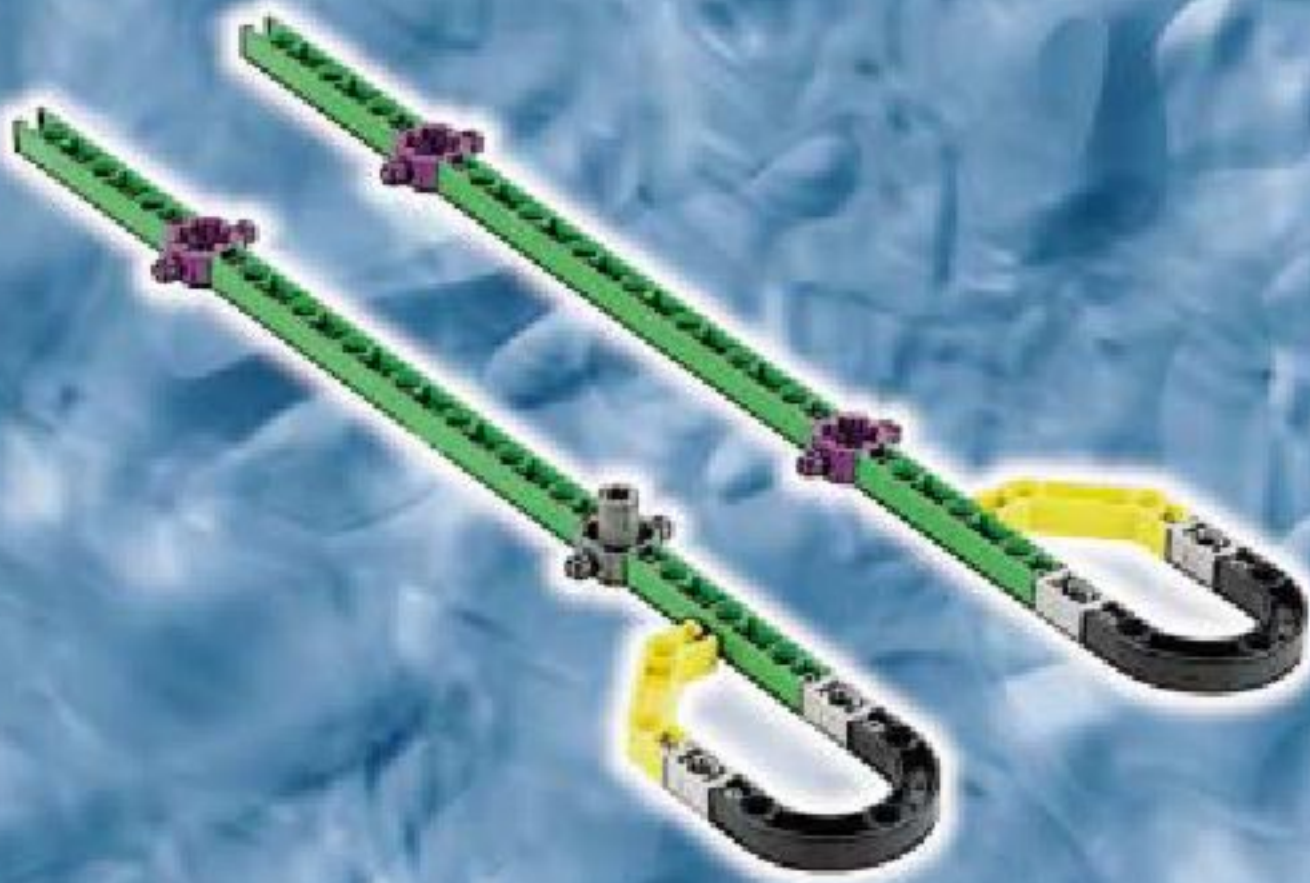

3

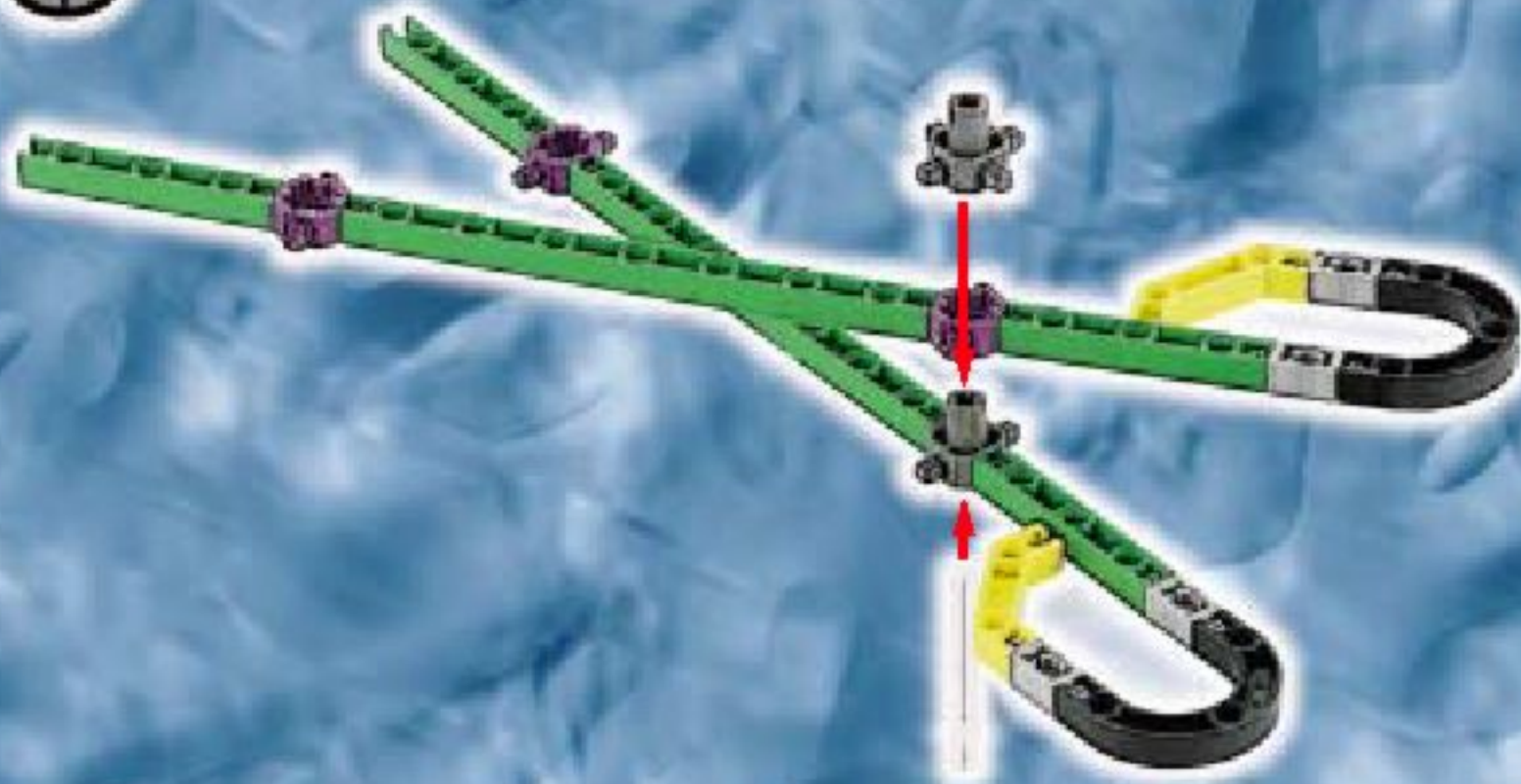

4

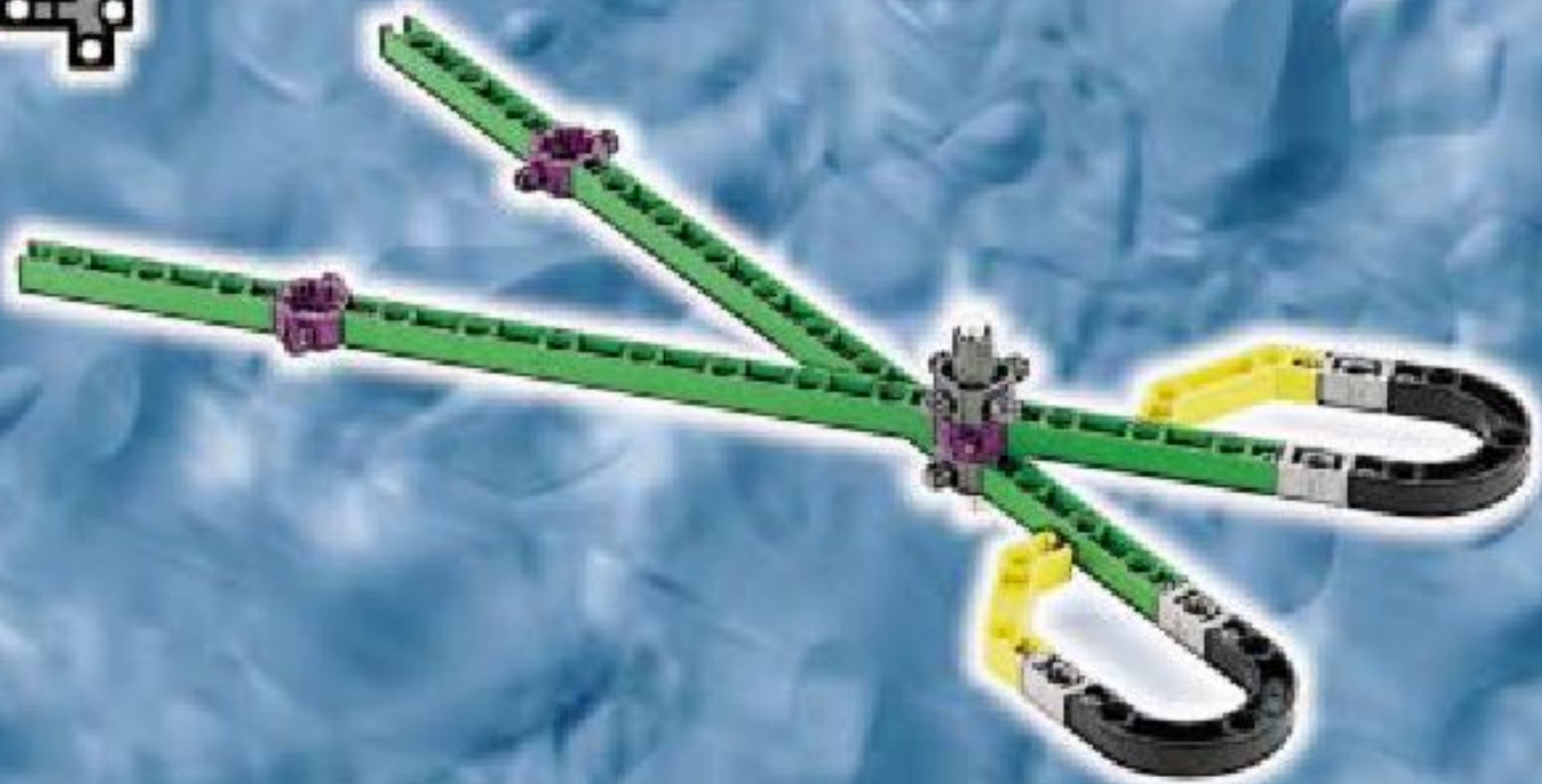



1



2

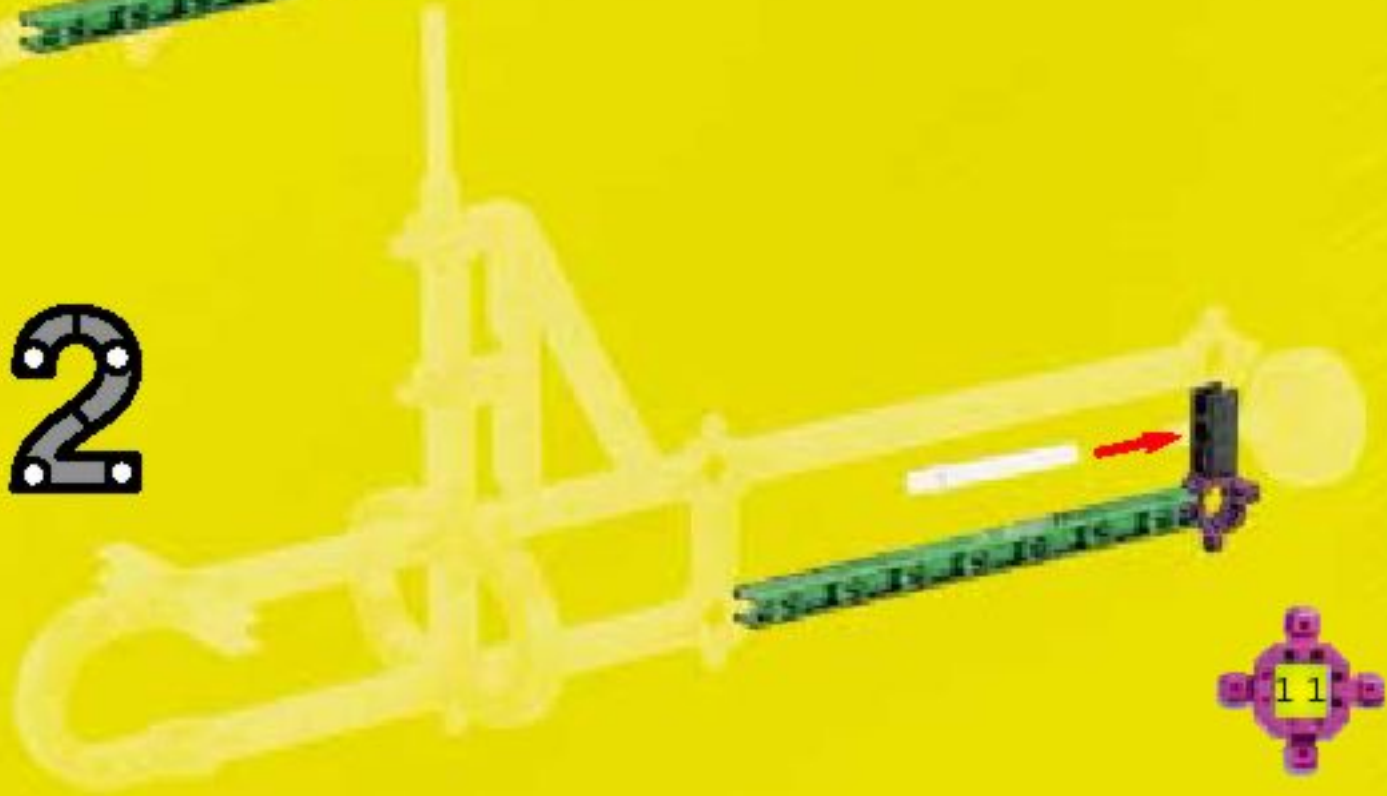

3



4



5



6

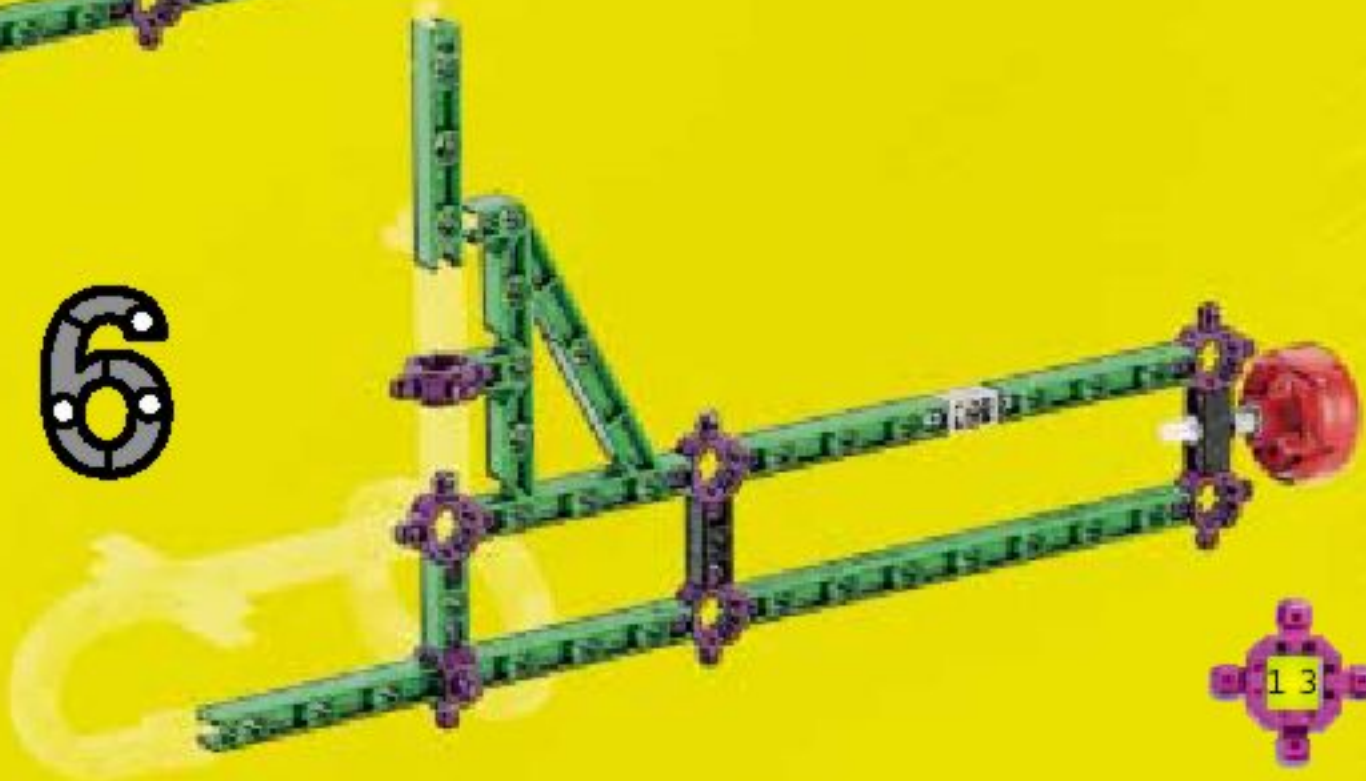

7

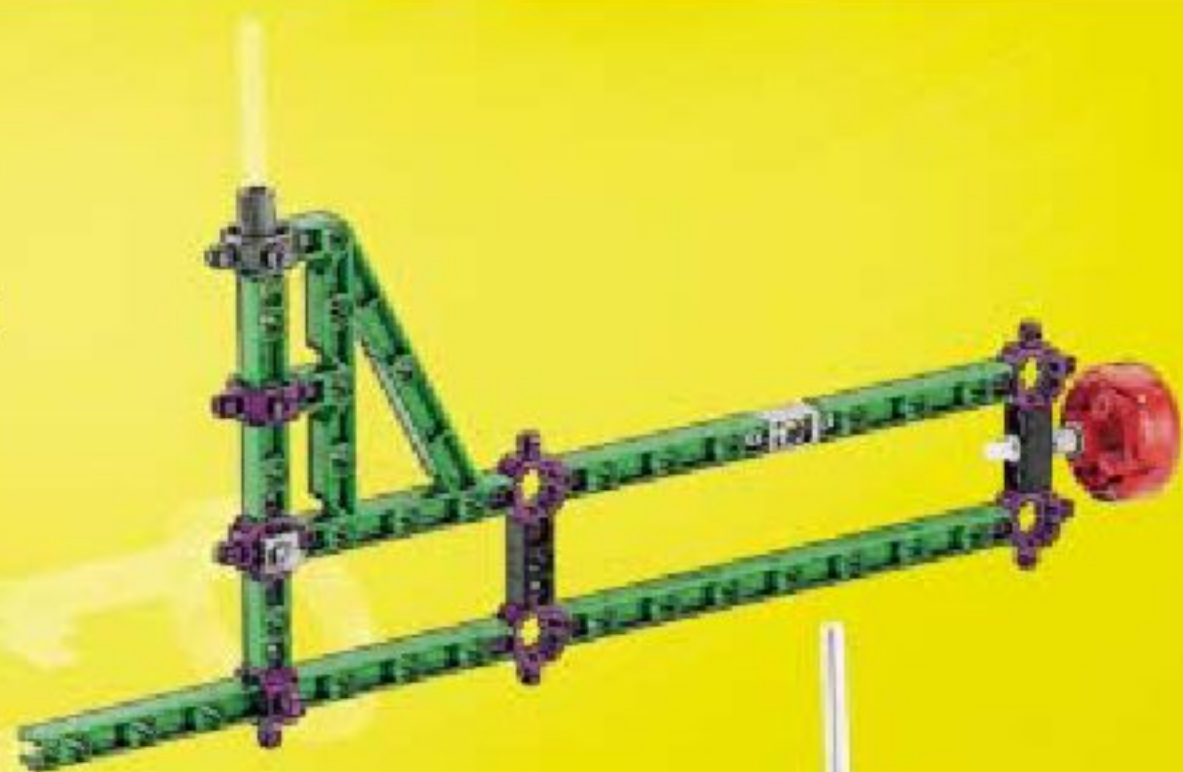

8



9



10



15



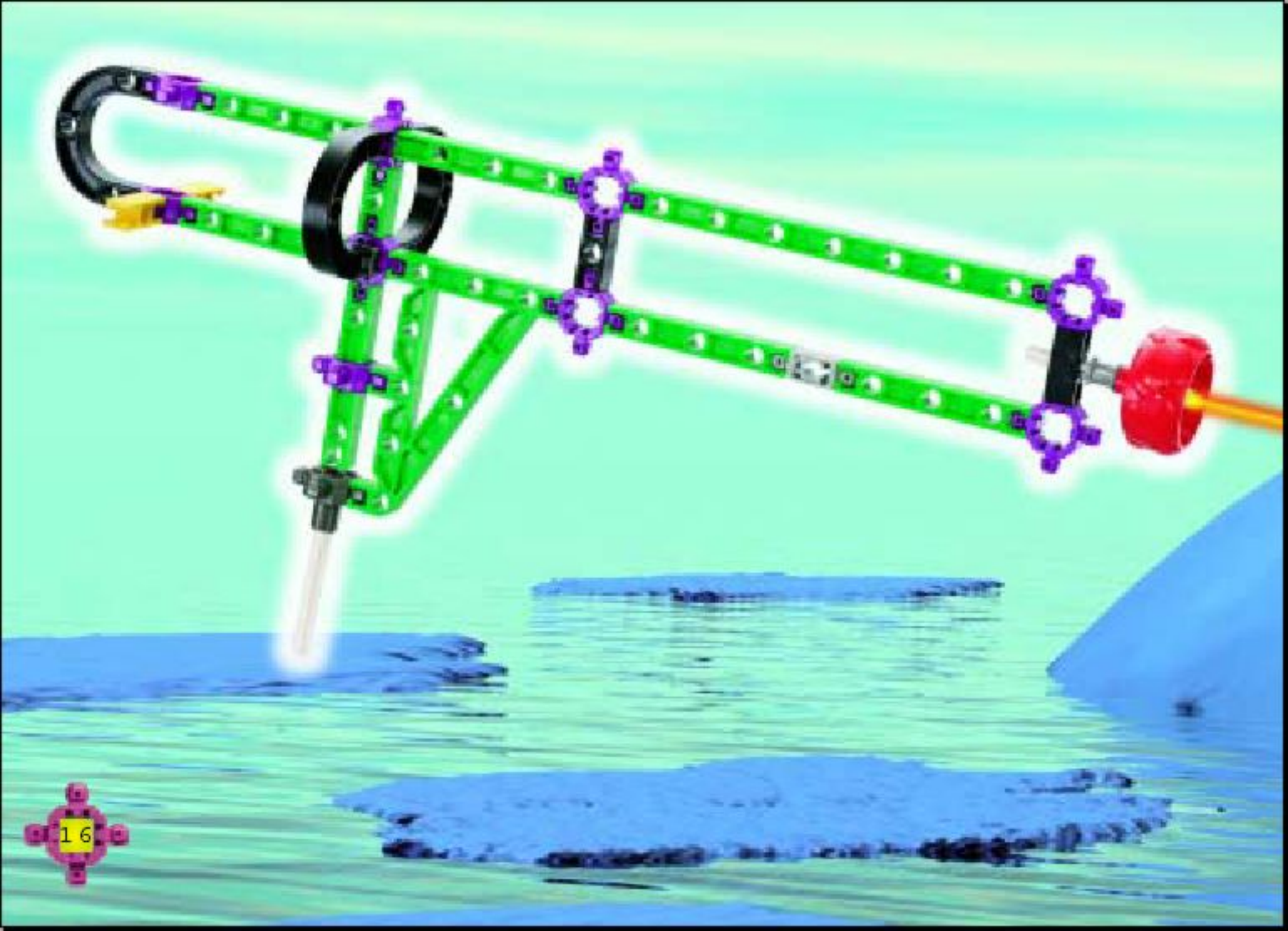





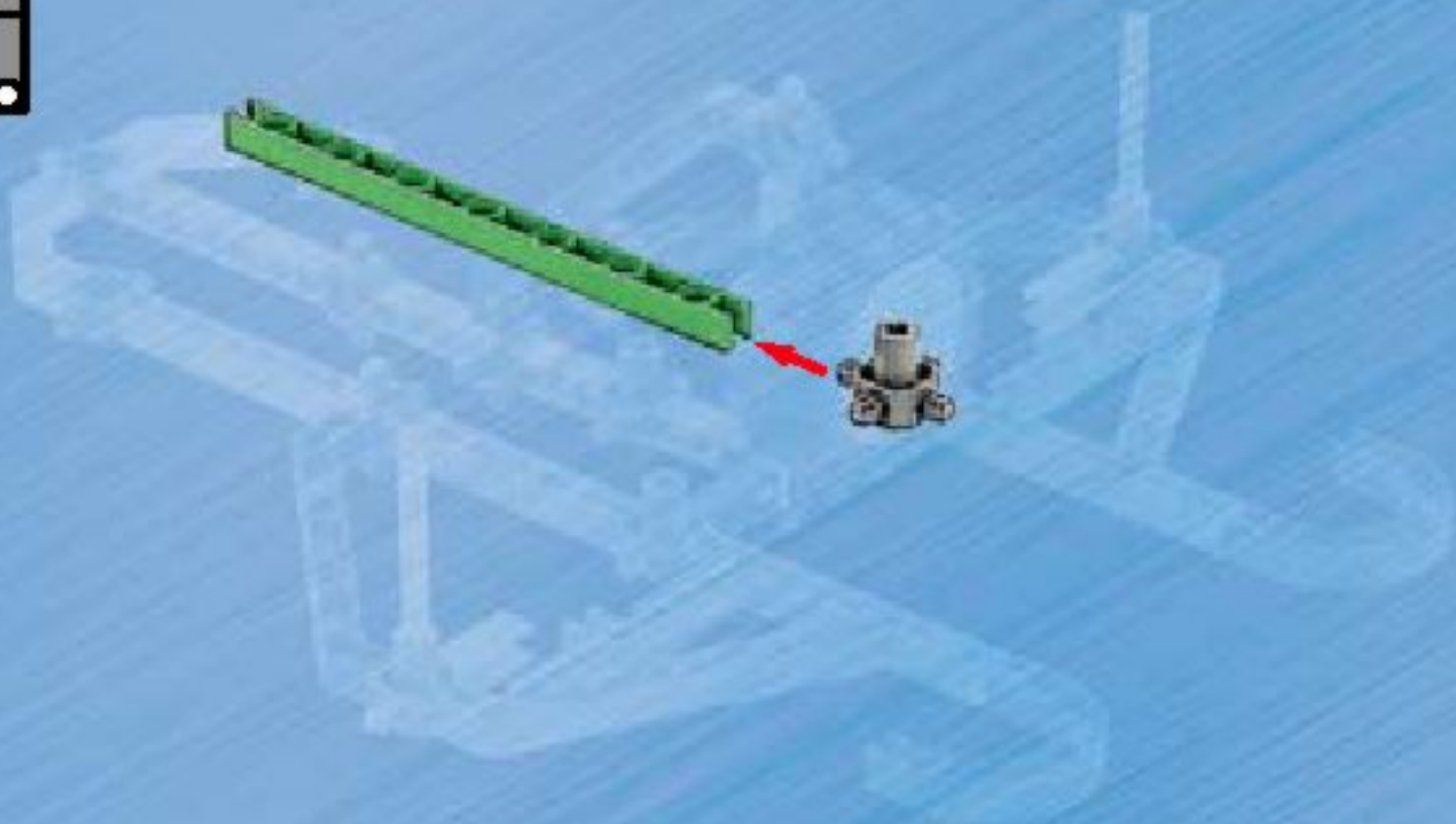

2

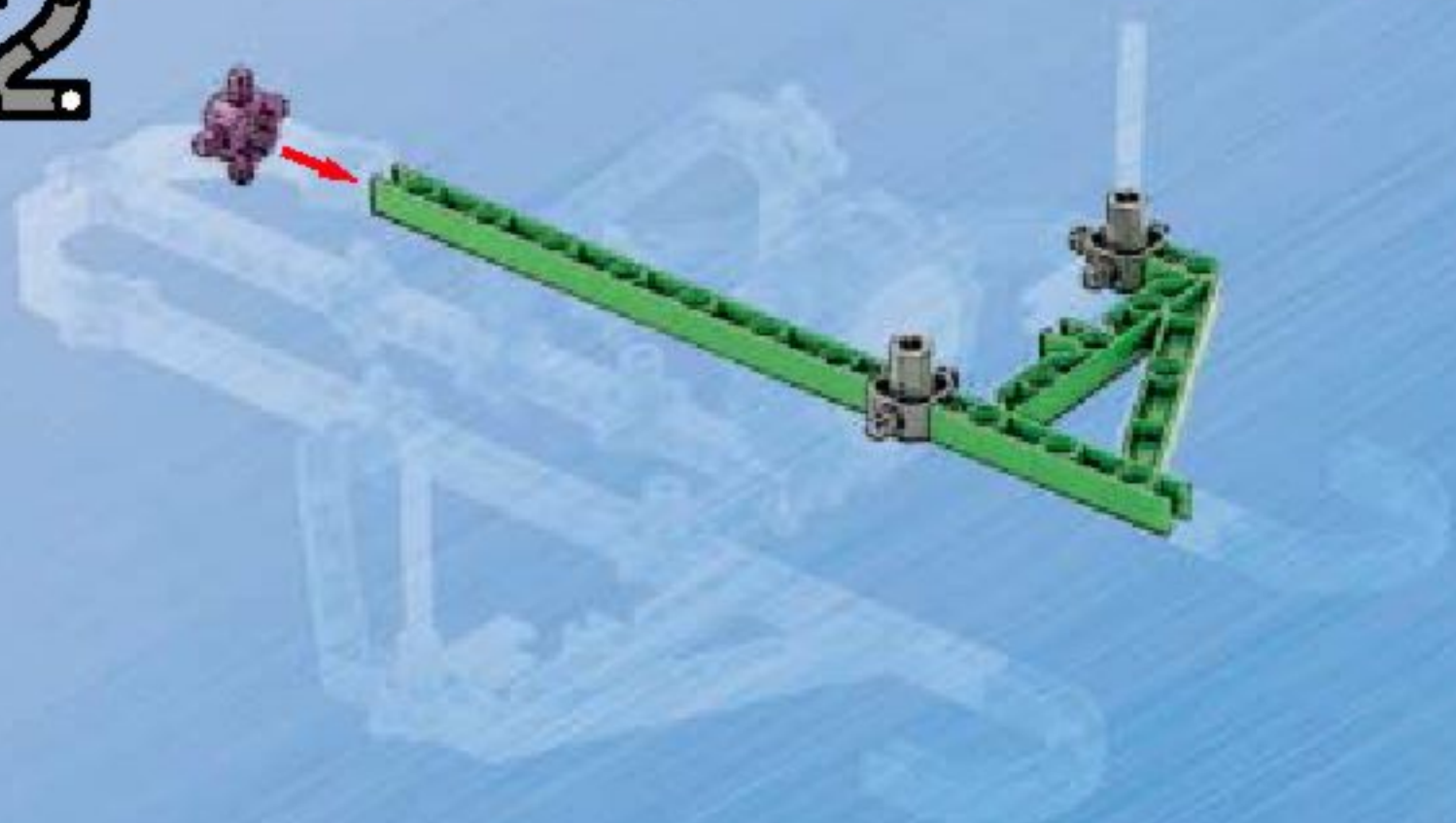

3

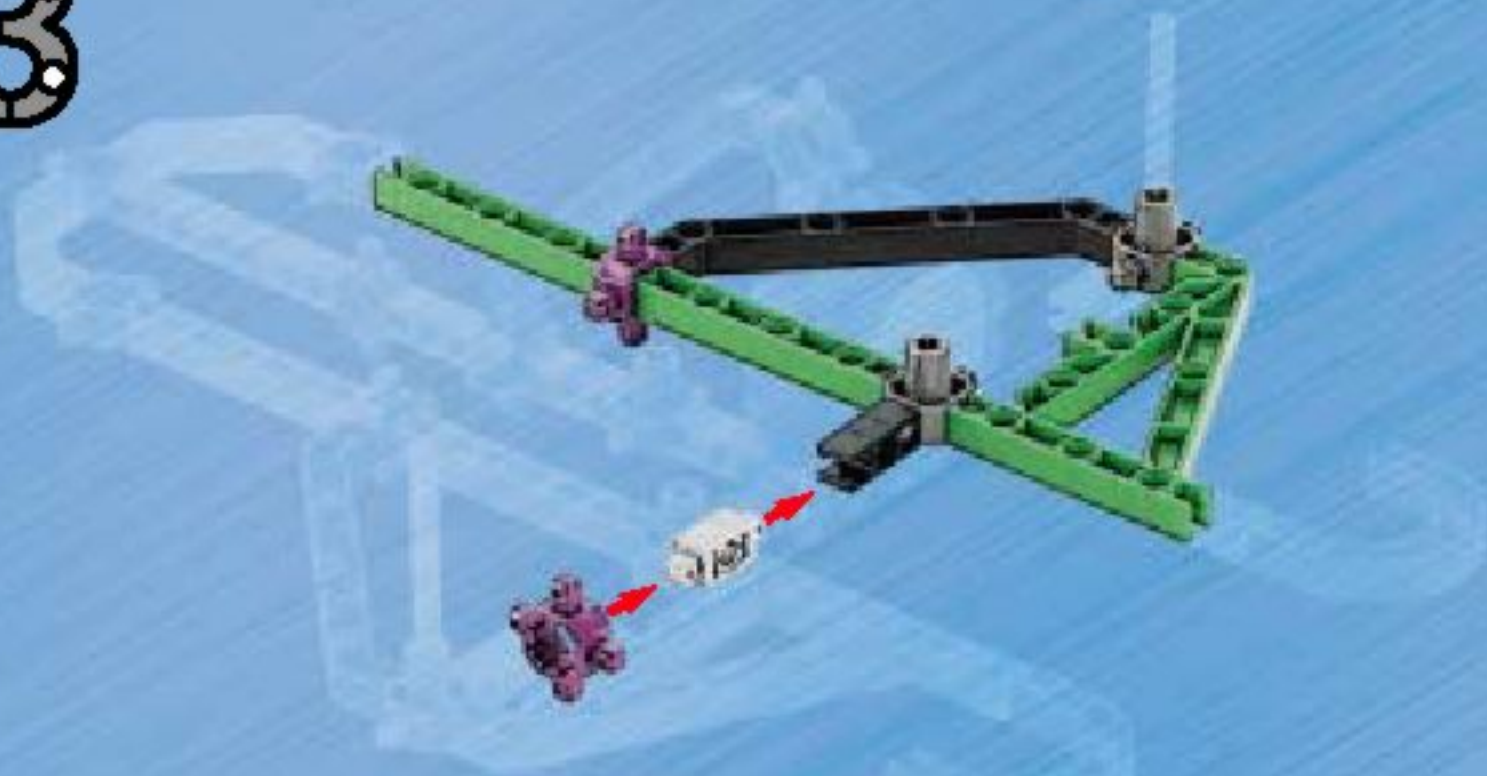

4



5



7



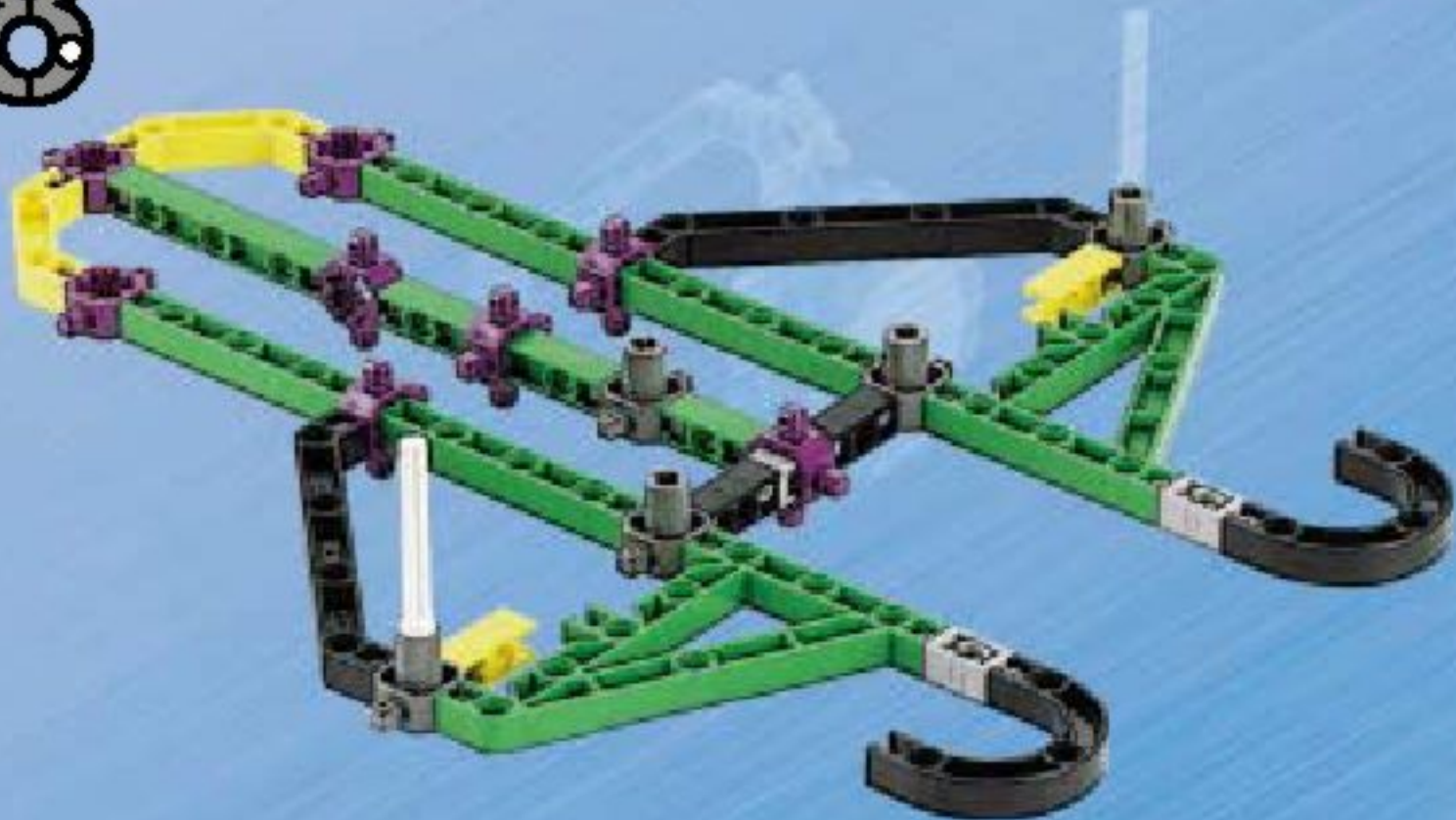

9

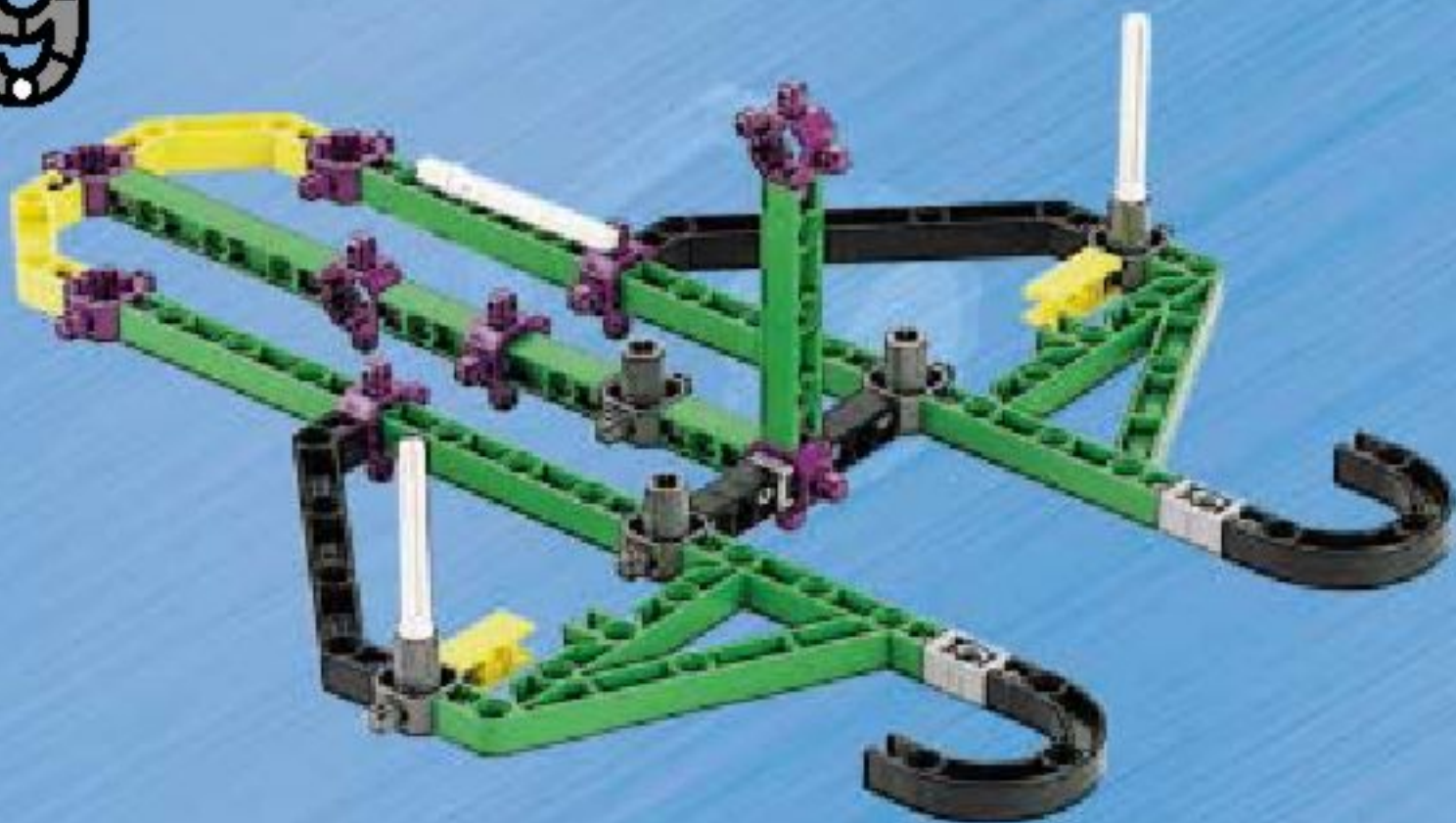

10

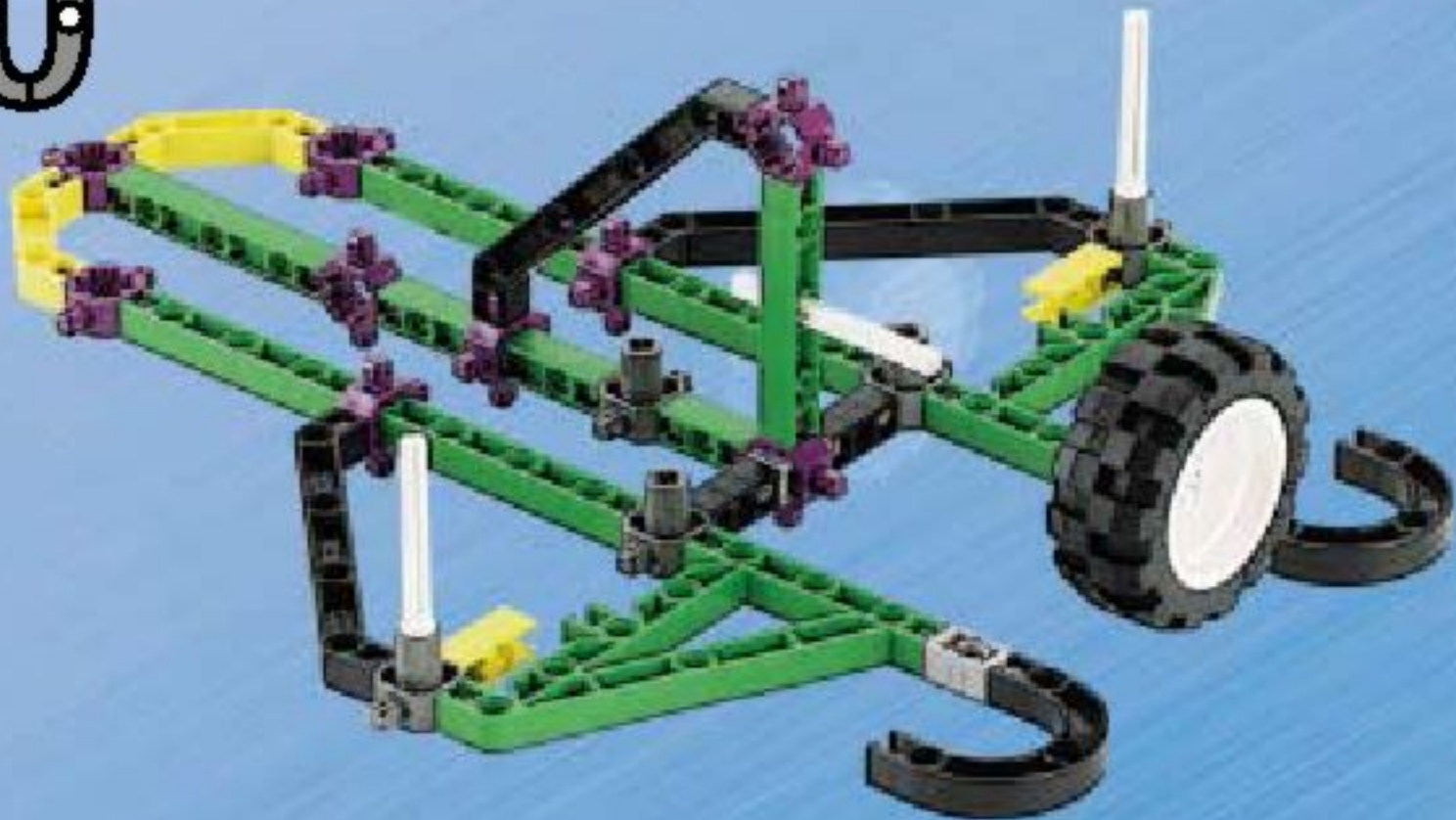

11



TRANS  FORM



2



3





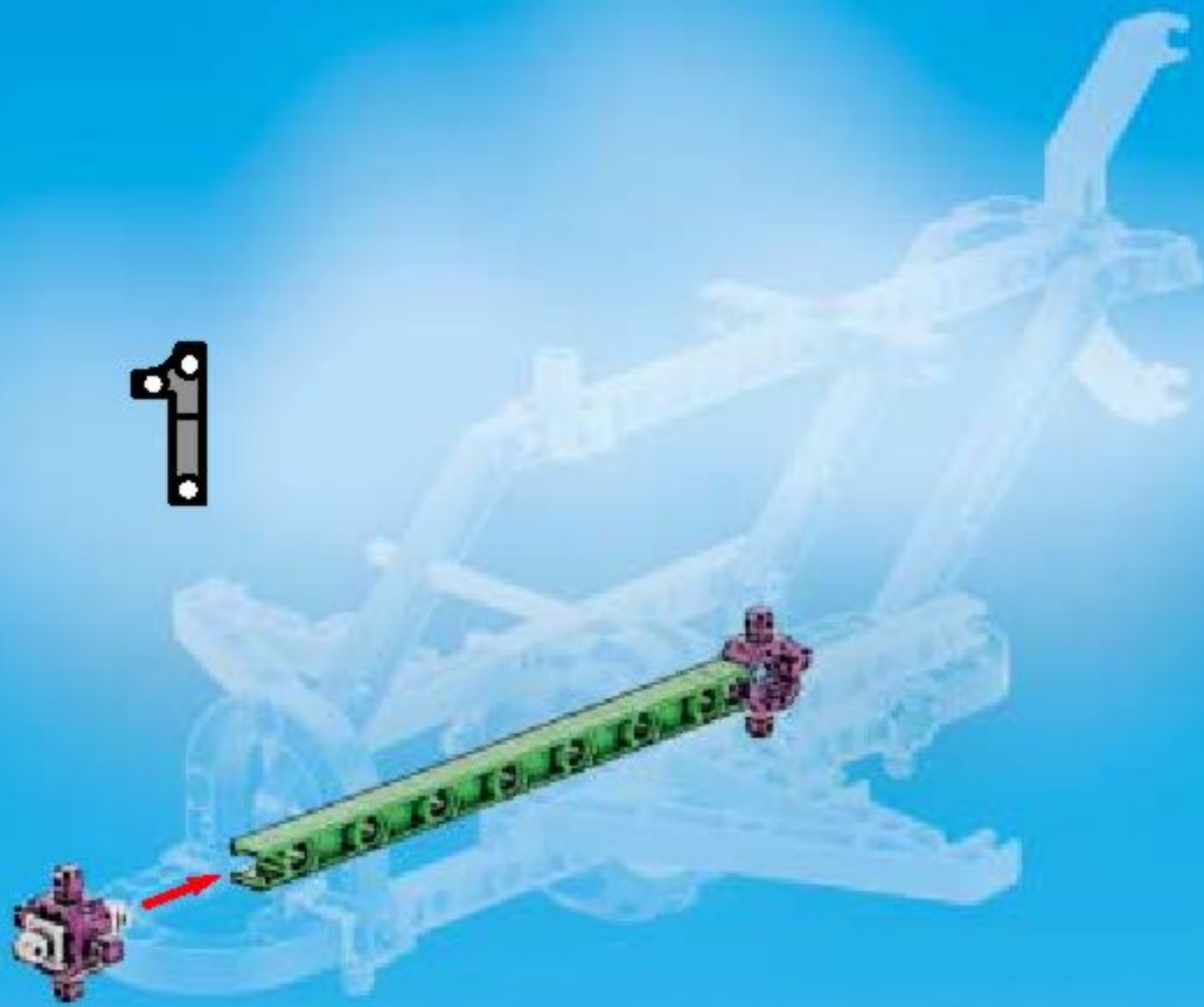

2

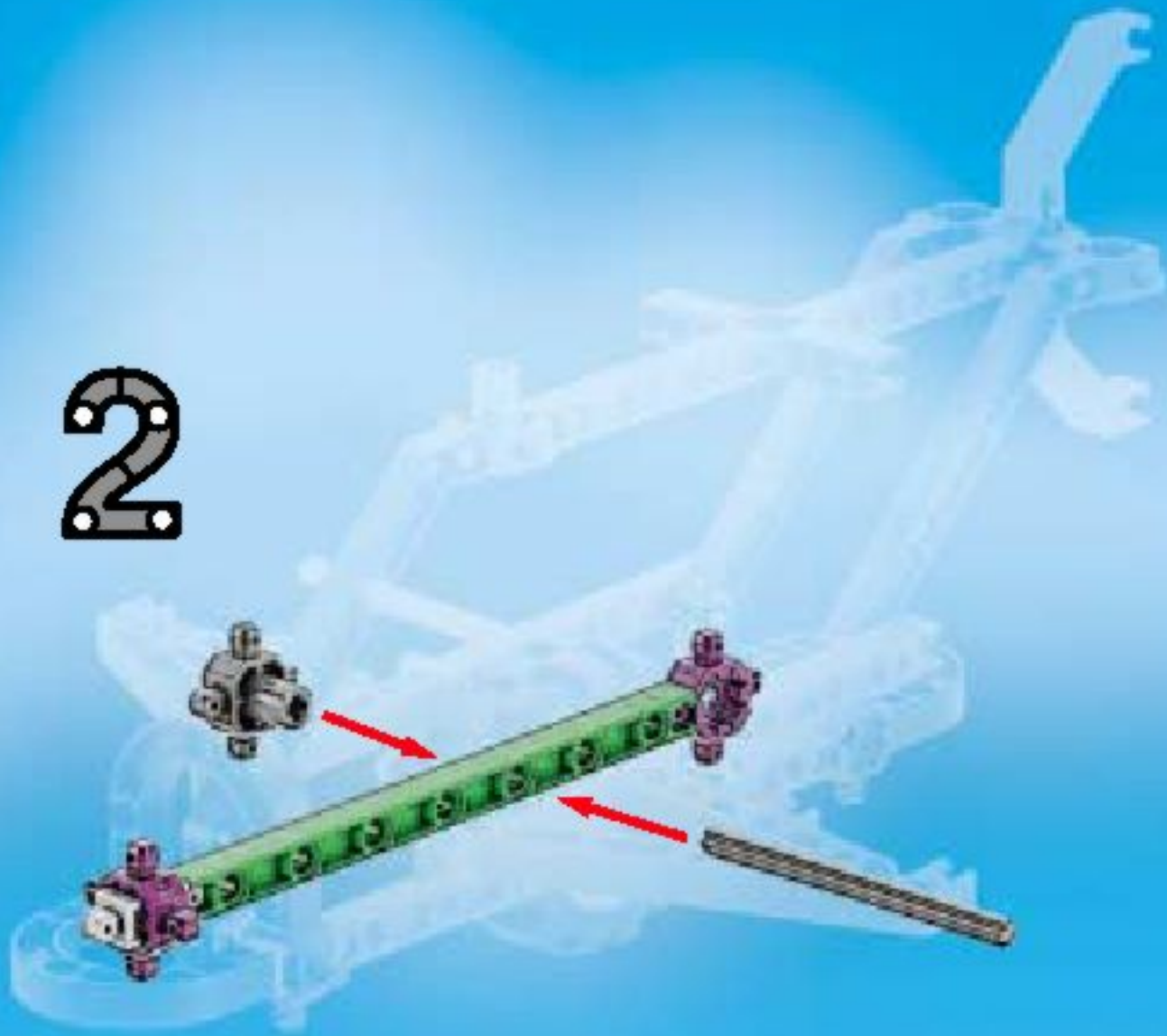

3



4



5



6



7





9



10



11



12



13



14



15



16



17





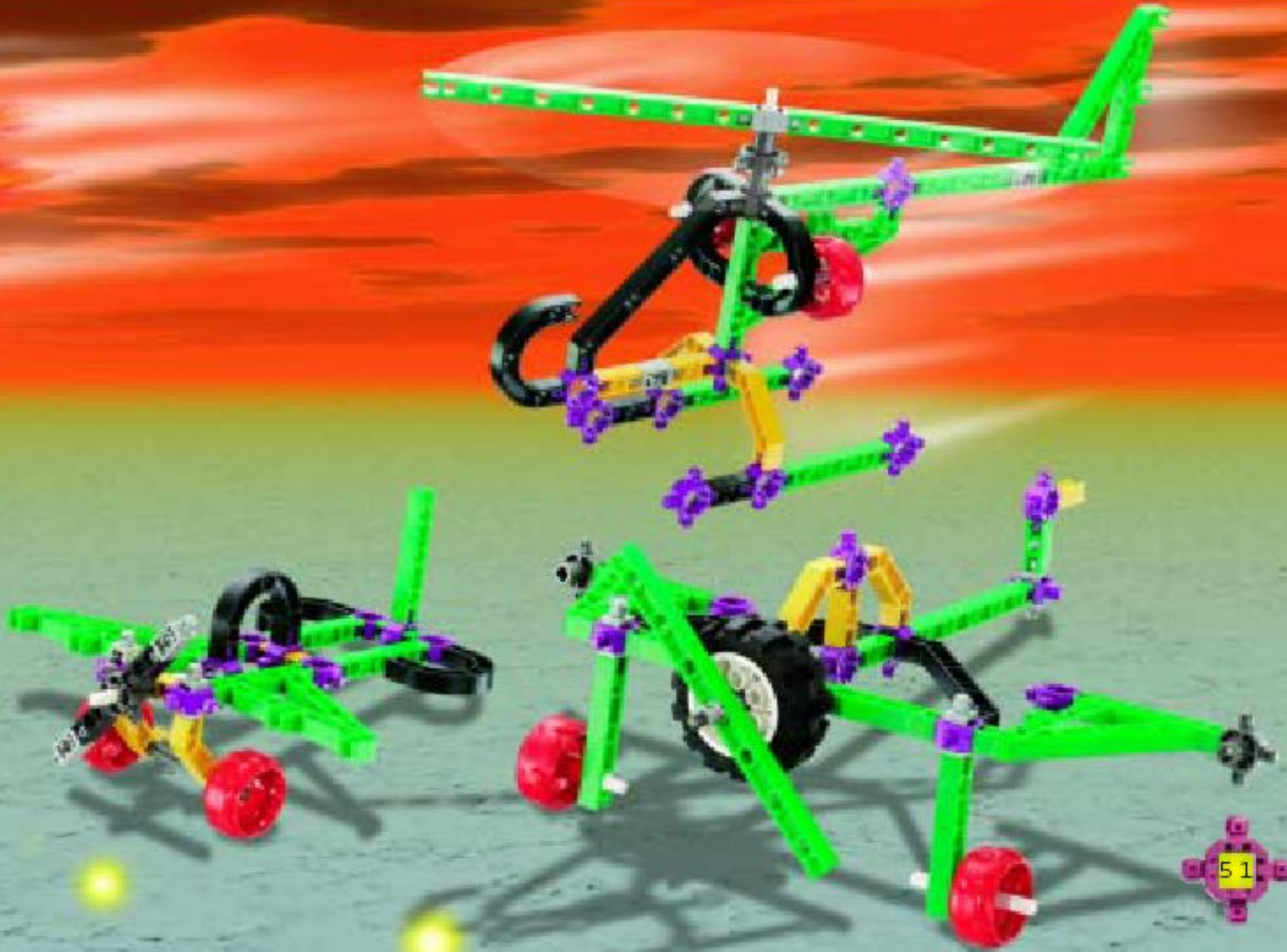

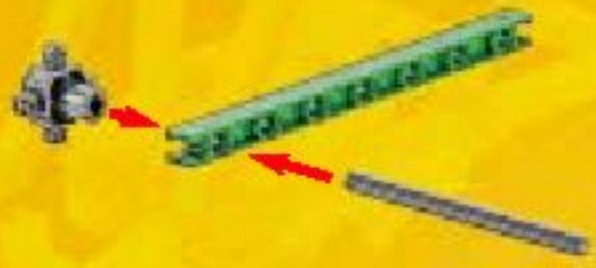
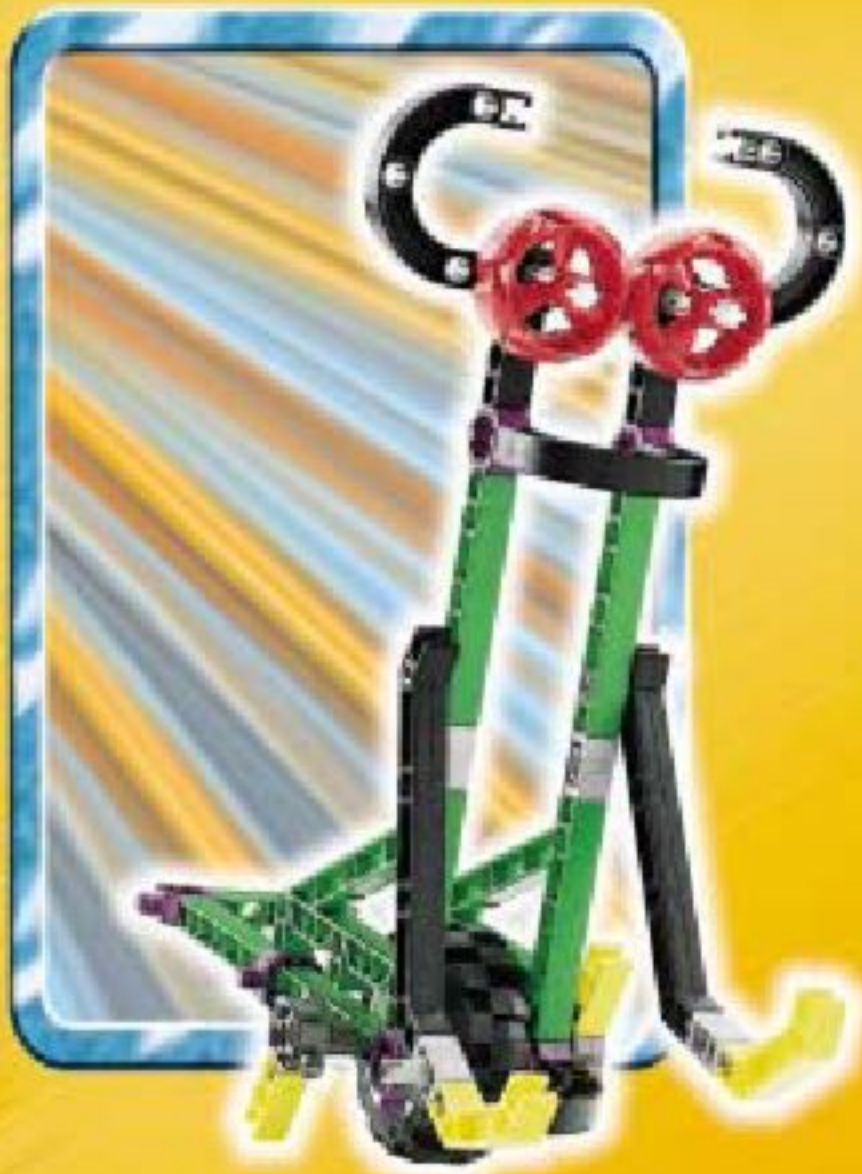

2



3



4



5



6



7





10



11



12



13



14



15



16









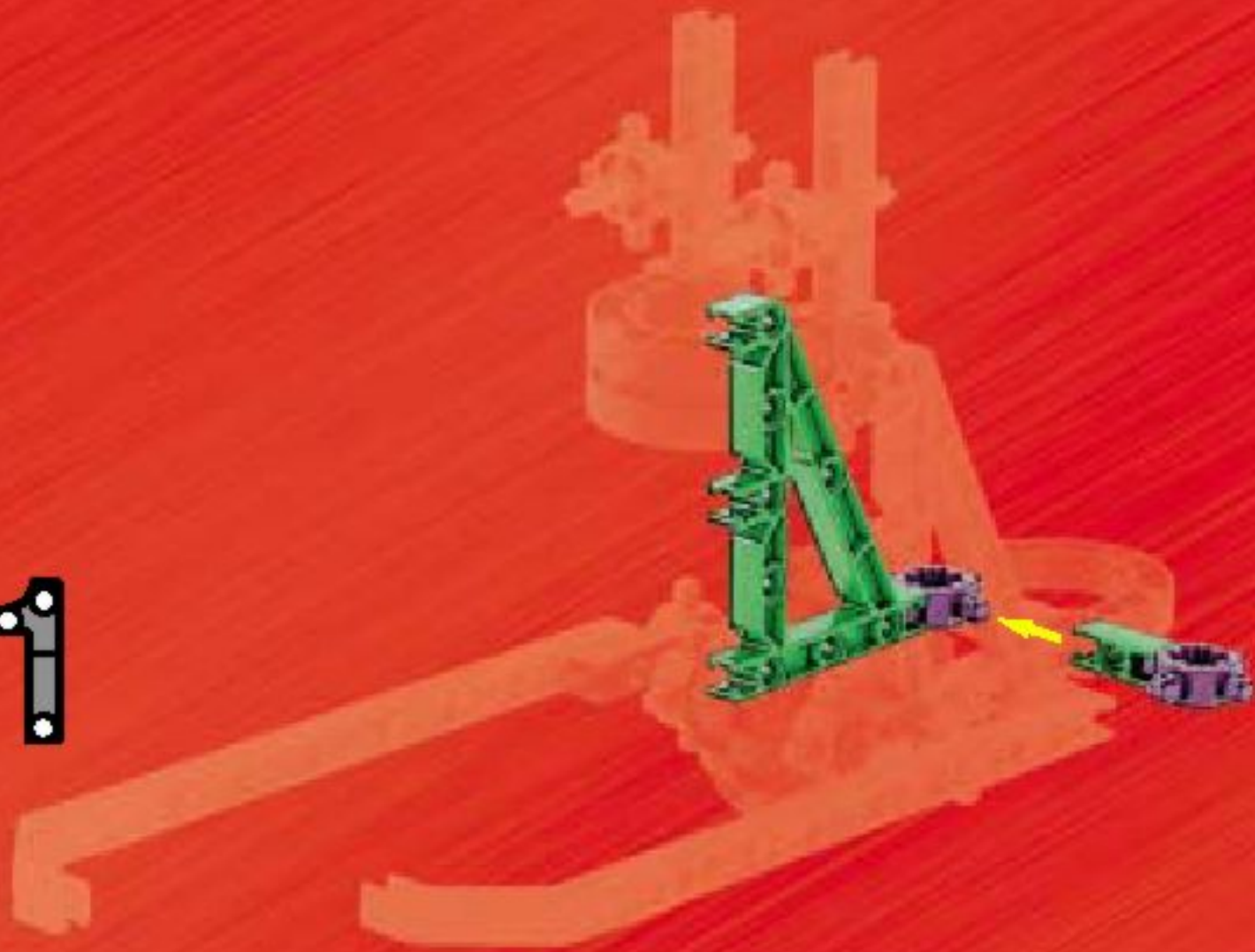

2



3



4



5

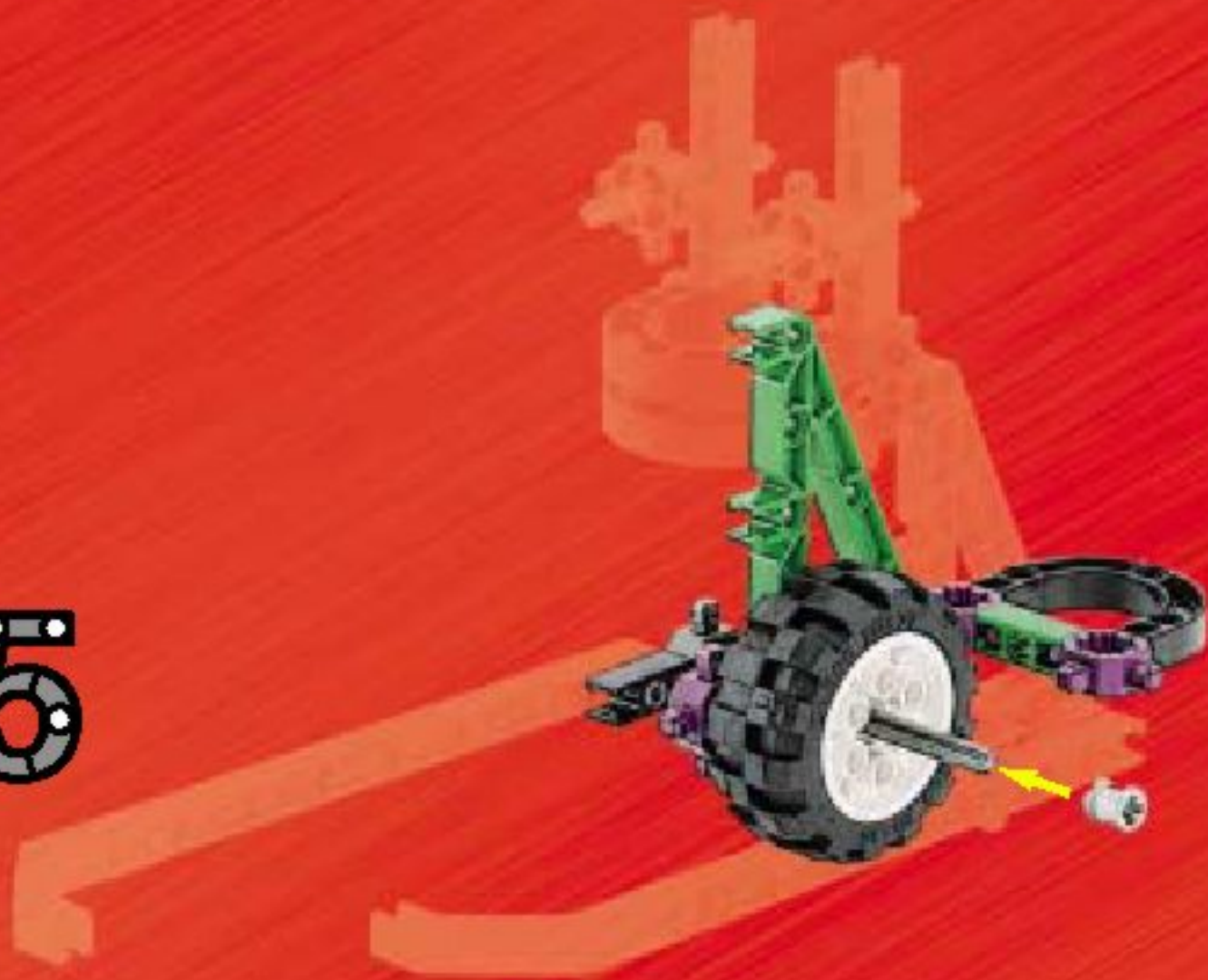

6



7

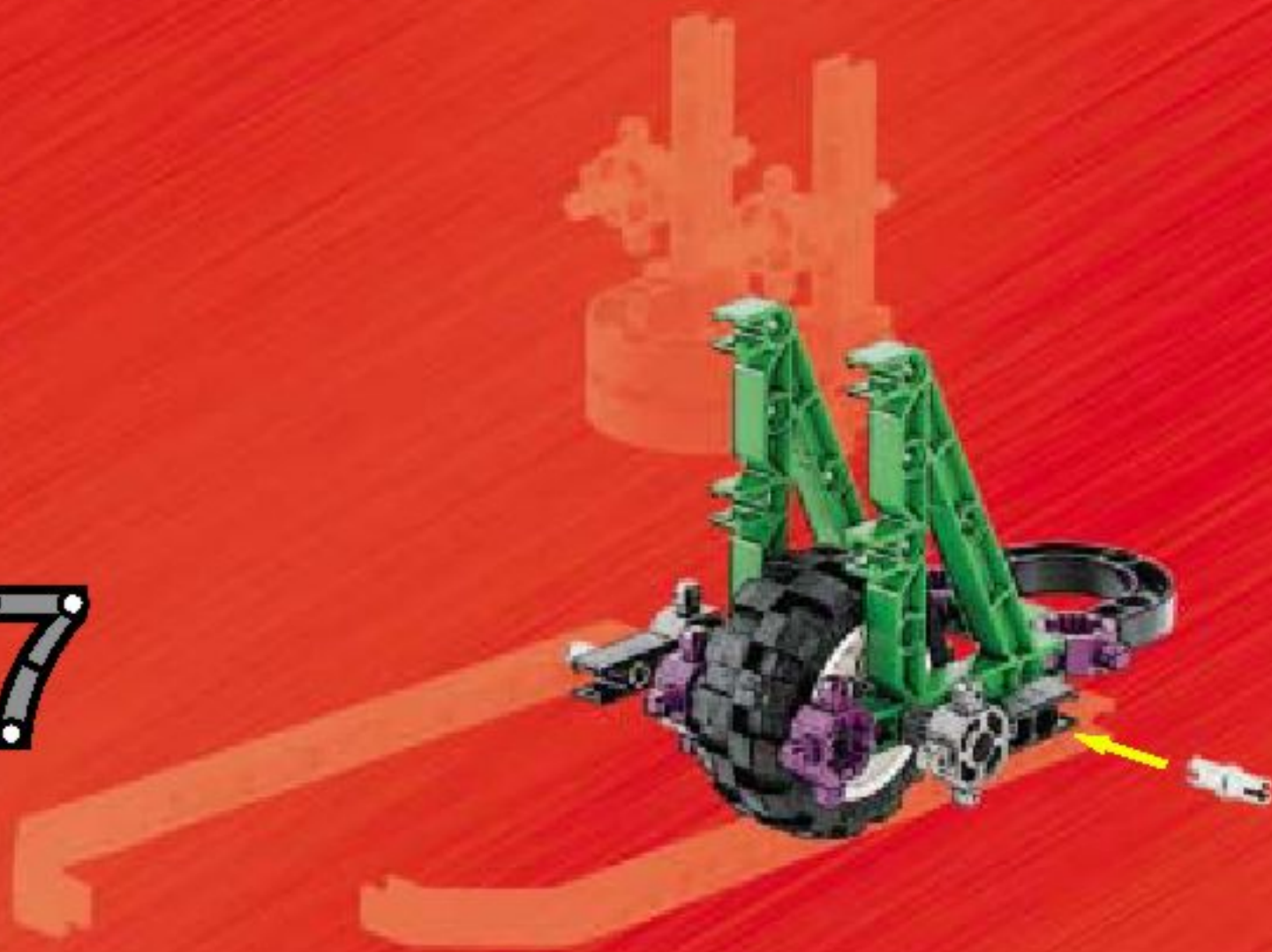

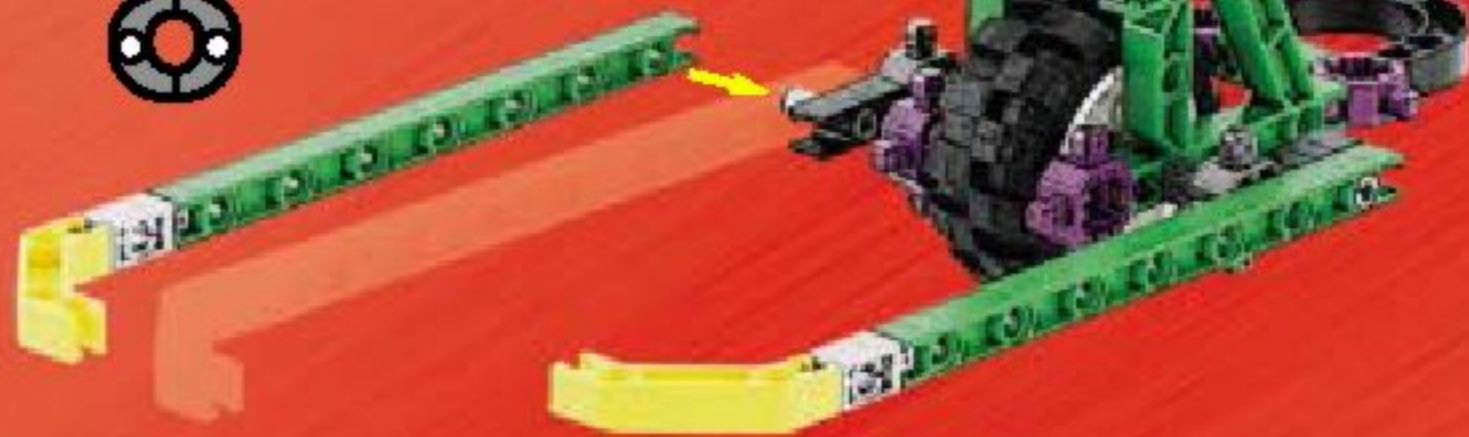

9



10



11



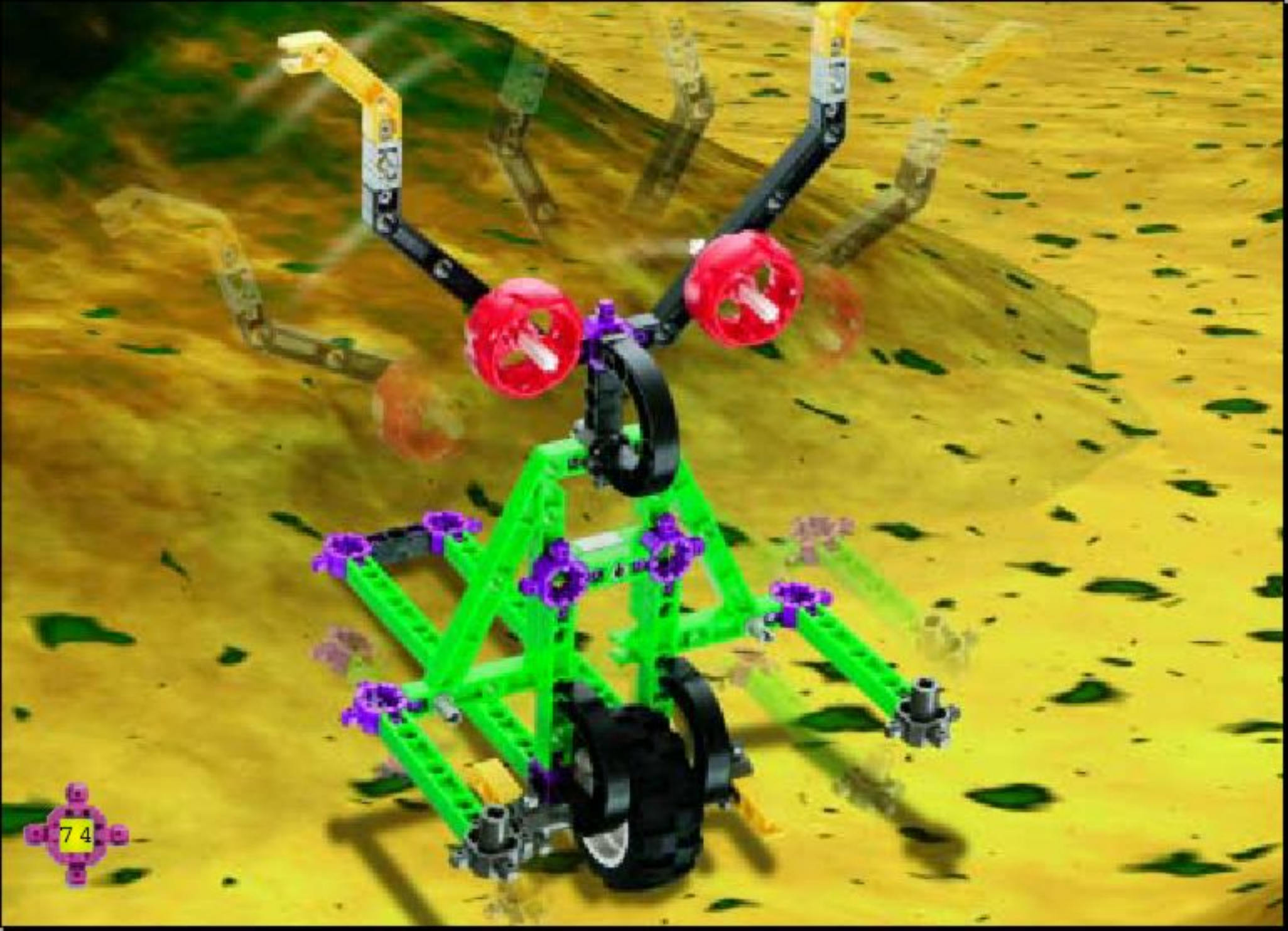





1

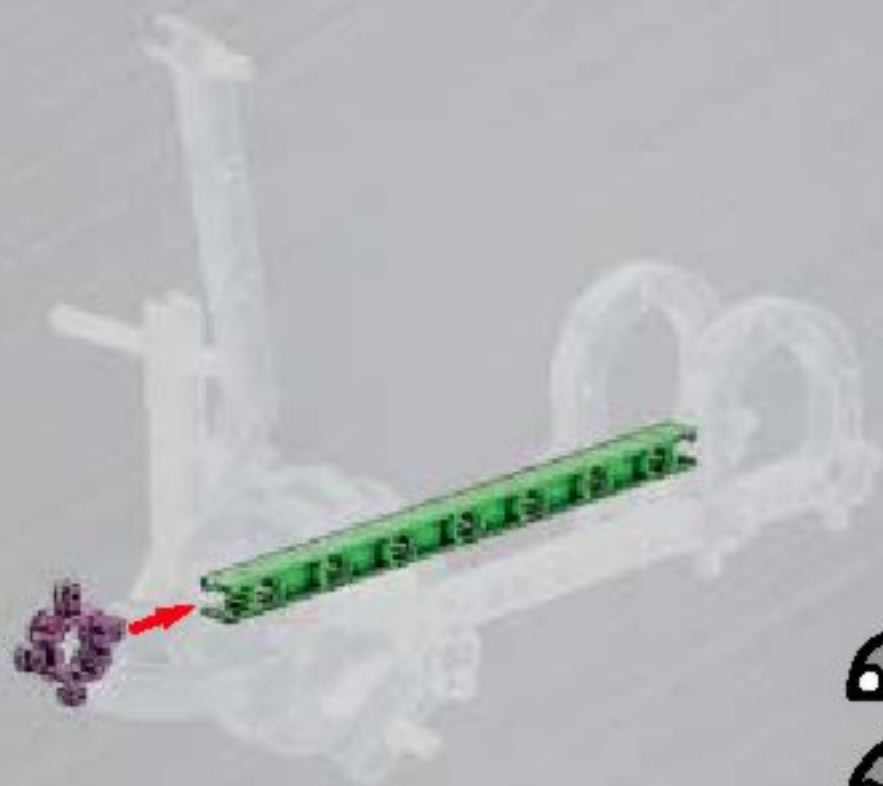

2

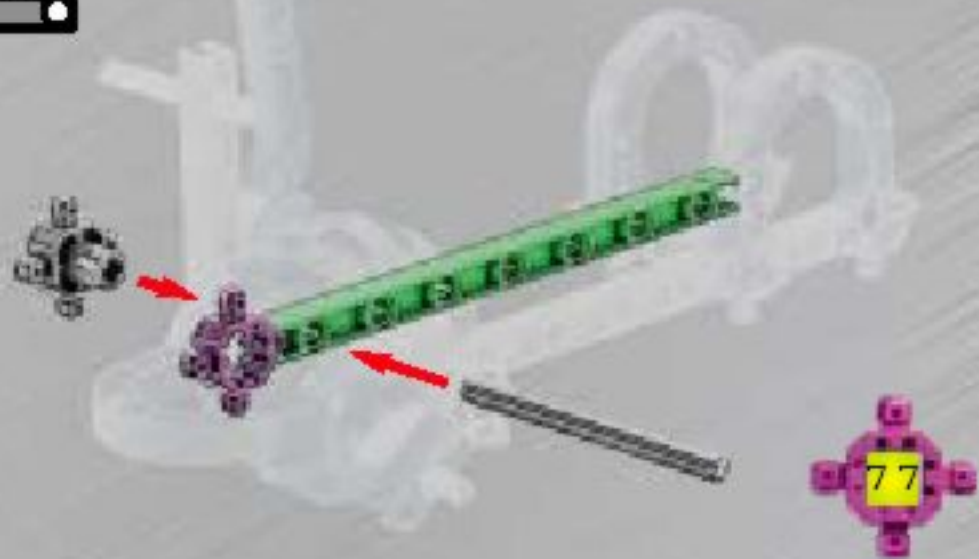

3



4

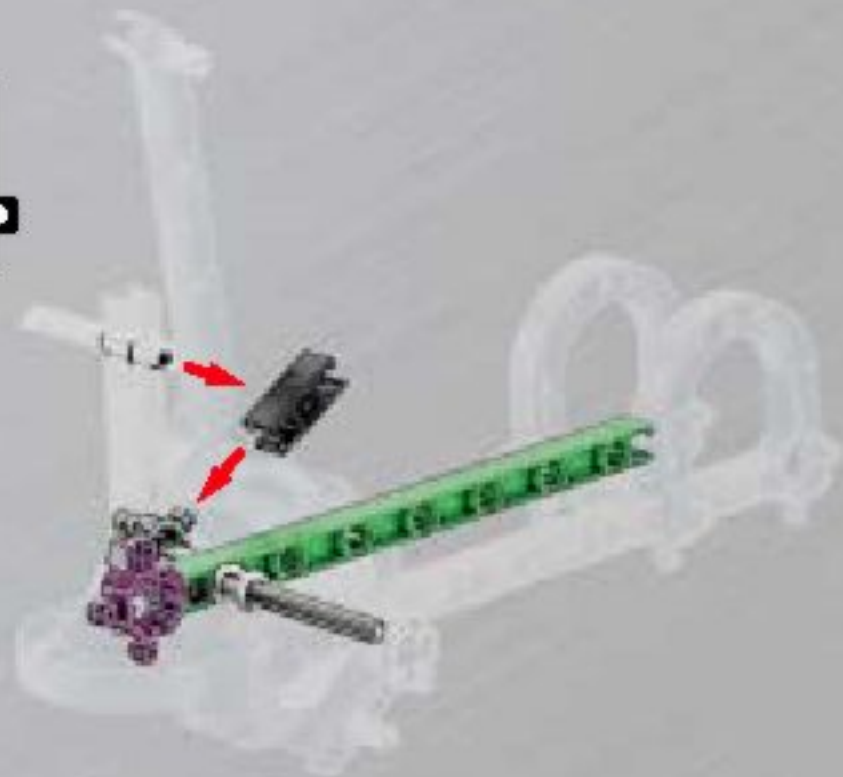

5

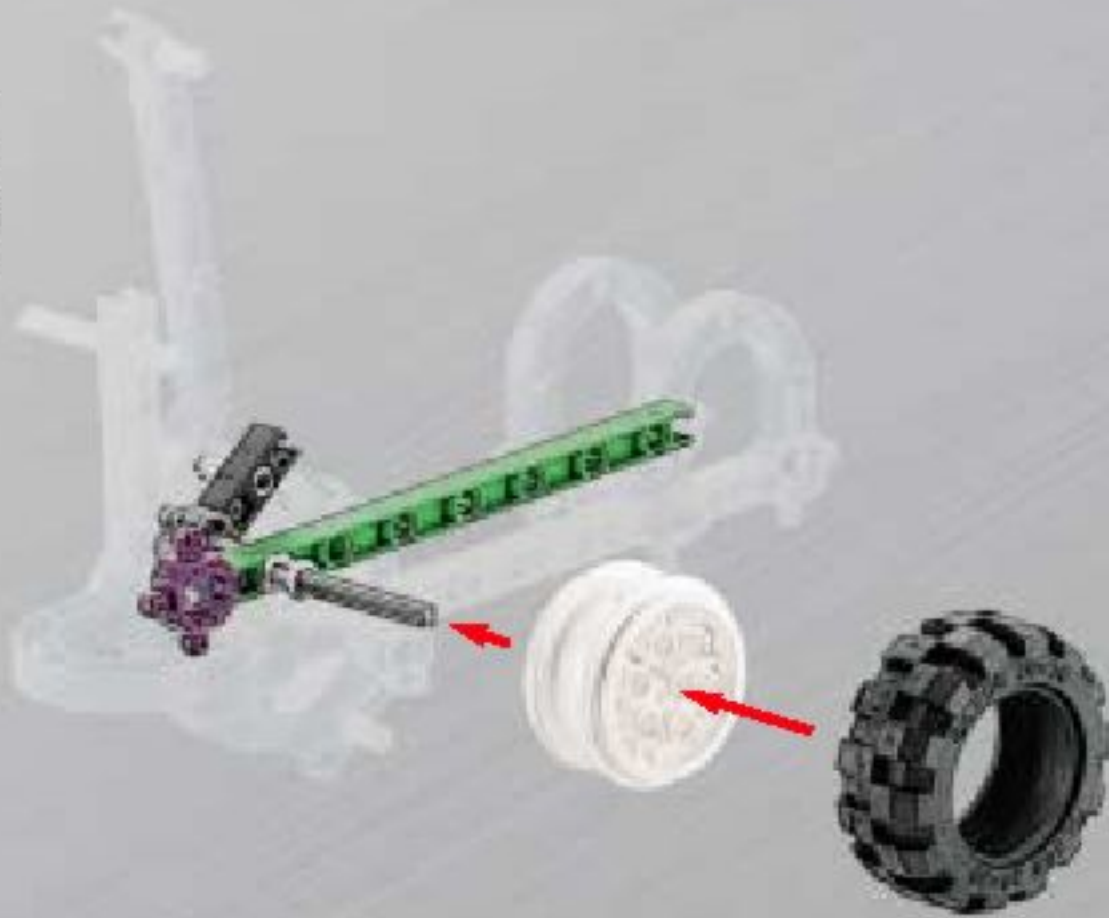

6

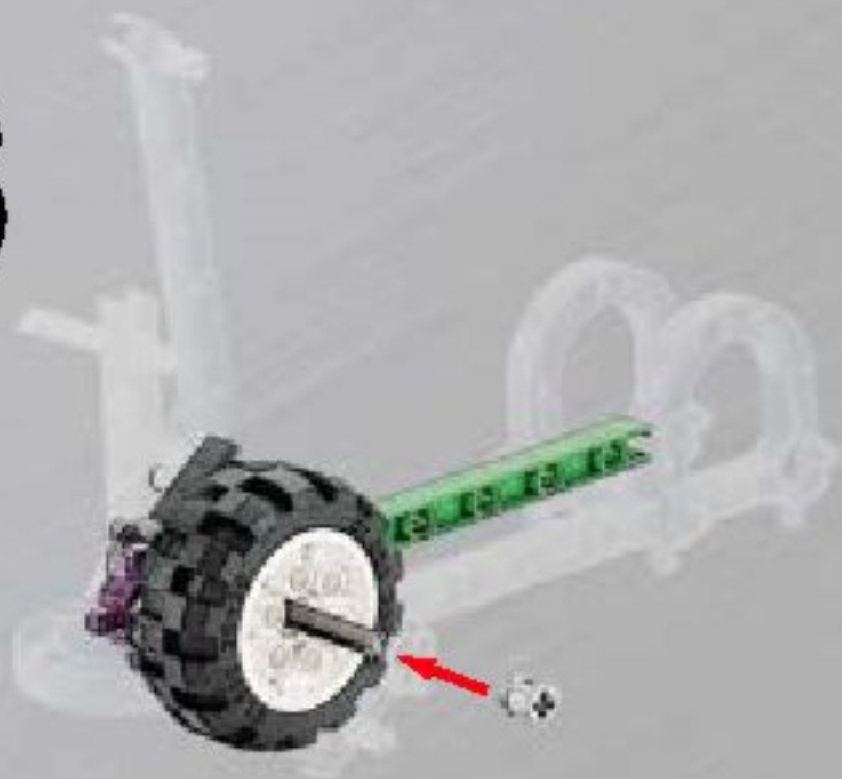

7

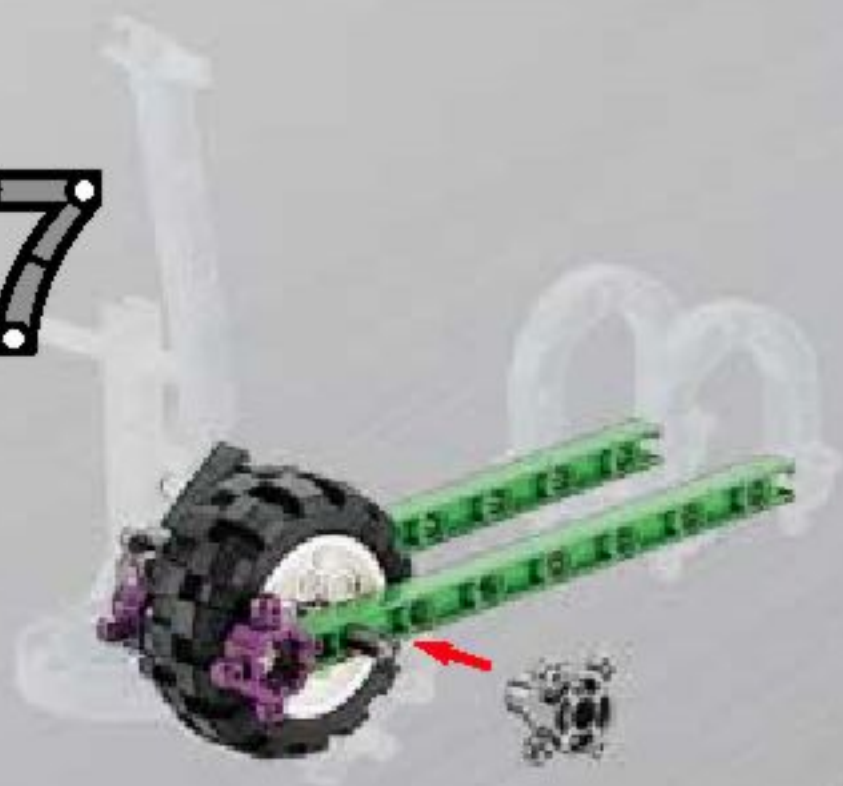





10



11



12

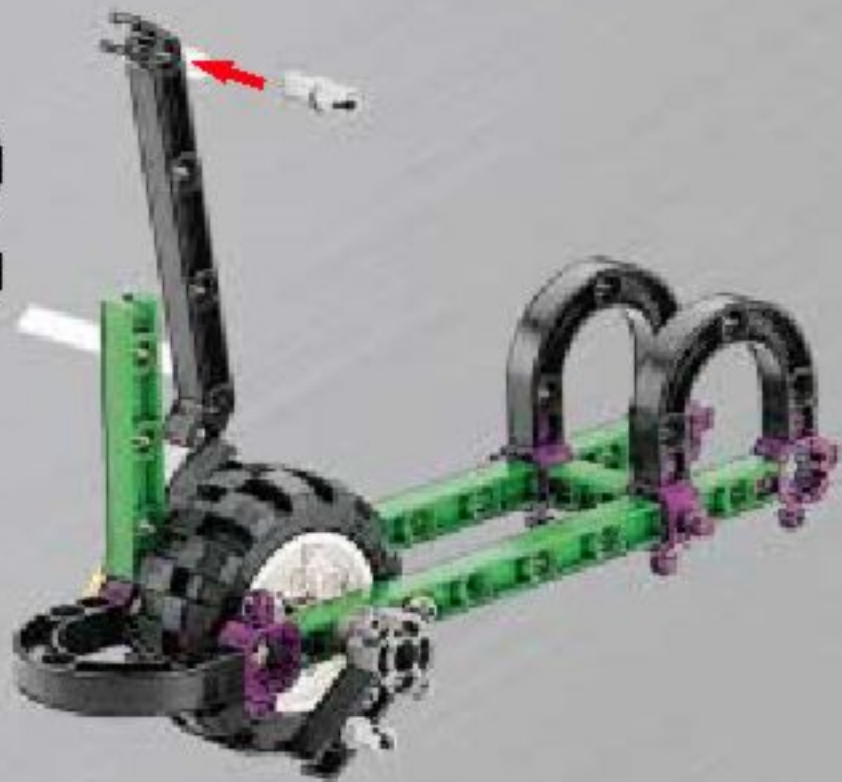

13



14



15



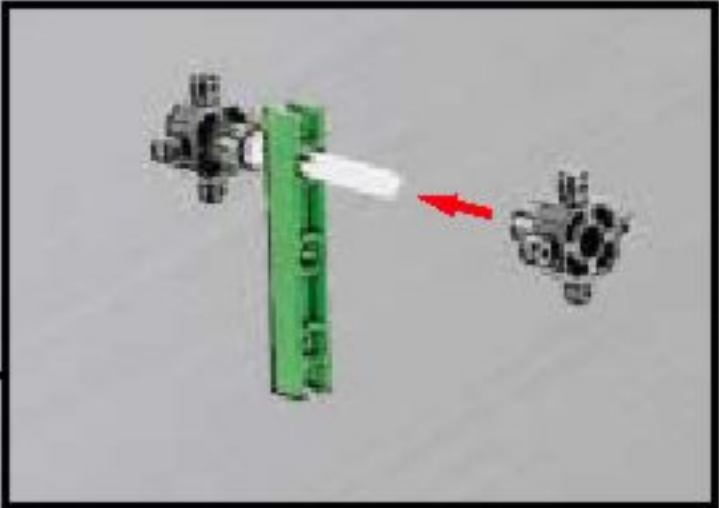

16



17

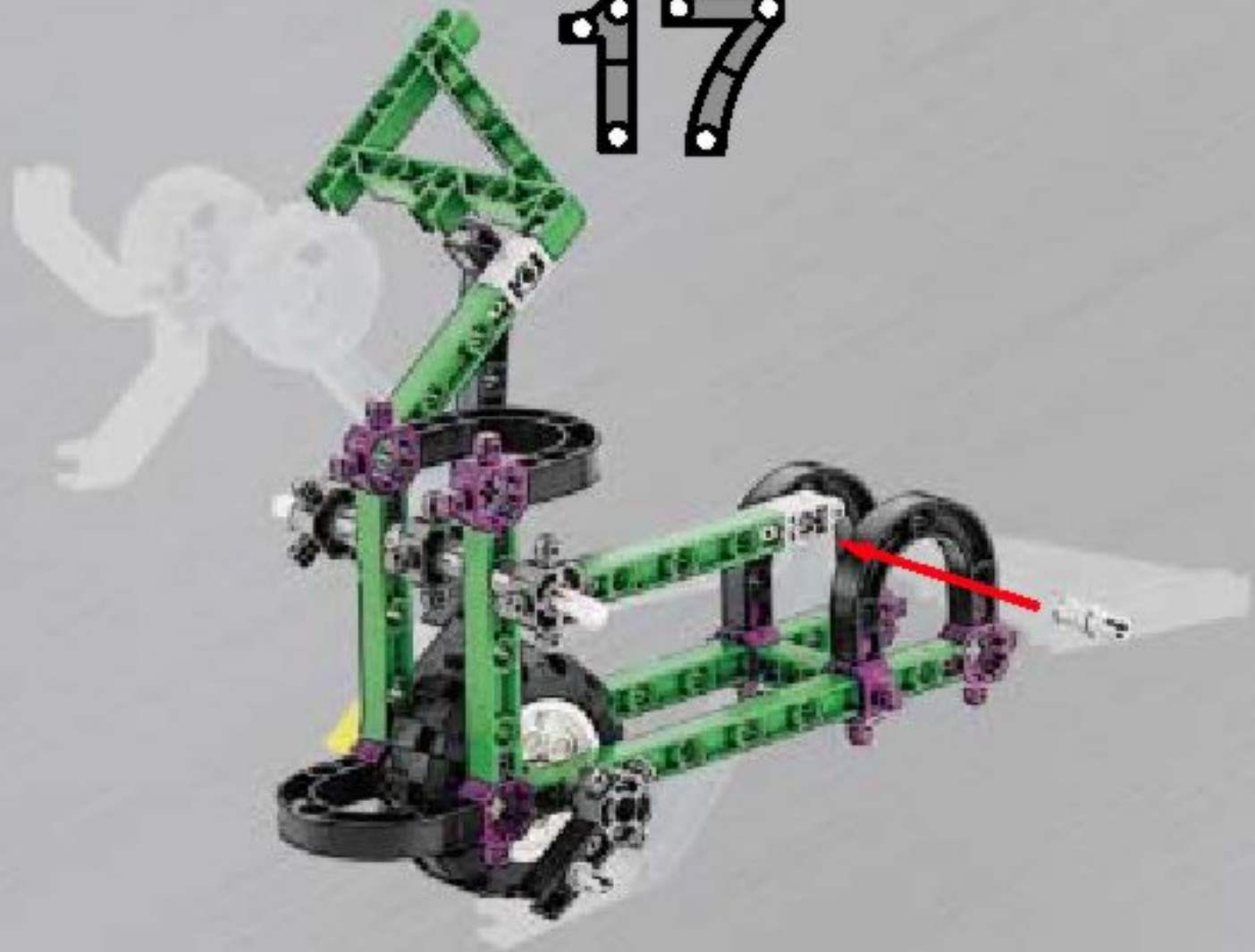

18



19



20



21

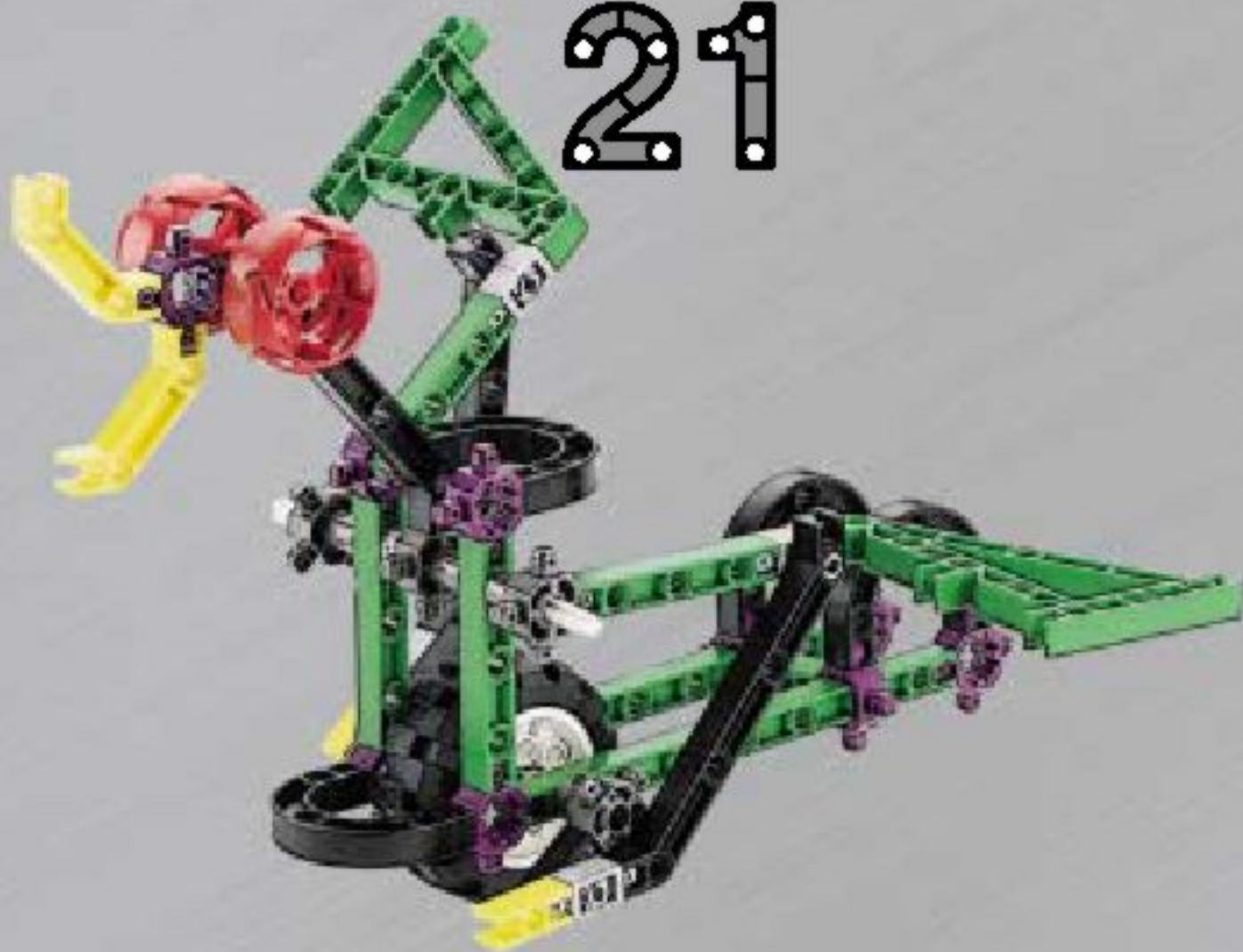

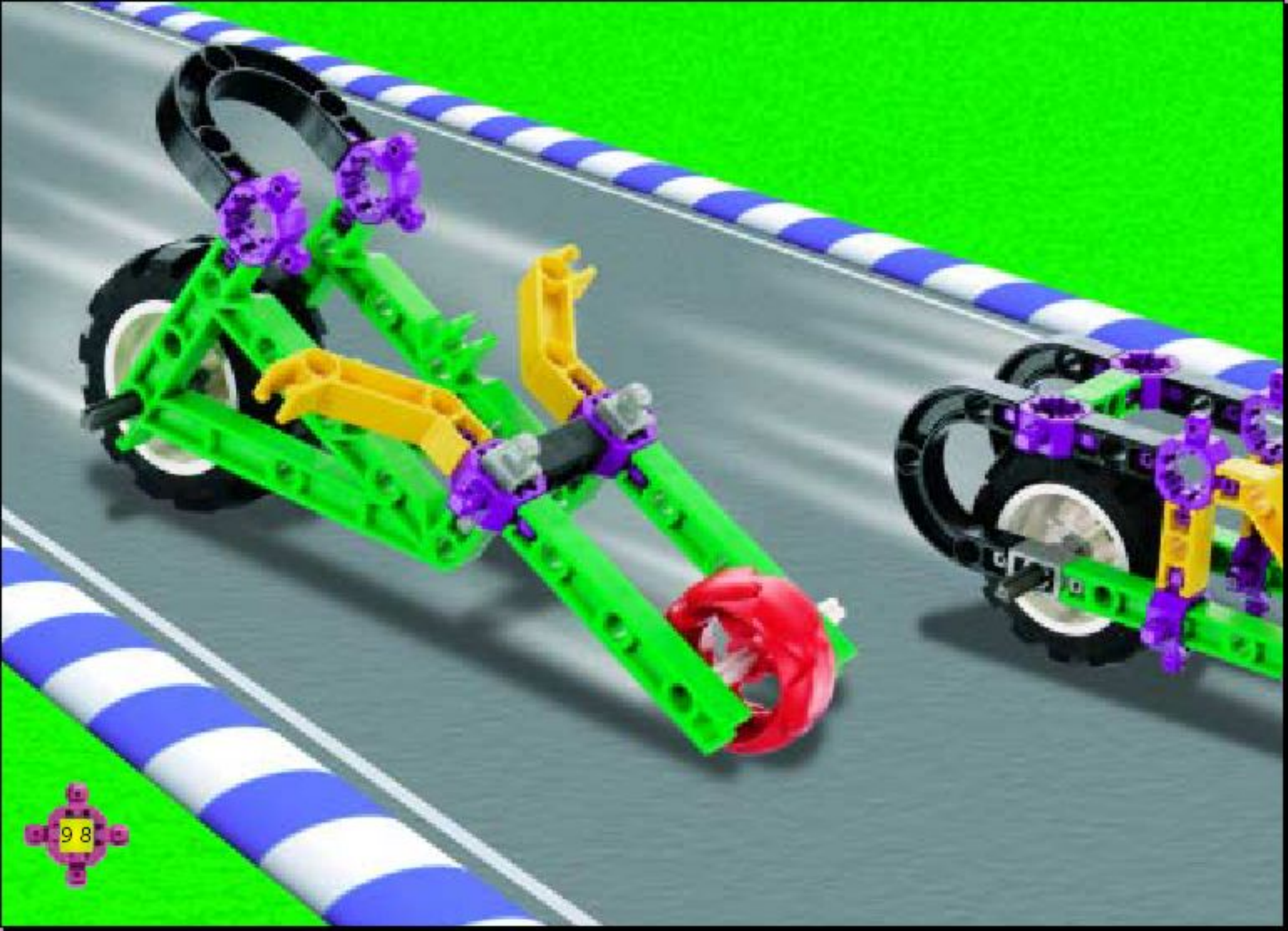

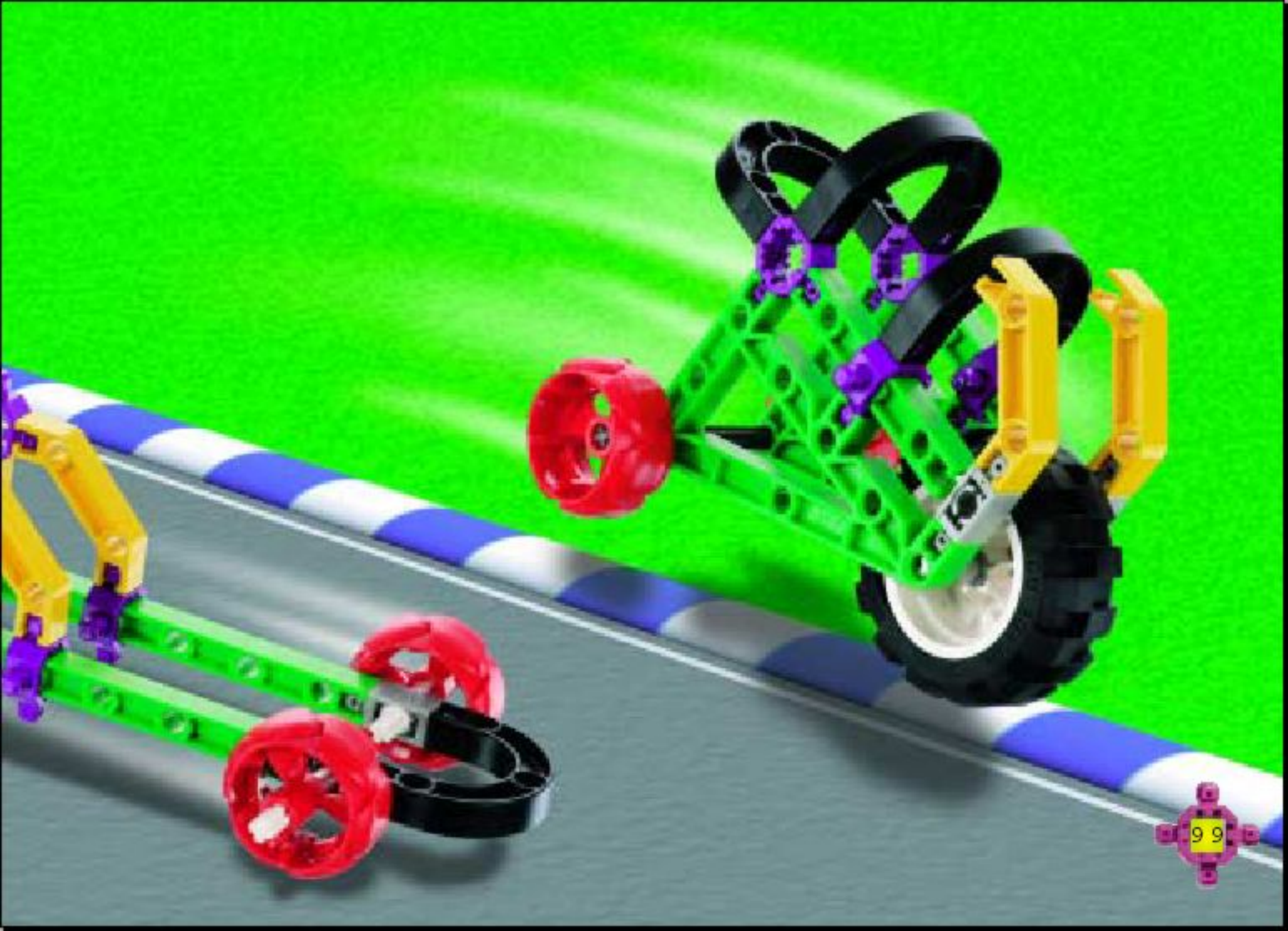

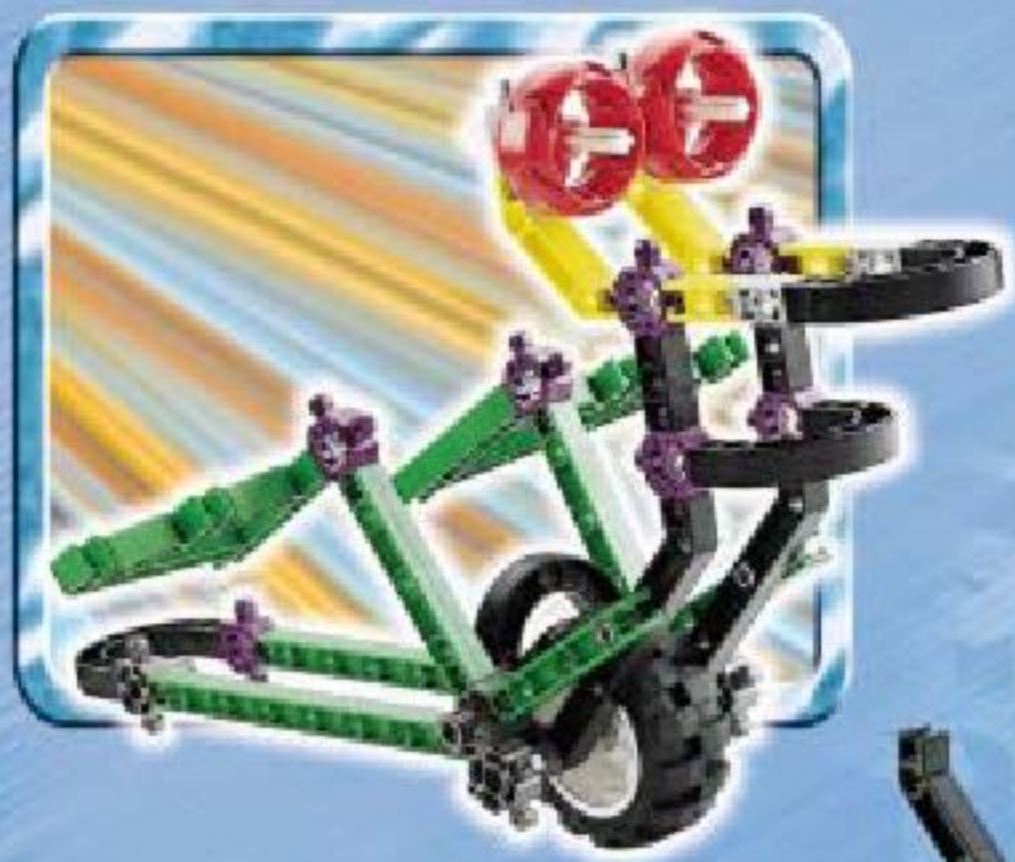

2



3



4



5



6



7





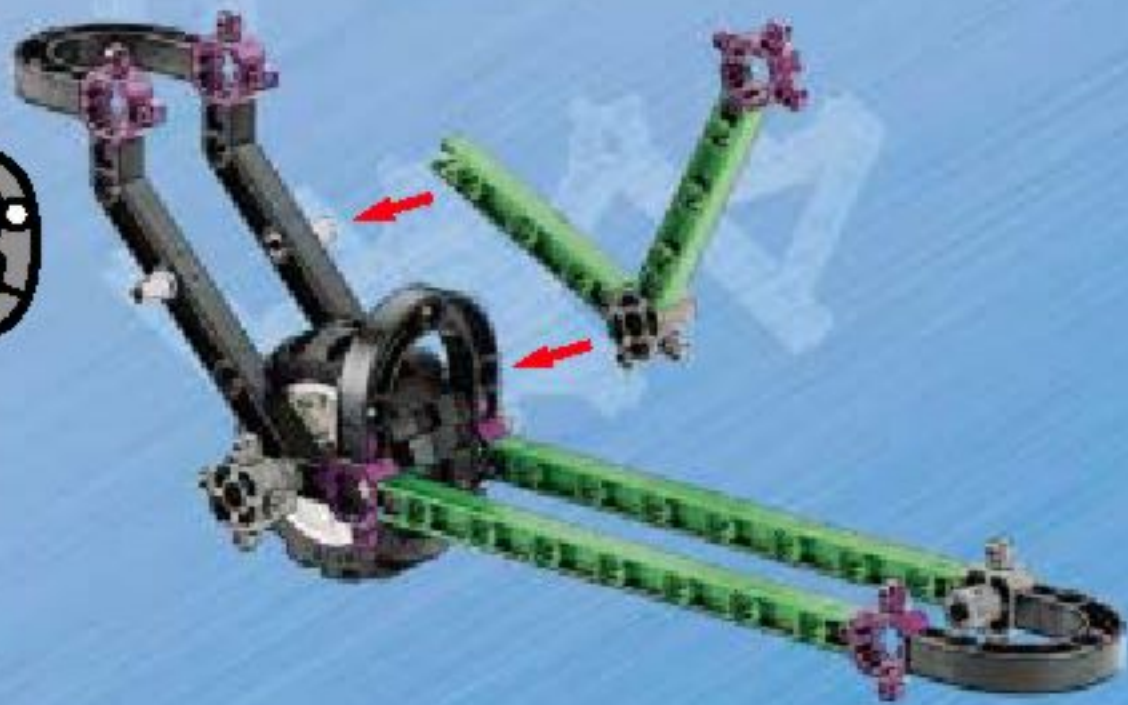

10



11



12



13



14





14



The LEGO logo is displayed in its characteristic white, bold, sans-serif font with a black outline, set against a red square background.

4123873

® LEGO is a registered trade-mark

© 1999 LEGO Group.

<http://www.LEGO.com>

