



40593





LEGO.com/sustainable-packaging

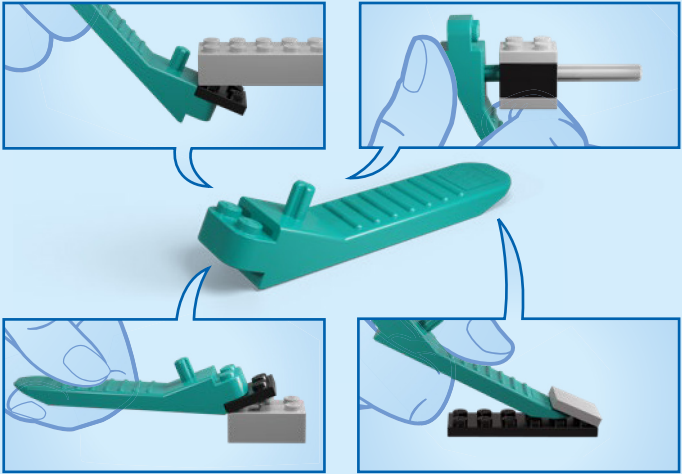

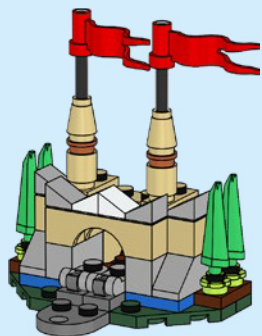
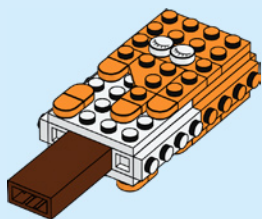
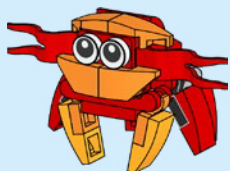

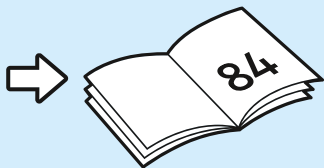
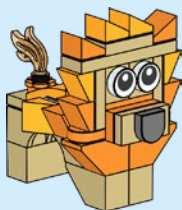
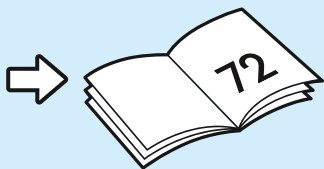
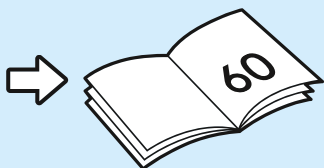
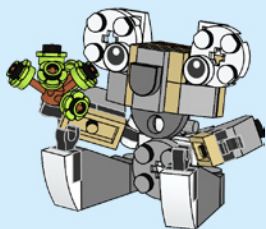
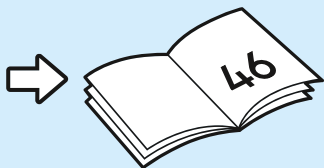
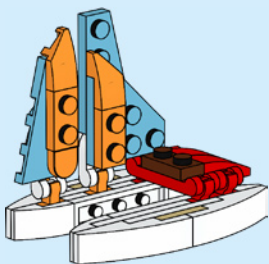

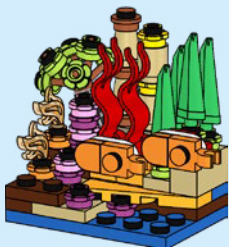
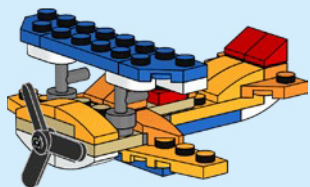
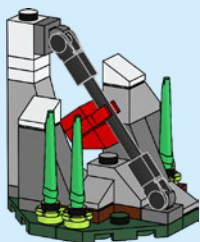
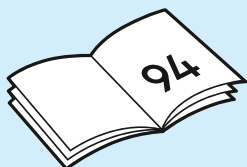
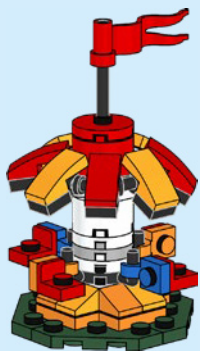

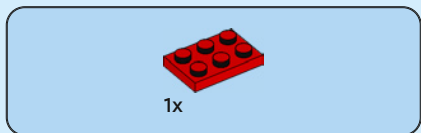
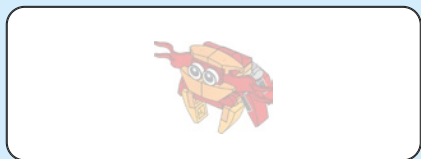

1

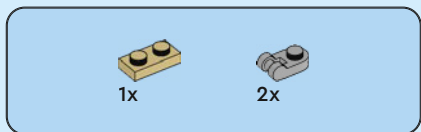

2

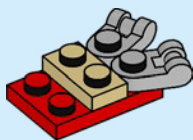



1x



1x

3

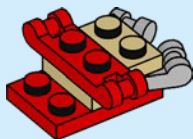

1x

4

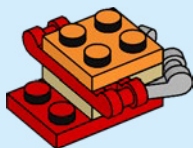

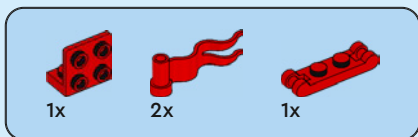

5

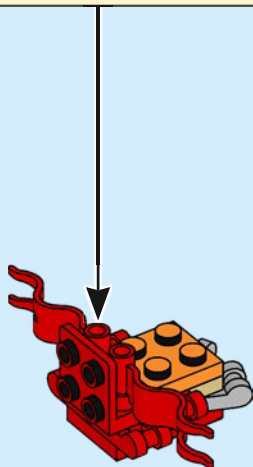
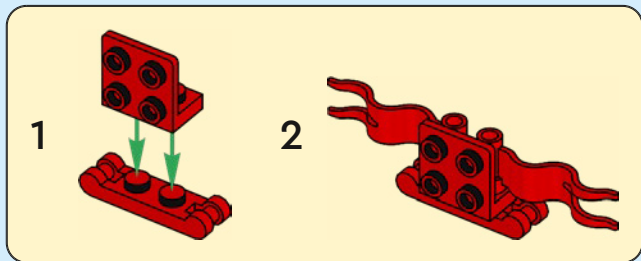



6

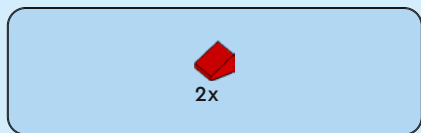
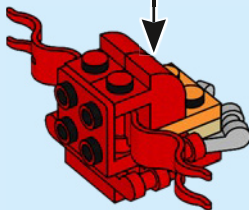
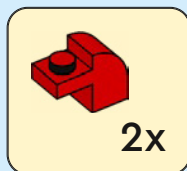

7

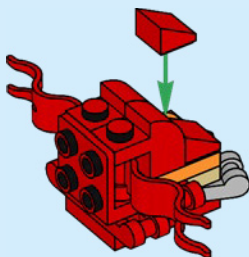



1x



1x

8

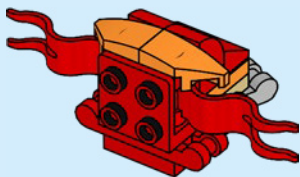

1x



1x



2x

9

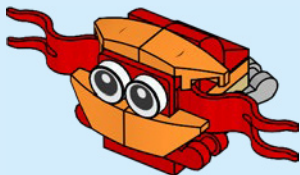



4x



4x

10

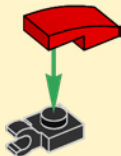
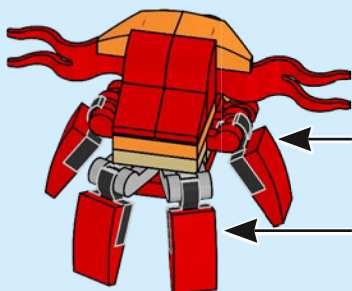

4x



2x



2x

11

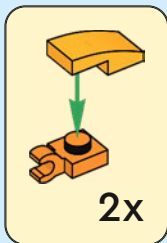

2x

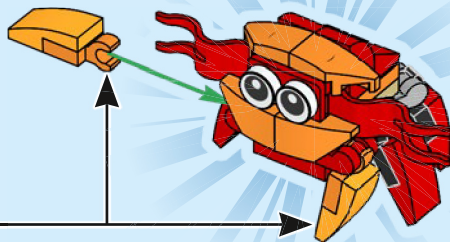

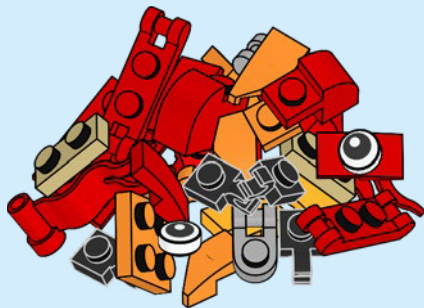
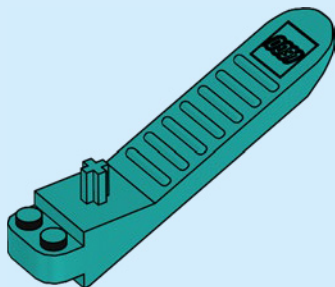
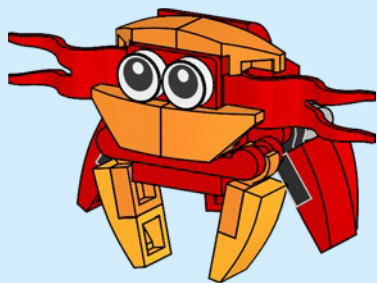

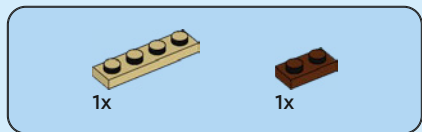
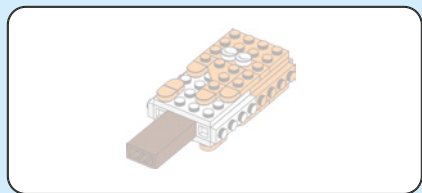

1

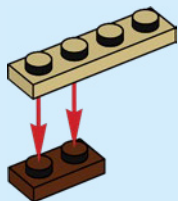



1x

2

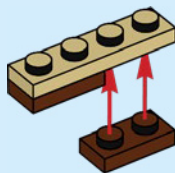

2x



1x

3

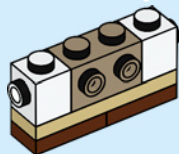



2x

4

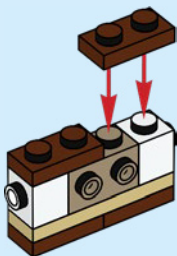

1x

5

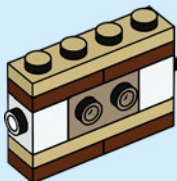



6

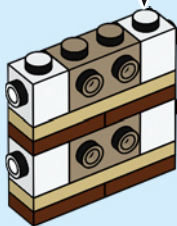
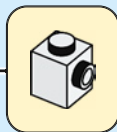

7

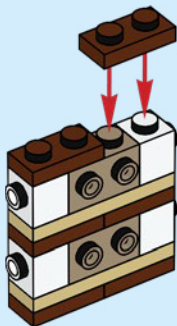



1x

8

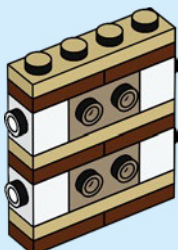

1x



2x

9

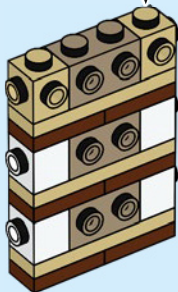
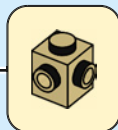

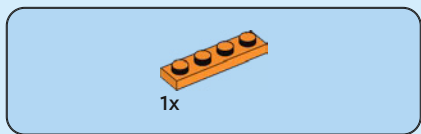

10

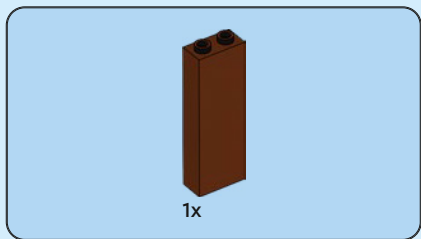

11

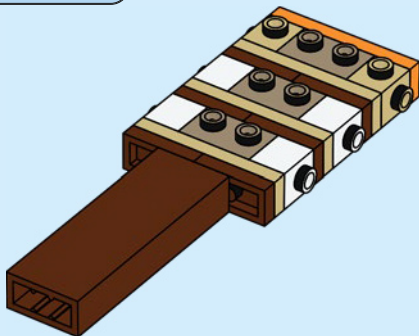



2x



2x



2x

12

1



2



2x

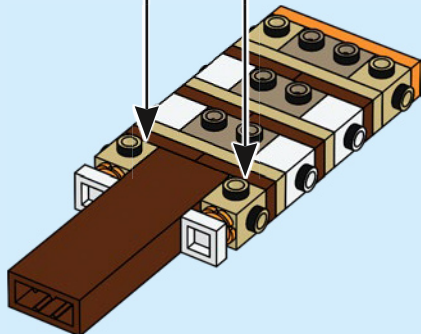



2x

13

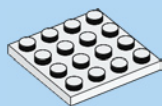
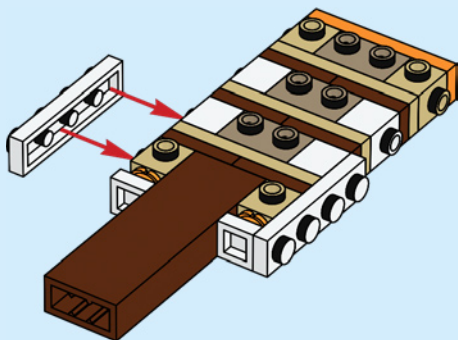

1x

14

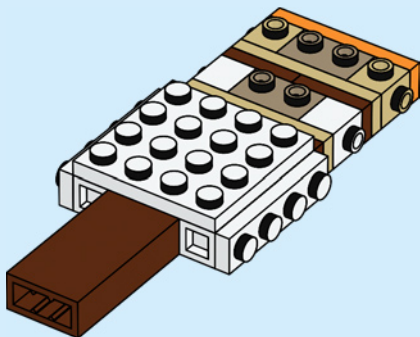



2x

15

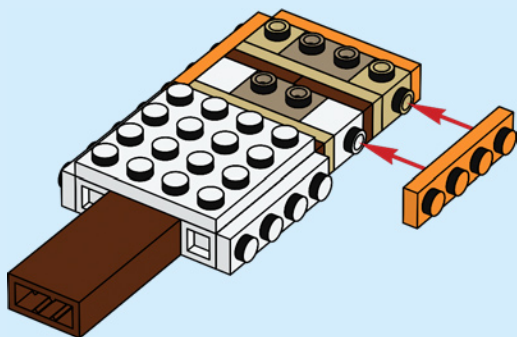

2x

16

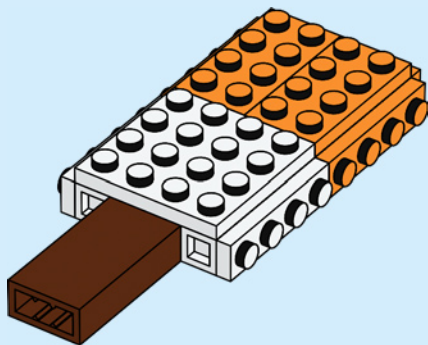

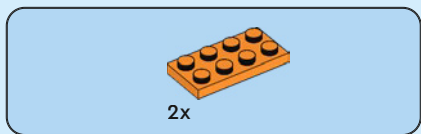

17

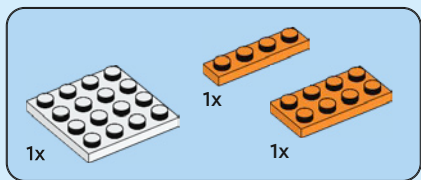
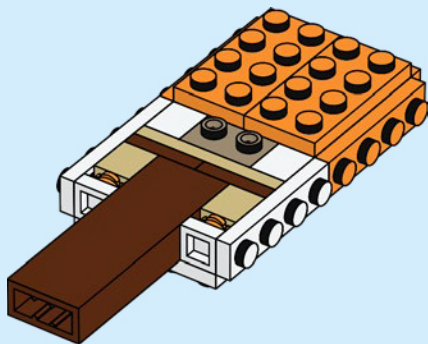

18

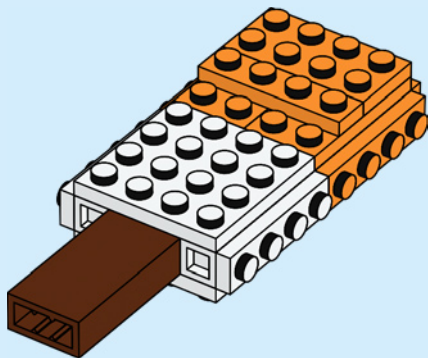



1x



1x



1x

19

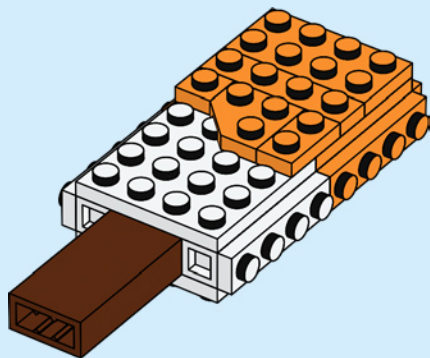

1x



5x

20

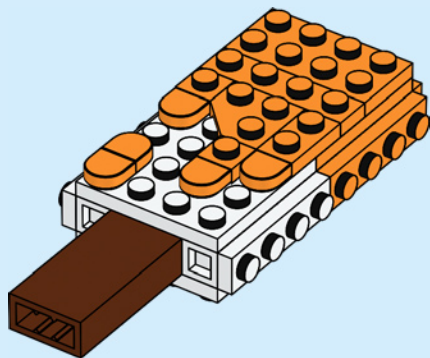

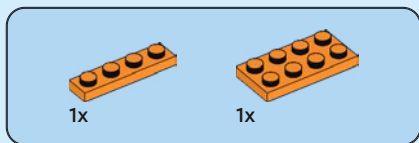

21

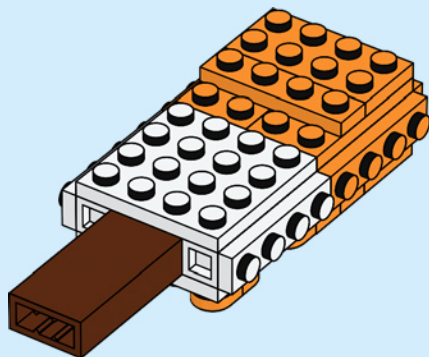

22

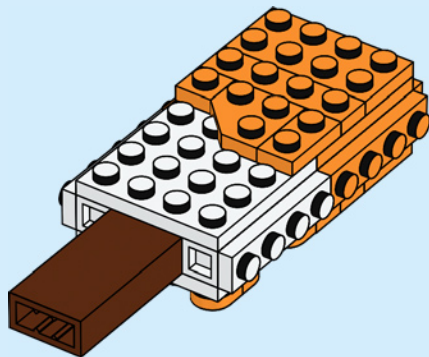



1x



5x

23

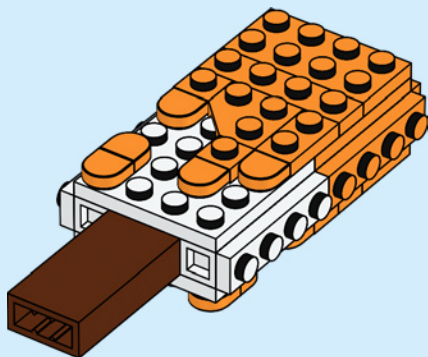

2x

24

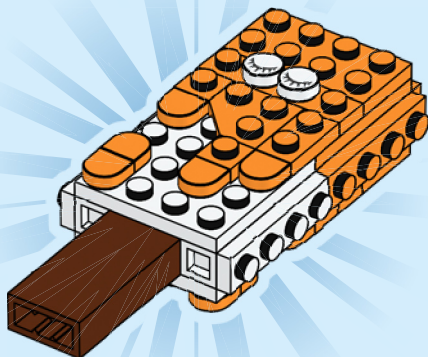

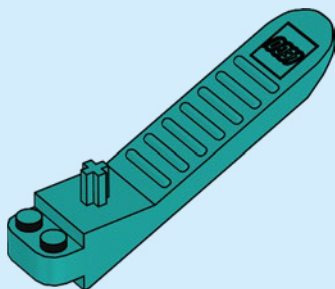
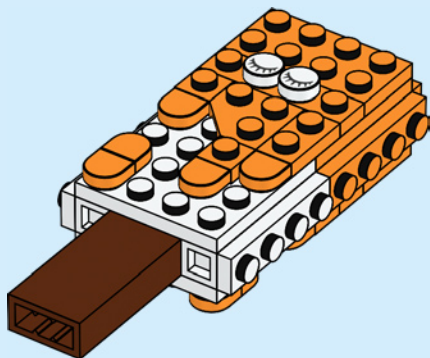

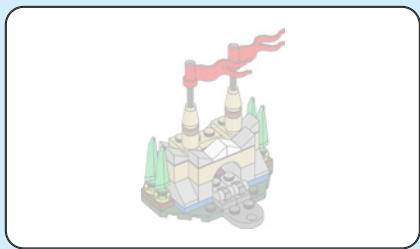

1x



1x

1

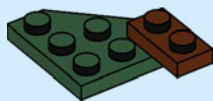



1x

2

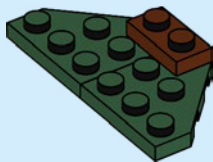

1x

3

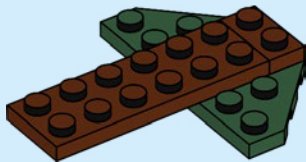

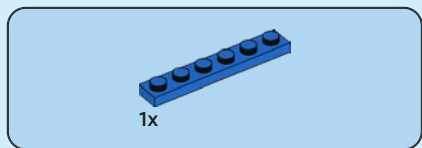

4

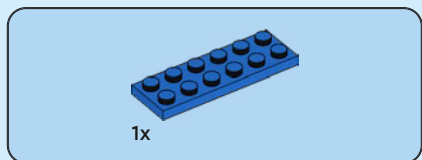
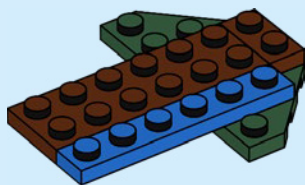

5

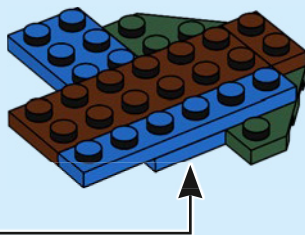
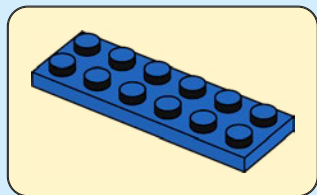

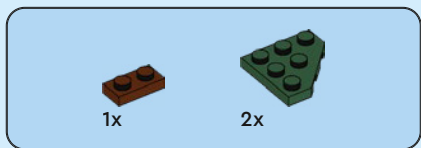

6

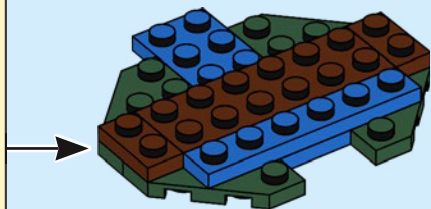
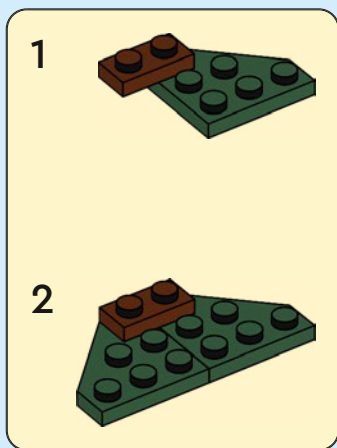



1x



2x



2x

7

1



2

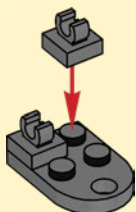

3

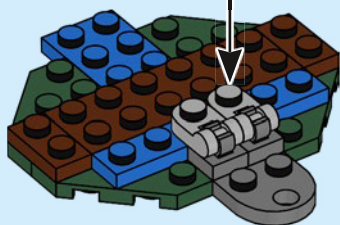
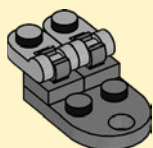



2x



4x

8

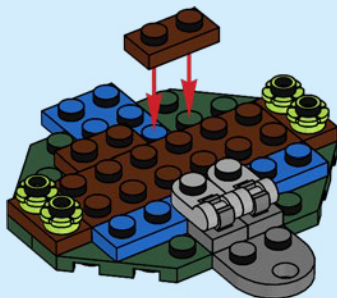

2x



2x

9

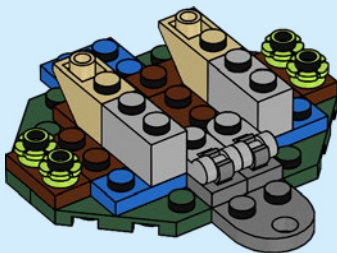



2x

10

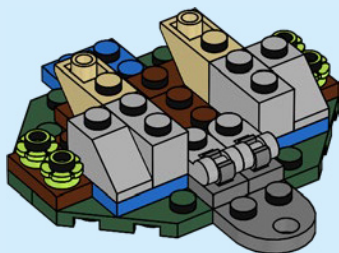

2x

11

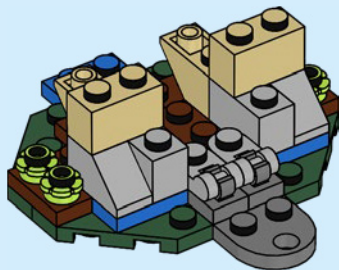



2x

12

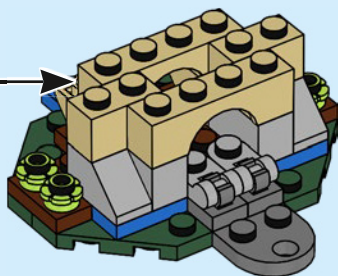
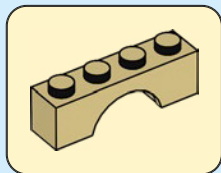

2x

13

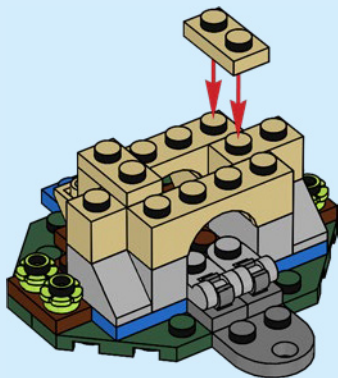



2x

14

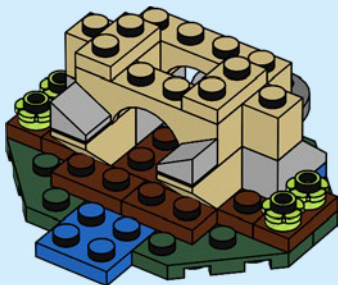

2x

15

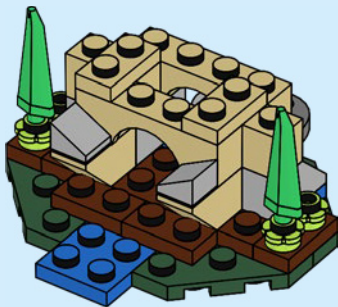



2x



2x

16

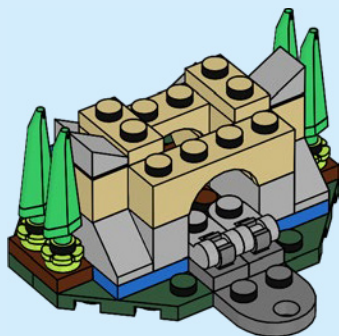

2x



2x

17

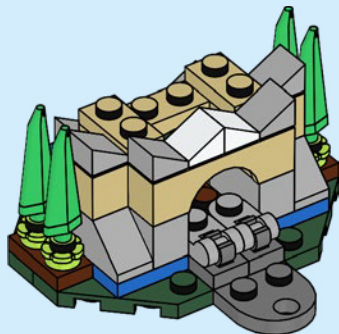

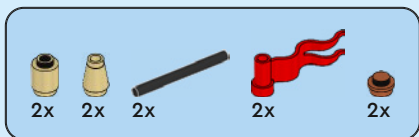

18

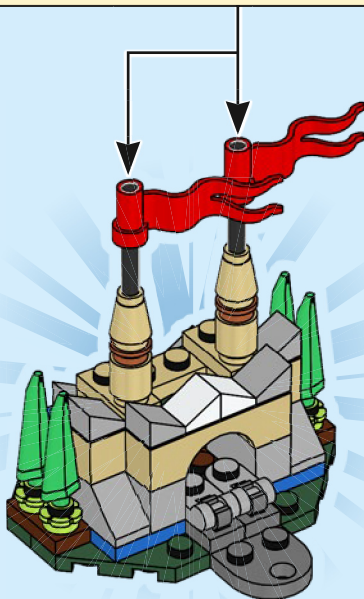
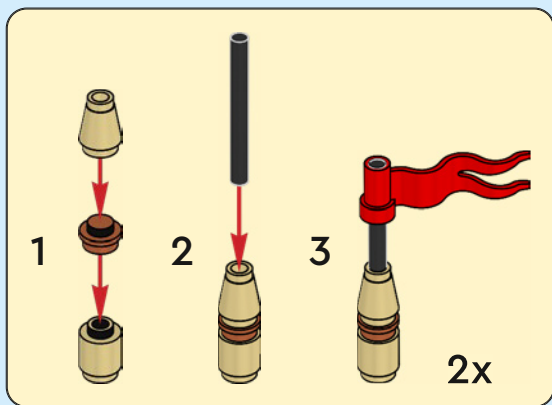

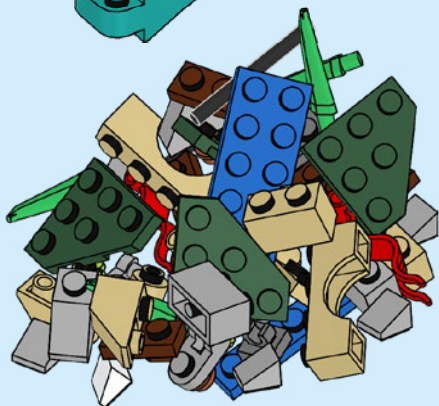
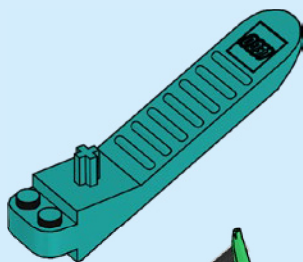
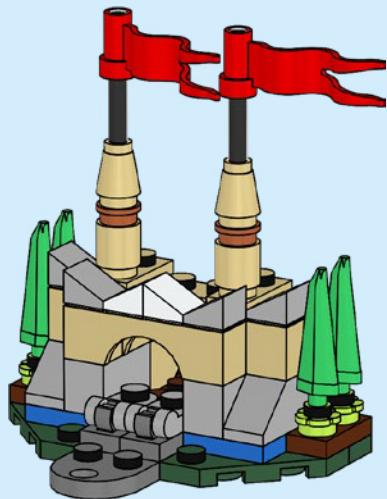

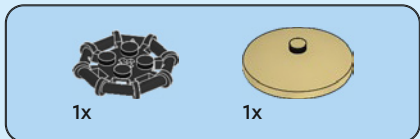

1

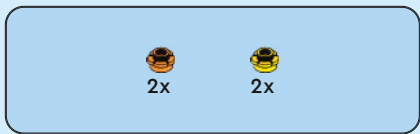
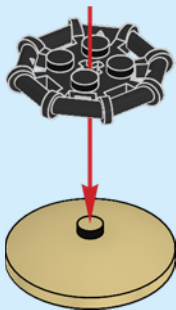

2

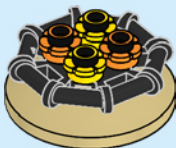



2x

3



2x

4





8x



8x



8x

5

1



2



8x

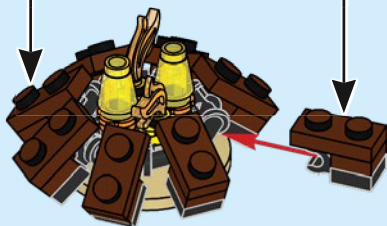



2x

6



2x





2x



2x

7

1



2



2x



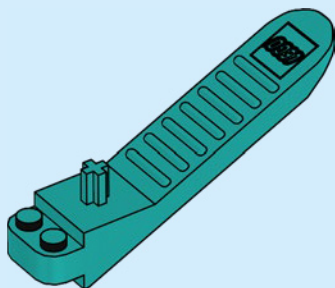

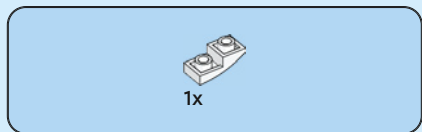

1

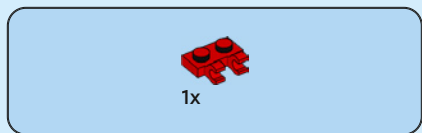
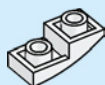

2

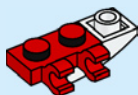



1x

3

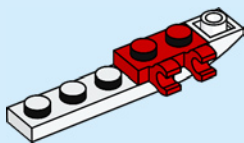

2x



1x

4

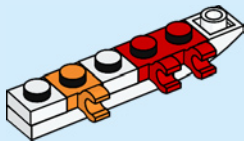



1x

5

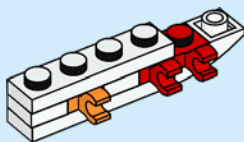

1x

6

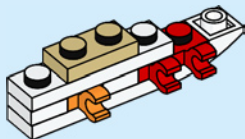



1x

7

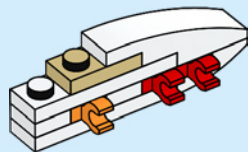

1x



1x



1x

8

1

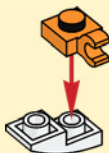

2

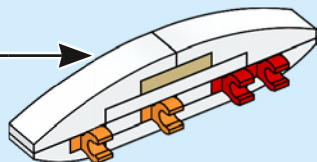
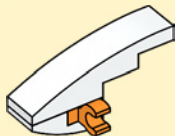

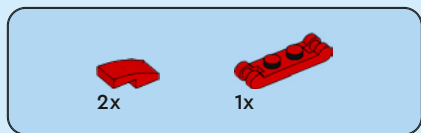

9

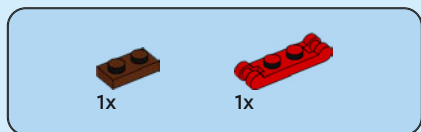
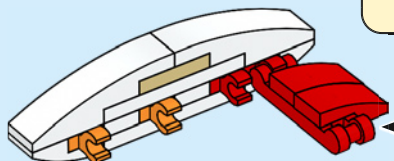
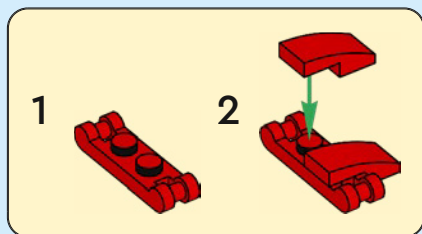

10

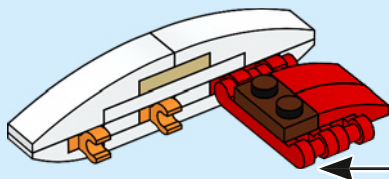
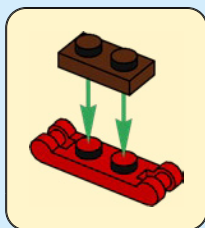

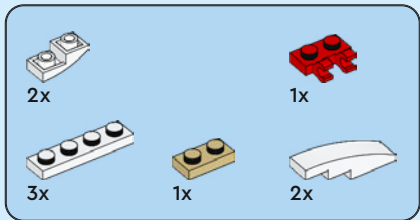
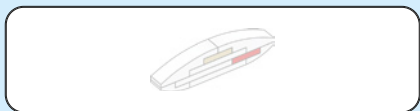

11

1

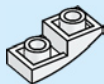

2



3

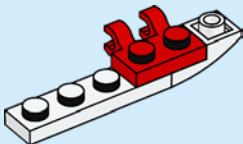

4

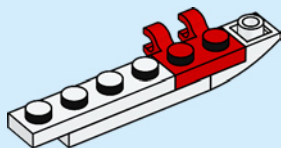

5

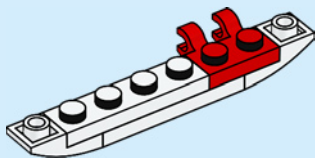

6

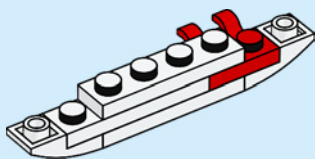

7

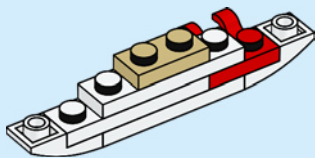

8

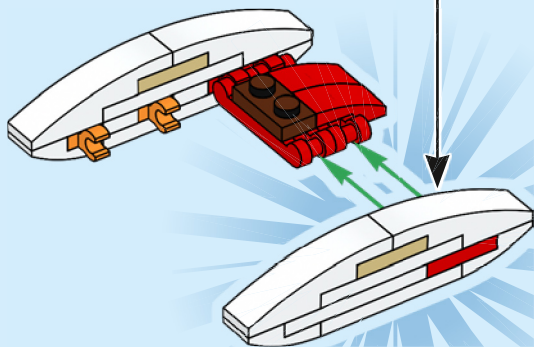
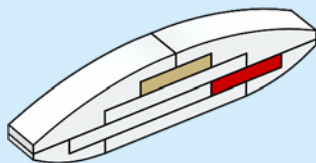

12

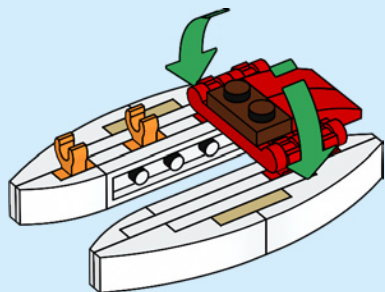

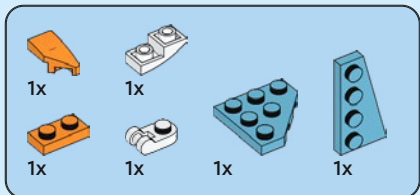

13

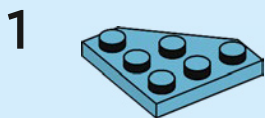

4

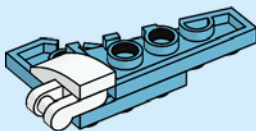

5

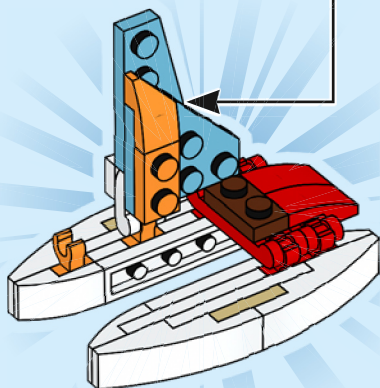
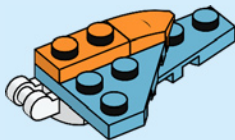

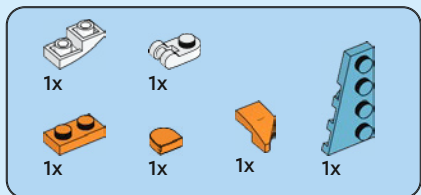
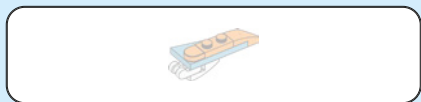

14

1

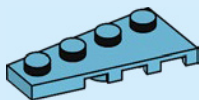

2

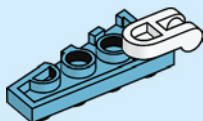

3

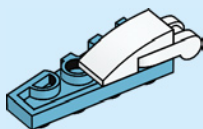



4

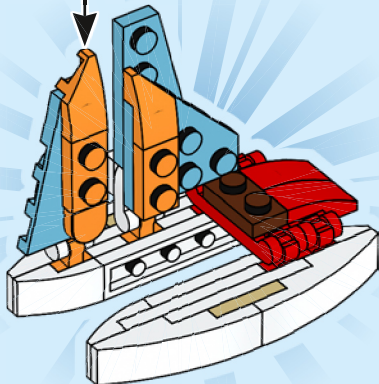
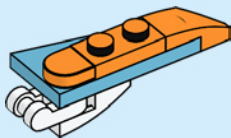

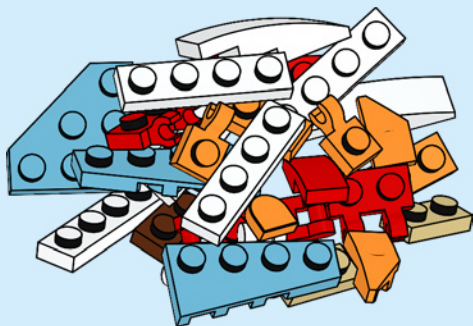
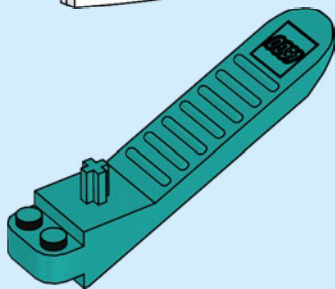
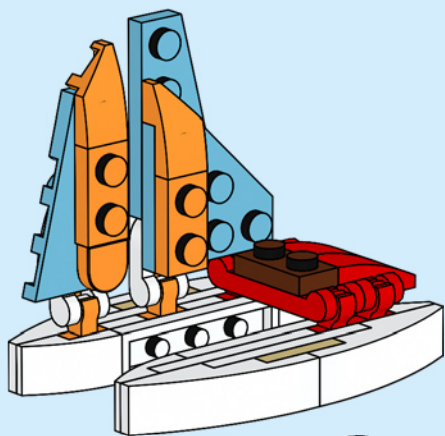

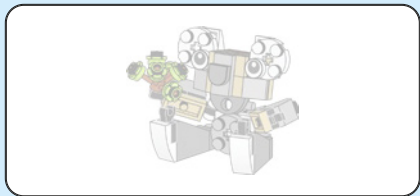

1



2





1x

3



1x

4

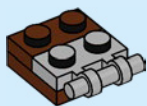



2x

5

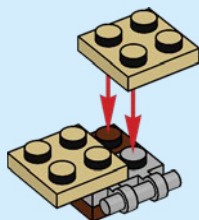

1x

6

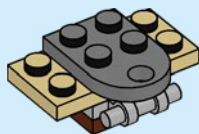



2x

7

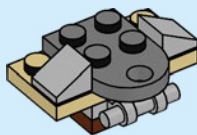

2x

8

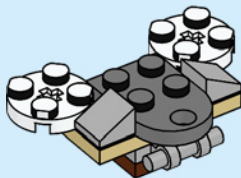



2x

9

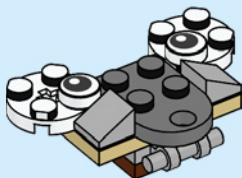

2x

10





2x

11

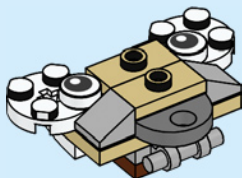

1x



1x

12

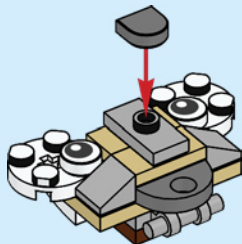

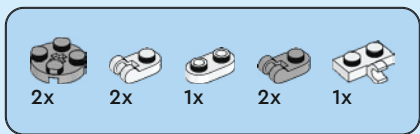

13

1



2



3



4



5

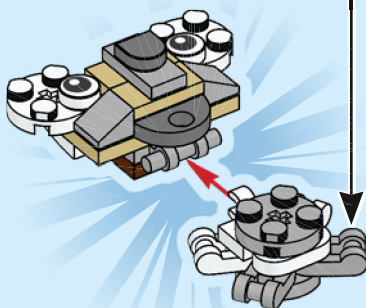
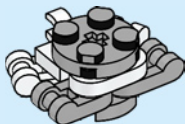

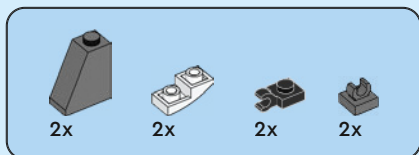

14

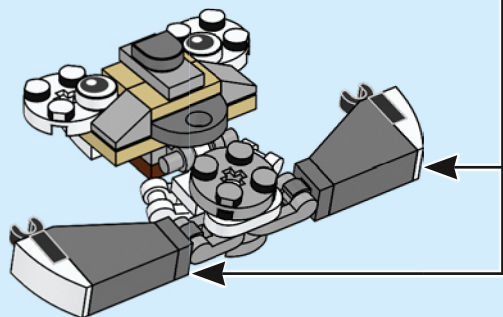
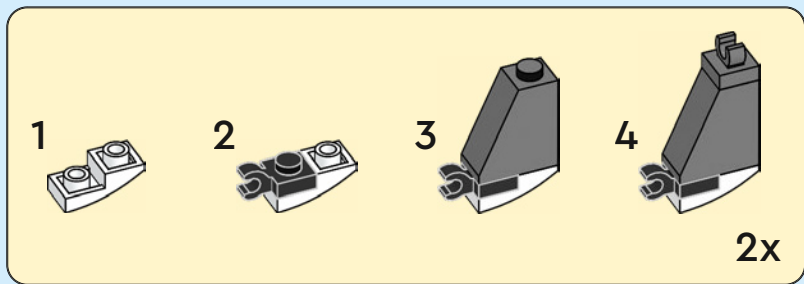

15

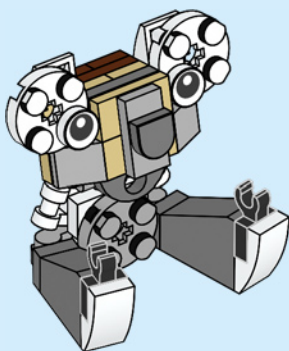



2x



2x



4x

16

1



2

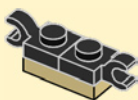

3

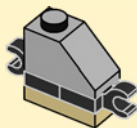

2x

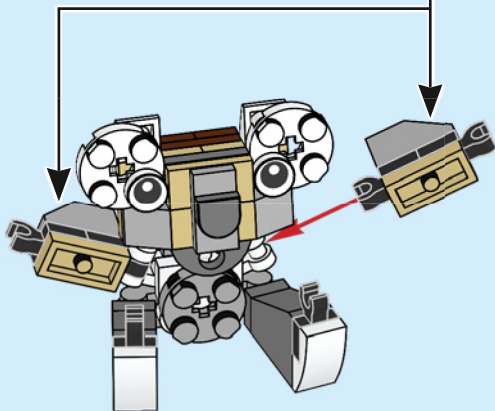



6x



1x

17

1



2

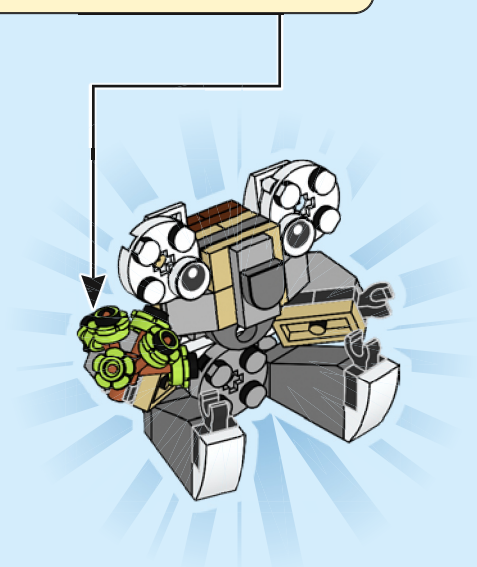

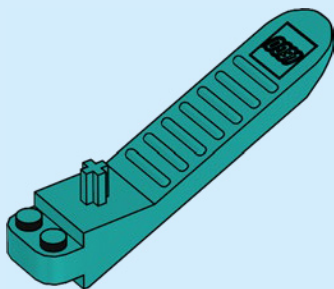
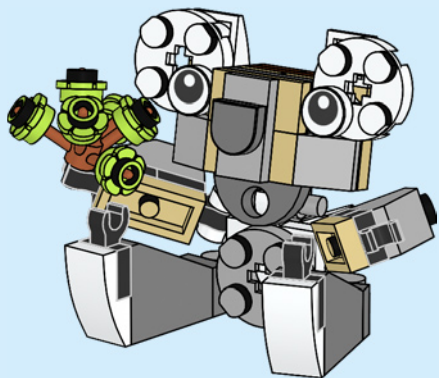

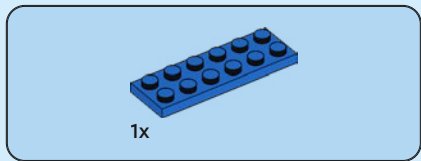
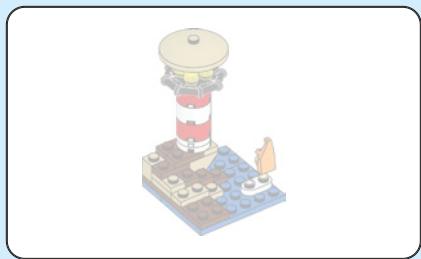

1

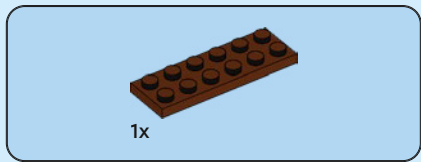
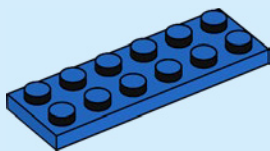

2

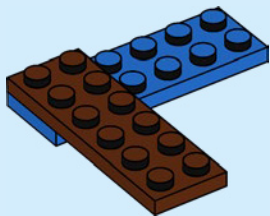

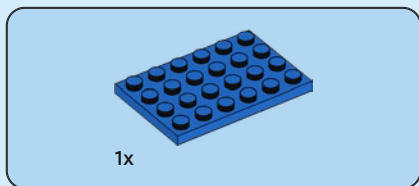

3

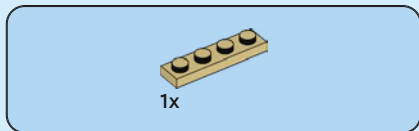
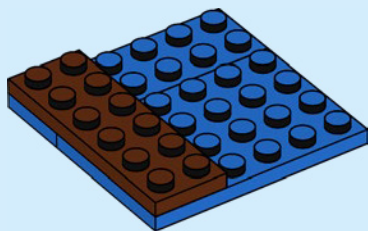

4

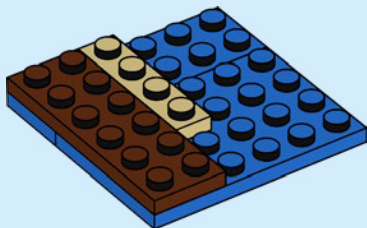



1x



2x

5

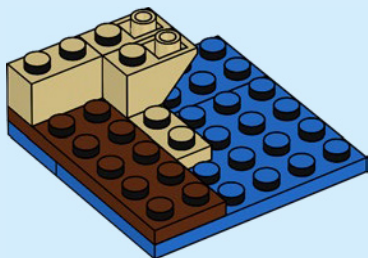

1x



1x

6

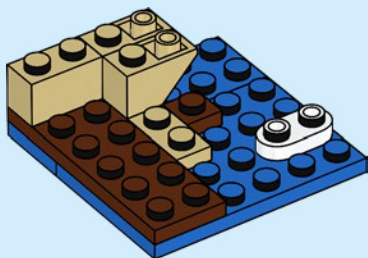



1x



1x

7

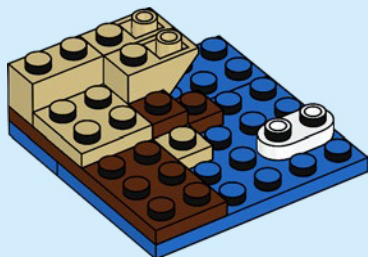

1x



1x

8

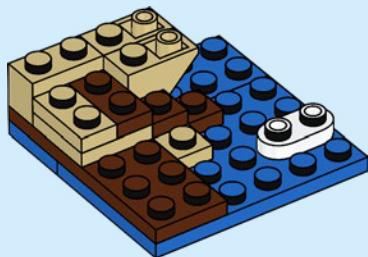



1x



1x

9

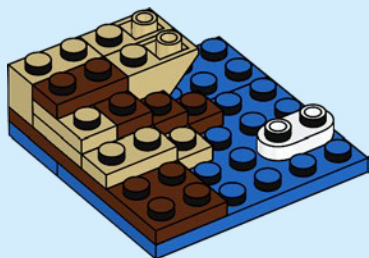

2x

10

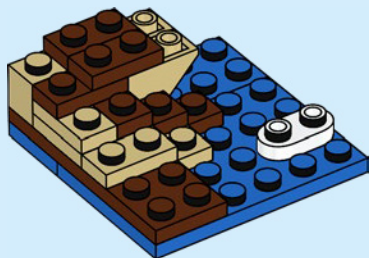

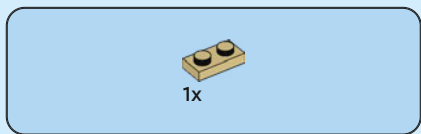

11

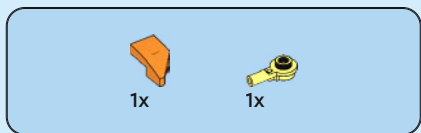
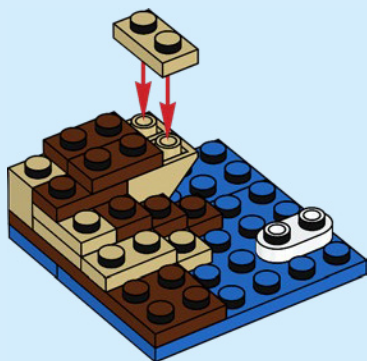

12

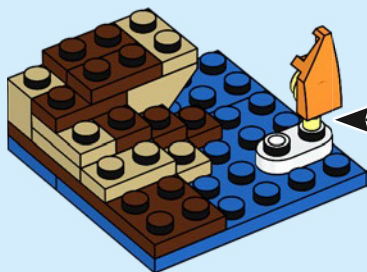
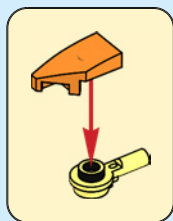

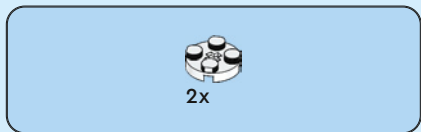

13

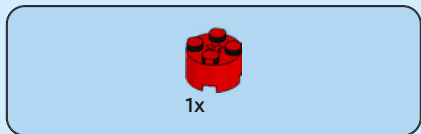
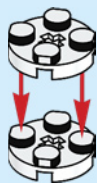

14





1x

15



1x

16





1x

17



4x

18



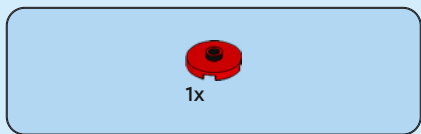

19

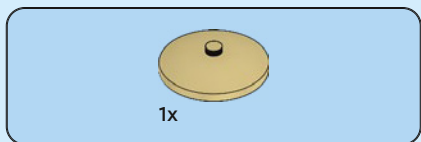

20



21



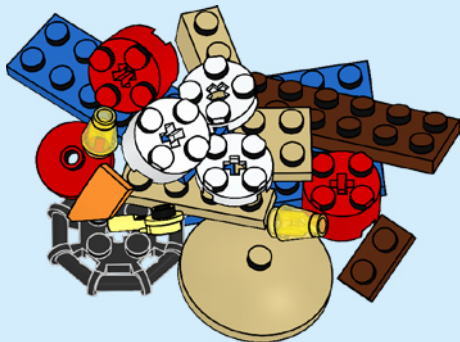
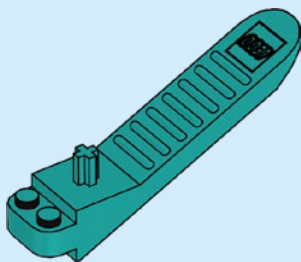

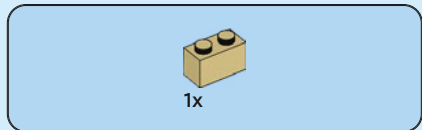

1

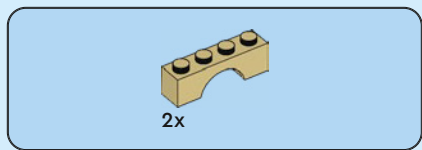

2

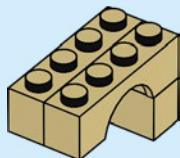



2x

3

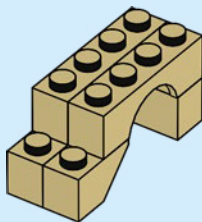

2x

4

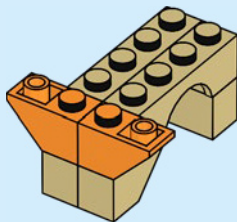

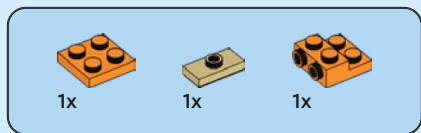

5

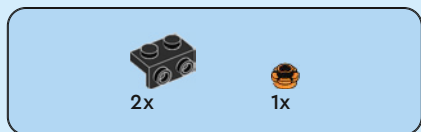
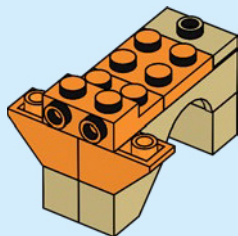

6

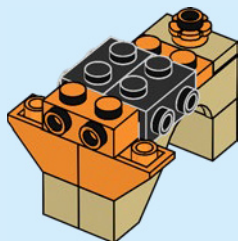



1x



2x

7

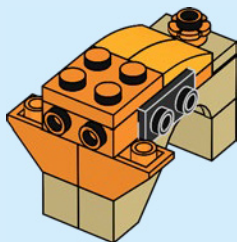

2x

8

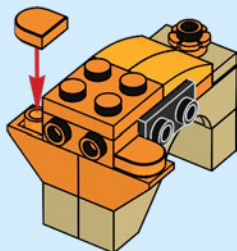



2x



2x

9

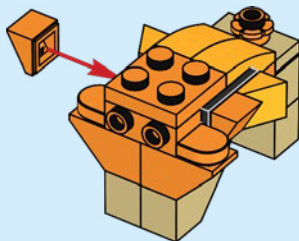

1x

10

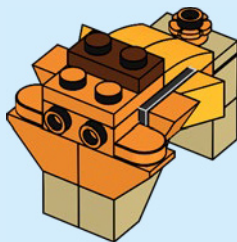



1x



1x

11

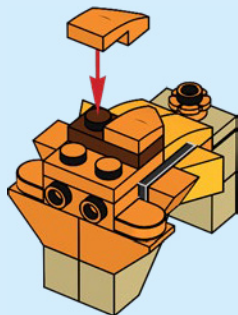

1x



1x



1x

12

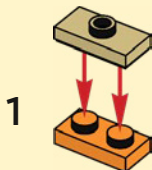

2

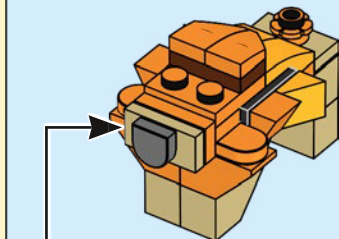



2x

13

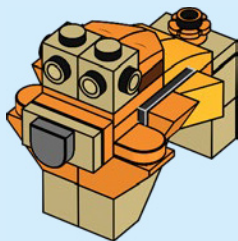

2x



2x



2x

14

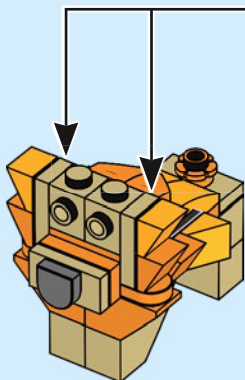

1



2

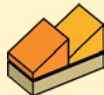

2x



1x

15

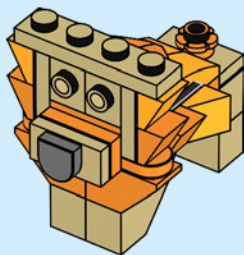

1x



2x

16

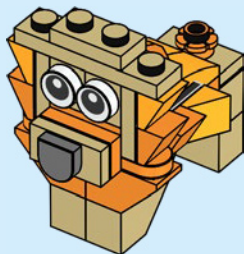



2x



2x



1x

17

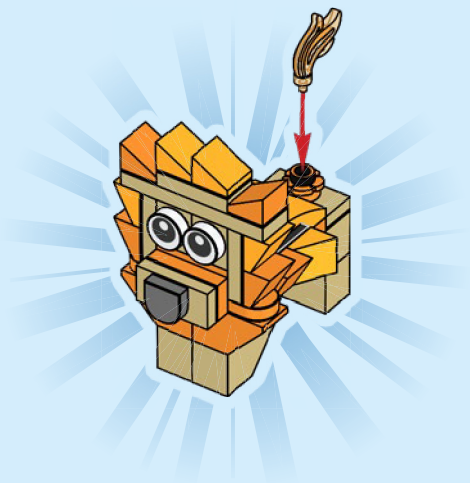

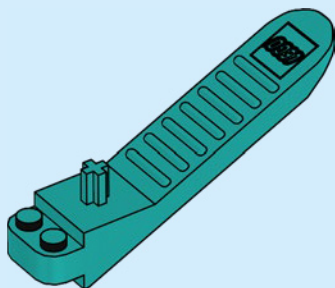
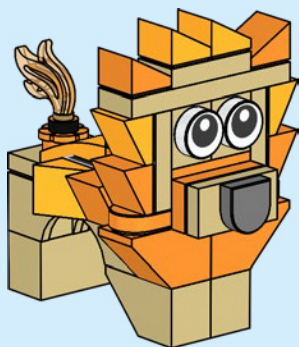

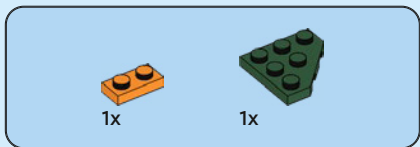

1x

1x

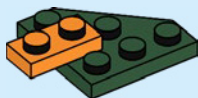

1

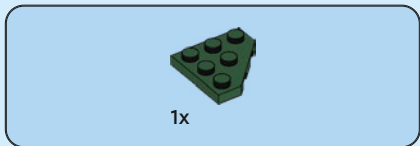

1x

2

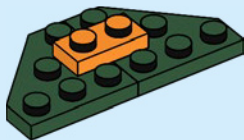



1x

3

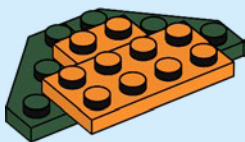

2x

4

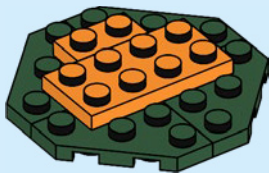



1x

5

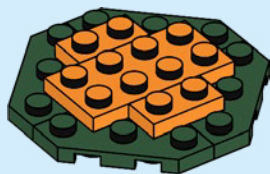

1x

6

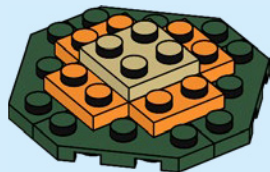

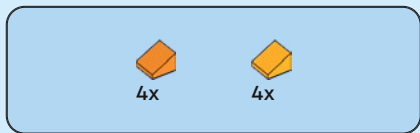

7

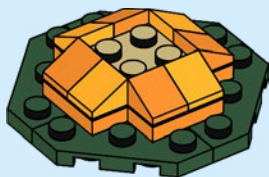

8

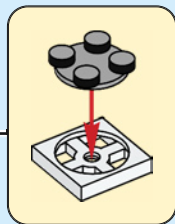

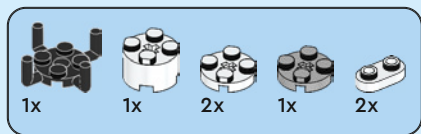

9

1

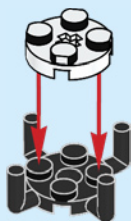

2

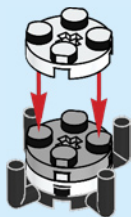

3

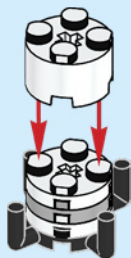

4

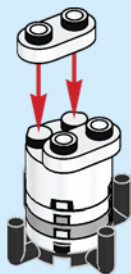



2x



2x

10



2x

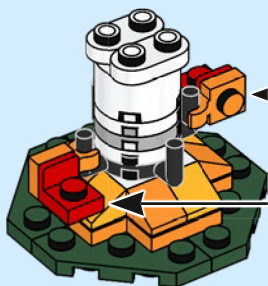

2x



2x

11



2x

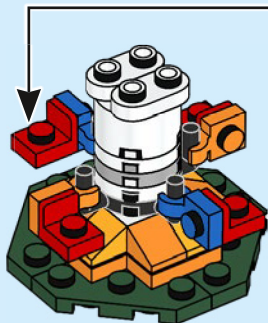



12

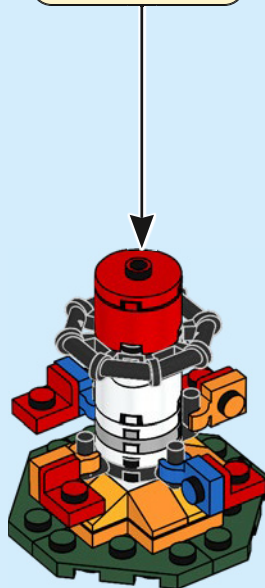
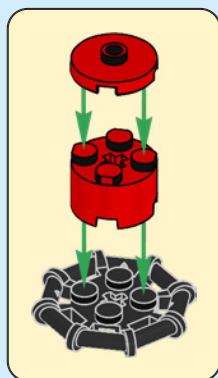



13

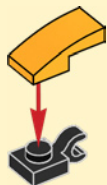
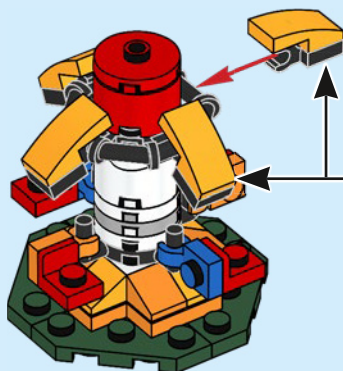

4x



14

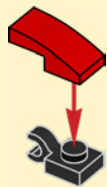
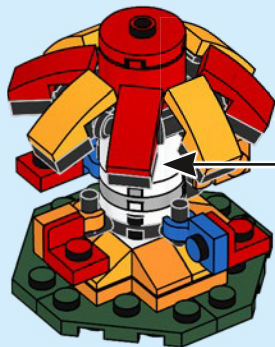

4x

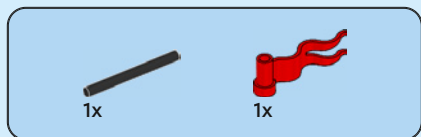

15

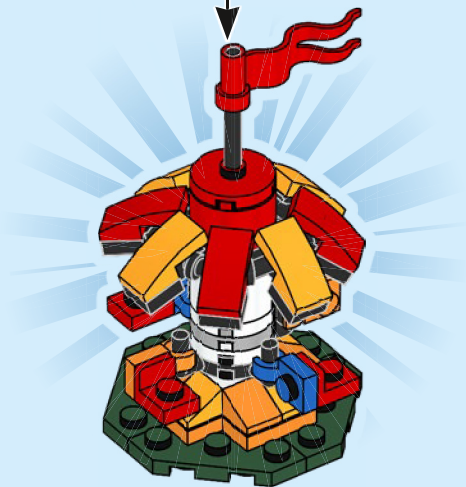
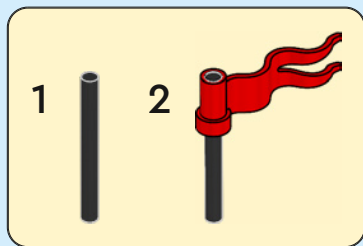

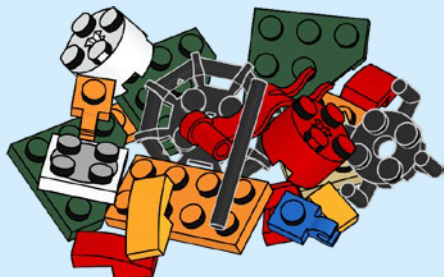
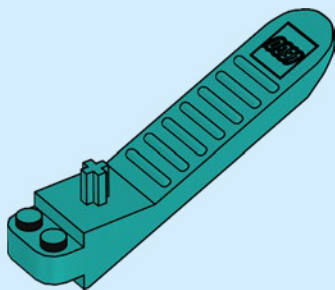
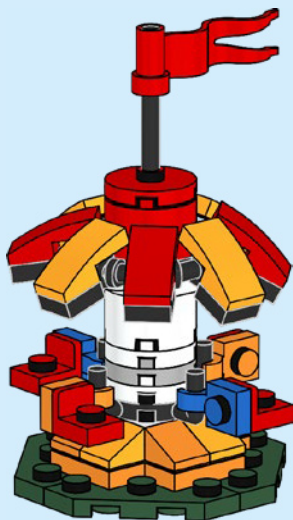

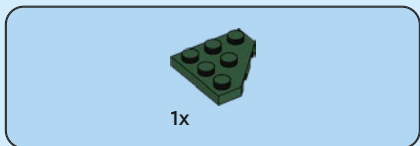
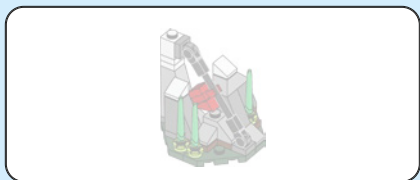

1

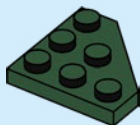

2





1x



1x

3



1x

4

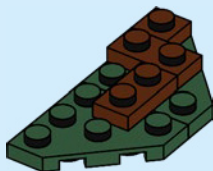



1x

5

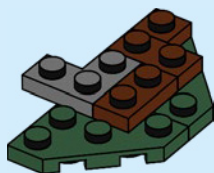

1x

6

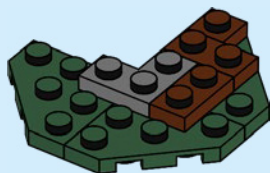



1x



1x



1x

7

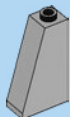
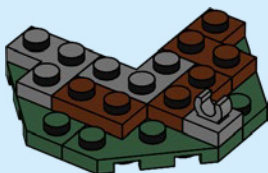

1x



1x



1x

8

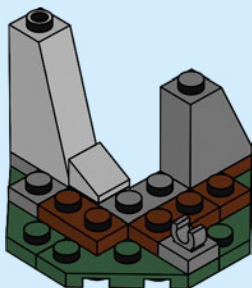

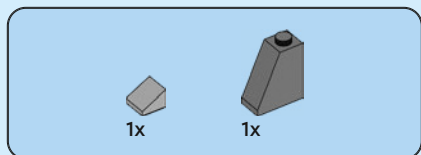

9

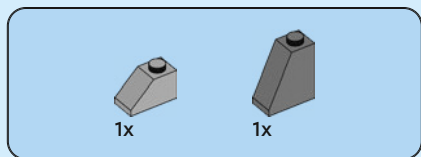
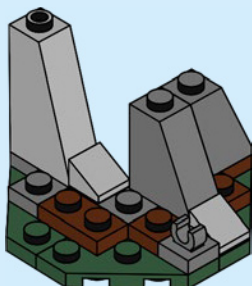

10

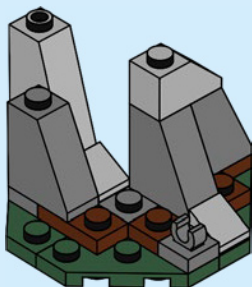



1x



1x

11

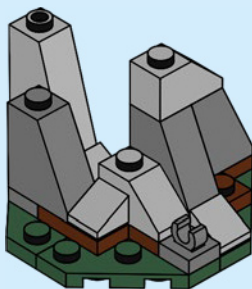

2x

12

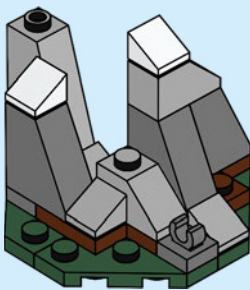



2x



1x



1x

13

1



2



3

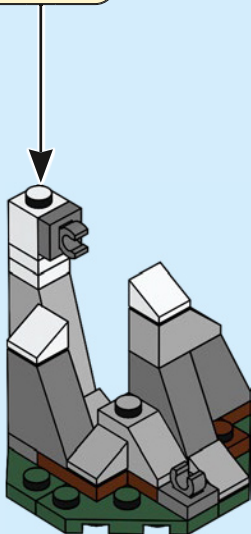
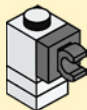



14

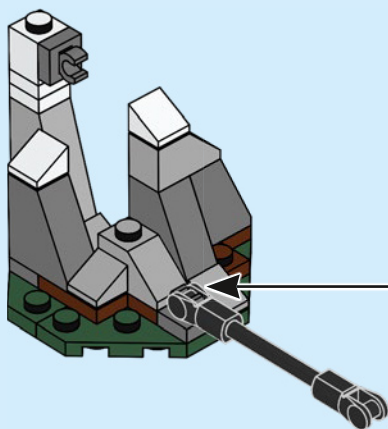
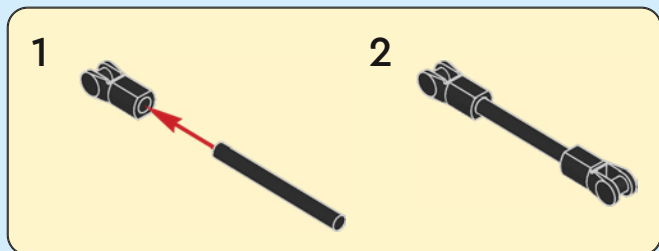



1x



1x



1x

15

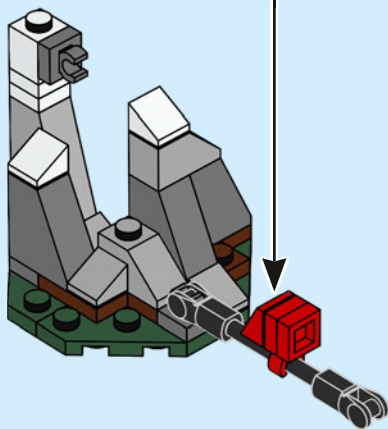
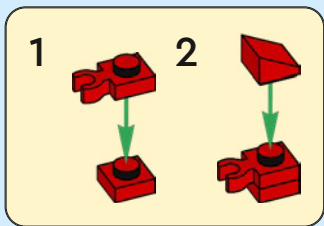

16

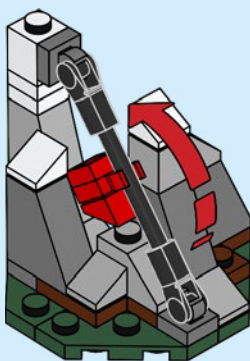



3x



3x

17

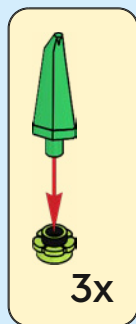

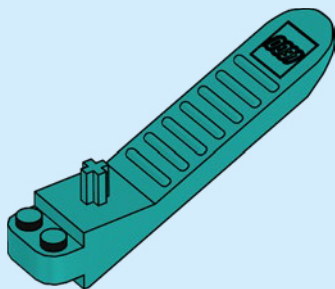
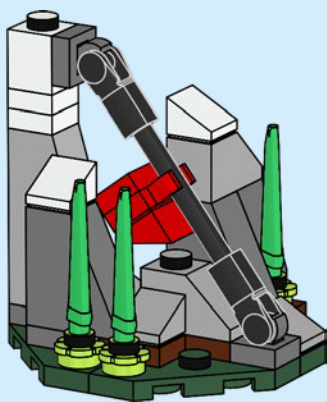

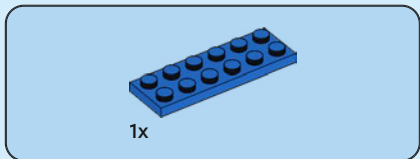
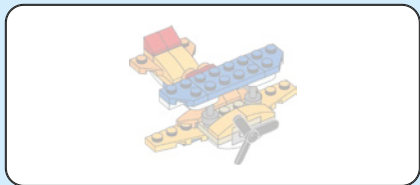

1

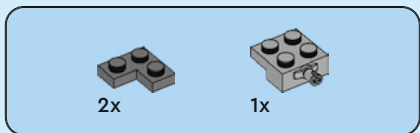
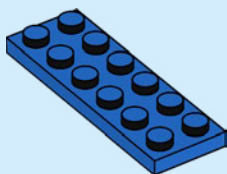

2

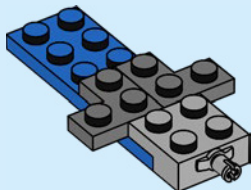

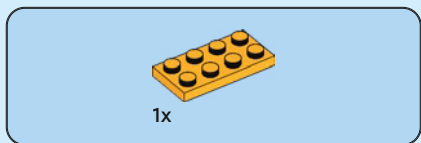

3

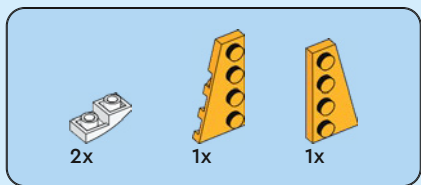
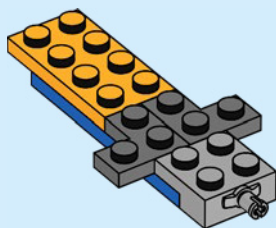

4

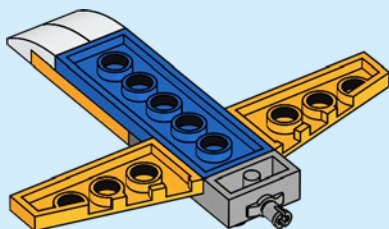

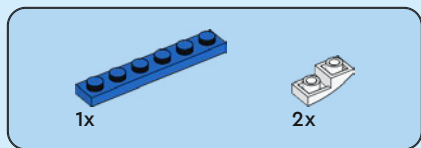

5

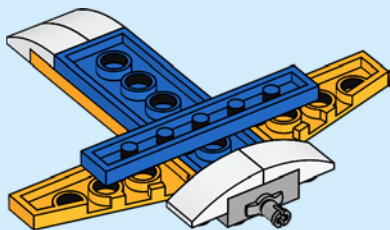

6

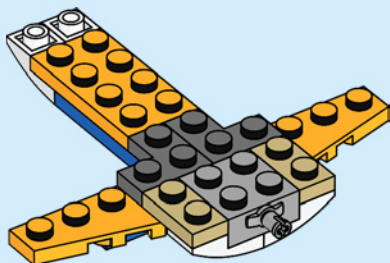

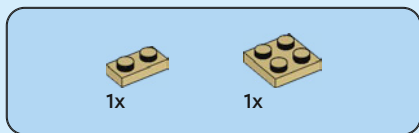

7

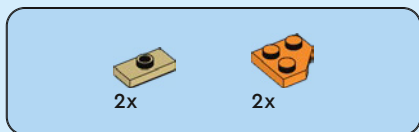
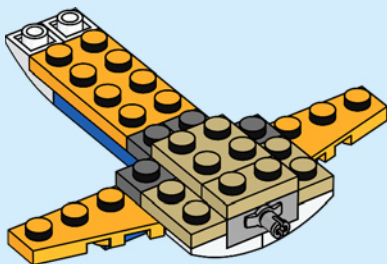

8

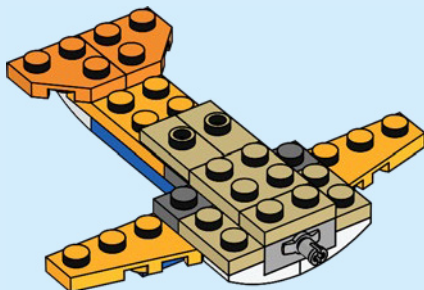



2x

9

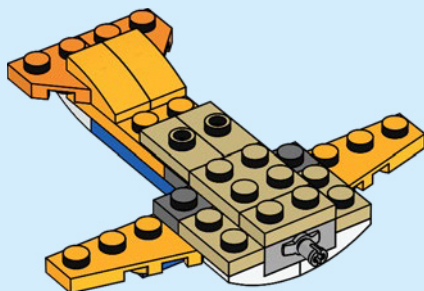

1x

10

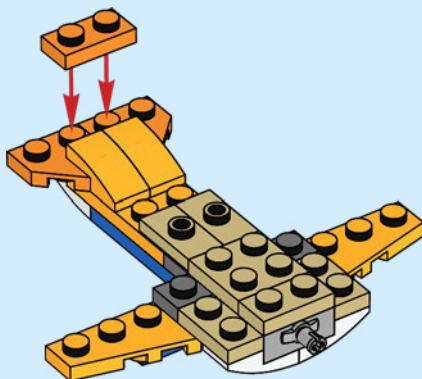



2x



1x



1x

11

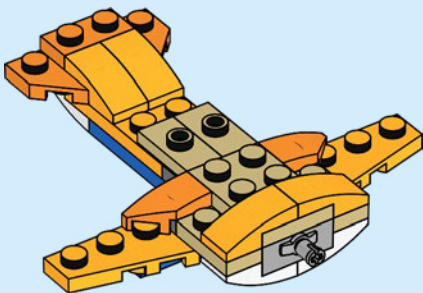

2x



2x

12

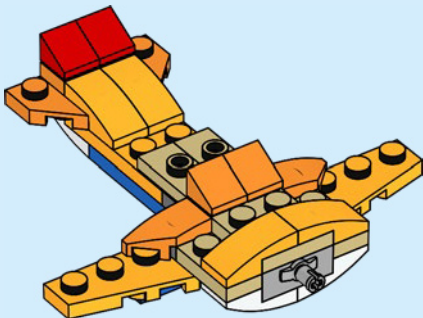



2x



2x

13

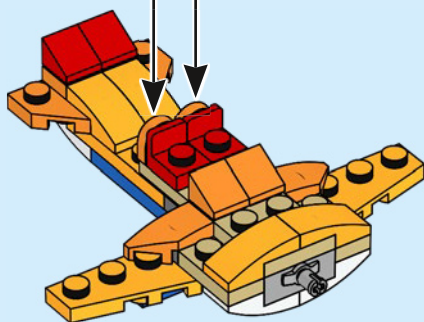
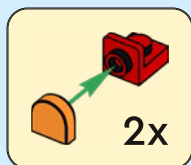

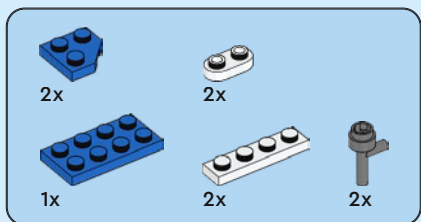
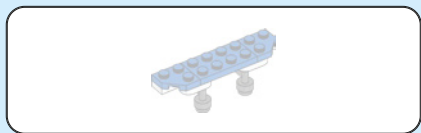

14

1

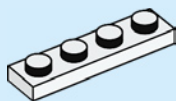

2

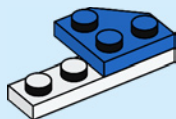

3

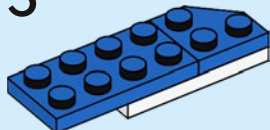

4

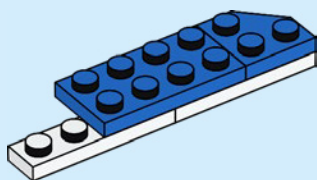

5

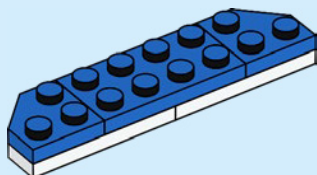

6

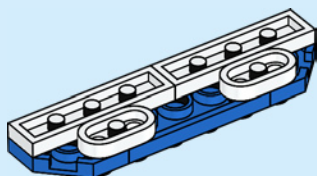

7

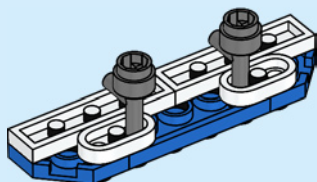



8

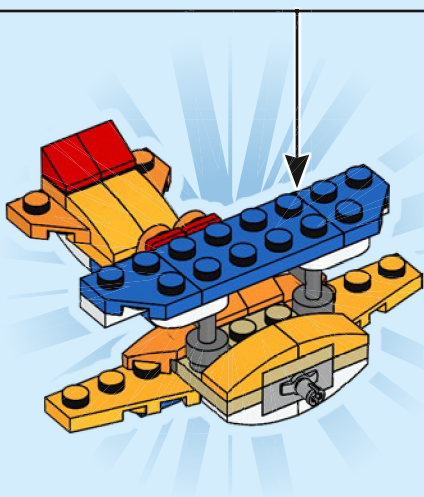
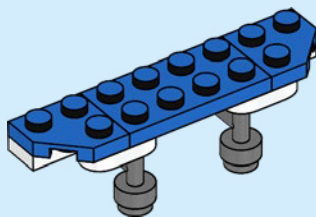



1x

15

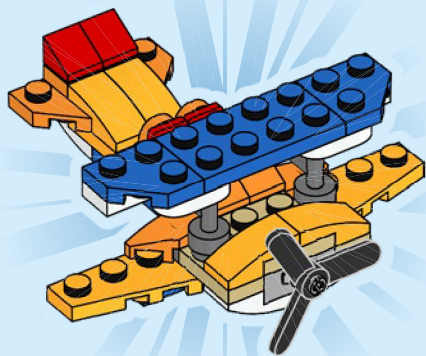

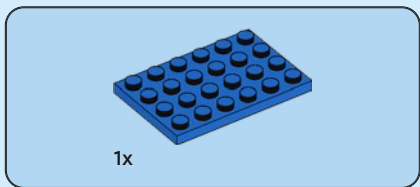

1

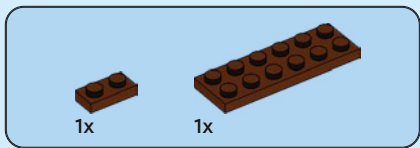
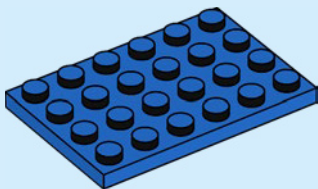

2

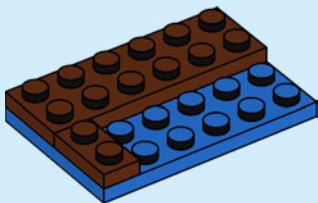

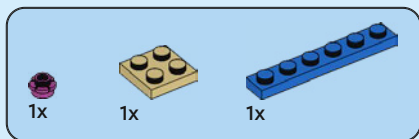

3

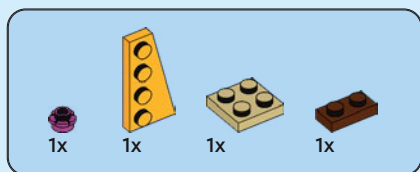
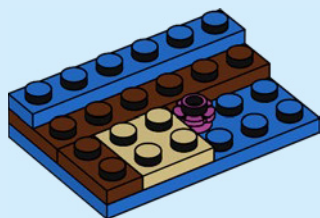

4

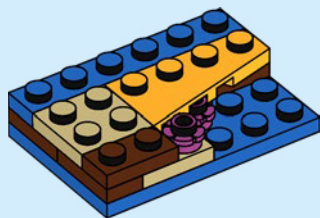



1x



2x



2x

5

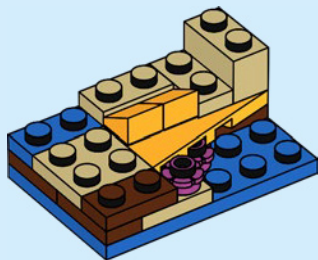

1x



2x



1x

6

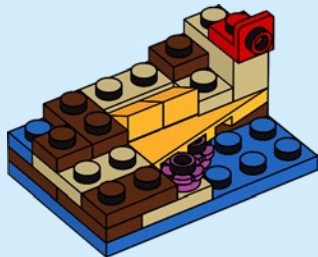

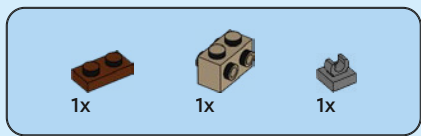

7

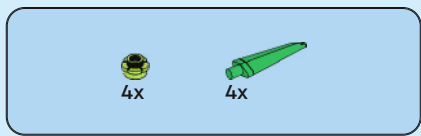
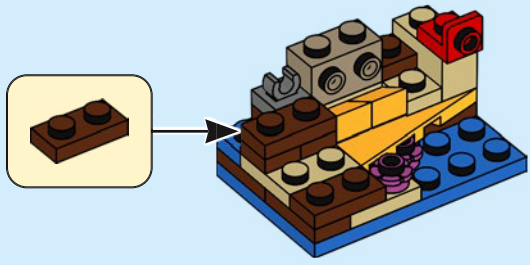

8

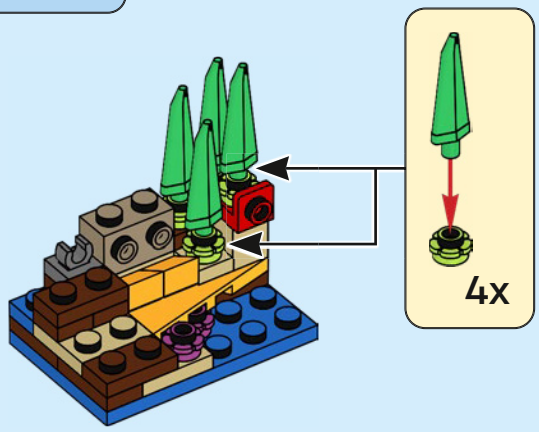



2x



2x



1x

9

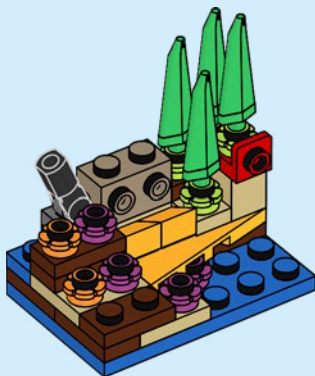

2x

10

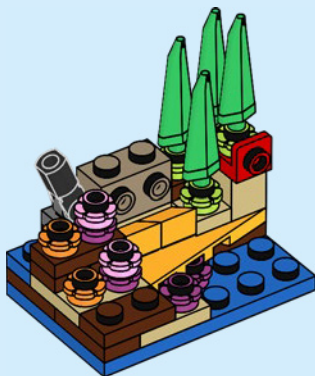



1x



1x

11

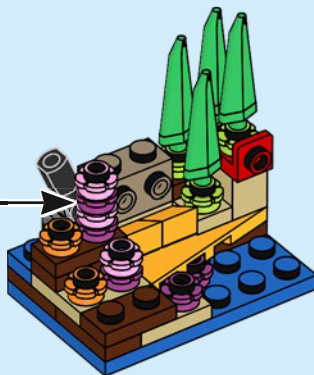
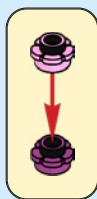

2x

12

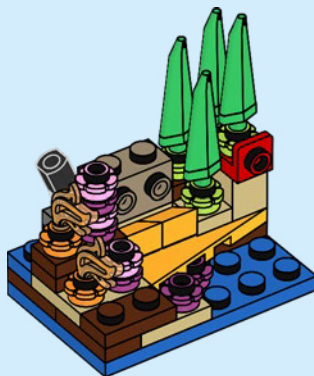



2x



2x

13

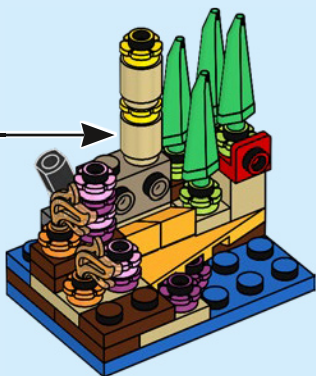
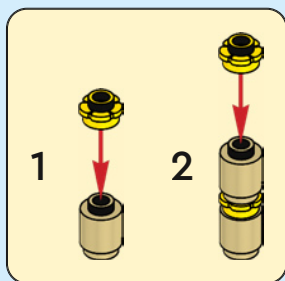

2x



3x

14

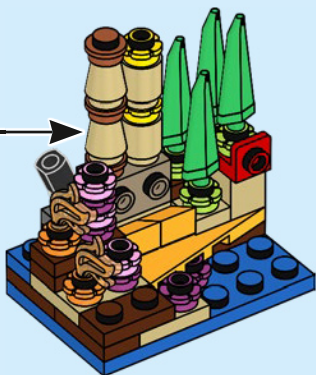
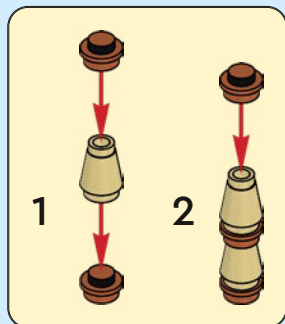



6x



1x

15

1

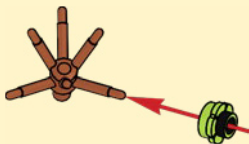

2

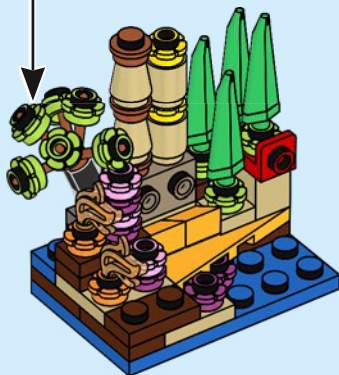



2x

16



2x



2x



2x

17

1



2



2x



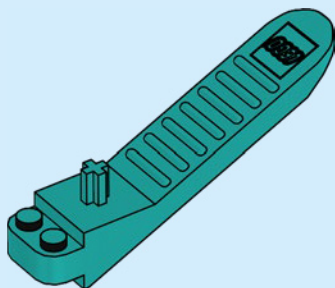
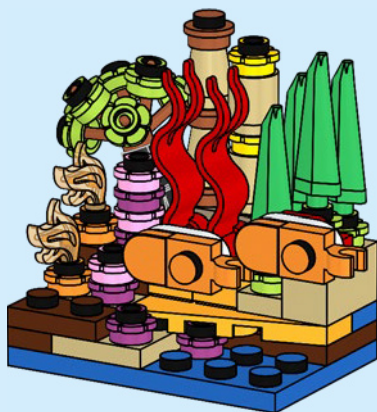



4x
4558952



2x
4504369



6x
6172927



4x
6045936



2x
302401



5x
371001



2x
4243812



2x
6174937



1x
6313115



2x
6284599



2x
6284604



2x
6210272



2x
403201



2x
368001



1x
614301



8x
6308000



2x
6016172



1x
6313508



1x
6018805



2x
6116604



2x
6170693



2x
6321194



2x
6299813



4x
6337597



2x
4109995



4x
6175968



2x
4529237



2x
4117070



2x
4159196



2x
4550323



3x
6092587



3x
4113917



2x
4114084



3x
4113233



1x
6265305



2x
614321



3x
4504379



2x
6184782



4x
6029946



1x
302421



1x
302121



4x
6249907



1x
6337002



1x
6001806



2x
6360036



2x
6286215



1x
6132541



2x
6268946



6x
4504371



2x
4616279



2x
6177499



2x
6177490



4x
4524929



2x
4177932



2x
4159007



5x
4118782



6x
4158355



2x
6347295



1x
6289113



10x
6344851



2x
6218367



2x
6214234



2x
4211388



3x
6013658



3x
6296963



1x
302023



1x
4277016



6x
4521921



2x
4210635



6x
6023173



1x
366623



8x
4221744



2x
4211614



2x
6344022



4x
6099728



1x
379523



8x
4211150



1x
4211494



1x
4225733



1x
6097511



1x
379523



1x
4211247



2x
6066097



1x
6362252



1x
6227662



1x
6227663



1x
303223



1x
4211247



2x
6225246



2x
4566028



1x
6227662



1x
6227663



2x
6347291



3x
6212501



1x
4211632



5x
6209682

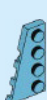

1x
6296847



1x
6296848



2x
6390153



2x
6314353



2x
4211475



3x
6135609



1x
6296847



1x
6296848



4x
6270084



2x
6371448



3x
6315782



2x
6353494



4x
6270084



2x
4540203



2x
6269941



2x
6353494



4x
6270084



4x
6328333



10x
6209692



2x
6353494



4x
6270084

4x
6328333

10x
6209692



2x
6353494



4x
6270084

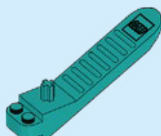

1x
6254100

 [LEGO.com/service](https://www.lego.com/service)



YOU COULD

WIN



Scan this QR code or go to **LEGO.COM/PRODUCTFEEDBACK** and give us your short feedback about this LEGO® set for a chance to win a cool LEGO prize.

Terms and Conditions apply*

EN: YOU COULD WIN. Terms and Conditions apply* **DE: Du könntest GEWINNEN.** Es gelten die Teilnahmebedingungen* **FR: Tu pourrais GAGNER.** Des conditions s'appliquent* **IT: Potresti VINCERE tu.** Termini e condizioni sono applicabili* **ES: Puedes GANAR.** Aplican términos y condiciones* **PT: Poderá GANHAR.** Aplicam-se termos e condições* **ZH: 轻松获奖. 条款和条件适用*** **PL: Szansa na WYGRANĄ.** Obowiązują warunki korzystania* **CS: Máte šanci VYHRÁT.** Platí všeobecné smluvní podmínky* **SK: Máte šancu VYHRAŤ.** Platia všeobecné zmluvné podmienky* **HU: TE IS NYERHETSZ.** Felhasználási feltételek érvényesek* **RO: Ai putea CÂȘTIGA.** Se aplică termenii și condiții* **BG: Можете да СПЕЧЕЛИТЕ.** Има определени правила и условия* **LV: Tu vari LAIMĒT.** Ir spēkā noteikumi un nosacījumi.* **ET: Sul on võimalus VÕITA.** Kehtivad tingimused* **LT: Jūs galite LAIMĖTI.** Taikomos sąlygos*

*[LEGO.com/productfeedback-terms](https://www.lego.com/productfeedback-terms)