



6+
30564



6345930

1

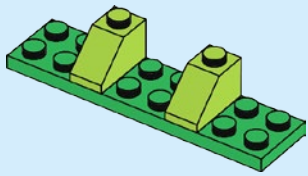

3

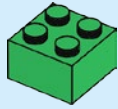

4

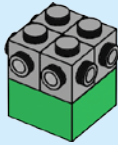

5

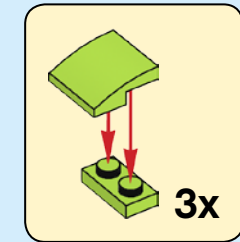

6

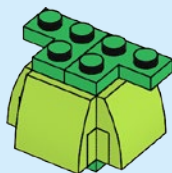

7

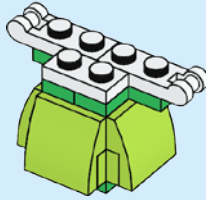

8

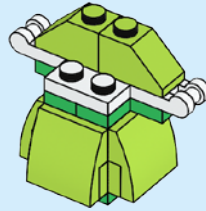

9

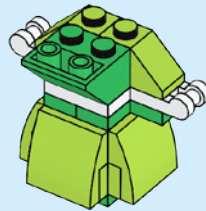

10

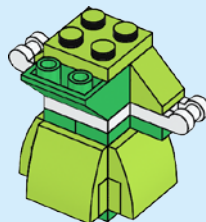

11

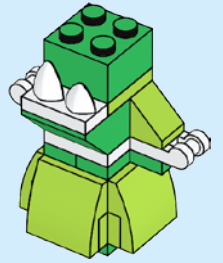

12

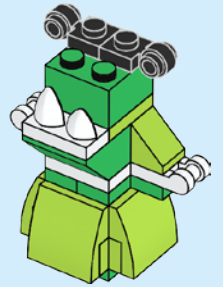

13

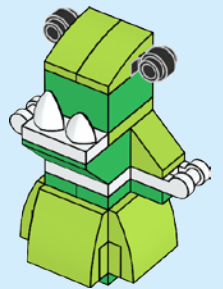

14

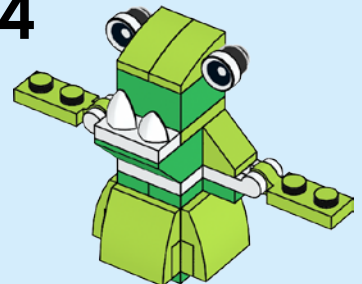

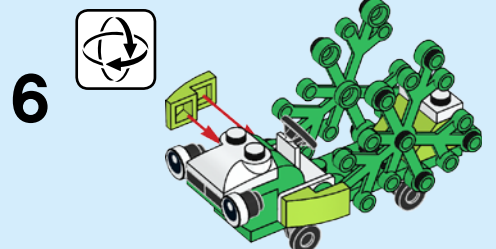
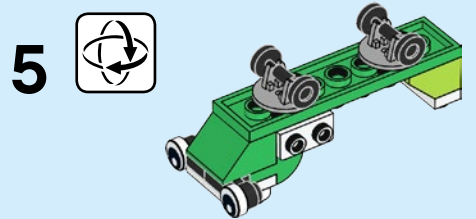
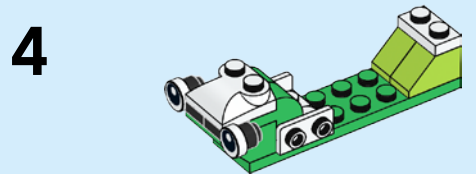
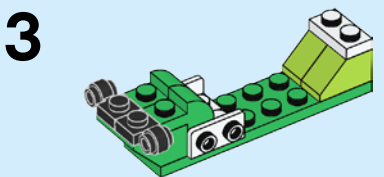
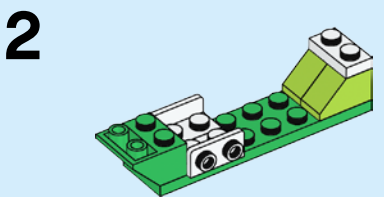
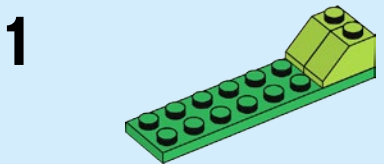
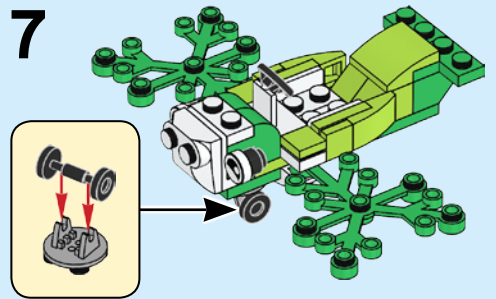
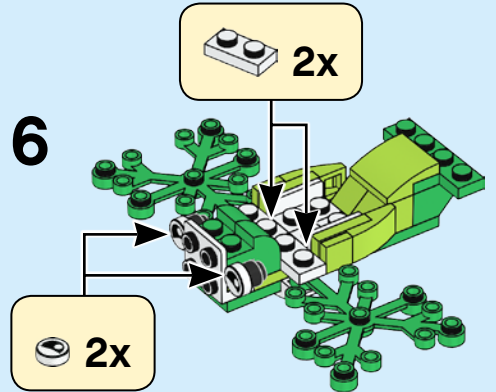
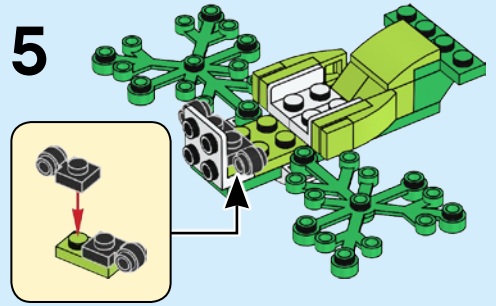
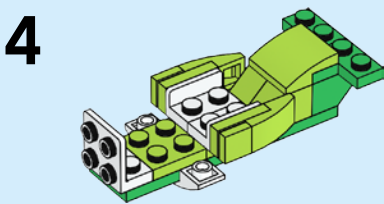
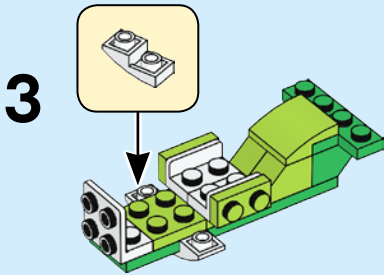
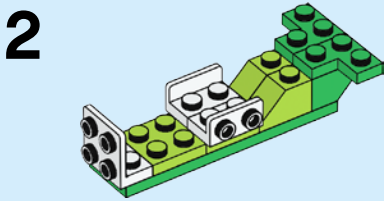
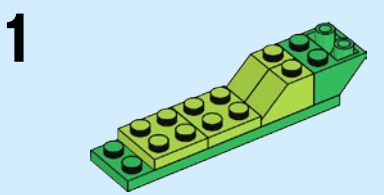
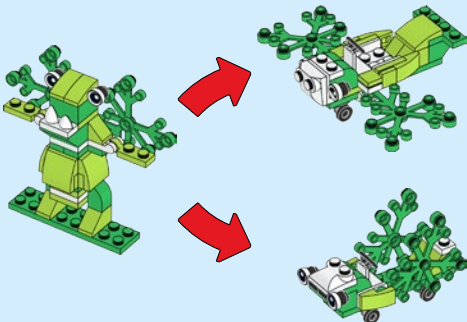
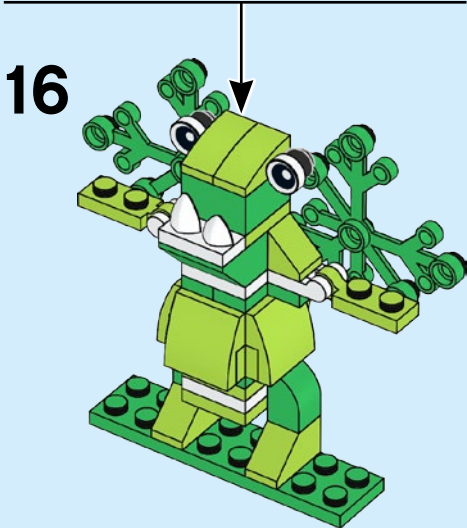
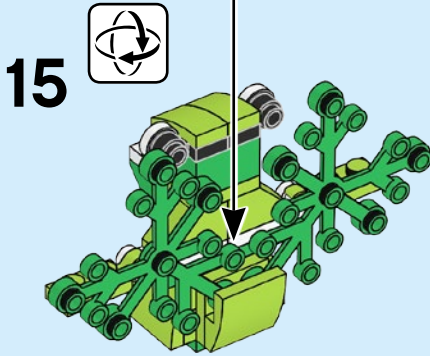
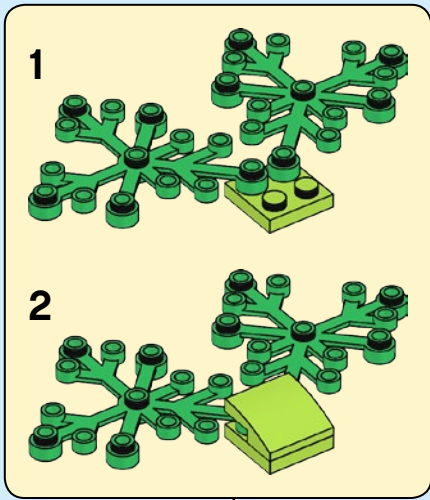

3x 302301	2x 6172927	2x 6284605	2x 6284599	2x 6070698	2x 6281993	2x 6152344	2x 6069006	2x 6138122	4x 6138661	4x 4537251	2x 4157120	2x 6266968	1x 303428	2x 6100223
2x 4515364	1x 6046384	1x 9551	1x 6097637	1x 4494474	2x 249626	4x 6267495	3x 4164037	4x 4537925	4x 4537937	2x 300328	1x 4142717	2x 6266968	1x 303428	2x 6100223