



# H USE

Home of the Brick™

1  
LIMITED  
EDITION

40501



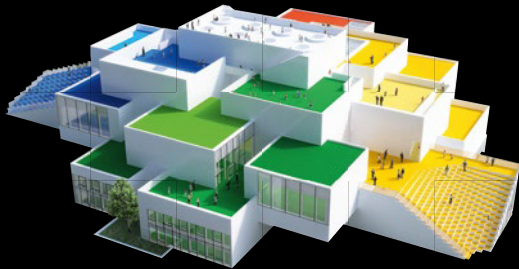

## What is LEGO® House?

LEGO® House is a unique experience house located at the centre of Billund – Home of the Brick™.

The building allows LEGO fans of all ages to feel the magic of the LEGO universe and have the ultimate LEGO experience all year round. A number of new LEGO experiences and 25 million LEGO bricks will greet children and adults alike, inviting them to unleash their creativity.

LEGO House includes paid attractions as well as experiences open to the public. You will not need a ticket to visit LEGO Square, play on the terraces, explore the LEGO Store and treat yourself to extraordinary culinary experiences with a LEGO twist at one of the three eateries.

## Wooden LEGO toys – and a duck’s tale

The story of the LEGO company starts more than 100 years ago, in 1916, when 24-year-old Master Carpenter Ole Kirk Kristiansen (1891-1958), buys a workshop in the tiny town of Billund, Denmark.

### From carpenter to toy manufacturer

Ole Kirk settles in Billund and starts his carpentry business building houses, stables and pieces of furniture. He quickly becomes known and well-liked for his skilled craftsmanship and his focus on quality, and up through the 1920s his workshop is bustling.

However, by the early 1930s, the dark shadows of the worldwide Great Depression are threatening to close down Ole Kirk’s business for good. As a means to saving his business and put food on the table for his family, Ole Kirk turns his skills to creating a range of wooden toys for children.

The hand-painted, red fire engines, beautiful shaped yo-yos and skilfully carved horse-drawn wagons become the beginning of not just a new life and a new career for Ole Kirk, but also of the LEGO company.

### Children deserve the best

From the very first toys coming out of Ole Kirk’s workshop, the dedication to quality and functionality is obvious. The design and the carving, sanding and painting of each toy is done to perfection because Ole Kirk is convinced that children deserve toys of high quality, made of the finest materials, so that they will last for many years of play.

- “Children deserve the best,” Ole Kirk would say, and he later adopts the motto **“Only the best is good enough”**.

This way of thinking is also reflected in his choice of name for his new toy producing company: In 1934, Ole Kirk comes up with the name “LEGO” by contracting the Danish

words “LEg GOdt”, meaning “Play Well” – a name which places the emphasis firmly on developing children’s play, and at the same time focusing on quality in preference to mass production.

## Quality above all

During the 1930s and 1940s, Ole Kirk’s business is steadily growing. The product portfolio is wide and consists of everything from cars, busses, trains and tractors to letter blocks and the very popular pull-along animals.

In the early years, most of the toys are designed by Ole Kirk himself, and some are designed by Ole Kirk’s son, Godtfred Kirk Christiansen (1920-1995). From a young age, Godtfred Kirk takes a keen interest in the business, and in fact later takes over from his father, becoming owner of the company.

Every piece of toy is crafted from carefully selected beech wood of the finest quality. Before being used in the toy production, the beech wood is first air-dried for two years, then kiln-dried for three weeks. The rationale behind the very meticulous process is simple: If you wish to create a top-quality toy, it all starts with a top-quality material.

In 1937, Ole Kirk decides to invest in a milling machine, which at the time is cutting-edge wood-working technology. With a gift for spotting potential, and the courage to take a chance, Ole Kirk spends a large sum of money on the machine. But he is in no doubt about the investment; the machine will increase the quality of the wooden toys as well as help speed up production.

## The LEGO® duck

Amongst the many pieces of wooden LEGO toys that were designed and produced throughout the early years of the company’s existence, the wooden duck stands out. The duck has become a symbol of Ole Kirk’s and the LEGO Group’s motto “**Only the best is good enough**”. It has grown to become the embodiment of quality.

To find the reason for this, we need to go back to 1935 when the wooden duck was first produced.

In an interview from 1982, Ole Kirk’s son, Godtfred Kirk, shares the following story about his father’s focus on quality:

Working in his father’s workshop as a boy, Godtfred Kirk is laying the finishing touches on a consignment of wooden LEGO ducks. This means applying coats of varnish, and finally bringing the boxes with the finished toy ducks to the train station for dispatch. Back at the workshop, Godtfred proudly announces to his father that he has done something really clever and saved the company money.

– “How did you manage that?” asks Ole Kirk.

– “I gave the ducks just two coats of varnish, not three as we usually do,” is Godtfred Kirk’s answer.

Back comes his father’s prompt response:

– “You will immediately fetch those ducks back, give them the last coat of varnish, pack them and return them to the station! And you will do it on your own – even if it takes you all night!”

– “That taught me a lesson about quality,”

Godtfred Kirk recalls, and continues to explain how he then carved out wooden signs with his father’s motto “**Only the best is good enough**” to hang on the walls of the workshop to remind himself and the rest of the employees never to compromise on the quality of a LEGO product.

Throughout his life, Godtfred Kirk remembers his father’s words and to this day, “**Only the best is good enough**” – because children deserve the best.

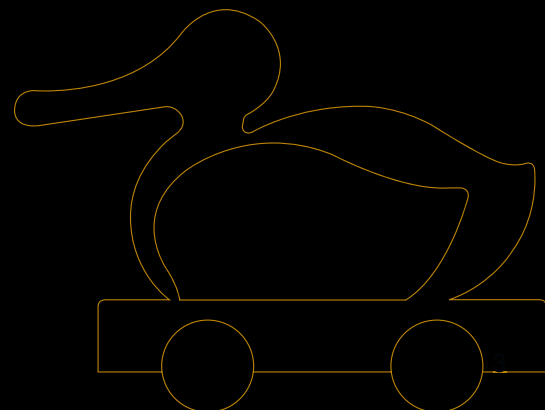

## Duck Facts:

- Between 1932 and 1947, the LEGO® company solely produced wooden toys.
- From 1947 onwards, the LEGO company produced both wooden and plastic toys before switching solely to plastic in 1960.
- The wooden duck went on the drawing board in 1935 and was produced until 1960.
- The duck was designed by LEGO founder Ole Kirk Kristiansen.
- Many shapes and feathers... Through the years, the duck has been produced in various sizes and shapes.
- The most popular duck was the same type as the one in this exclusive LEGO set: It has a moving beak which opens and closes when the duck is pulled back and forth.

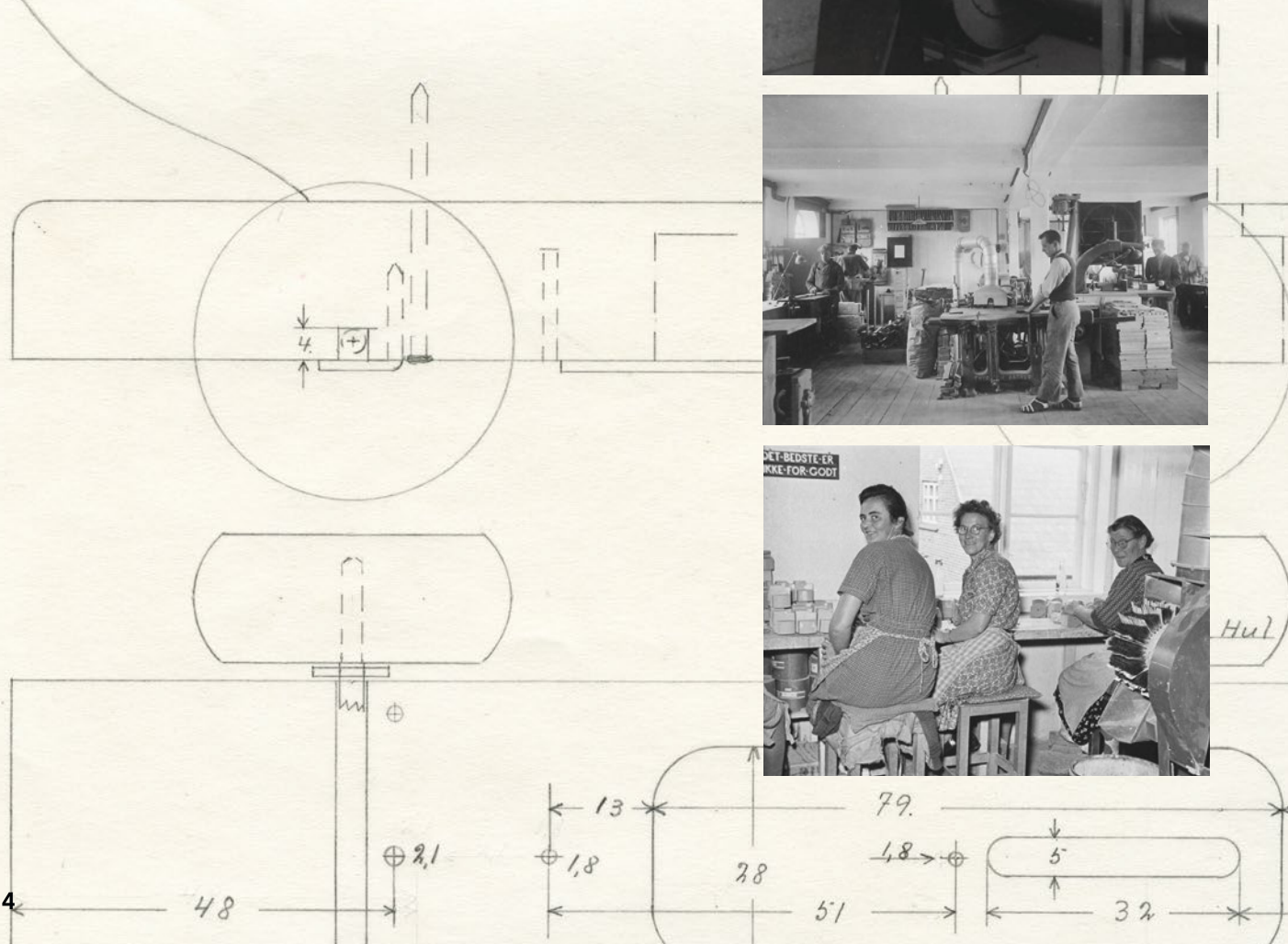





# HOUSE

Home of the Brick™

## The duck-prints in LEGO® House

Already when LEGO® House was nothing but a few ink strokes on paper, one of the core ideas was that the LEGO history should play a vital role throughout the finished house. The history is the foundation that the entire company is built on and obviously, this should be reflected in several layers within the playful LEGO House environment.

So where do we find duck-prints when we look around the premises?



## History Collection

The most obvious place is the History Collection in the basement of LEGO House. This entire part of LEGO House is dedicated to telling the story about how the LEGO brand has developed into one of the most beloved brands in the world. And the duck of course has a very prominent spot in the exhibition – right in front of the sign with “**Only the best is good enough**”.



## Tree of Creativity

When guests first enter LEGO® House, they meet the Tree of Creativity, built from more than six million LEGO bricks and 15.68 metres tall. The model is not just impressive in its size – but also in its detail and surprises, making sure that even the most hardcore LEGO enthusiast will be impressed by its creativity. When you look closely, you'll find engravings in the trunk and one of them is – surprise – the duck.

The tree is a beloved motive on LEGO House's Social Media channels, and the tree and the duck are often used in humorous contexts.



## Creative Lab

Another duck reference can be found in the Creative Lab in the Red Zone where one of the LEGO House monkeys is taking the wooden duck (made from LEGO bricks) for a stroll.

LEGO House will keep adding little duck details around the house. The iconic duck is timeless and over the years has become the symbol of Ole Kirk's and the LEGO Group's motto "**Only the best is good enough**". You are welcome to come to LEGO House and have a look for yourself.

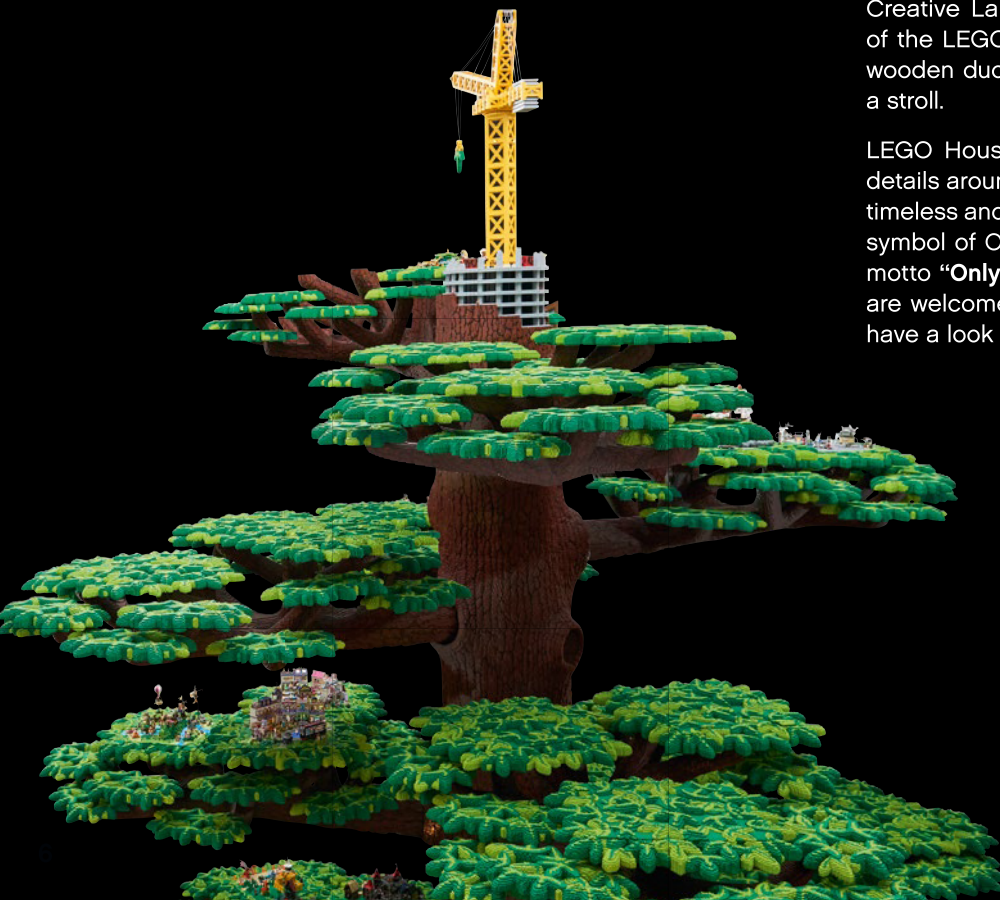



## World Explorer

If you look very closely, there is another duck reference in one of the World Explorer dioramas. Back in 1953, Wonderful Copenhagen issued a famous poster with a police officer holding back traffic in order to allow a mother duck and her chicks to pass the road. In the LEGO® House edition of the reenactment, the duck has turned into the LEGO duck.



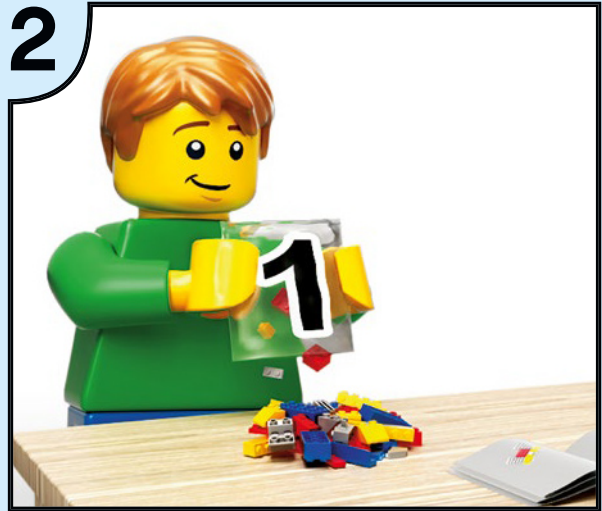



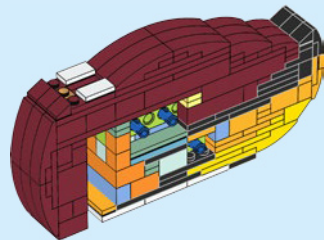
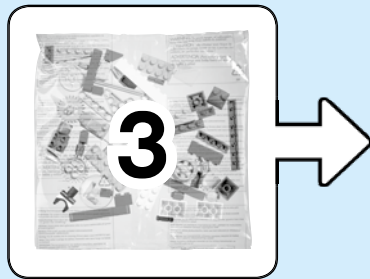
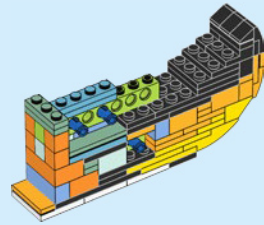
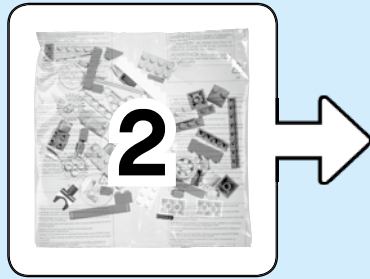
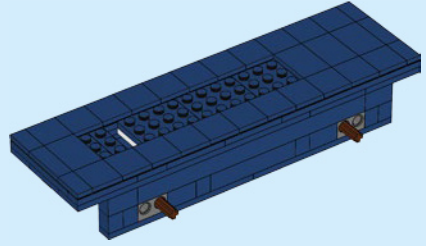
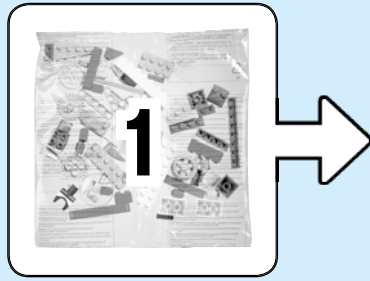

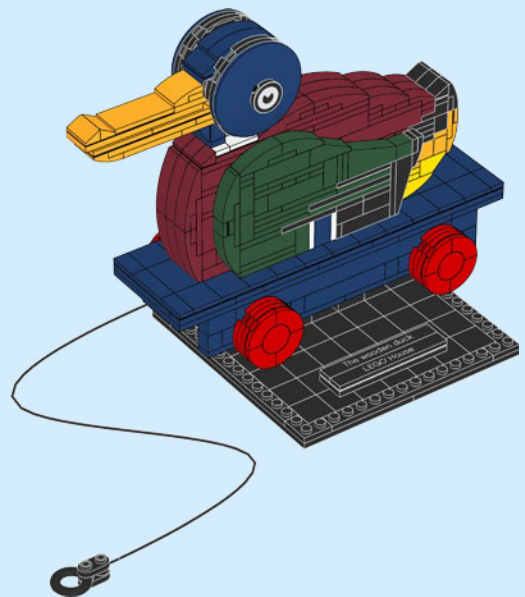
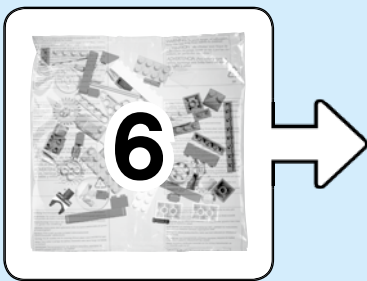
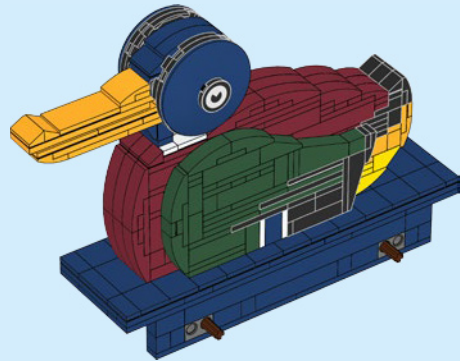
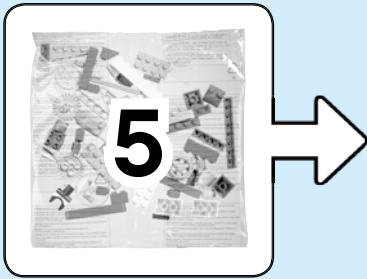
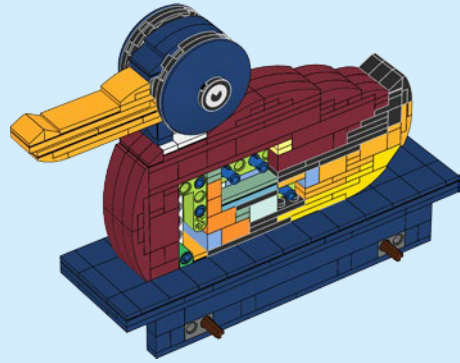
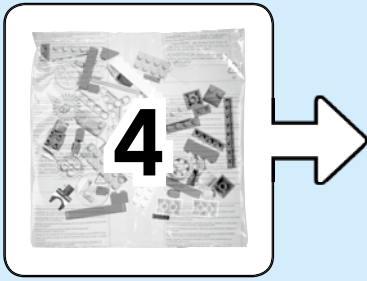

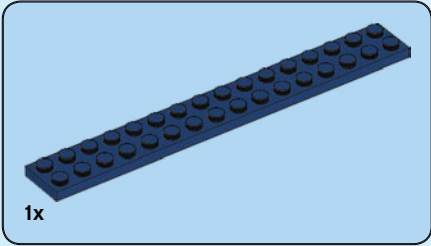
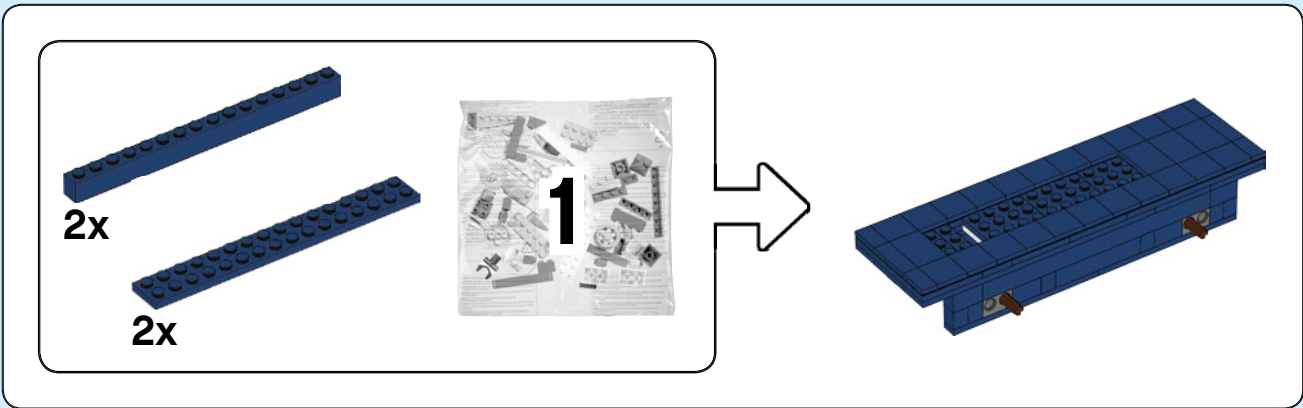

1

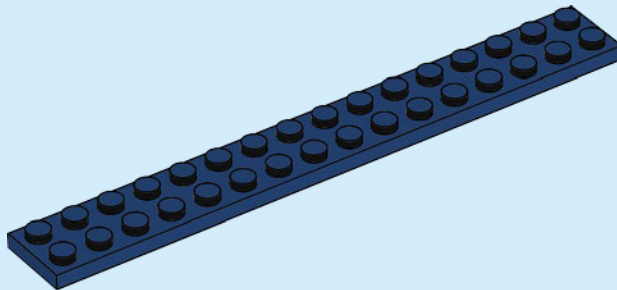

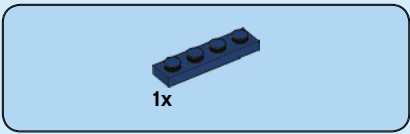

2

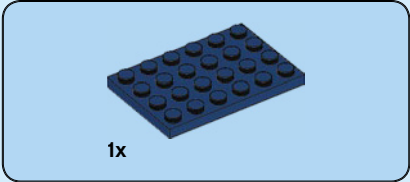
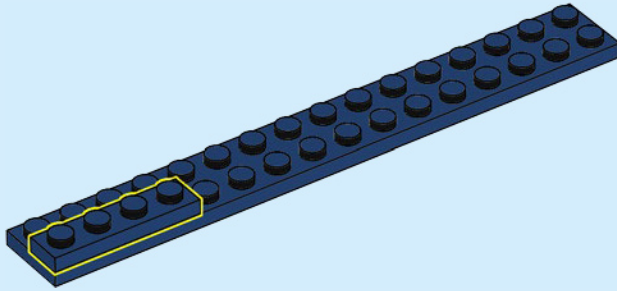

3

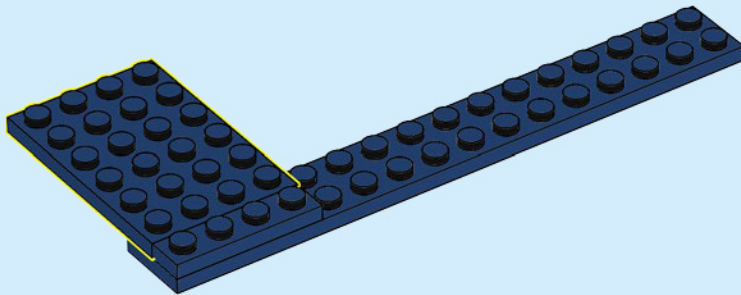



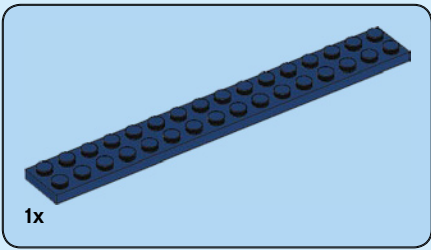

4

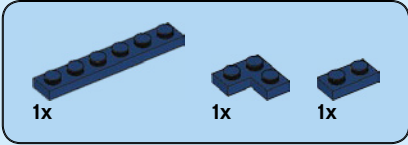
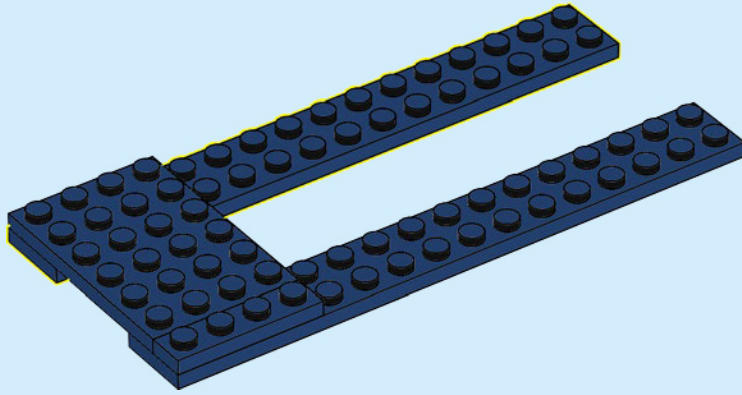

5

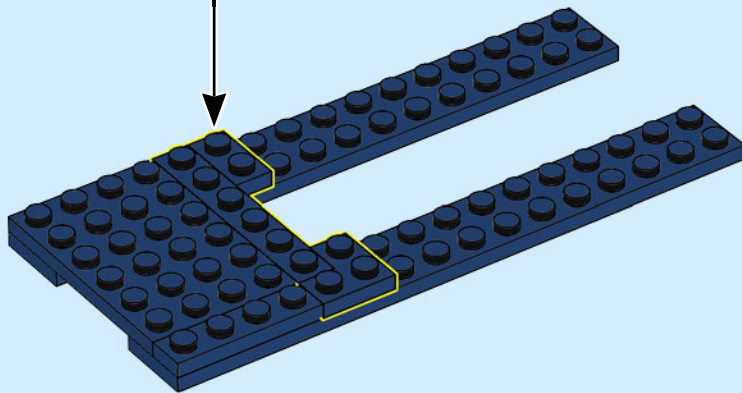
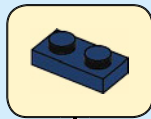

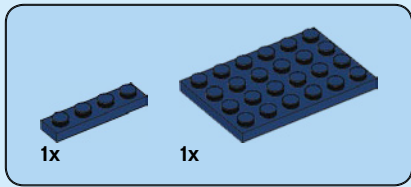

6

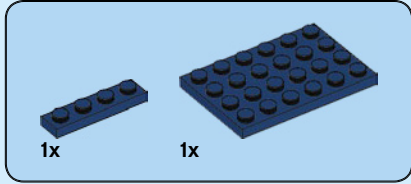
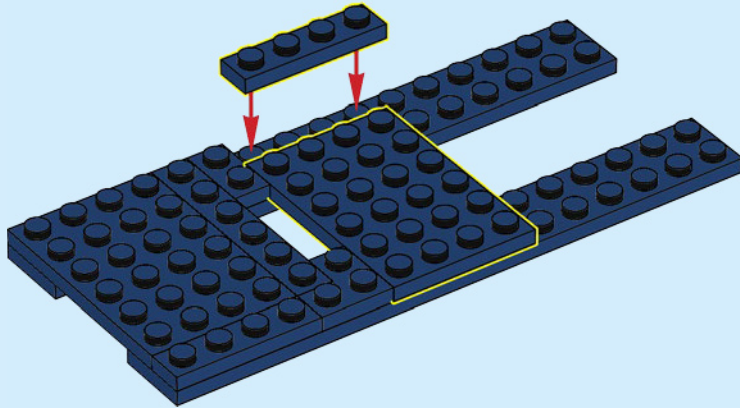

7

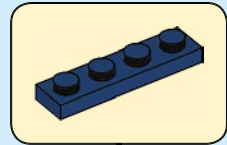
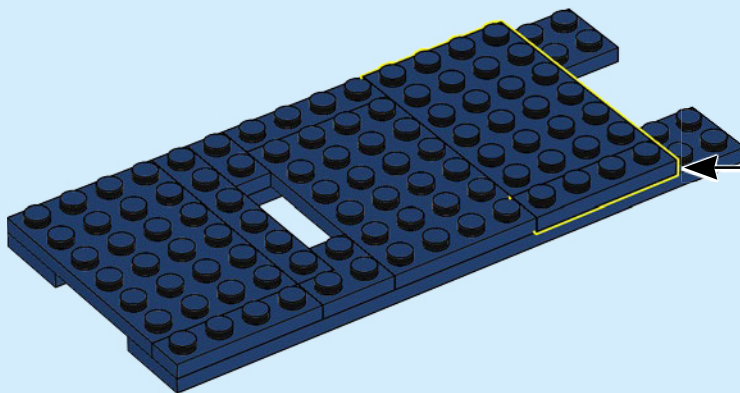

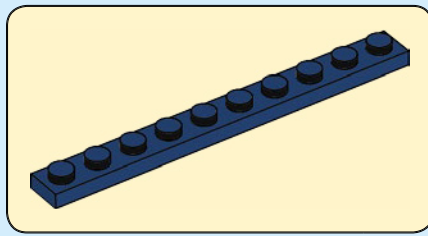
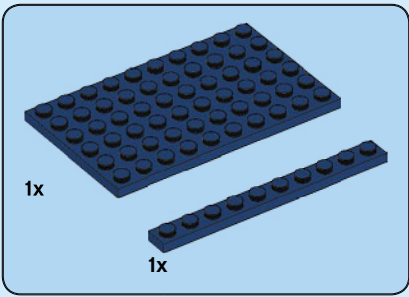

8

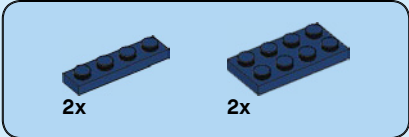
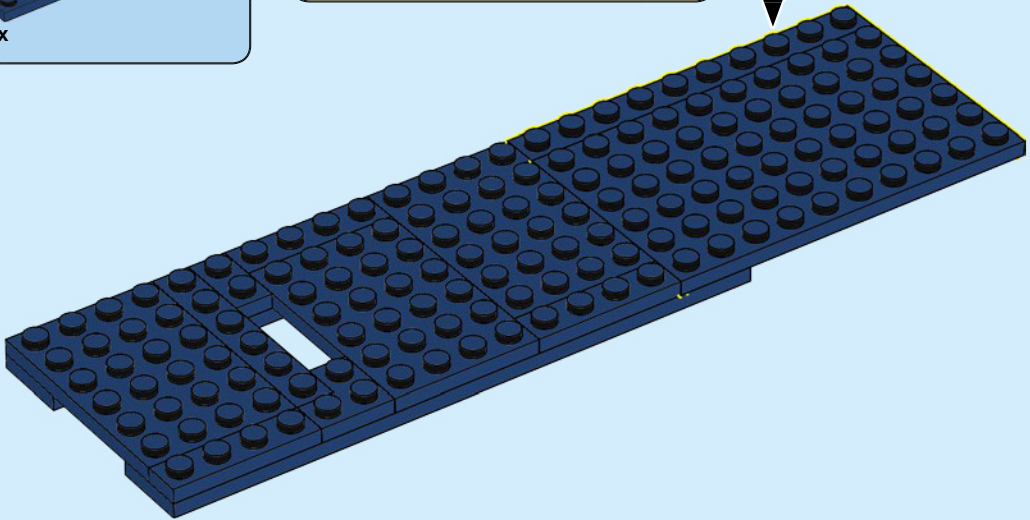

9

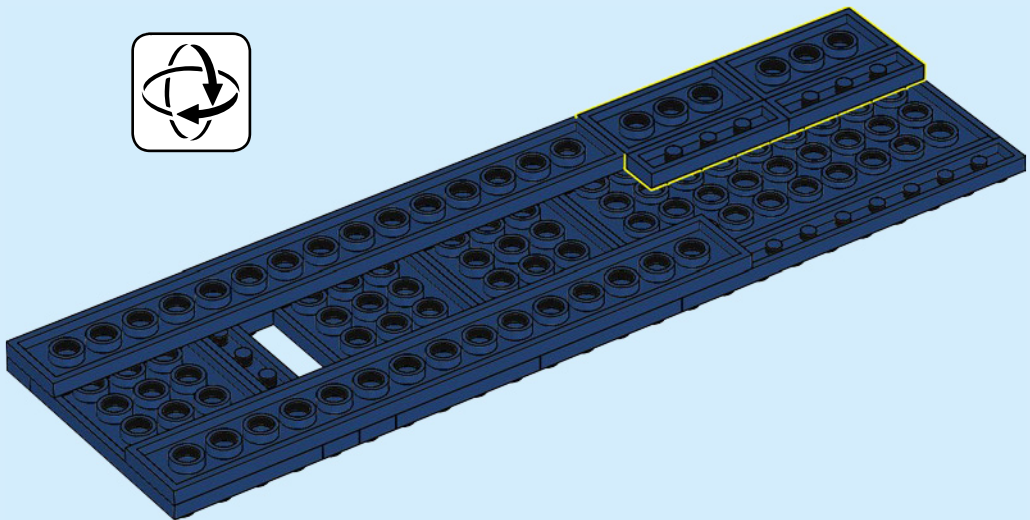

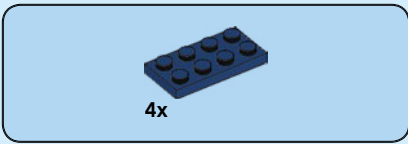

10

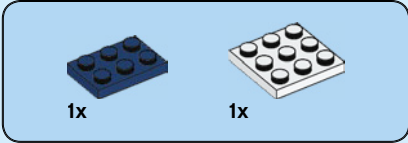
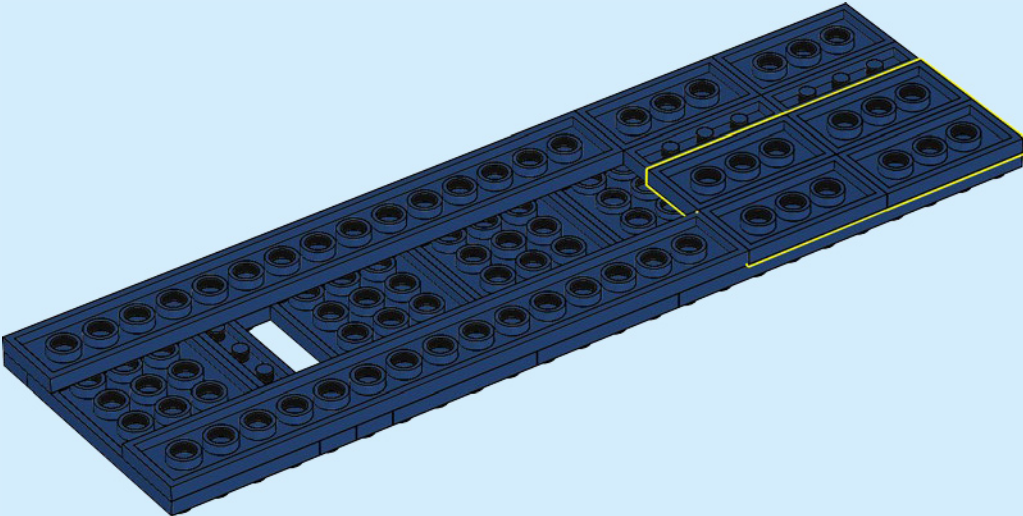

11

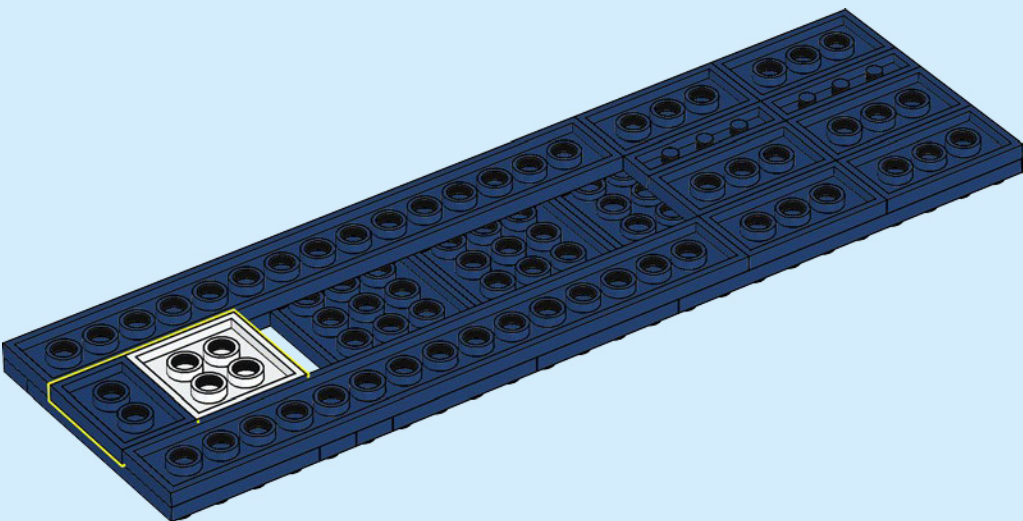



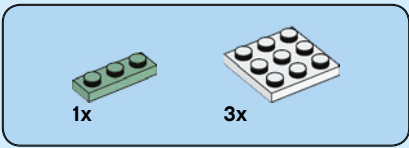

12

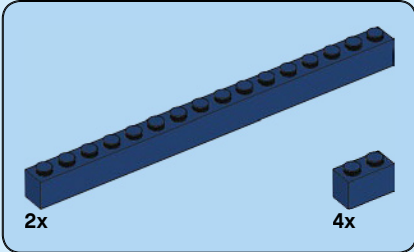
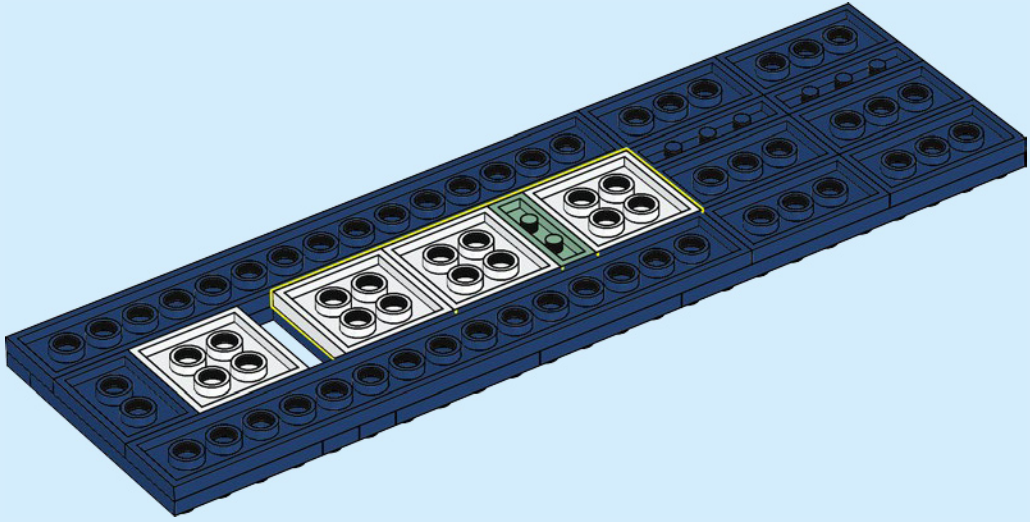

13

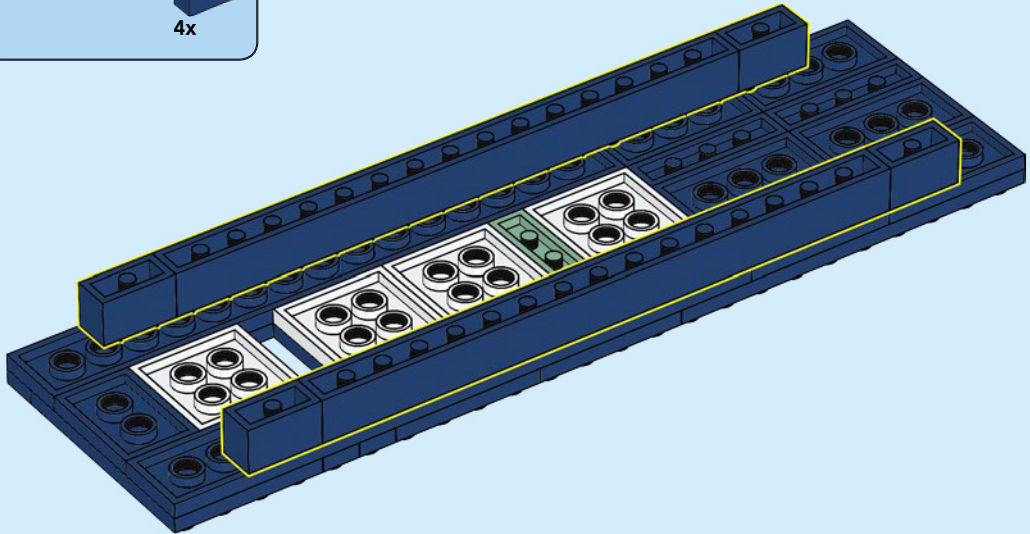

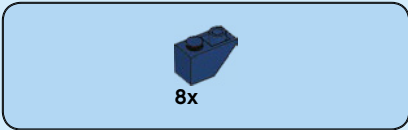

14

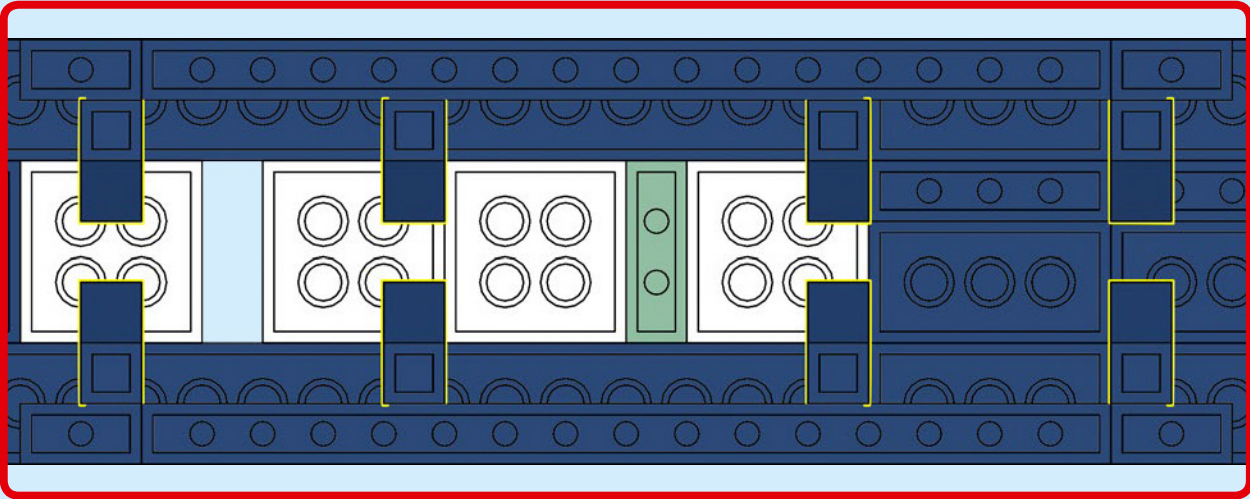
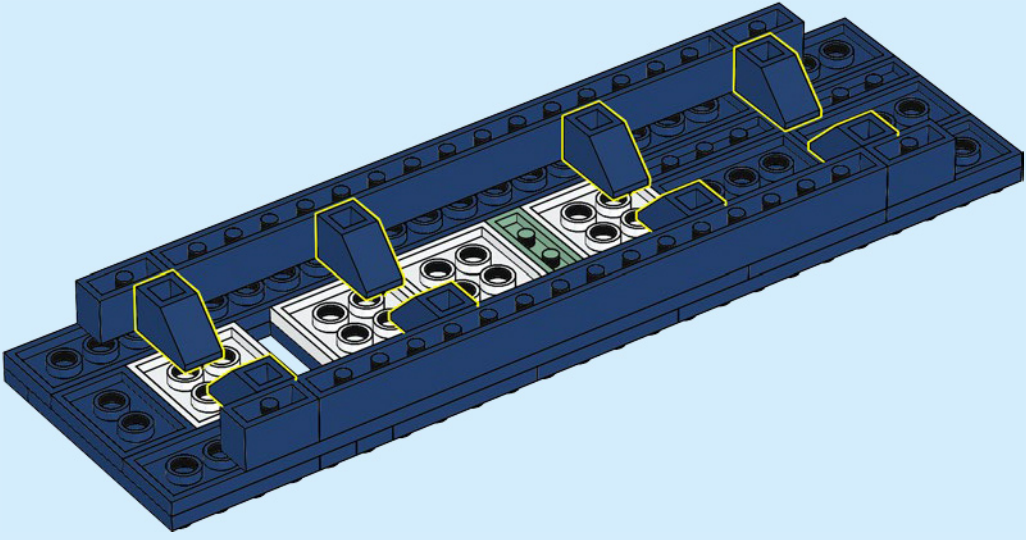



15

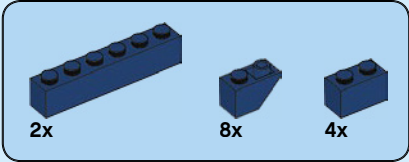
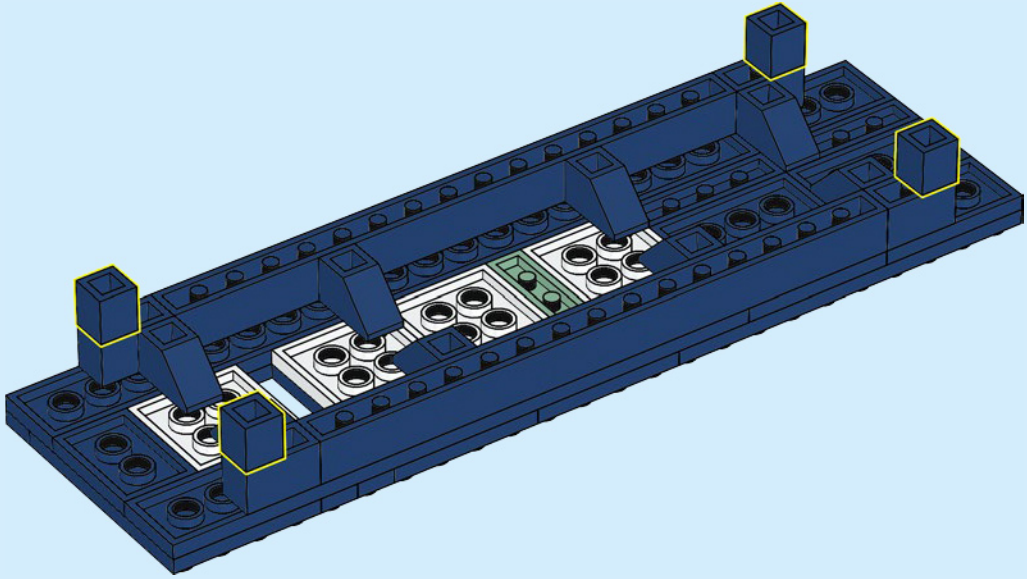

16

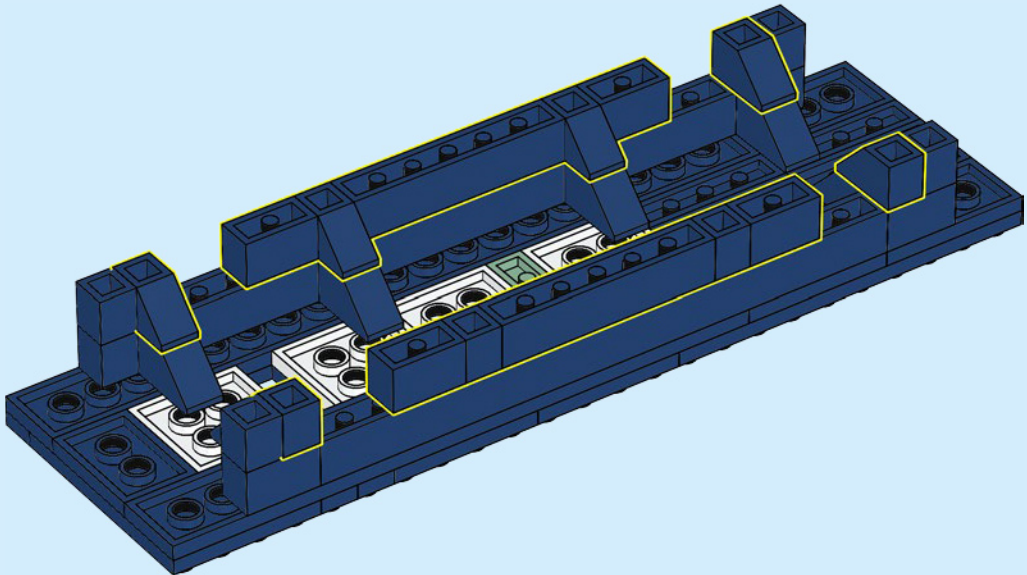

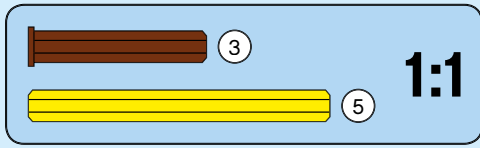
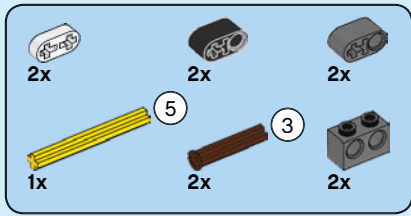

# 17

1

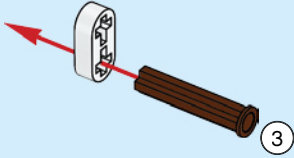

2

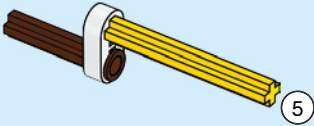

3

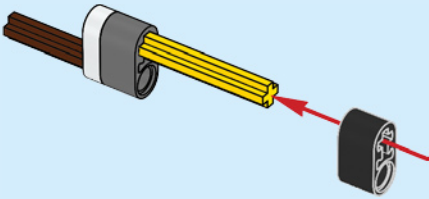

4

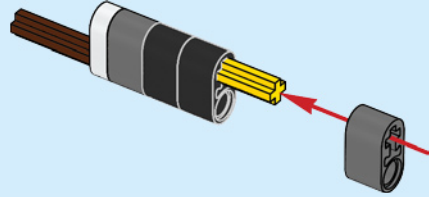

5

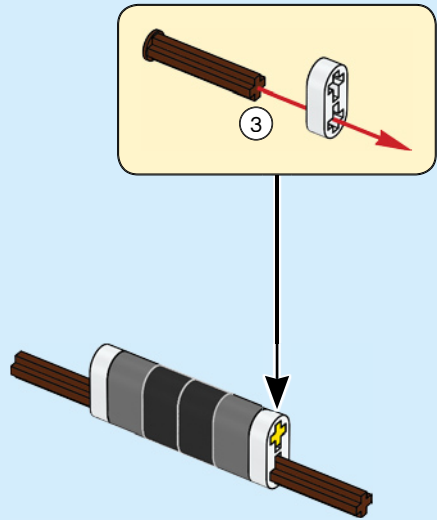



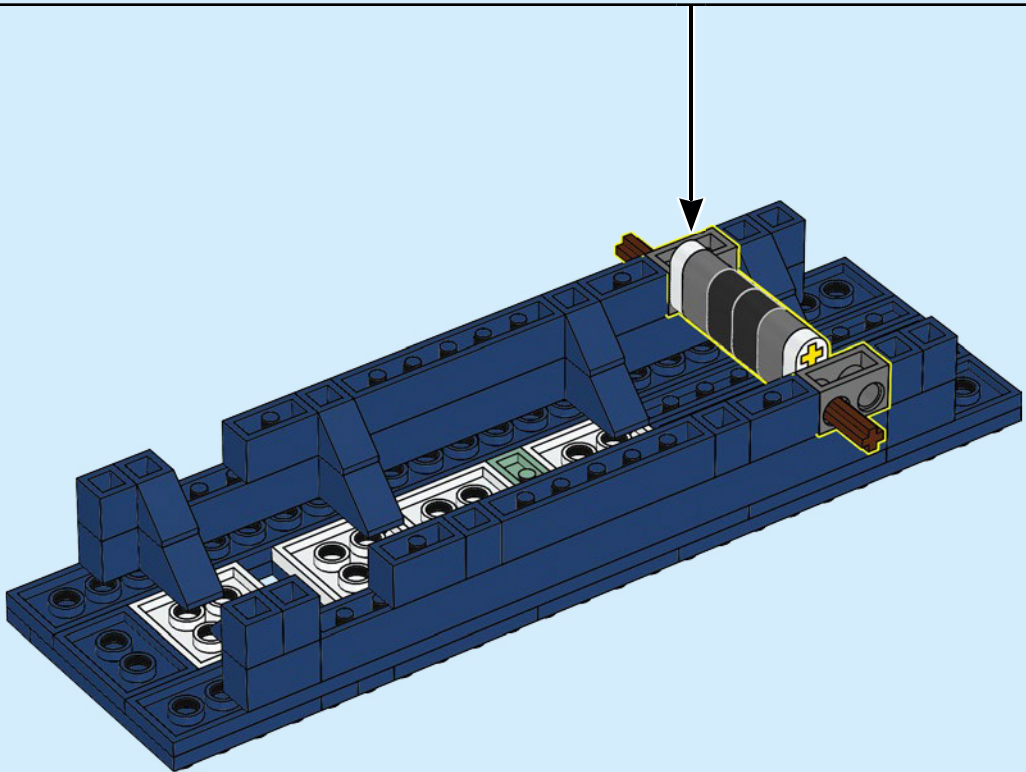
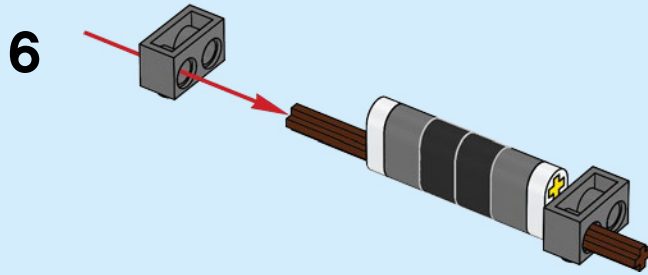

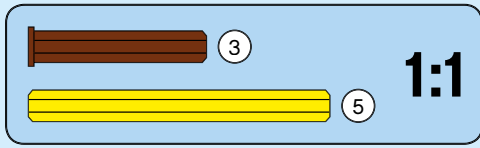
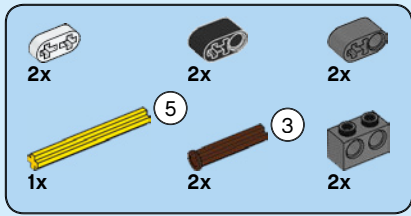

# 18

1

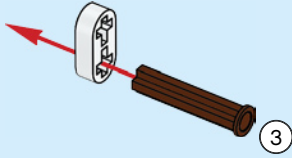

2

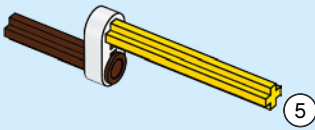

3

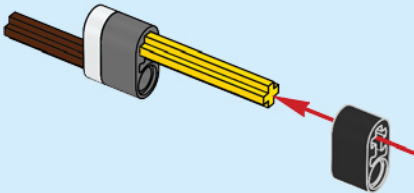

4

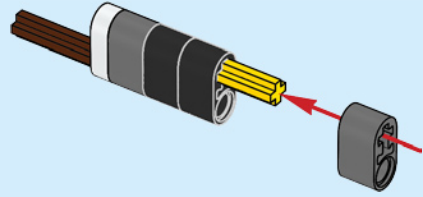

5

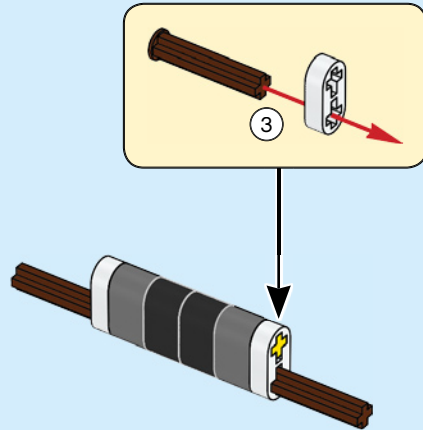

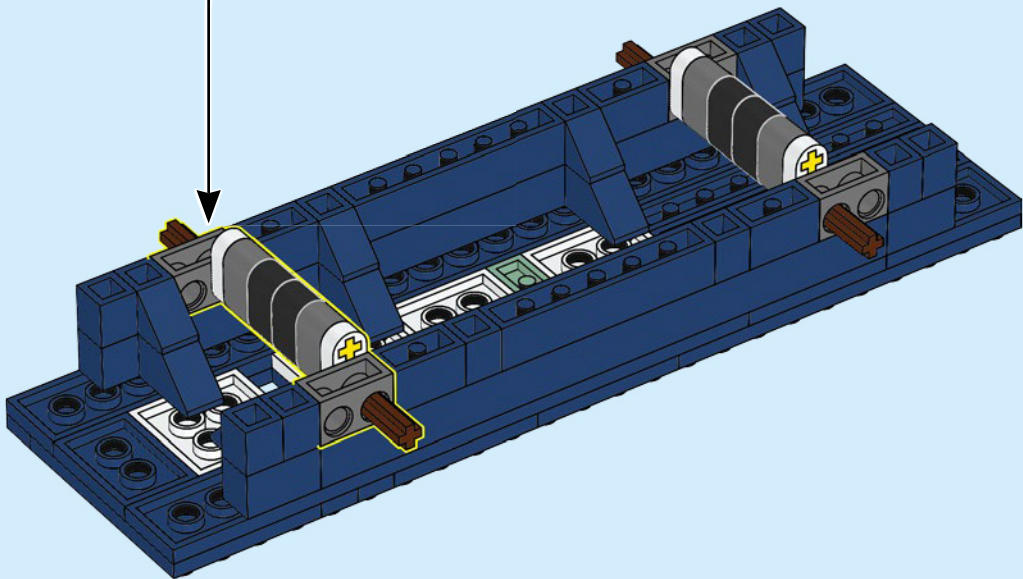
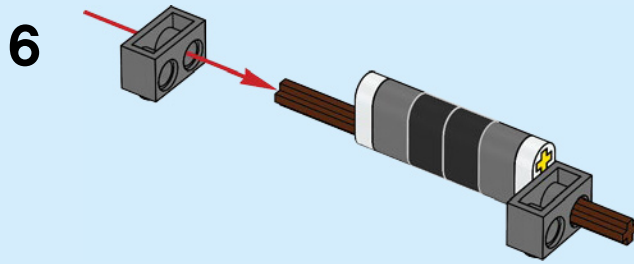

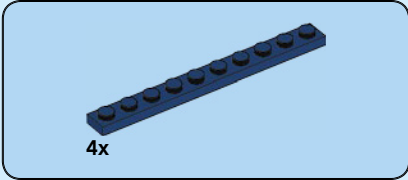
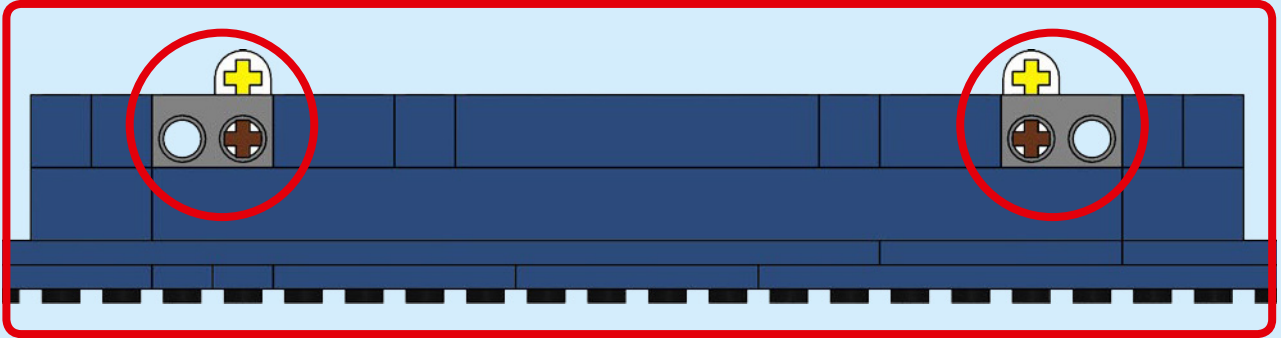

19

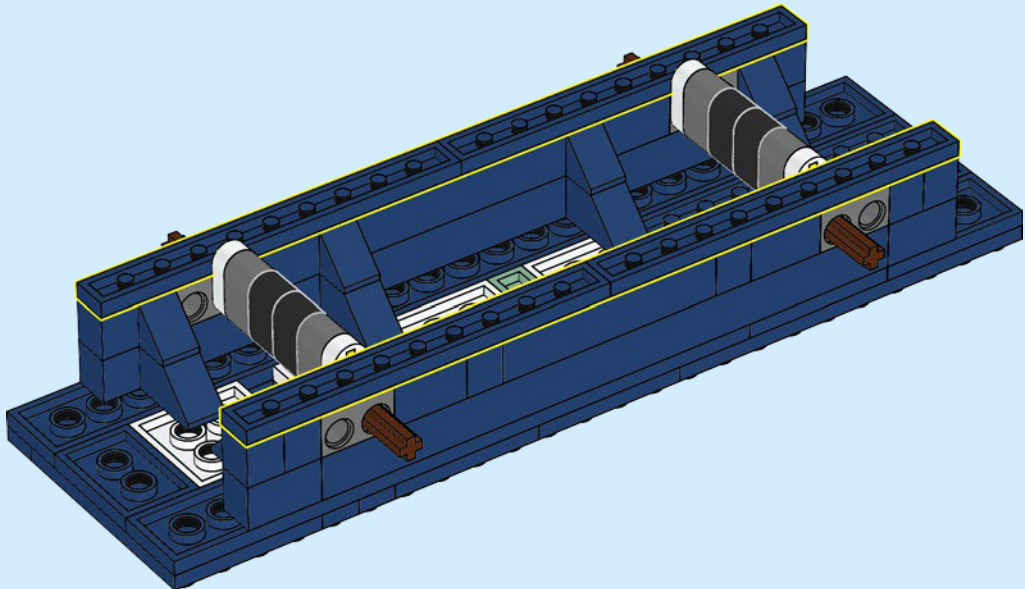

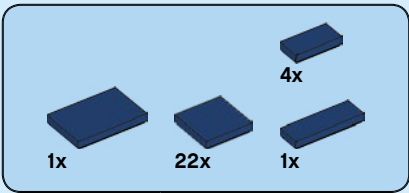

20

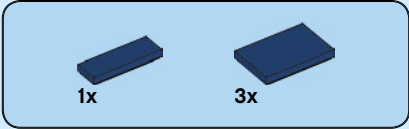
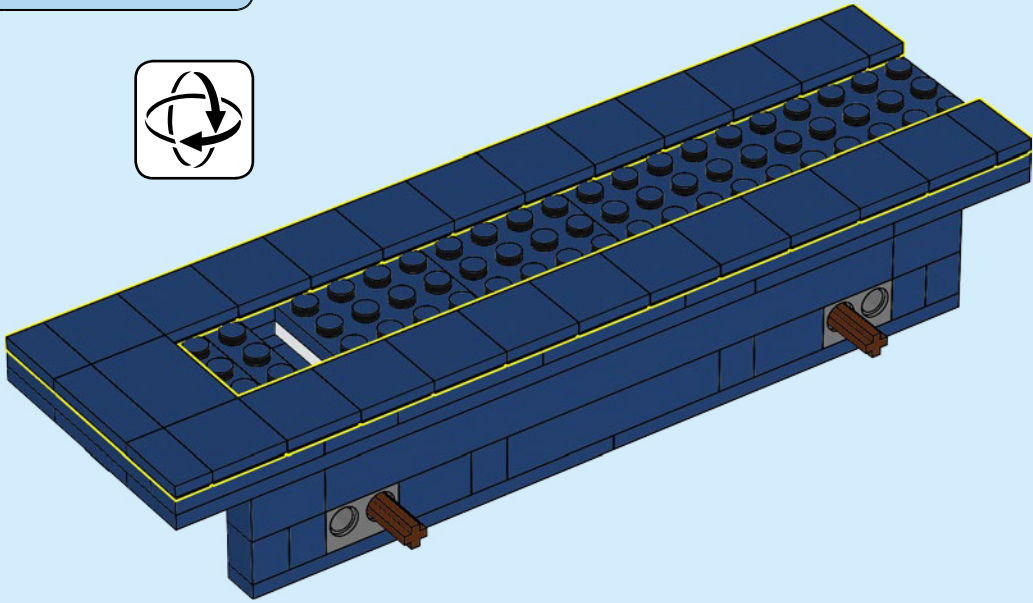

21

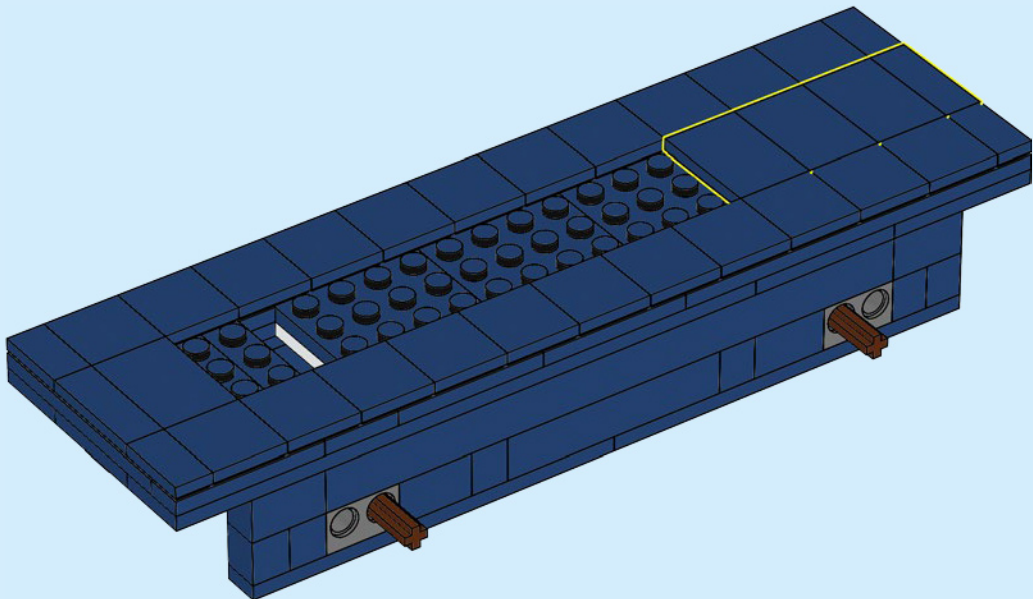



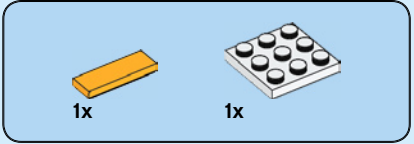
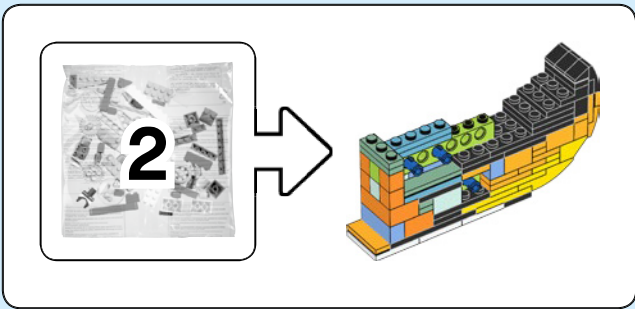

**22**

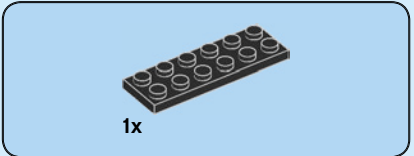
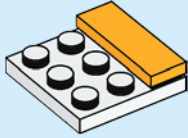

**23**

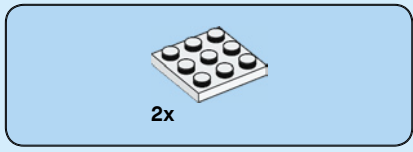
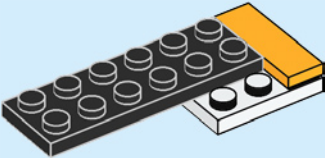

**24**

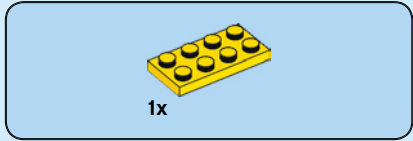
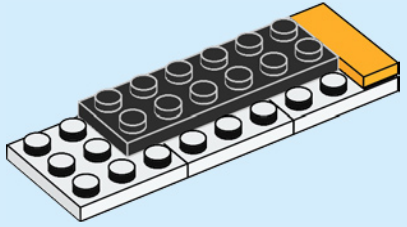

**25**

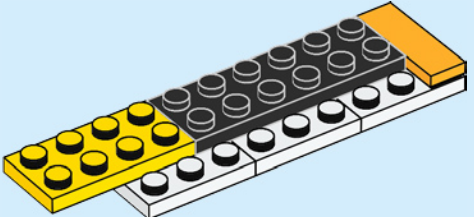

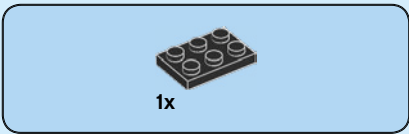

26

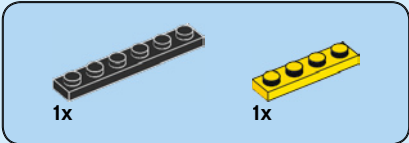
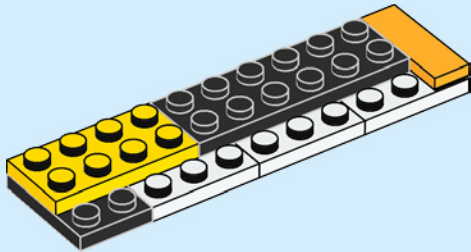

27

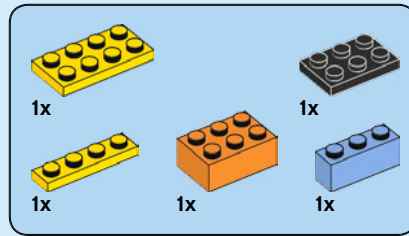
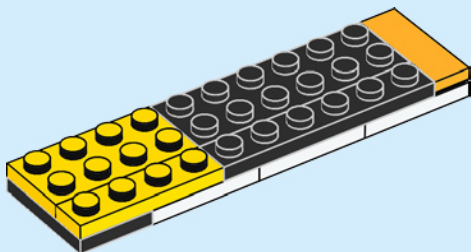

28

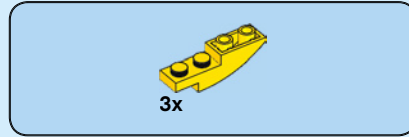
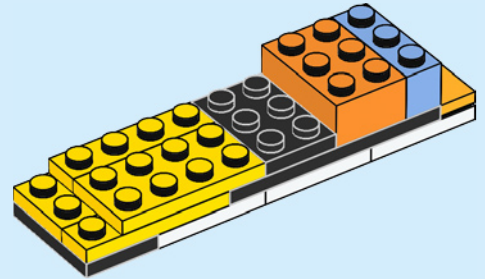

29

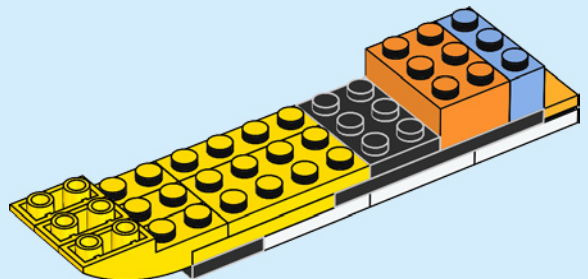

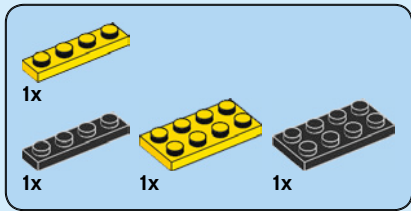

30

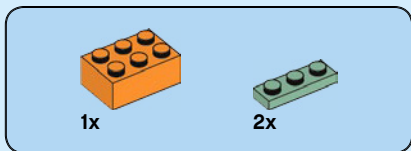
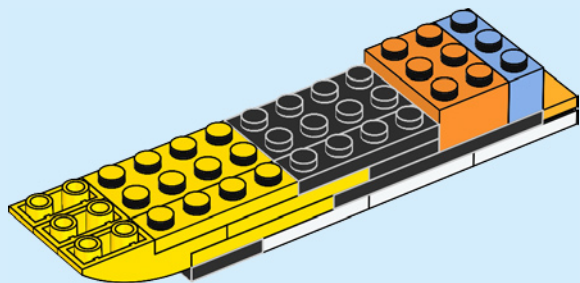

31

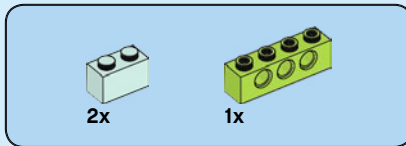
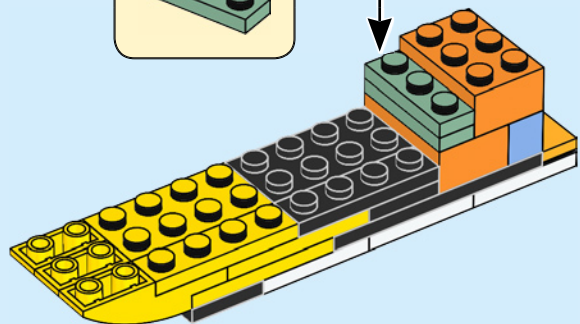
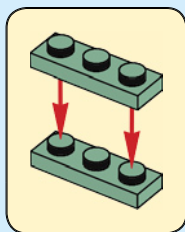

32

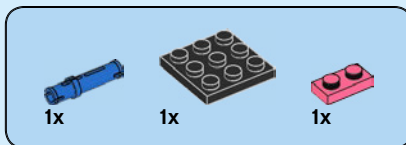
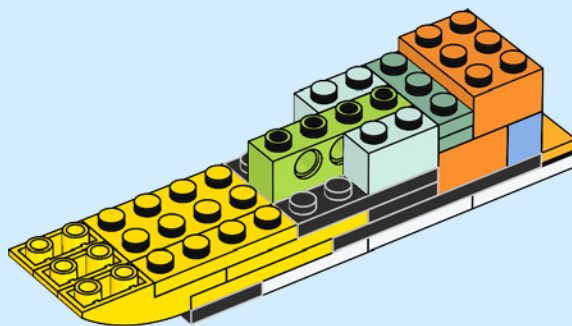

33

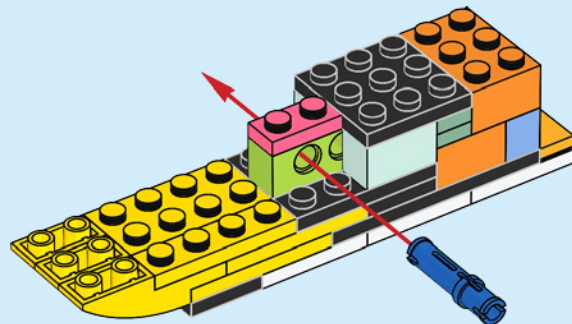

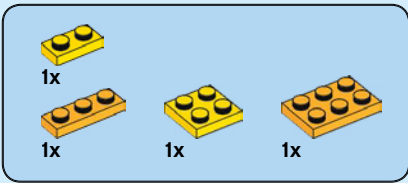

34

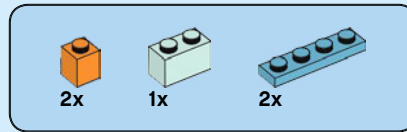
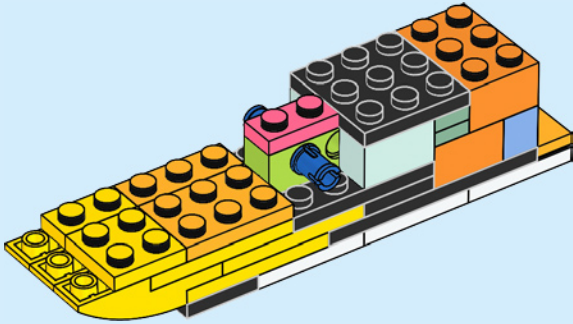

36

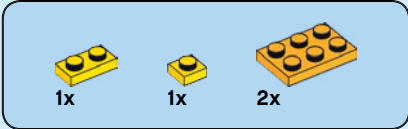
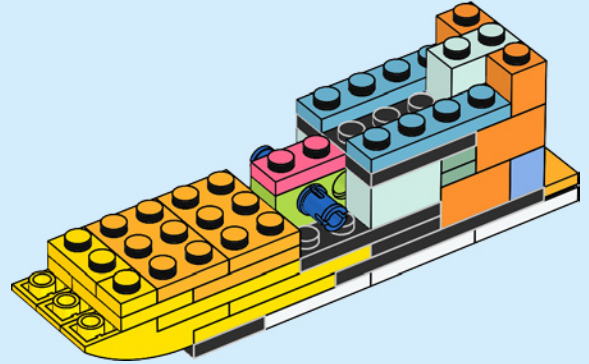

35

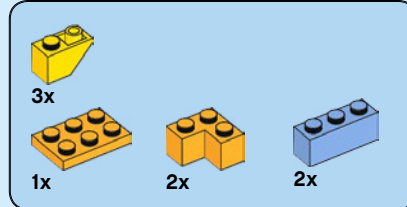
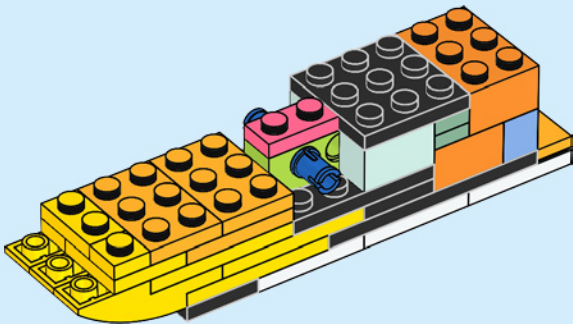

37

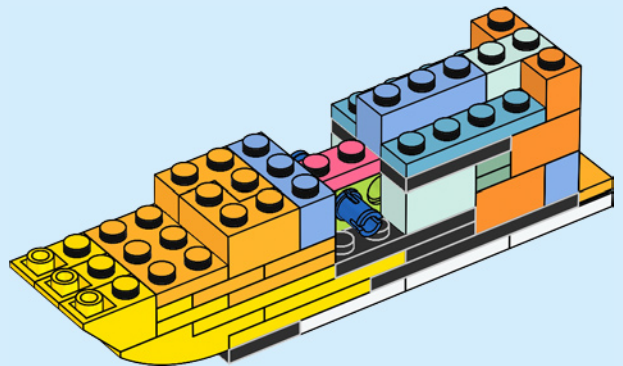

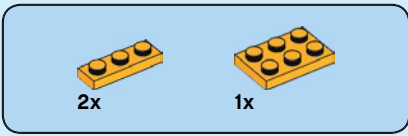

38

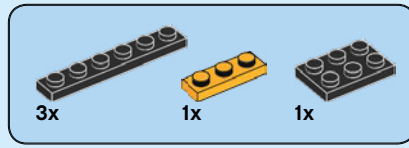
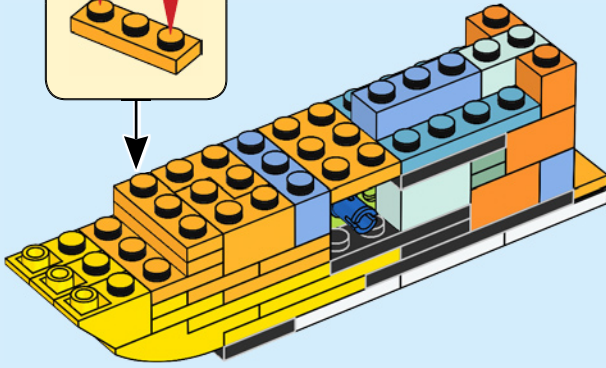
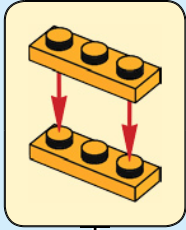

40

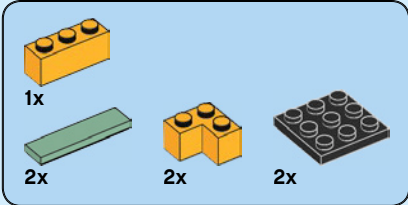
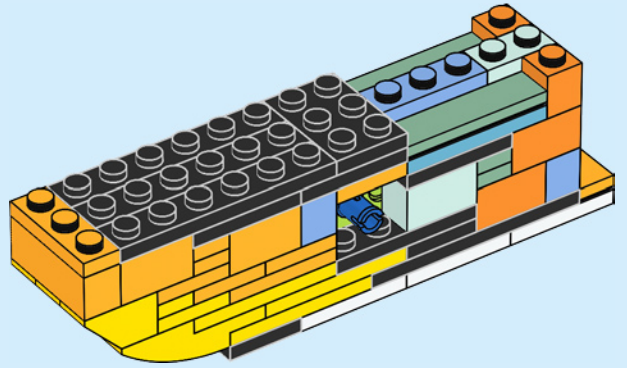

39

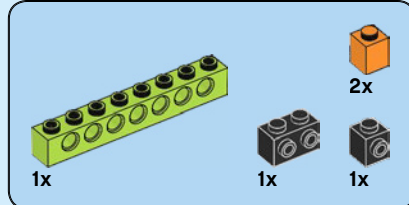
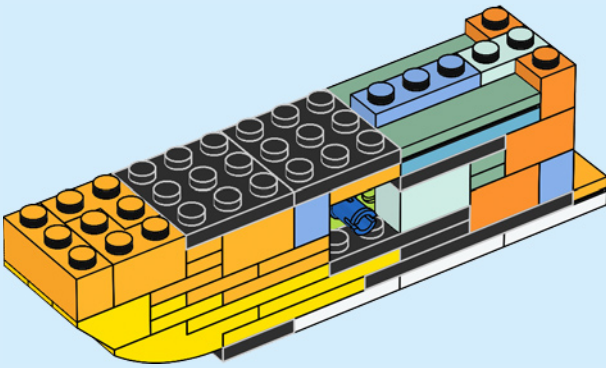

41

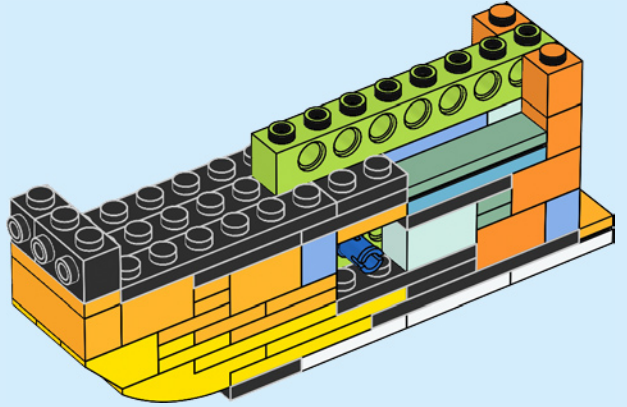



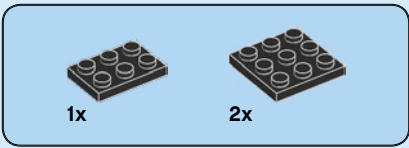

# 42

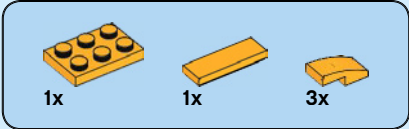
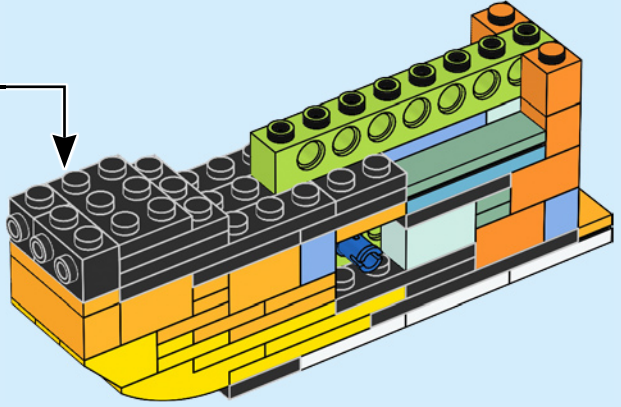
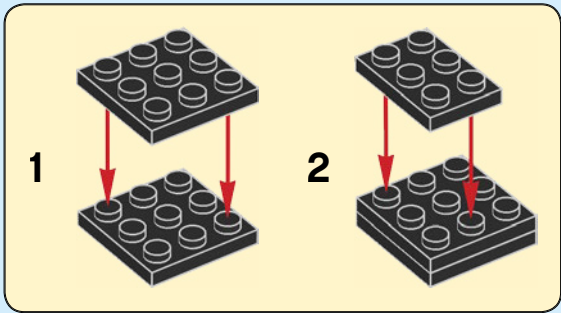

# 43

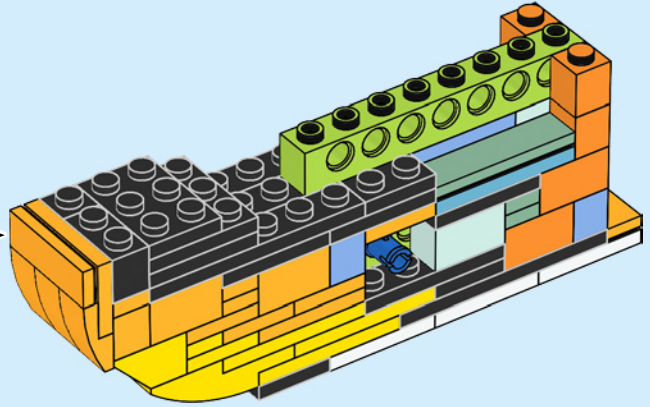
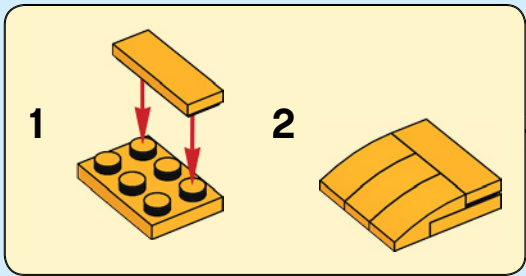

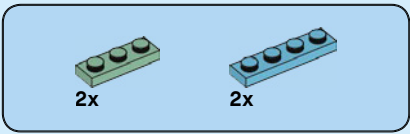

44

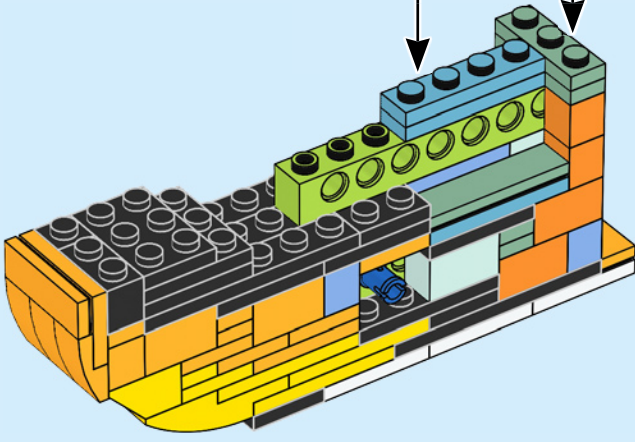
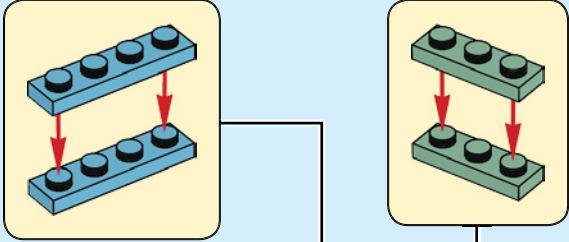

45

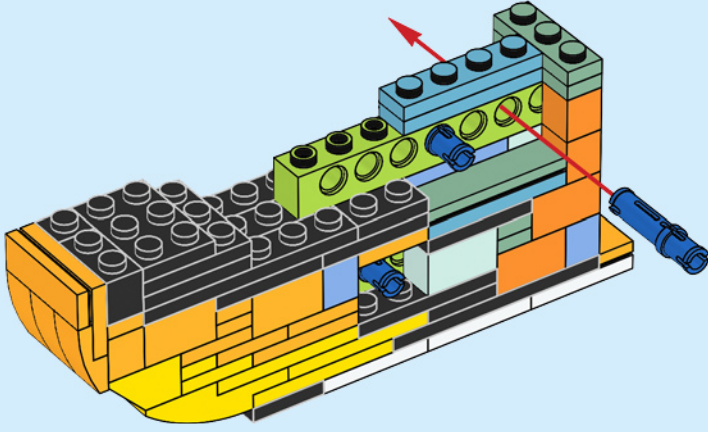



46

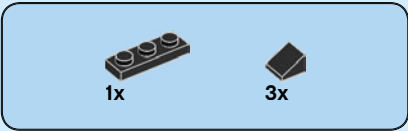
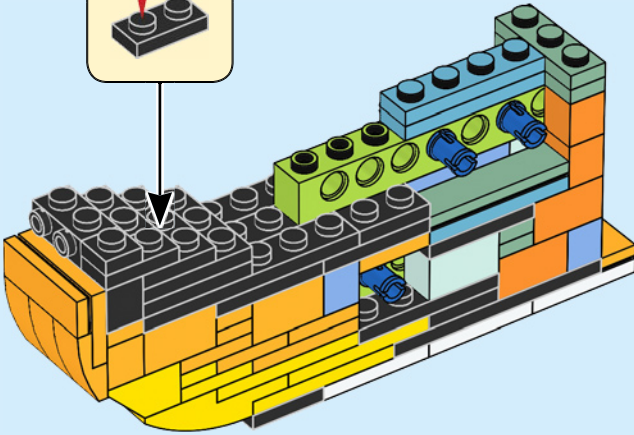
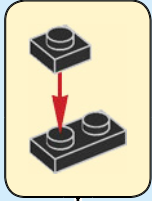

47

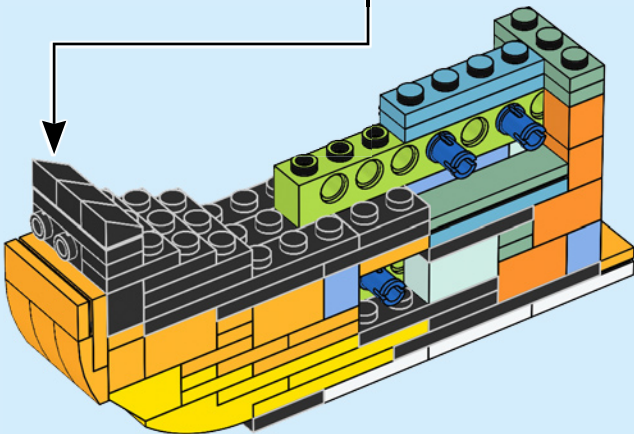
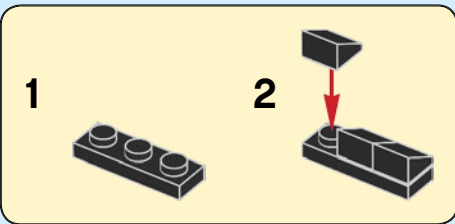

48

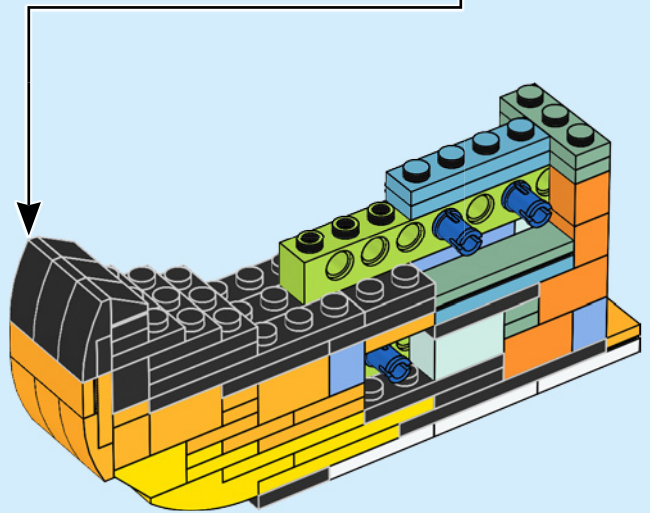
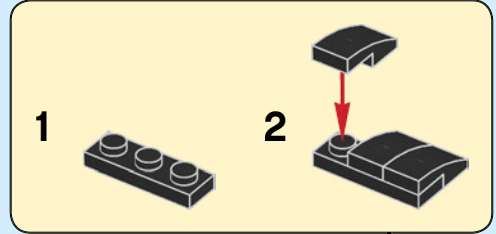

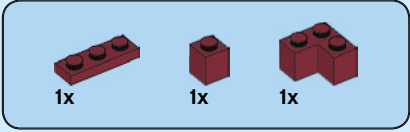
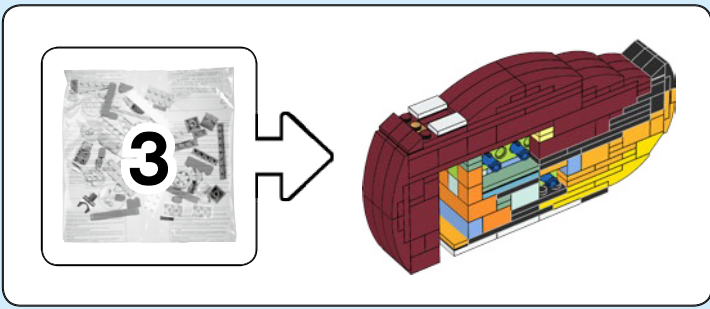

49

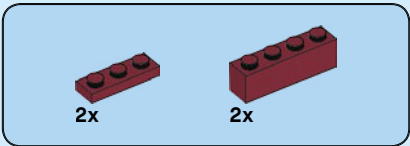
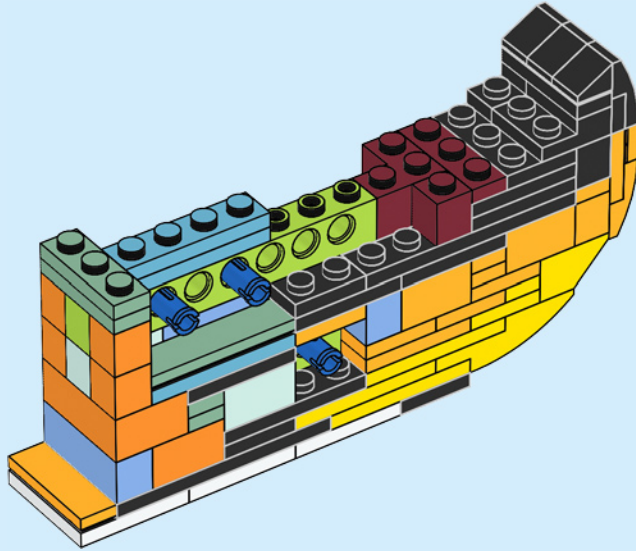

50

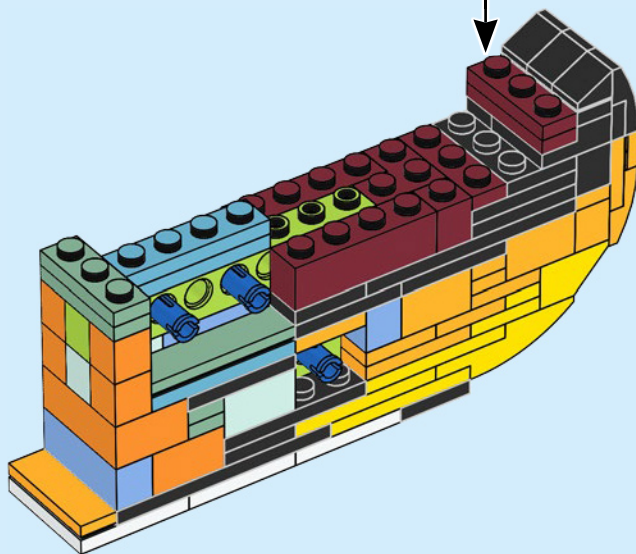
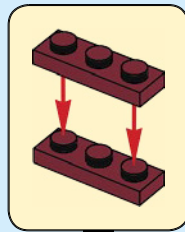



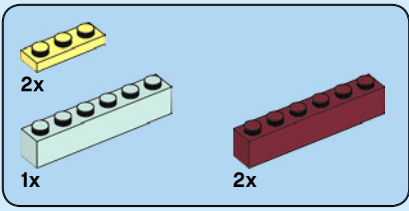

51

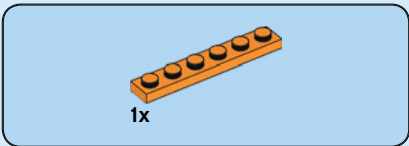
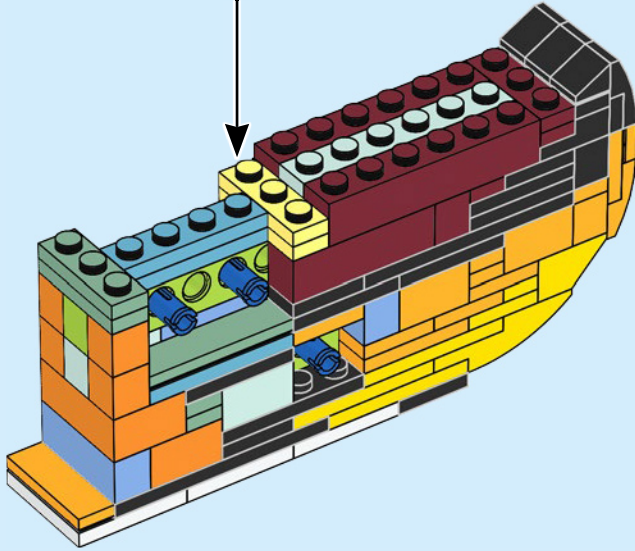
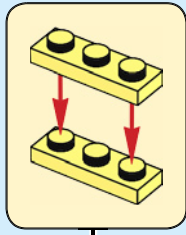

52

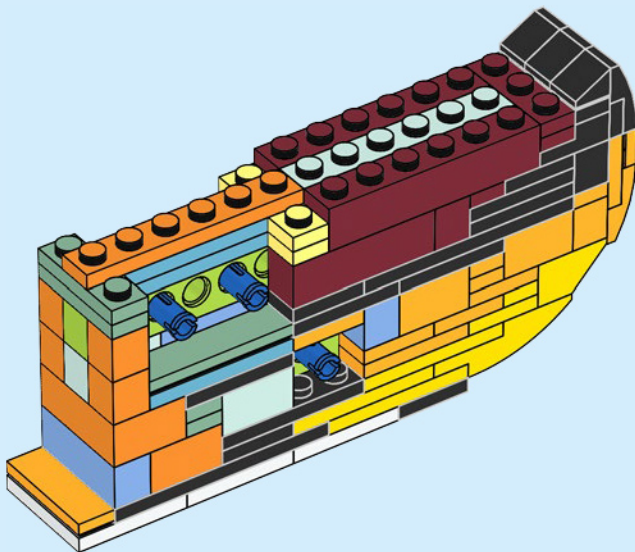



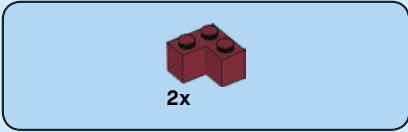
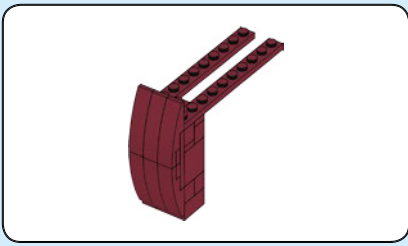

53

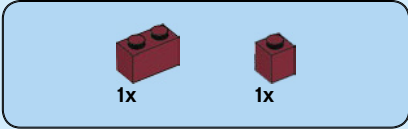
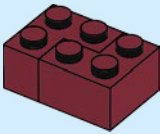

54

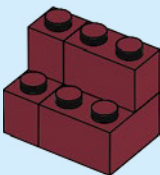

55

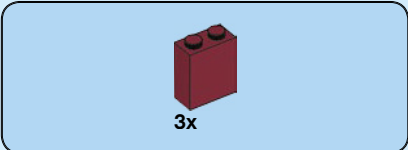
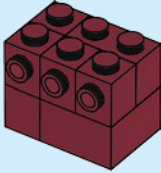

56

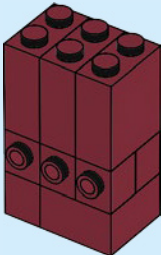

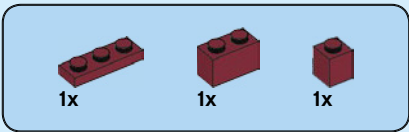

57

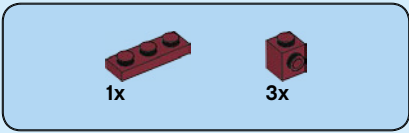
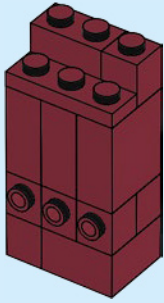

58

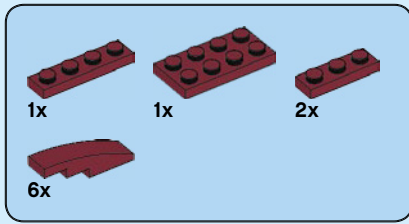
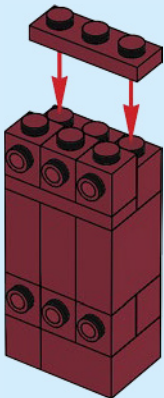

59

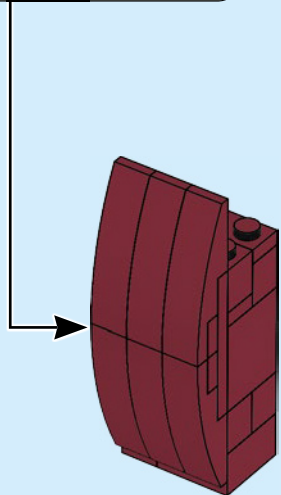
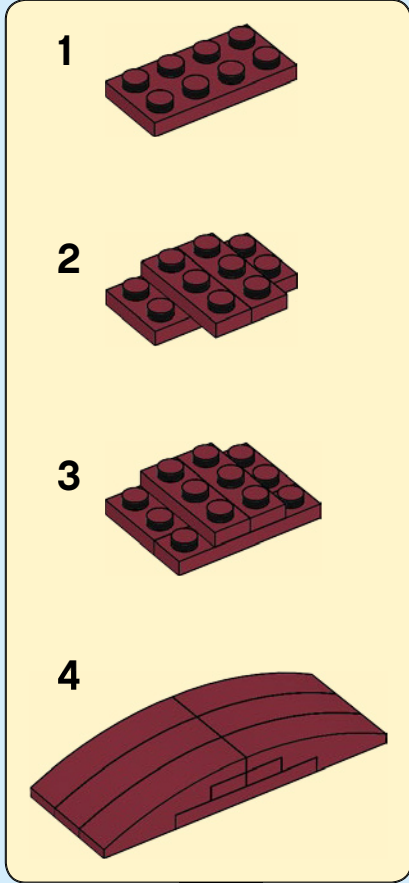

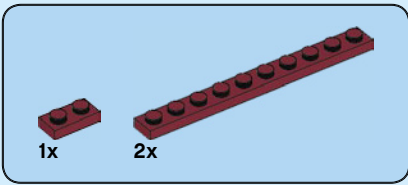

60

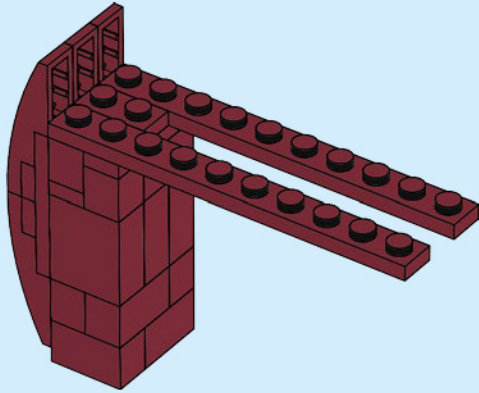

---

61

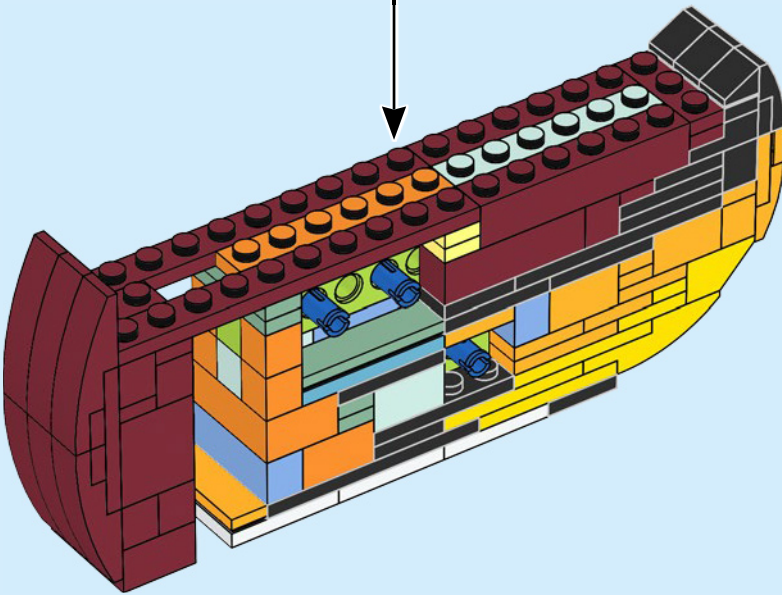

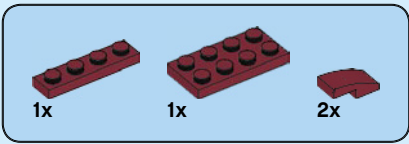

62

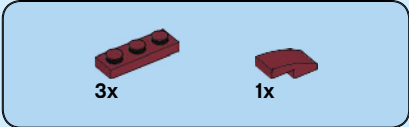
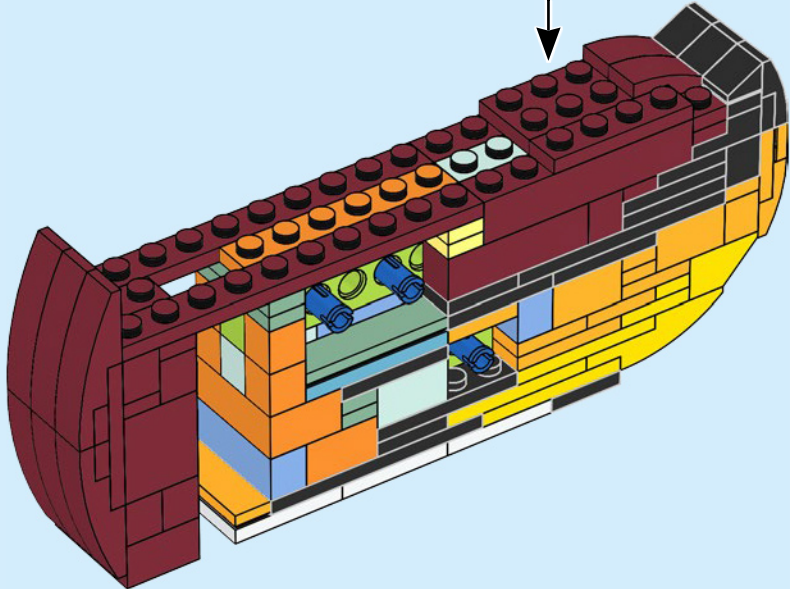
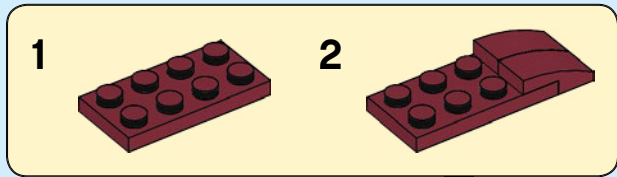

63

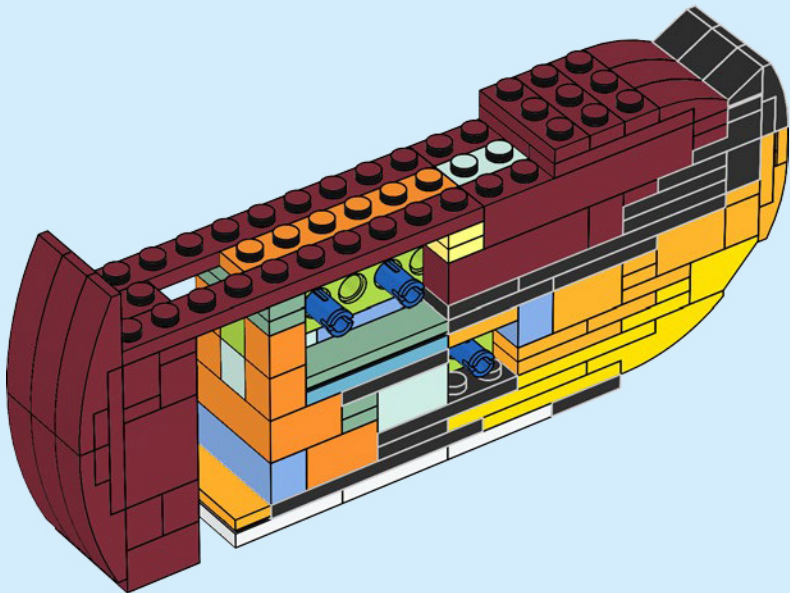



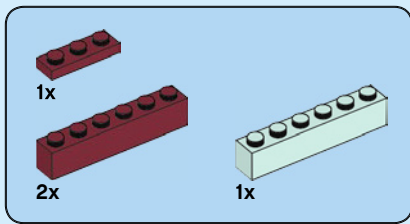

64

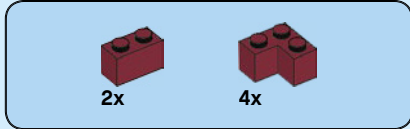
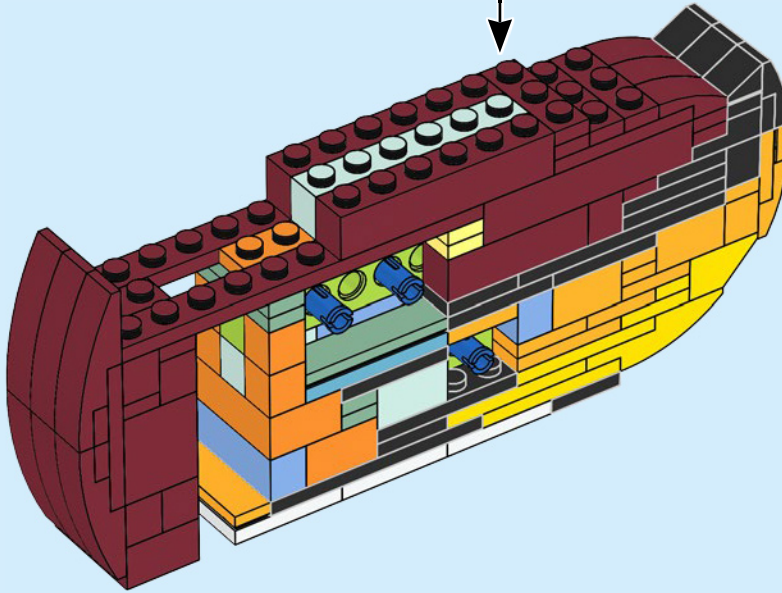
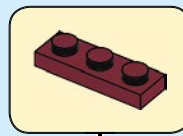

65

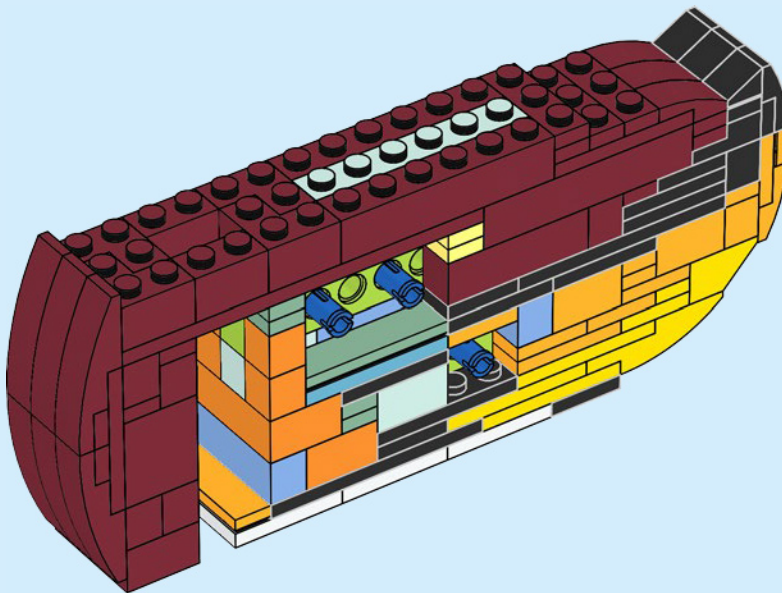

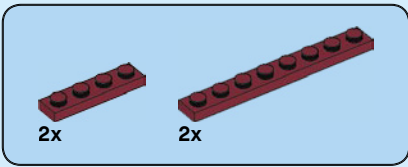

66

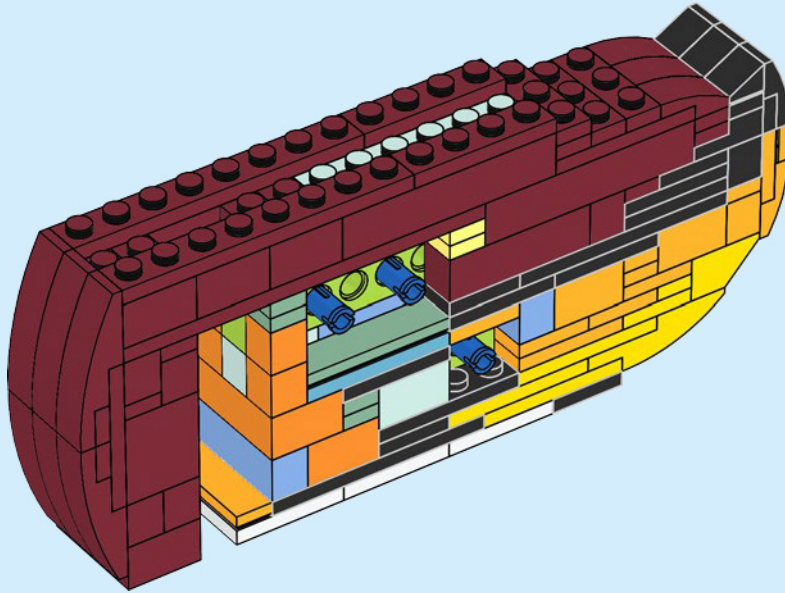

67

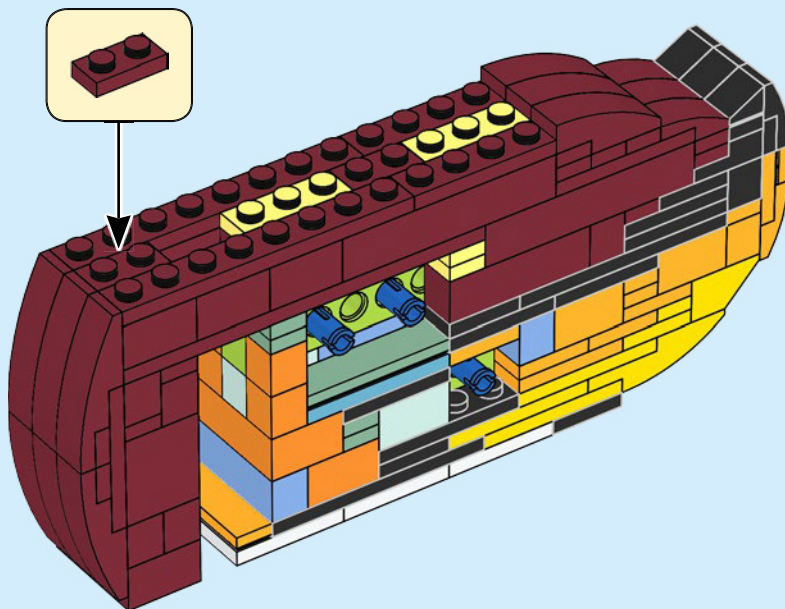

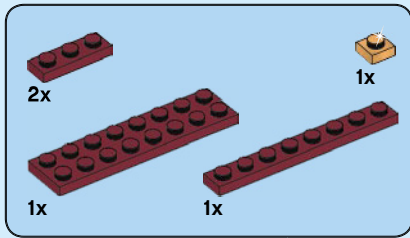

68

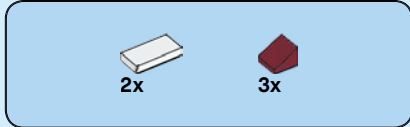
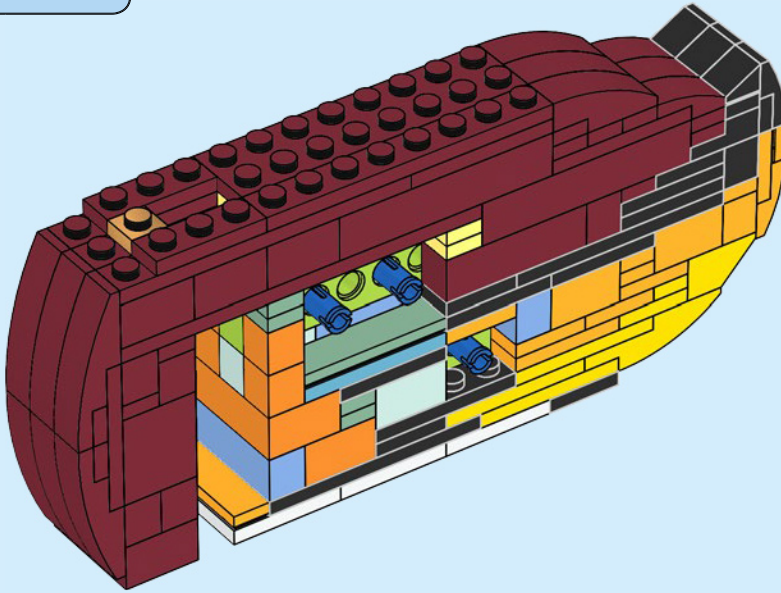

69

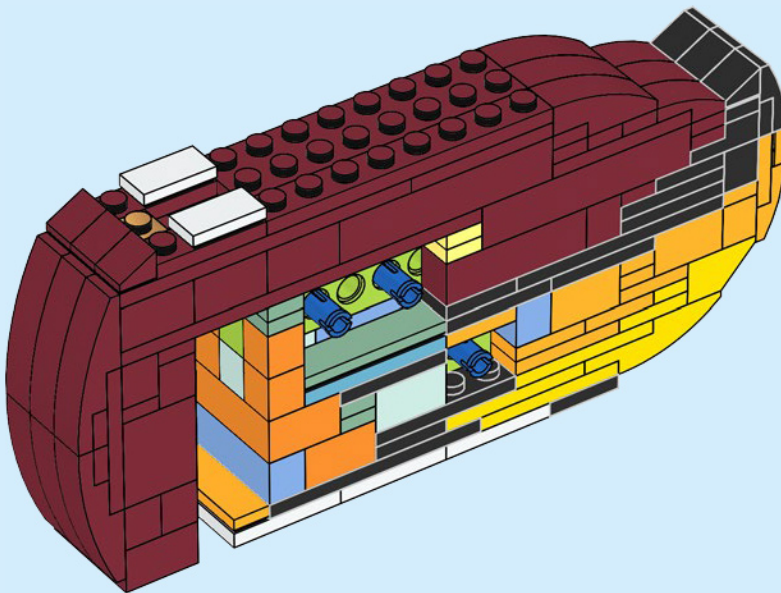

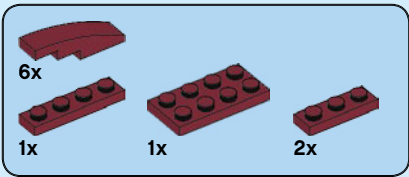

# 70

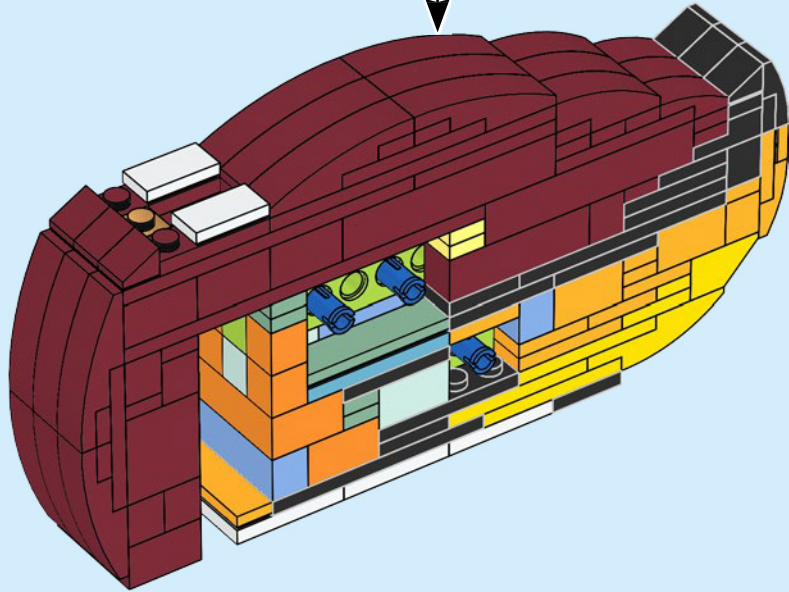
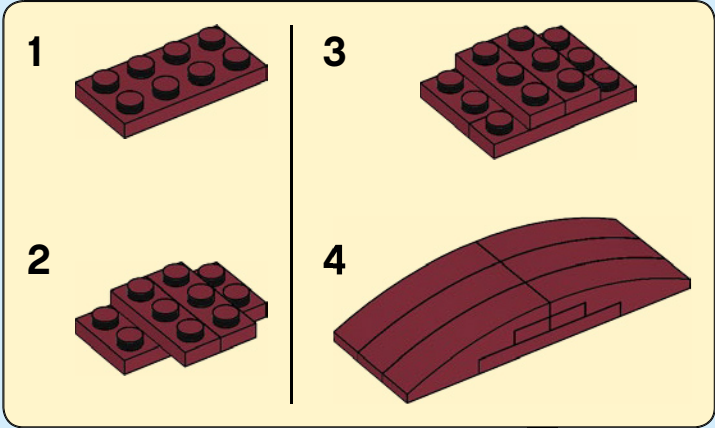



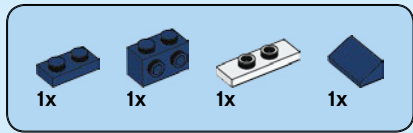
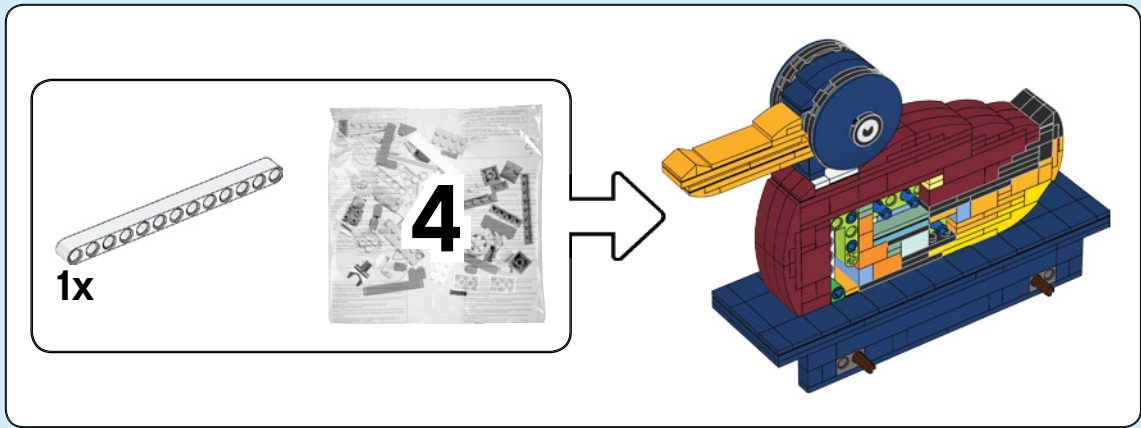

71

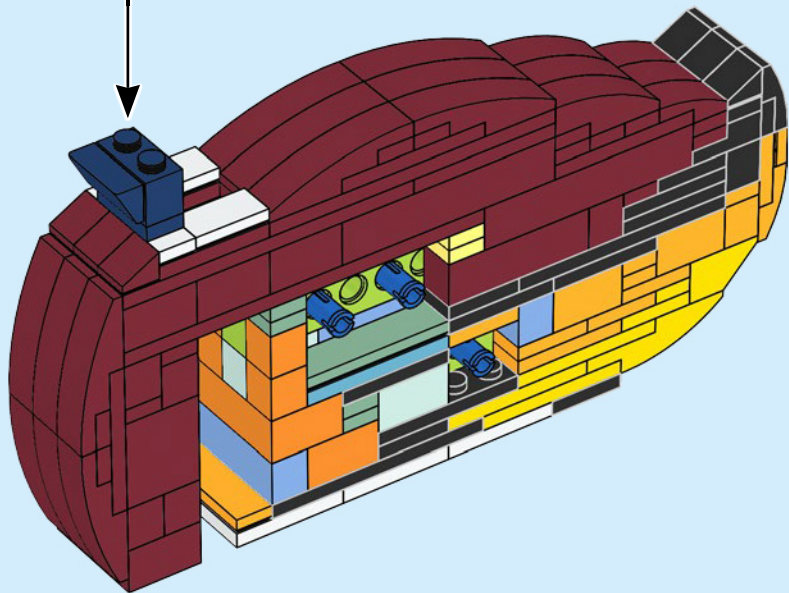
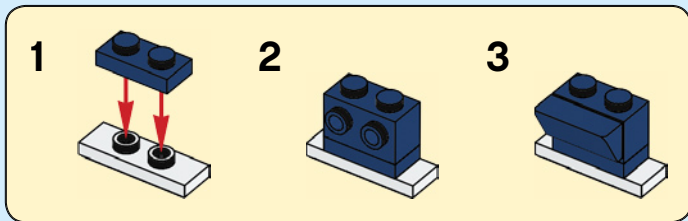

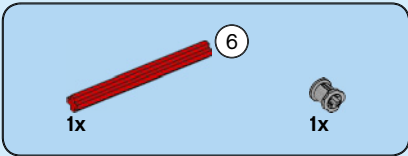
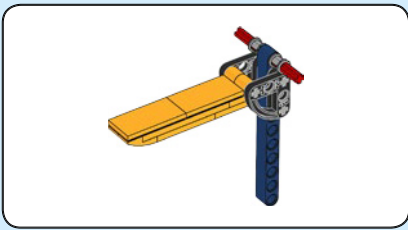

72

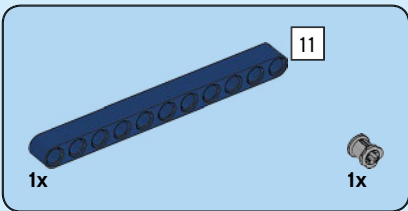

73

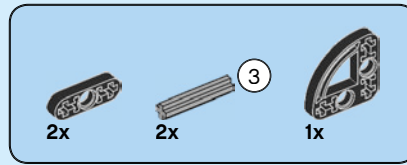
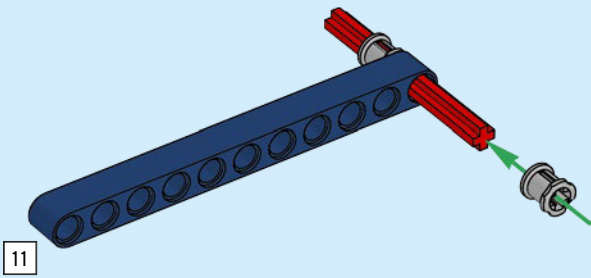

74

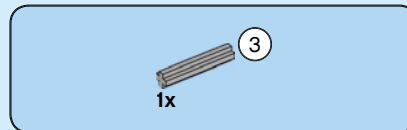
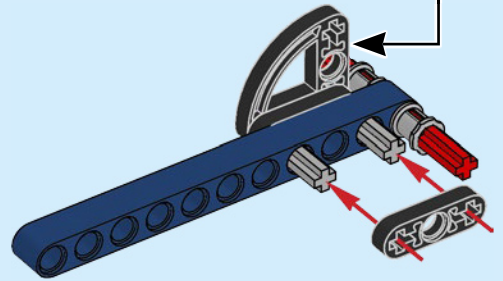
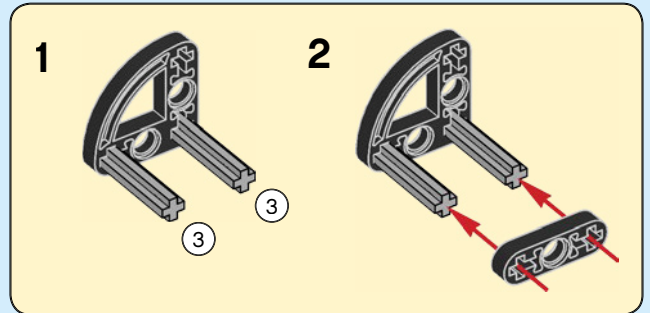

75

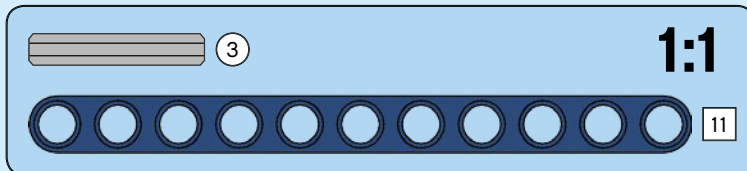
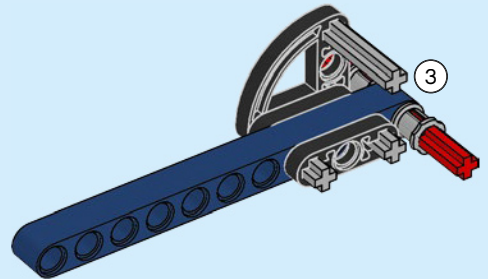

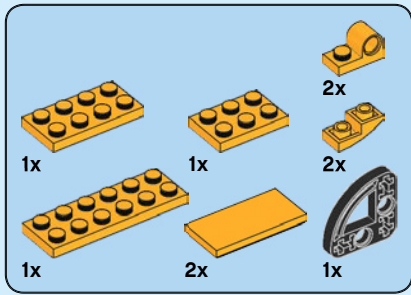

# 76

1

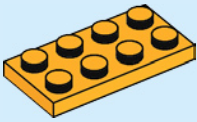

2

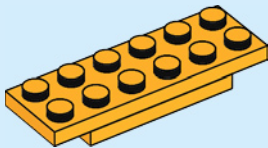

3

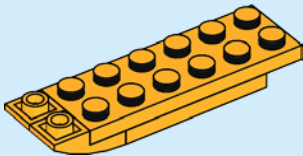

4

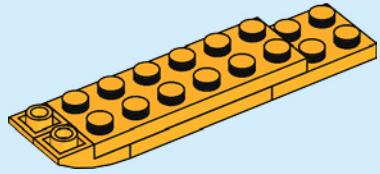

5

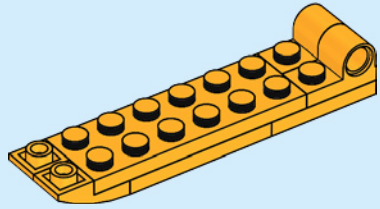

6

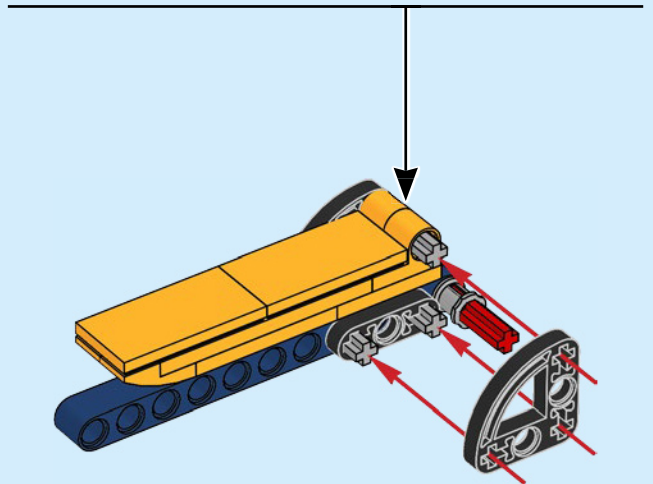
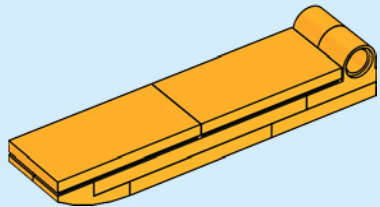

77

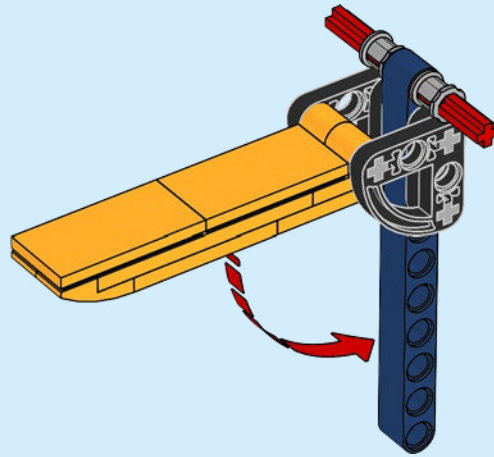

78

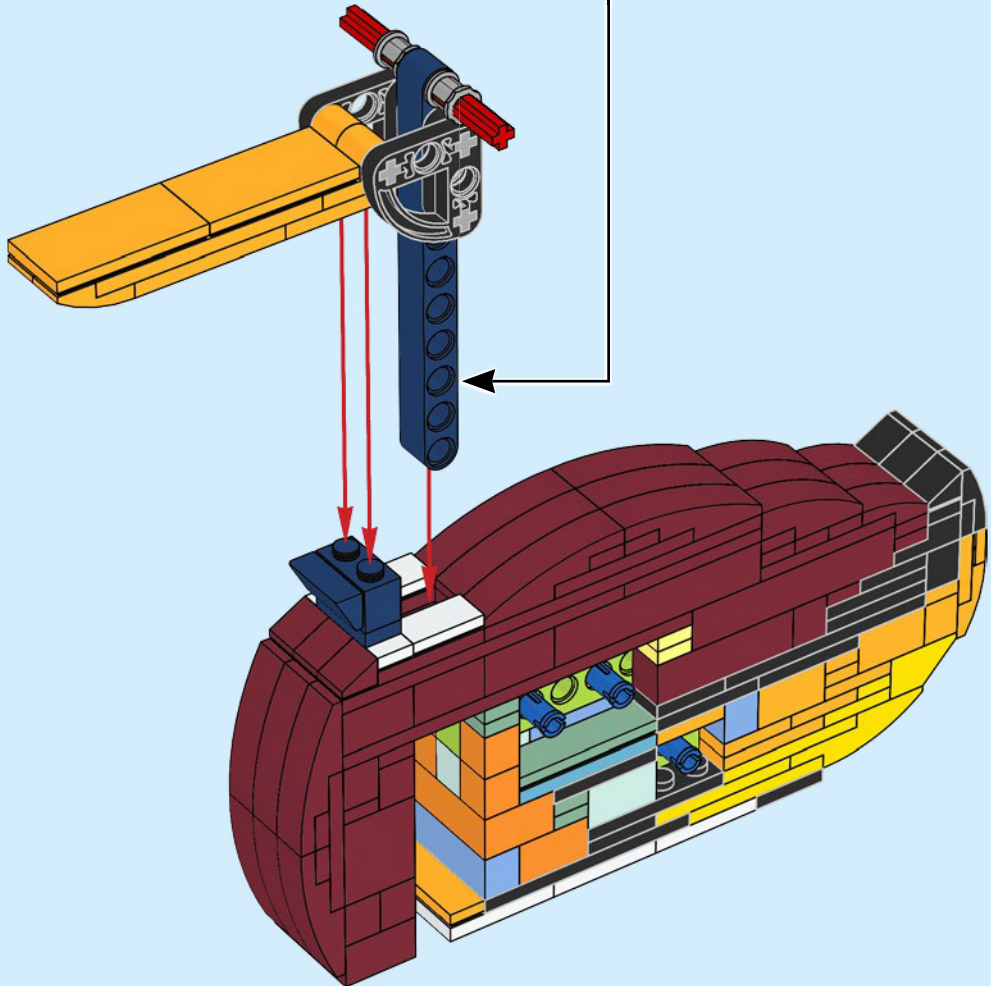



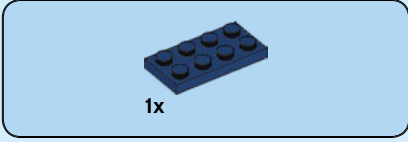
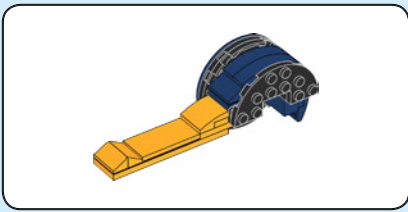

79

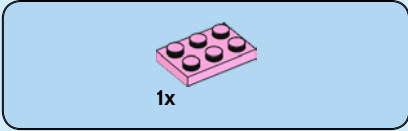
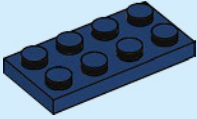

80

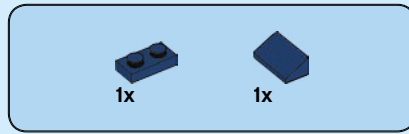
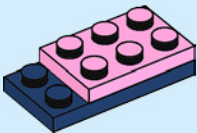

81

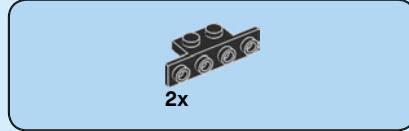
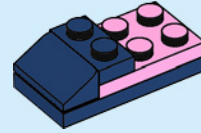

82

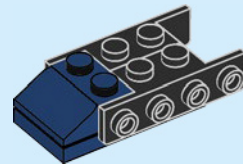

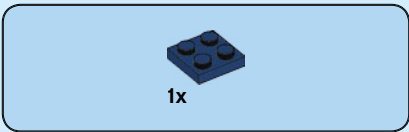

83

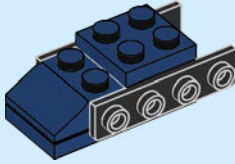

84

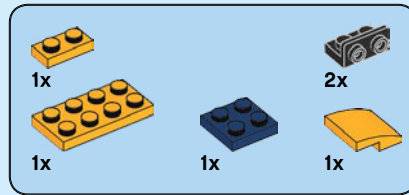
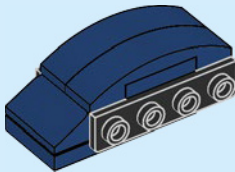

85

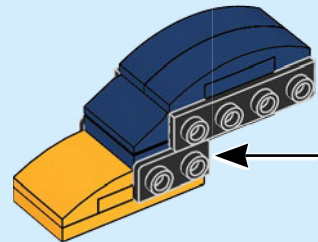
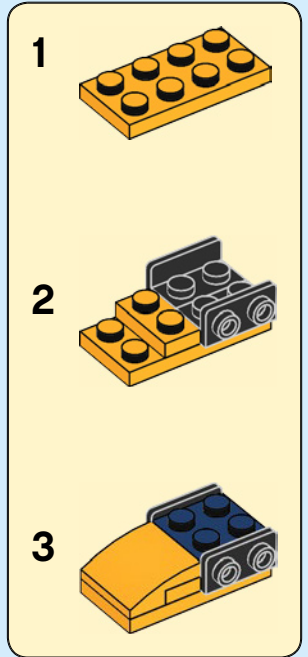

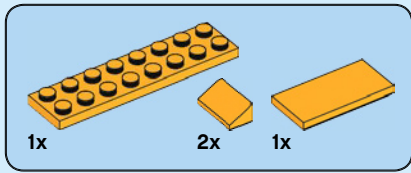

86

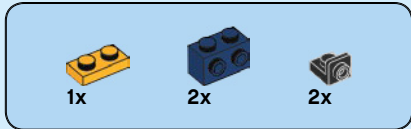
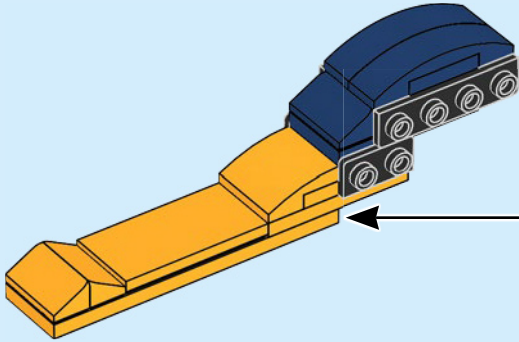
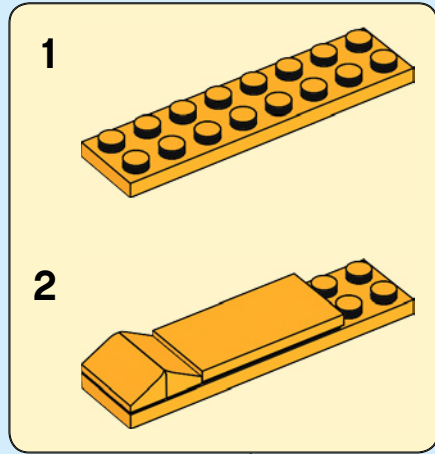

87

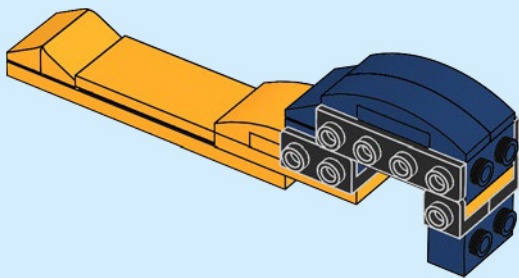
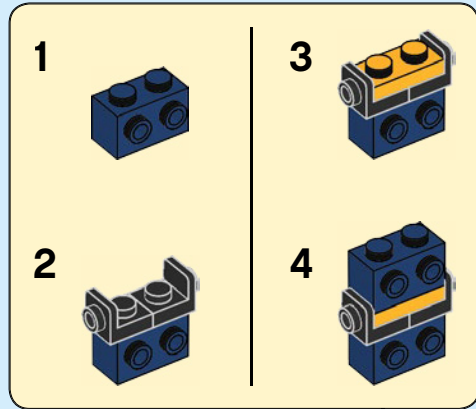

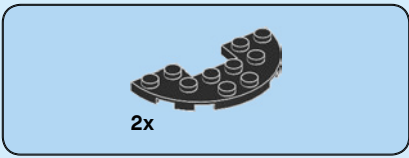

88

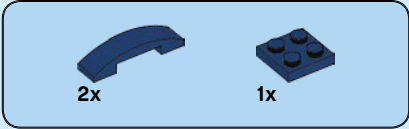
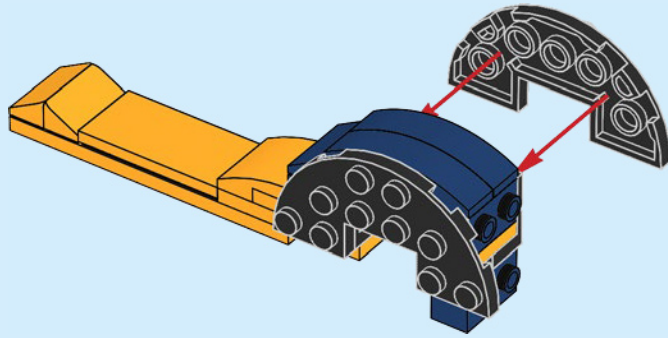

89

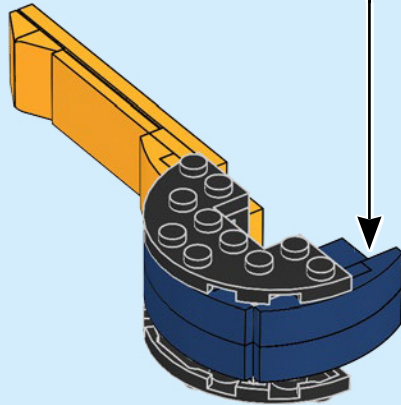
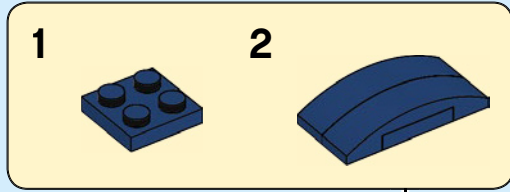

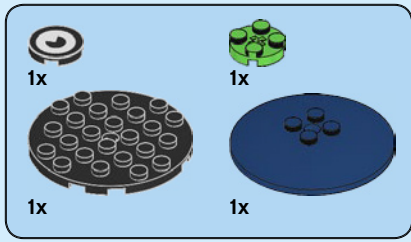

90

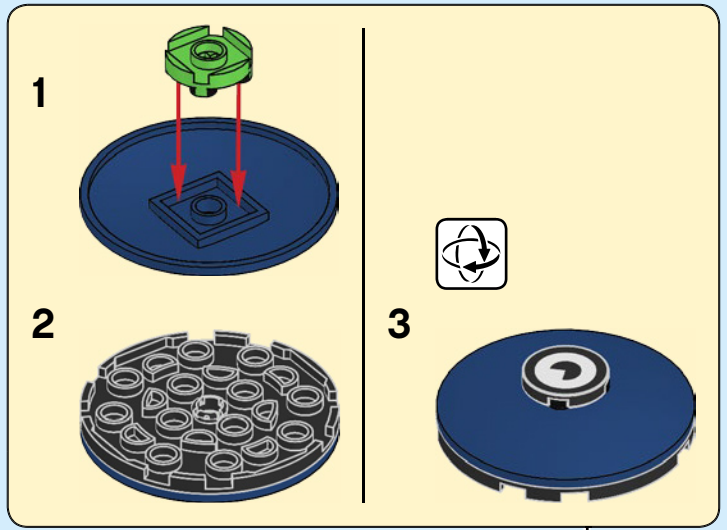
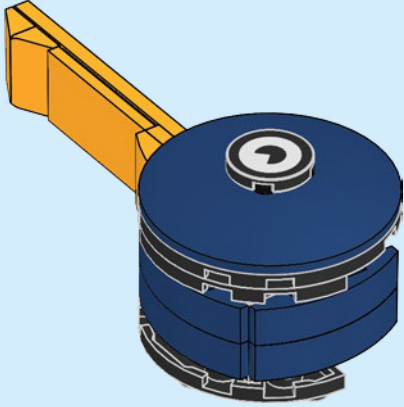

91

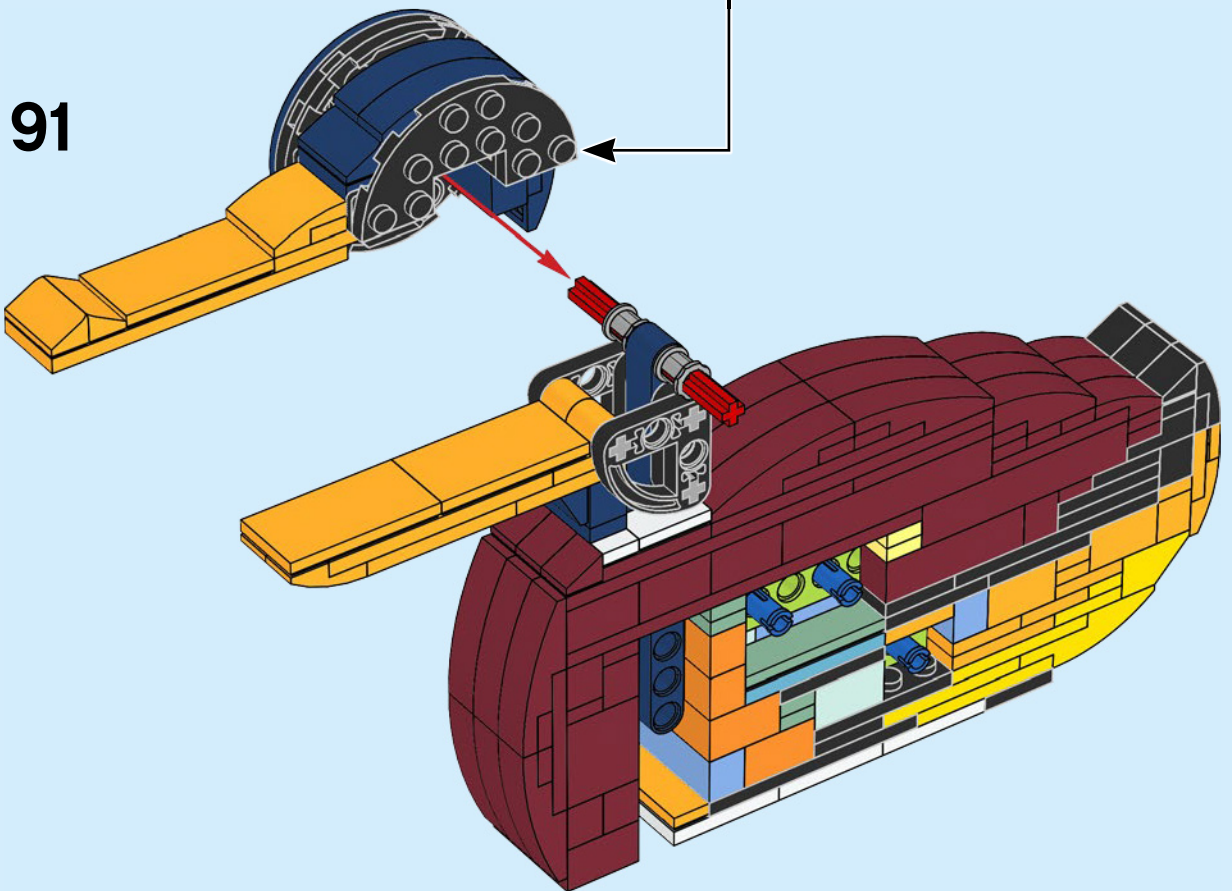



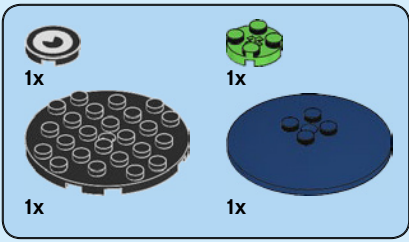

92

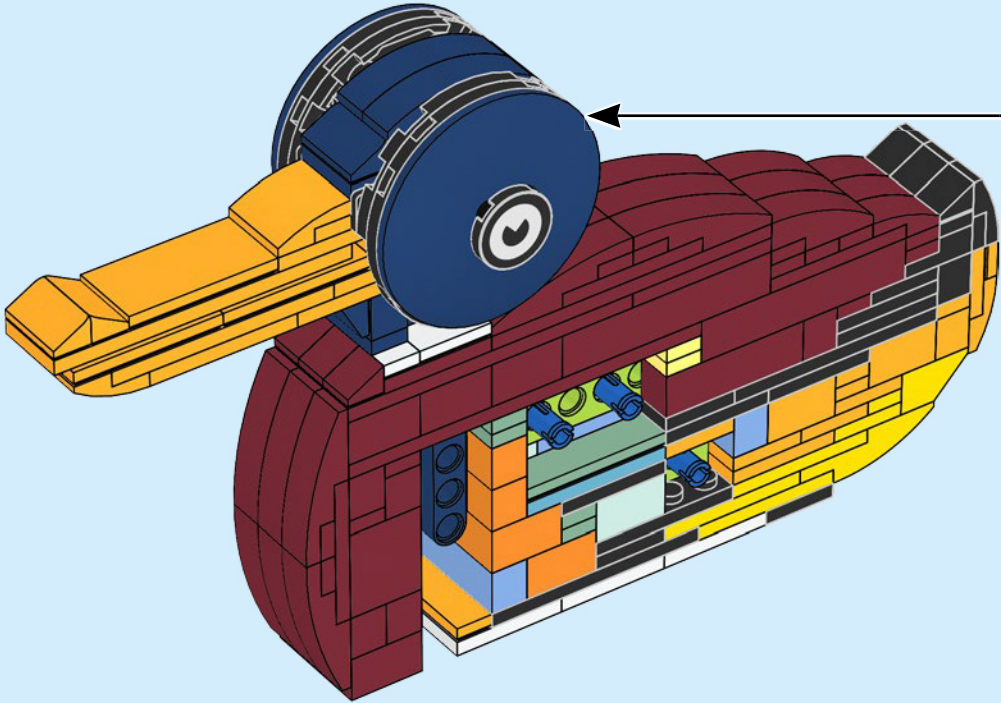
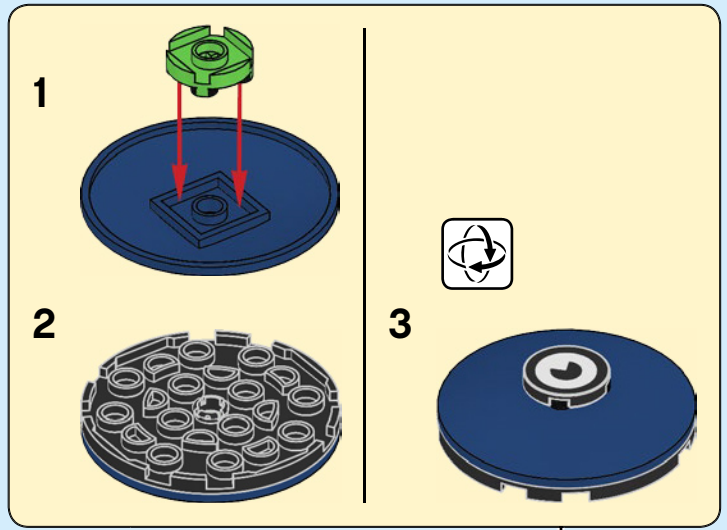

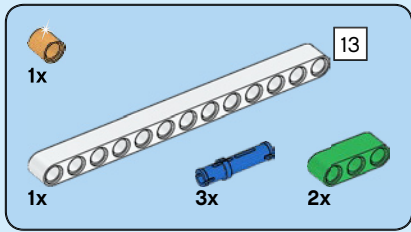

93

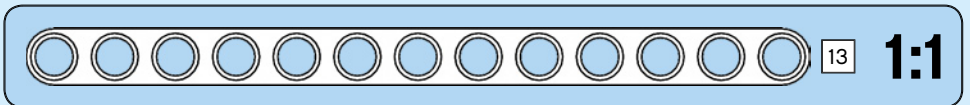
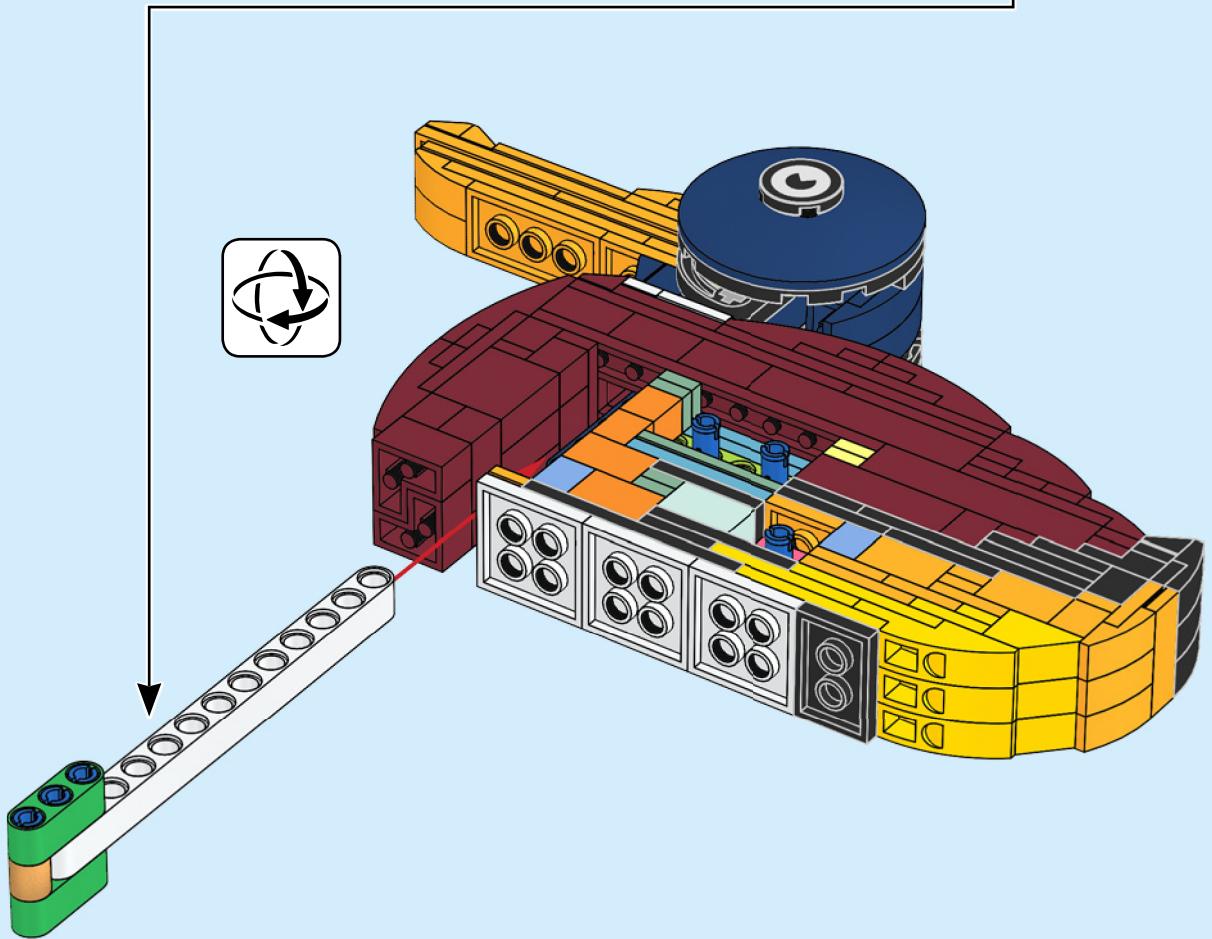
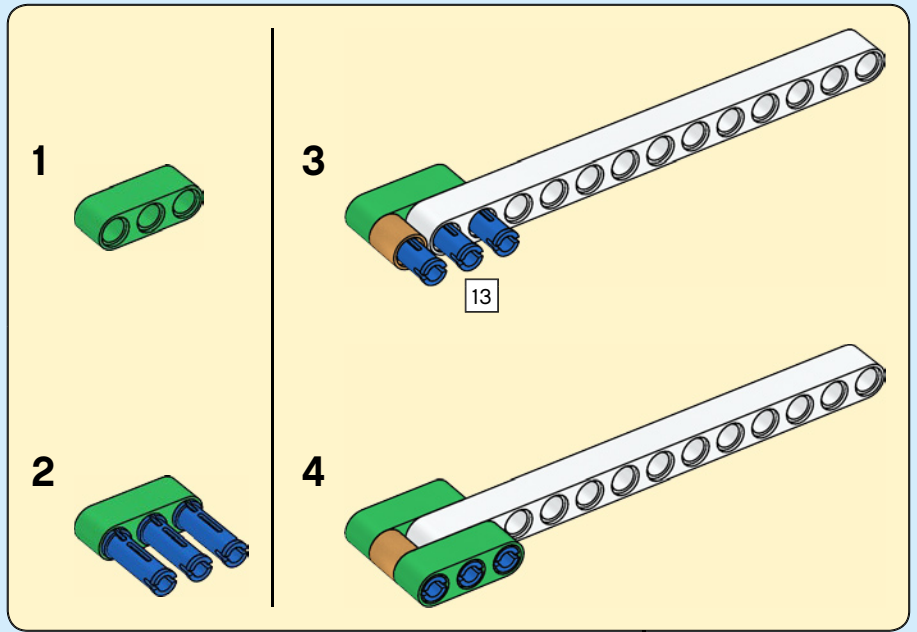

94

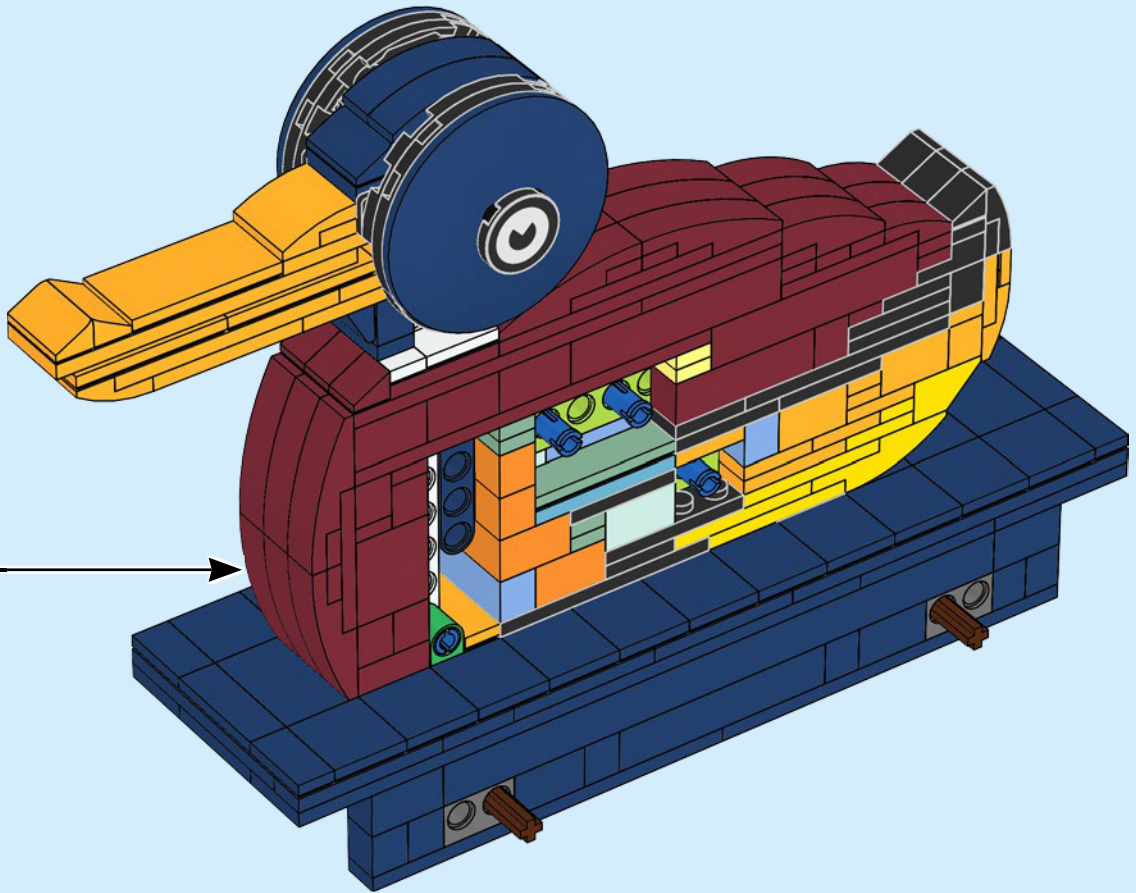



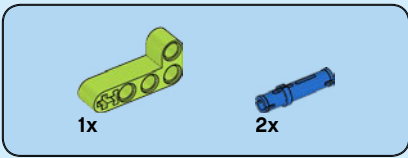

95

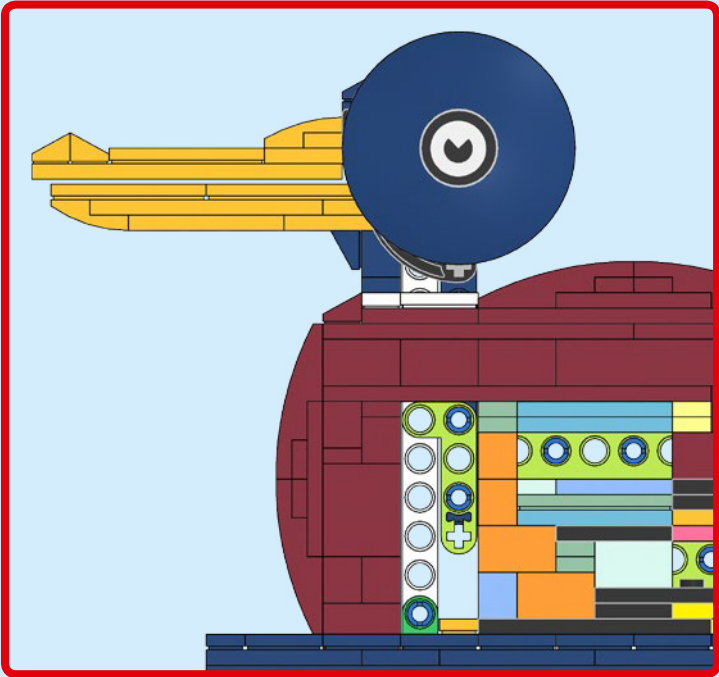
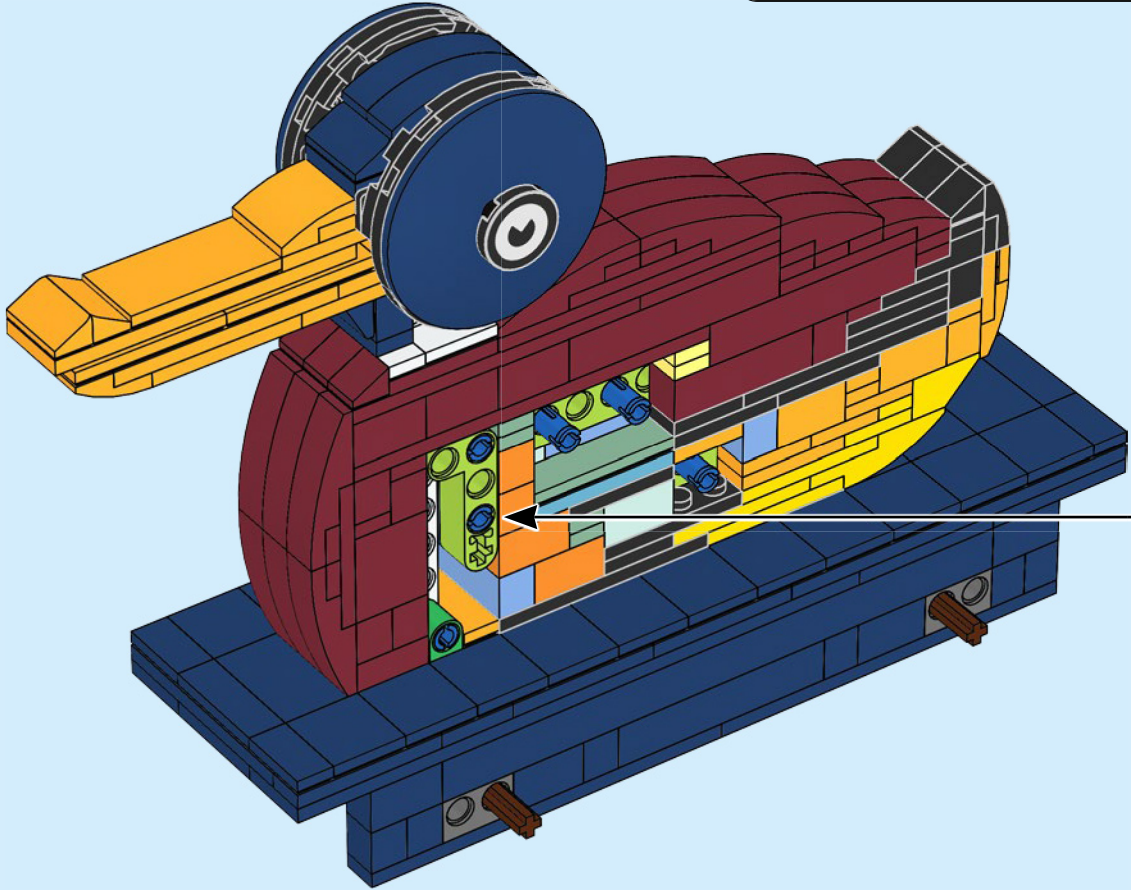
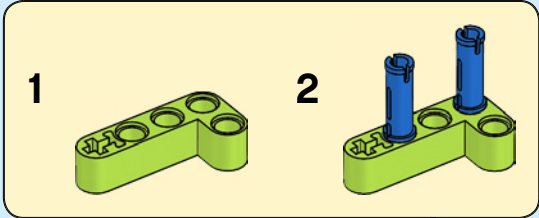

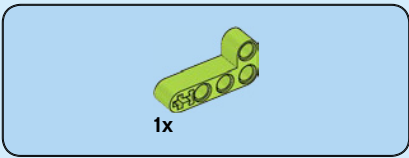

96

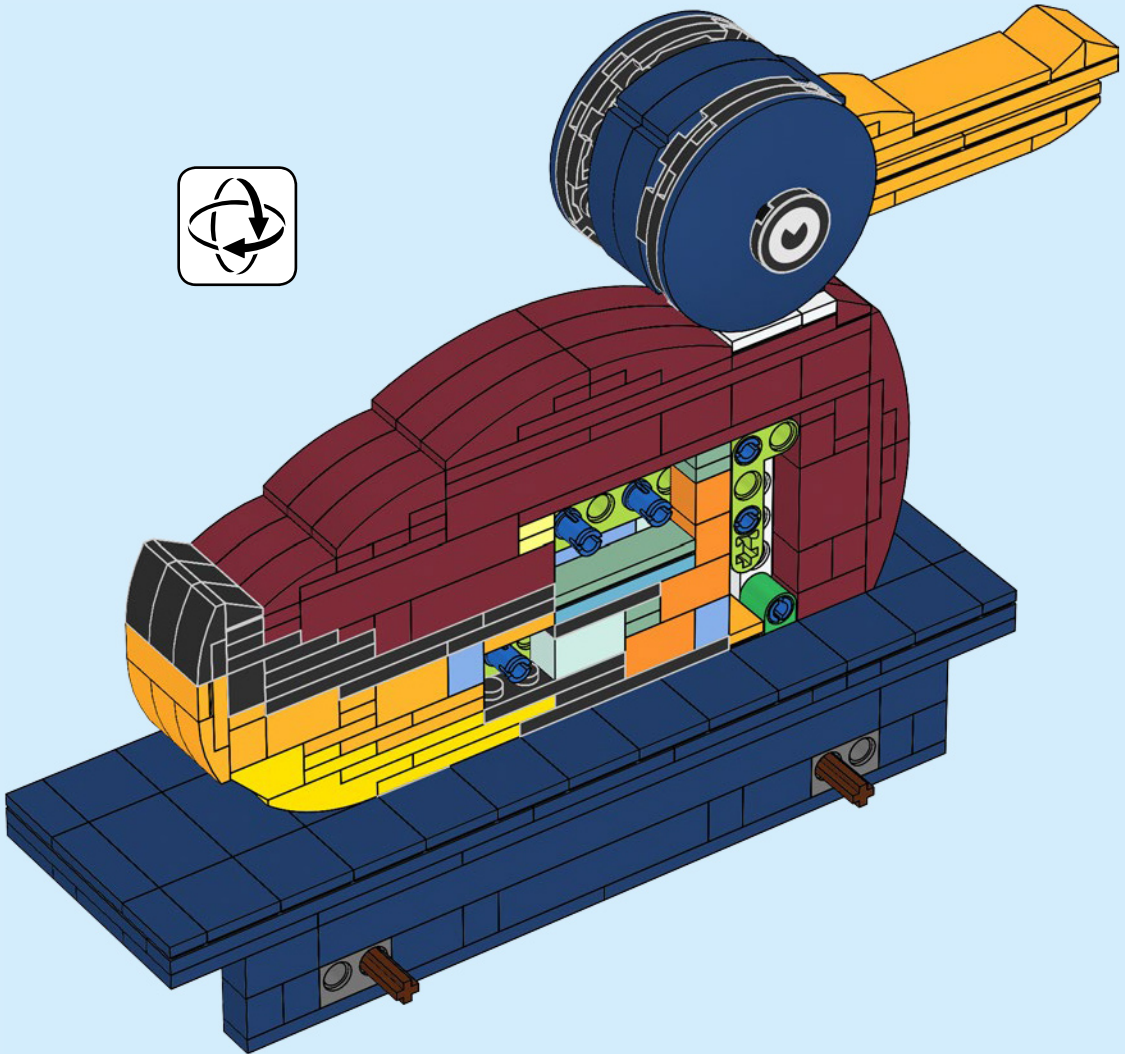



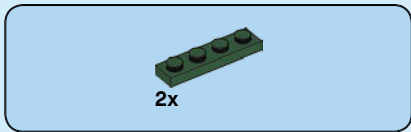
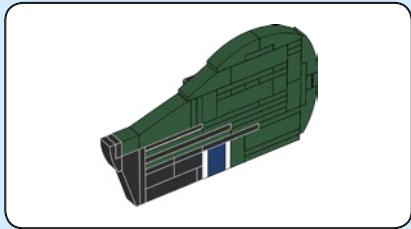
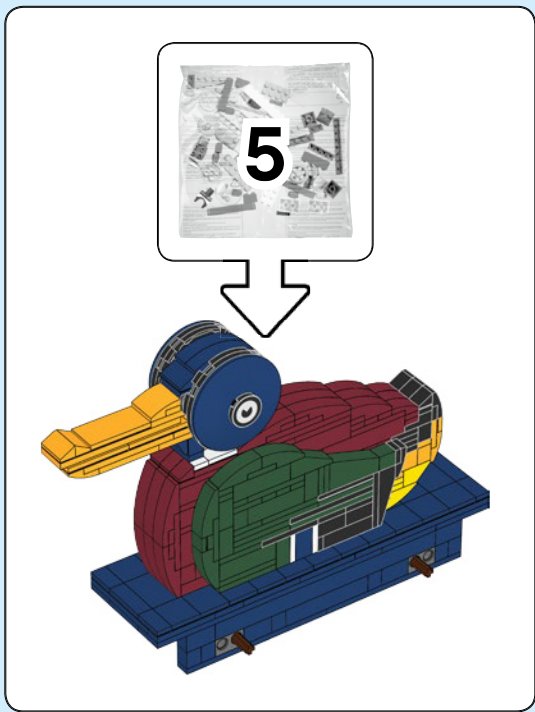

97

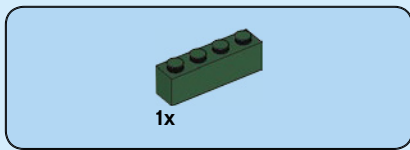
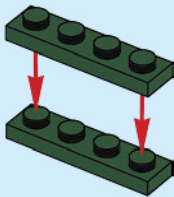

98

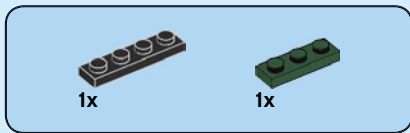
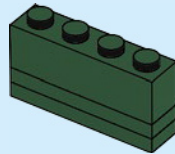

99

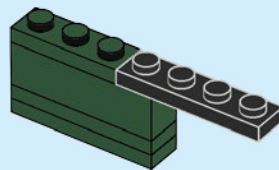

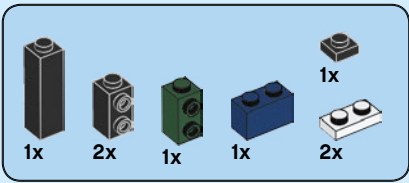

# 100

1

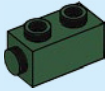

2

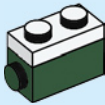

3

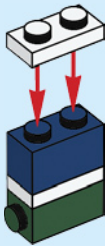

4

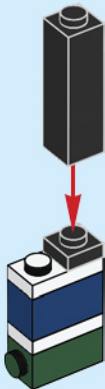

5

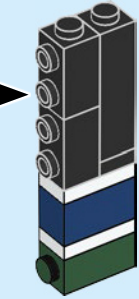
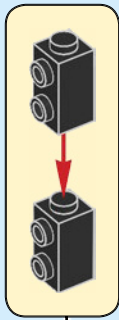

6

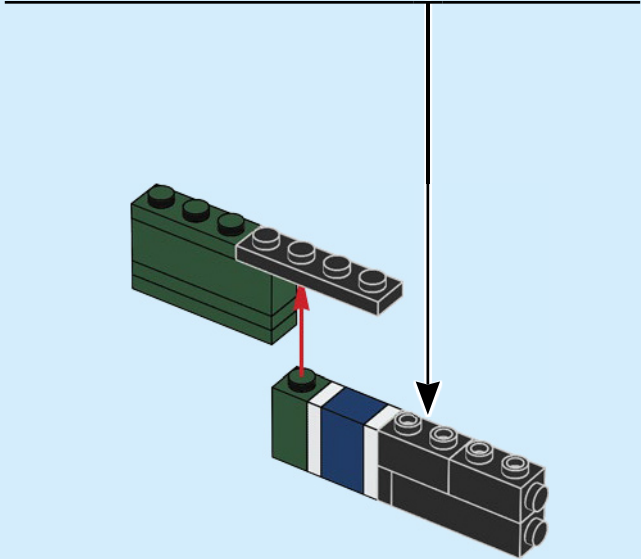
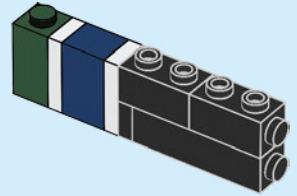
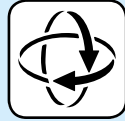

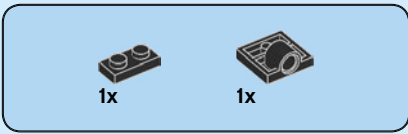

# 101

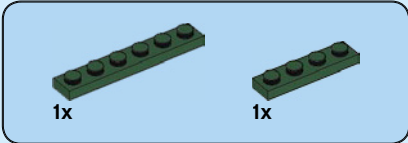
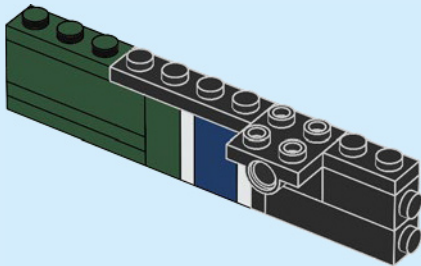

# 102

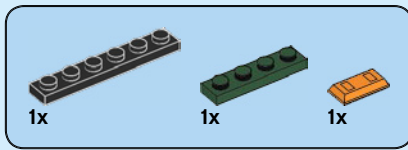
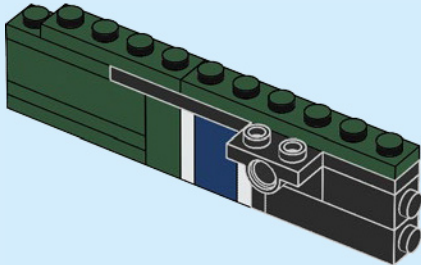

# 103

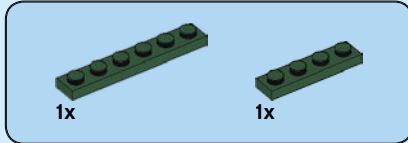
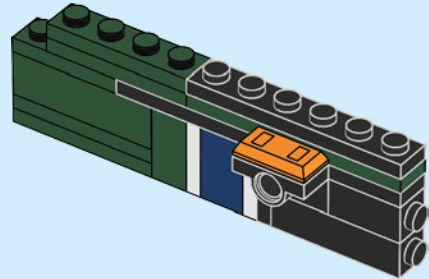

# 104

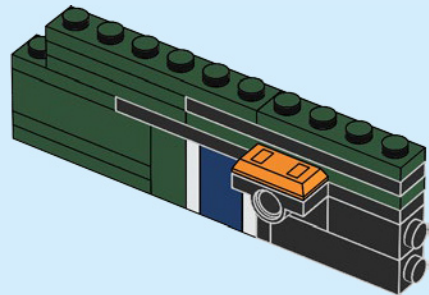

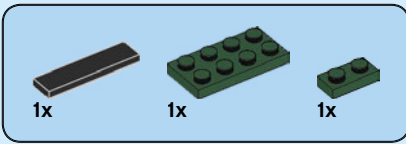

105

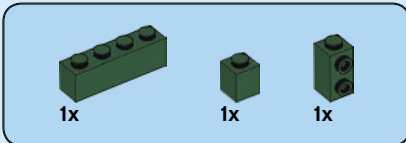
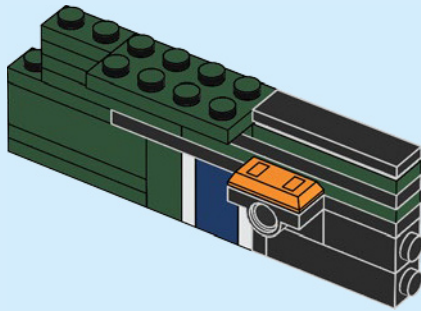

106

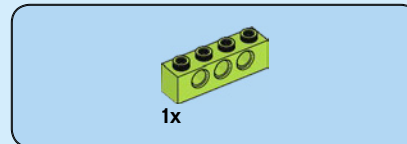
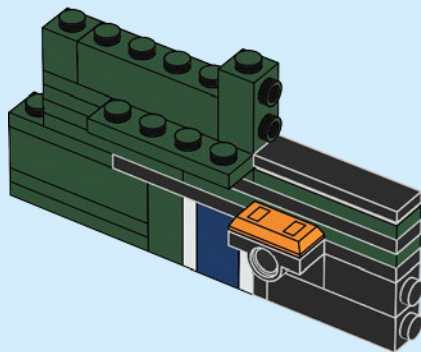

107

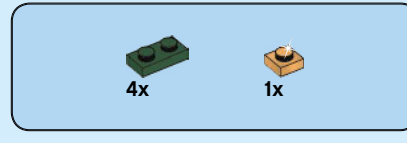
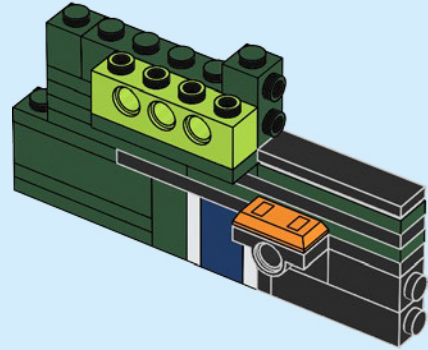

108

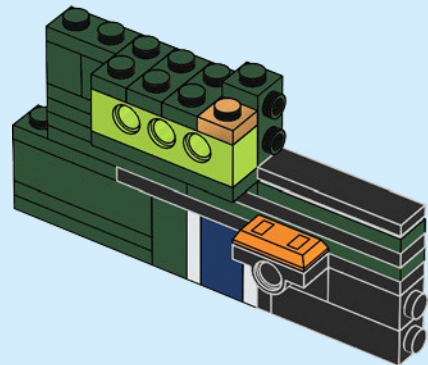



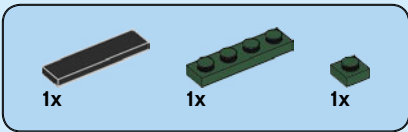

109

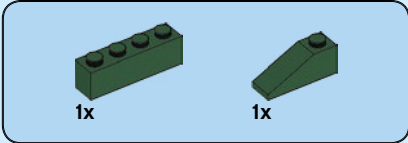
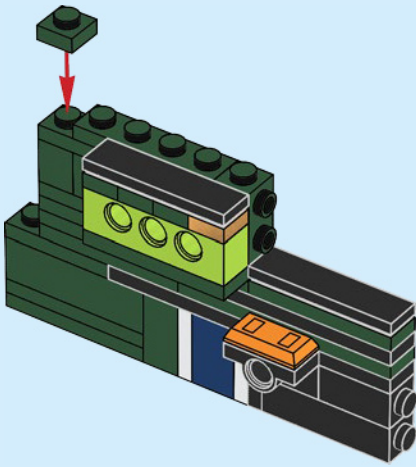

110

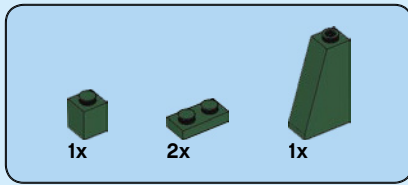
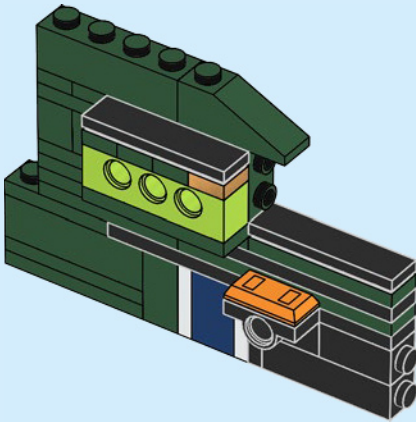

111

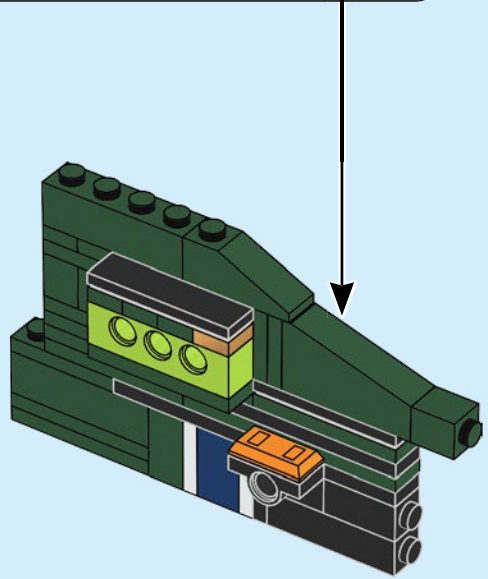
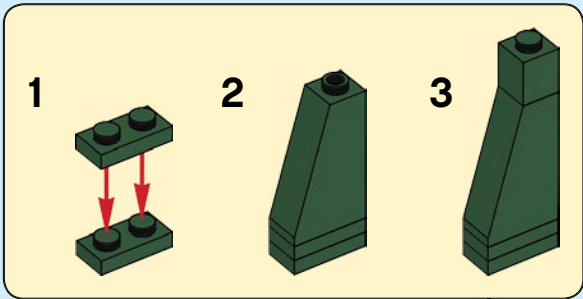

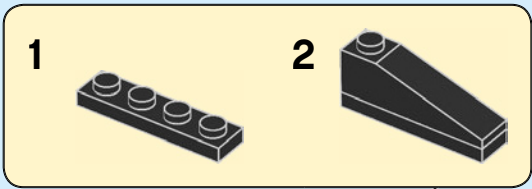
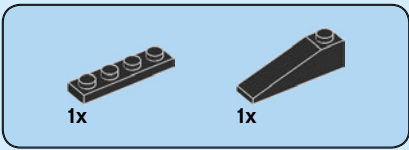

112

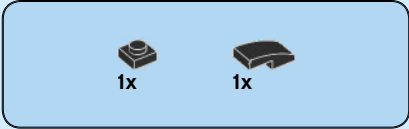
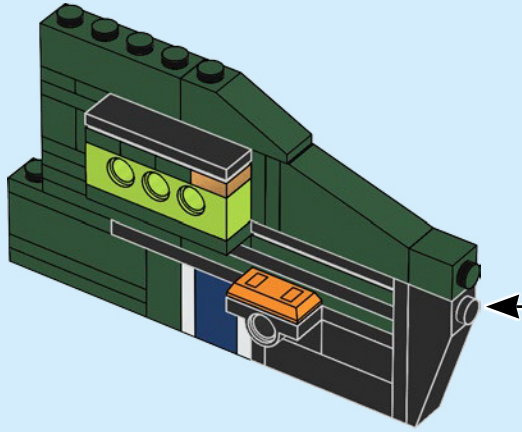

113

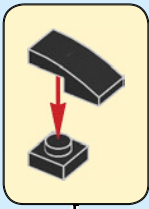
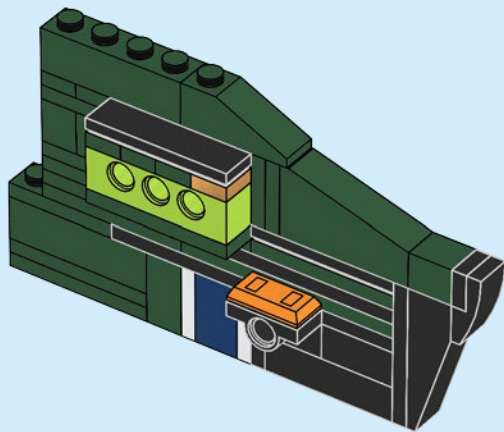

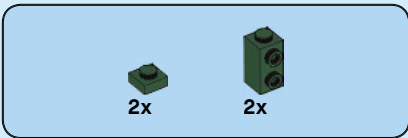

# 114

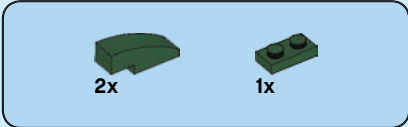
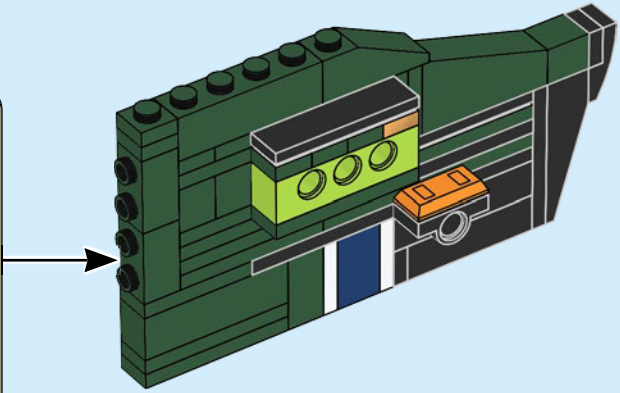
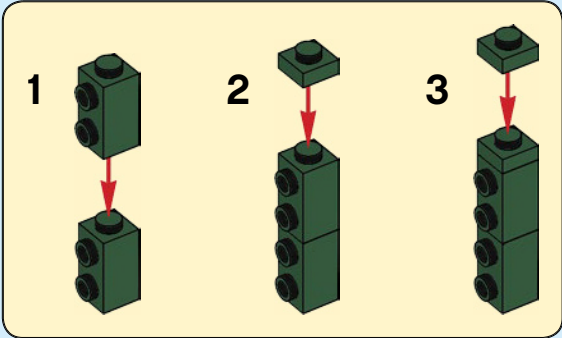

# 115

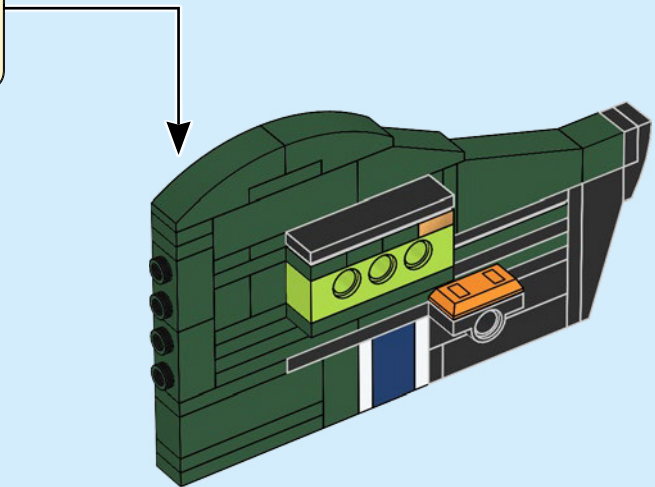
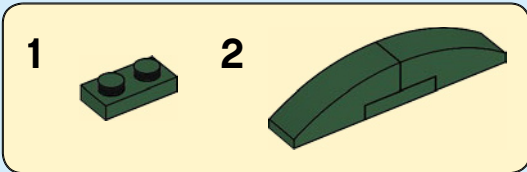

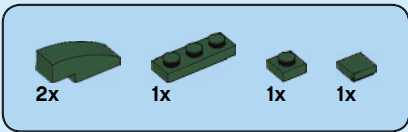

# 116

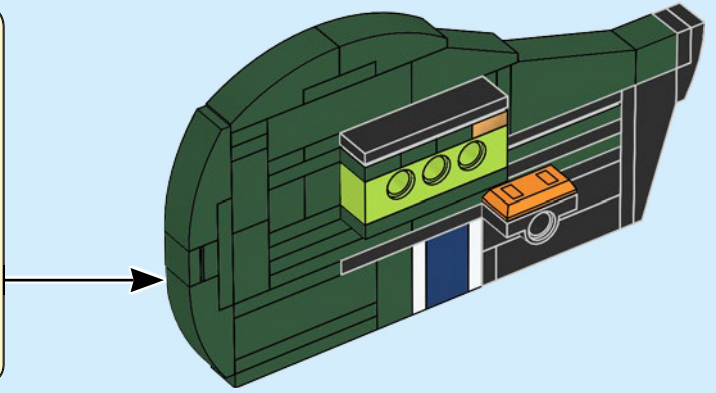
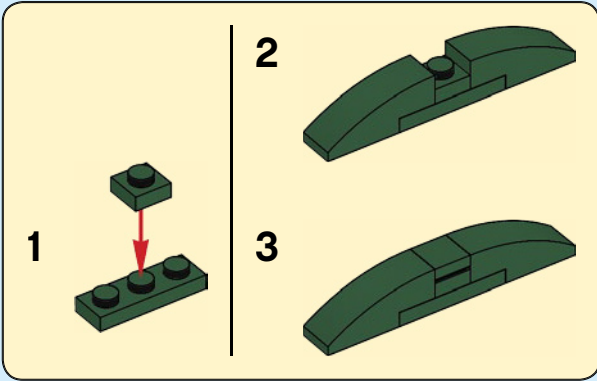

# 117

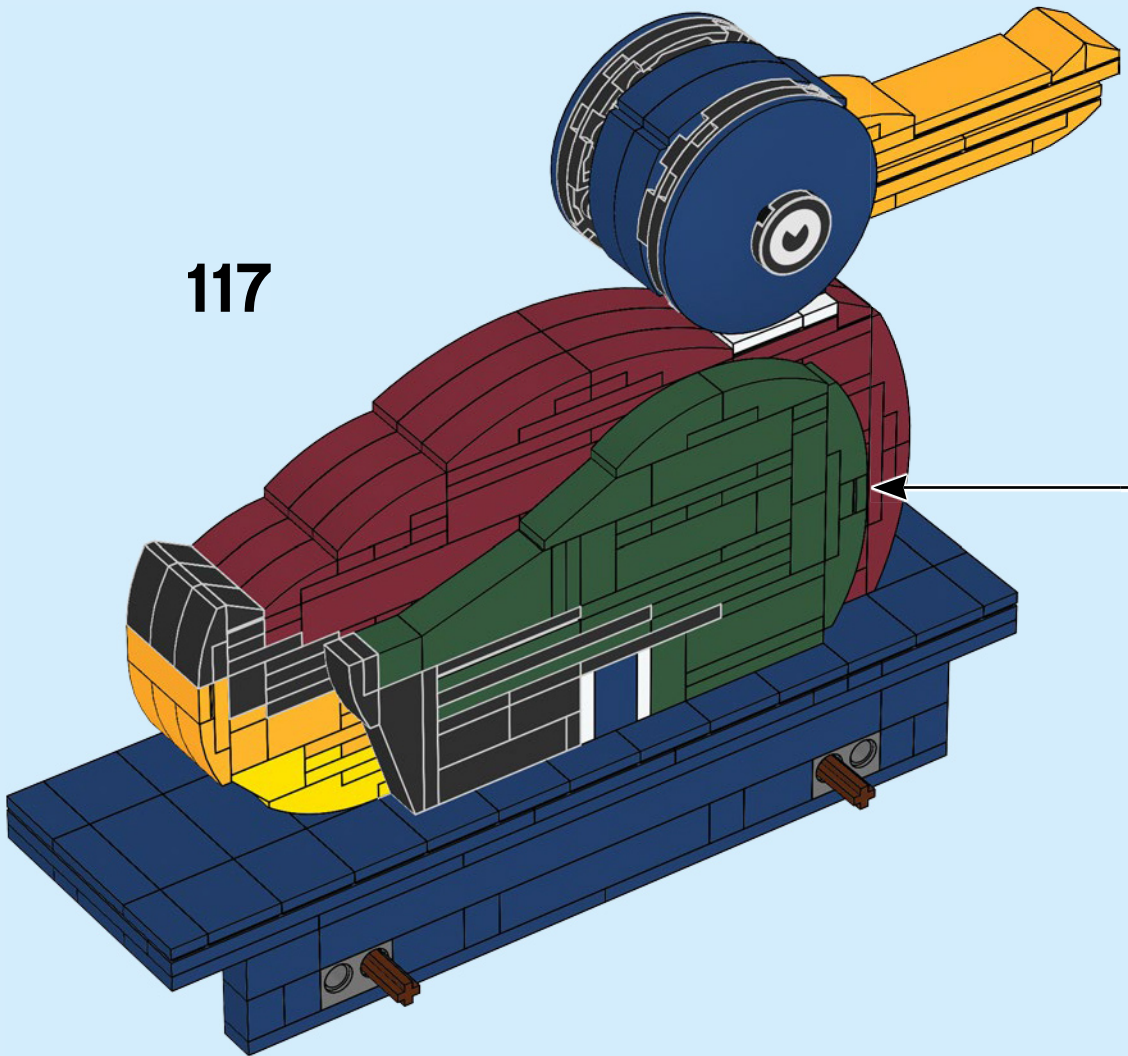



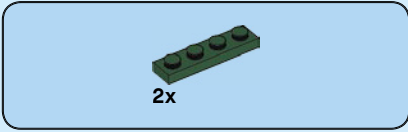
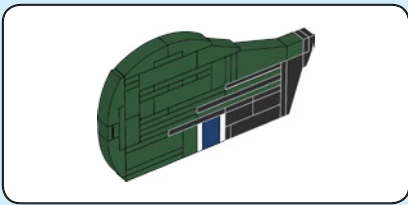

118

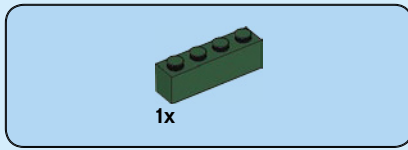
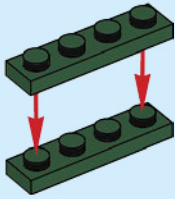

119

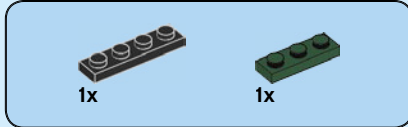
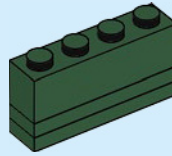

120

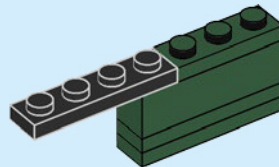

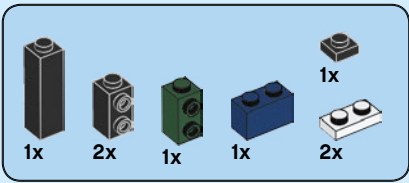

# 121

1

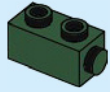

2



3

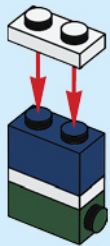

4

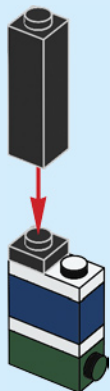

5

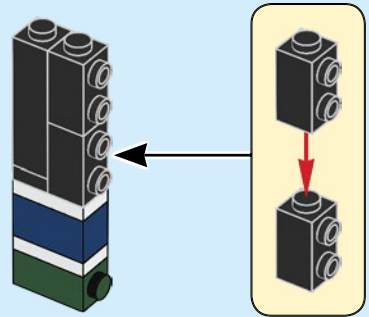

6

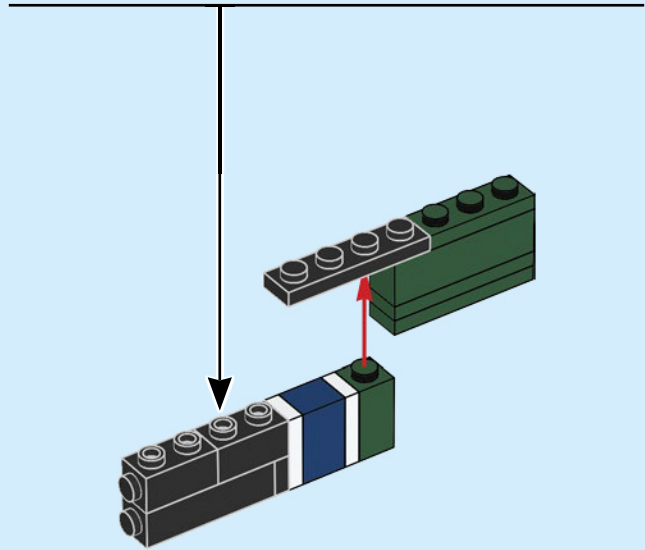
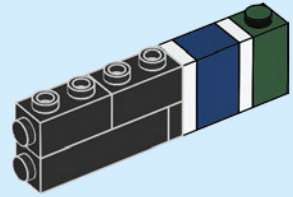
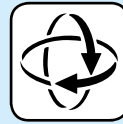

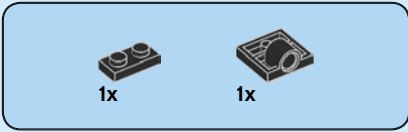

122

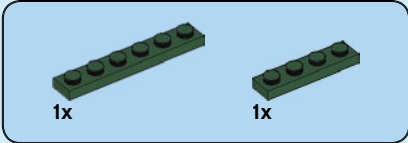
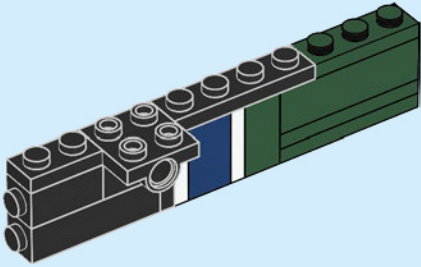

123

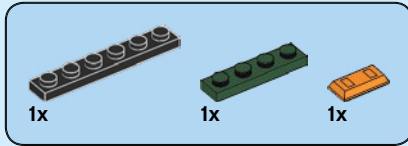
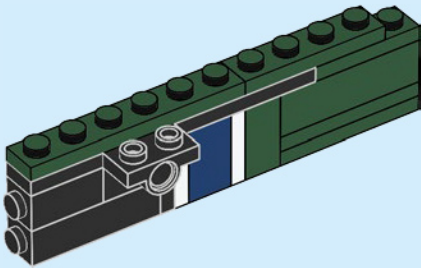

124

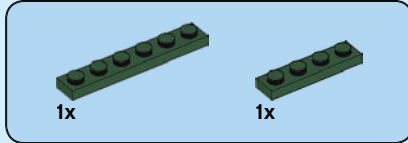
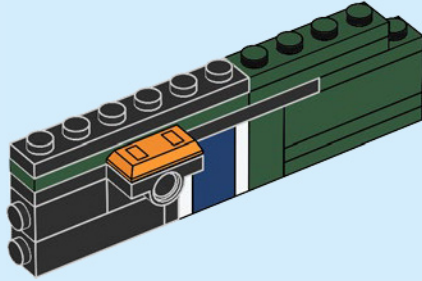

125

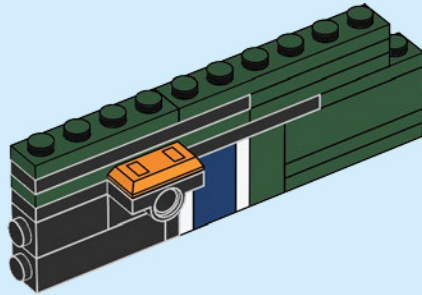

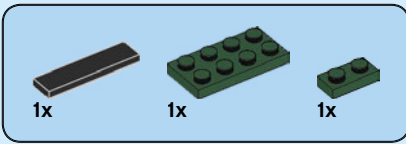

126

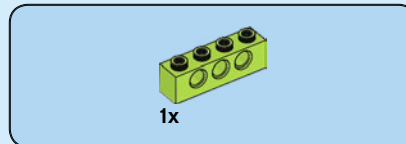
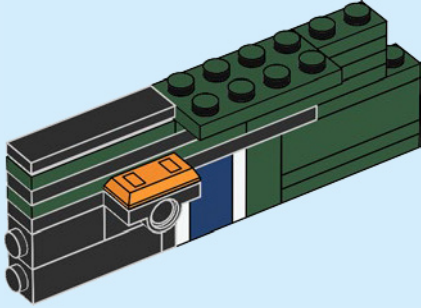

128

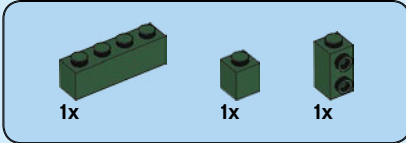
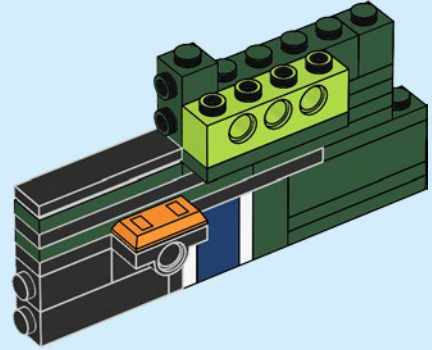

127

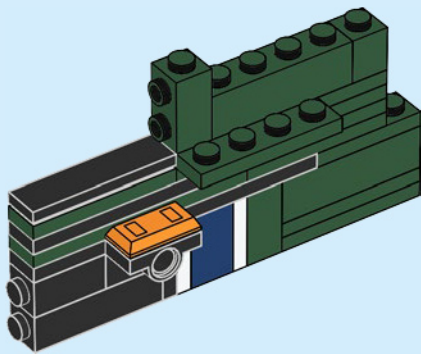

129

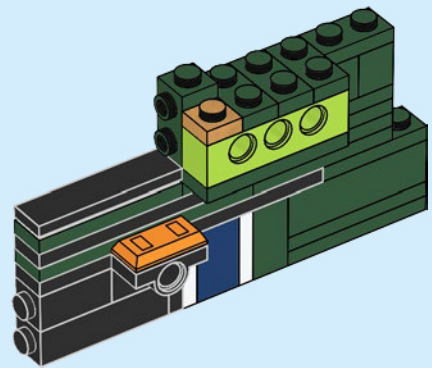

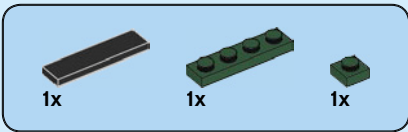

130

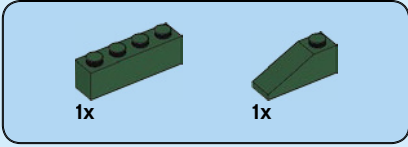
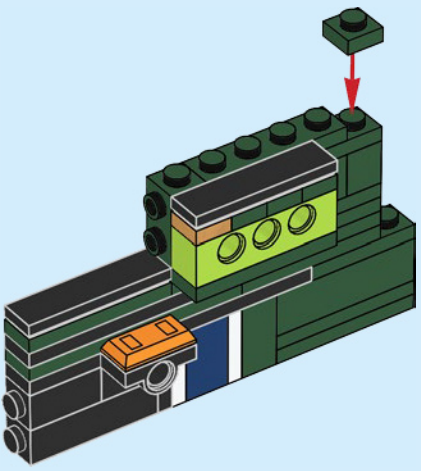

131

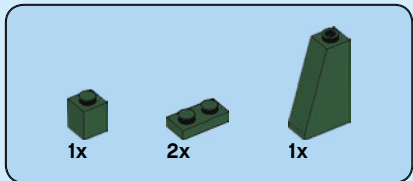
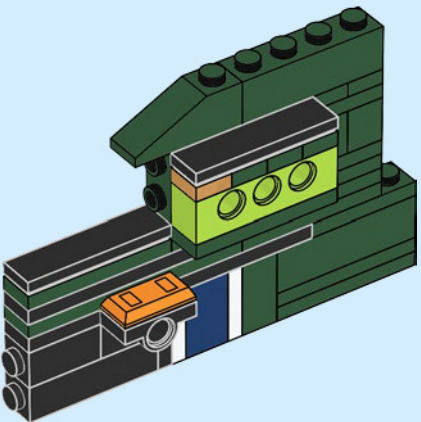

132

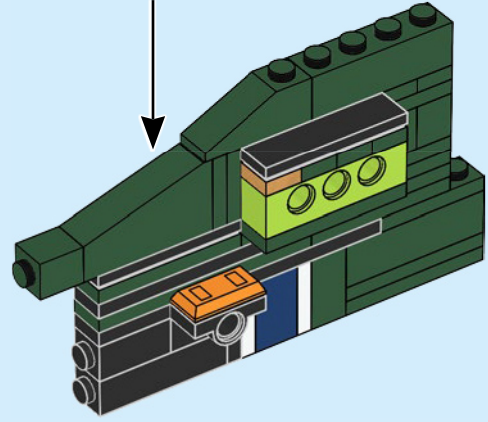
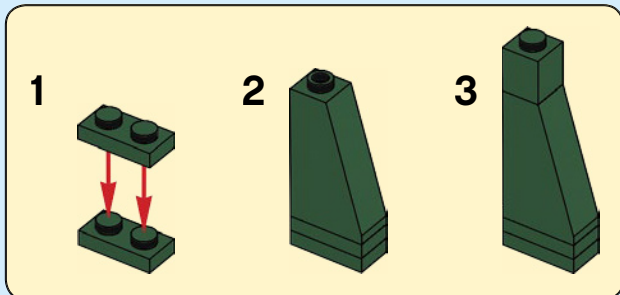



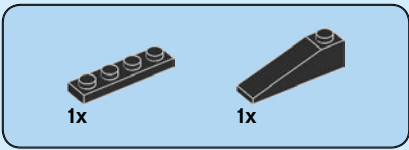

# 133

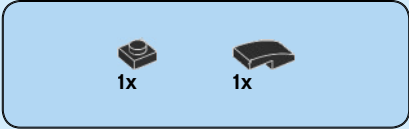
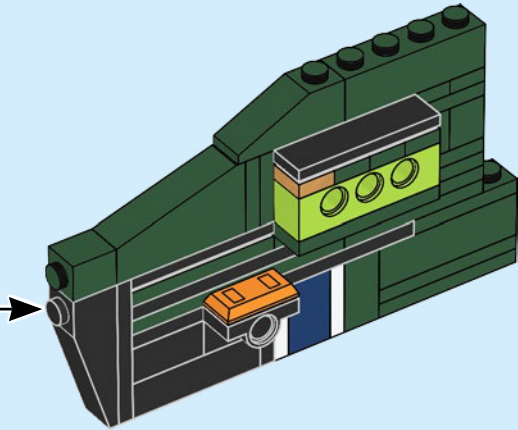
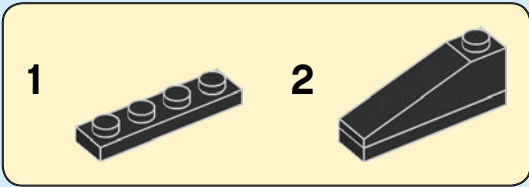

# 134

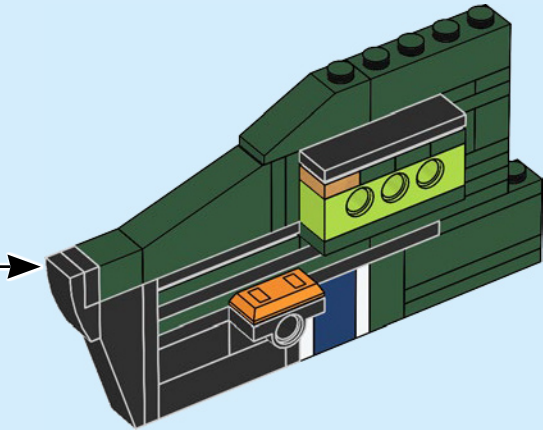
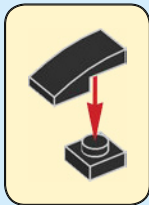

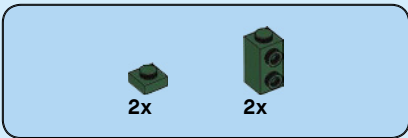

# 135

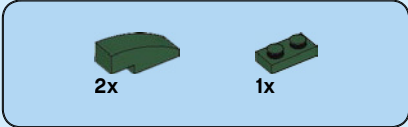
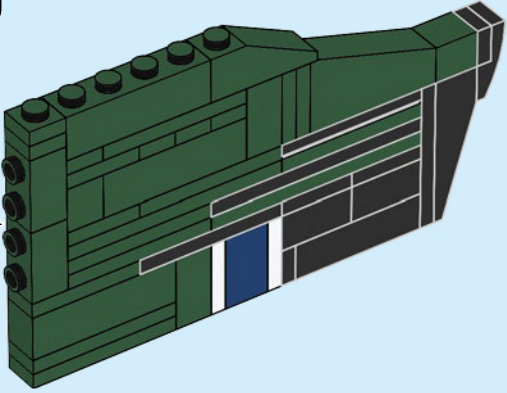
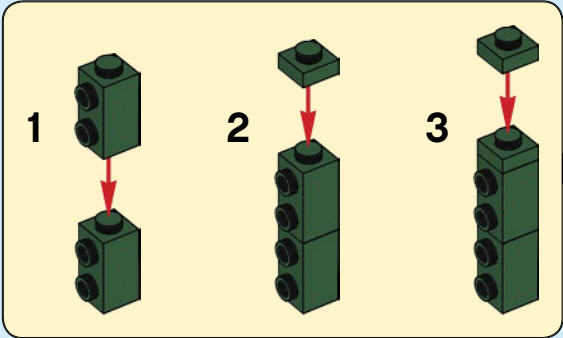

# 136

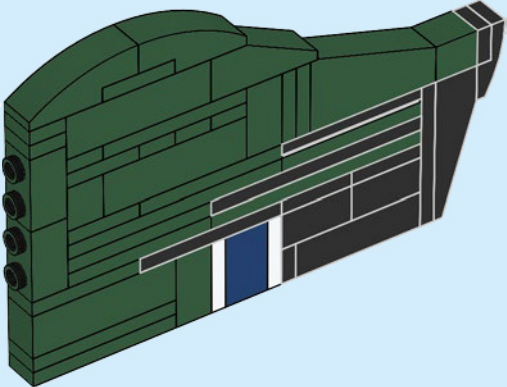
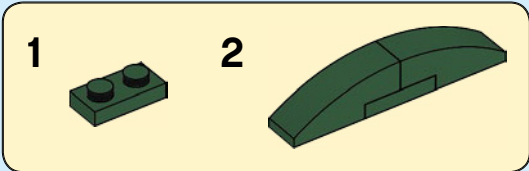

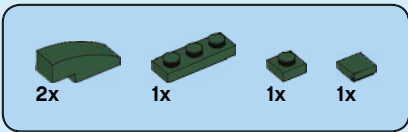

# 137

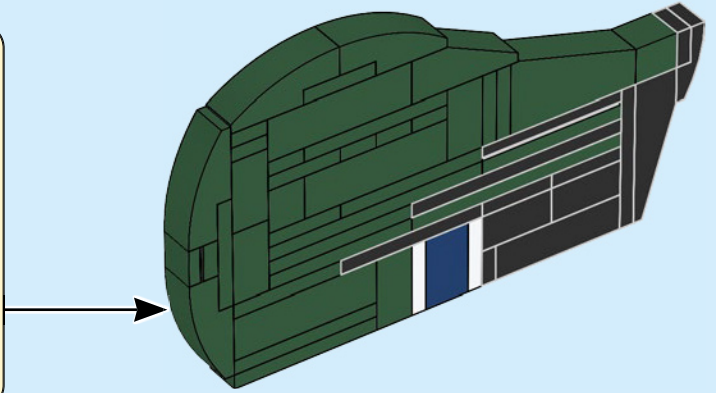
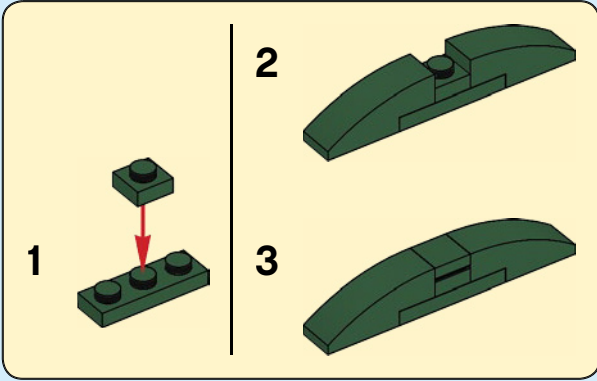

# 138

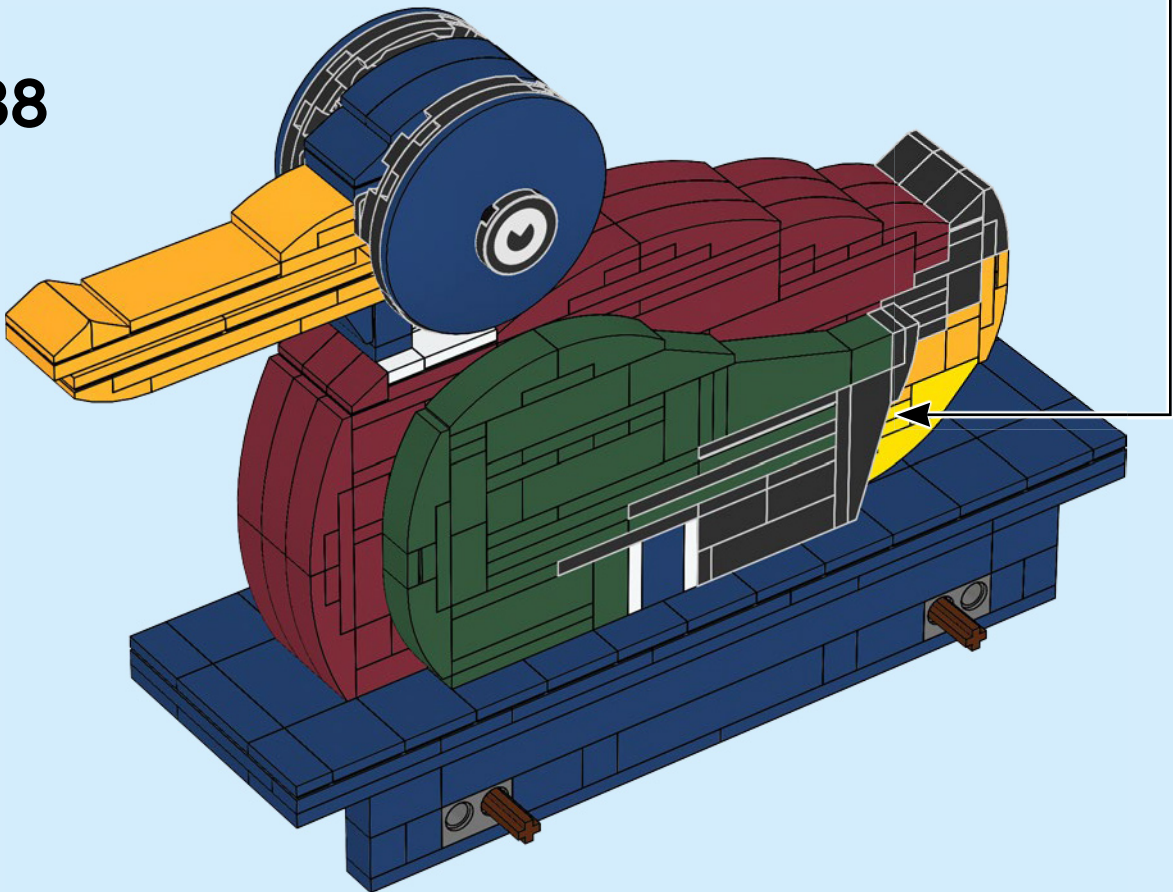

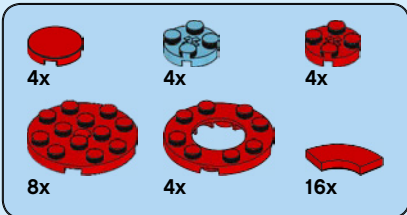
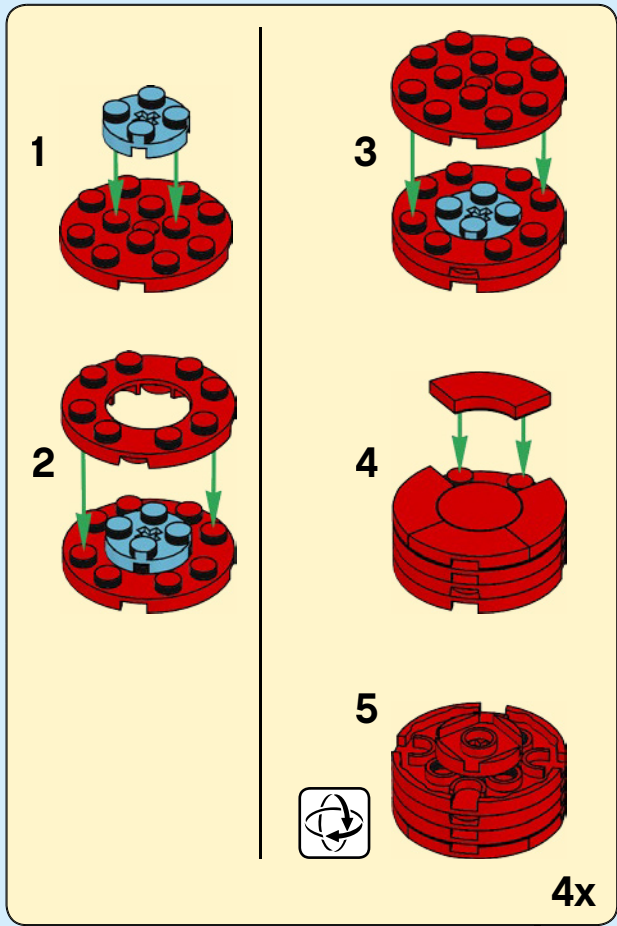
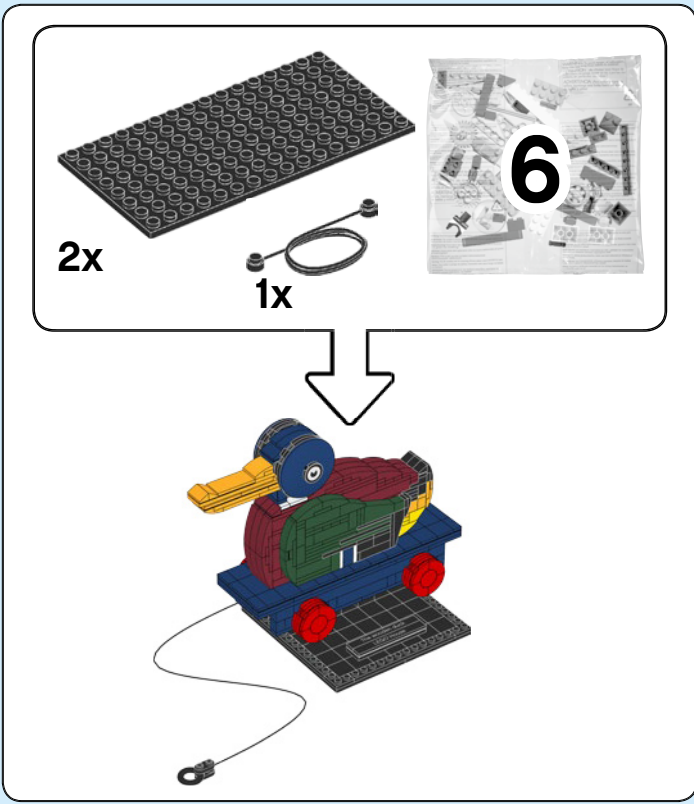

139

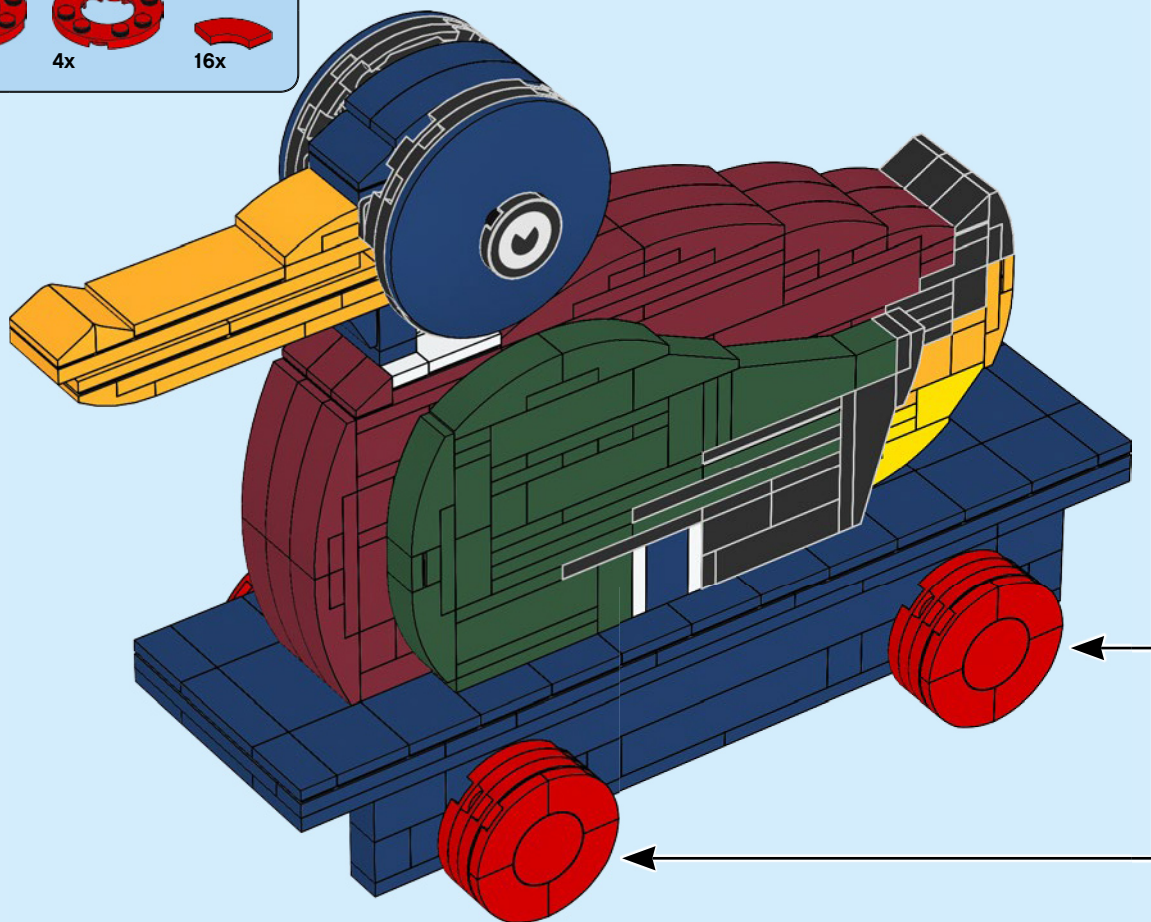



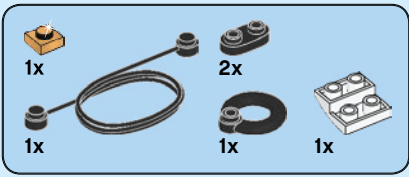

# 140

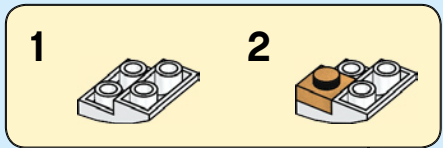
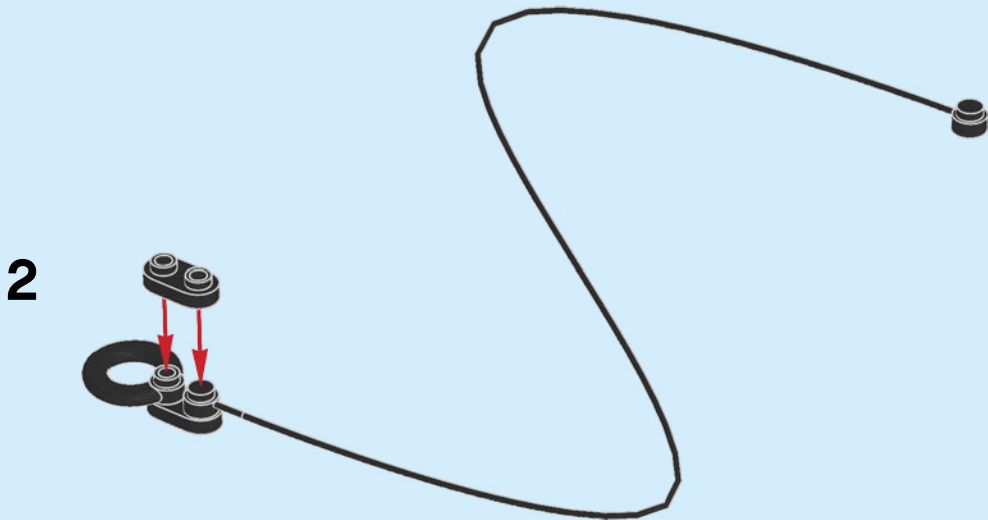
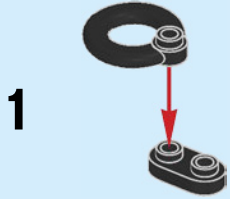

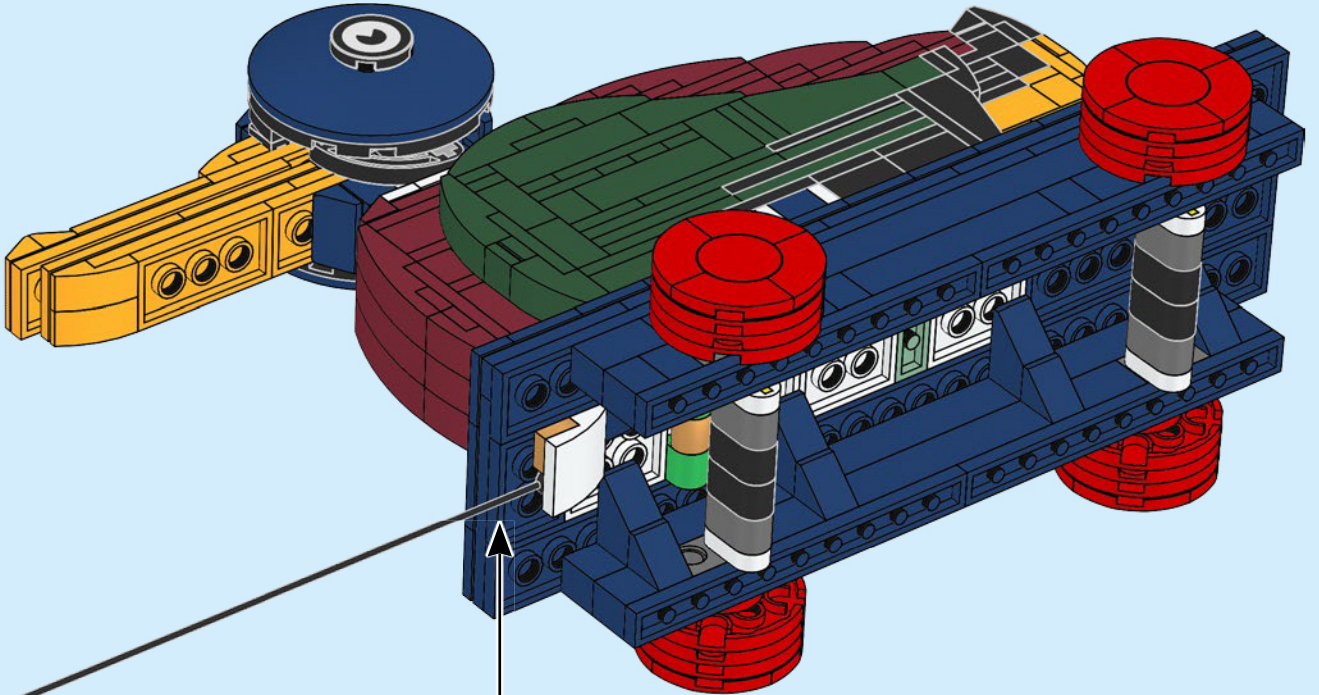

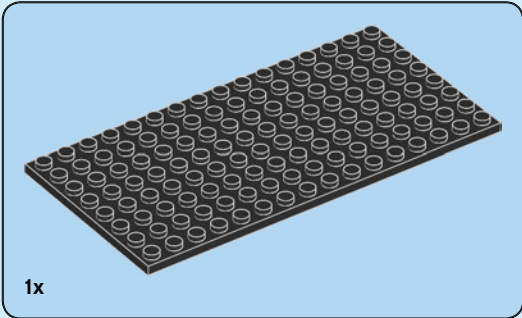
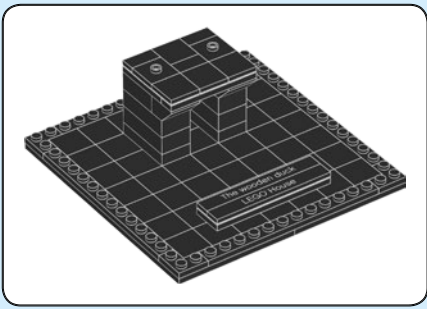

1x

141

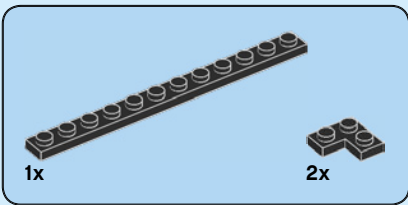
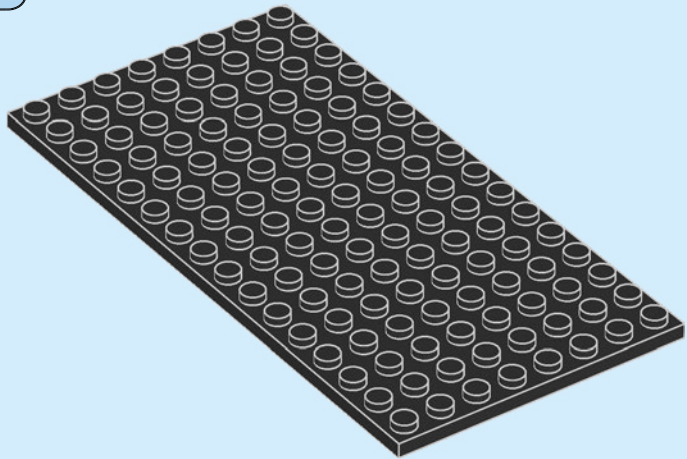

1x

2x

142

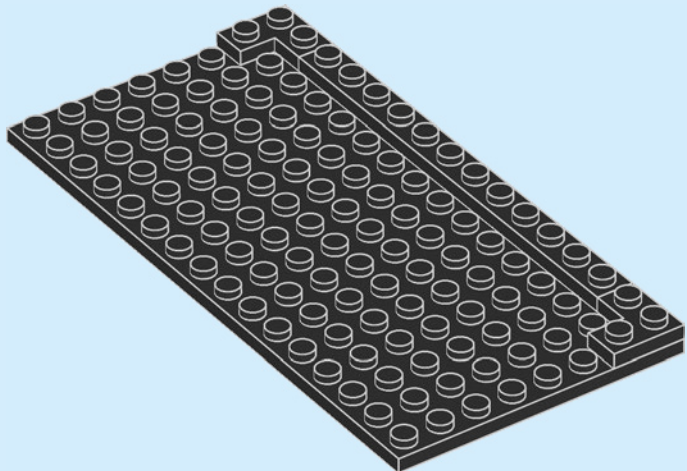



14x

# 143

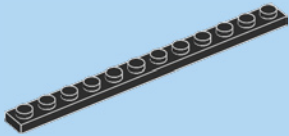
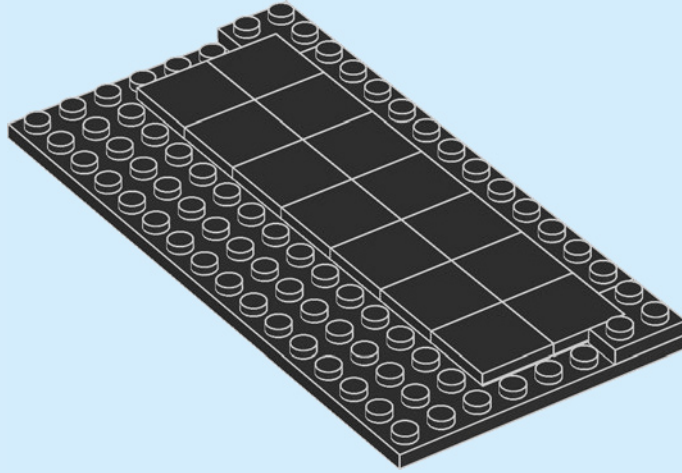

2x

# 144

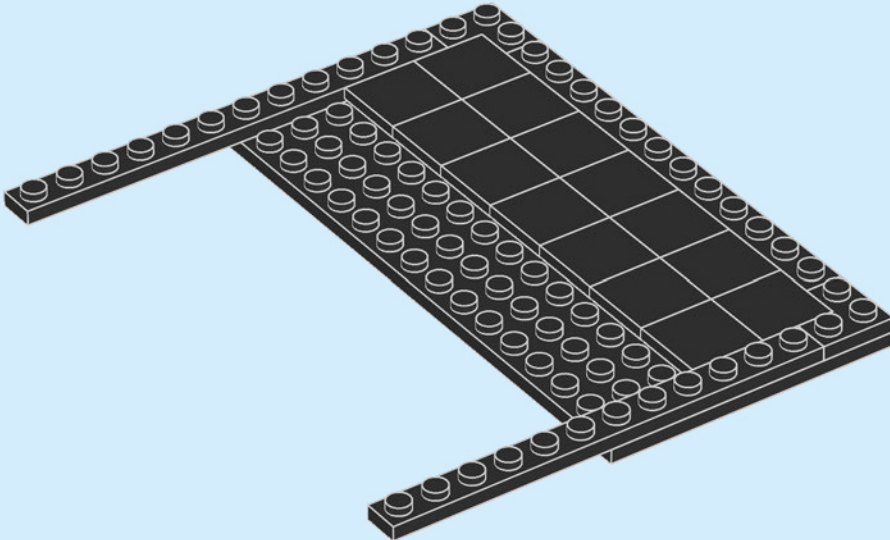

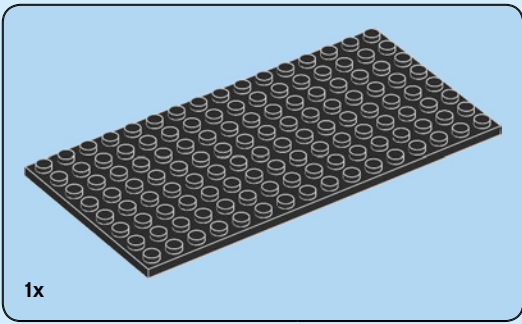

145

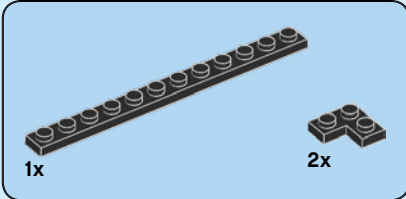
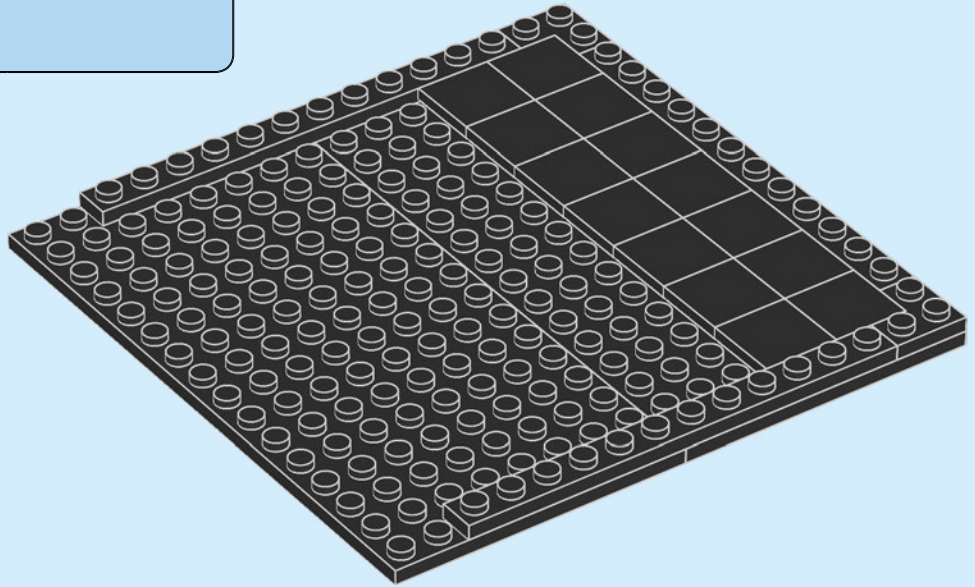

146

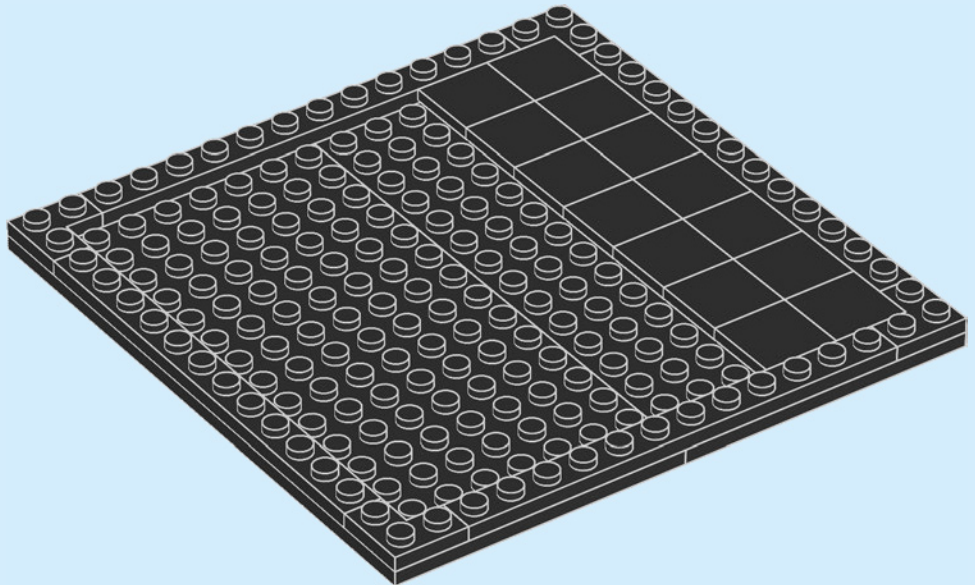





14x

147

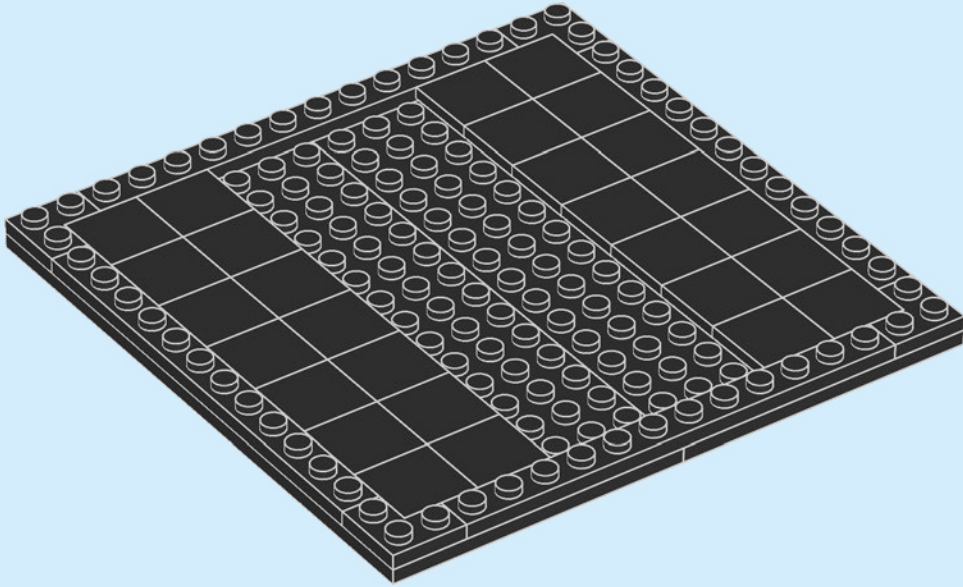

11x

148

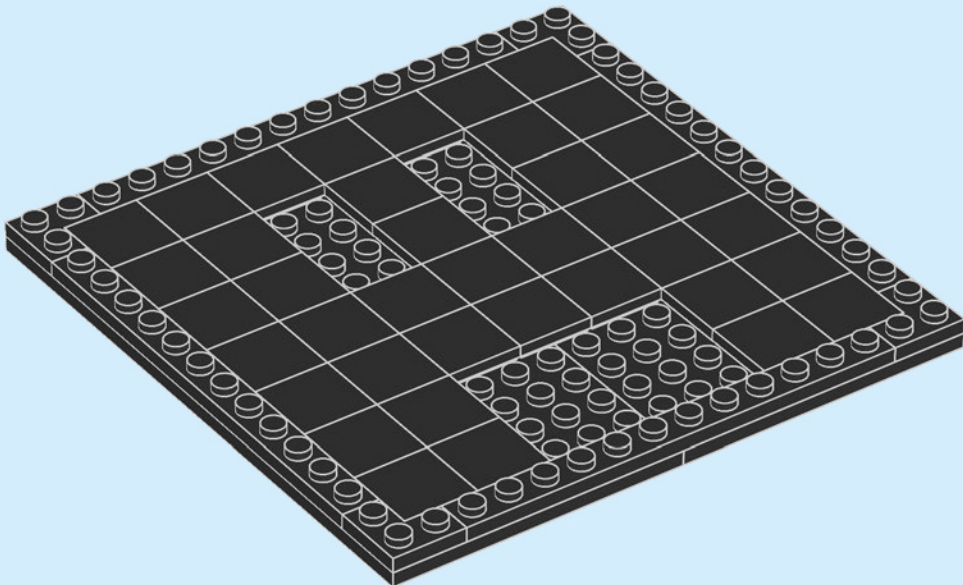

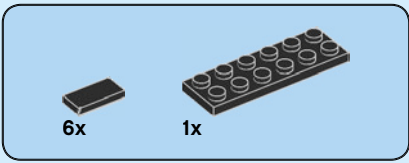

149

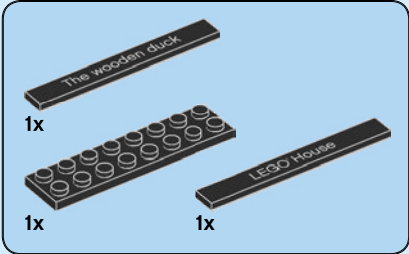
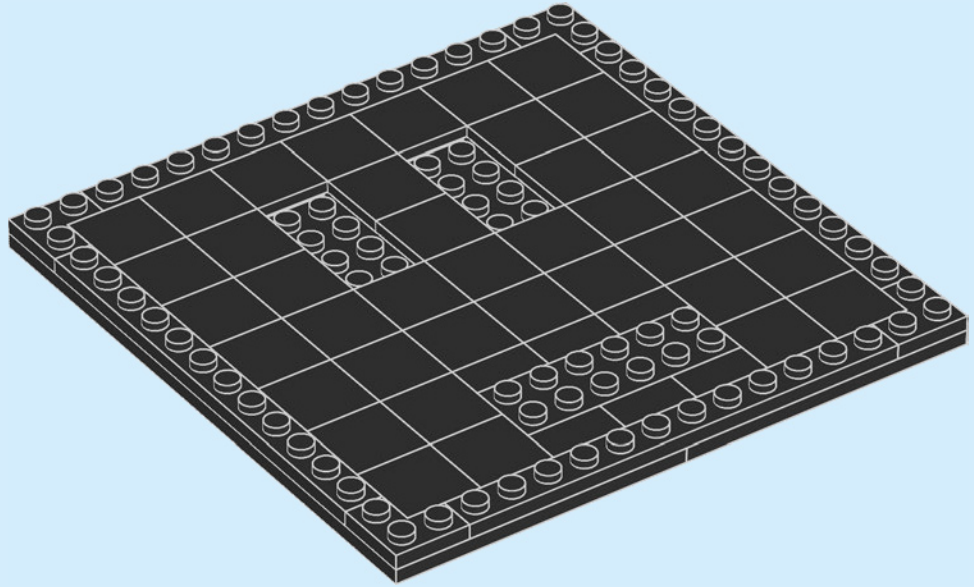

150

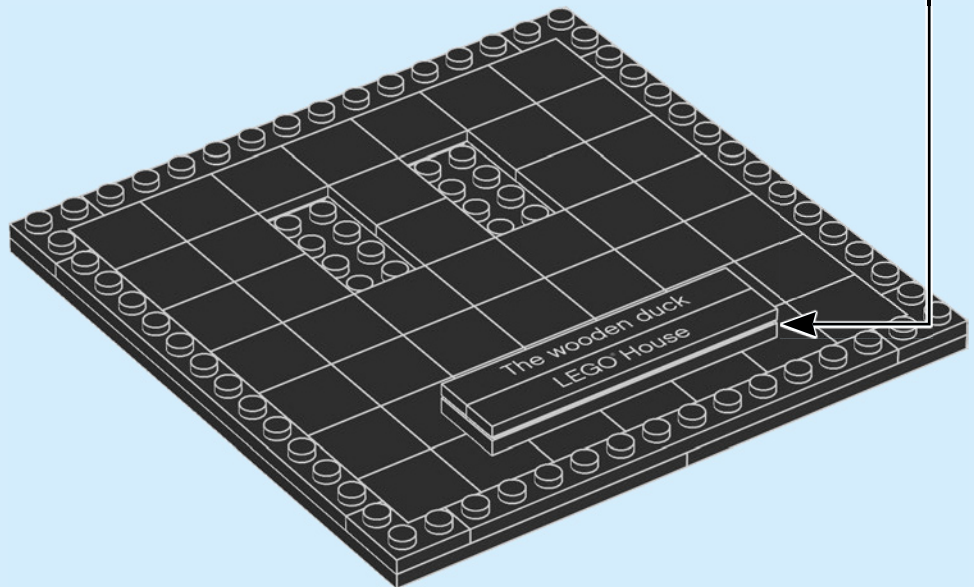
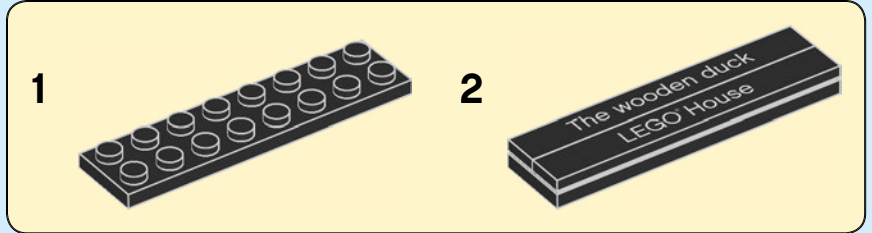

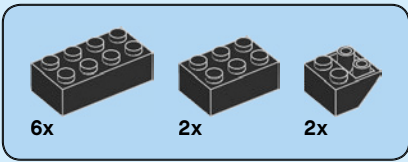

# 151

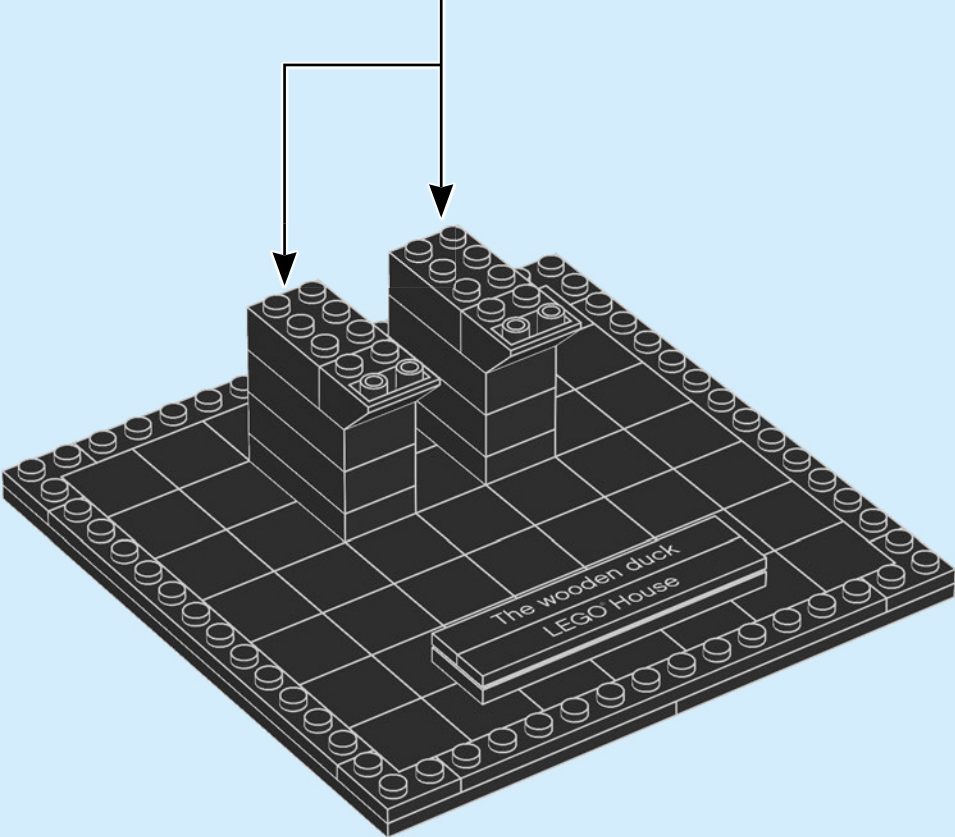
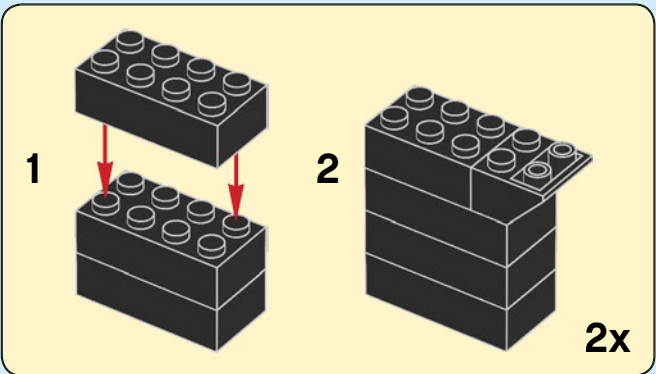

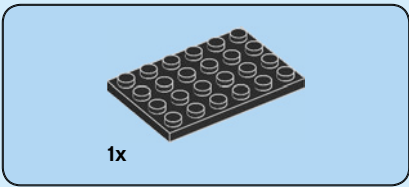

152

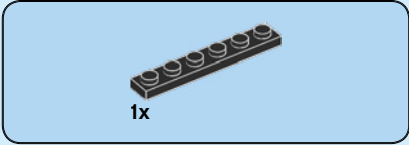
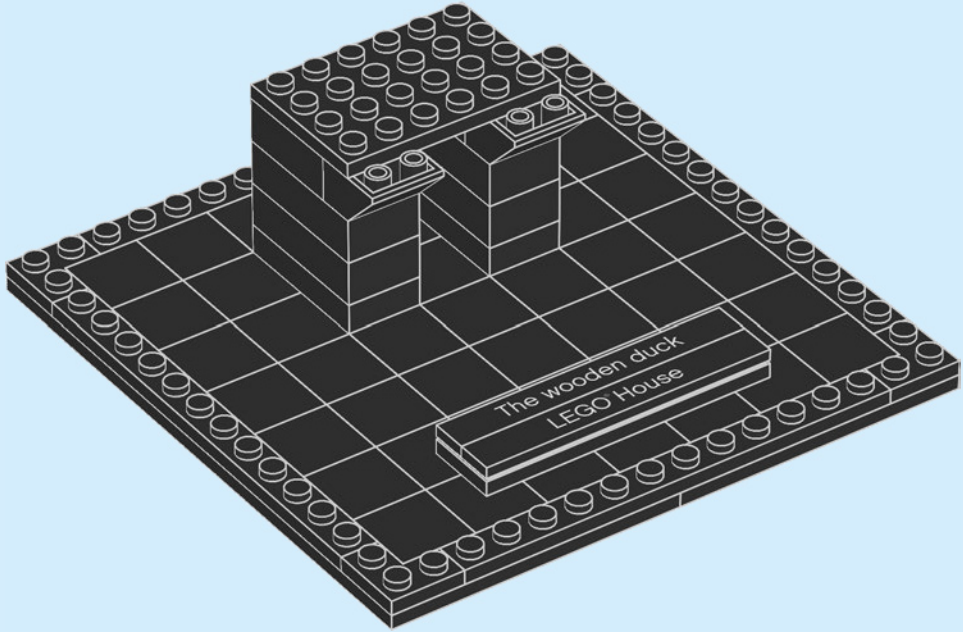

153

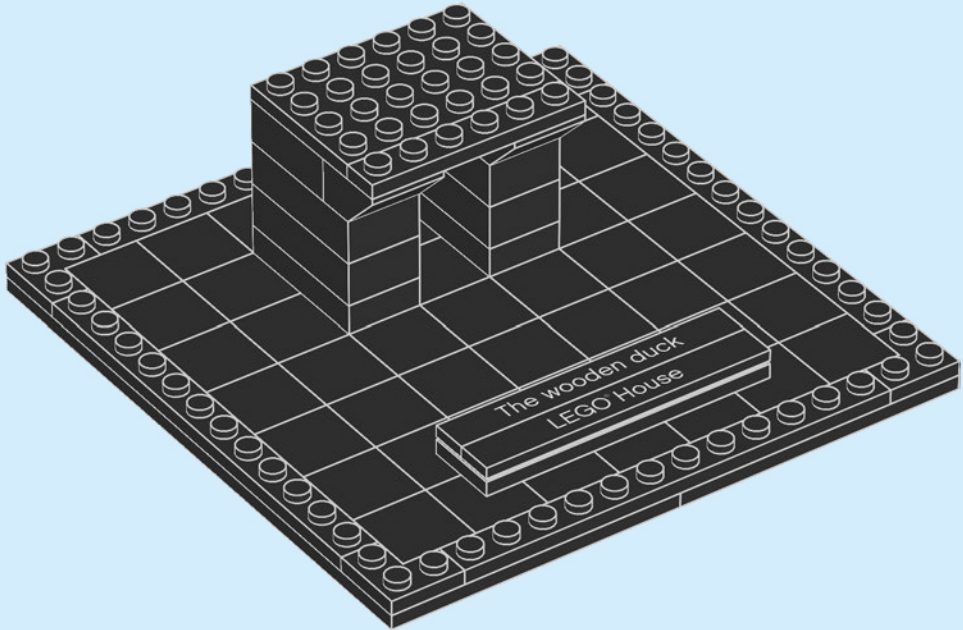



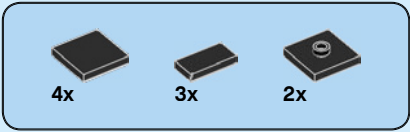

# 154

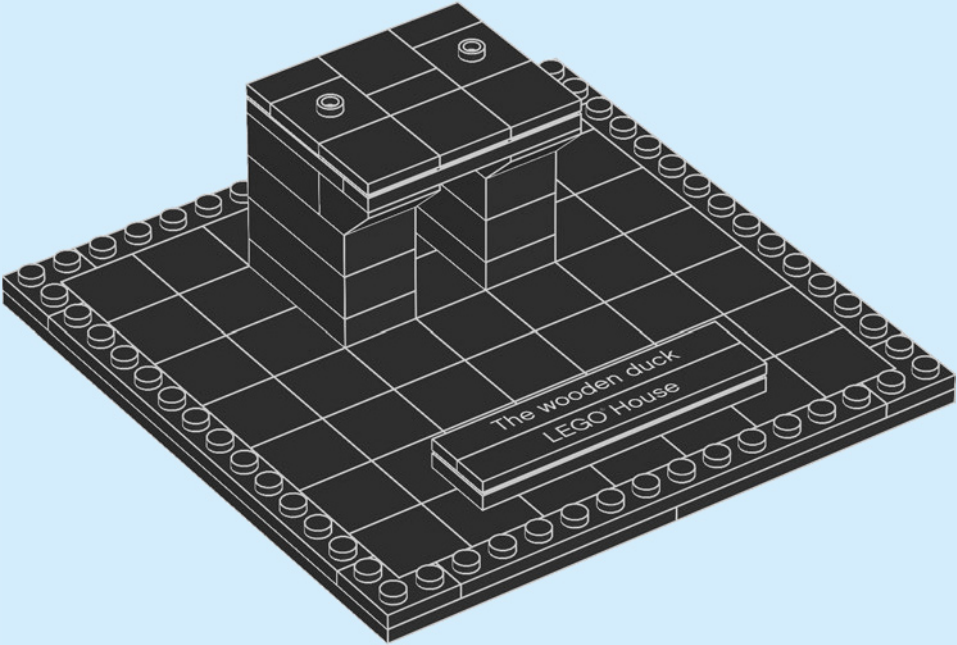



155

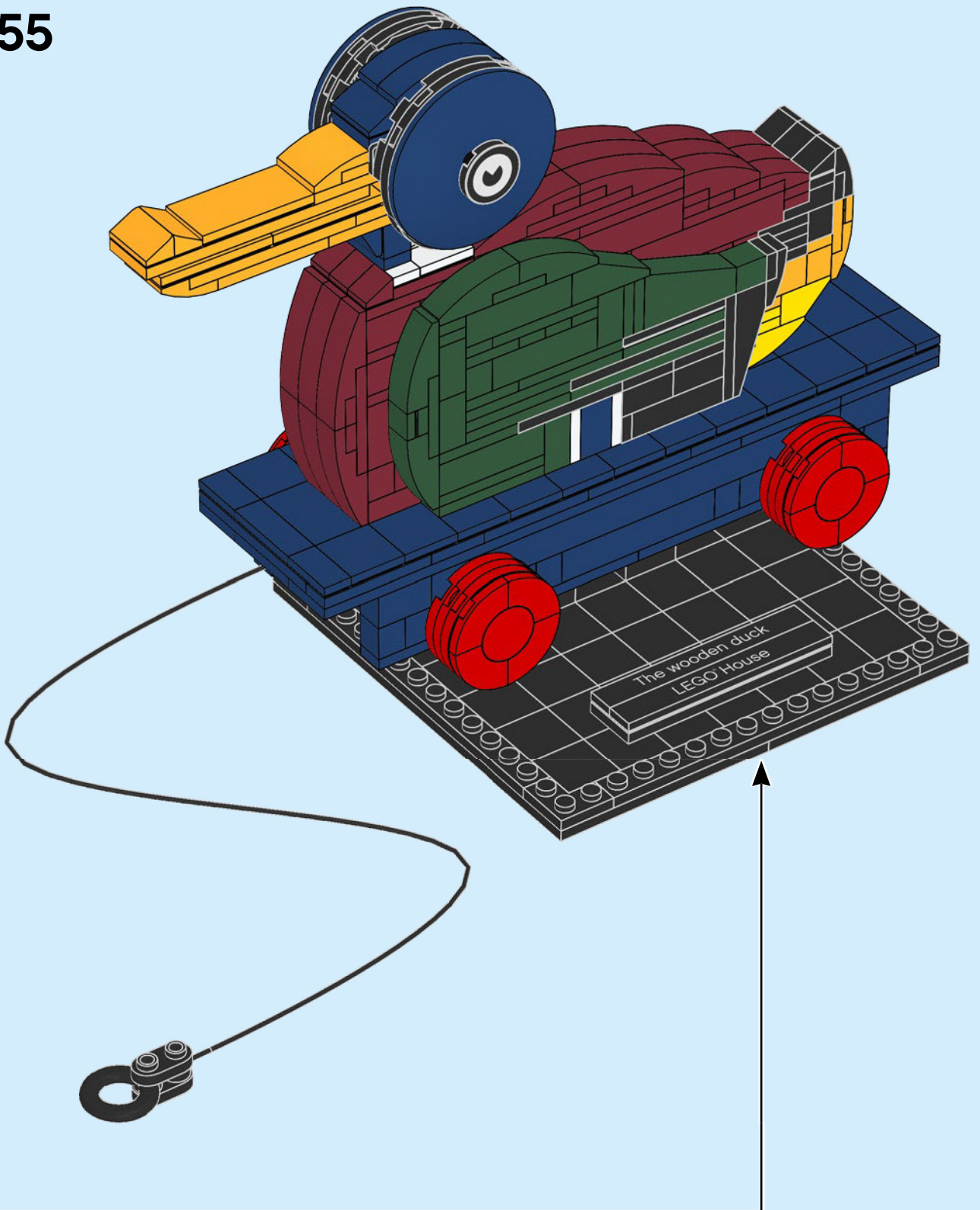

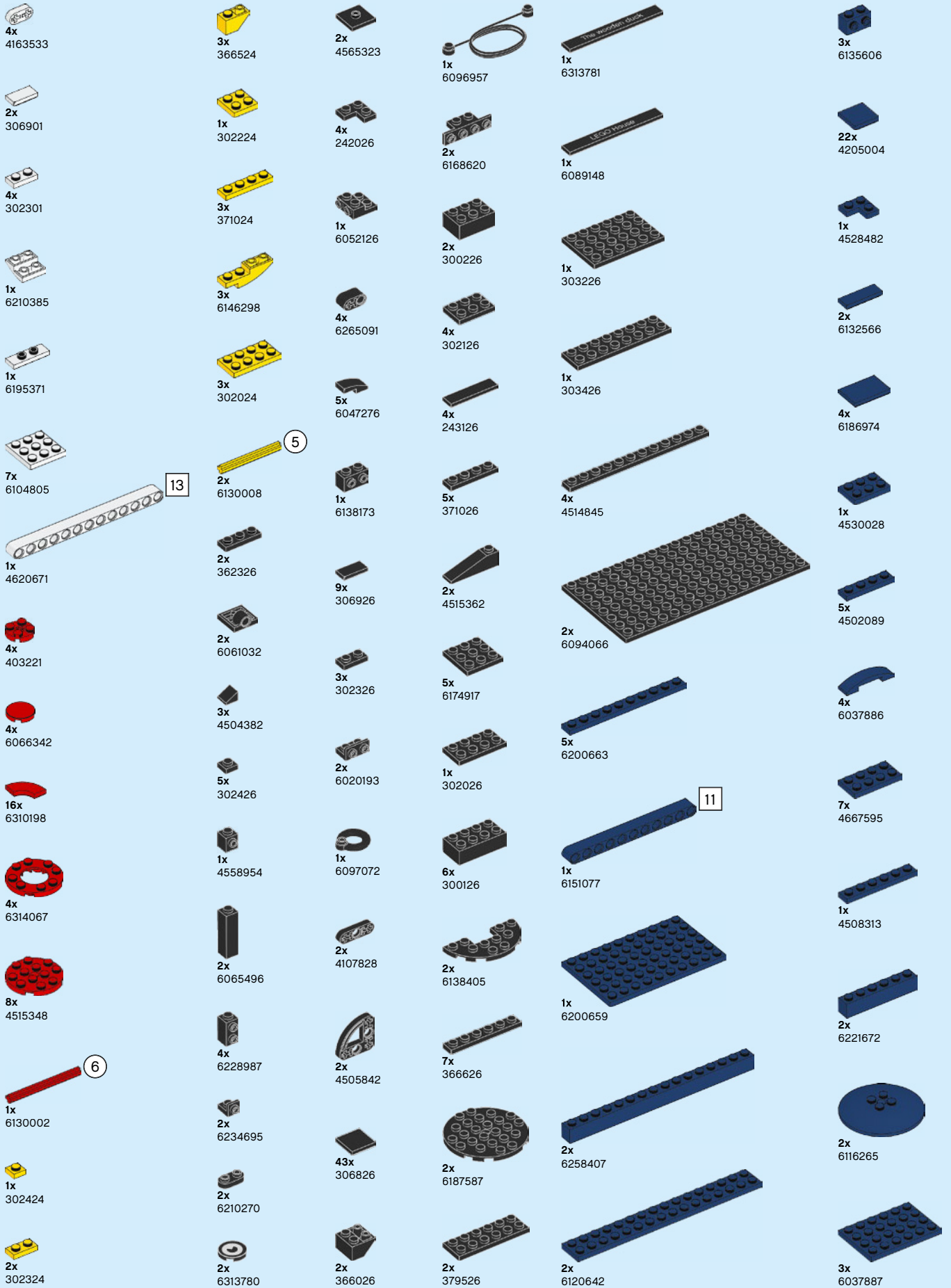

4x  
4255413

8x  
4267850

7x  
4541379

2x  
6310196

4x  
4173805

2x  
6275844

2x  
6216905

2x  
6168573

15x  
4539076

2x  
6145215

2x  
6149656

3x  
4211815

10x  
4249891

6x  
4245571

3x  
4541546

1x  
6099730

2x  
4153826

4x  
6265093

3x  
4528981

12x  
6020923

12x  
6042953

4x  
6034175

1x  
4173332

4x  
4210762

16x  
6097498

2x  
4586057

2x  
6052777

2x  
6099725

1x  
6258094

1x  
6102999

4x  
4528488

4x  
4245566

5x  
4539061

1x  
6061688

2x  
6271826

4x  
6296492

3x  
6037890

5x  
6069257

3x  
4539071

4x  
6073042

3x  
6132373

1x  
6256803

3x  
6000881

2x  
6192923

4x  
4541528

7x  
6097503

1x  
6132375

4x  
6069887

8x  
6055169

3x  
4531415

3x  
4541507

3x  
4621543

8x  
6299413

4x  
6109752

2x  
6055171

3x  
4541376

1x  
6152321

2x  
6097511

2x  
6007973

4x  
6070757

4x  
4521915

6x  
6212007

2x  
6037995

1x  
6097509

2x  
6138624

3x  
6022032

8x  
6252591

3x  
6173168

2x  
6024286

1x  
6133817

2x  
6227921

2x  
6227921

16x  
6013102

3x  
6212084

2x  
6024286

4x  
6135494

2x  
6055224

3x  
4539097

2x  
6028736

4x  
6013975

4x  
4539102

3x  
6099728

Customer Service  
Kundenservice  
Service Consommateurs  
Servicio Al Consumidor

LEGO.com/service or dial



: 00800 5346 5555

: 1-800-422-5346

3

3



LEGO and the LEGO logo are trademarks of the LEGO Group.  
©2020 The LEGO Group. 6324978

